

MELSOFT

# User Web Page Design Tool Operating Manual

---

-SW1DNN-WSVDT-MD

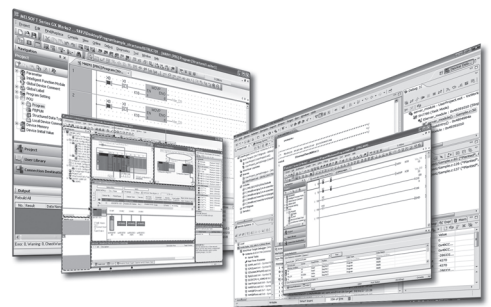



# SAFETY PRECAUTIONS

---

(Read this section before using this product.)

When using this product, make sure that this manual and other related manuals introduced in this manual are read carefully, and be reminded to treat this product correctly while paying due attention to safety.

Precautions shown in this manual describe only those about this product. For safety precautions as a PLC system, refer to the user's manual of a module used.

In this manual, safety precautions are ranked and classified into "⚠️ WARNING" and "⚠️ CAUTION".

---

## **WARNING**

Indicates that incorrect handling may cause hazardous conditions, resulting in death or severe injury.

---

## **CAUTION**

Indicates that incorrect handling may cause hazardous conditions, resulting in minor or moderate injury or property damage.

---

For your information, even if a precaution is classified into the category "⚠️ CAUTION" and described, it may lead to a significant consequence, depending on its situation.

Precautions classified into both categories describe what are important, and therefore make sure to observe them.

Keep this manual in a safe place so that it can be read whenever necessary, and make sure that it will be delivered to its end users.

## [DESIGN PRECAUTIONS]

---

### **WARNING**

- If a communication cable is disconnected, the network may be unstable, resulting in a communication failure of multiple stations. Construct an interlock circuit in the program so that the system always operates on the safe side even if communications fail. Incorrect output or malfunction may result in an accident.
- 

## [SECURITY PRECAUTIONS]

---

### **WARNING**

- To maintain the security (confidentiality, integrity, and availability) of the programmable controller and the system against unauthorized access, denial-of-service (DoS) attacks, computer viruses, and other cyberattacks from unreliable networks and devices via network, take appropriate measures such as firewalls, virtual private networks (VPNs), and antivirus solutions.
- 

## [STARTUP AND MAINTENANCE PRECAUTIONS]

---

### **CAUTION**

- Especially, when a remote programmable controller is controlled by an external device, immediate action cannot be taken if a problem occurs in the programmable controller due to a communication failure. To prevent this, configure an interlock circuit in the program, and determine corrective actions to be taken between the external device and CPU module in case of a communication failure.
-

# CONDITIONS OF USE FOR THE PRODUCT

---

- (1) MELSEC programmable controller ("the PRODUCT") shall be used in conditions;
- i) where any problem, fault or failure occurring in the PRODUCT, if any, shall not lead to any major or serious accident; and
  - ii) where the backup and fail-safe function are systematically or automatically provided outside of the PRODUCT for the case of any problem, fault or failure occurring in the PRODUCT.
- (2) The PRODUCT has been designed and manufactured for the purpose of being used in general industries. MITSUBISHI ELECTRIC SHALL HAVE NO RESPONSIBILITY OR LIABILITY (INCLUDING, BUT NOT LIMITED TO ANY AND ALL RESPONSIBILITY OR LIABILITY BASED ON CONTRACT, WARRANTY, TORT, PRODUCT LIABILITY) FOR ANY INJURY OR DEATH TO PERSONS OR LOSS OR DAMAGE TO PROPERTY CAUSED BY the PRODUCT THAT ARE OPERATED OR USED IN APPLICATION NOT INTENDED OR EXCLUDED BY INSTRUCTIONS, PRECAUTIONS, OR WARNING CONTAINED IN MITSUBISHI ELECTRIC USER'S, INSTRUCTION AND/OR SAFETY MANUALS, TECHNICAL BULLETINS AND GUIDELINES FOR the PRODUCT.
- ("Prohibited Application")
- Prohibited Applications include, but not limited to, the use of the PRODUCT in;
- Nuclear Power Plants and any other power plants operated by Power companies, and/or any other cases in which the public could be affected if any problem or fault occurs in the PRODUCT.
  - Railway companies or Public service purposes, and/or any other cases in which establishment of a special quality assurance system is required by the Purchaser or End User.
  - Aircraft or Aerospace, Medical applications, Train equipment, transport equipment such as Elevator and Escalator, Incineration and Fuel devices, Vehicles, Manned transportation, Equipment for Recreation and Amusement, and Safety devices, handling of Nuclear or Hazardous Materials or Chemicals, Mining and Drilling, and/or other applications where there is a significant risk of injury to the public or property.
- Notwithstanding the above restrictions, Mitsubishi Electric may in its sole discretion, authorize use of the PRODUCT in one or more of the Prohibited Applications, provided that the usage of the PRODUCT is limited only for the specific applications agreed to by Mitsubishi Electric and provided further that no special quality assurance or fail-safe, redundant or other safety features which exceed the general specifications of the PRODUCTS are required. For details, please contact the Mitsubishi Electric representative in your region.
- (3) Mitsubishi Electric shall have no responsibility or liability for any problems involving programmable controller trouble and system trouble caused by DoS attacks, unauthorized access, computer viruses, and other cyberattacks.

## INTRODUCTION

---

Thank you for purchasing Mitsubishi Electric Corporation's PLC.

This manual is to help users understand the User Web Page Design Tool.

Before using this product, read this manual carefully to fully understand the User Web Page Design Tool's functions/ capabilities, and make sure that this product is used correctly.

Be reminded that this manual will surely be delivered to this product's end users.

# CONTENTS

SAFETY PRECAUTIONS .....	1
CONDITIONS OF USE FOR THE PRODUCT .....	2
INTRODUCTION .....	2
RELEVANT MANUALS .....	4
TERMS .....	4
<b>CHAPTER 1 BEFORE USING THIS PRODUCT</b> .....	<b>5</b>
1.1 Features .....	5
1.2 Operating Environment .....	5
1.3 Software License .....	7
<b>CHAPTER 2 USER INTERFACE</b> .....	<b>22</b>
2.1 Screen Structure .....	22
2.2 Shortcut .....	22
2.3 Menu Bar .....	23
2.4 Tool Buttons .....	29
2.5 Component Window .....	30
PLC components .....	30
Generic components .....	38
Common items .....	42
2.6 Design Window .....	45
2.7 Property Window .....	46
Component properties .....	46
Page properties .....	46
Common items .....	47
<b>CHAPTER 3 TUTORIAL</b> .....	<b>48</b>
3.1 Before Tutorial .....	48
3.2 Practical Examples .....	50
Creating a user Web page .....	50
Access to user Web page .....	57
<b>CHAPTER 4 NOTES</b> .....	<b>58</b>
<b>APPENDIX</b> .....	<b>60</b>
Appendix 1 Project Management .....	60
<b>INDEX</b> .....	<b>63</b>
REVISIONS .....	65
TRADEMARKS .....	66

# RELEVANT MANUALS

Manual name <manual number>	Description
MELSEC iQ-R/MELSEC iQ-F Web Server Function Guide Book <SH-081982ENG>	This describes the specifications of the Web server's functions, procedures before its operations, and its troubleshooting.
MELSEC iQ-R Ethernet User's Manual (Application) <SH-081257ENG>	This describes Ethernet functions, parameter settings, programming, troubleshooting, I/O signals, and buffer memory. For the Web server functions, this describes the details of JavaScript components which can be used in a user Web page.
MELSEC iQ-F FX5 User's Manual (Communication) <SH-082625ENG>	This describes contents about built-in Ethernet port communication's functions. For the Web server functions, this describes the details of JavaScript components which can be used in a user Web page.
User Web Page Design Tool Operating Manual <SH-082315ENG> (this manual)	This describes the user Web page tool's functions and how to use it.

## TERMS

Unless otherwise stated expressly, the following terms shall be used in this manual for an explanation.

Terms	Description
Device	This is a device which a CPU module has in it (such as X, Y, M, D, etc.)
FX5CPU	This is a generic name for MELSEC iQ-F series CPU modules.
GX Works3	This is a generic name for products whose product model name is SWnDND-GXW3. ("n" denotes their version.)
RCPU	This is a generic name for MELSEC iQ-R series CPU modules.

# 1 BEFORE USING THIS PRODUCT

This User Web Page Design Tool is a tool to help its users create user Web pages using Web server functions.



To use all the functions described in this manual, install the latest version of User Web Page Design Tool.

## 1.1 Features

This section describes features of this tool.

### Easy operations enabling users to create user Web pages

Its screen operations allocate PLC and generic components and configure property settings, and thereby HTML files for user Web pages can be created, which will operate on a CPU module's Web server functions.

Components prepared beforehand are selected and their property settings are configured, and therefore its users can create HTML files without knowing HTML tags and Cascading Style Sheets (CSS).

### HTML files transferable to a CPU module

HTML files created by this tool can be transferred to an SD memory card attached to a CPU module through FTP communication.\*1

\*1 When a MELSEC iQ-R series CPU module is used, there are restrictions on the firmware version. (Page 25 Communication)

## 1.2 Operating Environment

This section describes the operating environment of this tool.

Item	Description
Personal computer main part	This must be a personal computer that can run Microsoft® Windows®.
CPU	Intel® Core® i3 2 GHz or better is recommended.
Required memory size	8 GB or more is recommended.
Hard disk free space	400 MB or more
Display resolution	1280 × 1024 pixels or better
OS (English, Japanese, and Chinese (simplified characters) versions)*1	Windows 10 (Home, Pro, Enterprise, and Education)(64 bit)
Supporting CPU modules	■MELSEC iQ-R series*2 • R01CPU and R02CPU: Firmware version "18" or later*3 • CPU modules other than those above: Firmware version "50" or later*4 ■MELSEC iQ-F series • FX5S CPU modules: Firmware version "1.000" or later • FX5UJ CPU modules: Firmware version "1.020" or later • FX5U/FX5UC CPU modules: Firmware version "1.220" or later

\*1 English, Japanese, and Chinese (simplified characters) are supported as the display languages of this tool. (Page 25 Switch Display Language) However, selection button displays, etc. depend on an OS's language, and therefore they may be displayed in one other than those languages above.

\*2 There are some restrictions on the combination of user Web page and CPU module firmware versions. (MELSEC iQ-R/MELSEC iQ-F Web Server Function Guide Book)

\*3 The communication function of this tool is supported by firmware version "30" or later.

\*4 The communication function of this tool is supported by firmware version "63" or later.

The communication function cannot be used in the R00CPU module because an SD memory card is required for the function.

## Client operating environment

Clients whose operability have been confirmed by Mitsubishi Electric Corporation are as shown below. Use a Web browser that supports HTML5, CSS3, and JavaScript.

Terminal	OS	Browser	Browser version	
			MELSEC iQ-R	MELSEC iQ-F
Personal computer	Microsoft® Windows®	Internet Explorer®	11	11
		Microsoft® Edge	85	85
		Google Chrome	85	85
Tablet	Android®	Mobile Google Chrome	81	81
Smartphone	iOS®	Mobile Safari	12	12



# 1.3 Software License

This tool is composed of multiple software components. There are copyrights of our company and third parties to those individual software components. This tool includes the software items shown below.

- Software items to which there exist third-party copyrights and which are distributed as free software. For software items to which Mitsubishi Electric Corporation or third parties have copyrights, their source codes shall not be distributed.

Please refrain from contacting Mitsubishi Electric Corporation about open sources' source codes.

## Software information

This product contains the software items shown below.

OSS (Open Source Software)	Software version	License name
electron	8.2.5	MIT License
electron-splashscreen	1.0.0	MIT License
electron-progressbar	1.2.0	MIT License
connected-react-router	6.8.0	MIT License
react	16.13.1	MIT License
react-bootstrap	1.0.1	MIT License
react-dnd	16.13.1	MIT License
react-dnd-html5-backend	7.4.4	MIT License
react-helmet	6.1.0	MIT License
react-dom	16.13.0	MIT License
react-id-generator	3.0.0	MIT License
react-router	5.1.2	MIT License
react-select	3.1.0	MIT License
react-tabs	3.1.0	MIT License
react-i18next	11.3.5	MIT License
react-redux	7.2.0	MIT License
redux-actions	2.6.5	MIT License
redux-localstorage	0.4.1	MIT License
redux	4.0.5	MIT License
redux-thunk	2.2.0	MIT License
bootstrap	4.4.1	MIT License
i18next	19.4.2	MIT License
sweetalert2	9.10.12	MIT License
fs-extra	9.0.0	MIT License
file-exists	5.0.1	MIT License
babel	7.9.0	MIT License
history	4.10.1	MIT License
immer	6.0.3	MIT License
jquery	3.5.1	MIT License
popper.js	1.16.0	MIT License
prop-types	15.7.2	MIT License
Json.NET	12.0.3	MIT License
lodash	4.17.15	MIT License
extend	3.0.2	MIT License
mxgraph-js	1.0.1	Apache License 2.0
guid-typescript	1.0.9	ISC License

## ■electron

This product uses electron which is licensed by MIT.

The copyright and license notice of electron is shown below.

---

Version 8.2.5  
MIT License  
Copyright (c) 2013-2019 GitHub Inc.

Permission is hereby granted, free of charge, to any person obtaining a copy of this software and associated documentation files (the "Software"), to deal in the Software without restriction, including without limitation the rights to use, copy, modify, merge, publish, distribute, sublicense, and/or sell copies of the Software, and to permit persons to whom the Software is furnished to do so, subject to the following conditions:

The above copyright notice and this permission notice shall be included in all copies or substantial portions of the Software.

THE SOFTWARE IS PROVIDED "AS IS", WITHOUT WARRANTY OF ANY KIND, EXPRESS OR IMPLIED, INCLUDING BUT NOT LIMITED TO THE WARRANTIES OF MERCHANTABILITY, FITNESS FOR A PARTICULAR PURPOSE AND NONINFRINGEMENT. IN NO EVENT SHALL THE AUTHORS OR COPYRIGHT HOLDERS BE LIABLE FOR ANY CLAIM, DAMAGES OR OTHER LIABILITY, WHETHER IN AN ACTION OF CONTRACT, TORT OR OTHERWISE, ARISING FROM, OUT OF OR IN CONNECTION WITH THE SOFTWARE OR THE USE OR OTHER DEALINGS IN THE SOFTWARE.

---

## ■electron-splashscreen

This product uses electron-splashscreen which is licensed by MIT.

The copyright and license notice of electron-splashscreen is shown below.

---

Version: 1.0.0  
MIT License  
Copyright (c) 2017 Troy McKinnon.

Permission is hereby granted, free of charge, to any person obtaining a copy of this software and associated documentation files (the "Software"), to deal in the Software without restriction, including without limitation the rights to use, copy, modify, merge, publish, distribute, sublicense, and/or sell copies of the Software, and to permit persons to whom the Software is furnished to do so, subject to the following conditions:

The above copyright notice and this permission notice shall be included in all copies or substantial portions of the Software.

THE SOFTWARE IS PROVIDED "AS IS", WITHOUT WARRANTY OF ANY KIND, EXPRESS OR IMPLIED, INCLUDING BUT NOT LIMITED TO THE WARRANTIES OF MERCHANTABILITY, FITNESS FOR A PARTICULAR PURPOSE AND NONINFRINGEMENT. IN NO EVENT SHALL THE AUTHORS OR COPYRIGHT HOLDERS BE LIABLE FOR ANY CLAIM, DAMAGES OR OTHER LIABILITY, WHETHER IN AN ACTION OF CONTRACT, TORT OR OTHERWISE, ARISING FROM, OUT OF OR IN CONNECTION WITH THE SOFTWARE OR THE USE OR OTHER DEALINGS IN THE SOFTWARE.

---

## ■electron-progressbar

This product uses electron-progressbar which is licensed by MIT.

The copyright and license notice of electron-progressbar is shown below.

---

Version: 1.2.0  
MIT License  
Copyright (c) 2017 Anderson Ravagnani Mamede

Permission is hereby granted, free of charge, to any person obtaining a copy of this software and associated documentation files (the "Software"), to deal in the Software without restriction, including without limitation the rights to use, copy, modify, merge, publish, distribute, sublicense, and/or sell copies of the Software, and to permit persons to whom the Software is furnished to do so, subject to the following conditions:

The above copyright notice and this permission notice shall be included in all copies or substantial portions of the Software.

THE SOFTWARE IS PROVIDED "AS IS", WITHOUT WARRANTY OF ANY KIND, EXPRESS OR IMPLIED, INCLUDING BUT NOT LIMITED TO THE WARRANTIES OF MERCHANTABILITY, FITNESS FOR A PARTICULAR PURPOSE AND NONINFRINGEMENT. IN NO EVENT SHALL THE AUTHORS OR COPYRIGHT HOLDERS BE LIABLE FOR ANY CLAIM, DAMAGES OR OTHER LIABILITY, WHETHER IN AN ACTION OF CONTRACT, TORT OR OTHERWISE, ARISING FROM, OUT OF OR IN CONNECTION WITH THE SOFTWARE OR THE USE OR OTHER DEALINGS IN THE SOFTWARE.

---

## ■connected-react-router

This product uses connected-react-router which is licensed by MIT.

The copyright and license notice of connected-react-router is shown below.

---

Version: 6.8.0  
MIT License  
Copyright (c) 2016-present Supasate Choochaisri

Permission is hereby granted, free of charge, to any person obtaining a copy of this software and associated documentation files (the "Software"), to deal in the Software without restriction, including without limitation the rights to use, copy, modify, merge, publish, distribute, sublicense, and/or sell copies of the Software, and to permit persons to whom the Software is furnished to do so, subject to the following conditions:

The above copyright notice and this permission notice shall be included in all copies or substantial portions of the Software.

THE SOFTWARE IS PROVIDED "AS IS", WITHOUT WARRANTY OF ANY KIND, EXPRESS OR IMPLIED, INCLUDING BUT NOT LIMITED TO THE WARRANTIES OF MERCHANTABILITY, FITNESS FOR A PARTICULAR PURPOSE AND NONINFRINGEMENT. IN NO EVENT SHALL THE AUTHORS OR COPYRIGHT HOLDERS BE LIABLE FOR ANY CLAIM, DAMAGES OR OTHER LIABILITY, WHETHER IN AN ACTION OF CONTRACT, TORT OR OTHERWISE, ARISING FROM, OUT OF OR IN CONNECTION WITH THE SOFTWARE OR THE USE OR OTHER DEALINGS IN THE SOFTWARE.

---

## ■react

This product uses react which is licensed by MIT.

The copyright and license notice of react is shown below.

---

Version 16.13.1  
MIT License  
Copyright (c) Facebook, Inc. and its affiliates.

Permission is hereby granted, free of charge, to any person obtaining a copy of this software and associated documentation files (the "Software"), to deal in the Software without restriction, including without limitation the rights to use, copy, modify, merge, publish, distribute, sublicense, and/or sell copies of the Software, and to permit persons to whom the Software is furnished to do so, subject to the following conditions:

The above copyright notice and this permission notice shall be included in all copies or substantial portions of the Software.

THE SOFTWARE IS PROVIDED "AS IS", WITHOUT WARRANTY OF ANY KIND, EXPRESS OR IMPLIED, INCLUDING BUT NOT LIMITED TO THE WARRANTIES OF MERCHANTABILITY, FITNESS FOR A PARTICULAR PURPOSE AND NONINFRINGEMENT. IN NO EVENT SHALL THE AUTHORS OR COPYRIGHT HOLDERS BE LIABLE FOR ANY CLAIM, DAMAGES OR OTHER LIABILITY, WHETHER IN AN ACTION OF CONTRACT, TORT OR OTHERWISE, ARISING FROM, OUT OF OR IN CONNECTION WITH THE SOFTWARE OR THE USE OR OTHER DEALINGS IN THE SOFTWARE.

---

## ■react-bootstrap

This product uses react-bootstrap which is licensed by MIT.

The copyright and license notice of react-bootstrap is shown below.

---

Version 1.0.1  
MIT License  
Copyright (c) 2014-present Stephen J. Collings, Matthew Honnibal, Pieter Vanderwerff

Permission is hereby granted, free of charge, to any person obtaining a copy of this software and associated documentation files (the "Software"), to deal in the Software without restriction, including without limitation the rights to use, copy, modify, merge, publish, distribute, sublicense, and/or sell copies of the Software, and to permit persons to whom the Software is furnished to do so, subject to the following conditions:

The above copyright notice and this permission notice shall be included in all copies or substantial portions of the Software.

THE SOFTWARE IS PROVIDED "AS IS", WITHOUT WARRANTY OF ANY KIND, EXPRESS OR IMPLIED, INCLUDING BUT NOT LIMITED TO THE WARRANTIES OF MERCHANTABILITY, FITNESS FOR A PARTICULAR PURPOSE AND NONINFRINGEMENT. IN NO EVENT SHALL THE AUTHORS OR COPYRIGHT HOLDERS BE LIABLE FOR ANY CLAIM, DAMAGES OR OTHER LIABILITY, WHETHER IN AN ACTION OF CONTRACT, TORT OR OTHERWISE, ARISING FROM, OUT OF OR IN CONNECTION WITH THE SOFTWARE OR THE USE OR OTHER DEALINGS IN THE SOFTWARE.

---

## ■react-dnd

This product uses react-dnd which is licensed by MIT.

The copyright and license notice of react-dnd is shown below.

---

Version 16.13.1

MIT License

Copyright (c) 2015 Dan Abramov.

Permission is hereby granted, free of charge, to any person obtaining a copy of this software and associated documentation files (the "Software"), to deal in the Software without restriction, including without limitation the rights to use, copy, modify, merge, publish, distribute, sublicense, and/or sell copies of the Software, and to permit persons to whom the Software is furnished to do so, subject to the following conditions:

The above copyright notice and this permission notice shall be included in all copies or substantial portions of the Software.

THE SOFTWARE IS PROVIDED "AS IS", WITHOUT WARRANTY OF ANY KIND, EXPRESS OR IMPLIED, INCLUDING BUT NOT LIMITED TO THE WARRANTIES OF MERCHANTABILITY, FITNESS FOR A PARTICULAR PURPOSE AND NONINFRINGEMENT. IN NO EVENT SHALL THE AUTHORS OR COPYRIGHT HOLDERS BE LIABLE FOR ANY CLAIM, DAMAGES OR OTHER LIABILITY, WHETHER IN AN ACTION OF CONTRACT, TORT OR OTHERWISE, ARISING FROM, OUT OF OR IN CONNECTION WITH THE SOFTWARE OR THE USE OR OTHER DEALINGS IN THE SOFTWARE.

---

## ■react-dnd-html5-backend

This product uses react-dnd-html5-backend which is licensed by MIT.

The copyright and license notice of react-dnd-html5-backend is shown below.

---

Version 7.4.4

MIT License

Copyright (c) 2015 Dan Abramov.

Permission is hereby granted, free of charge, to any person obtaining a copy of this software and associated documentation files (the "Software"), to deal in the Software without restriction, including without limitation the rights to use, copy, modify, merge, publish, distribute, sublicense, and/or sell copies of the Software, and to permit persons to whom the Software is furnished to do so, subject to the following conditions:

The above copyright notice and this permission notice shall be included in all copies or substantial portions of the Software.

THE SOFTWARE IS PROVIDED "AS IS", WITHOUT WARRANTY OF ANY KIND, EXPRESS OR IMPLIED, INCLUDING BUT NOT LIMITED TO THE WARRANTIES OF MERCHANTABILITY, FITNESS FOR A PARTICULAR PURPOSE AND NONINFRINGEMENT. IN NO EVENT SHALL THE AUTHORS OR COPYRIGHT HOLDERS BE LIABLE FOR ANY CLAIM, DAMAGES OR OTHER LIABILITY, WHETHER IN AN ACTION OF CONTRACT, TORT OR OTHERWISE, ARISING FROM, OUT OF OR IN CONNECTION WITH THE SOFTWARE OR THE USE OR OTHER DEALINGS IN THE SOFTWARE.

---

## ■react-helmet

This product uses react-helmet which is licensed by MIT.

The copyright and license notice of react-helmet is shown below.

---

Version 6.1.0  
MIT License  
Copyright (c) 2015 NFL.

Permission is hereby granted, free of charge, to any person obtaining a copy of this software and associated documentation files (the "Software"), to deal in the Software without restriction, including without limitation the rights to use, copy, modify, merge, publish, distribute, sublicense, and/or sell copies of the Software, and to permit persons to whom the Software is furnished to do so, subject to the following conditions:

The above copyright notice and this permission notice shall be included in all copies or substantial portions of the Software.

THE SOFTWARE IS PROVIDED "AS IS", WITHOUT WARRANTY OF ANY KIND, EXPRESS OR IMPLIED, INCLUDING BUT NOT LIMITED TO THE WARRANTIES OF MERCHANTABILITY, FITNESS FOR A PARTICULAR PURPOSE AND NONINFRINGEMENT. IN NO EVENT SHALL THE AUTHORS OR COPYRIGHT HOLDERS BE LIABLE FOR ANY CLAIM, DAMAGES OR OTHER LIABILITY, WHETHER IN AN ACTION OF CONTRACT, TORT OR OTHERWISE, ARISING FROM, OUT OF OR IN CONNECTION WITH THE SOFTWARE OR THE USE OR OTHER DEALINGS IN THE SOFTWARE.

---

## ■react-dom

This product uses react-dom which is licensed by MIT.

The copyright and license notice of react-dom is shown below.

---

Version 16.13.0  
MIT License  
Copyright (c) Facebook, Inc. and its affiliates.

Permission is hereby granted, free of charge, to any person obtaining a copy of this software and associated documentation files (the "Software"), to deal in the Software without restriction, including without limitation the rights to use, copy, modify, merge, publish, distribute, sublicense, and/or sell copies of the Software, and to permit persons to whom the Software is furnished to do so, subject to the following conditions:

The above copyright notice and this permission notice shall be included in all copies or substantial portions of the Software.

THE SOFTWARE IS PROVIDED "AS IS", WITHOUT WARRANTY OF ANY KIND, EXPRESS OR IMPLIED, INCLUDING BUT NOT LIMITED TO THE WARRANTIES OF MERCHANTABILITY, FITNESS FOR A PARTICULAR PURPOSE AND NONINFRINGEMENT. IN NO EVENT SHALL THE AUTHORS OR COPYRIGHT HOLDERS BE LIABLE FOR ANY CLAIM, DAMAGES OR OTHER LIABILITY, WHETHER IN AN ACTION OF CONTRACT, TORT OR OTHERWISE, ARISING FROM, OUT OF OR IN CONNECTION WITH THE SOFTWARE OR THE USE OR OTHER DEALINGS IN THE SOFTWARE.

---

## ■react-id-generator

This product uses react-id-generator which is licensed by MIT.

The copyright and license notice of react-id-generator is shown below.

---

Version 3.0.0  
MIT License  
Copyright (c) 2019 Tomek.

Permission is hereby granted, free of charge, to any person obtaining a copy of this software and associated documentation files (the "Software"), to deal in the Software without restriction, including without limitation the rights to use, copy, modify, merge, publish, distribute, sublicense, and/or sell copies of the Software, and to permit persons to whom the Software is furnished to do so, subject to the following conditions:

The above copyright notice and this permission notice shall be included in all copies or substantial portions of the Software.

THE SOFTWARE IS PROVIDED "AS IS", WITHOUT WARRANTY OF ANY KIND, EXPRESS OR IMPLIED, INCLUDING BUT NOT LIMITED TO THE WARRANTIES OF MERCHANTABILITY, FITNESS FOR A PARTICULAR PURPOSE AND NONINFRINGEMENT. IN NO EVENT SHALL THE AUTHORS OR COPYRIGHT HOLDERS BE LIABLE FOR ANY CLAIM, DAMAGES OR OTHER LIABILITY, WHETHER IN AN ACTION OF CONTRACT, TORT OR OTHERWISE, ARISING FROM, OUT OF OR IN CONNECTION WITH THE SOFTWARE OR THE USE OR OTHER DEALINGS IN THE SOFTWARE.

---

## ■react-router

This product uses react-router which is licensed by MIT.

The copyright and license notice of react-router is shown below.

---

Version 5.1.2  
MIT License  
Copyright (c) React Training 2016-2018

Permission is hereby granted, free of charge, to any person obtaining a copy of this software and associated documentation files (the "Software"), to deal in the Software without restriction, including without limitation the rights to use, copy, modify, merge, publish, distribute, sublicense, and/or sell copies of the Software, and to permit persons to whom the Software is furnished to do so, subject to the following conditions:

The above copyright notice and this permission notice shall be included in all copies or substantial portions of the Software.

THE SOFTWARE IS PROVIDED "AS IS", WITHOUT WARRANTY OF ANY KIND, EXPRESS OR IMPLIED, INCLUDING BUT NOT LIMITED TO THE WARRANTIES OF MERCHANTABILITY, FITNESS FOR A PARTICULAR PURPOSE AND NONINFRINGEMENT. IN NO EVENT SHALL THE AUTHORS OR COPYRIGHT HOLDERS BE LIABLE FOR ANY CLAIM, DAMAGES OR OTHER LIABILITY, WHETHER IN AN ACTION OF CONTRACT, TORT OR OTHERWISE, ARISING FROM, OUT OF OR IN CONNECTION WITH THE SOFTWARE OR THE USE OR OTHER DEALINGS IN THE SOFTWARE.

---

## ■react-select

This product uses react-select which is licensed by MIT.

The copyright and license notice of react-select is shown below.

---

Version 3.1.0  
MIT License  
Copyright (c) 2018 Jed Watson

Permission is hereby granted, free of charge, to any person obtaining a copy of this software and associated documentation files (the "Software"), to deal in the Software without restriction, including without limitation the rights to use, copy, modify, merge, publish, distribute, sublicense, and/or sell copies of the Software, and to permit persons to whom the Software is furnished to do so, subject to the following conditions:

The above copyright notice and this permission notice shall be included in all copies or substantial portions of the Software.

THE SOFTWARE IS PROVIDED "AS IS", WITHOUT WARRANTY OF ANY KIND, EXPRESS OR IMPLIED, INCLUDING BUT NOT LIMITED TO THE WARRANTIES OF MERCHANTABILITY, FITNESS FOR A PARTICULAR PURPOSE AND NONINFRINGEMENT. IN NO EVENT SHALL THE AUTHORS OR COPYRIGHT HOLDERS BE LIABLE FOR ANY CLAIM, DAMAGES OR OTHER LIABILITY, WHETHER IN AN ACTION OF CONTRACT, TORT OR OTHERWISE, ARISING FROM, OUT OF OR IN CONNECTION WITH THE SOFTWARE OR THE USE OR OTHER DEALINGS IN THE SOFTWARE.

---

## ■react-tabs

This product uses react-tabs which is licensed by MIT.

The copyright and license notice of react-tabs is shown below.

---

Version 3.1.0  
MIT License  
Copyright (c) 2015-2019 by Matt Zabriskie

Permission is hereby granted, free of charge, to any person obtaining a copy of this software and associated documentation files (the "Software"), to deal in the Software without restriction, including without limitation the rights to use, copy, modify, merge, publish, distribute, sublicense, and/or sell copies of the Software, and to permit persons to whom the Software is furnished to do so, subject to the following conditions:

The above copyright notice and this permission notice shall be included in all copies or substantial portions of the Software.

THE SOFTWARE IS PROVIDED "AS IS", WITHOUT WARRANTY OF ANY KIND, EXPRESS OR IMPLIED, INCLUDING BUT NOT LIMITED TO THE WARRANTIES OF MERCHANTABILITY, FITNESS FOR A PARTICULAR PURPOSE AND NONINFRINGEMENT. IN NO EVENT SHALL THE AUTHORS OR COPYRIGHT HOLDERS BE LIABLE FOR ANY CLAIM, DAMAGES OR OTHER LIABILITY, WHETHER IN AN ACTION OF CONTRACT, TORT OR OTHERWISE, ARISING FROM, OUT OF OR IN CONNECTION WITH THE SOFTWARE OR THE USE OR OTHER DEALINGS IN THE SOFTWARE.

---

## ■react-i18next

This product uses react-i18next which is licensed by MIT.

The copyright and license notice of react-i18next is shown below.

---

Version: 11.3.5  
MIT License  
Copyright (c) 2015 i18next

Permission is hereby granted, free of charge, to any person obtaining a copy of this software and associated documentation files (the "Software"), to deal in the Software without restriction, including without limitation the rights to use, copy, modify, merge, publish, distribute, sublicense, and/or sell copies of the Software, and to permit persons to whom the Software is furnished to do so, subject to the following conditions:

The above copyright notice and this permission notice shall be included in all copies or substantial portions of the Software.

THE SOFTWARE IS PROVIDED "AS IS", WITHOUT WARRANTY OF ANY KIND, EXPRESS OR IMPLIED, INCLUDING BUT NOT LIMITED TO THE WARRANTIES OF MERCHANTABILITY, FITNESS FOR A PARTICULAR PURPOSE AND NONINFRINGEMENT. IN NO EVENT SHALL THE AUTHORS OR COPYRIGHT HOLDERS BE LIABLE FOR ANY CLAIM, DAMAGES OR OTHER LIABILITY, WHETHER IN AN ACTION OF CONTRACT, TORT OR OTHERWISE, ARISING FROM, OUT OF OR IN CONNECTION WITH THE SOFTWARE OR THE USE OR OTHER DEALINGS IN THE SOFTWARE.

---

## ■react-redux

This product uses react-redux which is licensed by MIT.

The copyright and license notice of react-redux is shown below.

---

Version 7.2.0  
MIT License  
Copyright (c) 2015-present Dan Abramov

Permission is hereby granted, free of charge, to any person obtaining a copy of this software and associated documentation files (the "Software"), to deal in the Software without restriction, including without limitation the rights to use, copy, modify, merge, publish, distribute, sublicense, and/or sell copies of the Software, and to permit persons to whom the Software is furnished to do so, subject to the following conditions:

The above copyright notice and this permission notice shall be included in all copies or substantial portions of the Software.

THE SOFTWARE IS PROVIDED "AS IS", WITHOUT WARRANTY OF ANY KIND, EXPRESS OR IMPLIED, INCLUDING BUT NOT LIMITED TO THE WARRANTIES OF MERCHANTABILITY, FITNESS FOR A PARTICULAR PURPOSE AND NONINFRINGEMENT. IN NO EVENT SHALL THE AUTHORS OR COPYRIGHT HOLDERS BE LIABLE FOR ANY CLAIM, DAMAGES OR OTHER LIABILITY, WHETHER IN AN ACTION OF CONTRACT, TORT OR OTHERWISE, ARISING FROM, OUT OF OR IN CONNECTION WITH THE SOFTWARE OR THE USE OR OTHER DEALINGS IN THE SOFTWARE.

---

## ■redux-actions

This product uses redux-actions which is licensed by MIT.

The copyright and license notice of redux-actions is shown below.

---

Version: 2.6.5  
MIT License  
Copyright (c) Andrew Clark.

Permission is hereby granted, free of charge, to any person obtaining a copy of this software and associated documentation files (the "Software"), to deal in the Software without restriction, including without limitation the rights to use, copy, modify, merge, publish, distribute, sublicense, and/or sell copies of the Software, and to permit persons to whom the Software is furnished to do so, subject to the following conditions:

The above copyright notice and this permission notice shall be included in all copies or substantial portions of the Software.

THE SOFTWARE IS PROVIDED "AS IS", WITHOUT WARRANTY OF ANY KIND, EXPRESS OR IMPLIED, INCLUDING BUT NOT LIMITED TO THE WARRANTIES OF MERCHANTABILITY, FITNESS FOR A PARTICULAR PURPOSE AND NONINFRINGEMENT. IN NO EVENT SHALL THE AUTHORS OR COPYRIGHT HOLDERS BE LIABLE FOR ANY CLAIM, DAMAGES OR OTHER LIABILITY, WHETHER IN AN ACTION OF CONTRACT, TORT OR OTHERWISE, ARISING FROM, OUT OF OR IN CONNECTION WITH THE SOFTWARE OR THE USE OR OTHER DEALINGS IN THE SOFTWARE.

---

## ■redux-localstorage

This product uses redux-localstorage which is licensed by MIT.

The copyright and license notice of redux-localstorage is shown below.

---

Version: 0.4.1  
MIT License  
Copyright (c) 2015 Elger Lambert

Permission is hereby granted, free of charge, to any person obtaining a copy of this software and associated documentation files (the "Software"), to deal in the Software without restriction, including without limitation the rights to use, copy, modify, merge, publish, distribute, sublicense, and/or sell copies of the Software, and to permit persons to whom the Software is furnished to do so, subject to the following conditions:

The above copyright notice and this permission notice shall be included in all copies or substantial portions of the Software.

THE SOFTWARE IS PROVIDED "AS IS", WITHOUT WARRANTY OF ANY KIND, EXPRESS OR IMPLIED, INCLUDING BUT NOT LIMITED TO THE WARRANTIES OF MERCHANTABILITY, FITNESS FOR A PARTICULAR PURPOSE AND NONINFRINGEMENT. IN NO EVENT SHALL THE AUTHORS OR COPYRIGHT HOLDERS BE LIABLE FOR ANY CLAIM, DAMAGES OR OTHER LIABILITY, WHETHER IN AN ACTION OF CONTRACT, TORT OR OTHERWISE, ARISING FROM, OUT OF OR IN CONNECTION WITH THE SOFTWARE OR THE USE OR OTHER DEALINGS IN THE SOFTWARE.

---

## ■redux

This product uses redux which is licensed by MIT.

The copyright and license notice of redux is shown below.

---

Version 4.0.5  
MIT License  
Copyright (c) 2015-present Dan Abramov

Permission is hereby granted, free of charge, to any person obtaining a copy of this software and associated documentation files (the "Software"), to deal in the Software without restriction, including without limitation the rights to use, copy, modify, merge, publish, distribute, sublicense, and/or sell copies of the Software, and to permit persons to whom the Software is furnished to do so, subject to the following conditions:

The above copyright notice and this permission notice shall be included in all copies or substantial portions of the Software.

THE SOFTWARE IS PROVIDED "AS IS", WITHOUT WARRANTY OF ANY KIND, EXPRESS OR IMPLIED, INCLUDING BUT NOT LIMITED TO THE WARRANTIES OF MERCHANTABILITY, FITNESS FOR A PARTICULAR PURPOSE AND NONINFRINGEMENT. IN NO EVENT SHALL THE AUTHORS OR COPYRIGHT HOLDERS BE LIABLE FOR ANY CLAIM, DAMAGES OR OTHER LIABILITY, WHETHER IN AN ACTION OF CONTRACT, TORT OR OTHERWISE, ARISING FROM, OUT OF OR IN CONNECTION WITH THE SOFTWARE OR THE USE OR OTHER DEALINGS IN THE SOFTWARE.

---



## ■redux-thunk

This product uses redux-thunk which is licensed by MIT.

The copyright and license notice of redux-thunk is shown below.

---

Version: 2.2.0  
MIT License  
Copyright (c) 2015-present Dan Abramov.

Permission is hereby granted, free of charge, to any person obtaining a copy of this software and associated documentation files (the "Software"), to deal in the Software without restriction, including without limitation the rights to use, copy, modify, merge, publish, distribute, sublicense, and/or sell copies of the Software, and to permit persons to whom the Software is furnished to do so, subject to the following conditions:

The above copyright notice and this permission notice shall be included in all copies or substantial portions of the Software.

THE SOFTWARE IS PROVIDED "AS IS", WITHOUT WARRANTY OF ANY KIND, EXPRESS OR IMPLIED, INCLUDING BUT NOT LIMITED TO THE WARRANTIES OF MERCHANTABILITY, FITNESS FOR A PARTICULAR PURPOSE AND NONINFRINGEMENT. IN NO EVENT SHALL THE AUTHORS OR COPYRIGHT HOLDERS BE LIABLE FOR ANY CLAIM, DAMAGES OR OTHER LIABILITY, WHETHER IN AN ACTION OF CONTRACT, TORT OR OTHERWISE, ARISING FROM, OUT OF OR IN CONNECTION WITH THE SOFTWARE OR THE USE OR OTHER DEALINGS IN THE SOFTWARE.

---

## ■bootstrap

This product uses bootstrap which is licensed by MIT.

The copyright and license notice of bootstrap is shown below.

---

Version 4.4.1  
MIT License  
Copyright (c) 2014-present Stephen J. Collings, Matthew Honnibal, Pieter Vanderwerff

Permission is hereby granted, free of charge, to any person obtaining a copy of this software and associated documentation files (the "Software"), to deal in the Software without restriction, including without limitation the rights to use, copy, modify, merge, publish, distribute, sublicense, and/or sell copies of the Software, and to permit persons to whom the Software is furnished to do so, subject to the following conditions:

The above copyright notice and this permission notice shall be included in all copies or substantial portions of the Software.

THE SOFTWARE IS PROVIDED "AS IS", WITHOUT WARRANTY OF ANY KIND, EXPRESS OR IMPLIED, INCLUDING BUT NOT LIMITED TO THE WARRANTIES OF MERCHANTABILITY, FITNESS FOR A PARTICULAR PURPOSE AND NONINFRINGEMENT. IN NO EVENT SHALL THE AUTHORS OR COPYRIGHT HOLDERS BE LIABLE FOR ANY CLAIM, DAMAGES OR OTHER LIABILITY, WHETHER IN AN ACTION OF CONTRACT, TORT OR OTHERWISE, ARISING FROM, OUT OF OR IN CONNECTION WITH THE SOFTWARE OR THE USE OR OTHER DEALINGS IN THE SOFTWARE.

---

## ■i18next

This product uses i18next which is licensed by MIT.

The copyright and license notice of i18next is shown below.

---

Version 19.4.2  
MIT License  
Copyright (c) 2017 i18next

Permission is hereby granted, free of charge, to any person obtaining a copy of this software and associated documentation files (the "Software"), to deal in the Software without restriction, including without limitation the rights to use, copy, modify, merge, publish, distribute, sublicense, and/or sell copies of the Software, and to permit persons to whom the Software is furnished to do so, subject to the following conditions:

The above copyright notice and this permission notice shall be included in all copies or substantial portions of the Software.

THE SOFTWARE IS PROVIDED "AS IS", WITHOUT WARRANTY OF ANY KIND, EXPRESS OR IMPLIED, INCLUDING BUT NOT LIMITED TO THE WARRANTIES OF MERCHANTABILITY, FITNESS FOR A PARTICULAR PURPOSE AND NONINFRINGEMENT. IN NO EVENT SHALL THE AUTHORS OR COPYRIGHT HOLDERS BE LIABLE FOR ANY CLAIM, DAMAGES OR OTHER LIABILITY, WHETHER IN AN ACTION OF CONTRACT, TORT OR OTHERWISE, ARISING FROM, OUT OF OR IN CONNECTION WITH THE SOFTWARE OR THE USE OR OTHER DEALINGS IN THE SOFTWARE.

---

## ■sweetalert2

This product uses sweetalert2 which is licensed by MIT.

The copyright and license notice of sweetalert2 is shown below.

---

Version 9.10.12

MIT License

Copyright (c) 2014 Tristan Edwards & Limon Monte

Permission is hereby granted, free of charge, to any person obtaining a copy of this software and associated documentation files (the "Software"), to deal in the Software without restriction, including without limitation the rights to use, copy, modify, merge, publish, distribute, sublicense, and/or sell copies of the Software, and to permit persons to whom the Software is furnished to do so, subject to the following conditions:

The above copyright notice and this permission notice shall be included in all copies or substantial portions of the Software.

THE SOFTWARE IS PROVIDED "AS IS", WITHOUT WARRANTY OF ANY KIND, EXPRESS OR IMPLIED, INCLUDING BUT NOT LIMITED TO THE WARRANTIES OF MERCHANTABILITY, FITNESS FOR A PARTICULAR PURPOSE AND NONINFRINGEMENT. IN NO EVENT SHALL THE AUTHORS OR COPYRIGHT HOLDERS BE LIABLE FOR ANY CLAIM, DAMAGES OR OTHER LIABILITY, WHETHER IN AN ACTION OF CONTRACT, TORT OR OTHERWISE, ARISING FROM, OUT OF OR IN CONNECTION WITH THE SOFTWARE OR THE USE OR OTHER DEALINGS IN THE SOFTWARE.

---

## ■fs-extra

This product uses fs-extra which is licensed by MIT.

The copyright and license notice of fs-extra is shown below.

---

Version: 9.0.0

The MIT License

Copyright (c) 2011-2017 JP Richardson.

Permission is hereby granted, free of charge, to any person obtaining a copy of this software and associated documentation files (the "Software"), to deal in the Software without restriction, including without limitation the rights to use, copy, modify, merge, publish, distribute, sublicense, and/or sell copies of the Software, and to permit persons to whom the Software is furnished to do so, subject to the following conditions:

The above copyright notice and this permission notice shall be included in all copies or substantial portions of the Software.

THE SOFTWARE IS PROVIDED "AS IS", WITHOUT WARRANTY OF ANY KIND, EXPRESS OR IMPLIED, INCLUDING BUT NOT LIMITED TO THE WARRANTIES OF MERCHANTABILITY, FITNESS FOR A PARTICULAR PURPOSE AND NONINFRINGEMENT. IN NO EVENT SHALL THE AUTHORS OR COPYRIGHT HOLDERS BE LIABLE FOR ANY CLAIM, DAMAGES OR OTHER LIABILITY, WHETHER IN AN ACTION OF CONTRACT, TORT OR OTHERWISE, ARISING FROM, OUT OF OR IN CONNECTION WITH THE SOFTWARE OR THE USE OR OTHER DEALINGS IN THE SOFTWARE.

---

## ■file-exists

This product uses file-exists which is licensed by MIT.

The copyright and license notice of file-exists is shown below.

---

Version 5.0.1  
MIT License  
Copyright (c) 2014 Scott Corgan

Permission is hereby granted, free of charge, to any person obtaining a copy of this software and associated documentation files (the "Software"), to deal in the Software without restriction, including without limitation the rights to use, copy, modify, merge, publish, distribute, sublicense, and/or sell copies of the Software, and to permit persons to whom the Software is furnished to do so, subject to the following conditions:

The above copyright notice and this permission notice shall be included in all copies or substantial portions of the Software.

THE SOFTWARE IS PROVIDED "AS IS", WITHOUT WARRANTY OF ANY KIND, EXPRESS OR IMPLIED, INCLUDING BUT NOT LIMITED TO THE WARRANTIES OF MERCHANTABILITY, FITNESS FOR A PARTICULAR PURPOSE AND NONINFRINGEMENT. IN NO EVENT SHALL THE AUTHORS OR COPYRIGHT HOLDERS BE LIABLE FOR ANY CLAIM, DAMAGES OR OTHER LIABILITY, WHETHER IN AN ACTION OF CONTRACT, TORT OR OTHERWISE, ARISING FROM, OUT OF OR IN CONNECTION WITH THE SOFTWARE OR THE USE OR OTHER DEALINGS IN THE SOFTWARE.

---

## ■babel

This product uses babel which is licensed by MIT.

The copyright and license notice of babel is shown below.

---

Version 7.9.0  
MIT License  
Copyright (c) 2014-present Sebastian McKenzie and other contributors

Permission is hereby granted, free of charge, to any person obtaining a copy of this software and associated documentation files (the "Software"), to deal in the Software without restriction, including without limitation the rights to use, copy, modify, merge, publish, distribute, sublicense, and/or sell copies of the Software, and to permit persons to whom the Software is furnished to do so, subject to the following conditions:

The above copyright notice and this permission notice shall be included in all copies or substantial portions of the Software.

THE SOFTWARE IS PROVIDED "AS IS", WITHOUT WARRANTY OF ANY KIND, EXPRESS OR IMPLIED, INCLUDING BUT NOT LIMITED TO THE WARRANTIES OF MERCHANTABILITY, FITNESS FOR A PARTICULAR PURPOSE AND NONINFRINGEMENT. IN NO EVENT SHALL THE AUTHORS OR COPYRIGHT HOLDERS BE LIABLE FOR ANY CLAIM, DAMAGES OR OTHER LIABILITY, WHETHER IN AN ACTION OF CONTRACT, TORT OR OTHERWISE, ARISING FROM, OUT OF OR IN CONNECTION WITH THE SOFTWARE OR THE USE OR OTHER DEALINGS IN THE SOFTWARE.

---

## ■history

This product uses history which is licensed by MIT.

The copyright and license notice of history is shown below.

---

Version 4.10.1  
MIT License  
Copyright (c) React Training 2016-2018

Permission is hereby granted, free of charge, to any person obtaining a copy of this software and associated documentation files (the "Software"), to deal in the Software without restriction, including without limitation the rights to use, copy, modify, merge, publish, distribute, sublicense, and/or sell copies of the Software, and to permit persons to whom the Software is furnished to do so, subject to the following conditions:

The above copyright notice and this permission notice shall be included in all copies or substantial portions of the Software.

THE SOFTWARE IS PROVIDED "AS IS", WITHOUT WARRANTY OF ANY KIND, EXPRESS OR IMPLIED, INCLUDING BUT NOT LIMITED TO THE WARRANTIES OF MERCHANTABILITY, FITNESS FOR A PARTICULAR PURPOSE AND NONINFRINGEMENT. IN NO EVENT SHALL THE AUTHORS OR COPYRIGHT HOLDERS BE LIABLE FOR ANY CLAIM, DAMAGES OR OTHER LIABILITY, WHETHER IN AN ACTION OF CONTRACT, TORT OR OTHERWISE, ARISING FROM, OUT OF OR IN CONNECTION WITH THE SOFTWARE OR THE USE OR OTHER DEALINGS IN THE SOFTWARE.

---

## ■immer

This product uses immer which is licensed by MIT.

The copyright and license notice of immer is shown below.

---

Version 6.0.3  
MIT License  
Copyright (c) 2017 Michel Weststrate

Permission is hereby granted, free of charge, to any person obtaining a copy of this software and associated documentation files (the "Software"), to deal in the Software without restriction, including without limitation the rights to use, copy, modify, merge, publish, distribute, sublicense, and/or sell copies of the Software, and to permit persons to whom the Software is furnished to do so, subject to the following conditions:

The above copyright notice and this permission notice shall be included in all copies or substantial portions of the Software.

THE SOFTWARE IS PROVIDED "AS IS", WITHOUT WARRANTY OF ANY KIND, EXPRESS OR IMPLIED, INCLUDING BUT NOT LIMITED TO THE WARRANTIES OF MERCHANTABILITY, FITNESS FOR A PARTICULAR PURPOSE AND NONINFRINGEMENT. IN NO EVENT SHALL THE AUTHORS OR COPYRIGHT HOLDERS BE LIABLE FOR ANY CLAIM, DAMAGES OR OTHER LIABILITY, WHETHER IN AN ACTION OF CONTRACT, TORT OR OTHERWISE, ARISING FROM, OUT OF OR IN CONNECTION WITH THE SOFTWARE OR THE USE OR OTHER DEALINGS IN THE SOFTWARE.

---

## ■jquery

This product uses jquery which is licensed by MIT.

The copyright and license notice of jquery is shown below.

---

Version 3.5.1  
MIT License  
Copyright OpenJS Foundation and other contributors, <https://openjsf.org/>

Permission is hereby granted, free of charge, to any person obtaining a copy of this software and associated documentation files (the "Software"), to deal in the Software without restriction, including without limitation the rights to use, copy, modify, merge, publish, distribute, sublicense, and/or sell copies of the Software, and to permit persons to whom the Software is furnished to do so, subject to the following conditions:

The above copyright notice and this permission notice shall be included in all copies or substantial portions of the Software.

THE SOFTWARE IS PROVIDED "AS IS", WITHOUT WARRANTY OF ANY KIND, EXPRESS OR IMPLIED, INCLUDING BUT NOT LIMITED TO THE WARRANTIES OF MERCHANTABILITY, FITNESS FOR A PARTICULAR PURPOSE AND NONINFRINGEMENT. IN NO EVENT SHALL THE AUTHORS OR COPYRIGHT HOLDERS BE LIABLE FOR ANY CLAIM, DAMAGES OR OTHER LIABILITY, WHETHER IN AN ACTION OF CONTRACT, TORT OR OTHERWISE, ARISING FROM, OUT OF OR IN CONNECTION WITH THE SOFTWARE OR THE USE OR OTHER DEALINGS IN THE SOFTWARE.

---

## ■popper.js

This product uses popper.js which is licensed by MIT.

The copyright and license notice of popper.js is shown below.

---

Version 1.16.0  
MIT License  
Copyright (c) 2019 Federico Zivolo

Permission is hereby granted, free of charge, to any person obtaining a copy of this software and associated documentation files (the "Software"), to deal in the Software without restriction, including without limitation the rights to use, copy, modify, merge, publish, distribute, sublicense, and/or sell copies of the Software, and to permit persons to whom the Software is furnished to do so, subject to the following conditions:

The above copyright notice and this permission notice shall be included in all copies or substantial portions of the Software.

THE SOFTWARE IS PROVIDED "AS IS", WITHOUT WARRANTY OF ANY KIND, EXPRESS OR IMPLIED, INCLUDING BUT NOT LIMITED TO THE WARRANTIES OF MERCHANTABILITY, FITNESS FOR A PARTICULAR PURPOSE AND NONINFRINGEMENT. IN NO EVENT SHALL THE AUTHORS OR COPYRIGHT HOLDERS BE LIABLE FOR ANY CLAIM, DAMAGES OR OTHER LIABILITY, WHETHER IN AN ACTION OF CONTRACT, TORT OR OTHERWISE, ARISING FROM, OUT OF OR IN CONNECTION WITH THE SOFTWARE OR THE USE OR OTHER DEALINGS IN THE SOFTWARE.

---

## ■prop-types

This product uses prop-types which is licensed by MIT.

The copyright and license notice of prop-types is shown below.

---

Version 15.7.2

MIT License

Copyright (c) 2013-present, Facebook, Inc.

Permission is hereby granted, free of charge, to any person obtaining a copy of this software and associated documentation files (the "Software"), to deal in the Software without restriction, including without limitation the rights to use, copy, modify, merge, publish, distribute, sublicense, and/or sell copies of the Software, and to permit persons to whom the Software is furnished to do so, subject to the following conditions:

The above copyright notice and this permission notice shall be included in all copies or substantial portions of the Software.

THE SOFTWARE IS PROVIDED "AS IS", WITHOUT WARRANTY OF ANY KIND, EXPRESS OR IMPLIED, INCLUDING BUT NOT LIMITED TO THE WARRANTIES OF MERCHANTABILITY, FITNESS FOR A PARTICULAR PURPOSE AND NONINFRINGEMENT. IN NO EVENT SHALL THE AUTHORS OR COPYRIGHT HOLDERS BE LIABLE FOR ANY CLAIM, DAMAGES OR OTHER LIABILITY, WHETHER IN AN ACTION OF CONTRACT, TORT OR OTHERWISE, ARISING FROM, OUT OF OR IN CONNECTION WITH THE SOFTWARE OR THE USE OR OTHER DEALINGS IN THE SOFTWARE.

---

## ■Json.NET

This product uses Json.NET which is licensed by MIT.

The copyright and license notice of Json.NET is shown below.

---

Version 12.0.3  
MIT License  
Copyright (c) 2007 James Newton-King.

Permission is hereby granted, free of charge, to any person obtaining a copy of this software and associated documentation files (the "Software"), to deal in the Software without restriction, including without limitation the rights to use, copy, modify, merge, publish, distribute, sublicense, and/or sell copies of the Software, and to permit persons to whom the Software is furnished to do so, subject to the following conditions:

The above copyright notice and this permission notice shall be included in all copies or substantial portions of the Software.

THE SOFTWARE IS PROVIDED "AS IS", WITHOUT WARRANTY OF ANY KIND, EXPRESS OR IMPLIED, INCLUDING BUT NOT LIMITED TO THE WARRANTIES OF MERCHANTABILITY, FITNESS FOR A PARTICULAR PURPOSE AND NONINFRINGEMENT. IN NO EVENT SHALL THE AUTHORS OR COPYRIGHT HOLDERS BE LIABLE FOR ANY CLAIM, DAMAGES OR OTHER LIABILITY, WHETHER IN AN ACTION OF CONTRACT, TORT OR OTHERWISE, ARISING FROM, OUT OF OR IN CONNECTION WITH THE SOFTWARE OR THE USE OR OTHER DEALINGS IN THE SOFTWARE.

---

## ■lodash

This product uses lodash which is licensed by MIT.

The copyright and license notice of lodash is shown below.

---

Version 4.17.15  
MIT License  
Copyright JS Foundation and other contributors <<https://js.foundation/>>

Based on Underscore.js, copyright Jeremy Ashkenas, DocumentCloud and Investigative Reporters & Editors <<http://underscorejs.org/>>  
This software consists of voluntary contributions made by many individuals. For exact contribution history, see the revision history available at <https://github.com/lodash/lodash>

Permission is hereby granted, free of charge, to any person obtaining a copy of this software and associated documentation files (the "Software"), to deal in the Software without restriction, including without limitation the rights to use, copy, modify, merge, publish, distribute, sublicense, and/or sell copies of the Software, and to permit persons to whom the Software is furnished to do so, subject to the following conditions:

The above copyright notice and this permission notice shall be included in all copies or substantial portions of the Software.

THE SOFTWARE IS PROVIDED "AS IS", WITHOUT WARRANTY OF ANY KIND, EXPRESS OR IMPLIED, INCLUDING BUT NOT LIMITED TO THE WARRANTIES OF MERCHANTABILITY, FITNESS FOR A PARTICULAR PURPOSE AND NONINFRINGEMENT. IN NO EVENT SHALL THE AUTHORS OR COPYRIGHT HOLDERS BE LIABLE FOR ANY CLAIM, DAMAGES OR OTHER LIABILITY, WHETHER IN AN ACTION OF CONTRACT, TORT OR OTHERWISE, ARISING FROM, OUT OF OR IN CONNECTION WITH THE SOFTWARE OR THE USE OR OTHER DEALINGS IN THE SOFTWARE.

---

## ■extend

This product uses extend which is licensed by MIT.

The copyright and license notice of extend is shown below.

---

Version 3.0.2  
MIT License (MIT)  
Copyright (c) 2014 Stefan Thomas

Permission to use, copy, modify, and/or distribute this software for any purpose with or without fee is hereby granted, provided that the above copyright notice and this permission notice appear in all copies.

THE SOFTWARE IS PROVIDED "AS IS" AND THE AUTHOR DISCLAIMS ALL WARRANTIES WITH REGARD TO THIS SOFTWARE INCLUDING ALL IMPLIED WARRANTIES OF MERCHANTABILITY AND FITNESS. IN NO EVENT SHALL THE AUTHOR BE LIABLE FOR ANY SPECIAL, DIRECT, INDIRECT, OR CONSEQUENTIAL DAMAGES OR ANY DAMAGES WHATSOEVER RESULTING FROM LOSS OF USE, DATA OR PROFITS, WHETHER IN AN ACTION OF CONTRACT, NEGLIGENCE OR OTHER TORTIOUS ACTION, ARISING OUT OF OR IN CONNECTION WITH THE USE OR PERFORMANCE OF THIS SOFTWARE.

---

## ■mxgraph-js

This product uses mxgraph-js which is licensed by Apache (version 2.0).

The copyright and license notice of mxgraph-js is shown below.

---

Version 1.0.1  
Apache License 2.0  
Copyright 2010-2013 Coda Hale and Yammer, Inc., 2014-2015 Dropwizard Team

Licensed under the Apache License, Version 2.0 (the "License"); you may not use this file except in compliance with the License. You may obtain a copy of the License at

<http://www.apache.org/licenses/LICENSE-2.0>

Unless required by applicable law or agreed to in writing, software distributed under the License is distributed on an "AS IS" BASIS, WITHOUT WARRANTIES OR CONDITIONS OF ANY KIND, either express or implied. See the License for the specific language governing permissions and limitations under the License.

---

## ■guid-typescript

This product uses guid-typescript which is licensed by ISC.

The copyright and license notice of guid-typescript is shown below.

---

Version 1.0.9  
ISC License

Permission to use, copy, modify, and/or distribute this software for any purpose with or without fee is hereby granted, provided that the above copyright notice and this permission notice appear in all copies.

THE SOFTWARE IS PROVIDED "AS IS" AND THE AUTHOR DISCLAIMS ALL WARRANTIES WITH REGARD TO THIS SOFTWARE INCLUDING ALL IMPLIED WARRANTIES OF MERCHANTABILITY AND FITNESS. IN NO EVENT SHALL THE AUTHOR BE LIABLE FOR ANY SPECIAL, DIRECT, INDIRECT, OR CONSEQUENTIAL DAMAGES OR ANY DAMAGES WHATSOEVER RESULTING FROM LOSS OF USE, DATA OR PROFITS, WHETHER IN AN ACTION OF CONTRACT, NEGLIGENCE OR OTHER TORTIOUS ACTION, ARISING OUT OF OR IN CONNECTION WITH THE USE OR PERFORMANCE OF THIS SOFTWARE.

---

# 2 USER INTERFACE

## 2.1 Screen Structure

If a project is newly created or an existing one is opened, the following user interfaces will be displayed. When this tool is started, it will be in a state where no project is created, and only its menu bar and tool buttons will be displayed.

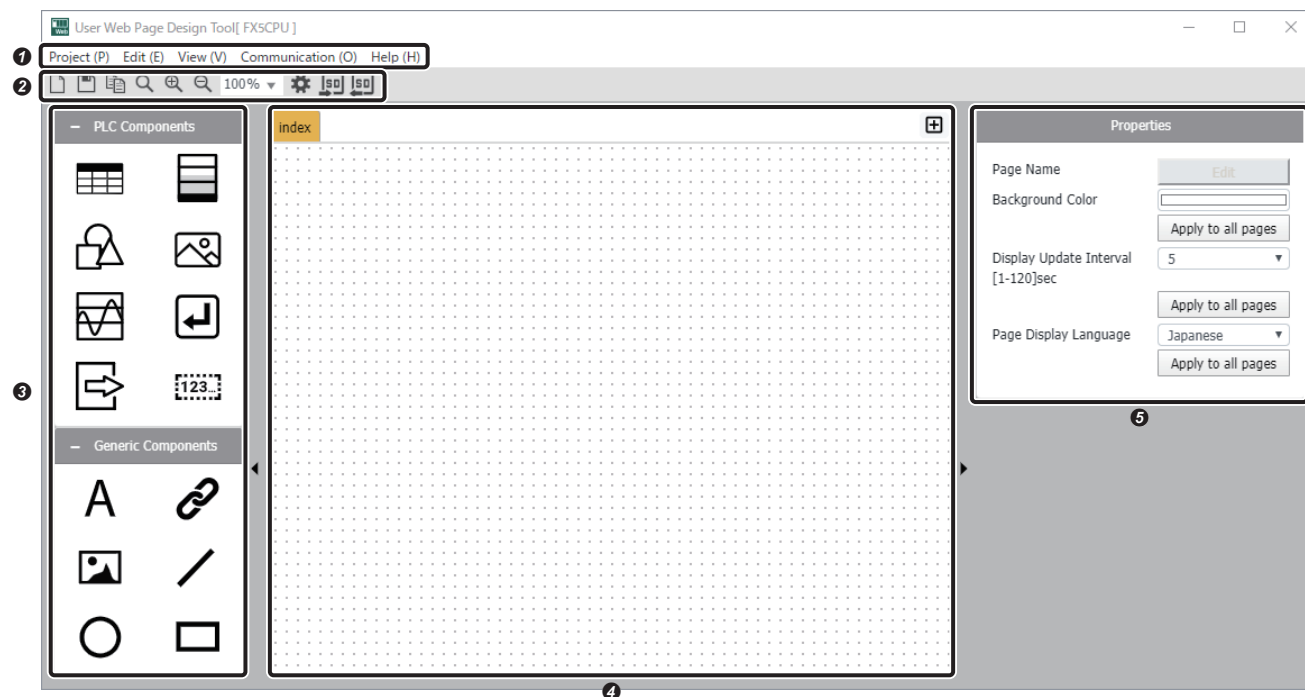

- 1 Menu bar (Page 23 Menu Bar)
- 2 Tool buttons (Page 29 Tool Buttons)
- 3 Component window (Page 30 Component Window)
- 4 Design window (Page 45 Design Window)
- 5 Property window (Page 46 Property Window)

## 2.2 Shortcut





Shortcuts can be used for this tool.

Shortcut	Description	Reference
<b>Ctrl</b> + <b>N</b>	Create Project	Page 23 Create Project
<b>Ctrl</b> + <b>O</b>	Open	Page 23 Open
<b>Ctrl</b> + <b>S</b>	Save	Page 23 Save
<b>Ctrl</b> + <b>Shift</b> + <b>P</b>	Preview	Page 24 Preview
<b>Alt</b> + <b>F4</b>	End Tool	Page 23 Exit
<b>Delete</b>	Delete Component Currently Selected	Page 45 Context menu



## 2.3 Menu Bar

The menu bar can be used to conduct edit and display operations. The items below are shown on the menu bar.

- Project (  Page 23 Project)
- Edit (  Page 24 Edit)
- View (  Page 24 View)
- Communication (  Page 25 Communication)
- Help (  Page 28 Help)

### Project

#### ■Create Project

[Project] ⇒ [Create Project]

This is used to select a CPU module's series and newly create a project. If a project is opened which is not saved yet, after having performed an operation to save it, this will create a new one.

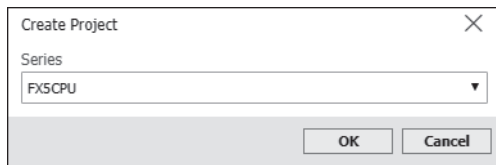

[Range]  
• FX5CPU  
• RCPU

#### ■Open

[Project] ⇒ [Open]

This is used to read a project which is saved in a personal computer's hard disk, etc.

#### ■Save

[Project] ⇒ [Save]

This is used to overwrite and save the project currently opened.

#### ■Save As

[Project] ⇒ [Save As]

This is used to set a project's name and save it in a personal computer's hard disk, etc.

The maximum length of a project's name specifiable can be varied from 1 to 216 bytes, depending on its save location.

Prohibited characters ( \, /, :, \*, ?, ", <, >, | ) cannot be used for a project name.

#### ■Recent Projects

[Project] ⇒ [Recent Projects]

This is used to select one from projects shown on its submenu. The submenu displays projects which are opened recently.

(Up to 5 projects)

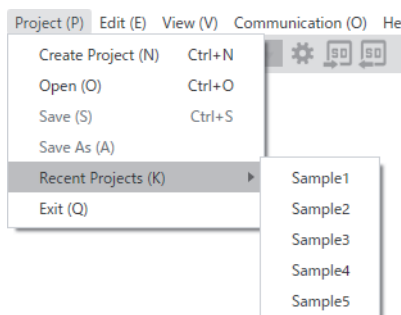

#### ■Exit

[Project] ⇒ [Exit]

This is used to end this tool. If a project is opened which is not saved yet, after having performed an operation to save it, this will end this tool.

## Edit

### ■ Create Page

[Edit] ⇨ [Create Page]

This is used to set an HTML file's name and newly create it in a project in question. It is possible to create an HTML file that contains no more than 160 pages (including its index.html) in a project.

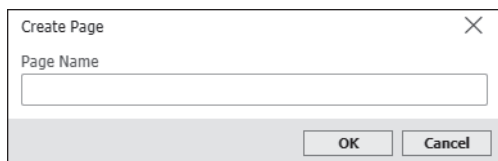

For a file name, only half-width alphanumeric characters, "-", and "\_" can be used, and no more than 26 such characters must be entered. A file name can be changed from its property window. (☞ Page 46 Property Window)

## View

### ■ Preview

[View] ⇨ [Preview]

This is used to show the preview display of the currently displayed design window's contents in a Web browser.

### ■ Show Gridlines

[View] ⇨ [Show Gridlines]

This can be used to display/not display gridlines in the design window. As far as a user doesn't change the display/not display of those gridlines, this situation will not be changed even if this tool is restarted.

### ■ Guide Setting

[View] ⇨ [Guide Setting]

This can be used to select the display/not display of the guide in the design window. This can be used to set the guide's size.

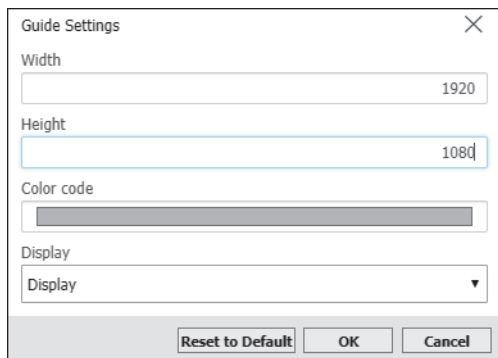

Such guide settings will be reflected in all pages within a project in question.

[Range]

- Width: 1 to 3840
- Height: 1 to 2160
- Color code: This will be selected from the color palette.
- Display: Display/Not Display

These settings can be initialized using "Reset to Default."

### Point

The guide is shown only on the design window. It is not shown on a preview window or a window written to an SD memory card.

## ■Switch Display Language

[View] ⇒ [Switch Display Language]

A display language used in this tool (English, Japanese, and Chinese (simplified characters)) can be changed.

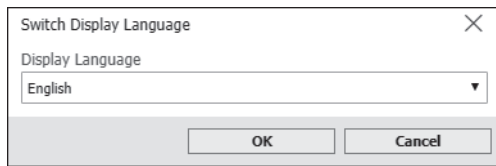

## Communication

- For MELSEC iQ-R series CPU modules, the R01CPU and R02CPU with firmware version "30" or later support this function.
- For MELSEC iQ-R series CPU modules, the R04CPU, R08CPU, R16CPU, R32CPU, R120CPU, R04ENCPU, R08ENCPU, R16ENCPU, R32ENCPU, and R120ENCPU with firmware version "63" or later support this function.
- When the FX5S CPU module is used, an SD memory card module is required.

With the communication function, this tool communicates with CPU modules in which the FTP server settings are configured through FTP communication. For the FTP server settings, refer to the following.

📖 MELSEC iQ-R Ethernet User's Manual (Application)

📖 MELSEC iQ-F FX5 User's Manual (Communication)

## ■Write files to PLC (SD Memory Card)

[Communication] ⇒ [Write files to PLC (SD Memory Card)]

This is used to write a project file, which is opened by this tool, to an SD memory card attached to a CPU module. However, it is necessary to create a folder hierarchy for a user Web page in such an SD memory card beforehand. (📖 Page 60 File configuration)

After all files under a WWW folder in such an SD memory card are deleted, such a project will be written to it.

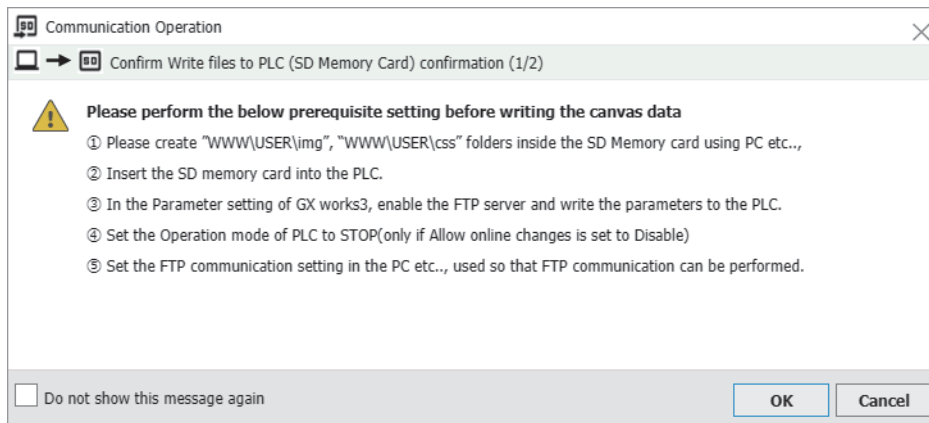

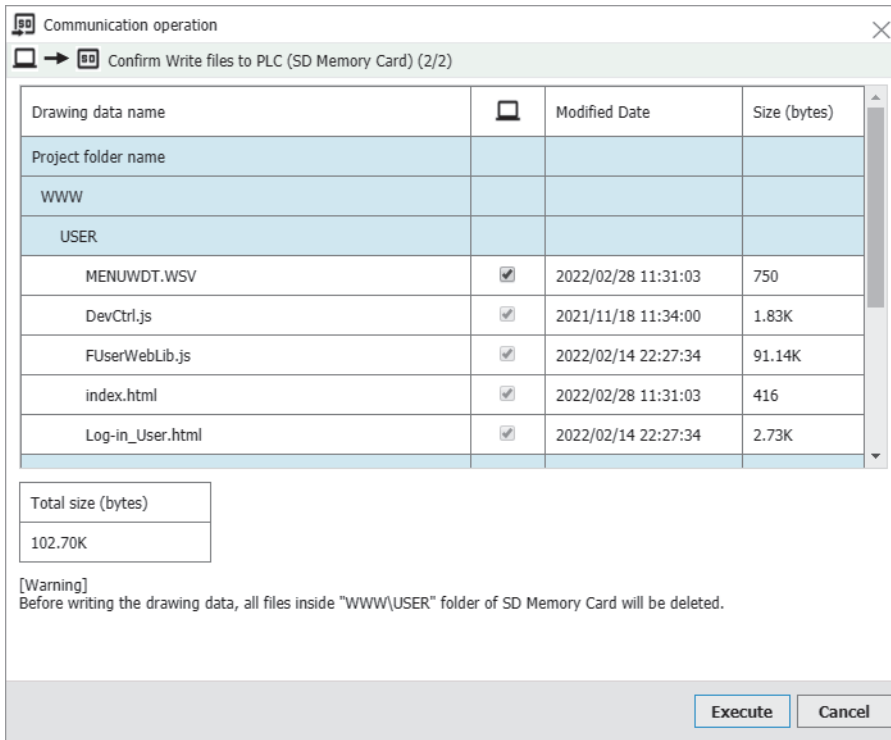

### ■Read files from PLC (SD Memory Card)

[Communication] ⇨ [Read files from PLC (SD Memory Card)]

This is used to read a project from an SD memory card attached to a CPU module.

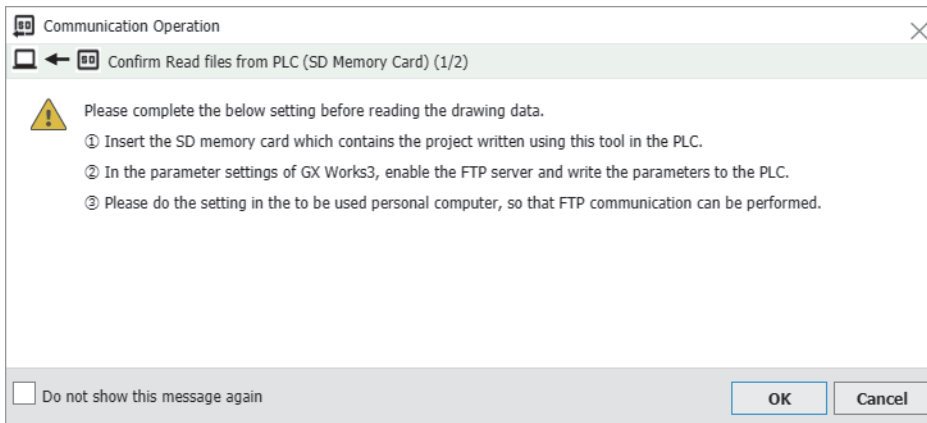

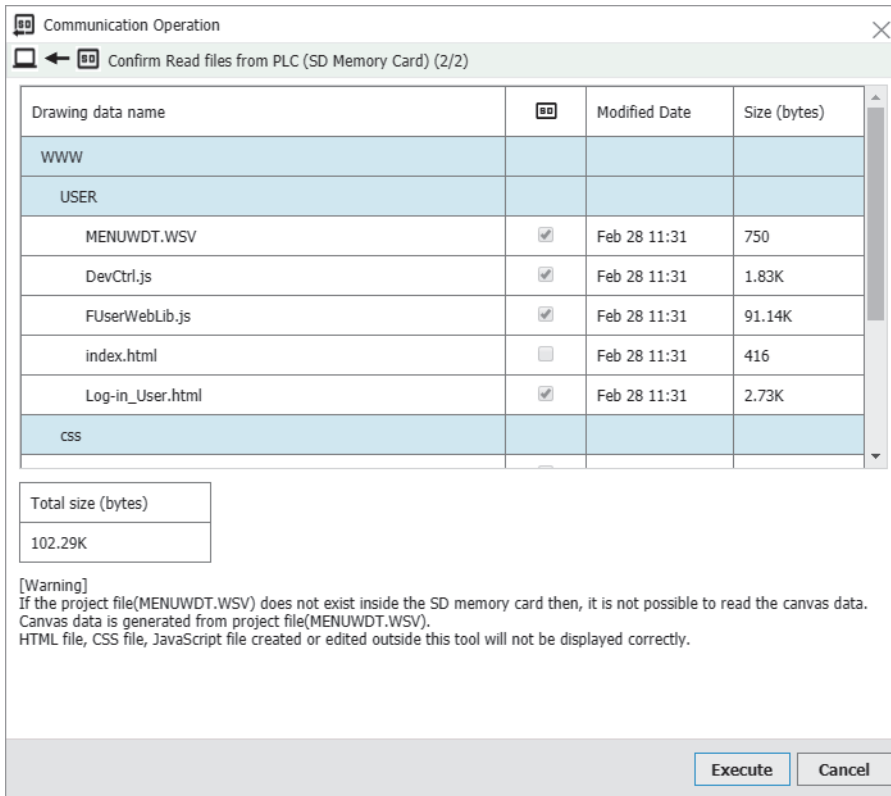

## ■Communication Settings

[Communication] ⇒ [Communication Settings]

This is used to configure FTP communication with a CPU module.

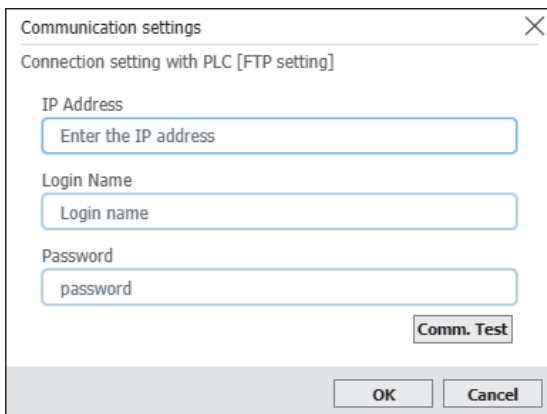

Use the same IP address and FTP server settings of a CPU module with which communication is to be conducted.

### ■Range (RCPU)

- IP Address: 0.0.0.1 to 223.255.255.254
- Login Name: 1 to 12 half-width characters (alphanumeric characters)
- Password: 0 to 32 half-width characters (alphanumeric characters)

### ■Range (FX5CPU)

- IP Address: 0.0.0.1 to 223.255.255.254
- Login Name: 1 to 12 half-width characters (alphanumeric characters)
- Password: 1 to 32 half-width characters (alphanumeric characters)

Conduct a communication test to check if communication with a CPU module in question is possible.

It is necessary to configure a CPU module's Web server settings to view a user Web page in a browser. (MELSEC iQ-R/MELSEC iQ-F Web Server Function Guide Book)

## Help

### ■Show Help

[Help] ⇒ [Show Help]

This is used to view the help file (in PDF format).

### ■Connection to MITSUBISHI ELECTRIC FA Global Website

[Help] ⇒ [Connection to MITSUBISHI ELECTRIC FA Global Website]

This is used to view the MITSUBISHI ELECTRIC FA Global Website in a Web browser. Different websites will be displayed, depending on selected languages.

- For a case where "English" or "Chinese" is selected in "Switch Display Language": MITSUBISHI ELECTRIC FA Global Website
- For a case where "Japanese" is selected in "Switch Display Language": MITSUBISHI ELECTRIC FA Website

### ■Version

[Help] ⇒ [Version]

This is used to view information items on a software version, etc.











### ■License

[Help] ⇒ [License]

This is used to view information items on the licenses of software items used by this tool. (☞ Page 7 Software License)

## 2.4 Tool Buttons

The tool buttons are equivalent to some of the menu commands. The following table lists the tool buttons.

Icon	Description	Reference
	[Create Project] This is used to select a CPU module's series and newly create a project.	Page 23 Create Project
	[Save Project] This is used to overwrite and save the project currently opened.	Page 23 Save
	[Copy Page] This is used to set a page name and copy the design window currently displayed.	—
	[Preview] This is used to preview the design window currently displayed, on a web browser.	Page 24 Preview
	[Zoom-In] This is used to zoom in on the display. Each click of this button increases the zoom level by 10%. (200% maximum)	—
	[Zoom-Out] This is used to zoom out on the display. Each click of this button decreases the zoom level by 10%. (10% minimum)	—
	[Zoom] This is used to change the zoom level. To change the zoom level, select a percentage from the drop-down list or enter a desired percentage into this field. (Range: 10% to 200%)	—
	[Communication Settings] This is used to configure FTP communication with a CPU module.	Page 27 Communication Settings
	[Write files to PLC (SD Memory Card)] This is used to write a project to an SD memory card attached to a CPU module.	Page 25 Write files to PLC (SD Memory Card)
	[Read files from PLC (SD Memory Card)] This is used to read a project from an SD memory card attached to a CPU module.	Page 26 Read files from PLC (SD Memory Card)

## 2.5 Component Window

This is used to view components used to configure a user Web page. Drag an individual component to the design window so that it can be allocated. (☞ Page 45 Design Window) To configure an individual item's settings, use its property window. (☞ Page 46 Property Window)









Refer to the following documents for more information about individual components.

📖 MELSEC iQ-R Ethernet User's Manual (Application)

📖 MELSEC iQ-F FX5 User's Manual (Communication)

### PLC components

The followings can be used as PLC components.

Icon	Description	Reference
	[UserWebPage component - Data Block] This is used to display specified device data items in a tabular format. Multiple devices and their directions can also be specified.	Page 31 Data Block
	[UserWebPage component - Level Display] This is used to view the current value of a specified device as a level relative to its upper and lower limits. Different colors can be allocated to a level display component, depending on whether its current value is larger than its upper limit or smaller than its lower limit, and its direction can also be specified.	Page 32 Level Display
	[UserWebPage component - Graphic Display] This is used to display a figure in a specified color when the current value of a specified device is within a set range.	Page 33 Graphic Display
	[UserWebPage component - Image Display] This is used to display a specified image file when the current value of a specified device is within a set range.	Page 34 Image Display
	[UserWebPage component - Historic Graph] This is used to display the time series of a device's values in a line graph. A device's value is read at update intervals, and when the number of allowed records is reached, the oldest record will be deleted and the line graph will shift to the left.	Page 35 Historic Graph
	[UserWebPage component - Input Button] This is used to display a preset button that writes a value to a specified device.	Page 36 Input Button
	[UserWebPage component - Logout Button] This is used to display a button for logging out. If a logout button is clicked, a user login page (Log-in_User.html) will appear.	Page 36 Logout Button
	[PLC component - Arbitrary value write Button] This is used to display a set of an input field and a write button to write an arbitrary value.	Page 37 Arbitrary value write Button

The current value of a device will be updated at regular intervals. (☞ Page 46 Display update interval)

Up to 128 PLC components can be allocated to an HTML file page. However, for logout button components, only one can be used in an HTML file.

If the input button and arbitrary value write button components are used, set "Write Device" in "Web Server Account Settings" to "Enable". (📖 MELSEC iQ-R/MELSEC iQ-F Web Server Function Guide Book) For an account that does not write operations, such a setting is not necessary.



## Data Block

Below are setting items which will be displayed in its property window.

Property window	Properties	Settings	
	Direction	Vertical, Horizontal	
	Block Size	1 to 32	
	Device Property	Page 31 Device Property	
	Line Color	This will be selected from the color palette.	
	Device Name	Display	Display, Not Display
		Font Color	This will be selected from the color palette.
		Background Color	
		Cell Width <sup>*1</sup>	
	Cell Height <sup>*2</sup>	10 to 1080	
	Device Value	Font Color	This will be selected from the color palette.
		Background Color	
		Cell Width	10 to 1920
		Cell Height	10 to 1080
	X Coordinate	0 to 3840	
Y Coordinate	0 to 2160		

\*1 It can be edited when "Vertical" is selected as a direction.

\*2 It can be edited when "Horizontal" is selected as a direction.

### Device Property

A device to be displayed in a data block can be registered. Up to 32 devices can be registered per data block.

Properties	Settings
Display Label	No more than 100 characters
Device	Page 42 Device settings
Data Type	
Display Format	
+	This is used to add a line to a displayed device.
-	This is used to delete a line from a displayed device. (The second line or thereafter)

## Level Display

Below are setting items which will be displayed in its property window.

Property window	Properties	Settings	
<div style="border: 1px solid #ccc; padding: 5px;"> <p>Direction <input type="text" value="Vertical"/></p> <p>Device <input type="text" value="D"/></p> <p>Device Number <input type="text" value="0"/></p> <p>Data Type <input type="text" value="Word [Signed]"/></p> <p>Level Color <input type="color" value="#0000FF"/></p> <p>Upper Color <input type="color" value="#FF0000"/></p> <p>Lower Color <input type="color" value="#008000"/></p> <p>Background Color <input type="color" value=""/></p> <p>Upper Value <input type="text" value="32767"/></p> <p>Lower Value <input type="text" value="-32768"/></p> <p><b>— Alarm Value</b></p> <p>Display Line <input checked="" type="radio"/> Display <input type="radio"/> Not Display</p> <p>Line Color <input type="color" value="#008000"/></p> <p>Upper Value <input type="text" value="20000"/></p> <p>Lower Value <input type="text" value="-20000"/></p> <p><b>— Current Value</b></p> <p>Display <input checked="" type="radio"/> Display <input type="radio"/> Not Display</p> <p>Color <input type="color" value=""/></p> <p>Background Color <input type="color" value=""/></p> <p>Width <input type="text" value="150"/></p> <p>Height <input type="text" value="50"/></p> <p>Level Length <input type="text" value="400"/></p> <p>Level Width <input type="text" value="150"/></p> <p>X Coordinate <input type="text" value="214"/></p> <p>Y Coordinate <input type="text" value="33"/></p> <p style="text-align: center;"><input type="button" value="Apply"/></p> <p>In order to save the changes, please click on the [Apply] button.</p> </div>	Direction	Vertical, Horizontal	
	Device	Page 42 Device settings	
	Device Number		
	Data Type		
	Level Color	This will be selected from the color palette.	
	Upper Color		
	Lower Color		
	Background Color		
	Upper Value	Page 43 Settings (Decimal)	
	Lower Value		
	Alarm Value	Display Line	Display, Not Display
		Line Color	This will be selected from the color palette.
		Upper Value	Page 43 Settings (Decimal)
		Lower Value	
	Current Value	Display	Display, Not Display
		Color	This will be selected from the color palette.
		Background Color	
		Width	10 to 3840
		Height	10 to 2160
	Level Length		10 to 3840
Level Width		10 to 2160	
X Coordinate		0 to 3840	
Y Coordinate		0 to 2160	

## Graphic Display

Below are setting items which will be displayed in its property window.

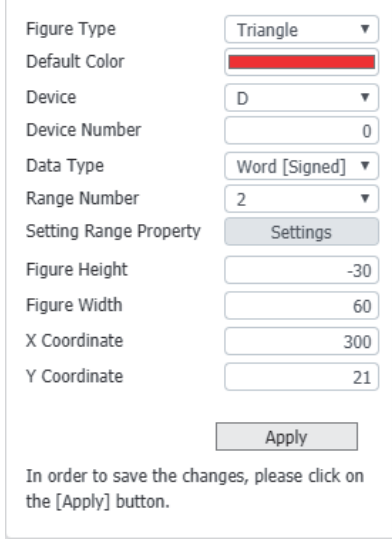
Property window	Properties	Settings
	Figure Type	Triangle, Rectangle, and Ellipse
	Default Color	This will be selected from the color palette.
	Device	Page 42 Device settings
	Device Number	
	Data Type	
	Range Number	1 to 5
	Figure Height <sup>*1</sup>	-2160 to -1, 1 to 2160
	Figure Width	10 to 3840
	X Coordinate	0 to 3840
	Y Coordinate	0 to 2160

\*1 If the "Figure Type" property is "Triangle", setting a negative number will result in a downward triangle.

### Setting Range Property

A figure's upper and lower limits can be set to change its color. Depending on the number of ranges set, the number of settings will vary.

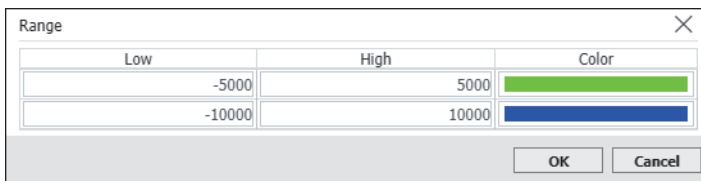

Properties	Settings
Low	Page 43 Settings (Decimal)
High	
Color	This will be selected from the color palette.

## Image Display

Below are setting items which will be displayed in its property window.

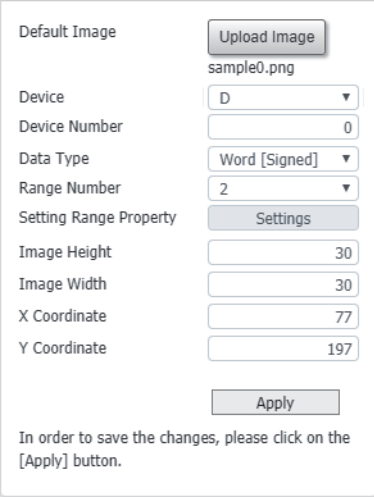
Property window	Properties	Settings
	Default Image* <sup>1</sup>	Page 44 Image file
	Device	Page 42 Device settings
	Device Number	
	Data Type	
	Range Number	1 to 5
	Image Height	10 to 3840
	Image Width	10 to 2160
	X Coordinate	0 to 3840
	Y Coordinate	0 to 2160

\*1 This is an image when the value of a device in question is out of a setting range in "Setting Range Property."

### ■Setting Range Property

Upper and lower limits can be set to change a displayed image. Depending on the number of ranges set, the number of settings will vary.

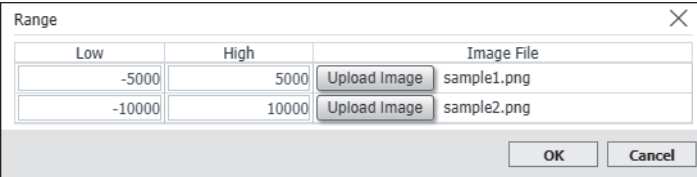

Low	High	Image File
-5000	5000	sample1.png
-10000	10000	sample2.png

Properties	Settings
Low	Page 43 Settings (Decimal)
High	
Image File	Page 44 Image file

## Historic Graph

Below are setting items which will be displayed in its property window.

Property window	Properties	Settings
	Graph Element Number	1 to 32
	Data Type	Page 42 Device settings
	Upper Limit Value	Page 43 Settings (Decimal)
	Lower Limit Value	
	Number Of Records	5 to 100
	Vertical Axis Interval	0 to 99
	Number Of Horizontal Axes	0 to 99
	Graph Background Color	This will be selected from the color palette.
	Character Color	This will be selected from the color palette.
	Right Margin	1 to 3840
	Left Margin	1 to 3840
	Upper Margin	1 to 2160
	Lower Margin	1 to 2160
	Graph Height	10 to 2160
	Graph Width	10 to 3840
	X Coordinate	0 to 3840
	Y Coordinate	0 to 2160

### ■Graph Element Property

This is used to set a device whose graph will be displayed. Depending on the number of graph elements, the number of settings will vary.

Properties	Settings
Device Name	Page 42 Device settings
Device Number	
Line Color	This will be selected from the color palette.

## Input Button

Below are setting items which will be displayed in its property window.

Property window	Properties	Settings
<div style="border: 1px solid #ccc; padding: 10px;"> <p>Device <input type="text" value="X"/></p> <p>Device Number <input type="text" value="0"/></p> <p>Data Type <input type="text" value="Bit"/></p> <p>Display Format <input type="text" value="Binary"/></p> <p>Write Value <input type="text" value="1"/></p> <p>Button Text <input type="text" value="OK"/></p> <p>Write Confirm <input type="text" value="Display"/></p> <p>Button Width <input type="text" value="150"/></p> <p>Button Height <input type="text" value="50"/></p> <p>X Coordinate <input type="text" value="143"/></p> <p>Y Coordinate <input type="text" value="233"/></p> <p style="text-align: center;"><input type="button" value="Apply"/></p> <p>In order to save the changes, please click on the [Apply] button.</p> </div>	Device	☞ Page 42 Device settings
	Device Number	
	Data Type	
	Display Format	
	Write Value	☞ Page 43 Settings
	Button Text	No more than 100 characters
	Write Confirm	Display, Not Display
	Button Width	10 to 3840
	Button Height	10 to 2160
	X Coordinate	0 to 3840
	Y Coordinate	0 to 2160

## Logout Button

Below are setting items which will be displayed in its property window.

Property window	Properties	Settings
<div style="border: 1px solid #ccc; padding: 10px;"> <p>Button Text <input type="text" value="Logout"/></p> <p>Button Width <input type="text" value="100"/></p> <p>Button Height <input type="text" value="26"/></p> <p>X Coordinate <input type="text" value="1020"/></p> <p>Y Coordinate <input type="text" value="130"/></p> <p style="text-align: center;"><input type="button" value="Apply"/></p> <p>In order to save the changes, please click on the [Apply] button.</p> </div>	Button Text	No more than 100 characters
	Button Width	10 to 3840
	Button Height	10 to 2160
	X Coordinate	0 to 3840
	Y Coordinate	0 to 2160







## Arbitrary value write Button

Below are setting items which will be displayed in its property window.

Property window	Properties	Settings
<div style="border: 1px solid #ccc; padding: 5px;"> <p>Position <input type="text" value="Right"/></p> <p>Button Text <input type="text" value="SET"/></p> <p>Input Value <input type="text" value="0"/></p> <p>Device <input type="text" value="D"/></p> <p>Device Number <input type="text" value="0"/></p> <p>Data Type <input type="text" value="Word [Signed]"/></p> <p>Write Format <input type="text" value="Decimal"/></p> <p>Write Confirm <input type="text" value="Display"/></p> <p>Font Size <input type="text" value="20"/></p> <p>Width <input type="text" value="220"/></p> <p>Height <input type="text" value="30"/></p> <p>X Coordinate <input type="text" value="280"/></p> <p>Y Coordinate <input type="text" value="230"/></p> <p style="text-align: center;"><input type="button" value="Apply"/></p> <p>In order to save the changes, please click on the [Apply] button.</p> </div>	Position	Left, Right, Top, and Bottom
	Button Text	No more than 100 characters
	Input Value	Page 43 Settings
	Device	Page 42 Device settings
	Device Number	
	Data Type	
	Write Format	
	Write Confirm	Display, Not Display
	Font Size	1 to 1500
	Width	10 to 3840
	Height	10 to 2160
	X Coordinate	0 to 3840
	Y Coordinate	0 to 2160

# Generic components

For generic components, the followings can be used.

Icon	Description	Reference
	[Label] This is used to display a label.	Page 38 Label
	[Hyper Link] This is used to display a label to which a hyper link is set. Click the label to jump to the hyper link destination. A hyper link to an HTML page in a project and one to an external URL can be set.	Page 39 Hyper Link
	[Image Tag] This is used to display an image file.	Page 40 Image Tag
	[Line] This is used to display a line in a specified area.	Page 40 Line
	[Ellipse] This is used to display an ellipse.	Page 41 Ellipse
	[Rectangle] This is used to display a rectangle.	Page 41 Rectangle

Up to 256 generic components can be allocated to an HTML file page.

## Label

Below are setting items which will be displayed in its property window.

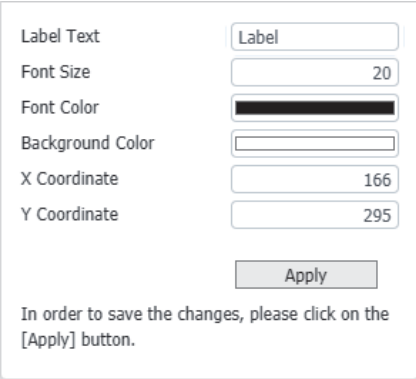
Property window	Properties	Settings
	Label Text	No more than 1000 characters
	Font Size	1 to 1500
	Font Color	This will be selected from the color palette.
	Background Color	This will be selected from the color palette.
	X Coordinate	0 to 3840
	Y Coordinate	0 to 2160



## Hyper Link

Below are setting items which will be displayed in its property window.



Property window	Properties	Settings
<div style="border: 1px solid #ccc; padding: 5px;"> <p>Type <input type="text" value="Page"/></p> <p>URL <input type="text" value="https://"/></p> <p>Page <input type="text" value="Select..."/></p> <p>Target <input type="text" value="Same Window"/></p> <p>Text <input type="text" value="Hyper Link"/></p> <p>Font Size <input type="text" value="20"/></p> <p>X Coordinate <input type="text" value="408"/></p> <p>Y Coordinate <input type="text" value="350"/></p> <p style="text-align: center;"><input type="button" value="Apply"/></p> <p>In order to save the changes, please click on the [Apply] button.</p> </div>	Type	Page, URL
	URL	No more than 1000 characters <sup>*1</sup>
	Page	Select a page that is already created and other than the own page. <sup>*2</sup>
	Target	Other window, Same window
	Text	1000 characters
	Font Size	1 to 1500
	X Coordinate	0 to 3840
	Y Coordinate	0 to 2160

\*1 When "URL" is selected for the type property, it can be edited.

\*2 When "Page" is selected for the type property, it can be edited.

## Image Tag

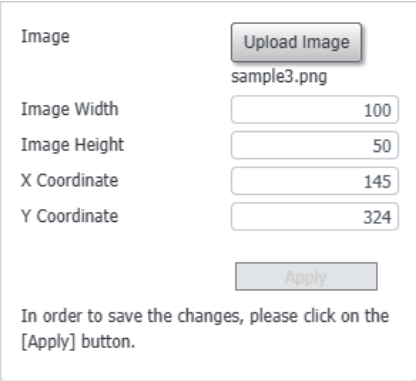
Below are setting items which will be displayed in its property window.

Property window	Properties	Settings
	Image	 Page 44 Image file
	Image Width	10 to 3840
	Image Height	10 to 2160
	X Coordinate	0 to 3840
	Y Coordinate	0 to 2160

## Line

Below are setting items which will be displayed in its property window.

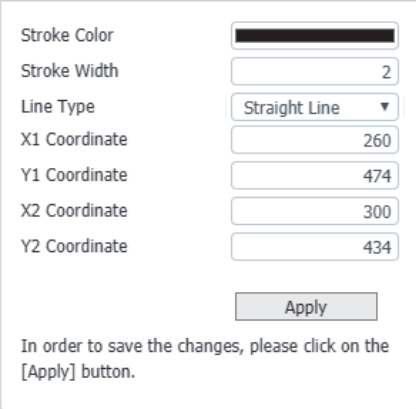
Property window	Properties	Settings
	Stroke Color	This will be selected from the color palette.
	Stroke Width	1 to 100
	Line Type	Straight line, dotted line 1 to 6
	X1 Coordinate <sup>*1*2</sup>	0 to 3840
	Y1 Coordinate <sup>*1*2</sup>	0 to 2160
	X2 Coordinate <sup>*2*3</sup>	0 to 3840
	Y2 Coordinate <sup>*2*3</sup>	0 to 2160

\*1 Coordinate of line start point

\*2 The same coordinate cannot be set to (X1, Y1) and (X2, Y2).

\*3 Coordinate of line end point

## Ellipse

Below are setting items which will be displayed in its property window.

Property window	Properties	Settings
	Stroke Color	This will be selected from the color palette.
	Stroke Width	1 to 1080 <sup>*1</sup>
	Fill Color	This will be selected from the color palette.
	Ellipse Width	10 to 3840
	Ellipse Height	10 to 2160
	X Coordinate	0 to 3840
	Y Coordinate	0 to 2160

\*1 Set the upper limit value to a value equal to or lower than half the smaller value of the width or height. If the value of the width or height exceeds the upper limit value when the part is resized, the input value is automatically calculated so that it does not exceed the upper limit value.

## Rectangle

Below are setting items which will be displayed in its property window.

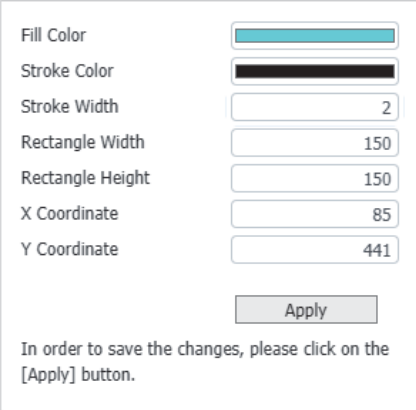
Property window	Properties	Settings
	Fill Color	This will be selected from the color palette.
	Stroke Color	
	Stroke Width	1 to 1080 <sup>*1</sup>
	Rectangle Width	10 to 3840
	Rectangle Height	10 to 2160
	X Coordinate	0 to 3840
	Y Coordinate	0 to 2160

\*1 Set the upper limit value to a value equal to or lower than half the smaller value of the width or height. If the value of the width or height exceeds the upper limit value when a component is resized, the input value is automatically calculated so that it does not exceed the upper limit value.

# Common items

This section shows items common to individual components.

## Device settings

Consistency among a device, a data type, and a display format is required for device settings. Use the following combinations to perform device settings.

### ■RCPU

○: can be set, ×: cannot be set

Device *1		Data type *2				
		Word [signed/unsigned]	Double word [signed/unsigned]	Floating point real number	Double point real number	Bit
X	Input	×	×	×	×	○
Y	Output	×	×	×	×	○
M	Internal relay	×	×	×	×	○
L	Latch relay	×	×	×	×	○
B	Link relay	×	×	×	×	○
F	Annunciator	×	×	×	×	○
SB	Link special relay	×	×	×	×	○
V	Edge relay	×	×	×	×	○
T	Timer	○: K, H [unsigned]	×	×	×	×
ST	Retentive timer	○: K, H [unsigned]	×	×	×	×
LT	Long timer	×	○: K, H [unsigned]	×	×	×
LST	Long retentive timer	×	○: K, H [unsigned]	×	×	×
C	Counter	○: K, H [unsigned]	×	×	×	×
LC	Long counter	×	○: K, H [unsigned]	×	×	×
D	Data register	○: K, H	○: K, H	○: K	○: K	×
W	Link register	○: K, H	○: K, H	○: K	○: K	×
SW	Link special register	○: K, H	○: K, H	○: K	○: K	×
DX	Direct access input	×	×	×	×	○
DY	Direct access output	×	×	×	×	○
SM	Special relay	×	×	×	×	○
SD	Special register	○: K, H	○: K, H	○: K	○: K	×
J□\X	Link input	×	×	×	×	○
J□\Y	Link output	×	×	×	×	○
J□\B	Link relay	×	×	×	×	○
J□\SB	Link special relay	×	×	×	×	○
J□\W	Link register	○: K, H	○: K, H	○: H	○: H	×
J□\SW	Link special register	○: K, H	○: K, H	○: H	○: H	×
U□\G	Module access device	○: K, H	○: K, H	○: K	○: K	×
U3E□\G	CPU buffer memory	○: K, H	○: K, H	○: K	○: K	×
U3E□\HG		○: K, H	○: K, H	○: K	○: K	×
Z	Index register	○: K, H	○: K, H	○: K	○: K	×
LZ	Long index register	×	○: K, H	○: K	×	×
R	File register	○: K, H	○: K, H	○: K	○: K	×
ZR	File register	○: K, H	○: K, H	○: K	○: K	×
RD	Refresh data register	○: K, H	○: K, H	○: K	○: K	×
BL	SFC block device	×	×	×	×	○
BL□\S		×	×	×	×	○

\*1 For a device number, refer to the user's manual of a CPU module used.

\*2 K: Decimal, H: Hexadecimal

## ■FX5CPU

○: can be set, ×: cannot be set

Device*1		Data type*2			
		Word [signed/unsigned]	Double word [signed/unsigned]	Floating point real number	Bit
X	Input	×	×	×	○*3
Y	Output	×	×	×	○*3
M	Internal relay	×	×	×	○
L	Latch relay	×	×	×	○
B	Link relay	×	×	×	○
F	Annunciator	×	×	×	○
SB	Link special relay	×	×	×	○
S	Step relay	×	×	×	○
T	Timer	Contact: TS/Coil: TC	×	×	×
		Current value: TN	○: K, H	×	×
ST	Retentive timer	Contact: STS/Coil: STC	×	×	×
		Current value: STN	○: K, H	×	×
C	Counter	Contact: CS/Coil: CC	×	×	×
		Current value: CN	○: K, H	×	×
LC	Long counter	Contact: LCS/Coil: LCC	×	×	×
		Current value: LCN	×	○: K, H	×
D	Data register	○: K, H	○: K, H	○: K	×
W	Link register	○: K, H	○: K, H	○: K	×
SW	Link special register	○: K, H	○: K, H	○: K	×
SM	Special relay	×	×	×	○
SD	Special register	○: K, H	○: K, H	○: K	×
U□/G	Module access device	○: K, H	○: K, H	○: K	×
Z	Index register	○: K, H	○: K, H	○: K	×
LZ	Long index register	×	○: K, H	○: K	×
R	File register	○: K, H	○: K, H	○: K	×
BL	SFC block device	×	×	×	○
BL□/S		×	×	×	○

\*1 For a device number, refer to the user's manual of a CPU module used.

\*2 K: Decimal, H: Hexadecimal

\*3 If X and Y are to be specified, specify them in octal numbers.

## Settings

If individual components' upper/lower limits, etc. are to be set, their ranges will vary depending on their data types.

Data type	Range
Word [signed]	-32768 to +32767
Word [unsigned]	0 to 65535
Double word [signed]	-2147483648 to +2147483647
Double word [unsigned]	0 to 4294967295
Floating point real number	-3.402823e+38 to +3.402823e+38
Double point real number (only RCP)	-1.797693e+308 to +1.797693e+308
Bit	0, 1

## Coordinate

To define the design window's coordinate, its upper left corner is set as the origin, (0, 0), the X-axis is set along the horizontal direction from the origin, and the Y-axis is set along the vertical direction from the origin. Individual components' coordinates represent their upper left positions.

## Image file

For an image file which this tool can use, its file name consists of no more than 27 half-width characters of alphanumeric characters, "-", "\_", and "." including its extension (.jpg, .gif, .jpeg, and .png). Aim for 100 KB or less as the total size of image files in one screen. (This also includes a case where an image display component uses multiple image files)

If an image file is specified, its copy will be stored in the img folder. (☞ Page 60 File configuration) If a file in the img folder is specified, its copy will not be created.

If an image is not specified, a default image will appear.

## Ordered arrangement of components

The ordered arrangement of components is their allocated order in the design window. Only generic and arbitrary value write button components can optionally change their ordered arrangements to the forefront/backmost. (☞ Page 45 Context menu)

## Window folding

A component window can be folded to make more space for the design window.

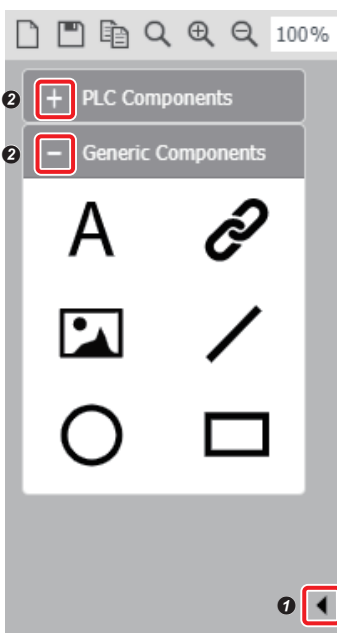

Click the symbol on the right side of ❶ to fold a component window in question. If a component window is folded, click such a symbol to unfold it. Click the symbol on the right side of ❷ to fold a corresponding PLC/generic component's list.

# 2.6 Design Window

The design window can create/edit an HTML file which will allocate components and show them in a Web browser. This section describes how to operate the design window. The highest resolution of the design window (an HTML section) is 4K (3840 × 2160 pixels).

## Select HTML file



This is used to display in the design window, an HTML file whose file name is selected.

## Delete HTML file



This is used to delete an HTML file that is created in a project. However, index.html cannot be deleted.

## Create new HTML file



This is used to set an HTML file's name and newly create it in a project in question. (Page 24 Create Page)

## Context menu

If a component allocated in the design screen is selected and right-clicked, a context menu will appear. The following operations can be performed from the context menu.

Context menu	Description
Cut	This is used to cut a selected component.
Copy	This is used to copy a selected component.
Paste	This is used to paste a cut or copied component. "Paste" can be executed only within a project of the same series. (Example: A component copied in a project of the FX5 CPU series cannot be pasted in a project of the RCPU series.)
Delete	This is used to delete a selected component.
Bring to Front <sup>*1</sup>	This is used to bring a generic/arbitrary value write button component to the front. (The component will be brought to the front among all components which are allocated to and displayed in the design window)
Send to Back <sup>*1</sup>	This is used to send a generic/arbitrary value write button component to the back. (The component will be sent to the back among all components which are allocated to and displayed in the design window)

\*1 This applies to a PLC component only if it is an arbitrary value write button component.

### ■Select multiple components

Multiple components can be selected in the design window. When multiple components are selected, only "Cut", "Copy", "Paste", and "Delete" context menu options are valid.

## 2.7 Property Window

If a component is allocated to the design window, its property and HTML file page settings can be conducted. If a component is selected in the design window, its component properties will be displayed, and if a component is not selected, its page properties will be displayed.

### Component properties

If a component is selected in the design window, its component properties will be displayed. This section describes how to operate the design window. For individual components' properties which can be set, refer to  Page 30 Component Window.

#### Delete component



This is used to delete a selected component. This is an operation common to all components.

#### "Apply" button

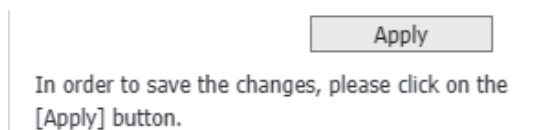

This can be clicked when a setting value is changed in the component property. When the component property is switched, the input values are retained only with the [Apply] button clicked.

This is an operation common to all components.

### Page properties

If an HTML file is displayed in the design screen, its page properties will be displayed. Those page properties which can be set are shown below.

#### Page name

To change a page name, click the [Edit] button. ( Page 24 Create Page)

Note, however, that the page names of index.html and Log-in\_User.html cannot be changed.

#### Background color

The background color of an HTML file can be set from the color palette.

If such a background color is set as "Reflect in all pages," it will be reflected in all HTML files in a project in question.

#### Display update interval

This is used to set the display update interval of a PLC component allocated to an HTML file which is displayed in the design window. The setting range is as follows.

Project	User Web page component of library for Web server function	User Web Page Design Tool	Setting range
RCPU	Earlier than version "1.03"	Version "1.00A"	5 to 120 (second)
	Version "1.03" or later	Version "1.01B" or later	1 to 120 (second)
FX5CPU	Earlier than version "1.003"	Version "1.00A"	5 to 120 (second)
	Version "1.003" or later	Version "1.01B" or later	1 to 120 (second)

If such a display update interval is set as "Reflect in all pages," the display update interval will be reflected in all HTML files in a project in question.



## Page display language

This is used to set the display language of input button and arbitrary value write button components allocated to an HTML file which is displayed in the design window (English, Japanese, and Chinese (simplified characters)). The default display language is one set in index.html.

If such a display language is set as "Reflect in all pages," the display language will be reflected in all HTML files in a project in question.

## Common items

This section shows setting items common to all property windows.

## Window folding



This is used to fold a property window to make more space for the design window. If a property window is folded, this is used to unfold the window.

# 3 TUTORIAL

This section describes the procedures, operations, and practical examples before using the user Web page.

## 3.1 Before Tutorial

To use this tutorial, it is necessary to obtain this tool and become familiar with its operations. Check a system configuration to read/write a project through FTP communication with an SD memory card attached to a CPU module.

### How to obtain and start the tool

This section describes how to obtain and start this tool and associated functions.

#### ■How to Obtain

Please consult your local Mitsubishi representative.

#### ■Installing and Uninstalling

• To install, execute setup.exe and install the tool according to the message of the installer. To use this tool, turn off SmartScreen in the Microsoft® Edge settings as follows.

1. Select [Settings and more] ⇒ [Settings] ⇒ [Privacy, search, and services].
2. Turn off "Microsoft Defender SmartScreen" in "Security".

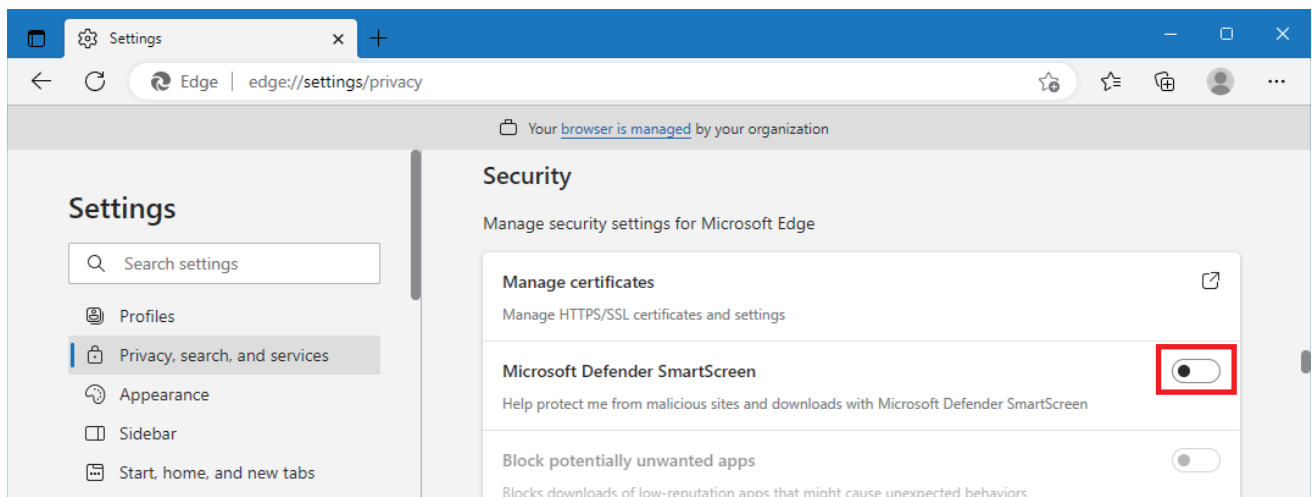

• To uninstall, execute uninstall.exe and uninstall the tool according to the message.

#### ■Start and End

To start it: [Start Menu] ⇒ [UserWebPageDesignTool] ⇒ [UserWebPageDesignTool]

To end it: [Project] ⇒ [Exit] (⌨ Page 23 Exit)

## FTP communication

If this tool (installed on a personal computer) is connected to a CPU module through Ethernet, a project can be read/written through FTP communication.

For more information about how to operate FTP communication, refer to [Page 25 Communication](#).

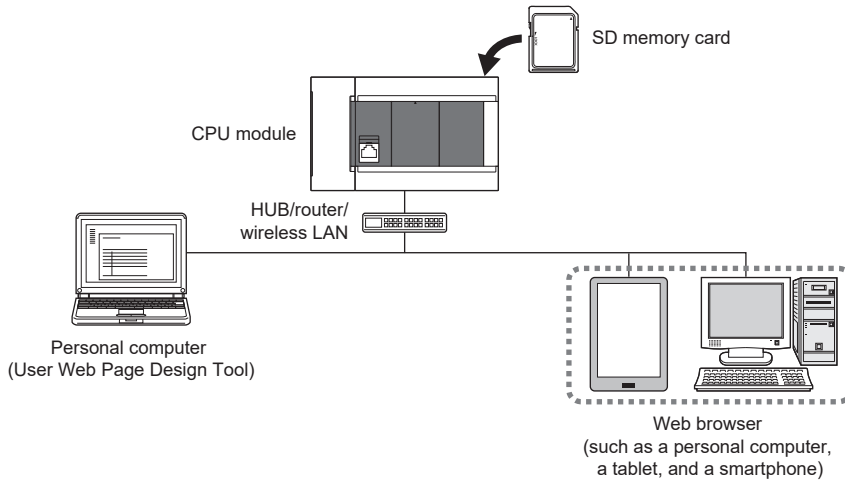

Use a straight cable with either of the following specifications. If a personal computer is to be directly connected to a CPU module with an Ethernet cable, a cross cable whose specification is category 5e or less can be used.

[When 100BASE-TX connection is available]

Cable products compliant with the Ethernet standard whose specification is category 5 or better (STP cables)

[When 10BASE-T connection is available]

Cable products compliant with the Ethernet standard whose specification is category 3 or better (STP cables)

## 3.2 Practical Examples

The practical examples of user Web pages are shown below.

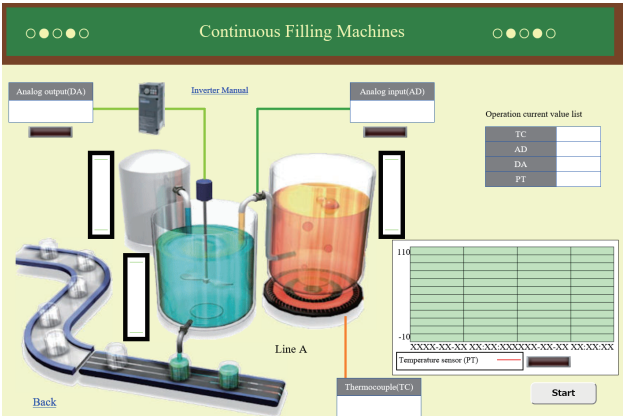
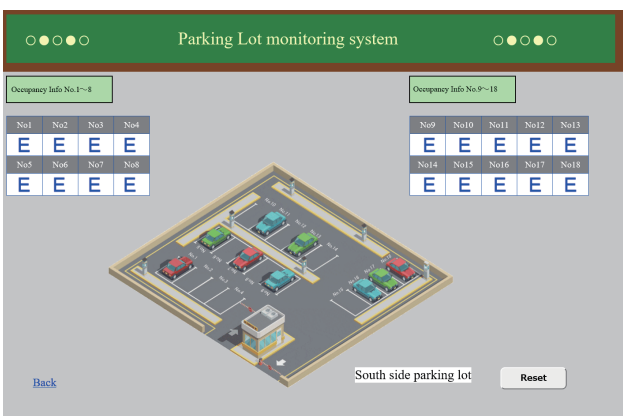
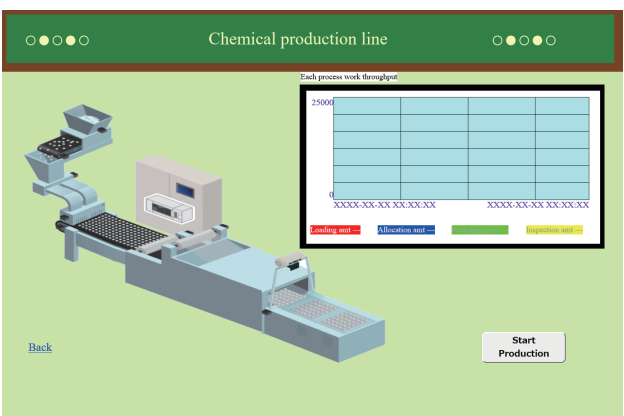
Top page (index.html)	Continuous Filling Machines
	
Parking Lot monitoring system	Chemical production line
	

This section describes procedures to create a project with continuous filling machines as an example.

The "Continuous filling machines" example is about a user Web page to monitor the states and measurements of individual devices.

### Creating a user Web page

This section describes procedures to create the HTML files of the continuous filling machines.

#### Creating a project

For a project, refer to [Page 60 Project Management](#).

##### 1. Newly Creating Project

After having installed this tool, start this tool, and perform the following operation to create a new project.

[Project] ⇒ [Create Project] ([Page 23 Create Project](#))

##### 2. Creating HTML File

Perform the following operation to create an HTML file. For this example, its page name is "001."

[Edit] ⇒ [Create Page] ([Page 24 Create Page](#))

## Editing HTML file

By allocating individual components, the continuous filling machines' user Web page will be created. The continuous filling machines consist of the following items.

[Tank] This monitors water storage (R3) in the equipment's tank

[Liquid tank 1] This monitors the water level (R1) and analog output (D102) of the equipment's liquid tank.

[Liquid tank 2] This monitors the water level (R2), analog input (D101), and temperature (D100) of the equipment's liquid tank.

[Batch display section] This monitors the analog input/output (D101 and D102) and the temperatures (D100 and R100).

### ■ Tank

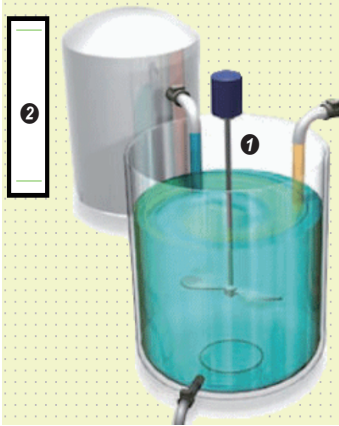
Design window	Used components
	<p>Allocate the following components from the component window.</p> <ul style="list-style-type: none"> <li>❶ Image tag components In this example, the image files of "Tank" and "Liquid tank 1" are the same.</li> <li>❷ Level display and rectangle components This shows the water storage (R3) using a level indication.</li> </ul>

❷ The following items are set for the level display component. (Property window)

Properties		Settings	Properties		Settings
Direction		Vertical	Current Value	Display	Not Display
Device		R		Color	Set this optionally.
Device Number		3		Background Color	
Data Type		word [signed]		Width	10
Level Color		Set this optionally.		Height	10
Upper Color			Level Length		160
Lower Color			Level Width		30
Background Color			X Coordinate		Set this optionally.
Upper Value		Y Coordinate			
Lower Value		5000	—		
Lower Value		-10			
Alarm Value	Display Line	Display			
	Line Color	Set this optionally.			
	Upper Value	4999			
	Lower Value	-1			

## ■Liquid Tank 1

Design window	Used components
	<p>Allocate the following components from the component window.</p> <ul style="list-style-type: none"> <li>❶ Image tag components In this example, the image files of "Tank" and "Liquid tank 1" are the same.</li> <li>❷ Image tag components Allocate an image file specific to "Liquid tank 1."</li> <li>❸ Line components</li> <li>❹ Label components</li> <li>❺ Level display and rectangle components This shows a water level (R1) in the liquid tank using a level indication. The rectangular component has to be located so that it will overlap with the level display component.</li> <li>❻ Data block components This shows the analog output (D102).</li> <li>❼ Image display components This indicates whether the analog output is monitored.</li> <li>❽ Hyper link components</li> </ul>

❺ The following items are set for the level display component. (Property window)

Properties		Settings	Properties		Settings
Direction		Vertical	Current Value	Display	Not Display
Device		R		Color	Set this optionally.
Device Number		1		Background Color	
Data Type		word [signed]		Width	10
Level Color		Set this optionally.		Height	10
Upper Color			Level Length		160
Lower Color			Level Width		30
Background Color			X Coordinate		Set this optionally.
Upper Value		5000	Y Coordinate		
Lower Value		-10	—		
Alarm Value	Display Line	Display			
	Line Color	Set this optionally.			
	Upper Value	4999			
	Lower Value	-1			

❻ The following items are set for the data block component. (Property window)

Properties		Settings	Properties		Settings
Direction		Horizontal	Device Value	Font Color	Set this optionally.
Block Size		1		Background Color	
Device Property	Display Label	Analog output(DA)		Cell Width	190
	Device	D102		Cell Height	50
	Data Type	word [signed]	X Coordinate		Set this optionally.
Display Format		Decimal	Y Coordinate		
Line Color		Set this optionally.	—		
Device Name	Display	Display			
	Font Color	Set this optionally.			
	Background Color				
	Cell Width	—			
	Cell Height	40			

7 The following items are set for the image display component. (Property window)

Properties	Settings	Properties	Settings	
Default Image	An image file that will be displayed when OFF.	Setting Range Property	Low	1
Device	M		High	1
Device Number	202		Image File	An image file that will be displayed when ON.
Data Type	Bit	Image Height	25	
Range Number	1	Image Width	100	
—		X Coordinate	Set this optionally.	
		Y Coordinate		

8 The following items are set for the hyper link component. (Property window)

Properties	Settings	Properties	Settings
Type	URL	Text	Inverter Manual
URL	An arbitrary address	Font Size	20
Page	—	X Coordinate	Set this optionally.
Target	Same Window	Y Coordinate	

### ■Liquid Tank 2

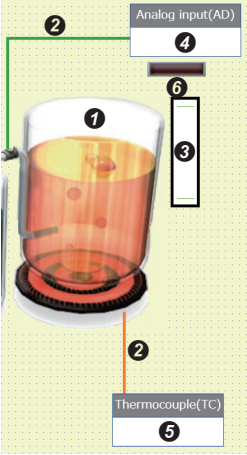
Design window	Used components
	<p>Allocate the following components from the component window.</p> <ul style="list-style-type: none"> <li>1 Image tag components</li> <li>2 Line components</li> <li>3 Level display and rectangle components</li> </ul> <p>This shows a water level (R2) in the liquid tank using a level indication. The rectangular component has to be located so that it will overlap with the level display component.</p> <ul style="list-style-type: none"> <li>4 Data block component</li> </ul> <p>This displays the analog input value (D101).</p> <ul style="list-style-type: none"> <li>5 Data block components</li> </ul> <p>This shows the measured temperature of temperature (D100).</p> <ul style="list-style-type: none"> <li>6 Image display components</li> </ul> <p>This indicates whether the analog input value is monitored.</p>

3 The following items are set for the level display component. (Property window)

Properties	Settings	Properties	Settings	
Direction	Vertical	Current Value	Display	Not Display
Device	R		Color	Set this optionally.
Device Number	2		Background Color	
Data Type	word [signed]		Width	10
Level Color	Set this optionally.		Height	10
Upper Color		Level Length	160	
Lower Color		Level Width	30	
Background Color		X Coordinate	Set this optionally.	
Upper Value	5000	Y Coordinate		
Lower Value	-10	—		
Alarm Value	Display Line	Display		
	Line Color	Set this optionally.		
	Upper Value	4999		
	Lower Value	-1		

4 The following items are set for the data block component. (Property window)

Properties		Settings	Properties		Settings
Direction		Horizontal	Device Value	Font Color	Set this optionally.
Block Size		1		Background Color	
Device Property	Display Label	Analog input(AD)		Cell Width	190
	Device	D101		Cell Height	50
	Data Type	word [signed]	X Coordinate	Set this optionally.	
	Display Format	Decimal	Y Coordinate		
Line Color		Set this optionally.	—		
Device Name	Display	Display	—		
	Font Color	Set this optionally.			
	Background Color				
	Cell Width	—			
	Cell Height	40			

5 The following items are set for the data block component. (Property window)

Properties		Settings	Properties		Settings
Direction		Horizontal	Device Value	Font Color	Set this optionally.
Block Size		1		Background Color	
Device Property	Display Label	Thermocouple(TC)		Cell Width	190
	Device	D100		Cell Height	50
	Data Type	word [signed]	X Coordinate	Set this optionally.	
	Display Format	Decimal	Y Coordinate		
Line Color		Set this optionally.	—		
Device Name	Display	Display	—		
	Font Color	Set this optionally.			
	Background Color				
	Cell Width	—			
	Cell Height	40			

6 The following items are set for the image display component. (Property window)

Properties		Settings	Properties		Settings
Default Image		An image file that will be displayed when OFF.	Setting Range Property	Low	1
Device		M		High	1
Device Number		201		Image File	An image file that will be displayed when ON.
Data Type		Bit	Image Height		25
Range Number		1	Image Width		100
—			X Coordinate		Set this optionally.
			Y Coordinate		

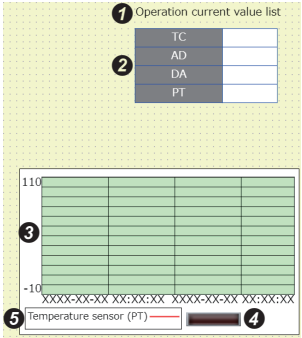

## ■ Batch Display Section

Design window	Used components
	<p>Allocate the following components from the component window.</p> <ul style="list-style-type: none"> <li>❶ Label components</li> <li>❷ Data block components This shows the analog input/output values (D101 and D102) and the temperatures (D100 and R100).</li> <li>❸ Historic graph components This shows the temperature (R100) in a time series line graph.</li> <li>❹ Image display components This shows whether the temperatures are monitored.</li> <li>❺ Rectangle, label, and line components</li> </ul>

❷ The following items are set for the data block component. (Property window)

Properties		Settings	Properties		Settings
Direction		Vertical	Device Value	Font Color	Set this optionally.
Block Size		4		Background Color	
Device Property		*1		Cell Width	100
Line Color		Set this optionally.		Cell Height	34
Device Name	Display	Display	X Coordinate		Set this optionally.
	Font Color	Set this optionally.	Y Coordinate		
	Background Color		—		
	Cell Width	160			
	Cell Height	—			

\*1 The following items are set for individual lines. (Display label, device, data type, and display format)

- First line: TC, D100, word [signed], and decimal number
- Second line: AD, D101, word [signed], and decimal number
- Third line: DA, D102, word [signed], and decimal number
- Fourth line: PT, R100, word [signed], and decimal number

❸ The following items are set for the historic graph component. (Property window)

Properties		Settings	Properties		Settings
Graph Element Number		1	Graph Background Color		Set this optionally.
Graph Element Property	Device Name	R	Character Color		Set this optionally.
	Device Number	100	Right Margin		10
	Line Color	Set this optionally.	Left Margin		40
Data Type		word [signed]	Upper Margin		15
Upper Limit Value		110	Lower Margin		75
Lower Limit Value		-10	Graph Height		215
Number Of Records		20	Graph Width		462
Vertical Axis Interval		5	X Coordinate		Set this optionally.
Number Of Horizontal Axes		11	Y Coordinate		

❹ The following items are set for the image display component. (Property window)

Properties		Settings	Properties		Settings
Default Image		An image file that will be displayed when OFF.	Setting Range Property	Low	1
Device		M		High	1
Device Number		200		Image File	An image file that will be displayed when ON.
Data Type		Bit	Image Height		25
Range Number		1	Image Width		100
—			X Coordinate		Set this optionally.
			Y Coordinate		

## Start Button and Hyper Link

A button to start monitoring and a hyper link to the top page will be allocated.

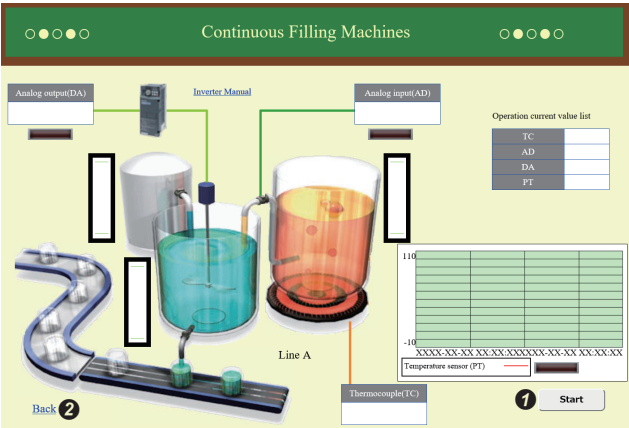
Design window	Used components
	<p>Allocate the following components from the component window.</p> <ul style="list-style-type: none"> <li>❶ Input button components A button (Y0) to start monitoring will be allocated.</li> <li>❷ Hyper link components A hyper link to return to the top page will be allocated.</li> </ul>

❶ The following items are set for the input button component. (Property window)

Properties	Settings	Properties	Settings
Device	Y	Write Confirm	Not Display
Device Number	0	Button Width	150
Data Type	Bit	Button Height	50
Display Format	Binary	X Coordinate	Set this optionally.
Write Value	1	Y Coordinate	
Button Text	Start		

❷ The following items are set for the hyper link component. (Property window)

Properties	Settings	Properties	Settings
Type	Page	Text	Back
URL	—	Font Size	26
Page	index.html	X Coordinate	Set this optionally.
Target	Same Window	Y Coordinate	

## Writing the Project

If a project is created, save it to an SD memory card attached to a CPU module.

When writing the project to the SD memory card, make sure that there are the css and img folders in the SD memory card. (☞ Page 60 File configuration) In addition, when the project is written to the SD memory card, all files under the USER folder in the SD memory card will be deleted. Save files in the SD memory card, as appropriate.

### 1. Communication Settings

[Communication] ⇒ [Communication Settings]

Set an IP address, a user name, and a password from "Communication Settings." Make sure that these settings are the same as those settings which are written to the CPU module by GX Works3. (☞ Page 27 Communication Settings)

### 2. Uploading to SD Memory Card

[Communication] ⇒ [Write files to PLC (SD Memory Card)]

Use "Write files to PLC (SD Memory Card)" to write the project, which is currently opened and already saved, to the SD memory card.

#### Point

When an SD memory card is used on the FX5S CPU module, an SD memory card module is required.

## Access to user Web page

If a project is written to an SD memory card attached to a CPU module, the user Web page can be accessed from the Web browser. Refer to the following documents for more information about respective settings.

📖 MELSEC iQ-R Ethernet User's Manual (Application)

📖 MELSEC iQ-F FX5 User's Manual (Communication)

📖 MELSEC iQ-R/MELSEC iQ-F Web Server Function Guide Book

### 1. Setting CPU Module Parameters

Use GX Works3 to set the CPU module's "IP Address" and "Web Server Settings". For "Authority for Window Display" in "Web Server Settings," select either "Permit Both Displays" or "User Web Page Only" to write the selection to the CPU module.

If the input button and arbitrary value write button components are used, set "Write Device" in "Web Server Account Settings" to "Enable".

### 2. Access to Login Page

Enter the following URL to a Web browser's address bar to access the user Web page.

http://[the IP address of the Web server (the CPU module)]/

For example, if the IP address of the CPU module is 192.168.3.39: http://192.168.3.39/

If the own station's port number is changed from its default value (80), enter the following.

http://[the IP address of the Web server (the CPU module)]:[the own station's port number]/

For example, if the IP address of the CPU module is 192.168.3.39: http://192.168.3.39:8080/

### 3. Login Operations

On a login screen, enter the "Use Name" and "Password" set by "Web Server Settings" to log in to the user Web page.

### 4. Access to User Web Page

Access destinations after login may vary, depending on what is set for "Initial Display Window".

[When "System Web Page" is selected]

A system Web page will be accessed after login. If "User Web Page" is selected from its menu, the user Web page will be accessed.

[When "User Web Page" is selected]

The user Web page will be accessed after login.

# 4 NOTES

---

Notes are as shown below.

## User operation

---

Only one keyboard shortcut or menu command can be used at a time.

## External editing

---

- If an HTML file is created externally, it cannot be processed by this tool.
- If an HTML file was created by this tool but is directly edited externally, it may not be processed by this tool.

## Project file configuration

---

Do not remove MENUWDT.WSV from the USER folder. If removed, the tool cannot read the project.

## Overlapping setting ranges

---

For a generic component or an image display component, if its setting ranges overlap each other, one with a smaller setting range number will be displayed. For example, if a device value is in both setting range 1 and setting range 2, it will be displayed in setting range 1.

## Image file

---

Only one file with the same file name and extension can be used in a project. If there is a file in the img folder with the same file name and extension as those of a used image (specified by an image component), the file in the img folder will be overwritten with one specified later.

## Preview

---

- If there are problems in the property settings of PLC and generic components allocated to an HTML file displayed in the design window, their previews cannot be displayed. For a problematic component, an error message will be displayed and therefore deal with the problematic component. (Even if there are multiple problematic components, an error message for only one of the problematic components will be displayed)
- As executing a preview, the system outputs files under the install folder. If the memory of the file output destination is insufficient, the output fails and the preview cannot be displayed.

## Access to Web server

---

Communication in the Web server's functions doesn't support encrypted communication (SSL communication). Do not access the Web server via the Internet. When accessing the Web server, access it within its LAN. When it is accessed via the Internet, the communication may be intercepted.

## Access to HTML file

After having logged in the Web server, do not access an individual user Web page by directly specifying its URL. If such a URL is specified, the screen will not be displayed correctly, and information cannot be collected from the Web server.

## Device value of historic graph

If a heavy communication load state continues for a historic graph component, it may miss its device values.

## Troubleshooting

If FTP communication fails, refer to the following document for troubleshooting.

 MELSEC iQ-R Ethernet User's Manual (Application)

 MELSEC iQ-F FX5 User's Manual (Communication)

Refer to the document  MELSEC iQ-R/MELSEC iQ-F Web Server Function Guide Book for more information about the Web server functions.

# APPENDIX

## Appendix 1 Project Management

This section describes how to conduct the basic operations and management of a project.

### Project file

This tool treats an HTML file for user Web pages (up to 160 pages) for one CPU module as a project. A generated project is stored in a file and managed on a project basis.

### File configuration

This section shows the file configuration of a project created by this tool.

Do not change the configurations of folders and files other than those encircled by the dotted lines. If file names and folder configuration are different from what are shown here, the project cannot be written to a CPU module.

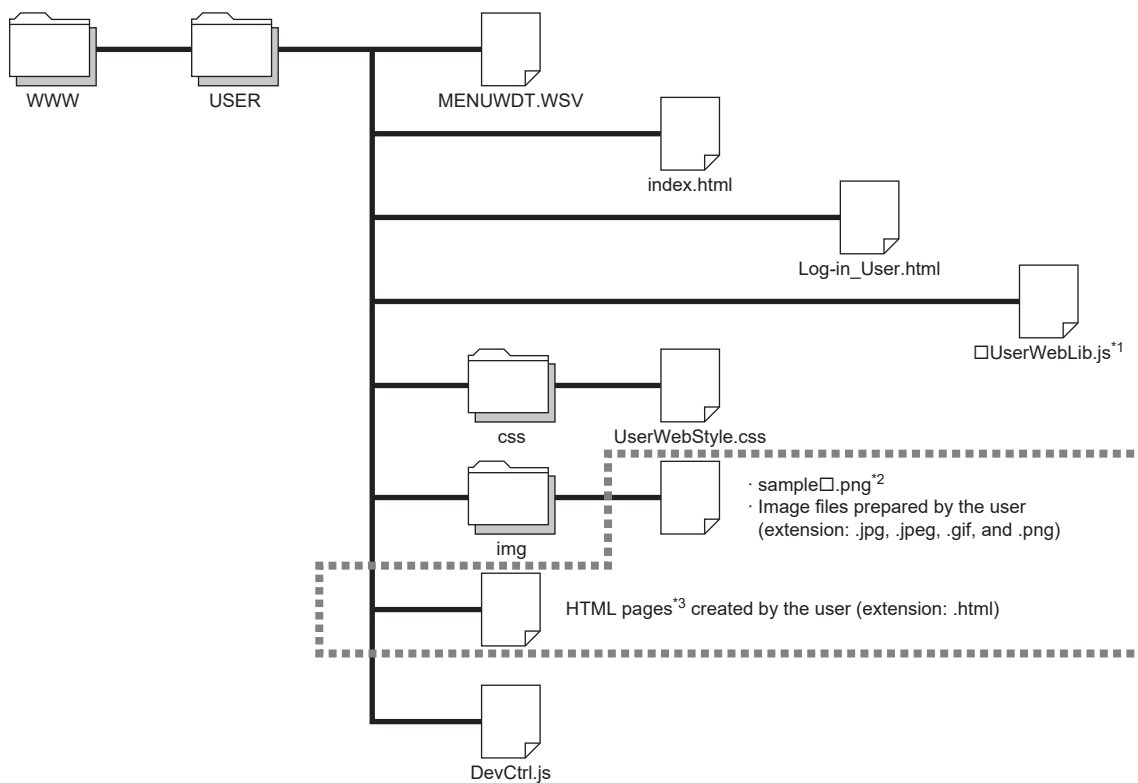

\*1 Its file name varies, depending on a project's series.

RCPU: RUserWebLib.js

FX5CPU: FUserWebLib.js

\*2 [ ]: 0 to 3

\*3 If an HTML file is created and edited by one other than this tool and is read, it will not be displayed correctly.

## ■ Configuration file list

Configuration files are extracted to the work area of the installation destination in accordance with the series selection, this tool, or display language setting of the target project.

File name	Description
MENUWDT.WSV	This is the configuration file of a project in question. If this file is stored in the WWW/USER folder, this tool will recognize it as a project.
index.html	This is an HTML file which will be displayed initially when a user Web page is logged in.*1
Log-in_User.html	This is an HTML file that will be displayed when the user Web page is logged out.*1
FUserWebLib.js	This is a JavaScript library file for the user Web page. This will be allocated only for an FX5CPU project.
RUserWebLib.js	This is a JavaScript library file for the user Web page. This will be allocated only for an RCP project.
sample□.png*2	This is a default image file for image display and image components.
UserWebStyle.css	This is a style sheet for the User Web page.
DevCtrl.js	This is a JavaScript library file for an arbitrary value write button component. If no arbitrary value write button component is used, this will not be shown.

\*1 It is possible to edit an HTML file.

\*2 □: 0 to 3

# MEMO

---



# INDEX

---

## A

---

Arbitrary value write Button . . . . . 37

## C

---

Component properties . . . . . 46  
Component Window . . . . . 30

## D

---

Data Block . . . . . 31  
Design Window . . . . . 45

## E

---

Ellipse . . . . . 41

## F

---

FTP communication . . . . . 49

## G

---

Generic components . . . . . 38  
Graphic Display . . . . . 33

## H

---

Historic Graph . . . . . 35  
Hyper Link . . . . . 39

## I

---

Image Display . . . . . 34  
Image Tag . . . . . 40  
Input Button . . . . . 36

## L

---

Label . . . . . 38  
Level Display . . . . . 32  
Line . . . . . 40  
Logout Button . . . . . 36

## M

---

Menu Bar . . . . . 23

## O

---

Operating Environment . . . . . 5

## P

---

Page properties . . . . . 46  
PLC components . . . . . 30  
Property Window . . . . . 46

## R

---

Rectangle . . . . . 41

## S

---

Software License . . . . . 7



# MEMO

---

# REVISIONS

Revision date	Revision	Description
October 2020	A	First Edition
October 2021	B	■Added or modified part Section 1.2
May 2022	C	■Added or modified parts Chapter 1, 2, 3, 4, Appendix 1
June 2023	D	■Added or modified parts RELEVANT MANUALS, Section 2.3, 2.5, 3.1, 3.2, Chapter 4, TRADEMARKS

Japanese manual number: SH-082314-D

This manual confers no industrial property rights or any rights of any other kind, nor does it confer any patent licenses. Mitsubishi Electric Corporation cannot be held responsible for any problems involving industrial property rights which may occur as a result of using the contents noted in this manual.

© 2020 MITSUBISHI ELECTRIC CORPORATION

# TRADEMARKS

---

Microsoft, Windows, Microsoft Edge, and Internet Explorer are trademarks of the Microsoft group of companies.

Android and Google Chrome are either registered trademarks or trademarks of Google LLC.

Safari is a trademark of Apple Inc., registered in the U.S. and other countries.

IOS (iOS) is either a registered trademark or trademark of Cisco Systems, Inc. and/or its affiliates in the United States and certain other countries, and iOS is used under license by Apple Inc.

Intel is either registered trademarks or trademarks of Intel Corporation in the United States and/or other countries.

Oracle and Java are registered trademarks of Oracle and/or its affiliates.

The company names, system names and product names mentioned in this manual are either registered trademarks or trademarks of their respective companies.

In some cases, trademark symbols such as <sup>™</sup> or <sup>®</sup> are not specified in this manual.



Manual number: SH(NA)-082315ENG-D

## **MITSUBISHI ELECTRIC CORPORATION**

HEAD OFFICE: TOKYO BLDG., 2-7-3, MARUNOUCHI, CHIYODA-KU, TOKYO 100-8310, JAPAN  
NAGOYA WORKS: 1-14, YADA-MINAMI 5-CHOME, HIGASHI-KU, NAGOYA 461-8670, JAPAN

When exported from Japan, this manual does not require application to the  
Ministry of Economy, Trade and Industry for service transaction permission.

Specifications subject to change without notice.