

**MITSUBISHI ELECTRIC**  
PROGRAMMABLE CONTROLLERS  
MELSEC-F

## FX3U-485ADP

# Installation Manual

Manual Number	JY997D13801
Revision	J
Date	April 2013



This manual describes the part names, dimensions, mounting, and specifications of the product. Before use, read this manual and the manuals of all relevant products fully to acquire proficiency in handling and operating the product. Make sure to learn all the product information, safety information, and precautions. Store this manual in a safe place so that it can be taken out and read whenever necessary. Always forward it to the end user. Registration: The company and product names described in this manual are registered trademarks or the trademarks of their respective companies. Effective April 2013. Specifications are subject to change without notice. © 2005 Mitsubishi Electric Corporation

### Safety Precaution (Read these precautions before use.)

This manual classifies the safety precautions into two categories:

**WARNING** and **CAUTION**.

<b>WARNING</b>	Indicates that incorrect handling may cause hazardous conditions, resulting in death or severe injury.
<b>CAUTION</b>	Indicates that incorrect handling may cause hazardous conditions, resulting in medium or slight personal injury or physical damage.

Depending on the circumstances, procedures indicated by **CAUTION** may also cause severe injury. It is important to follow all precautions for personal safety.

### Associated Manuals

Manual name	Manual No.	Description
FX3S Series User's Manual - Hardware Edition	JY997D48601 MODEL CODE: 09R535	Explains the FX3S Series PLC specifications for I/O, wiring, installation, and maintenance.
FX3G Series User's Manual - Hardware Edition	JY997D31301 MODEL CODE: 09R521	Explains the FX3G Series PLC specifications for I/O, wiring, installation, and maintenance.
FX3GC Series User's Manual - Hardware Edition	JY997D45401 MODEL CODE: 09R533	Explains the FX3GC Series PLC specifications for I/O, wiring, installation, and maintenance.
FX3U Series User's Manual - Hardware Edition	JY997D16501 MODEL CODE: 09R516	Explains the FX3U Series PLC specifications for I/O, wiring, installation, and maintenance.
FX3UC Series User's Manual - Hardware Edition	JY997D28701 MODEL CODE: 09R519	Explains the FX3UC Series PLC specifications for I/O, wiring, installation, and maintenance.
FX3S/FX3G/FX3GC/FX3U/FX3UC Series Programming Manual - Basic & Applied Instruction Edition	JY997D16601 MODEL CODE: 09R517	Describes PLC programming for basic/applied instructions and devices.
FX Series User's Manual - Data Communication Edition	JY997D16901 MODEL CODE: 09R715	Explains N:N network, Parallel Link, Computer Link, Non-Protocol communication by RS and RS2 instructions/FX2N-232IF.

### How to obtain manuals

For product manuals or documents, consult with the Mitsubishi Electric dealer from who you purchased your product.

### Applicable standards

FX3U-485ADP units made in June, 2005 or later comply with the EC Directive (EMC Directive) and UL standards (UL, cUL). Further information can be found in the following manual.

- FX3S Series Hardware Manual (Manual No. JY997D48301)
- FX3G Series Hardware Manual (Manual No. JY997D46001)
- FX3GC Series Hardware Manual (Manual No. JY997D45201)
- FX3U Series Hardware Manual (Manual No. JY997D18801)
- FX3UC (D, DS, DSS) Series Hardware Manual (Manual No. JY997D28601)
- FX3UC-32MT-LT-2 Hardware Manual (Manual No. JY997D31601)

Regarding the standards that relate to the main unit, please refer to either the FX series product catalog or consult with your nearest Mitsubishi product provider.

### Attention

- This product is designed for use in industrial applications.

### Note

- Manufactured by: Mitsubishi Electric Corporation  
2-7-3 Marunouchi, Chiyoda-ku, Tokyo, 100-8310 Japan
- Manufactured at: Mitsubishi Electric Corporation Himeji Works  
840 Chiyoda-machi, Himeji, Hyogo, 670-8677 Japan
- Authorized Representative in the European Community:  
Mitsubishi Electric Europe B.V.  
Gothaer Str. 8, 40880 Ratingen, Germany

## 1. Outline

The FX3U-485ADP communication special adapter (hereinafter called 485ADP) is a special adapter for RS-485 communication with a terminal block (European type). The 485ADP is an isolated signal exchange unit of RS-485 serial data communication between the PLC and an RS-485 device.

### 1.1 Communication Function

Communication type	Function
N:N network	Data transfer connecting up to eight FX Series PLCs.
Parallel link	Data transfer between two FX Series PLCs relationship specifying master/slave station.
Computer link	Data transfer between the PLC and computer (specified as the master station) via dedicated protocol.
Non-protocol communication	Serial communication between the PLC and an RS-485 device via non-protocol.
Inverter communication	Controlling Mitsubishi's FREQROL inverter using inverter communication instructions.

### 1.2 Incorporated Items

Verify that the following product and items are included in the package:

Product	FX3U-485ADP communication special adapter
Accessories	Label for indication of link station number Installation manual (This manual)

The label should be applied on the front of 485ADP for checking station numbers in N:N network, computer link, etc.

### 1.3 External Dimensions and Part Names

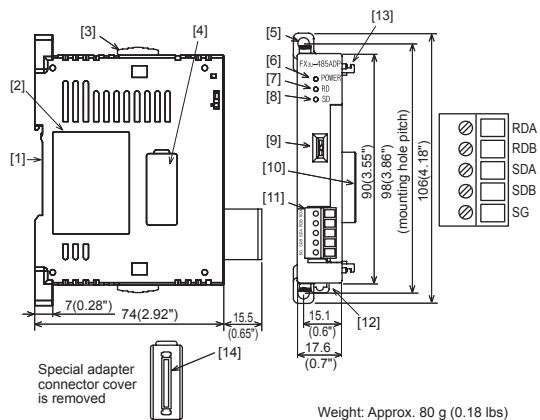

- [1] DIN rail mounting groove (DIN rail: DIN46277)
- [2] Name plate
- [3] Special adapter slide lock: Used to connect additional special adapters onto left side of this special adapter.
- [4] Special adapter connector cover: Remove this cover to connect additional special adapters on the left side.
- [5] Direct mounting hole: 2 holes of  $\phi 4.5$  (0.18") (mounting screw: M4 screw) Not used when connecting to FX3GC/FX3UC Series PLC.
- [6] POWER LED (green): Lit while 5 V DC power is supplied from main unit.
- [7] RD LED (red): Lit while receiving data from connected RS-485 device.
- [8] SD LED (red): Lit while sending data to connected RS-485 device.
- [9] Terminal resistor selector switch (330 $\Omega$ /OPEN/110 $\Omega$ )
- [10] Special adapter connector: Used to connect this special adapter to PLC main unit or special adapter.
- [11] Terminal block (European type) for connecting RS-485 device Use to connect RS-485 device to 485ADP.
- [12] DIN rail mounting hook
- [13] Special adapter fixing hook
- [14] Special adapter connector: Used to connect communication or analog special adapter to the left side of the 485ADP.

### 1.4 Terminal Configuration

The terminal configuration of the RS-485 terminal on the 485ADP is shown below. Note that the terminal configuration is different from that of the FX3U-485-BD.

Terminal screws	Signal name	Function	Signal direction	
			485ADP	RS-485 equipment
RDA(RXD+)	RDB(RXD-)	Receive data	←	
			→	
SDA(TXD+)	SDB(TXD-)	Send data	→	
			←	
SG(GND)	Signal ground		-	

### 1.5 Terminal Resistor Selector Switch

485ADP has a built-in terminal resistor. A terminal resistor may be required depending on the communication type. Refer to the following manual for the terminal resistor setting.

→ FX Series User's Manual - Data Communication Edition

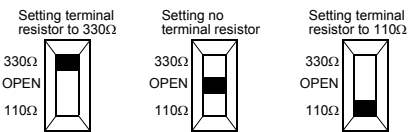

### 1.6 Operation of Terminal Resistor Selector Switch

Use the tip of tweezers, tip of mechanical pencil, minute screwdriver, or the tool whose tip width is about 0.8 mm (0.03") when operating the terminal resistor selector switch.

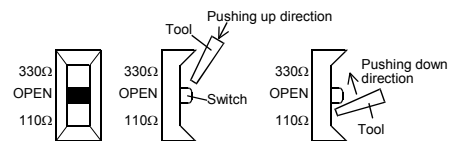

Either 'push down' or 'push up' the switch to change the setting as indicated in the figure above. Confirm the clicking noise when setting the switch.

## 2. Channel Allocation

Up to two communication ports can be added to the main unit. Refer to the following manual for equipment that occupies communication ports. → FX Series User's Manual - Data Communication Edition

### FX3S Series PLC

Communication port channels are automatically allocated.

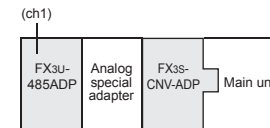

### FX3G Series PLC

Communication port channels are automatically allocated.

- 40-point, 60-point type

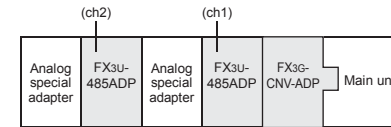

### FX3GC Series PLC

Communication port channels are automatically allocated. The communication special adapter closer to the main unit is ch1.

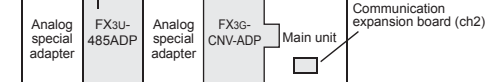

- 14-point, 24-point type

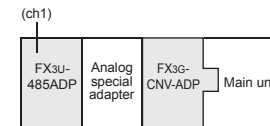

### FX3UC Series PLC

Communication port channels are automatically allocated. The communication special adapter closer to the main unit is ch1.

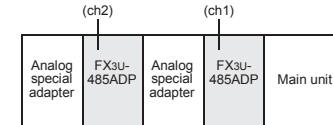

### FX3U/FX3UC-32MT-LT(-2) Series PLC

Communication port channels are automatically allocated. The communication special adapter closer to the main unit is ch1.

- Using one communication special adapter + communication expansion board

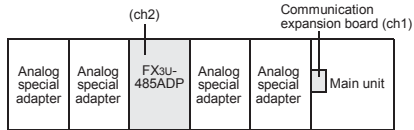

- Using two communication special adapters

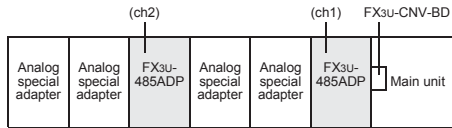

### FX3UC (D, DS, DSS) Series PLC

Communication port channels are automatically allocated. The communication special adapter closer to the main unit is ch1.

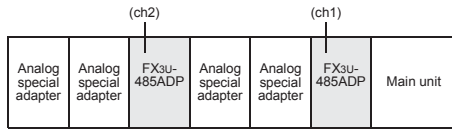

### 3. Installation

For installation/uninstallation details, refer to the respective PLC User's manual Hardware Edition.

INSTALLATION PRECAUTIONS	<b>⚠ WARNING</b>
<ul style="list-style-type: none"> <li>Make sure to cut off all phases of the power supply externally before attempting installation or wiring work. Failure to do so may cause electric shock or damage to the product.</li> </ul>	

INSTALLATION PRECAUTIONS	<b>⚠ CAUTION</b>
<ul style="list-style-type: none"> <li>Use the product within the generic environment specifications described in PLC main unit manual (Hardware Edition). Never use the product in areas with excessive dust, oily smoke, conductive dusts, corrosive gas (salt air, Cl<sub>2</sub>, H<sub>2</sub>S, SO<sub>2</sub>, or NO<sub>2</sub>), flammable gas, vibration or impacts, or expose it to high temperature, condensation, or rain and wind. If the product is used in such conditions, electric shock, fire, malfunctions, deterioration or damage may occur.</li> <li>When drilling screw holes or wiring, make sure cutting or wire debris does not enter the ventilation slits. Failure to do so may cause fire, equipment failures or malfunctions.</li> <li>Do not touch the conductive parts of the product directly. Doing so may cause device failures or malfunctions.</li> <li>Connect special adapter securely to their designated connectors. Loose connections may cause malfunctions.</li> </ul>	

### 3.1 Connection to the PLC

This section describes the connection method to the PLC (FX3U Series PLC is used for the following example).

For installation method to other PLCs, refer to the respective PLC User's manual Hardware Edition.

#### Procedure

- Turn off the power. Disconnect all the cables connected to the PLC main unit and special adapter, and demount the main unit and special adapter mounted on DIN rail or mounted directly using screws.
- Install an expansion board to the main unit. For the expansion board installation procedure, refer to the following manual: → **FX3U Series User's Manual - Hardware Edition**
- Remove the special adapter connector cover on the expansion board (fig.A). When connecting this product to another special adapter, please replace the 'expansion board' in the above description with a 'special adapter' and perform the procedure as indicated.
- Slide the special adapter slide lock (fig.B) of the main unit. When connecting this product to another special adapter, please replace the 'main unit' in the above description with a 'special adapter' and perform the procedure as indicated. (Please replace the following procedures similarly.)

- Connect the special adapter (fig.C) to the main unit as shown on the right.
- Slide back the special adapter slide lock (fig.B) of the main unit to fix the special adapter (fig.C).

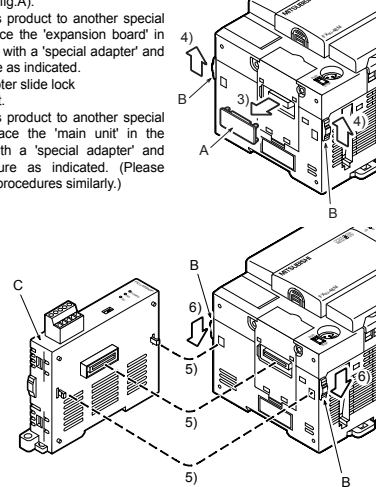

#### Connection precautions

Connect all the high-speed I/O special adapters before connecting other special adapters when they are used in combination.

Do not connect a high-speed I/O special adapter on the left side of any special adapters other than other high-speed I/O special adapters.

### 4. Wiring

For wiring details, refer to the following manual.

→ **FX Series User's Manual - Data Communication Edition**

WIRING PRECAUTIONS	<b>⚠ WARNING</b>
<ul style="list-style-type: none"> <li>Make sure to cut off all phases of the power supply externally before attempting installation or wiring work. Failure to do so may cause electric shock or damage to the product.</li> </ul>	

WIRING PRECAUTIONS	<b>⚠ CAUTION</b>
<ul style="list-style-type: none"> <li>When drilling screw holes or wiring, make sure cutting or wire debris does not enter the ventilation slits. Failure to do so may cause fire, equipment failures or malfunctions.</li> <li>Make sure to observe the following precautions in order to prevent any damage to the machinery or accidents due to abnormal data written to the PLC under the influence of noise:                     <ol style="list-style-type: none"> <li>Do not bundle the main circuit line together with or lay it close to the main circuit, high-voltage line or load line. Otherwise, noise disturbance and/or surge induction are likely to take place. As a guideline, lay the control line at least 100mm (3.94") or more away from the main circuit or high-voltage lines.</li> <li>Ground the shield wire or shield of the shielded cable at one point on the PLC. However, do not use common grounding with heavy electrical systems.</li> </ol> </li> <li>Make sure to properly wire to the terminal block (European type) in accordance with the following precautions. Failure to do so may cause electric shock, equipment failures, a short-circuit, wire breakage, malfunctions, or damage to the product.                     <ul style="list-style-type: none"> <li>The disposal size of the cable end should follow the dimensions described in the manual of the PLC main unit.</li> <li>Tightening torque should follow the specifications in the manual of the PLC main unit.</li> <li>Twist the end of strand wire and make sure that there are no loose wires.</li> <li>Do not solder-plate the electric wire ends.</li> <li>Do not connect more than the specified number of wires or electric wires of unspecified size.</li> <li>Affix the electric wires so that neither the terminal block nor the connected parts are directly stressed.</li> </ul> </li> </ul>	

WIRING PRECAUTIONS	<b>⚠ CAUTION</b>
<ul style="list-style-type: none"> <li>When drilling screw holes or wiring, make sure cutting or wire debris does not enter the ventilation slits. Failure to do so may cause fire, equipment failures or malfunctions.</li> <li>Make sure to observe the following precautions in order to prevent any damage to the machinery or accidents due to abnormal data written to the PLC under the influence of noise:                     <ol style="list-style-type: none"> <li>Do not bundle the main circuit line together with or lay it close to the main circuit, high-voltage line or load line. Otherwise, noise disturbance and/or surge induction are likely to take place. As a guideline, lay the control line at least 100mm (3.94") or more away from the main circuit or high-voltage lines.</li> <li>Ground the shield wire or shield of the shielded cable at one point on the PLC. However, do not use common grounding with heavy electrical systems.</li> </ol> </li> <li>Make sure to properly wire to the terminal block (European type) in accordance with the following precautions. Failure to do so may cause electric shock, equipment failures, a short-circuit, wire breakage, malfunctions, or damage to the product.                     <ul style="list-style-type: none"> <li>The disposal size of the cable end should follow the dimensions described in the manual of the PLC main unit.</li> <li>Tightening torque should follow the specifications in the manual of the PLC main unit.</li> <li>Twist the end of strand wire and make sure that there are no loose wires.</li> <li>Do not solder-plate the electric wire ends.</li> <li>Do not connect more than the specified number of wires or electric wires of unspecified size.</li> <li>Affix the electric wires so that neither the terminal block nor the connected parts are directly stressed.</li> </ul> </li> </ul>	

#### Wiring precaution

- Do not attach the terminal block (replacement European terminal block) for connecting RS-485 device which is already wired to FX3U-485-BD. If attached as its left and right are confused, the terminal configuration becomes upside down and no communication is performed.

### 5. Specifications

STARTUP AND MAINTENANCE PRECAUTIONS	<b>⚠ CAUTION</b>
<ul style="list-style-type: none"> <li>Do not disassemble or modify the PLC. Doing so may cause fire, equipment failures, or malfunctions. * For repair, contact your local Mitsubishi Electric representative.</li> <li>Do not drop the product or exert strong impact to it. Doing so may cause damage.</li> </ul>	

DISPOSAL PRECAUTIONS	<b>⚠ CAUTION</b>
<ul style="list-style-type: none"> <li>Please contact a certified electronic waste disposal company for the environmentally safe recycling and disposal of your device.</li> </ul>	

TRANSPORTATION AND STORAGE PRECAUTIONS	<b>⚠ CAUTION</b>
<ul style="list-style-type: none"> <li>The product is a precision instrument. During transportation, avoid any impacts. Failure to do so may cause failures in the product. After transportation, verify the operations of the product.</li> </ul>	

#### 5.1 Applicable PLC

Model name	Applicability
FX3S Series PLC	Ver. 1.00 or later (from first production)
FX3G Series PLC	Ver. 1.00 or later (from first production)
FX3GC Series PLC	Ver. 1.40 or later (from first production)
FX3U Series PLC	Ver. 2.20 or later (from first production)
FX3UC Series PLC	Ver. 1.00 or later (from first production)

The version number can be checked by monitoring D8001/D8101 as the last three digits indicate it.

### 5.2 General Specifications

Items other than the following are equivalent to those of the PLC main unit. For general specifications, refer to the respective PLC User's manual Hardware Edition.

Item	Specification	
Dielectric withstand voltage	500 V AC, one minute	Between terminal block and ground terminal of PLC main unit
Insulation resistance	5 MΩ or more by 500 V DC megger	

### 5.3 Power Supply Specifications

Item	Specification
Current consumption	20 mA 5 V DC power is supplied from the internal power supply of main unit.

### 5.4 Performance Specification

Item	Specification
Transmission standard	Conforming to RS-485/RS-422
Type of isolation	Photocoupler isolation
Transmission distance	Total extension distance: 500 m (1640' 5") or less [50 m (164' 0") or less if FX1N-485-BD, FX2N-485-BD or FX3G-485-BD, FX3U-485-BD is installed to connected equipment]
Connection method	European type terminal block, AWG 22-20 (when inserting one twisted pair cable), AWG 22 (when inserting two twisted pair cables) Tightening torque: 0.22 to 0.25 N·m
Number of occupied I/O points	0 point (This number is not related to the maximum number of input/output points of the PLC.)
Communication method	Half-duplex
Baud rate	N:N network: 38400 bps Parallel Link: 115200 bps Computer Link, Non-Protocol Communication: 300/600/1200/2400/4800/9600/19200/38400 <sup>1</sup> bps Inverter communication: 4800/9600/19200/38400 <sup>1</sup> bps
Communication format	N:N network, Parallel Link Computer Link (dedicated protocol: format 1/format 4), Non-Protocol, and Inverter communication
LED display: LED color	Power: green, RD: red, SD: red

<sup>1</sup> Applicable for FX3U/FX3UC Series PLC Ver. 2.41 or later and FX3S/FX3G/FX3GC Series PLC.

This manual confers no industrial property rights or any rights of any other kind, nor does it confer any patent licenses. Mitsubishi Electric Corporation cannot be held responsible for any problems involving industrial property rights which may occur as a result of using the contents noted in this manual.

#### Warranty

Mitsubishi will not be held liable for damage caused by factors found not to be the cause of Mitsubishi; opportunity loss or lost profits caused by faults in the Mitsubishi products; damage, secondary damage, accident compensation caused by special factors unpredictable by Mitsubishi; damages to products other than Mitsubishi products; and to other duties.

<b>⚠ For safe use</b>
<ul style="list-style-type: none"> <li>This product has been manufactured as a general-purpose part for general industries, and has not been designed or manufactured to be incorporated in a device or system used in purposes related to human life.</li> <li>Before using the product for special purposes such as nuclear power, electric power, aerospace, medicine or passenger movement vehicles, consult with Mitsubishi Electric.</li> <li>This product has been manufactured under strict quality control. However when installing the product where major accidents or losses could occur if the product fails, install appropriate backup or failsafe functions in the system.</li> </ul>

## MITSUBISHI ELECTRIC CORPORATION

HEAD OFFICE : TOKYO BUILDING, 2-7-3 MARUNOUCHI, CHIYODA-KU, TOKYO 100-8310, JAPAN  
HIMEJI WORKS : 840, CHIYODA CHO, HIMEJI, JAPAN

**MITSUBISHI ELECTRIC**  
PROGRAMMABLE CONTROLLERS  
MELSEC-F

**FX3U-485ADP**

**Installation Manual**

Manual Number	JY997D13801
Revision	J
Date	April 2013

**FX3U**

This manual describes the part names, dimensions, mounting, and specifications of the product. Before use, read this manual and the manuals of all relevant products fully to acquire proficiency in handling and operating the product. Make sure to learn all the product information, safety information, and precautions. Store this manual in a safe place so that it can be taken out and read whenever necessary. Always forward it to the end user.

Registration:  
The company and product names described in this manual are registered trademarks or the trademarks of their respective companies.

Effective April 2013  
Specifications are subject to change without notice.

© 2005 Mitsubishi Electric Corporation

**Safety Precaution** (Read these precautions before use.)

This manual classifies the safety precautions into two categories:

**WARNING** and **CAUTION**

<b>WARNING</b>	Indicates that incorrect handling may cause hazardous conditions, resulting in death or severe injury.
<b>CAUTION</b>	Indicates that incorrect handling may cause hazardous conditions, resulting in medium or slight personal injury or physical damage.

Depending on the circumstances, procedures indicated by **CAUTION** may also cause severe injury. It is important to follow all precautions for personal safety.

**Associated Manuals**

Manual name	Manual No.	Description
FX3S Series User's Manual - Hardware Edition	JY997D48601 MODEL CODE: 09R535	Explains the FX3S Series PLC specifications for I/O, wiring, installation, and maintenance.
FX3G Series User's Manual - Hardware Edition	JY997D31301 MODEL CODE: 09R521	Explains the FX3G Series PLC specifications for I/O, wiring, installation, and maintenance.
FX3GC Series User's Manual - Hardware Edition	JY997D45401 MODEL CODE: 09R533	Explains the FX3GC Series PLC specifications for I/O, wiring, installation, and maintenance.
FX3U Series User's Manual - Hardware Edition	JY997D16501 MODEL CODE: 09R516	Explains the FX3U Series PLC specifications for I/O, wiring, installation, and maintenance.
FX3UC Series User's Manual - Hardware Edition	JY997D28701 MODEL CODE: 09R519	Explains the FX3UC Series PLC specifications for I/O, wiring, installation, and maintenance.
FX3S/FX3G/FX3GC/FX3U/FX3UC Series Programming Manual - Basic & Applied Instruction Edition	JY997D16601 MODEL CODE: 09R517	Describes PLC programming for basic/applied instructions and devices.
FX Series User's Manual - Data Communication Edition	JY997D16901 MODEL CODE: 09R715	Explains N:N network, Parallel Link, Computer Link, Non-Protocol communication by RS and RS2 instructions/FX2N-232IF.

**How to obtain manuals**

For product manuals or documents, consult with the Mitsubishi Electric dealer from who you purchased your product.

**FX3U/FX3UC-32MT-LT(-2) Series PLC**

Communication port channels are automatically allocated. The communication special adapter closer to the main unit is ch1.

- Using one communication special adapter + communication expansion board

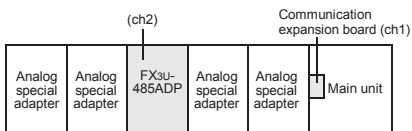

- Using two communication special adapters

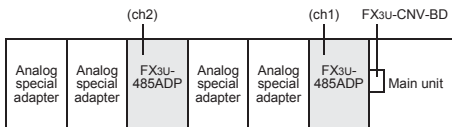

**FX3UC (D, DS, DSS) Series PLC**

Communication port channels are automatically allocated. The communication special adapter closer to the main unit is ch1.

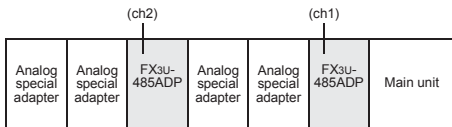

**3. Installation**

For installation/uninstallation details, refer to the respective PLC User's manual Hardware Edition.

**INSTALLATION PRECAUTIONS** **WARNING**

- Make sure to cut off all phases of the power supply externally before attempting installation or wiring work. Failure to do so may cause electric shock or damage to the product.

**INSTALLATION PRECAUTIONS** **CAUTION**

- Use the product within the generic environment specifications described in PLC main unit manual (Hardware Edition). Never use the product in areas with excessive dust, oily smoke, conductive dusts, corrosive gas (salt air, Cl<sub>2</sub>, H<sub>2</sub>S, SO<sub>2</sub>, or NO<sub>2</sub>), flammable gas, vibration or impacts, or expose it to high temperature, condensation, or rain and wind. If the product is used in such conditions, electric shock, fire, malfunctions, deterioration or damage may occur.
- When drilling screw holes or wiring, make sure cutting or wire debris does not enter the ventilation slits. Failure to do so may cause fire, equipment failures or malfunctions.
- Do not touch the conductive parts of the product directly. Doing so may cause device failures or malfunctions.
- Connect special adapter securely to their designated connectors. Loose connections may cause malfunctions.

**Applicable standards**

FX3U-485ADP units made in June, 2005 or later comply with the EC Directive (EMC Directive) and UL standards (UL, cUL). Further information can be found in the following manual.

- FX3S Series Hardware Manual (Manual No. JY997D48301)
- FX3G Series Hardware Manual (Manual No. JY997D46001)
- FX3GC Series Hardware Manual (Manual No. JY997D45201)
- FX3U Series Hardware Manual (Manual No. JY997D18801)
- FX3UC (D, DS, DSS) Series Hardware Manual (Manual No. JY997D28601)
- FX3UC-32MT-LT-2 Hardware Manual (Manual No. JY997D31601)

Regarding the standards that relate to the main unit, please refer to either the FX series product catalog or consult with your nearest Mitsubishi product provider.

**Attention**

- This product is designed for use in industrial applications.

**Note**

- Manufactured by: Mitsubishi Electric Corporation  
2-7-3 Marunouchi, Chiyoda-ku, Tokyo, 100-8310 Japan
- Manufactured at: Mitsubishi Electric Corporation Himeji Works  
840 Chiyoda-machi, Himeji, Hyogo, 670-8677 Japan
- Authorized Representative in the European Community:  
Mitsubishi Electric Europe B.V.  
Gothaer Str. 8, 40880 Ratingen, Germany

**1. Outline**

The FX3U-485ADP communication special adapter (hereinafter called 485ADP) is a special adapter for RS-485 communication with a terminal block (European type). The 485ADP is an isolated signal exchange unit of RS-485 serial data communication between the PLC and an RS-485 device.

**1.1 Communication Function**

Communication type	Function
N:N network	Data transfer connecting up to eight FX Series PLCs.
Parallel link	Data transfer between two FX Series PLCs relationship specifying master/slave station.
Computer link	Data transfer between the PLC and computer (specified as the master station) via dedicated protocol.
Non-protocol communication	Serial communication between the PLC and an RS-485 device via non-protocol.
Inverter communication	Controlling Mitsubishi's FREQROL inverter using inverter communication instructions.

**1.2 Incorporated Items**

Verify that the following product and items are included in the package:

Product	FX3U-485ADP communication special adapter
Accessories	Label for indication of link station number Installation manual (This manual)

The label should be applied on the front of 485ADP for checking station numbers in N:N network, computer link, etc.

**1.3 External Dimensions and Part Names**

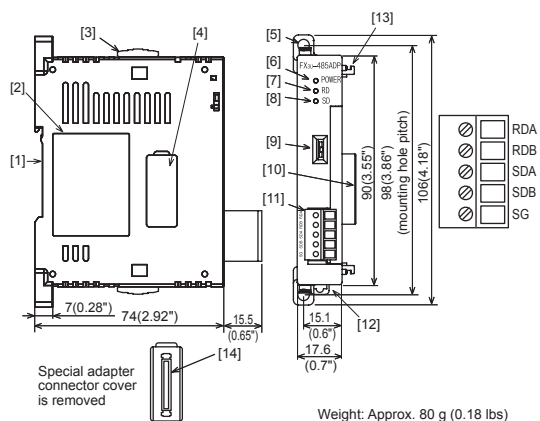

Weight: Approx. 80 g (0.18 lbs)

**3.1 Connection to the PLC**

This section describes the connection method to the PLC (FX3U Series PLC is used for the following example). For installation method to other PLCs, refer to the respective PLC User's manual Hardware Edition.

**Procedure**

- Turn off the power. Disconnect all the cables connected to the PLC main unit and special adapter, and demount the main unit and special adapter mounted on DIN rail or mounted directly using screws.
- Install an expansion board to the main unit. For the expansion board installation procedure, refer to the following manual: → FX3U Series User's Manual - Hardware Edition
- Remove the special adapter connector cover on the expansion board (fig.A). When connecting this product to another special adapter, please replace the 'expansion board' in the above description with a 'special adapter' and perform the procedure as indicated.
- Slide the special adapter side lock (fig.B) of the main unit. When connecting this product to another special adapter, please replace the 'main unit' in the above description with a 'special adapter' and perform the procedure as indicated. (Please replace the following procedures similarly.)
- Connect the special adapter (fig.C) to the main unit as shown on the right.
- Slide back the special adapter side lock (fig.B) of the main unit to fix the special adapter (fig.C).

**Connection precautions**

Connect all the high-speed I/O special adapters before connecting other special adapters when they are used in combination. Do not connect a high-speed I/O special adapter on the left side of any special adapters other than other high-speed I/O special adapters.

- DIN rail mounting groove (DIN rail: DIN46277)
- Name plate
- Special adapter slide lock: Used to connect additional special adapters onto left side of this special adapter.
- Special adapter connector cover: Remove this cover to connect additional special adapters on the left side.
- Direct mounting hole: 2 holes of  $\phi 4.5$  (0.18") (mounting screw: M4 screw) Not used when connecting to FX3GC/FX3UC Series PLC.
- POWER LED (green): Lit while 5 V DC power is supplied from main unit.
- RD LED (red): Lit while receiving data from connected RS-485 device.
- SD LED (red): Lit while sending data to connected RS-485 device.
- Terminal resistor selector switch (330 $\Omega$ /OPEN/110 $\Omega$ )
- Special adapter connector: Used to connect this special adapter to PLC main unit or special adapter.
- Terminal block (European type) for connecting RS-485 device Use to connect RS-485 device to 485ADP.
- DIN rail mounting hook
- Special adapter fixing hook
- Special adapter connector: Used to connect communication or analog special adapter to the left side of the 485ADP.

**1.4 Terminal Configuration**

The terminal configuration of the RS-485 terminal on the 485ADP is shown below. Note that the terminal configuration is different from that of the FX3U-485-BD.

Terminal screws	Signal name	Function	Signal direction	
			485ADP	RS-485 equipment
RDA (RXD+)	RDA (RXD+)	Receive data		←
RDB (RXD-)	RDB (RXD-)	Receive data		←
SDA (TXD+)	SDA (TXD+)	Send data	→	
SDB (TXD-)	SDB (TXD-)	Send data	→	
SG (GND)	SG (GND)	Signal ground		-

**1.5 Terminal Resistor Selector Switch**

485ADP has a built-in terminal resistor. A terminal resistor may be required depending on the communication type. Refer to the following manual for the terminal resistor setting. → FX Series User's Manual - Data Communication Edition

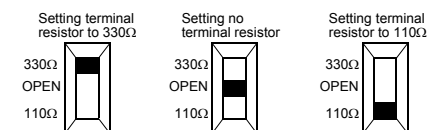

**1.6 Operation of Terminal Resistor Selector Switch**

Use the tip of tweezers, tip of mechanical pencil, minute screwdriver, or the tool whose tip width is about 0.8 mm (0.03") when operating the terminal resistor selector switch.

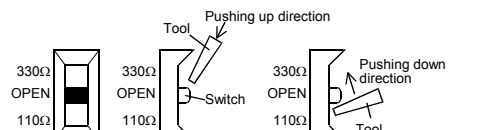

Either 'push down' or 'push up' the switch to change the setting as indicated in the figure above. Confirm the clicking noise when setting the switch.

**4. Wiring**

For wiring details, refer to the following manual. → FX Series User's Manual - Data Communication Edition

**WIRING PRECAUTIONS** **WARNING**

- Make sure to cut off all phases of the power supply externally before attempting installation or wiring work. Failure to do so may cause electric shock or damage to the product.

**WIRING PRECAUTIONS** **CAUTION**

- When drilling screw holes or wiring, make sure cutting or wire debris does not enter the ventilation slits. Failure to do so may cause fire, equipment failures or malfunctions.
- Make sure to observe the following precautions in order to prevent any damage to the machinery or accidents due to abnormal data written to the PLC under the influence of noise:
  - Do not bundle the main circuit line together with or lay it close to the main circuit, high-voltage line or load line. Otherwise, noise disturbance and/or surge induction are likely to take place. As a guideline, lay the control line at least 100mm (3.94") or more away from the main circuit or high-voltage lines.
  - Ground the shield wire or shield of the shielded cable at one point on the PLC. However, do not use common grounding with heavy electrical systems.
- Make sure to properly wire to the terminal block (European type) in accordance with the following precautions. Failure to do so may cause electric shock, equipment failures, a short-circuit, wire breakage, malfunctions, or damage to the product.
  - The disposal size of the cable end should follow the dimensions described in the manual of the PLC main unit.
  - Tightening torque should follow the specifications in the manual of the PLC main unit.
  - Twist the end of strand wire and make sure that there are no loose wires.
  - Do not solder-plate the electric wire ends.
  - Do not connect more than the specified number of wires or electric wires of unspecified size.
  - Affix the electric wires so that neither the terminal block nor the connected parts are directly stressed.

- Do not attach the terminal block (replacement European terminal block) for connecting RS-485 device which is already wired to FX3U-485-BD. If attached as its left and right are confused, the terminal configuration becomes upside down and no communication is performed.

**5. Specifications**

**STARTUP AND MAINTENANCE PRECAUTIONS** **CAUTION**

- Do not disassemble or modify the PLC. Doing so may cause fire, equipment failures, or malfunctions. \* For repair, contact your local Mitsubishi Electric representative.
- Do not drop the product or exert strong impact to it. Doing so may cause damage.

**DISPOSAL PRECAUTIONS** **CAUTION**

- Please contact a certified electronic waste disposal company for the environmentally safe recycling and disposal of your device.

**TRANSPORTATION AND STORAGE PRECAUTIONS** **CAUTION**

- The product is a precision instrument. During transportation, avoid any impacts. Failure to do so may cause failures in the product. After transportation, verify the operations of the product.

**5.1 Applicable PLC**

Model name	Applicability
FX3S Series PLC	Ver. 1.00 or later (from first production)
FX3G Series PLC	Ver. 1.00 or later (from first production)
FX3GC Series PLC	Ver. 1.40 or later (from first production)
FX3U Series PLC	Ver. 2.20 or later (from first production)
FX3UC Series PLC	Ver. 1.00 or later (from first production)

The version number can be checked by monitoring D8001/D8101 as the last three digits indicate it.

**2. Channel Allocation**

Up to two communication ports can be added to the main unit. Refer to the following manual for equipment that occupies communication ports. → FX Series User's Manual - Data Communication Edition

**FX3S Series PLC**

Communication port channels are automatically allocated.

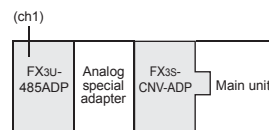

**FX3G Series PLC**

Communication port channels are automatically allocated.

- 40-point, 60-point type

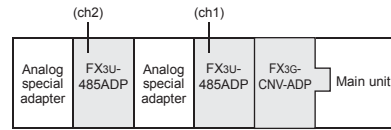

- 14-point, 24-point type

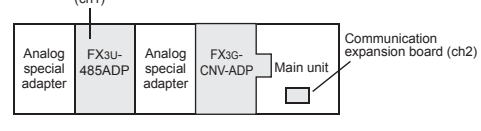

- 14-point, 24-point type

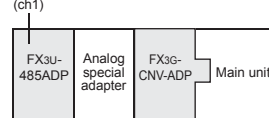

**FX3GC Series PLC**

Communication port channels are automatically allocated. The communication special adapter closer to the main unit is ch1.

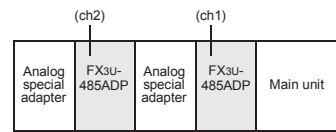

**5.2 General Specifications**

Items other than the following are equivalent to those of the PLC main unit. For general specifications, refer to the respective PLC User's manual Hardware Edition.

Item	Specification
Dielectric withstand voltage	500 V AC, one minute
Insulation resistance	5 M $\Omega$ or more by 500 V DC megger

**5.3 Power Supply Specifications**

Item	Specification
Current consumption	20 mA 5 V DC power is supplied from the internal power supply of main unit.

**5.4 Performance Specification**

Item	Specification
Transmission standard	Conforming to RS-485/RS-422
Type of isolation	Photocoupler isolation
Transmission distance	Total extension distance: 500 m (1640' 5") or less [50 m (164' 0") or less if FX1N-485-BD, FX2N-485-BD or FX3G-485-BD, FX3U-485-BD is installed to connected equipment]
Connection method	European type terminal block, AWG 22-20 (when inserting one twisted pair cable), AWG 22 (when inserting two twisted pair cables) Tightening torque: 0.22 to 0.25 N·m
Number of occupied I/O points	0 point (This number is not related to the maximum number of input/output points of the PLC.)
Communication method	Half-duplex
Baud rate	N:N network: 38400 bps Parallel Link: 115200 bps Computer Link, Non-Protocol Communication: 300/600/1200/2400/4800/9600/19200/38400 <sup>1</sup> bps Inverter communication: 4800/9600/19200/38400 <sup>1</sup> bps
Communication format	N:N network, Parallel Link Computer Link (dedicated protocol: format 1/format 4), Non-Protocol, and Inverter communication
LED display: LED color	Power: green, RD: red, SD: red

<sup>1</sup> Applicable for FX3U/FX3UC Series PLC Ver. 2.41 or later and FX3S/FX3G/FX3GC Series PLC.

This manual confers no industrial property rights or any rights of any other kind, nor does it confer any patent licenses. Mitsubishi Electric Corporation cannot be held responsible for any problems involving industrial property rights which may occur as a result of using the contents noted in this manual.

**Warranty**  
Mitsubishi will not be held liable for damage caused by factors found not to be the cause of Mitsubishi; opportunity loss or lost profits caused by faults in the Mitsubishi products; damage, secondary damage, accident compensation caused by special factors unpredictable by Mitsubishi; damages to products other than Mitsubishi products; and to other duties.

**For safe use**

- This product has been manufactured as a general-purpose part for general industries, and has not been designed or manufactured to be incorporated in a device or system used in purposes related to human life.
- Before using the product for special purposes such as nuclear power, electric power, aerospace, medicine or passenger movement vehicles, consult with Mitsubishi Electric.
- This product has been manufactured under strict quality control. However when installing the product where major accidents or losses could occur if the product fails, install appropriate backup or failsafe functions in the system.