

Programmable Controller

MELSEC iQ-F
series

MELSEC iQ-F

FX5 Positioning Module Function Block Reference



SAFETY PRECAUTIONS

(Read these precautions before use.)

Before using this product, please read this reference and the relevant manuals introduced in this reference carefully and pay full attention to safety in order to handle the product correctly.

The precautions given in this reference are concerned with this product only. For the safety precautions of the programmable controller system, refer to the User's Manual (Hardware) of the CPU module used.

This reference classifies the safety precautions into two categories: "⚠️ WARNING" and "⚠️ CAUTION".

 WARNING	Indicates that incorrect handling may cause hazardous conditions, resulting in death or severe injury.
 CAUTION	Indicates that incorrect handling may cause hazardous conditions, resulting in minor or moderate injury or property damage.

Depending on the circumstances, procedures indicated by "⚠️ CAUTION" may also cause severe injury.

It is important to follow all precautions for personal safety.

Store this manual in a safe place so that it can be read whenever necessary. Always forward it to the end user.

INTRODUCTION

Thank you for purchasing the Mitsubishi MELSEC iQ-F series programmable controllers. This reference will guide the reader in module FBs for following target modules. Before using this product, please read this manual and the relevant manuals introduced in this specifications carefully and pay attention to safety in order to handle the product correctly. Always forward it to the end user.

Relevant products

FX5-20PG-P

FX5-20PG-D

Regarding use of this product

- This product has been manufactured as a general-purpose part for general industries, and has not been designed or manufactured to be incorporated in a device or system used in purposes related to human life.
- Before using the product for special purposes such as nuclear power, electric power, aerospace, medicine or passenger movement vehicles, consult Mitsubishi Electric.
- This product has been manufactured under strict quality control. However when installing the product where major accidents or losses could occur if the product fails, install appropriate backup or failsafe functions into the system.

Note

- If in doubt at any stage during the installation of the product, always consult a professional electrical engineer who is qualified and trained to the local and national standards. If in doubt about the operation or use, please consult your local Mitsubishi Electric representative.
- Mitsubishi Electric will not accept responsibility for actual use of the product based on these illustrative examples. Please use it after confirming the function and safety of the equipment and system.
- The content, specification etc. of this manual may be changed, for improvement, without notice.
- The information in this manual has been carefully checked and is believed to be accurate; however, if you notice a doubtful point, an error, etc., please contact your local Mitsubishi Electric representative.

CONTENTS

SAFETY PRECAUTIONS	1
INTRODUCTION	2
RELEVANT MANUALS	6
TERMS	6
GENERIC TERMS AND ABBREVIATIONS	7
CHAPTER 1 OVERVIEW	8
1.1 Function Block (FB) List	8
1.2 How to Obtain	8
1.3 System Configuration	9
CHAPTER 2 POSITIONING MODULE FB	10
2.1 M+FX5PG_SetPositioningData (Positioning data setting)	10
Overview	10
Labels	10
FB details	14
Parameter setting	16
Example of use	16
Performance value	17
Error code	17
2.2 M+FX5PG_StartPositioning (Positioning start)	18
Overview	18
Labels	18
FB details	19
Parameter setting	21
Example of use	21
Performance value	21
Error code	21
2.3 M+FX5PG_JOG (JOG operation or inching operation)	22
Overview	22
Labels	22
FB details	23
Parameter setting	25
Performance value	26
Error code	26
2.4 M+FX5PG_MPG (Manual pulse generator operation)	27
Overview	27
Labels	27
FB details	28
Parameter setting	30
Performance value	30
Error code	30
2.5 M+FX5PG_ChangeSpeed (Speed change)	31
Overview	31
Labels	31
FB details	32
Parameter setting	33
Performance value	34

	Error code	34
2.6	M+FX5PG_ChangeAccDecTime (Acceleration/deceleration time change)	35
	Overview	35
	Labels	35
	FB details.....	36
	Parameter setting	38
	Performance value	38
	Error code	39
2.7	M+FX5PG_ChangePosition (Target position change)	40
	Overview	40
	Labels	40
	FB details.....	42
	Parameter setting	44
	Performance value	44
	Error code	44
2.8	M+FX5PG_Restart (Positioning restart)	45
	Overview	45
	Labels	45
	FB details.....	46
	Parameter setting	47
	Performance value	48
	Error code	48
2.9	M+FX5PG_OperateError (Error operation)	49
	Overview	49
	Labels	49
	FB details.....	50
	Parameter setting	53
	Performance value	53
	Error code	53
2.10	M+FX5PG_InitializeParameter (Parameter initialization)	54
	Overview	54
	Labels	54
	FB details.....	55
	Parameter setting	56
	Performance value	56
	Error code	56
2.11	M+FX5PG_WriteFlash (Flash ROM writing)	57
	Overview	57
	Labels	57
	FB details.....	58
	Parameter setting	59
	Performance value	59
	Error code	59
2.12	M+FX5PG_ABRST (Absolute position restoration)	60
	Overview	60
	Labels	60
	FB details.....	61
	Parameter setting	63
	Performance value	63
	Error code	63
2.13	M+FX5PG_StartAddressOffsetPositioning (Address offset positioning)	64

Overview	64
Labels	64
FB details.....	66
Parameter setting	69
Performance value	69
Error code	70
2.14 M+FX5PG_SetTimeOffsetPositioning (Time offset positioning).....	71
Overview	71
Labels	71
FB details.....	72
Parameter setting	76
Performance value	76
Error code	77
CHAPTER 3 EXAMPLE OF USE	78
<hr/>	
3.1 M+FX5PG_StartPositioning (Positioning start)	78
When the parameters are used	78
When the public labels are used	80
INSTRUCTION INDEX	83
<hr/>	
REVISIONS	85
TRADEMARKS	86

RELEVANT MANUALS

Manual name <manual number>	Description
MELSEC iQ-F FX5S/FX5UJ/FX5U/FX5UC User's Manual (Hardware) <SH-082452ENG>	Describes the details of hardware of the CPU module, including performance specifications, wiring, installation, and maintenance.
MELSEC iQ-F FX5 User's Manual (Application) <JY997D55401>	Describes basic knowledge required for program design, functions of the CPU module, devices/labels, and parameters.
MELSEC iQ-F FX5 Programming Manual (Program Design) <JY997D55701>	Describes specifications of ladders, ST, FBD/LD, and other programs and labels.
MELSEC iQ-F FX5 Programming Manual (Instructions, Standard Functions/Function Blocks) <JY997D55801>	Describes specifications of instructions and functions that can be used in programs.
MELSEC iQ-F FX5 Positioning Module User's Manual <SH-081805ENG>	Describes the positioning module.
GX Works3 Operating Manual <SH-081215ENG>	Describes the system configuration, parameter settings, and online operations of GX Works3.

TERMS

Unless otherwise specified, this manual uses the following terms.

Terms	Description
JOG operation	Pulses are output to the drive module only while the JOG start signal is on. The drive module drives the motor according to the input pulse count.
M code	Set to issue commands to perform auxiliary operations (stop of clamp or drill, replacement of tools, etc.) corresponding to code numbers in association with the execution of positioning data.
Md	Monitor data in the buffer memory address.
Inching operation	A control method for outputting pulses for a small travel distance by manual operation.
Engineering tool	A tool used for setting up programmable controllers, programming, debugging, and maintenance.
Manual pulse generator operation	Pulses are output to the drive module from a device that generates pulses by turning the handle by hand. The drive module drives the motor according to the input pulse count.
Dwell time	Time until the completion flag turns on after the completion of positioning motion.
Interpolation operation	Motions synthesized by synchronously operating multiple motors for positioning .
Module label	A label that represents one of memory areas (I/O signals and buffer memory areas) specific to each module in a given character string. For the module used, GX Works3 automatically generates this label, which can be used as a global label.

GENERIC TERMS AND ABBREVIATIONS

Unless otherwise specified, this manual uses the following generic terms and abbreviations.

Generic terms and abbreviations	Description
FB	FB is the abbreviation for function block, in which the circuit blocks used repeatedly in a sequence program are broken down into parts so that the parts can be used for other purposes in the sequence program. This improves the program development efficiency, reduces program errors and improves the program quality.
FX5 CPU module	Generic term for FX5UJ CPU module, FX5U CPU module and FX5UC CPU module
FX5U CPU module	Generic term for FX5U-32MR/ES, FX5U-32MT/ES, FX5U-32MT/ESS, FX5U-64MR/ES, FX5U-64MT/ES, FX5U-64MT/ESS, FX5U-80MR/ES, FX5U-80MT/ES, FX5U-80MT/ESS, FX5U-32MR/DS, FX5U-32MT/DS, FX5U-32MT/DSS, FX5U-64MR/DS, FX5U-64MT/DS, FX5U-64MT/DSS, FX5U-80MR/DS, FX5U-80MT/DS, and FX5U-80MT/DSS
FX5UC CPU module	Generic term for FX5UC-32MT/D, FX5UC-32MT/DSS, FX5UC-64MT/D, FX5UC-64MT/DSS, FX5UC-96MT/D, FX5UC-96MT/DSS, FX5UC-32MT/DS-TS, FX5UC-32MT/DSS-TS, and FX5UC-32MR/DS-TS
FX5UJ CPU module	Generic term for FX5UJ-24MR/ES, FX5UJ-24MT/ES, FX5UJ-24MT/ESS, FX5UJ-24MR/DS, FX5UJ-24MT/DS, FX5UJ-24MT/DSS, FX5UJ-40MR/ES, FX5UJ-40MT/ES, FX5UJ-40MT/ESS, FX5UJ-40MR/DS, FX5UJ-40MT/DS, FX5UJ-40MT/DSS, FX5UJ-60MR/ES, FX5UJ-60MT/ES, FX5UJ-60MT/ESS, FX5UJ-60MR/DS, FX5UJ-60MT/DS, and FX5UJ-60MT/DSS

1 OVERVIEW

The FBs listed in this reference are module FBs (for GX Works3) to use the MELSEC iQ-F series positioning module.

1.1 Function Block (FB) List

Shown below is the list of the module FBs cited in this reference.



Note that this reference does not describe the FB version information which is displayed such as "_00A" at the end of FB name.

Positioning module FB

○: Required, —: Not required

Name	Description	Necessity of parameter setting
M+FX5PG_SetPositioningData (Positioning data setting)	Sets positioning data (Da.1 to Da.10, Da.27 to Da.29).	○
M+FX5PG_StartPositioning (Positioning start)	Starts the positioning operation.	○
M+FX5PG_JOG (JOG operation or inching operation)	Performs the JOG operation or inching operation.	—
M+FX5PG_MPG (Manual pulse generator operation)	Performs the manual pulse generator operation.	—
M+FX5PG_ChangeSpeed (Speed change)	Changes the speed.	—
M+FX5PG_ChangeAccDecTime (Acceleration/deceleration time change)	Changes the acceleration/deceleration time during speed change.	—
M+FX5PG_ChangePosition (Target position change)	Changes the target position.	—
M+FX5PG_Restart (Positioning restart)	Restarts an axis that has stopped.	—
M+FX5PG_OperateError (Error operation)	Monitors errors and warnings, and resets errors.	—
M+FX5PG_InitializeParameter (Parameter initialization)	Initializes parameters.	—
M+FX5PG_WriteFlash (Flash ROM writing)	Writes positioning data and block start data in the buffer memory to the flash ROM.	—
M+FX5PG_ABRST (Absolute position restoration)	Restores the absolute position.	—
M+FX5PG_StartAddressOffsetPositioning (Address offset positioning)	The following axis starts after the preceding axis has started and moved the set movement amount.	—
M+FX5PG_SetTimeOffsetPositioning (Time offset positioning)	The following axis starts after the set time has elapsed from the start of the preceding axis.	—

1.2 How to Obtain

The positioning module FB described in this reference manual are incorporated into GX Works3^{*1}. For using the module FBs, refer to the GX Works3 Operating Manual.

*1 Use appropriate GX Works3 compatible with the module FB used.

1.3 System Configuration

System configurations to use the module FBs for this reference is shown below.

Positioning module FB

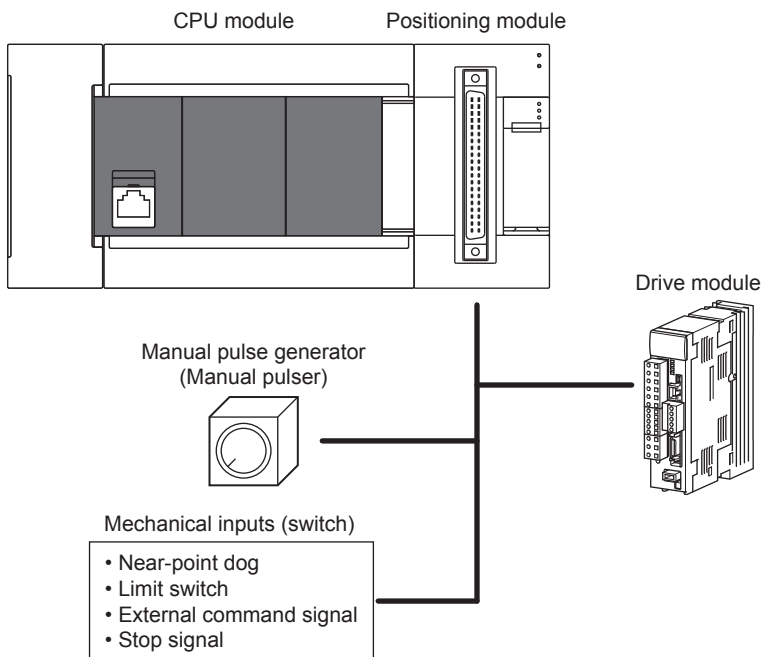

For specifications of the module used, refer to the user's manual of each module.

2 POSITIONING MODULE FB

2.1 M+FX5PG_SetPositioningData (Positioning data setting)

Overview

Sets positioning data (Da.1 to Da.10, Da.27 to Da.29).

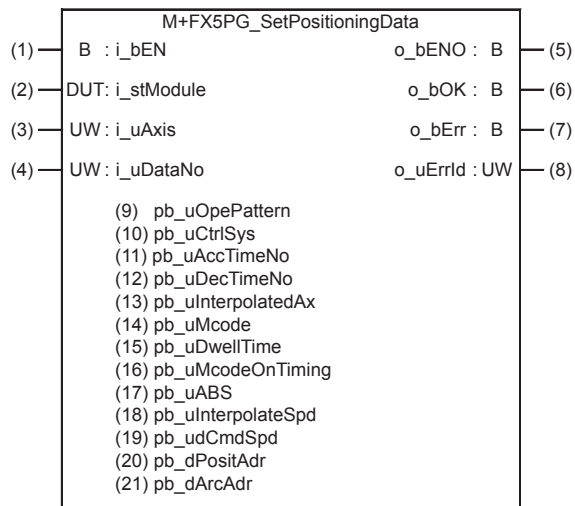

Labels

Input label

No.	Variable name	Name	Data type	Range	Description
(1)	i_bEN	Execution command	Bit	ON, OFF	ON: The FB is activated. OFF: The FB is not activated.
(2)	i_stModule	Module label	Structure	The setting range differs depending on the module label.	Specifies the module label for the positioning module.
(3)	i_uAxis	Target axis	Word [Unsigned]/Bit String [16-bit]	1 to 4	Specify the axis number. The setting range varies according to the positioning module in use.
(4)	i_uDataNo	Positioning data No.	Word [Unsigned]/Bit String [16-bit]	1 to 600	Specify the positioning data No.

Output label

No.	Variable name	Name	Data type	Default value	Description
(5)	o_bENO	Execution status	Bit	OFF	ON: The execution command is ON. OFF: The execution command is OFF.
(6)	o_bOK	Normal completion	Bit	OFF	When this label is ON, it indicates that the positioning data setting has been completed.
(7)	o_bErr	Error completion	Bit	OFF	When this label is ON, it indicates that an error has occurred in the FB.
(8)	o_uErrId	Error code	Word [Unsigned]/Bit String [16-bit]	0	Stores the error code that occurred in the FB.

Public label

No.	Variable name	Name	Data type	Range	Description
(9)	pb_uOpePattern	Da.1: Operation pattern	Word [Unsigned]/Bit String [16-bit]	0 to 1, 3	Specify whether the positioning is completed with the data being executed, or continues with the following data. When 4 or higher, which is out of the setting range, is specified, b0 and 1 are enabled. For example, when 4 is set, 0 is applied. 0: Positioning complete 1: Continuous positioning control 3: Continuous path control
(10)	pb_uCtrlSys	Da.2: Control method	Word [Unsigned]/Bit String [16-bit]	01H to 14H, 80H to 84H	Set the control method for performing the positioning control. 01H: ABS1 1-axis linear control (ABS) 02H: INC1 1-axis linear control (INC) 03H: FEED1 1-axis fixed-feed control 04H: VF1 1-axis speed control (forward run) 05H: VR1 1-axis speed control (reverse run) 06H: VPF Speed-position switching control (forward run) 07H: VPR Speed-position switching control (reverse run) 08H: PVF Position-speed switching control (forward run) 09H: PVR Position-speed switching control (reverse run) 0AH: ABS2 2-axis linear interpolation control (ABS) 0BH: INC2 2-axis linear interpolation control (INC) 0CH: FEED2 Fixed-feed control by 2-axis linear interpolation 0DH: ABS $\overset{\frown}{}$; Circular interpolation control with sub point specified (ABS) 0EH: INC $\overset{\frown}{}$; Circular interpolation control with sub point specified (INC) 0FH: ABS. Circular interpolation control with center point specified (ABS, CW) 10H: ABS. Circular interpolation control with center point specified (ABS, CCW) 11H: INC. Circular interpolation control with center point specified (INC, CW) 12H: INC. Circular interpolation control with center point specified (INC, CCW) 13H: VF2 2-axis speed control (forward run) 14H: VR2 2-axis speed control (reverse run) 80H: NOP NOP instruction 81H: POS Current value change 82H: JUMP JUMP instruction 83H: LOOP Beginning of LOOP-to-LEND processing 84H: LEND End of LOOP-to-LEND processing
(11)	pb_uAccTimeNo	Da.3: Acceleration time No.	Word [Unsigned]/Bit String [16-bit]	0 to 3	Set which acceleration time (0 to 3) to use for the acceleration time during positioning. When 4 or higher, which is out of the setting range, is specified, b0 and 1 are enabled. For example, when 4 is set, 0 is applied. 0: Acceleration time 0 1: Acceleration time 1 2: Acceleration time 2 3: Acceleration time 3
(12)	pb_uDecTimeNo	Da.4: Deceleration time No.	Word [Unsigned]/Bit String [16-bit]	0 to 3	Set which deceleration time (0 to 3) to use for the deceleration time during positioning. When 4 or higher, which is out of the setting range, is specified, b0 and 1 are enabled. For example, when 4 is set, 0 is applied. 0: Deceleration time 0 1: Deceleration time 1 2: Deceleration time 2 3: Deceleration time 3

No.	Variable name	Name	Data type	Range	Description
(13)	pb_uInterpolatedAx	Da.5: Axis to be interpolated	Word [Unsigned]/Bit String [16-bit]	0 to 1	Set the axis to be interpolated for performing the 2-axis interpolation operation. Values out of the setting range or the self-axis cannot be set as the axis to be interpolated. Set 0 when not using interpolation. 0: Axis 1 specification 1: Axis 2 specification
(14)	pb_uMcode	Da.10: M code	Word [Unsigned]/Bit String [16-bit]	0 to 10, 1 to 65535, 0 to 65535	Set the condition data No., number of repetitions, or M code for the control method. • Da.2: Control method 82H: JUMP instruction 0 to 10 • Da.2: Control method 83H: LOOP 1 to 65535 • Da.2: Control method other than above 0 to 65535
(15)	pb_uDwellTime	Da.9: Dwell time	Word [Unsigned]/Bit String [16-bit]	1 to 600, 0 to 65535	Set the positioning data No. or dwell time for the control method. • Da.2: Control method 82H: JUMP instruction 1 to 600 • Da.2: Control method other than JUMP instruction 0 to 65535
(16)	pb_uMcodeOnTiming	Da.27: M code On signal output timing	Word [Unsigned]/Bit String [16-bit]	0 to 2	Set the timing to output the M code On signal. When 4 or higher is set, b0 and 1 are enabled. For example, when 4 is set, 0 is applied. 0: Setting value of Pr.18: M code On signal output timing 1: WITH mode 2: AFTER mode
(17)	pb_uABS	Da.28: ABS direction in degrees	Word [Unsigned]/Bit String [16-bit]	0 to 3	Set the ABS movement direction for the position control when the unit is degree. When 4 or higher, which is out of the setting range, is specified, b0 and 1 are enabled. For example, when 4 is set, 0 is applied. 0: Setting value of Cd.40: ABS direction in degrees 1: ABS clockwise 2: ABS counterclockwise 3: Shortcut (the direction setting is invalid)
(18)	pb_uInterpolateSpd	Da.29: Interpolation speed specification method	Word [Unsigned]/Bit String [16-bit]	0 to 2	When performing linear interpolation/circular interpolation, set whether to specify the composite speed or the speed for the reference axis. When 8 or higher is set, only b0, b1, and b2 are valid. For example, when 8 is set, 0 is applied. 0: Setting value of Pr.20: Interpolation speed specification method 1: Composite speed 2: Reference axis speed
(19)	pb_udCmdSpd	Da.8: Command speed	Double Word [Unsigned]/Bit String [32-bit]	1 to 2000000000, 1 to 3000000000, 1 to 5000000	Set the command speed for positioning. • Pr.1: Unit setting 0, 1 1 to 2000000000 • Pr.1: Unit setting 2 1 to 3000000000 • Pr.1: Unit setting 3 1 to 5000000
				FFFFFFFFH	The speed set for the previous positioning data No. is used for the positioning control. • Current speed FFFFFFFFH (Speed set for the previous positioning data No.)

No.	Variable name	Name	Data type	Range	Description
(20)	pb_dPositAdr	Da.6: Positioning address	Double word [Signed]	-2147483648 to 2147483647, 0 to 35999999, 0 to 2147483647	Specify the target position or movement amount for the positioning control. The setting value differs depending on the control method. <ul style="list-style-type: none"> • Pr.1: Unit setting 0, 1, 3 • Da.2: Control method 06H to 09H 0 to 2147483647 • Da.2: Control method other than 06H to 09H -2147483648 to 2147483647 • Pr.1: Unit setting 2 • Da.2: Control method 01H, 0AH, 81H 0 to 35999999 • Da.2: Control method 02H, 0BH, 03H, 0CH -2147483648 to 2147483647 • Da.2: Control method 06H, 07H 0 to 2147483647 (INC mode) 0 to 35999999 (ABS mode) • Da.2: Control method 08H, 09H 0 to 2147483647
(21)	pb_dArcAdr	Da.7: Arc address	Double word [Signed]	-2147483648 to 2147483647, 0	Use this label only when performing the circular interpolation control. For the sub point specification, set the sub point address. For the center point specification, set the center point address of the arc. <ul style="list-style-type: none"> • Pr.1: Unit setting 0, 1, 3 -2147483648 to 2147483647 • Pr.1: Unit setting 2 Not used (Set 0.)

Module label

Buffer Memory Addresses	Name (Comment)	Label name	Data type	Initial value	Range	R/W	Description
H1	Module number	FX5PG_□.uIO	Word [Unsigned]/Bit String [16-bit]	0	1 to 16	R	Set the module number.

FB details

Available device

■Positioning module

Target module	Firmware Version	Engineering tool
FX5-20PG-P	—	GX Works3 Version 1.035M or later
FX5-20PG-D	—	GX Works3 Version 1.050C or later

■CPU module

MELSEC iQ-F series

Basic specifications

Item	Description
Language	Ladder diagram
Number of steps	274 steps The number of FB steps integrated in the program varies depending on the CPU module used, the input/output definition, and the setting options of GX Works3. For the setting options of GX Works3, refer to GX Works3 Operating Manual .
The amount of label usage	<ul style="list-style-type: none"> Label: 0.05 K point (Word) Latch label: 0 K point (Word) The amount of labels used in the program varies depending on the CPU module used, the device specified in an argument and the option setting of GX Works3. For the option setting of GX Works3, refer to GX Works3 Operating Manual .
The number of index register usage	<ul style="list-style-type: none"> Index register:0 point Long index register:0 point
The amount of file register usage	0 point
FB dependence	No dependence
FB compilation method	Macro type
FB operation	Pulsed execution (single scan execution type)

Processing

- By turning on i_bEN (Execution command), the set positioning data is written to the buffer memory.
- If the setting value of the target axis is out of the setting range, o_bErr (Error completion) turns on and the processing of this FB is interrupted. In addition, the error code 100 (hexadecimal) is stored in o_uErrId (Error code). For the error code, refer to [Page 17 Error code](#).
- If the setting value of the positioning data No. is out of the setting range, o_bErr (Error completion) turns on and the processing of this FB is interrupted. In addition, the error code 101 (hexadecimal) is stored in o_uErrId (Error code). For the error code, refer to [Page 17 Error code](#).
- The pulse output mode and external input/output signal logic, etc. must be set according to the connected devices and system before operating the positioning module. Set the GX Works3 module parameters according to the application. Refer to [Page 16 Parameter setting](#) for details on setting the module parameters.
- When setting or monitoring a public label, refer to [Page 16 Example of use](#). Designate a public label as "FB instance"."public label". The following program is designed to assign K0 to the open method (M_FX5PG_SetPositioningData_00A_1.pb_uOpePattern) to set an operation pattern for the end of positioning.

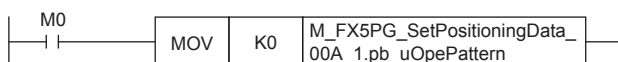

Timing chart of I/O signals

■For normal completion

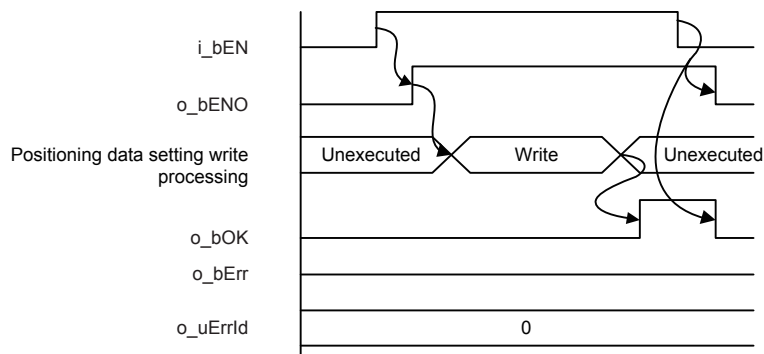

■For error completion

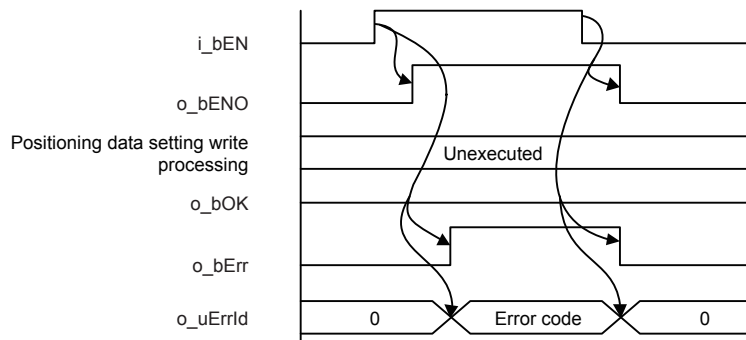

Restrictions or precautions

- This FB does not include the error recovery processing. Program the error recovery processing separately in accordance with the required system operation.
- This FB cannot be used in an interrupt program.
- Do not use this FB in programs that are executed only once, such as a subroutine program or FOR-NEXT loop, because i_bEN (Execution command) cannot be turned off and the normal operation cannot be acquired. Always use this FB in programs that can turn off i_bEN (Execution command).
- When this FB is used twice or more, precaution must be taken to avoid duplication of the target axis.
- Every input must be provided with a value for proper FB operation. Set a public label as needed.

Parameter setting

Navigation window ⇒ [Parameters] ⇒ [Module information] ⇒ [Target module] ⇒ [Module parameters]

For details, refer to MELSEC iQ-F FX5 Positioning Module User's Manual. The table of correspondence between module extended parameters and public labels is given below.

No.	1	2	3	4	5	6	7	8	9	10	11	12	13
1	0: Positioning corr. 01H: ABS 1: 1-a		2: Acceleration time 1; 2: Deceleration time 1					1 pulse/s	0 ms	0	0: Use the set value of M code C 1: ABS clockwise		
Positioning comment 2													
Positioning comment 3													
Positioning comment 4													

No.	Label name	Description
1	pb_uOpePattern	Specify whether the positioning is completed with the data being executed, or continues with the following data.
2	pb_uCtrlSys	Set the control method for performing the positioning control.
3	pb_uInterpolatedAx	Set the axis to be interpolated for performing the 2-axis interpolation operation.
4	pb_uAccTimeNo	Set which acceleration time (0 to 3) to use for the acceleration time during positioning.
5	pb_uDecTimeNo	Set which deceleration time (0 to 3) to use for the deceleration time during positioning.
6	pb_dPositAdr	Specify the target position or movement amount for the positioning control.
7	pb_dArcAdr	Use this label only when performing the circular interpolation control.
8	pb_udCmdSpd	Set the command speed for positioning.
9	pb_uDwellTime	Set the dwell time for the control method.
10	pb_uMcode	Set the M code for the control method.
11	pb_uMcodeOnTiming	Set the timing to output the M code On signal.
12	pb_uABS	In the case of the position control, set the ABS movement direction in degrees.
13	pb_uInterpolateSpd	Specify the synthesis rate for straight-line interpolation/circular interpolation.

Example of use

An example of the use of this FB is shown.

Outline of example of program (when the parameters are used)

When the parameters are used, the FB is not used.

Outline of example of program (when the public labels are used)

Refer to Page 80 When the public labels are used.

Performance value

CPU	Measurement conditions*3	Performance value		Number of scans
		Processing time	Maximum scan time	
FX5UJ	Axis 1 Positioning data 1	0.437 ms	0.788 ms	1 scan
FX5U, FX5UC*1*2	Axis 1 Positioning data 1	0.130 ms	0.581 ms	1 scan

*1 When the program capacity is set to 128 K steps, the processing speed may be reduced.

*2 The labels in the standard area are used.

*3 When measuring the performance values, set the positioning data No.1 as shown below.

Item name	Set value
Da.1: Operation pattern	K1
Da.2: Control method	H1
Da.3: Acceleration time No.	K3
Da.4: Deceleration time No.	K3
Da.5: Axis to be interpolated	K0
Da.10: M code	K1
Da.9: Dwell time	K1
Da.27: M code ON signal output timing	K0
Da.28: ABS direction in degrees	K1
Da.29: Interpolation speed specification method	K0
Da.8: Command speed	K100
Da.6: Positioning address	K1000
Da.7: Arc address	K0

Error code

Error code (hexadecimal)	Description	Action
100	The set value of i_uAxis (Target axis) is out of the range. The target axis is not within the range of 1 to 4.	Try again after checking the setting.
101	The set value of i_uDataNo (Positioning data No.) is out of the range. The positioning data No. is not within the range of 1 to 600.	Try again after checking the setting.

2.2 M+FX5PG_StartPositioning (Positioning start)

Overview

Starts the positioning operation.

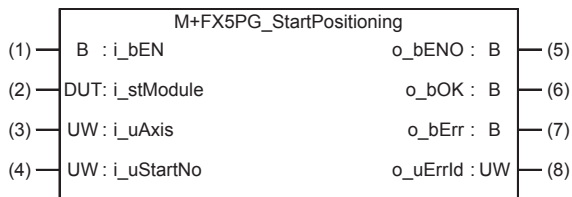

Labels

Input label

No.	Variable name	Name	Data type	Range	Description
(1)	i_bEN	Execution command	Bit	ON, OFF	ON: The FB is activated. OFF: The FB is not activated.
(2)	i_stModule	Module label	Structure	The setting range differs depending on the module label.	Specifies the module label for the positioning module.
(3)	i_uAxis	Target axis	Word [Unsigned]/Bit String [16-bit]	1 to 4	Specify the axis number. The setting range varies according to the positioning module in use.
(4)	i_uStartNo	Cd.3: Positioning start No.	Word [Unsigned]/Bit String [16-bit]	1 to 600, 7000 to 7004, 9001 to 9004	Set the positioning start No. corresponding to the control to be started in Cd.3: Positioning start No. 1 to 600: Positioning data No. 7000 to 7004: Block start specification 9001: Machine OPR 9002: Fast OPR 9003: Current value change 9004: Multiple axes simultaneous start

Output label

No.	Variable name	Name	Data type	Default value	Description
(5)	o_bENO	Execution status	Bit	OFF	ON: The execution command is ON. OFF: The execution command is OFF.
(6)	o_bOK	Normal completion	Bit	OFF	When this label is ON, it indicates that the positioning operation has been completed. However, this label does not turn on when a module error occurs at the start.
(7)	o_bErr	Error completion	Bit	OFF	When this label is ON, it indicates that an error has occurred in the FB.
(8)	o_uErrId	Error code	Word [Unsigned]/Bit String [16-bit]	0	Stores the error code that occurred in the FB.

Module label

Buffer Memory Addresses	Name (Comment)	Label name	Data type	Initial value	Range	R/W	Description
1500, 1600	RW: Positioning start No. (Direct)	FX5PG_□.stnAxisControlData_Axis_D[].uPositioningStartNo_D	Word [Unsigned]/ Bit String [16-bit]	0	1 to 600, 7000 to 7004, 9001 to 9004	R/W	Set the positioning start No. (Only 1 to 600 for the read-ahead start function)
31500.b0	R: READY (Direct)	FX5PG_□.stSystemMonitorData2_D.bReady_D	Bit	OFF	ON, OFF	R	Used for interlocking in a program.
31501.b0	R: BUSY (Direct)	FX5PG_□.stSystemMonitorData2_D.bnBusy_Axis_D[]	Bit	OFF	ON, OFF	R	Turns on at the start of positioning, origin return, and jogging.
30104, 30114	RW: Positioning start No. (Direct)	FX5PG_□.stnAxisControlData2_Axis_D[].uPositioningStart_D	Word [Unsigned]/ Bit String [16-bit]	0	0 to 1	R/W	Enabled at the startup to start.
817, 917	R: Status (Direct)	FX5PG_□.stnAxisMonitorData_Axis_D[].uStatus_D	Word [Unsigned]/ Bit String [16-bit]	0008H	—	R	Stores the ON/OFF status of each flag. b14: Completion of start Turns on at the start of positioning.

FB details

Available device



■ Positioning module

Target module	Firmware Version	Engineering tool
FX5-20PG-P	—	GX Works3 Version 1.035M or later
FX5-20PG-D	—	GX Works3 Version 1.050C or later

■ CPU module

MELSEC iQ-F series

Basic specifications

Item	Description
Language	Ladder diagram
Number of steps	263 steps The number of FB steps integrated in the program varies depending on the CPU module used, the input/output definition, and the setting options of GX Works3. For the setting options of GX Works3, refer to  GX Works3 Operating Manual.
The amount of label usage	<ul style="list-style-type: none"> Label: 0.01 K point (Word) Latch label: 0 K point (Word) The amount of labels used in the program varies depending on the CPU module used, the device specified in an argument and the option setting of GX Works3. For the option setting of GX Works3, refer to  GX Works3 Operating Manual.
The number of index register usage	<ul style="list-style-type: none"> Index register: 0 point Long index register: 0 point
The amount of file register usage	0 point
FB dependence	No dependence
FB compilation method	Macro type
FB operation	Pulsed execution (multiple scan execution type)

Processing

- By turning on i_bEN (Execution command), the control corresponding to i_uStartNo (Cd.3: Positioning start No.) is started.
- This FB is activated by turning on Positioning start signal (Cd.184: Positioning start signal).
- Only when all of the following conditions are satisfied, Positioning start signal (Cd.184: Positioning start signal) is turned on by turning on i_bEN (Execution command). If some of the conditions (even one condition) are not satisfied, o_bErr (Error completion) turns on and the processing of this FB is interrupted. In addition, the error code 200 (hexadecimal) is stored in o_uErrId (Error code). For the error code, refer to [Page 21 Error code](#). (The conditions are Positioning module ready signal (Md.140: Module status.b0): ON, Positioning start signal (Cd.184: Positioning start signal): OFF, Start complete signal (Md.31: Status.b14): OFF, and BUSY signal (Md.141: BUSY.b0, b1): OFF)
- When Start complete signal (Md.31: Status.b14) turns on or i_bEN (Execution command) is turned off, Positioning start signal (Cd.184: Positioning start signal) is turned off.
- If the setting value of the target axis is out of the setting range, o_bErr (Error completion) turns on and the processing of this FB is interrupted. In addition, the error code 100 (hexadecimal) is stored in o_uErrId (Error code). For the error code, refer to [Page 21 Error code](#).
- If the setting value of the positioning start No. is out of the setting range, o_bErr (Error completion) turns on and the processing of this FB is interrupted. In addition, the error code 102 (hexadecimal) is stored in o_uErrId (Error code). For the error code, refer to [Page 21 Error code](#).
- The pulse output mode and external input/output signal logic, etc. must be set according to the connected devices and system before operating the positioning module. Set the GX Works3 module parameters according to the application. Refer to [Page 16 Parameter setting](#) for details on setting the module parameters.

Timing chart of I/O signals

■For normal completion

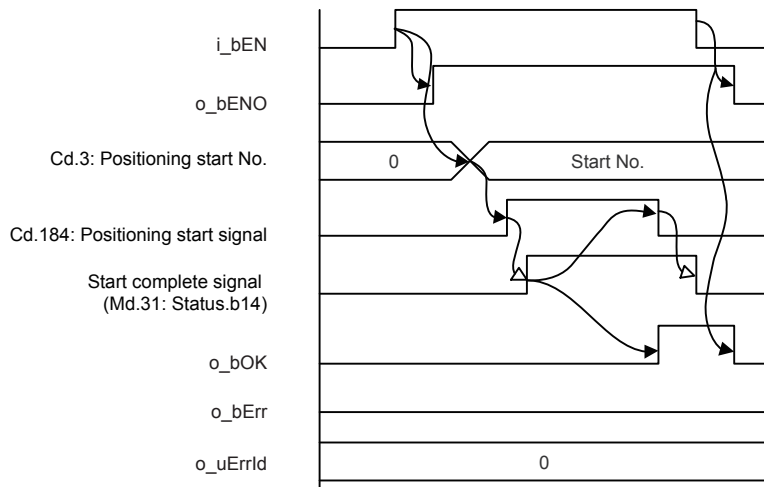

■For error completion

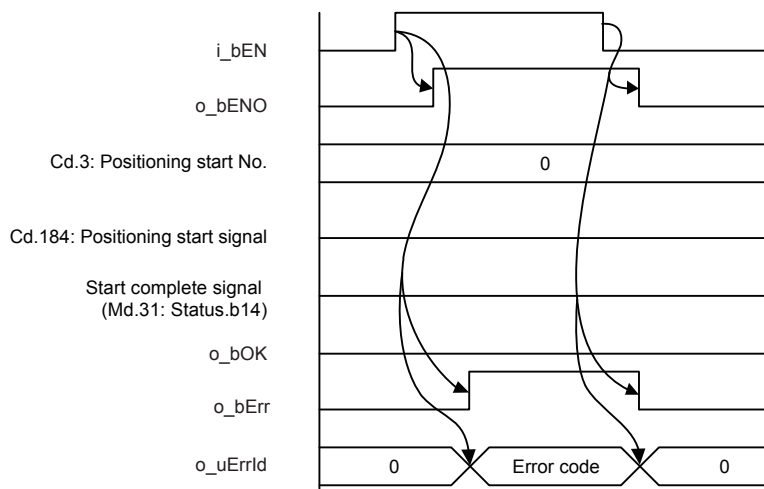

Restrictions or precautions

- This FB does not include the error recovery processing. Program the error recovery processing separately in accordance with the required system operation.
- This FB cannot be used in an interrupt program.
- Do not use this FB in programs that are executed only once, such as a subroutine program or FOR-NEXT loop, because i_bEN (Execution command) cannot be turned off and the normal operation cannot be acquired. Always use this FB in programs that can turn off i_bEN (Execution command).
- This FB turns on and off Positioning start signal (Cd.184: Positioning start signal). Thus, do not turn on and off Positioning start signal (Cd.184: Positioning start signal) by other means while this FB is being executed.
- When this FB is used twice or more, precaution must be taken to avoid duplication of the target axis.
- This FB does not set the data when started. Data required for controlling the start No. must be set on the parameter or buffer memory.
- Every input must be provided with a value for proper FB operation.

Parameter setting

Refer to  Page 16 Parameter setting.

Example of use

Outline of example of program (when the parameters are used)

Refer to  Page 78 When the parameters are used.

Outline of example of program (when the public labels are used)

Refer to  Page 80 When the public labels are used.

Performance value

CPU	Measurement conditions ^{*3}	Performance value		Number of scans
		Processing time	Maximum scan time	
FX5UJ	Axis 1 Positioning data 1	0.866 ms	0.964 ms	1 scan
FX5U, FX5UC ^{*1*2}	Axis 1 Positioning data 1	0.536 ms	0.739 ms	1 scan

*1 When the program capacity is set to 128 K steps, the processing speed may be reduced.

*2 The labels in the standard area are used.

*3 For the positioning data for measurement of the performance values, refer to  Page 17 Performance value. The current position at the start of measurement is 0.

Error code

Error code (hexadecimal)	Description	Action
100	The set value of i_uAxis (Target axis) is out of the range. The target axis is not within the range of 1 to 4.	Try again after checking the setting.
102	The set value of i_uStartNo (Cd.3: Positioning start No.) is out of the range. The positioning start No. is not within the range of 1 to 600, 7000 to 7004, and 9001 to 9004.	Try again after checking the setting.
200	The conditions for positioning start are not satisfied. Some of the following conditions are not satisfied. <ul style="list-style-type: none"> • Ready: ON • Positioning start signal: OFF • Start complete signal: OFF • BUSY signal: OFF 	Execute the FB again when all of the following conditions are satisfied. <ul style="list-style-type: none"> • Ready: ON • Positioning start signal: OFF • Start complete signal: OFF • BUSY signal: OFF

2.3 M+FX5PG_JOG (JOG operation or inching operation)

Overview

Performs the JOG operation or inching operation.

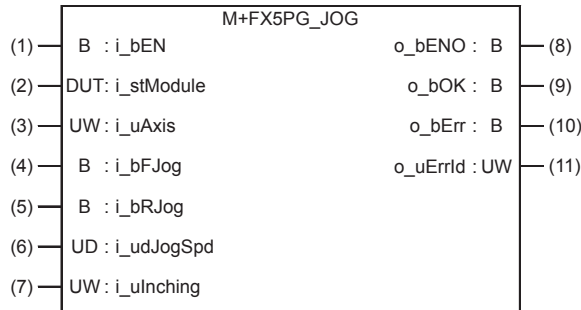

Labels

Input label

No.	Variable name	Name	Data type	Range	Description
(1)	i_bEN	Execution command	Bit	ON, OFF	ON: The FB is activated. OFF: The FB is not activated.
(2)	i_stModule	Module label	Structure	The setting range differs depending on the module label.	Specifies the module label for the positioning module.
(3)	i_uAxis	Target axis	Word [Unsigned]/Bit String [16-bit]	1 to 4	Specify the axis number. The setting range varies according to the positioning module in use.
(4)	i_bFJog	Forward run JOG command	Bit	ON, OFF	Turn on this label to perform the forward run JOG operation or forward inching operation.
(5)	i_bRJog	Reverse run JOG command	Bit	ON, OFF	Turn on this label to perform the reverse run JOG operation or reverse inching operation.
(6)	i_udJogSpd	Cd.17: JOG speed	Double Word [Unsigned]/Bit String [32-bit]	0 to 2000000000, 0 to 3000000000, 0 to 5000000	Specify the JOG speed. Set 0 for the inching operation. • Pr.1: Unit setting 0: mm 0 to 2000000000 ($\times 10^{-2}$ mm/min) • Pr.1: Unit setting 1: inch 0 to 2000000000 ($\times 10^{-3}$ inch/min) • Pr.1: Unit setting 2: degree 0 to 3000000000 ($\times 10^{-3}$ degree/min) • Pr.1: Unit setting 3: pulse 0 to 5000000 (pulse/s)
(7)	i_ulnching	Cd.16: Inching movement amount	Word [Unsigned]/Bit String [16-bit]	0 to 65535 0: JOG operation	Specify the inching movement amount. Set 0 for the JOG operation.

Output label

No.	Variable name	Name	Data type	Default value	Description
(8)	o_bENO	Execution status	Bit	OFF	ON: The execution command is ON. OFF: The execution command is OFF.
(9)	o_bOK	Normal completion	Bit	OFF	ON: The JOG command is ON. OFF The JOG command is OFF.
(10)	o_bErr	Error completion	Bit	OFF	When this label is ON, it indicates that an error has occurred in the FB.
(11)	o_uErrId	Error code	Word [Unsigned]/Bit String [16-bit]	0	Stores the error code that occurred in the FB.

Module label

Buffer Memory Addresses	Name (Comment)	Label name	Data type	Initial value	Range	R/W	Description
1517, 1617	RW: Inching movement amount (Direct)	FX5PG_□.stnAxisControlData_Axis_D[].uInchingMovementAmount_D	Word [Unsigned]/Bit String [16-bit]	0	0 to 65535	R/W	Set the inching distance. When the setting is 0, the object will operate in the JOG mode.
1518, 1519, 1618, 1619	RW: JOG speed (Direct)	FX5PG_□.stnAxisControlData_Axis_D[].uJogSpeed_D	Double Word [Unsigned]/Bit String [32-bit]	0	0 to 2000000000, 0 to 3000000000, 0 to 5000000	R/W	Set the jogging speed in the JOG mode.
30101, 30111	RW: Forward run JOG start (Direct)	FX5PG_□.stnAxisControlData2_Axis_D[].uForwardRunJogStart_D	Word [Unsigned]/Bit String [16-bit]	0	0 to 1	R/W	While the JOG start signal is on, the object operates in the JOG mode at "Cd.17JOG speed". When the JOG start signal is turned off, it will decelerate and stop.
30102, 30112	RW: Reverse run JOG start (Direct)	FX5PG_□.stnAxisControlData2_Axis_D[].uReverseRunJogStart_D	Word [Unsigned]/Bit String [16-bit]	0	0 to 1	R/W	While the JOG start signal is on, the object operates in the JOG mode at "Cd.17JOG speed". When the JOG start signal is turned off, it will decelerate and stop.
31500.b0	R: READY (Direct)	FX5PG_□.stSystemMonitorData2_D.bReady_D	Bit	OFF	ON, OFF	R	Used for interlocking in a program.
31501.b0	R: BUSY (Direct)	FX5PG_□.stSystemMonitorData2_D.bnBusy_Axis_D[]	Bit	OFF	ON, OFF	R	Turns on at the start of positioning, origin return, and jogging.

FB details

Available device



■ Positioning module

Target module	Firmware Version	Engineering tool
FX5-20PG-P	—	GX Works3 Version 1.035M or later
FX5-20PG-D	—	GX Works3 Version 1.050C or later

■ CPU module

MELSEC iQ-F series

Basic specifications

Item	Description
Language	Ladder diagram
Number of steps	238 steps The number of FB steps integrated in the program varies depending on the CPU module used, the input/output definition, and the setting options of GX Works3. For the setting options of GX Works3, refer to  GX Works3 Operating Manual.
The amount of label usage	<ul style="list-style-type: none"> Label: 0.01 K point (Word) Latch label: 0 K point (Word) The amount of labels used in the program varies depending on the CPU module used, the device specified in an argument and the option setting of GX Works3. For the option setting of GX Works3, refer to  GX Works3 Operating Manual.
The number of index register usage	<ul style="list-style-type: none"> Index register: 0 point Long index register: 0 point
The amount of file register usage	0 point
FB dependence	No dependence
FB compilation method	Macro type
FB operation	Always executed

Processing

- By turning on i_bFJog (Forward run JOG command) or i_bRJog (Reverse run JOG command) after i_bEN (Execution command) is turned on, the JOG operation or inching operation is performed.
- When i_bFJog (Forward run JOG command) and i_bRJog (Reverse run JOG command) are on at the same time, the operation stops.
- When i_bEN (Execution command) is turned off during the operation that has been started by i_bFJog (Forward run JOG command) or i_bRJog (Reverse run JOG command), the operation stops.
- When i_bRJog (Reverse run JOG command) is turned on during the forward run JOG operation, the operation stops. However, when i_bRJog (Reverse run JOG command) is turned on and off, the forward JOG operation restarts. (This relation is also applied to the reverse run JOG operation and i_bFJog (Forward run JOG command).)
- If the setting value of the target axis is out of the setting range, o_bErr (Error completion) turns on and the processing of this FB is interrupted. In addition, the error code 100 (hexadecimal) is stored in o_uErrId (Error code). For the error code, refer to [Page 26 Error code](#).

Timing chart of I/O signals

■For normal completion (Axis 1)

- Forward run JOG operation (Inching movement amount 0)

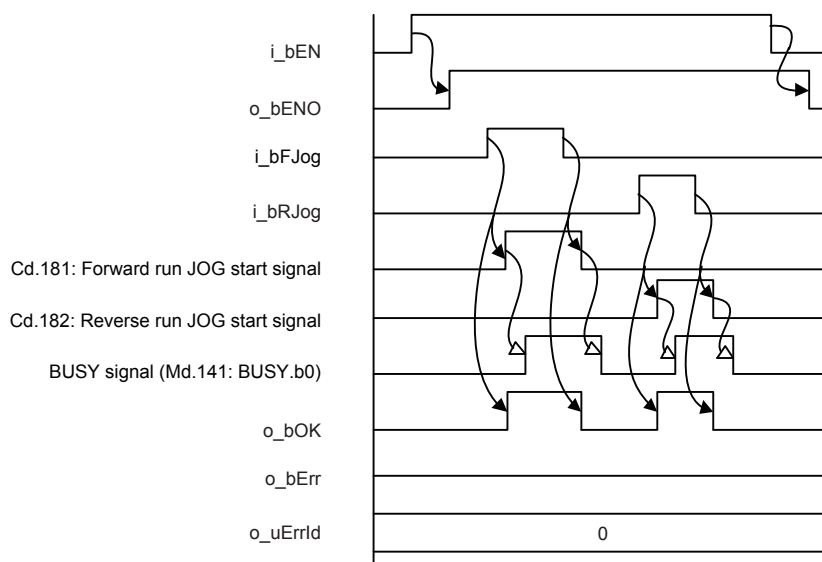

- Forward run inching operation (Inching movement amount other than 0)

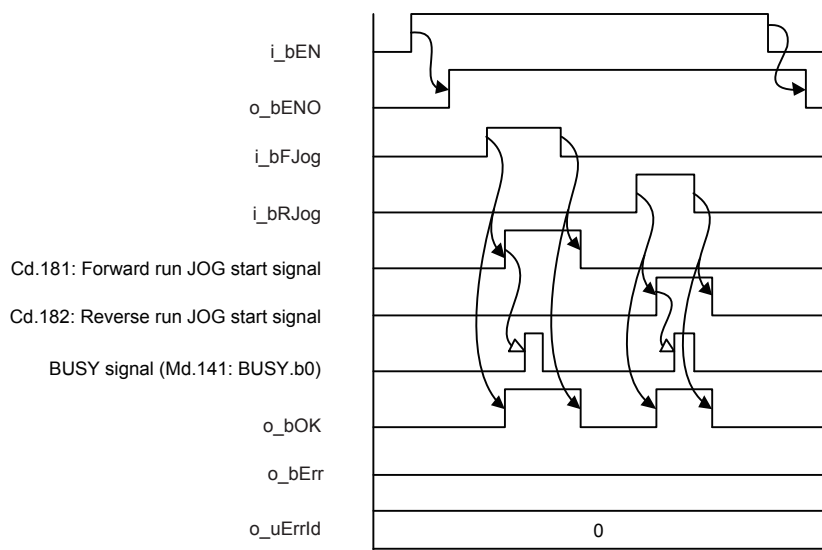

■ For error completion (Axis 1)

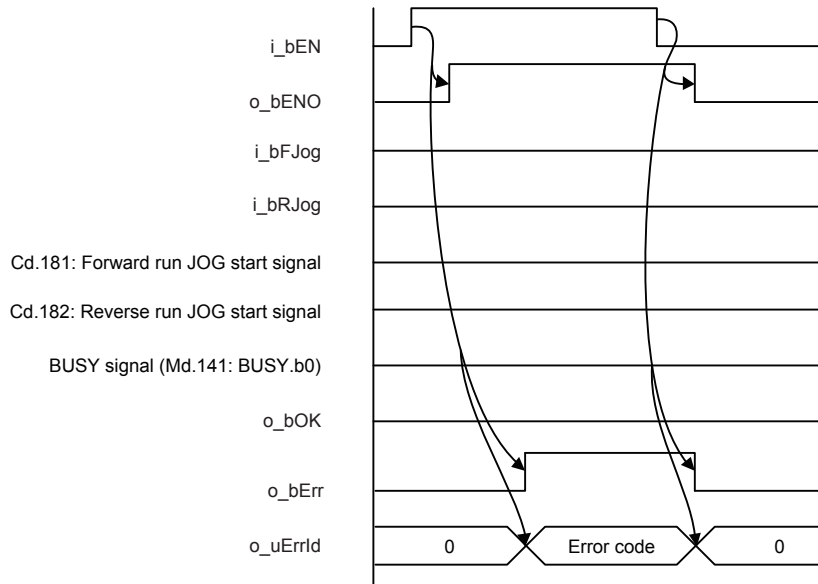

Restrictions or precautions

- This FB does not include the error recovery processing. Program the error recovery processing separately in accordance with the required system operation.
- This FB cannot be used in an interrupt program.
- Do not use this FB in programs that are executed only once, such as a subroutine program or FOR-NEXT loop, because i_bEN (Execution command) cannot be turned off and the normal operation cannot be acquired. Always use this FB in programs that can turn off i_bEN (Execution command).
- This FB turns on and off Forward run JOG start signal (Cd.181: Forward run JOG start signal) and Reverse run JOG start signal (Cd.182: Reverse run JOG start signal). Thus, do not turn on or off Forward run JOG start signal (Cd.181: Forward run JOG start signal) and Reverse run JOG start signal (Cd.182: Reverse run JOG start signal) by other means while this FB is being executed.
- When this FB is used twice or more, precaution must be taken to avoid duplication of the target axis.
- Setting a large value for the JOG speed from the beginning is dangerous. For safety, set a small value first, and increase the value gradually while checking the operation to determine the value optimal for the control.
- When values other than 0 are set in both i_ulnching (Cd.16: Inching movement amount) and i_udJogSpd (Cd.17: JOG speed), the inching operation is performed.
- Every input must be provided with a value for proper FB operation.

Parameter setting

No parameters are required to use this FB.

Performance value

CPU	Measurement conditions*3	Performance value		Number of scans
		Processing time	Maximum scan time	
FX5UJ	Axis 1 Jogging at speed of 1000	0.374 ms	0.975 ms	1 scan
	Axis 1 Inching at speed of 1000	0.365 ms	0.983 ms	1 scan
FX5U, FX5UC*1*2	Axis 1 Jogging at speed of 1000	0.102 ms	0.745 ms	1 scan
	Axis 1 Inching at speed of 1000	0.093 ms	0.762 ms	1 scan

*1 When the program capacity is set to 128 K steps, the processing speed may be reduced.

*2 The labels in the standard area are used.

*3 Measure the time from when the forward run JOG command is turned on until when it completes normally.

Error code

Error code (hexadecimal)	Description	Action
100	The set value of i_uAxis (Target axis) is out of the range. The target axis is not within the range of 1 to 4.	Try again after checking the setting. Turn off the forward run JOG command or reverse run JOG command, turn on i_bEN from off, and turn on the forward run JOG command or reverse run JOG command again.

2.4 M+FX5PG_MPG (Manual pulse generator operation)

Overview

Performs the manual pulse generator operation.

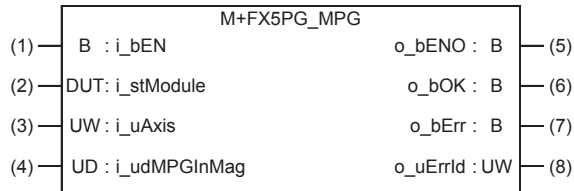

Labels

Input label

No.	Variable name	Name	Data type	Range	Description
(1)	i_bEN	Execution command	Bit	ON, OFF	ON: The FB is activated. OFF: The FB is not activated.
(2)	i_stModule	Module label	Structure	The setting range differs depending on the module label.	Specifies the module label for the positioning module.
(3)	i_uAxis	Target axis	Word [Unsigned]/Bit String [16-bit]	1 to 4	Specify the axis number. The setting range varies according to the positioning module in use.
(4)	i_udMPGInMag	Cd.20: Manual pulse generator 1 pulse input magnification	Double Word [Unsigned]/Bit String [32-bit]	1 to 10000	Set the input magnification of the manual pulse generator 1 pulse. • When the set value is 0, the magnification is 1. • When the set value is 10001 or higher, the magnification is 10000.

Output label

No.	Variable name	Name	Data type	Default value	Description
(5)	o_bENO	Execution status	Bit	OFF	ON: The execution command is ON. OFF: The execution command is OFF.
(6)	o_bOK	Normal completion	Bit	OFF	When this label is ON, it indicates that the manual pulse generator operation has been enabled.
(7)	o_bErr	Error completion	Bit	OFF	When this label is ON, it indicates that an error has occurred in the FB.
(8)	o_uErrId	Error code	Word [Unsigned]/Bit String [16-bit]	0	Stores the error code that occurred in the FB.

Module label

Buffer Memory Addresses	Name (Comment)	Label name	Data type	Initial value	Range	R/W	Description
1522, 1523, 1622, 1623	RW: Manual pulse generator 1 pulse input magnification (Direct)	FX5PG_□.stnAxisControlData_Axis_D[].udManualPulseGenerator1_PulseInputMagnification_D	Double Word [Unsigned]/Bit String [32-bit]	1	1 to 10000	R/W	Set the multiplying factor of the pulse count input from the manual pulser.
1524, 1624	RW: Manual pulse generator enable flag (Direct)	FX5PG_□.stnAxisControlData_Axis_D[].uManualPulseGeneratorEnableFlag_D	Word [Unsigned]/Bit String [16-bit]	0	0 to 1	R/W	Set whether or not to permit the manual pulser operation.
31500.b0	R: READY (Direct)	FX5PG_□.stSystemMonitorData2_D.bReady_D	Bit	OFF	ON, OFF	R	Used for interlocking in a program.
31501.b0	R: BUSY (Direct)	FX5PG_□.stSystemMonitorData2_D.bnBusy_Axis_D[]	Bit	OFF	ON, OFF	R	Turns on at the start of positioning, origin return, and jogging.

FB details

Available device



■ Positioning module

Target module	Firmware Version	Engineering tool
FX5-20PG-P	—	GX Works3 Version 1.035M or later
FX5-20PG-D	—	GX Works3 Version 1.050C or later

■ CPU module

MELSEC iQ-F series

Basic specifications

Item	Description
Language	Ladder diagram
Number of steps	160 steps The number of FB steps integrated in the program varies depending on the CPU module used, the input/output definition, and the setting options of GX Works3. For the setting options of GX Works3, refer to  GX Works3 Operating Manual.
The amount of label usage	<ul style="list-style-type: none"> Label: 0.01 K point (Word) Latch label: 0 K point (Word) The amount of labels used in the program varies depending on the CPU module used, the device specified in an argument and the option setting of GX Works3. For the option setting of GX Works3, refer to  GX Works3 Operating Manual.
The number of index register usage	<ul style="list-style-type: none"> Index register: 0 point Long index register: 0 point
The amount of file register usage	0 point
FB dependence	No dependence
FB compilation method	Macro type
FB operation	Always executed

Processing

- By turning ON or OFF i_bEN (Execution command), the manual pulse generator operation is enabled or disabled.
- This FB is constantly executed after i_bEN (Execution command) is turned on.
- The workpiece moves for the number of pulses input from the manual pulse generator while o_bOK (Normal completion) is ON.
- If the setting value of the target axis is out of the setting range, o_bErr (Error completion) turns on and the processing of this FB is interrupted. In addition, the error code 100 (hexadecimal) is stored in o_uErrId (Error code). For the error code, refer to  Page 30 Error code.

Timing chart of I/O signals

■For normal completion (Axis 1)

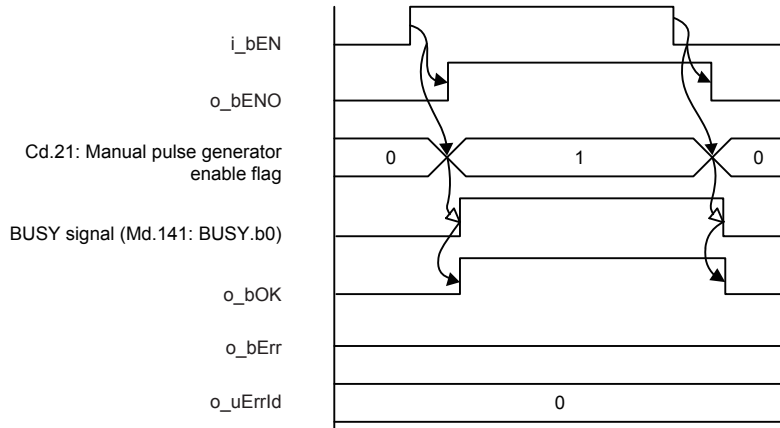

■For error completion (Axis 1)

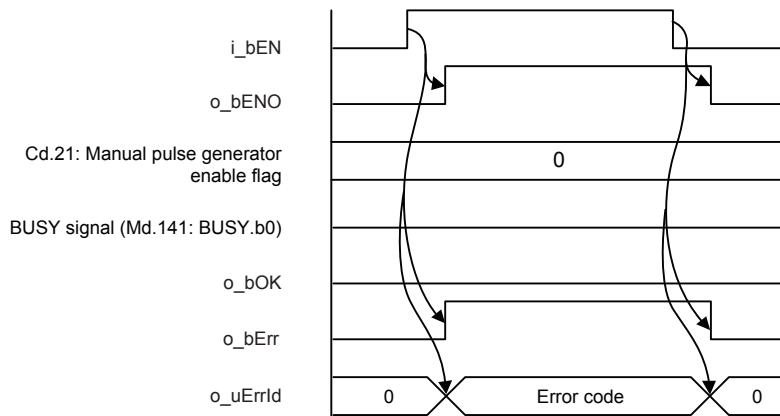

Restrictions or precautions

- This FB does not include the error recovery processing. Program the error recovery processing separately in accordance with the required system operation.
- This FB cannot be used in an interrupt program.
- Do not use this FB in programs that are executed only once, such as a subroutine program or FOR-NEXT loop, because i_bEN (Execution command) cannot be turned off and the normal operation cannot be acquired. Always use this FB in programs that can turn off i_bEN (Execution command).
- Do not change i_uAxis (Target axis) while i_bEN (Execution command) is ON.
- When this FB is used twice or more, precaution must be taken to avoid duplication of the target axis.
- Every input must be provided with a value for proper FB operation.

Parameter setting

No parameters are required to use this FB.

Performance value

CPU	Measurement conditions	Performance value		Number of scans
		Processing time	Maximum scan time	
FX5UJ	Axis 1 Manual pulse generator 1 pulse input magnification:1	1.52 ms	0.903 ms	1 scan
FX5U, FX5UC ^{*1*2}	Axis 1 Manual pulse generator 1 pulse input magnification:1	1.38 ms	0.790 ms	1 scan

*1 When the program capacity is set to 128 K steps, the processing speed may be reduced.

*2 The labels in the standard area are used.

Error code

Error code (hexadecimal)	Description	Action
100	The set value of i_uAxis (Target axis) is out of the range. The target axis is not within the range of 1 to 4.	Try again after checking the setting.

2.5 M+FX5PG_ChangeSpeed (Speed change)

Overview

Changes the speed.

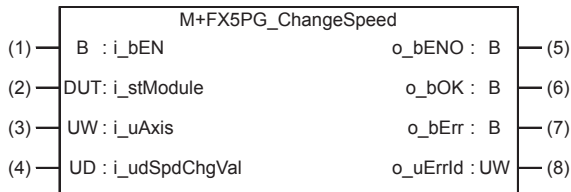

Labels

Input label

No.	Variable name	Name	Data type	Range	Description
(1)	i_bEN	Execution command	Bit	ON, OFF	ON: The FB is activated. OFF: The FB is not activated.
(2)	i_stModule	Module label	Structure	The setting range differs depending on the module label.	Specifies the module label for the positioning module.
(3)	i_uAxis	Target axis	Word [Unsigned]/Bit String [16-bit]	1 to 4	Specify the axis number. The setting range varies according to the positioning module in use.
(4)	i_udSpdChgVal	Cd.14: New speed value	Double Word [Unsigned]/Bit String [32-bit]	0 to 2000000000, 0 to 3000000000, 0 to 5000000	Set a new speed. <ul style="list-style-type: none"> Pr.1: Unit setting 0: mm 0 to 2000000000 ($\times 10^{-2}$ mm/min) Pr.1: Unit setting 1: inch 0 to 2000000000 ($\times 10^{-3}$ inch/min) Pr.1: Unit setting 2: degree 0 to 3000000000 ($\times 10^{-3}$ degree/min) Pr.1: Unit setting 3: pulse 0 to 5000000 (pulse/s)

Output label

No.	Variable name	Name	Data type	Default value	Description
(5)	o_bENO	Execution status	Bit	OFF	ON: The execution command is ON. OFF: The execution command is OFF.
(6)	o_bOK	Normal completion	Bit	OFF	When this label is ON, it indicates that the speed change has been completed.
(7)	o_bErr	Error completion	Bit	OFF	When this label is ON, it indicates that an error has occurred in the FB.
(8)	o_uErrId	Error code	Word [Unsigned]/Bit String [16-bit]	0	Stores the error code that occurred in the FB.

Module label

Buffer Memory Addresses	Name (Comment)	Label name	Data type	Initial value	Range	R/W	Description
1514, 1515, 1614, 1615	RW: New speed value (Direct)	FX5PG_□.stnAxisControlData_Axis_D[].udNewSpeedValue_D	Double Word [Unsigned]/Bit String [32-bit]	0	0 to 2000000000, 0 to 3000000000, 0 to 5000000	R	If the speed will be changed, set the new speed. When 0 is set, the axis will stop, but the BUSY signal will be kept on.
1516, 1616	RW: Speed change request (Direct)	FX5PG_□.stnAxisControlData_Axis_D[].uSpeedChangeRequest_D	Word [Unsigned]/Bit String [16-bit]	0	0 to 1	R/W	After setting "Cd.14 New speed value," request the speed change processing (validate the value of "Cd.14 New speed value").
31501.b0	R: BUSY (Direct)	FX5PG_□.stSystemMonitorData2_D.bnBusy_Axis_D[]	Bit	OFF	ON, OFF	R	Turns on at the start of positioning, origin return, and jogging.

FB details

Available device



■ Positioning module

Target module	Firmware Version	Engineering tool
FX5-20PG-P	—	GX Works3 Version 1.035M or later
FX5-20PG-D	—	GX Works3 Version 1.050C or later

■ CPU module

MELSEC iQ-F series

Basic specifications

Item	Description
Language	Ladder diagram
Number of steps	136 steps The number of FB steps integrated in the program varies depending on the CPU module used, the input/output definition, and the setting options of GX Works3. For the setting options of GX Works3, refer to  GX Works3 Operating Manual.
The amount of label usage	<ul style="list-style-type: none"> Label: 0.01 K point (Word) Latch label: 0 K point (Word) The amount of labels used in the program varies depending on the CPU module used, the device specified in an argument and the option setting of GX Works3. For the option setting of GX Works3, refer to  GX Works3 Operating Manual.
The number of index register usage	<ul style="list-style-type: none"> Index register: 0 point Long index register: 0 point
The amount of file register usage	0 point
FB dependence	No dependence
FB compilation method	Macro type
FB operation	Pulsed execution (multiple scan execution type)

Processing

- By turning on i_bEN (Execution command), the speed used for the control is changed to a new speed.
- If the setting value of the target axis is out of the setting range, o_bErr (Error completion) turns on and the processing of this FB is interrupted. In addition, the error code 100 (hexadecimal) is stored in o_uErrId (Error code). For the error code, refer to  Page 34 Error code.

Timing chart of I/O signals

■ For normal completion

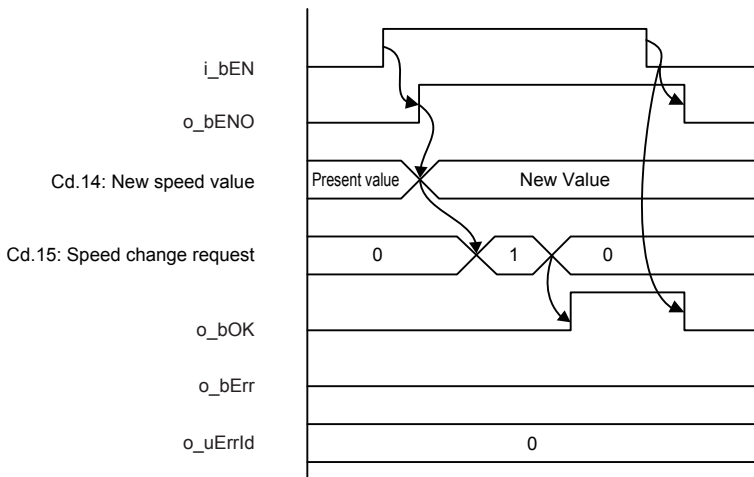

■ For error completion

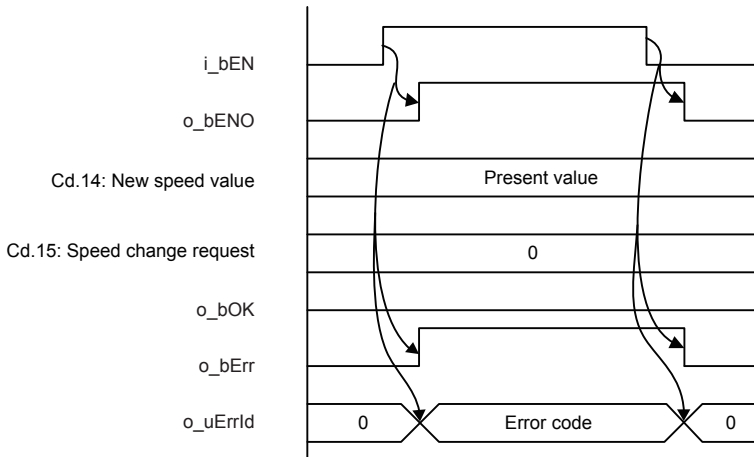

Restrictions or precautions

- This FB does not include the error recovery processing. Program the error recovery processing separately in accordance with the required system operation.
- This FB cannot be used in an interrupt program.
- Do not use this FB in programs that are executed only once, such as a subroutine program or FOR-NEXT loop, because **i_bEN** (Execution command) cannot be turned off and the normal operation cannot be acquired. Always use this FB in programs that can turn off **i_bEN** (Execution command).
- When this FB is used twice or more, precaution must be taken to avoid duplication of the target axis.
- Every input must be provided with a value for proper FB operation.
- When **i_bEN** (Execution command) is turned on while **BUSY** signal (**Md.141: BUSY.b0, b1**) is OFF, **o_bErr** (Error completion) turns on and the processing of this FB is interrupted. In addition, the error code 201 (hexadecimal) is stored in **o_uErrId** (Error code). For the error code, refer to [Page 34 Error code](#).

Parameter setting

No parameters are required to use this FB.

Performance value

CPU	Measurement conditions	Performance value		Number of scans
		Processing time	Maximum scan time	
FX5UJ	Axis 1 New speed value: 50000($\times 10^{-2}$ mm/min)	1.55 ms	1.28 ms	1 scan
FX5U, FX5UC ^{*1*2}	Axis 1 New speed value: 50000($\times 10^{-2}$ mm/min)	1.32 ms	1.08 ms	1 scan

*1 When the program capacity is set to 128 K steps, the processing speed may be reduced.

*2 The labels in the standard area are used.

Error code

Error code (hexadecimal)	Description	Action
100	The set value of i_uAxis (Target axis) is out of the range. The target axis is not within the range of 1 to 4.	Try again after checking the setting.
201	This FB is executed before the positioning operation starts.	Please try again during the positioning operation.

2.6 M+FX5PG_ChangeAccDecTime (Acceleration/ deceleration time change)

Overview

Changes the acceleration/deceleration time during speed change.

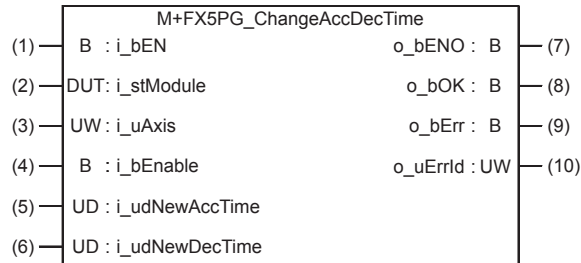

Labels

Input label

No.	Variable name	Name	Data type	Range	Description
(1)	i_bEN	Execution command	Bit	ON, OFF	ON: The FB is activated. OFF: The FB is not activated.
(2)	i_stModule	Module label	Structure	The setting range differs depending on the module label.	Specifies the module label for the positioning module.
(3)	i_uAxis	Target axis	Word [Unsigned]/Bit String [16-bit]	1 to 4	Specify the axis number. The setting range varies according to the positioning module in use.
(4)	i_bEnable	Acceleration/ deceleration time change enabled flag	Bit	ON: Enabled OFF: Disabled	Set this label to enable or disable the acceleration/ deceleration time change.
(5)	i_udNewAccTime	Cd.10: New acceleration time value	Double Word [Unsigned]/Bit String [32-bit]	0 to 8388608 ms	Set a new acceleration time. When 0 is set, the acceleration time is not changed after the speed is changed. In this case, the operation is controlled at the previously set acceleration time.
(6)	i_udNewDecTime	Cd.11: New deceleration time value	Double Word [Unsigned]/Bit String [32-bit]	0 to 8388608 ms	Set a new deceleration time. When 0 is set, the deceleration time is not changed after the speed is changed. In this case, the operation is controlled at the previously set deceleration time.

Output label

No.	Variable name	Name	Data type	Default value	Description
(7)	o_bENO	Execution status	Bit	OFF	ON: The execution command is ON. OFF: The execution command is OFF.
(8)	o_bOK	Normal completion	Bit	OFF	When this label is ON, it indicates that setting the acceleration/deceleration time change has been completed.
(9)	o_bErr	Error completion	Bit	OFF	When this label is ON, it indicates that an error has occurred in the FB.
(10)	o_uErrId	Error code	Word [Unsigned]/Bit String [16-bit]	0	Stores the error code that occurred in the FB.

Module label

Buffer Memory Addresses	Name (Comment)	Label name	Data type	Initial value	Range	R/W	Description
1508, 1509, 1608, 1609	RW: New acceleration time value (Direct)	FX5PG_□.stnAxisControlData_Axis_D[].udNewAccelerationTimeValue_D	Double Word [Unsigned]/BitString [32-bit]	0	0 to 8388608	R/W	If the acceleration time will be changed when the speed is changed, set the new acceleration time.
1510, 1511, 1610, 1611	RW: New deceleration time value (Direct)	FX5PG_□.stnAxisControlData_Axis_D[].udNewDecelerationTimeValue_D	Double Word [Unsigned]/BitString [32-bit]	0	0 to 8388608	R/W	If the deceleration time will be changed when the speed is changed, set the new deceleration time.
1512, 1612	RW: Acceleration/ deceleration time change during speed change, enable/ disableselection (Direct)	FX5PG_□.stnAxisControlData_Axis_D[].uAccelerationDecelerationTimeChange_SpeedChangeSelection_D	Word [Unsigned]/BitString [16-bit]	0	0 to 1	R/W	Set whether to enable or disable to change the acceleration/ deceleration time when the speed is changed.

FB details

Available device



■Positioning module

Target module	Firmware Version	Engineering tool
FX5-20PG-P	—	GX Works3 Version 1.035M or later
FX5-20PG-D	—	GX Works3 Version 1.050C or later

■CPU module

MELSEC iQ-F series

Basic specifications

Item	Description
Language	Ladder diagram
Number of steps	123 steps The number of FB steps integrated in the program varies depending on the CPU module used, the input/output definition, and the setting options of GX Works3. For the setting options of GX Works3, refer to  GX Works3 Operating Manual.
The amount of label usage	<ul style="list-style-type: none"> Label: 0.01 K point (Word) Latch label: 0 K point (Word) The amount of labels used in the program varies depending on the CPU module used, the device specified in an argument and the option setting of GX Works3. For the option setting of GX Works3, refer to  GX Works3 Operating Manual.
The number of index register usage	<ul style="list-style-type: none"> Index register:0 point Long index register:0 point
The amount of file register usage	0 point
FB dependence	No dependence
FB compilation method	Macro type
FB operation	Pulsed execution (single scan execution type)

Processing

- By turning on `i_bEN` (Execution command), the setting of acceleration/deceleration time is changed according to `i_bEnable` (Acceleration/deceleration time change enabled flag). When `i_bEnable` (Acceleration/deceleration time change enabled flag) is ON, `i_udNewAccTime` (Cd.10: New acceleration time value) and `i_udNewDecTime` (Cd.11: New deceleration time value) are set and Cd.12: Acceleration/deceleration time change during speed change, enable/disable selection is changed to 1: Acceleration/deceleration time change enabled. When `i_bEnable` (Acceleration/deceleration time change enabled flag) is OFF, `i_udNewAccTime` (Cd.10: New acceleration time value) and `i_udNewDecTime` (Cd.11: New deceleration time value) are not changed and Cd.12: Acceleration/deceleration time change during speed change, enable/disable selection is changed to 0: Acceleration/deceleration time change disabled.
- If the setting value of the target axis is out of the setting range, `o_bErr` (Error completion) turns on and the processing of this FB is interrupted. In addition, the error code 100 (hexadecimal) is stored in `o_uErrId` (Error code). For the error code, refer to, [Page 39 Error code](#).

Timing chart of I/O signals

■ For normal completion

- Cd.12: Acceleration/deceleration time change during speed change, enable/disable selection is enabled.

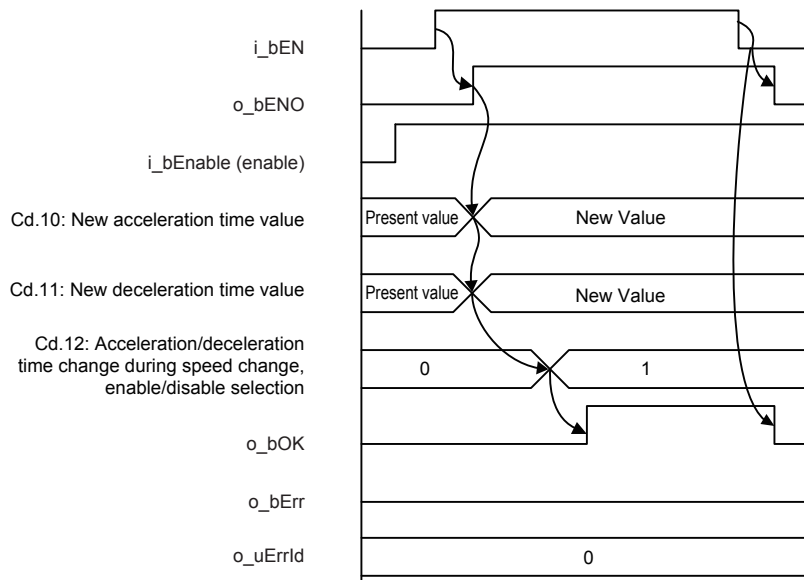

- Cd.12: Acceleration/deceleration time change during speed change, enable/disable selection is disabled.

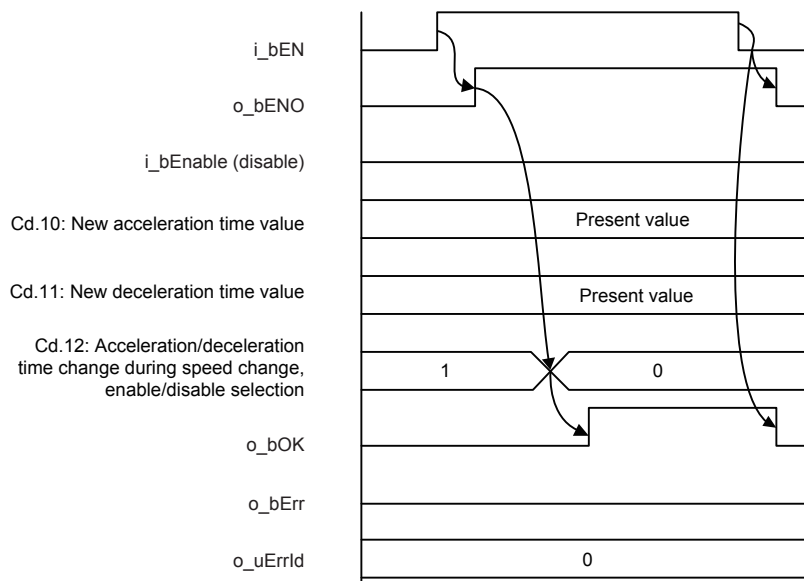

■ For error completion

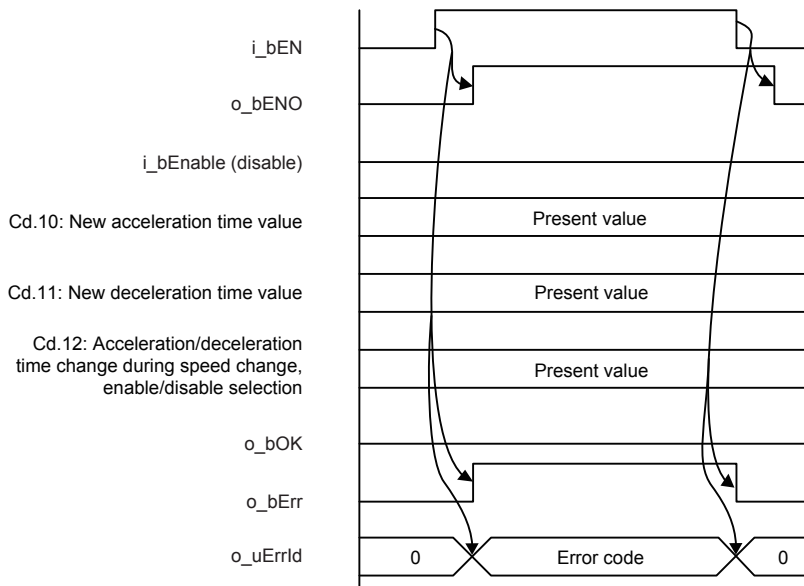

Restrictions or precautions

- This FB does not include the error recovery processing. Program the error recovery processing separately in accordance with the required system operation.
- This FB cannot be used in an interrupt program.
- Do not use this FB in programs that are executed only once, such as a subroutine program or FOR-NEXT loop, because *i_bEN* (Execution command) cannot be turned off and the normal operation cannot be acquired. Always use this FB in programs that can turn off *i_bEN* (Execution command).
- When this FB is used twice or more, precaution must be taken to avoid duplication of the target axis.
- Every input must be provided with a value for proper FB operation.

Parameter setting

No parameters are required to use this FB.

Performance value

CPU	Measurement conditions	Performance value		Number of scans
		Processing time	Maximum scan time	
FX5UJ	Axis 1 New acceleration time value: 10000 ms New deceleration time value: 15000 ms	0.344 ms	1.240 ms	1 scan
FX5U, FX5UC ^{*1,2}	Axis 1 New acceleration time value: 10000 ms New deceleration time value: 15000 ms	0.056 ms	0.921 ms	1 scan

*1 When the program capacity is set to 128 K steps, the processing speed may be reduced.

*2 The labels in the standard area are used.

Error code

Error code (hexadecimal)	Description	Action
100	The set value of i_uAxis (Target axis) is out of the range. The target axis is not within the range of 1 to 4.	Try again after checking the setting.

2.7 M+FX5PG_ChangePosition (Target position change)

Overview

Changes the target position.

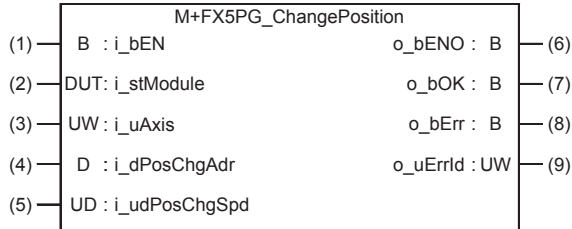

Labels

Input label

No.	Variable name	Name	Data type	Range	Description
(1)	i_bEN	Execution command	Bit	ON, OFF	ON: The FB is activated. OFF: The FB is not activated.
(2)	i_stModule	Module label	Structure	The setting range differs depending on the module label.	Specifies the module label for the positioning module.
(3)	i_uAxis	Target axis	Word [Unsigned]/Bit String [16-bit]	1 to 4	Specify the axis number. The setting range varies according to the positioning module in use.
(4)	i_dPosChgAdr	Cd.27: Target position change value (new address)	Double Word [Signed]	-2147483648 to 2147483647, 0 to 35999999	Set a new positioning address to change the target position during positioning. [ABS] • Pr.1: Unit setting 0: mm -2147483648 to 2147483647 ($\times 10^{-1}$ μm) • Pr.1: Unit setting 1: inch -2147483648 to 2147483647 ($\times 10^{-5}$ inch) • Pr.1: Unit setting 2: degree 0 to 35999999 ($\times 10^{-5}$ degree) • Pr.1: Unit setting 3: pulse -2147483648 to 2147483647 (pulse) [INC] • Pr.1: Unit setting 0: mm -2147483648 to 2147483647 ($\times 10^{-1}$ μm) • Pr.1: Unit setting 1: inch -2147483648 to 2147483647 ($\times 10^{-5}$ inch) • Pr.1: Unit setting 2: degree -2147483648 to 2147483647 ($\times 10^{-5}$ degree) • Pr.1: Unit setting 3: pulse -2147483648 to 2147483647 (pulse)
(5)	i_udPosChgSpd	Cd.28: Target position change value (new speed)	Double Word [Unsigned]/Bit String [32-bit]	0 to 2000000000, 0 to 3000000000, 0 to 5000000	Set a new speed to change the target position during positioning. When 0 is set, the speed is not changed. • Pr.1: Unit setting 0: mm 0 to 2000000000 ($\times 10^{-2}$ mm/min) • Pr.1: Unit setting 1: inch 0 to 2000000000 ($\times 10^{-3}$ inch/min) • Pr.1: Unit setting 2: degree 0 to 3000000000 ($\times 10^{-3}$ degree/min) • Pr.1: Unit setting 3: pulse 0 to 5000000 (pulse/s)

Output label

No.	Variable name	Name	Data type	Default value	Description
(6)	o_bENO	Execution status	Bit	OFF	ON: The execution command is ON. OFF: The execution command is OFF.
(7)	o_bOK	Normal completion	Bit	OFF	When this label is ON, it indicates that the module has accepted the target position change request values.
(8)	o_bErr	Error completion	Bit	OFF	When this label is ON, it indicates that an error has occurred in the FB.
(9)	o_uErrId	Error code	Word [Unsigned]/Bit String [16-bit]	0	Stores the error code that occurred in the FB.

Module label

Buffer Memory Addresses	Name (Comment)	Label name	Data type	Initial value	Range	R/W	Description
1534, 1535, 1634, 1635	RW: Target position change value(new address) (Direct)	FX5PG_□.stnAxisControlData_Axis_D].dTarg etPositionChangeValueNewAddress_D	Double Word [Signed]	0	-2147483648 to 2147483647, 0 to 35999999	R/W	If the target position will be changed during positioning, set the new positioning address.
1536, 1537, 1636, 1637	RW: Target position change value(new speed) (Direct)	FX5PG_□.stnAxisControlData_Axis_D].udTarg etPositionChangeValueNewSpeed_D	Double Word [Unsigned]/BitString [32-bit]	0	0 to 2000000000, 0 to 3000000000, 0 to 5000000	R/W	If the target position will be changed during positioning, set the new speed. When the setting is 0, the speed will not be changed.
1538, 1638	RW: Target position change request flag (Direct)	FX5PG_□.stnAxisControlData_Axis_D].uTarg etPositionChangeRequestFlag_D	Word [Unsigned]/Bit String [16-bit]	0	0 to 1	R/W	Set whether or not to change the target value during positioning.
31501.b0	R: BUSY (Direct)	FX5PG_□.stSystemMonitorData2_D.bnBusy_Axis_D[]	Bit	OFF	ON, OFF	R	Turns on at the start of positioning, origin return, and jogging.

FB details

Available device



■Positioning module

Target module	Firmware Version	Engineering tool
FX5-20PG-P	—	GX Works3 Version 1.035M or later
FX5-20PG-D	—	GX Works3 Version 1.050C or later

■CPU module

MELSEC iQ-F series

Basic specifications

Item	Description
Language	Ladder diagram
Number of steps	150 steps The number of FB steps integrated in the program varies depending on the CPU module used, the input/output definition, and the setting options of GX Works3. For the setting options of GX Works3, refer to  GX Works3 Operating Manual.
The amount of label usage	<ul style="list-style-type: none">• Label: 0.01 K point (Word)• Latch label: 0 K point (Word) The amount of labels used in the program varies depending on the CPU module used, the device specified in an argument and the option setting of GX Works3. For the option setting of GX Works3, refer to  GX Works3 Operating Manual.
The number of index register usage	<ul style="list-style-type: none">• Index register:0 point• Long index register:0 point
The amount of file register usage	0 point
FB dependence	No dependence
FB compilation method	Macro type
FB operation	Pulsed execution (multiple scan execution type)

Processing

- By turning on i_bEN (Execution command), the target position is changed according to the value set in i_dPosChgAdr (Cd.27: Target position change value (new address)) and the command speed is changed according to the value set in i_udPosChgSpd (Cd.28: Target position change value (new speed)) during the position control.
- If the setting value of the target axis is out of the setting range, o_bErr (Error completion) turns on and the processing of this FB is interrupted. In addition, the error code 100 (hexadecimal) is stored in o_uErrId (Error code). For the error code, refer to  Page 44 Error code.

Timing chart of I/O signals

■For normal completion

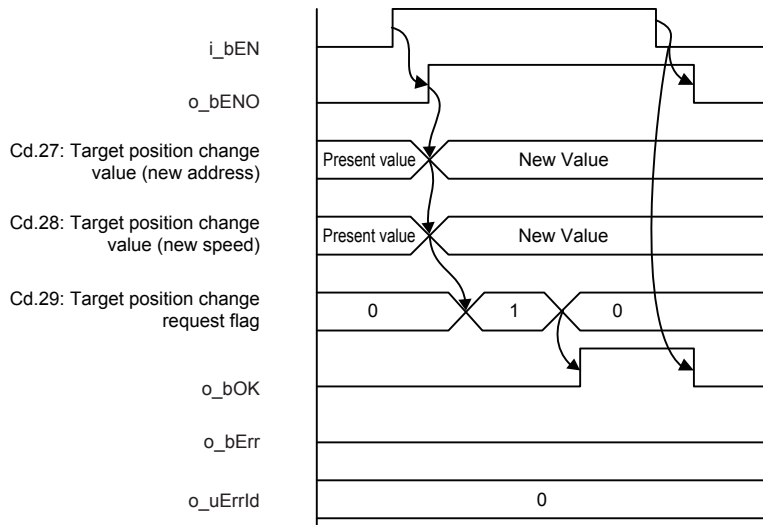

■For error completion

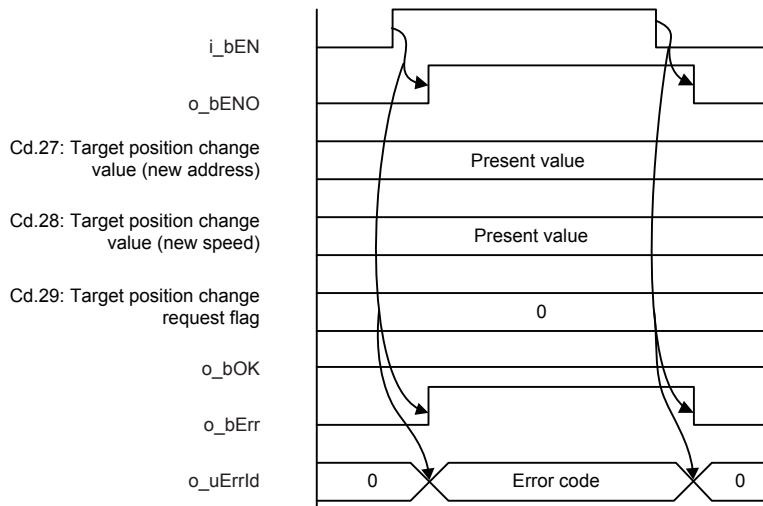

Restrictions or precautions

- This FB does not include the error recovery processing. Program the error recovery processing separately in accordance with the required system operation.
- This FB cannot be used in an interrupt program.
- Do not use this FB in programs that are executed only once, such as a subroutine program or FOR-NEXT loop, because i_bEN (Execution command) cannot be turned off and the normal operation cannot be acquired. Always use this FB in programs that can turn off i_bEN (Execution command).
- When this FB is used twice or more, precaution must be taken to avoid duplication of the target axis.
- Every input must be provided with a value for proper FB operation.
- When i_bEN (Execution command) is turned on while BUSY signal (Md.141: BUSY.b0, b1) is OFF, o_bErr (Error completion) turns on and the processing of this FB is interrupted. In addition, the error code 201 (hexadecimal) is stored in o_uErrId (Error code). For the error code, refer to [Page 44 Error code](#).

Parameter setting

No parameters are required to use this FB.

Performance value

CPU	Measurement conditions	Performance value		Number of scans
		Processing time	Maximum scan time	
FX5UJ	Axis 1 Target position change value(new address): 10000mm Target position change value(new speed): 1500mm	1.64 ms	1.270 ms	1 scan
FX5U, FX5UC ^{*1*2}	Axis 1 Target position change value(new address): 10000mm Target position change value(new speed): 1500mm	1.41 ms	0.946 ms	1 scan

*1 When the program capacity is set to 128 K steps, the processing speed may be reduced.

*2 The labels in the standard area are used.

Error code

Error code (hexadecimal)	Description	Action
100	The set value of i_uAxis (Target axis) is out of the range. The target axis is not within the range of 1 to 4.	Try again after checking the setting.
201	This FB is executed before the positioning operation starts.	Please try again during the positioning operation.

2.8 M+FX5PG_Restart (Positioning restart)

Overview

Restarts an axis that has stopped.

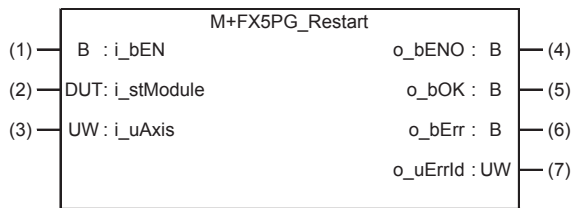

Labels

Input label

No.	Variable name	Name	Data type	Range	Description
(1)	i_bEN	Execution command	Bit	ON, OFF	ON: The FB is activated. OFF: The FB is not activated.
(2)	i_stModule	Module label	Structure	The setting range differs depending on the module label.	Specifies the module label for the positioning module.
(3)	i_uAxis	Target axis	Word [Unsigned]/Bit String [16-bit]	1 to 4	Specify the axis number. The setting range varies according to the positioning module in use.

Output label

No.	Variable name	Name	Data type	Default value	Description
(4)	o_bENO	Execution status	Bit	OFF	ON: The execution command is ON. OFF: The execution command is OFF.
(5)	o_bOK	Normal completion	Bit	OFF	When this label is ON, it indicates that the module has accepted the restart command request.
(6)	o_bErr	Error completion	Bit	OFF	When this label is ON, it indicates that an error has occurred in the FB.
(7)	o_uErrId	Error code	Word [Unsigned]/Bit String [16-bit]	0	Stores the error code that occurred in the FB.

Module label

Buffer Memory Addresses	Name (Comment)	Label name	Data type	Initial value	Range	R/W	Description
817, 917	R: Status (Direct)	FX5PG_□.stnAxisMonitorData_Axis_D[].uStatus_D	Word [Unsigned]/Bit String [16-bit]	0008H	—	R	Stores the ON/OFF status of each flag. b15: Turns on upon completion of positioning.
809, 909	R: Axis operation status (Direct)	FX5PG_□.stnAxisMonitorData_Axis_D[].wAxisOperationStatus_D	Word [signed]	0	-2 to 14	R	The axis operation status is stored.
1503, 1603	RW: Restart command (Direct)	FX5PG_□.stnAxisControlData_Axis_D[].uRestartCommand_D	Word [Unsigned]/Bit String [16-bit]	0	0 to 1	R/W	If "1" is set when positioning is suspended due to any factor (the axis operation status is "stopped"), the positioning will be restarted to move from the stop position to the end point specified in the suspended positioning data.

FB details

Available device



■Positioning module

Target module	Firmware Version	Engineering tool
FX5-20PG-P	—	GX Works3 Version 1.035M or later
FX5-20PG-D	—	GX Works3 Version 1.050C or later



■CPU module

MELSEC iQ-F series

Basic specifications

Item	Description
Language	Ladder diagram
Number of steps	148 steps The number of FB steps integrated in the program varies depending on the CPU module used, the input/output definition, and the setting options of GX Works3. For the setting options of GX Works3, refer to  GX Works3 Operating Manual.
The amount of label usage	• Label: 0.01 K point (Word) • Latch label: 0 K point (Word) The amount of labels used in the program varies depending on the CPU module used, the device specified in an argument and the option setting of GX Works3. For the option setting of GX Works3, refer to  GX Works3 Operating Manual.
The number of index register usage	• Index register:0 point • Long index register:0 point
The amount of file register usage	0 point
FB dependence	No dependence
FB compilation method	Macro type
FB operation	Pulsed execution (multiple scan execution type)

Processing

- Only when all of the following conditions are satisfied, the positioning operation that is stopped due to an error is restarted by turning on i_bEN (Execution command). If some of the conditions (even one condition) are not satisfied, o_bErr (Error completion) turns on and the processing of this FB is interrupted. In addition, the error code 202 (hexadecimal) is stored in o_uErrId (Error code). For the error code, refer to  Page 48 Error code. (The conditions are positioning module complete signal (Md.31: Status.b15): OFF and Axis operation status (Md.26: Axis operation status): Stopped.)
- If the setting value of the target axis is out of the setting range, o_bErr (Error completion) turns on and the processing of this FB is interrupted. In addition, the error code 100 (hexadecimal) is stored in o_uErrId (Error code). For the error code, refer to  Page 48 Error code.

Timing chart of I/O signals

■ For normal completion

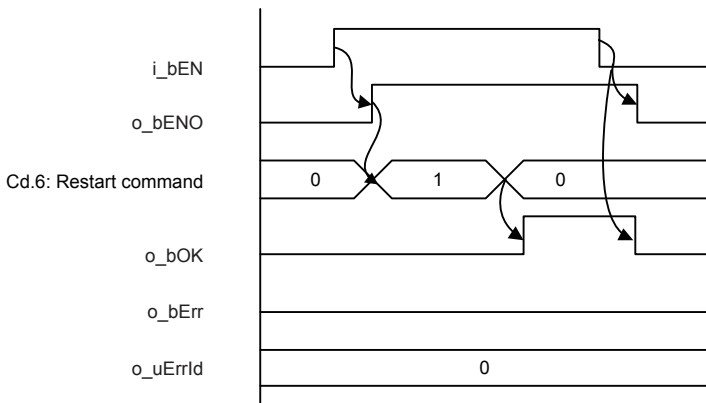

■ For error completion

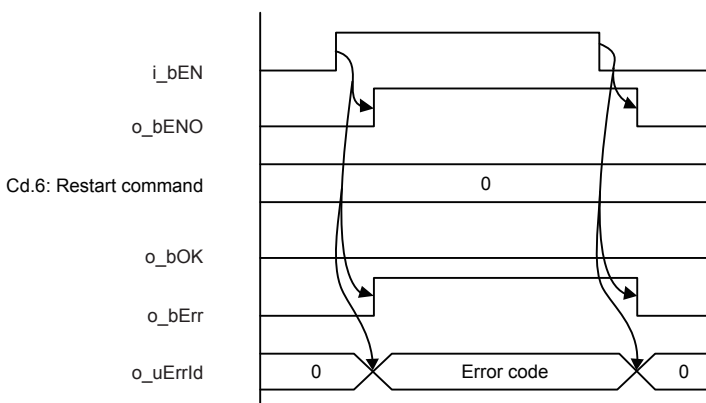

Restrictions or precautions

- This FB does not include the error recovery processing. Program the error recovery processing separately in accordance with the required system operation.
- This FB cannot be used in an interrupt program.
- Do not use this FB in programs that are executed only once, such as a subroutine program or FOR-NEXT loop, because i_bEN (Execution command) cannot be turned off and the normal operation cannot be acquired. Always use this FB in programs that can turn off i_bEN (Execution command).
- When this FB is used twice or more, precaution must be taken to avoid duplication of the target axis.
- Every input must be provided with a value for proper FB operation.

Parameter setting

No parameters are required to use this FB.

Performance value

CPU	Measurement conditions*3	Performance value		Number of scans
		Processing time	Maximum scan time	
FX5UJ	Axis 1	42.0 ms	1.270 ms	69 scans
FX5U, FX5UC**1*2	Axis 1	41.6 ms	0.971 ms	85 scans

*1 When the program capacity is set to 128 K steps, the processing speed may be reduced.

*2 The labels in the standard area are used.

*3 Start the positioning under the measurement conditions for the performance values of M+FX5PG_StartPositioning, and stop and restart the axis 1 during scanning.

Error code

Error code (hexadecimal)	Description	Action
100	The set value of i_uAxis (Target axis) is out of the range. The target axis is not within the range of 1 to 4.	Try again after checking the setting.
202	The conditions for positioning restart are not satisfied. Some of the following conditions are not satisfied. <ul style="list-style-type: none"> Positioning complete signal: OFF Axis operation status: Stopped 	Execute the FB again when all of the following conditions are satisfied. <ul style="list-style-type: none"> Positioning complete signal: OFF Axis operation status: Stopped

2.9 M+FX5PG_OperateError (Error operation)

Overview

Monitors errors and warnings, and resets errors.

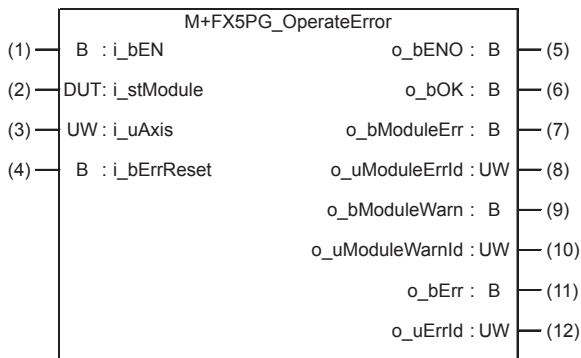

Labels

Input label

No.	Variable name	Name	Data type	Range	Description
(1)	i_bEN	Execution command	Bit	ON, OFF	ON: The FB is activated. OFF: The FB is not activated.
(2)	i_stModule	Module label	Structure	The setting range differs depending on the module label.	Specifies the module label for the positioning module.
(3)	i_uAxis	Target axis	Word [Unsigned]/Bit String [16-bit]	1 to 4	Specify the axis number. The setting range varies according to the positioning module in use.
(4)	i_bErrReset	Error reset command	Bit	ON, OFF	ON: Errors are reset. OFF: Errors are not reset.

Output label

No.	Variable name	Name	Data type	Default value	Description
(5)	o_bENO	Execution status	Bit	OFF	ON: The execution command is ON. OFF: The execution command is OFF.
(6)	o_bOK	Normal completion	Bit	OFF	When this label is ON, it indicates that error reset has been completed.
(7)	o_bModuleErr	Axis error detection	Bit	OFF	When this label is ON, it indicates that an axis error has occurred.
(8)	o_uModuleErrId	Axis error code	Word [Unsigned]/Bit String [16-bit]	0	The error code of the error that has occurred in the module of the specified axis is stored.
(9)	o_bModuleWarn	Axis warning detection	Bit	OFF	When this label is ON, it indicates that an axis warning has occurred.
(10)	o_uModuleWarnId	Axis warning code	Word [Unsigned]/Bit String [16-bit]	0	The warning code of the warning that has occurred in the module of the specified axis is stored.
(11)	o_bErr	Error completion	Bit	OFF	When this label is ON, it indicates that an error has occurred in the FB.
(12)	o_uErrId	Error code	Word [Unsigned]/Bit String [16-bit]	0	Stores the error code that occurred in the FB.

Module label

Buffer Memory Addresses	Name (Comment)	Label name	Data type	Initial value	Range	R/W	Description
1502, 1602	RW: Axis error reset	FX5PG_□.stnAxisControlData_Axis_D[].uAxisErrorReset_D	Word [Unsigned]/Bit String [16-bit]	0	0 to 1	R/W	Axis error detection, error No., axis warning detection and axis warning No. are cleared.
806, 906	R: Axis error No. (Direct)	FX5PG_□.stnAxisMonitorData_Axis_D[].uAxisErrorNo_D	Word [Unsigned]/Bit String [16-bit]	0	—	R	When an error is detected, the appropriate error code will be stored.
817, 917	R: Status (Direct)	FX5PG_□.stnAxisMonitorData_Axis_D[].uStatus_D	Word [Unsigned]/Bit String [16-bit]	0008H	—	R	Stores the ON/OFF status of each flag. b9: Turns on when an axis warning is detected and an axis warning occurs. Turns off when the axis error reset is turned on. b13: Error detection Turns on when an error occurs and turns off when "[Cd.5] Axis error reset" or "[Cd.49] All axes error reset" is turned on.
807, 907	R: Axis warning No. (Direct)	FX5PG_□.stnAxisMonitorData_Axis_D[].uAxisWarningNo_D	Word [Unsigned]/Bit String [16-bit]	0	—	R	When a warning is detected, the appropriate warning code will be stored.

FB details

Available device



■ Positioning module

Target module	Firmware Version	Engineering tool
FX5-20PG-P	—	GX Works3 Version 1.035M or later
FX5-20PG-D	—	GX Works3 Version 1.050C or later

■ CPU module

MELSEC iQ-F series

Basic specifications

Item	Description
Language	Ladder diagram
Number of steps	198 steps The number of FB steps integrated in the program varies depending on the CPU module used, the input/output definition, and the setting options of GX Works3. For the setting options of GX Works3, refer to  GX Works3 Operating Manual.
The amount of label usage	<ul style="list-style-type: none"> Label: 0.01 K point (Word) Latch label: 0 K point (Word) The amount of labels used in the program varies depending on the CPU module used, the device specified in an argument and the option setting of GX Works3. For the option setting of GX Works3, refer to  GX Works3 Operating Manual.
The number of index register usage	<ul style="list-style-type: none"> Index register: 0 point Long index register: 0 point
The amount of file register usage	0 point
FB dependence	No dependence
FB compilation method	Macro type
FB operation	Always executed

Processing

- By turning on i_bEN (Execution command), errors of the target axis are monitored.
- When a module error occurs, an error code is stored in o_uModuleErrId (Axis error code).
- After i_bEN (Execution command) is turned ON, the generated error is reset by turning on i_bErrReset (Error reset command).
- When a warning occurs in the module, the warning can be reset by turning on i_bErrReset (Error reset command).
- If the setting value of the target axis is out of the setting range, o_bErr (Error completion) turns on and the processing of this FB is interrupted. In addition, the error code 100 (hexadecimal) is stored in o_uErrId (Error code). For the error code, refer to  Page 53 Error code.

Timing chart of I/O signals

■ For normal completion

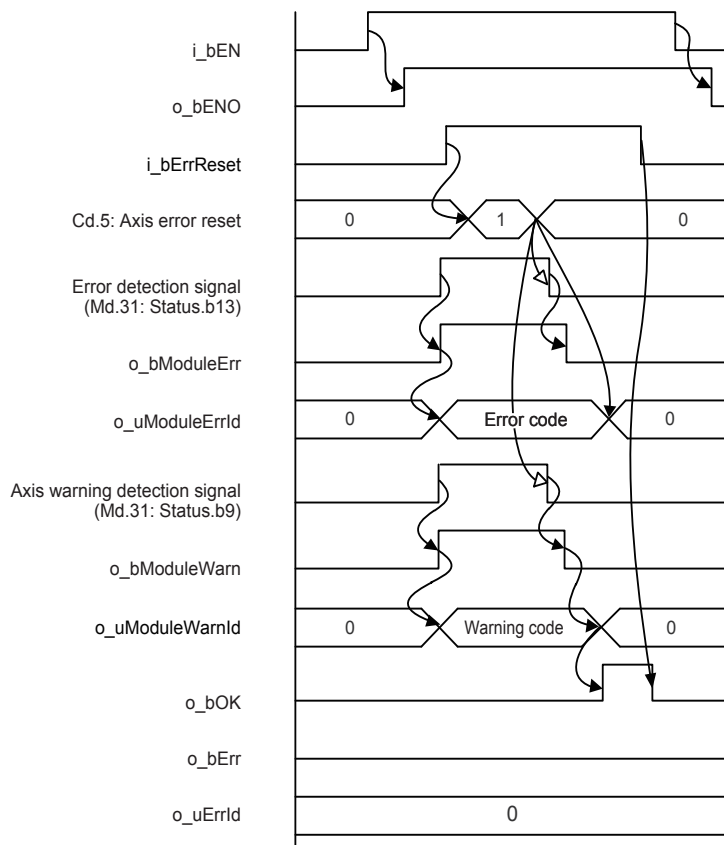

■ For error completion

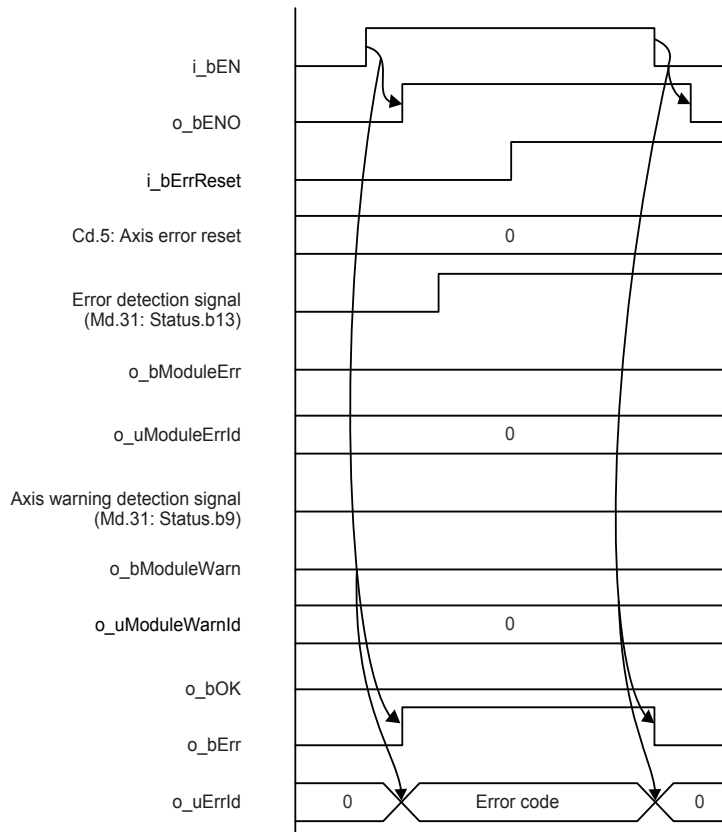

Restrictions or precautions

- This FB does not include the error recovery processing. Program the error recovery processing separately in accordance with the required system operation.
- This FB cannot be used in an interrupt program.
- Do not use this FB in programs that are executed only once, such as a subroutine program or FOR-NEXT loop, because **i_bEN** (Execution command) cannot be turned off and the normal operation cannot be acquired. Always use this FB in programs that can turn off **i_bEN** (Execution command).
- When this FB is used twice or more, precaution must be taken to avoid duplication of the target axis.
- Do not change **i_uAxis** (Target axis) while **i_bEN** (Execution command) is ON.
- Every input must be provided with a value for proper FB operation.

Parameter setting

No parameters are required to use this FB.

Performance value

CPU	Measurement conditions	Performance value		Number of scans
		Processing time	Maximum scan time	
FX5UJ	Axis 1 Error reset command: ON	42.1 ms	0.958 ms	63 scans
FX5U, FX5UC ^{*1*2}	Axis 1 Error reset command: ON	27.1 ms	0.826 ms	52 scans

*1 When the program capacity is set to 128 K steps, the processing speed may be reduced.

*2 The labels in the standard area are used.

Error code

Error code (hexadecimal)	Description	Action
100	The set value of i_uAxis (Target axis) is out of the range. The target axis is not within the range of 1 to 4.	Try again after checking the setting.

2.10 M+FX5PG_InitializeParameter (Parameter initialization)

Overview

Initializes parameters.

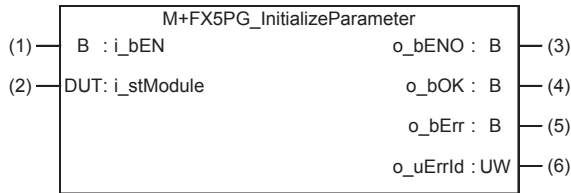

Labels

Input label

No.	Variable name	Name	Data type	Range	Description
(1)	i_bEN	Execution command	Bit	ON, OFF	ON: The FB is activated. OFF: The FB is not activated.
(2)	i_stModule	Module label	Structure	The setting range differs depending on the module label.	Specifies the module label for the positioning module.

Output label

No.	Variable name	Name	Data type	Default value	Description
(3)	o_bENO	Execution status	Bit	OFF	ON: The execution command is ON. OFF: The execution command is OFF.
(4)	o_bOK	Normal completion	Bit	OFF	When this label is ON, it indicates that parameter initialization has been completed.
(5)	o_bErr	Error completion	Bit	OFF	Always OFF
(6)	o_uErrId	Error code	Word [Unsigned]/Bit String [16-bit]	0	Always 0

Module label

Buffer Memory Addresses	Name (Comment)	Label name	Data type	Initial value	Range	R/W	Description
1950	RW: PLC READY signal (Direct)	FX5PG_□.stSystemControlData_D.uPLCReady_D	Word [Unsigned]/Bit String [16-bit]	0	0 to 1	R/W	A signal for notifying positioning module that the CPU module is normal.
31501.b0	R: BUSY (Direct)	FX5PG_□.stSystemMonitorData2_D.bnBusy_Axis_D[]	Bit	OFF	ON, OFF	R	Turns on at the start of positioning, origin return, and jogging.
1901	RW: Module data initialization request (Direct)	FX5PG_□.stSystemControlData_D.uModuleInitializeRequest_D	Word [Unsigned]/Bit String [16-bit]	0	0 to 1	R/W	The setting data is initialized.

FB details

Available device

■Positioning module

Target module	Firmware Version	Engineering tool
FX5-20PG-P	—	GX Works3 Version 1.035M or later
FX5-20PG-D	—	GX Works3 Version 1.050C or later

■CPU module

MELSEC iQ-F series

Basic specifications

Item	Description
Language	Ladder diagram
Number of steps	67 steps The number of FB steps integrated in the program varies depending on the CPU module used, the input/output definition, and the setting options of GX Works3. For the setting options of GX Works3, refer to GX Works3 Operating Manual .
The amount of label usage	<ul style="list-style-type: none"> Label: 0.01 K point (Word) Latch label: 0 K point (Word) The amount of labels used in the program varies depending on the CPU module used, the device specified in an argument and the option setting of GX Works3. For the option setting of GX Works3, refer to GX Works3 Operating Manual .
The number of index register usage	<ul style="list-style-type: none"> Index register:0 point Long index register:0 point
The amount of file register usage	0 point
FB dependence	No dependence
FB compilation method	Macro type
FB operation	Pulsed execution (multiple scan execution type)

Processing

- By turning on i_bEN (Execution command), the setting data stored in the buffer memory and the flash ROM of the positioning module is reset to the factory setting.

Timing chart of I/O signals

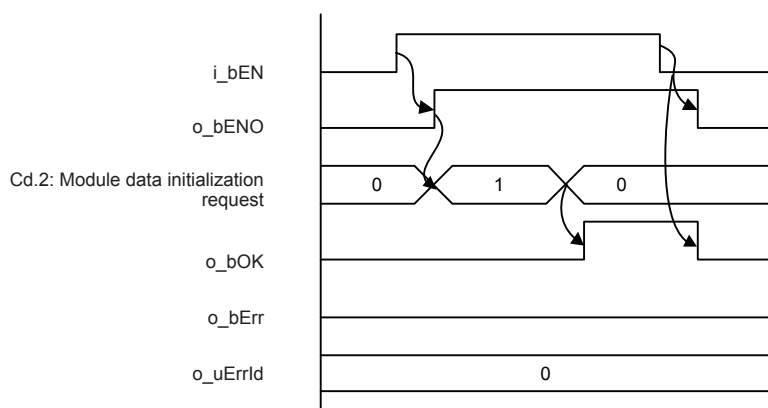

Restrictions or precautions

- This FB does not include the error recovery processing. Program the error recovery processing separately in accordance with the required system operation.
- This FB cannot be used in an interrupt program.
- Do not use this FB in programs that are executed only once, such as a subroutine program or FOR-NEXT loop, because i_bEN (Execution command) cannot be turned off and the normal operation cannot be acquired. Always use this FB in programs that can turn off i_bEN (Execution command).
- Every input must be provided with a value for proper FB operation.
- Before using this FB, check that PLC READY signal (Cd.190: PLC READY signal) is OFF.
- After the setting data is initialized, reset the CPU module or power on the programmable controller again.

Parameter setting

No parameters are required to use this FB.

Performance value

CPU	Measurement conditions	Performance value		Number of scans
		Processing time	Maximum scan time	
FX5UJ	Parameter initialization	160 ms	0.731 ms	305 scans
FX5U, FX5UC ^{*1*2}	Parameter initialization	125 ms	0.534 ms	285 scans

*1 When the program capacity is set to 128 K steps, the processing speed may be reduced.

*2 The labels in the standard area are used.

Error code

Error code (hexadecimal)	Description	Action
None	None	None

2.11 M+FX5PG_WriteFlash (Flash ROM writing)

Overview

Writes positioning data and block start data in the buffer memory to the flash ROM.

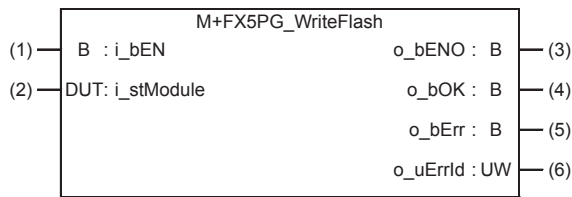

Labels

Input label

No.	Variable name	Name	Data type	Range	Description
(1)	i_bEN	Execution command	Bit	ON, OFF	ON: The FB is activated. OFF: The FB is not activated.
(2)	i_stModule	Module label	Structure	The setting range differs depending on the module label.	Specifies the module label for the positioning module.

Output label

No.	Variable name	Name	Data type	Default value	Description
(3)	o_bENO	Execution status	Bit	OFF	ON: The execution command is ON. OFF: The execution command is OFF.
(4)	o_bOK	Normal completion	Bit	OFF	When this label is ON, it indicates that writing the setting data to the flash ROM has been completed.
(5)	o_bErr	Error completion	Bit	OFF	Always OFF
(6)	o_uErrId	Error code	Word [Unsigned]/Bit String [16-bit]	0	Always 0

Module label

Buffer Memory Addresses	Name (Comment)	Label name	Data type	Initial value	Range	R/W	Description
1950	RW: PLC READY signal (Direct)	FX5PG_□.stSystemControlData_D.uPLCReady_D	Word [Unsigned]/Bit String [16-bit]	0	0 to 1	R/W	A signal for notifying positioning module that the CPU module is normal.
31501.b0	R: BUSY (Direct)	FX5PG_□.stSystemMonitorData2_D.bnBusy_Axis_D[]	Bit	OFF	ON, OFF	R	Turns on at the start of positioning, origin return, and jogging.
1900	RW: Module data backup request (Direct)	FX5PG_□.stSystemControlData_D.uModuleBackupRequest_D	Word [Unsigned]/Bit String [16-bit]	0	0 to 1	R/W	The contents of the buffer memory are written to the flash ROM.

FB details

Available device

■Positioning module

Target module	Firmware Version	Engineering tool
FX5-20PG-P	—	GX Works3 Version 1.035M or later
FX5-20PG-D	—	GX Works3 Version 1.050C or later

■CPU module

MELSEC iQ-F series

Basic specifications

Item	Description
Language	Ladder diagram
Number of steps	68 steps The number of FB steps integrated in the program varies depending on the CPU module used, the input/output definition, and the setting options of GX Works3. For the setting options of GX Works3, refer to GX Works3 Operating Manual.
The amount of label usage	<ul style="list-style-type: none"> Label: 0.01 K point (Word) Latch label: 0 K point (Word) The amount of labels used in the program varies depending on the CPU module used, the device specified in an argument and the option setting of GX Works3. For the option setting of GX Works3, refer to GX Works3 Operating Manual.
The number of index register usage	<ul style="list-style-type: none"> Index register:0 point Long index register:0 point
The amount of file register usage	0 point
FB dependence	No dependence
FB compilation method	Macro type
FB operation	Pulsed execution (multiple scan execution type)

Processing

- By turning on i_bEN (Execution command), the setting data in the buffer memory is written to the flash ROM.

Timing chart of I/O signals

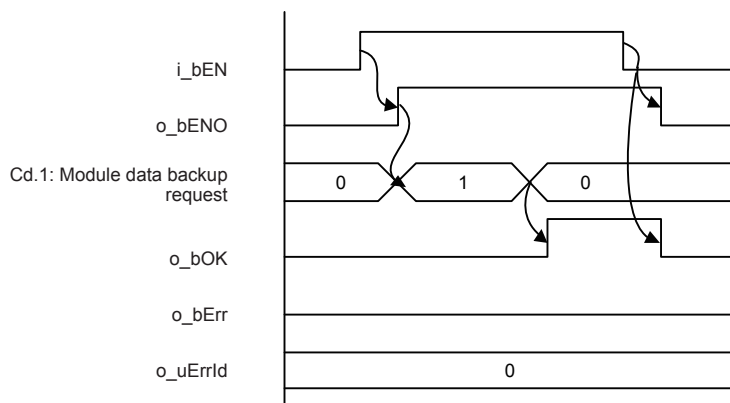

Restrictions or precautions

- This FB does not include the error recovery processing. Program the error recovery processing separately in accordance with the required system operation.
- This FB cannot be used in an interrupt program.
- Do not use this FB in programs that are executed only once, such as a subroutine program or FOR-NEXT loop, because i_bEN (Execution command) cannot be turned off and the normal operation cannot be acquired. Always use this FB in programs that can turn off i_bEN (Execution command).
- Every input must be provided with a value for proper FB operation.
- Before using this FB, check that PLC READY signal (Cd.190: PLC READY signal) is OFF.

Parameter setting

No parameters are required to use this FB.

Performance value

CPU	Measurement conditions	Performance value		Number of scans
		Processing time	Maximum scan time	
FX5UJ	Writing to the flash ROM once	165 ms	0.865 ms	187 scans
	Writing to the flash ROM 25 times	1760 ms	0.862 ms	5176 scans
FX5U, FX5UC ^{*1*2}	Writing to the flash ROM once	150 ms	0.615 ms	312 scans
	Writing to the flash ROM 25 times	1750 ms	0.682 ms	6420 scans

*1 When the program capacity is set to 128 K steps, the processing speed may be reduced.

*2 The labels in the standard area are used.

Error code

Error code (hexadecimal)	Description	Action
None	None	None

2.12 M+FX5PG_ABRST (Absolute position restoration)

Overview

Restores the absolute position.

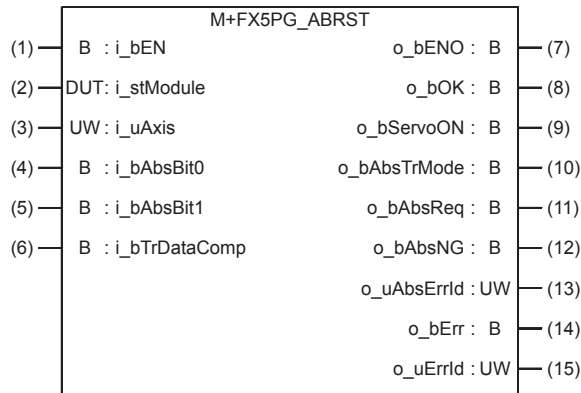

Labels

Input label

No.	Variable name	Name	Data type	Range	Description
(1)	i_bEN	Execution command	Bit	ON, OFF	ON: The FB is activated. OFF: The FB is not activated.
(2)	i_stModule	Module label	Structure	The setting range differs depending on the module label.	Specifies the module label for the positioning module.
(3)	i_uAxis	Target axis	Word [Unsigned]/Bit String [16-bit]	1 to 4	Specify the axis number. The setting range varies according to the positioning module in use.
(4)	i_bAbsBit0	ABS data bit 0	Bit	ON, OFF	The lower bit of the data received from the servo amplifier.
(5)	i_bAbsBit1	ABS data bit 1	Bit	ON, OFF	The upper bit of the data received from the servo amplifier.
(6)	i_bTrDataComp	ABS transmission data ready	Bit	ON, OFF	The ready signal from the servo amplifier.

Output label

No.	Variable name	Name	Data type	Default value	Description
(7)	o_bENO	Execution status	Bit	OFF	ON: The execution command is ON. OFF: The execution command is OFF.
(8)	o_bOK	Normal completion	Bit	OFF	When this label is ON, it indicates that the absolute position restoration request has been completed.
(9)	o_bServoON	Servo ON signal	Bit	OFF	Servo ON signal is ON while this label is ON.
(10)	o_bAbsTrMode	ABS transmission mode	Bit	OFF	The servo amplifier is in the ABS transmission mode while this label is ON.
(11)	o_bAbsReq	ABS request flag	Bit	OFF	The ABS data is requested while this label is ON.
(12)	o_bAbsNG	ABS error	Bit	OFF	When this label is ON, it indicates that the absolute position restoration has been completed with an error.
(13)	o_uAbsErrId	ABS error code	Word [Unsigned]/Bit String [16-bit]	0	The error code of the absolute position restoration instruction is stored. For the error codes, refer to MELSEC iQ-F FX5 Positioning Module User's Manual.
(14)	o_bErr	Error completion	Bit	OFF	When this label is ON, it indicates that an error has occurred in the FB.

No.	Variable name	Name	Data type	Default value	Description
(15)	o_uErrId	Error code	Word [Unsigned]/Bit String [16-bit]	0	Stores the error code that occurred in the FB.

Module label

Buffer Memory Addresses	Name (Comment)	Label name	Data type	Initial value	Range	R/W	Description
H1	Module number	FX5PG_□.uIO	Word [Unsigned]/Bit String [16-bit]	0	1 to 16	R	Set the module number.
31500.b0	R: READY (Direct)	FX5PG_□.stSystemMonitorData2_D.bReady_D	Bit	OFF	ON, OFF	R	Used for interlocking in a program.

FB details

Available device



■ Positioning module

Target module	Firmware Version	Engineering tool
FX5-20PG-P	—	GX Works3 Version 1.035M or later
FX5-20PG-D	—	GX Works3 Version 1.050C or later



■ CPU module

MELSEC iQ-F series

Basic specifications

Item	Description
Language	Ladder diagram
Number of steps	225 steps The number of FB steps integrated in the program varies depending on the CPU module used, the input/output definition, and the setting options of GX Works3. For the setting options of GX Works3, refer to  GX Works3 Operating Manual.
The amount of label usage	<ul style="list-style-type: none"> Label: 0.02 K point (Word) Latch label: 0 K point (Word) The amount of labels used in the program varies depending on the CPU module used, the device specified in an argument and the option setting of GX Works3. For the option setting of GX Works3, refer to  GX Works3 Operating Manual.
The number of index register usage	<ul style="list-style-type: none"> Index register: 0 point Long index register: 0 point
The amount of file register usage	0 point
FB dependence	No dependence
FB compilation method	Macro type
FB operation	Pulsed execution (multiple scan execution type)

Processing

- By turning on i_bEN (Execution command), the absolute position is restored.
- When the absolute position restoration is completed with an error, o_bAbsNG (ABS error) turns on and an error code is stored in o_uAbsErrId (ABS error code). For the error codes, refer to  MELSEC iQ-F FX5 Positioning Module User's Manual.
- If the setting value of the target axis is out of the setting range, o_bErr (Error completion) turns on and the processing of this FB is interrupted. In addition, the error code 100 (hexadecimal) is stored in o_uErrId (Error code). For the error code, refer to  Page 63 Error code.

Timing chart of I/O signals

■ For normal completion

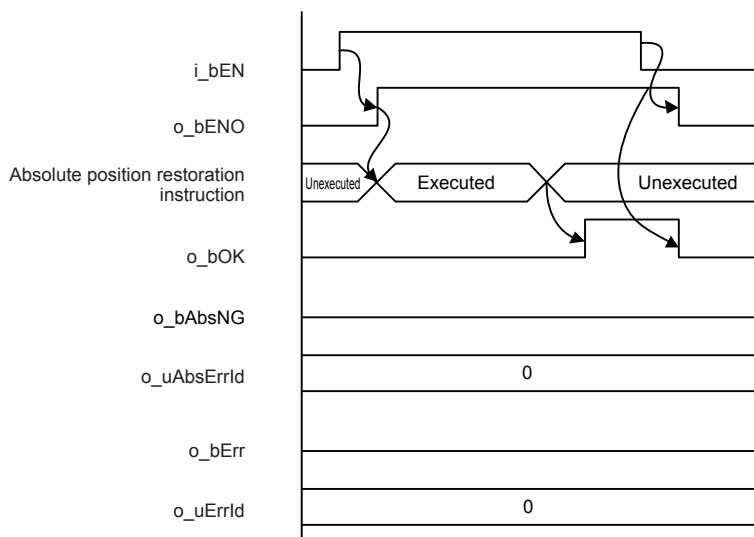

■ For error completion

- Out of the target axis setting range

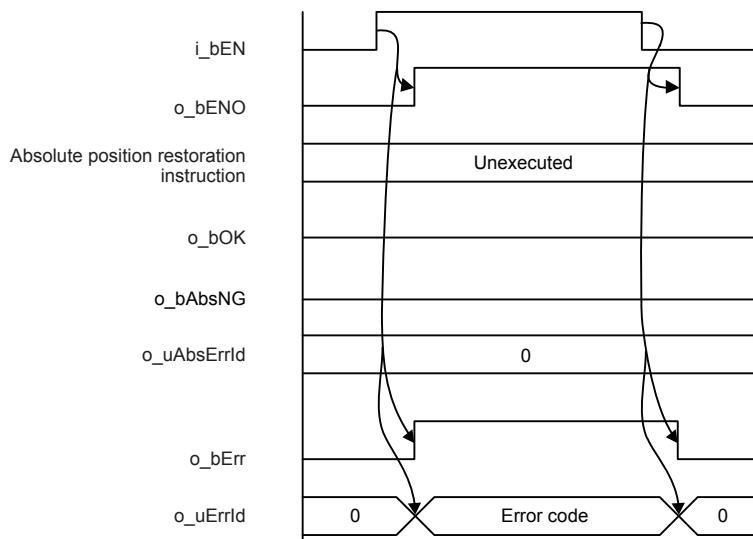

- The absolute position restoration instruction is completed with an error

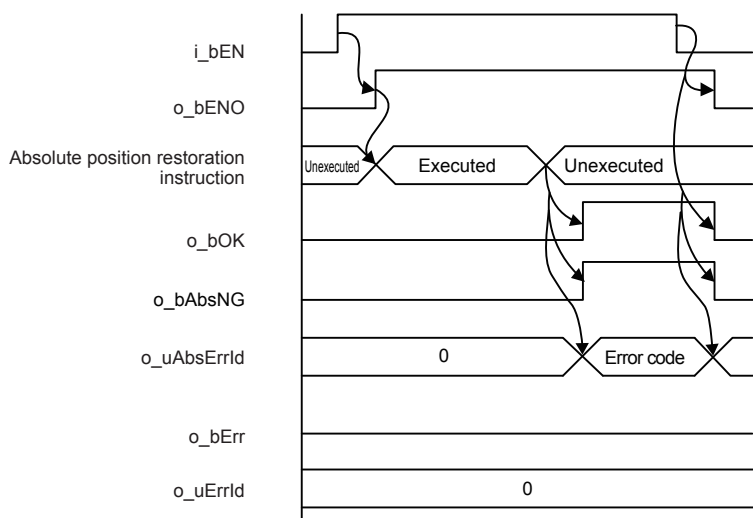

Restrictions or precautions

- This FB does not include the error recovery processing. Program the error recovery processing separately in accordance with the required system operation.
- This FB cannot be used in an interrupt program.
- Do not use this FB in programs that are executed only once, such as a subroutine program or FOR-NEXT loop, because i_bEN (Execution command) cannot be turned off and the normal operation cannot be acquired. Always use this FB in programs that can turn off i_bEN (Execution command).
- When this FB is used twice or more, precaution must be taken to avoid duplication of the target axis.
- Every input must be provided with a value for proper FB operation.
- Before using this FB, check that PLC READY signal (Cd.190: PLC READY signal) is OFF.
- When this FB is used, i_bEN (Execution command) is required to be on even after the absolute position restoration has been completed.
- Do not turn off i_bEN (Execution command) during the absolute position restoration. If i_bEN (Execution command) is turned off before the absolute position restoration is completed, an error occurs when i_bEN (Execution command) is turned on, and the error 1861 (Dedicated instruction error) is stored in o_uAbsErrId (ABS error code). When the error 1861 (Dedicated instruction error) has occurred, reset the error and turn off and on i_bEN (Execution command) again.

Parameter setting

No parameters are required to use this FB.

Performance value

CPU	Measurement conditions	Performance value		Number of scans
		Processing time	Maximum scan time	
FX5UJ	Axis 1 ABS data bit0: ON ABS data bit1: ON	4700 ms	1.18 ms	13510 scans
FX5U, FX5UC ^{*1*2}	Axis 1 ABS data bit0: ON ABS data bit1: ON	4680 ms	1.16 ms	16259 scans

*1 When the program capacity is set to 128 K steps, the processing speed may be reduced.

*2 The labels in the standard area are used.

Error code

Error code (hexadecimal)	Description	Action
100	The set value of i_uAxis (Target axis) is out of the range. The target axis is not within the range of 1 to 4.	Try again after checking the setting.

2.13 M+FX5PG_StartAddressOffsetPositioning (Address offset positioning)

Overview

The following axis starts after the preceding axis has started and moved the set movement amount.

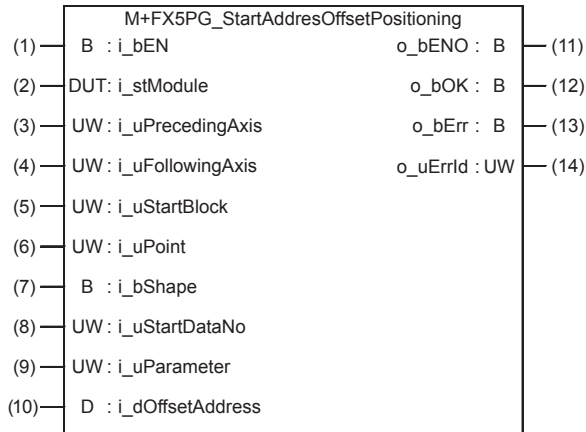

Labels

Input label

No.	Variable name	Name	Data type	Range	Description
(1)	i_bEN	Execution command	Bit	ON, OFF	ON: The FB is activated. OFF: The FB is not activated.
(2)	i_stModule	Module label	Structure	The setting range differs depending on the module label.	Specifies the module label for the positioning module.
(3)	i_uPrecedingAxis	Preceding axis	Word [Unsigned]/Bit String [16-bit]	1 to 4	Specify the number of the preceding axis. The setting range varies according to the positioning module in use.
(4)	i_uFollowingAxis	Following axis	Word [Unsigned]/Bit String [16-bit]	1 to 4	Specify the number of the following axis. The setting range varies according to the positioning module in use.
(5)	i_uStartBlock	Start block	Word [Unsigned]/Bit String [16-bit]	0 to 4	Specify the start block. 0: Start block 0 1: Start block 1 2: Start block 2 3: Start block 3 4: Start block 4
(6)	i_uPoint	Point	Word [Unsigned]/Bit String [16-bit]	1 to 50	Specify the point number.
(7)	i_bShape	Da.11: Shape	Bit	ON, OFF	Set the shape. OFF: End ON: Continuous
(8)	i_uStartDataNo	Da.12: Start data No.	Word [Unsigned]/Bit String [16-bit]	1 to 600	Set the "positioning data No." specified with the "block starting data".
(9)	i_uParameter	Da.14: Parameter (condition data No.)	Word [Unsigned]/Bit String [16-bit]	1 to 10	Set the condition data No.
(10)	i_dOffsetAddress	Offset address	Double word [Signed]	-2147483648 to 2147483647	Set the start timing offset movement amount. (When the preceding axis Pr. 1: unit setting is 2: degree -35999999 to 35999999)

Output label

No.	Variable name	Name	Data type	Default value	Description
(11)	o_bENO	Execution status	Bit	OFF	ON: The execution command is ON. OFF: The execution command is OFF.
(12)	o_bOK	Normal completion	Bit	OFF	When this label is ON, it indicates that the block start for the following axis has finished. However, if a module error occurs when starting, this label will not turn ON.
(13)	o_bErr	Error completion	Bit	OFF	When this label is ON, it indicates that an error has occurred in the FB.
(14)	o_uErrId	Error code	Word [Unsigned]/Bit String [16-bit]	0	Stores the error code that occurred in the FB.

Module label

Buffer Memory Addresses	Name (Comment)	Label name	Data type	Initial value	Range	R/W	Description
H1	Module number	FX5PG_□.uO	Word [Unsigned]/Bit String [16-bit]	0	1 to 16	R	Set the module number.
0, 150	RW: Unit setting (Direct)	FX5PG_□.stnParameter_Axis_D[].uUnitSetting_D	Word [Unsigned]/Bit String [16-bit]	3	0 to 3	R/W	Set the unit of positioning control command. Select mm, inch, degree, or pulse depending on the controlled object.
800, 900	R: Current feed value (Direct)	FX5PG_□.stnAxisMonitorData_Axis_D[].dCurrentFeedValue_D	Double word [Signed]	0	-2147483648 to 2147483647	R	The currently indicated address is stored.
1500, 1600	RW: Positioning start No. (Direct)	FX5PG_□.stnAxisControlData_Ais_D[].uPositioningStartNo_D	Word [Unsigned]/Bit String [16-bit]	0	1 to 600, 7000 to 7004, 9001 to 9004	R/W	Set the positioning start No. (Only 1 to 600 for the read-ahead start function)
1501, 1601	RW: Positioning starting point No. (Direct)	FX5PG_□.stnAxisControlData_Axis_D[].uPositioningStartingPointNo_D	Word [Unsigned]/Bit String [16-bit]	0	1 to 50	R/W	Set the "start point No. (1 to 50)" for executing the block start (positioning).
31500.b0	R: READY (Direct)	FX5PG_□.stSystemMonitorData2_D.bReady_D	Bit	OFF	ON, OFF	R	Used for interlocking in a program.
31501.b0	R: BUSY (Direct)	FX5PG_□.stSystemMonitorData2_D.bnBusy_Axis_D[]	Bit	OFF	ON, OFF	R	Turns on at the start of positioning, origin return, and jogging.
30104, 30114	RW: Positioning start signal (Direct)	FX5PG_□.stnAxisControlData2_Axis_D[].uPositioningStart_D	Word [Unsigned]/Bit String [16-bit]	0	0 to 1	R/W	Enabled at the startup to start.
817, 917	R: Status (Direct)	FX5PG_□.stnAxisMonitorData_Axis_D[].uStatus_D	Word [Unsigned]/Bit String [16-bit]	0008H	—	R	Stores the ON/OFF status of each flag. b14: Completion of start Turns on at the start of positioning.

FB details

Available device



■Positioning module

Target module	Firmware Version	Engineering tool
FX5-20PG-P	—	GX Works3 Version 1.035M or later
FX5-20PG-D	—	GX Works3 Version 1.050C or later

■CPU module

MELSEC iQ-F series

Basic specifications

Item	Description
Language	Ladder diagram
Number of steps	671 steps The number of FB steps integrated in the program varies depending on the CPU module used, the input/output definition, and the setting options of GX Works3. For the setting options of GX Works3, refer to  GX Works3 Operating Manual.
The amount of label usage	<ul style="list-style-type: none">• Label: 0.03 K point (Word)• Latch label: 0 K point (Word) The amount of labels used in the program varies depending on the CPU module used, the device specified in an argument and the option setting of GX Works3. For the option setting of GX Works3, refer to  GX Works3 Operating Manual.
The number of index register usage	<ul style="list-style-type: none">• Index register:0 point• Long index register:0 point
The amount of file register usage	0 point
FB dependence	No dependence
FB compilation method	Macro type
FB operation	Pulsed execution (multiple scan execution type)

Processing

- By turning `i_bEN` (Execution command) ON, the settings are made to start the following axis after the preceding axis has moved the set movement amount.

When the offset address is a positive value.

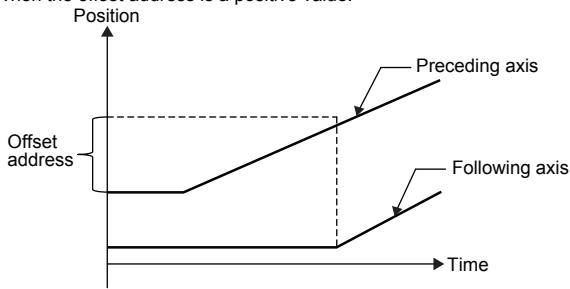

When the offset address is a negative value.

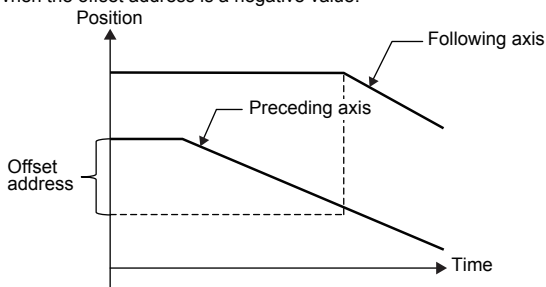

- When `i_bEN` (Execution command) turns ON, the following axis will move only when all of the following conditions are satisfied. If the conditions are not satisfied, `o_bErr` (Error completion) turns ON and the processing of this FB is interrupted. In addition, error code 200 (hexadecimal) is stored in `o_uErrId` (Error code). For details on the error code, refer to the [Page 70 Error code](#). (The conditions are Positioning module ready signal (Md.140: Module status.b0): ON, Positioning start signal (Cd.184: Positioning start signal): OFF, Start complete signal (Md.31: Status.b14): OFF, and BUSY signal (Md.141: BUSY.b0, b1): OFF)
- If the set value of the preceding axis is out of the range, `o_bErr` (Error completion) turns ON, and processing of this FB is interrupted. In addition, error code 103 (hexadecimal) is stored in `o_uErrId` (Error code). For details on the error code, refer to the [Page 70 Error code](#).
- If the set value of the following axis is out of the range, `o_bErr` (Error completion) turns ON, and processing of this FB is interrupted. In addition, error code 104 (hexadecimal) is stored in `o_uErrId` (Error code). For details on the error code, refer to the [Page 70 Error code](#).
- If the same axis number is set for the preceding axis and following axis, `o_bErr` (Error completion) turns ON, and processing of this FB is interrupted. In addition, error code 105 (hexadecimal) is stored in `o_uErrId` (Error code). For details on the error code, refer to the [Page 70 Error code](#).
- If the set value of the start block is out of the range, `o_bErr` (Error completion) turns ON, and processing of this FB is interrupted. In addition, error code 106 (hexadecimal) is stored in `o_uErrId` (Error code). For details on the error code, refer to the [Page 70 Error code](#).
- If the set value of the point is out of the range, `o_bErr` (Error completion) turns ON, and processing of this FB is interrupted. In addition, error code 107 (hexadecimal) is stored in `o_uErrId` (Error code). For details on the error code, refer to the [Page 70 Error code](#).
- If the set value of the start data No. is out of the range, `o_bErr` (Error completion) turns ON, and processing of this FB is interrupted. In addition, error code 108 (hexadecimal) is stored in `o_uErrId` (Error code). For details on the error code, refer to the [Page 70 Error code](#).
- If the set value of the condition data No. is out of the range, `o_bErr` (Error completion) turns ON, and processing of this FB is interrupted. In addition, error code 109 (hexadecimal) is stored in `o_uErrId` (Error code). For details on the error code, refer to the [Page 70 Error code](#).
- If the set value of the offset address is out of the range (only when preceding axis Pr. 1: unit setting is 2: degree), or when the value obtained by adding the preceding axis feed current value to the offset address is out of the range, `o_bErr` (Error completion) turns ON, and processing of this FB is interrupted. In addition, error code 10A (hexadecimal) is stored in `o_uErrId` (Error code). For details on the error code, refer to the [Page 70 Error code](#).

Timing chart of I/O signals

■ For normal completion

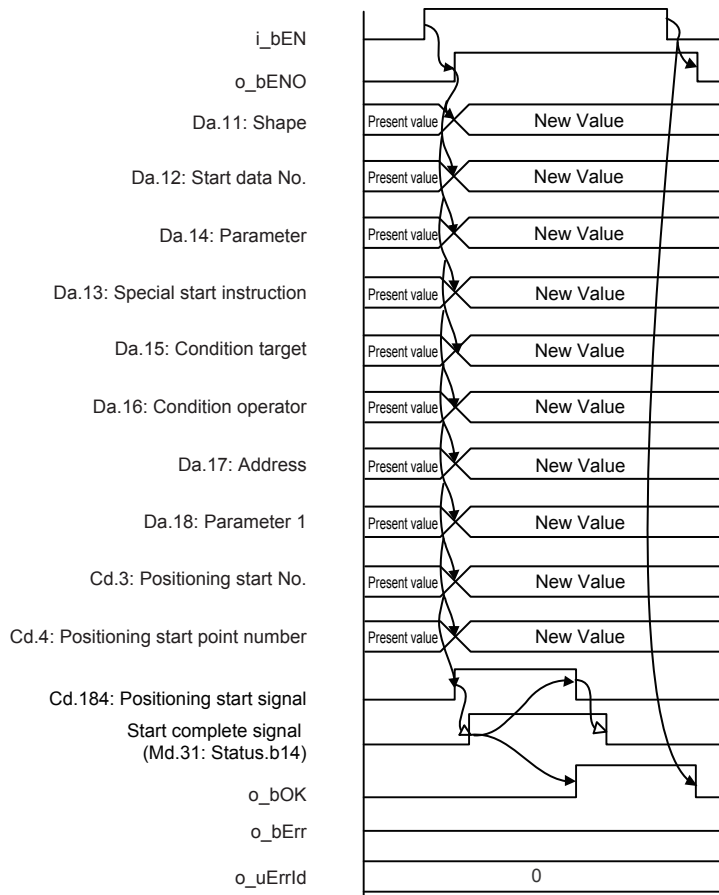

■ For error completion

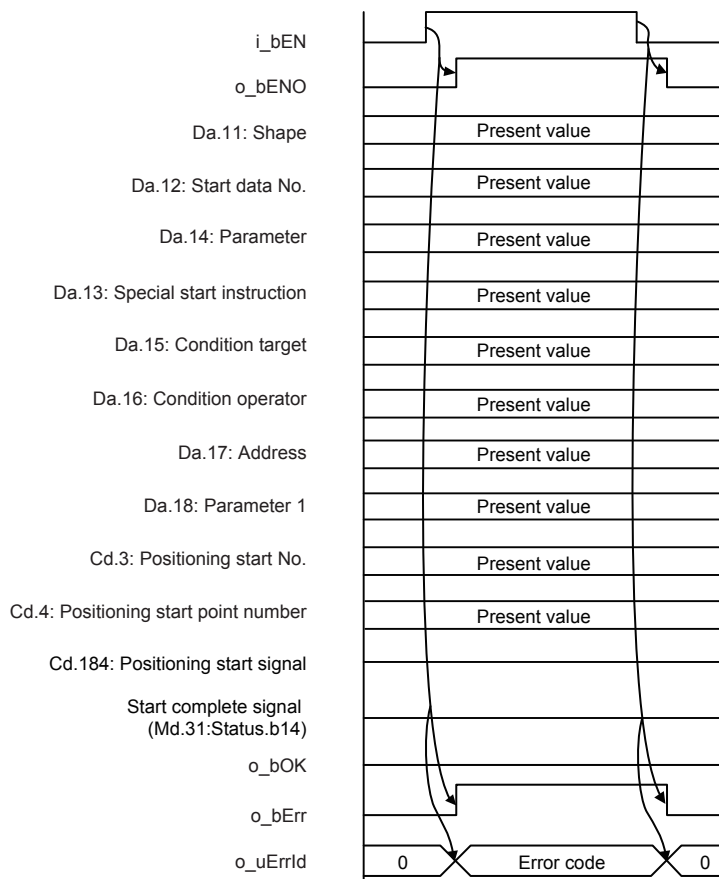

Restrictions or precautions

- This FB does not include the error recovery processing. Program the error recovery processing separately in accordance with the required system operation.
- This FB cannot be used in an interrupt program.
- Do not use this FB in programs that are executed only once, such as a subroutine program or FOR-NEXT loop, because i_bEN (Execution command) cannot be turned off and the normal operation cannot be acquired. Always use this FB in programs that can turn off i_bEN (Execution command).
- The positioning operation for the preceding axis is not started with this FB. Confirm that this FB o_bOK (Normal completion) turns ON, and then start operation of the preceding axis with the customer's program.
- Do not move the preceding axis in the direction opposite the direction set with the i_dOffsetAddress (Offset address) after this FB is executed.
- If the value obtained by adding the i_dOffset Address (Offset address) to the preceding axis feed current value is close to -2147483648 or 2147483647 (0 or 359999999 when preceding axis Pr. 1 unit setting is 2: degree), there may be cases when the following axis does not start even after the preceding axis moves by the i_dOffsetAddress (Offset address) amount.
- When i_dOffsetAddress (Offset address) is set to 0, the following axis will start operation immediately after the preceding axis starts regardless of the direction that the preceding axis moves. (The preceding axis and following axis do not start at a simultaneous timing. Instead, the following axis starts with a delay.)
- Every input must be provided with a value for proper FB operation.

Parameter setting

No parameters are required to use this FB.

Performance value

CPU	Measurement conditions	Performance value		Number of scans
		Processing time	Maximum scan time	
FX5UJ	Confirmation of operation of axis 1	1.170 ms	1.060 ms	1 scan
FX5U, FX5UC ^{*1*2}	Confirmation of operation of axis 1	0.802 ms	0.833 ms	1 scan

*1 When the program capacity is set to 128 K steps, the processing speed may be reduced.

*2 The labels in the standard area are used.

Error code

Error code (hexadecimal)	Description	Action
103	The i_uPrecedingAxis (Preceding axis) setting value is out of the setting range. The preceding axis is not set between 1 and 4.	Try again after checking the setting.
104	The i_uFollowingAxis (Following axis) setting value is out of the setting range. The following axis is not set between 1 and 4.	Try again after checking the setting.
105	The i_uPrecedingAxis (Preceding axis) and i_uFollowingAxis (Following axis) setting values are set to the same axis.	Try again after checking the setting.
106	The i_uStartBlock (Start block) setting value is out of the range. The start block is not set between 0 and 4.	Try again after checking the setting.
107	The i_uPoint (Point number) setting value is out of the range. The point number is not set between 1 and 50.	Try again after checking the setting.
108	i_uStartDataNo(Da.12: Start data No.) setting is out of the range. The start data is not set between 1 and 600.	Try again after checking the setting.
109	The i_uParameter (Condition data No.) setting value is out of the range. The condition data No. is not set between 1 and 10.	Try again after checking the setting.
10A	The i_dOffsetAddress (Offset address) setting value is out of the range. The value obtained by adding the offset address to the preceding axis feed current value is not set between -2147483648 to 2147483647(when Pr.1: unit setting is 2: unit setting is 2: degree, 0 to 35999999).	Try again after checking the setting.
200	The conditions for positioning start are not satisfied. Some of the following conditions are not satisfied. <ul style="list-style-type: none"> • Ready: ON • Positioning start signal: OFF • Start complete signal: OFF • BUSY signal: OFF 	Execute the FB again when all of the following conditions are satisfied. <ul style="list-style-type: none"> • Ready: ON • Positioning start signal: OFF • Start complete signal: OFF • BUSY signal: OFF

2.14 M+FX5PG_SetTimeOffsetPositioning (Time offset positioning)

Overview

The following axis starts after the set time has elapsed from the start of the preceding axis.

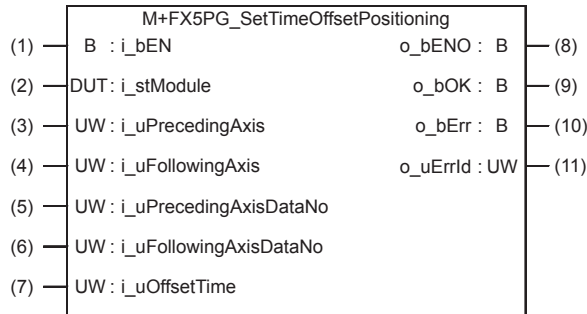

Labels

Input label

No.	Variable name	Name	Data type	Range	Description
(1)	i_bEN	Execution command	Bit	ON, OFF	ON: The FB is activated. OFF: The FB is not activated.
(2)	i_stModule	Module label	Structure	The setting range differs depending on the module label.	Specifies the module label for the positioning module.
(3)	i_uPrecedingAxis	Preceding axis	Word [Unsigned]/Bit String [16-bit]	1 to 4	Specify the number of the preceding axis. The setting range varies according to the positioning module in use.
(4)	i_uFollowingAxis	Following axis	Word [Unsigned]/Bit String [16-bit]	1 to 4	Specify the number of the following axis. The setting range varies according to the positioning module in use.
(5)	i_uPrecedingAxisDataNo	Preceding axis data No.	Word [Unsigned]/Bit String [16-bit]	1 to 600	Set the positioning data No. for the preceding axis.
(6)	i_uFollowingAxisDataNo	Following axis data No.	Word [Unsigned]/Bit String [16-bit]	1 to 600	Set the positioning data No. for the following axis.
(7)	i_uOffsetTime	Offset time	Word [Unsigned]/Bit String [16-bit]	0 to 65535 ms	Set the start timing offset time.

Output label

No.	Variable name	Name	Data type	Default value	Description
(8)	o_bENO	Execution status	Bit	OFF	ON: The execution command is ON. OFF: The execution command is OFF.
(9)	o_bOK	Normal completion	Bit	OFF	When this label is ON, it indicates that the positioning data setting has been completed.
(10)	o_bErr	Error completion	Bit	OFF	When this label is ON, it indicates that an error has occurred in the FB.
(11)	o_uErrId	Error code	Word [Unsigned]/Bit String [16-bit]	0	Stores the error code that occurred in the FB.

Module label

Buffer Memory Addresses	Name (Comment)	Label name	Data type	Initial value	Range	R/W	Description
H1	Module number	FX5PG_□.uIO	Word [Unsigned]/Bit String [16-bit]	0	1 to 16	R	Set the module number.
1540, 1640	RW: Simultaneous starting axis start data No. (axis 1 start data No.) (Direct)	FX5PG_□.stnAxisControlData_Axis_D[].uSimultaneousStartingAxisStartDataNo_Axis1_D	Word [Unsigned]/Bit String [16-bit]	0	1 to 600	R/W	Set the start data No. of the simultaneous start target axis.
1541, 1641	RW: Simultaneous starting axis start data No. (axis 2 start data No.) (Direct)	FX5PG_□.stnAxisControlData_Axis_D[].uSimultaneousStartingAxisStartDataNo_Axis2_D	Word [Unsigned]/Bit String [16-bit]	0	1 to 600	R/W	Set the start data No. of the simultaneous start target axis.
1542, 1642	RW: Simultaneous starting axis start data No. (axis 3 start data No.) (Direct)	FX5PG_□.stnAxisControlData_Axis_D[].uSimultaneousStartingAxisStartDataNo_Axis3_D	Word [Unsigned]/Bit String [16-bit]	0	1 to 600	R/W	Set the start data No. of the simultaneous start target axis.
1543, 1643	RW: Simultaneous starting axis start data No. (axis 4 start data No.) (Direct)	FX5PG_□.stnAxisControlData_Axis_D[].uSimultaneousStartingAxisStartDataNo_Axis4_D	Word [Unsigned]/Bit String [16-bit]	0	1 to 600	R/W	Set the start data No. of the simultaneous start target axis.

FB details

Available device



■ Positioning module

Target module	Firmware Version	Engineering tool
FX5-20PG-P	—	GX Works3 Version 1.035M or later
FX5-20PG-D	—	GX Works3 Version 1.050C or later

■ CPU module

MELSEC iQ-F series

Basic specifications

Item	Description
Language	Ladder diagram
Number of steps	384 steps The number of FB steps integrated in the program varies depending on the CPU module used, the input/output definition, and the setting options of GX Works3. For the setting options of GX Works3, refer to  GX Works3 Operating Manual.
The amount of label usage	<ul style="list-style-type: none"> Label: 0.02 K point (Word) Latch label: 0 K point (Word) The amount of labels used in the program varies depending on the CPU module used, the device specified in an argument and the option setting of GX Works3. For the option setting of GX Works3, refer to  GX Works3 Operating Manual.
The number of index register usage	<ul style="list-style-type: none"> Index register: 0 point Long index register: 0 point
The amount of file register usage	0 point
FB dependence	No dependence
FB compilation method	Macro type
FB operation	Pulsed execution (single scan execution type)

Processing

- By turning `i_bEN` (Execution command) ON, the settings are made to start the following axis (Following axis) after the set time since the preceding axis (Preceding axis) has started.

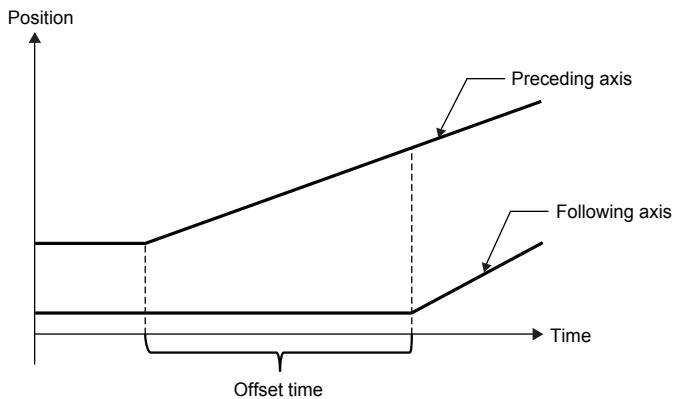

- If the set value of the preceding axis is out of the range, `o_bErr` (Error completion) turns ON, and processing of this FB is interrupted. In addition, error code 103 (hexadecimal) is stored in `o_uErrId` (Error code). For details on the error code, refer to the [Page 77 Error code](#).
- If the set value of the following axis is out of the range, `o_bErr` (Error completion) turns ON, and processing of this FB is interrupted. In addition, error code 104 (hexadecimal) is stored in `o_uErrId` (Error code). For details on the error code, refer to the [Page 77 Error code](#).
- If the same axis number is set for the preceding axis and following axis, `o_bErr` (Error completion) turns ON, and processing of this FB is interrupted. In addition, error code 105 (hexadecimal) is stored in `o_uErrId` (Error code). For details on the error code, refer to the [Page 77 Error code](#).
- If the set value of the preceding axis positioning data No. is out of the range, `o_bErr` (Error completion) turns ON, and processing of this FB is interrupted. In addition, error code 10B (hexadecimal) is stored in `o_uErrId` (Error code). For details on the error code, refer to the [Page 77 Error code](#).
- If the set value of the following axis positioning data No. is out of the range, `o_bErr` (Error completion) turns ON, and processing of this FB is interrupted. In addition, error code 10C (hexadecimal) is stored in `o_uErrId` (Error code). For details on the error code, refer to the [Page 77 Error code](#).

Timing chart of I/O signals

■ For normal completion

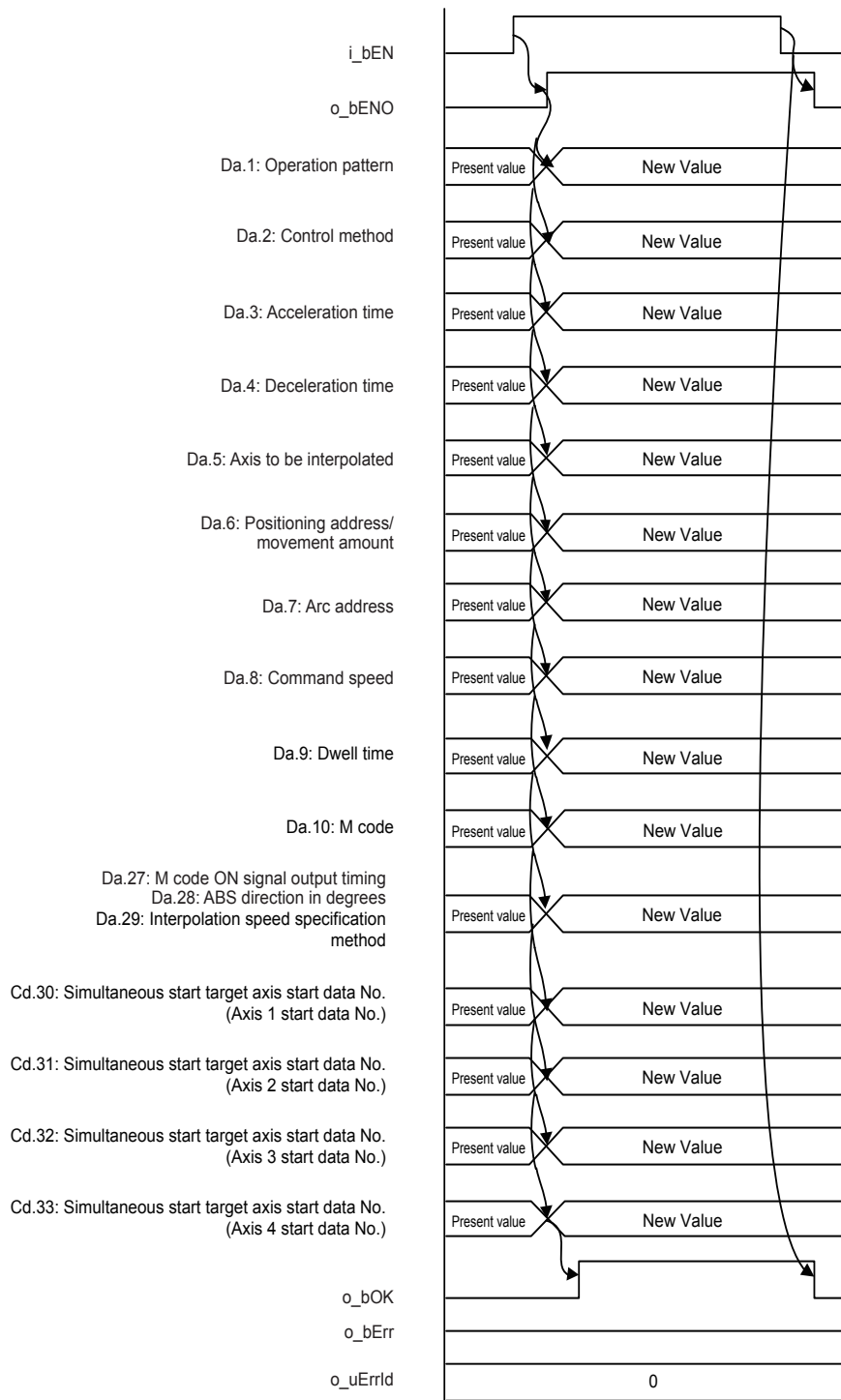

■ For error completion

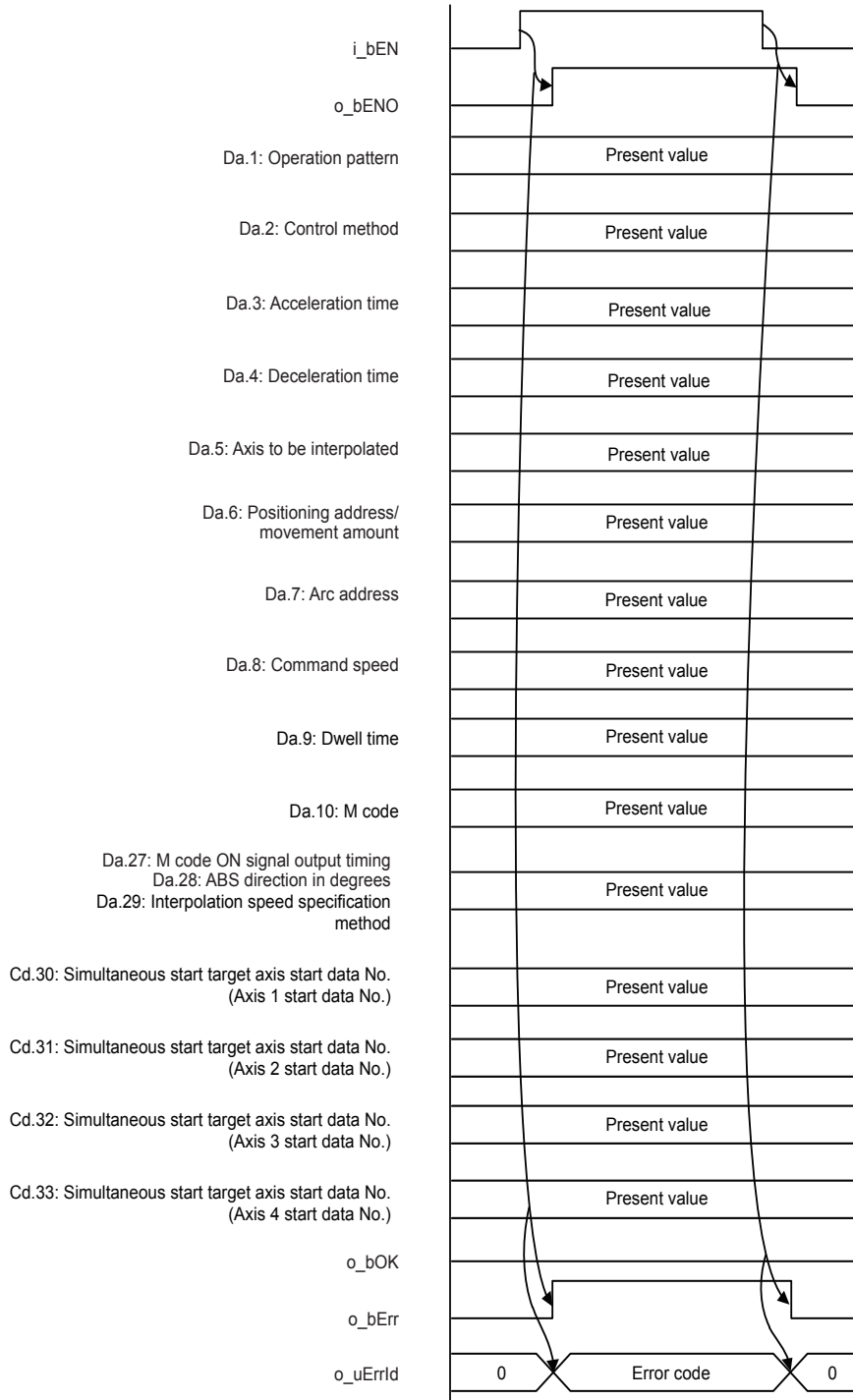

Restrictions or precautions

- This FB does not include the error recovery processing. Program the error recovery processing separately in accordance with the required system operation.
- This FB cannot be used in an interrupt program.
- Do not use this FB in programs that are executed only once, such as a subroutine program or FOR-NEXT loop, because i_bEN (Execution command) cannot be turned off and the normal operation cannot be acquired. Always use this FB in programs that can turn off i_bEN (Execution command).
- The positioning operation is not started with this FB. Confirm that o_bOK (Normal completion) for this FB has turned ON, and then set 9004 (multiple axis simultaneous start) in the preceding axis Cd.3: Positioning start No. using the customer's program. Then, start operation.
- With this FB, the positioning data of the one before the positioning data No. of the following axis is used, so do not change the positioning data for the corresponding data after this FB has been executed. (If 1 is set for the following axis positioning data No., the No. 600 positioning data will be used.)
- If i_uOffsetTime (Offset time) is set to 0, the following axis will start movement immediately after the preceding axis starts. (The preceding axis and following axis do not start at a simultaneous timing. Instead, the following axis starts with a delay.)
- Every input must be provided with a value for proper FB operation.

Parameter setting

No parameters are required to use this FB.

Performance value

CPU	Measurement conditions	Performance value		Number of scans
		Processing time	Maximum scan time	
FX5UJ	Preceding axis: 2 Following axis: 1 Preceding axis data No.: 3 Following axis data No.: 1 Offset time: 0ms	0.398 ms	0.716 ms	1 scan
	Preceding axis: 2 Following axis: 1 Preceding axis data No.: 3 Following axis data No.: 1 Offset time: 65535ms	0.395 ms	0.878 ms	1 scan
FX5U, FX5UC ^{*1,2}	Preceding axis: 2 Following axis: 1 Preceding axis data No.: 3 Following axis data No.: 1 Offset time: 0ms	0.135 ms	0.656 ms	1 scan
	Preceding axis: 2 Following axis: 1 Preceding axis data No.: 3 Following axis data No.: 1 Offset time: 65535ms	0.136 ms	0.653 ms	1 scan

*1 When the program capacity is set to 128 K steps, the processing speed may be reduced.

*2 The labels in the standard area are used.

*3 For the positioning data No.1 for measurement of the performance values, refer to  Page 17 Performance value.
Set the positioning data No.3 as shown below.

Item name	Set value
Da.1: Operation pattern	K0
Da.2: Control method	K0
Da.3: Acceleration time No.	K0
Da.4: Deceleration time No.	K0
Da.5: Axis to be interpolated	K0
Da.10: M code	K0
Da.9: Dwell time	K0
Da.27: M code ON signal output timing	K0

Item name	Set value
Da.28: ABS direction in degrees	K0
Da.29: Interpolation speed specification method	K0
Da.8: Command speed	K0
Da.6: Positioning address	K0
Da.7: Arc address	K0

Error code

Error code (hexadecimal)	Description	Action
103	The i_uPrecedingAxis (Preceding axis) setting value is out of the setting range. The preceding axis is not set between 1 and 4.	Try again after checking the setting.
104	The i_uFollowingAxis (Following axis) setting value is out of the setting range. The following axis is not set between 1 and 4.	Try again after checking the setting.
105	The i_uPrecedingAxis (Preceding axis) and i_uFollowingAxis (following axis) setting values are set to the same axis.	Try again after checking the setting.
10B	The i_uPrecedingAxisDataNo (Preceding axis data No.) setting value is out of the setting range. The preceding axis positioning data No. is not set between 1 and 600.	Try again after checking the setting.
10C	The i_uPrecedingAxisDataNo (Following axis data No.) setting value is out of the setting range. The following axis positioning data No. is not set between 1 and 600.	Try again after checking the setting.

3 EXAMPLE OF USE

3.1 M+FX5PG_StartPositioning (Positioning start)

When the parameters are used

System Configuration

Refer to  Page 9 System Configuration

Outline of example of program (when the parameters are used)

The operation pattern is set to the continuous positioning control using the axis 1 of positioning module, and 1000 pulses are output to the drive module to drive the motor for moving the object 1000 pulses in the positive direction from the current position.

The command speed, 100 (pulse/s), will be attained after 1000 ms, the speed will be decelerated near the target position after 1000 ms, and the object will reach the positioning address. Then, the positioning will be completed after the dwell time of 1 ms.

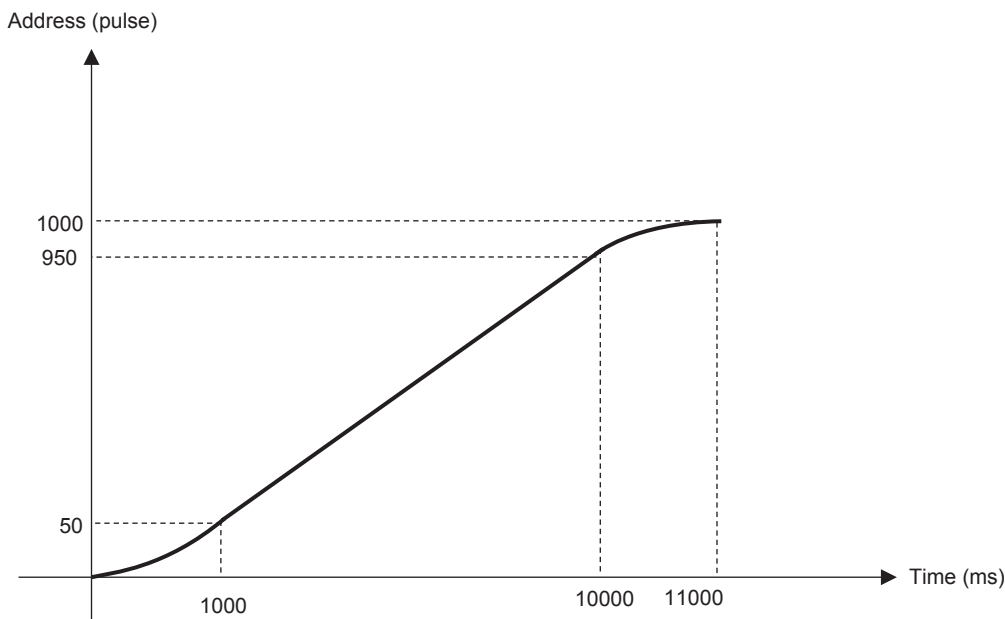
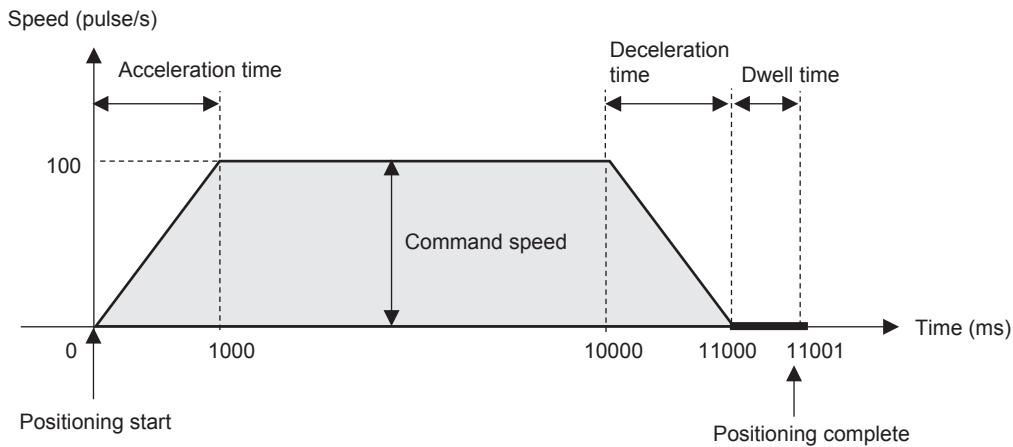

Parameter setting

Set the parameters by using GX Works3 as shown in the following figure. For the setting procedure, refer to [Page 16](#) Parameter setting.

No.	1	2	3	4	5	6	7	8	9	10		
No.	Operation pattern	Control method	Acceleration time No.	Deceleration time No.	Positioning address	Arc address	Command speed	Dwell time	M code	M code ON signal output timing	ABS direction in degrees	Interpolation speed specification method
1	0: Positioning con	01H: ABS1	1-a	2: Acceleration time	2: Deceleration time	1 pulse	1 pulse/s	0 ms	0	0: Use the set value of M code	C: ABS clockwise	
Positioning comment												
2												
Positioning comment												
3												
Positioning comment												
4												
Positioning comment												

No.	Item name	Description
1	Operation pattern	Set to the continuous positioning control.
2	Control method	Set to the linear control (ABS) of axis 1.
3	Acceleration time No.	Set the acceleration time No. to 3.
4	Deceleration time No.	Set the deceleration time No. to 3.
5	Positioning address	Set 1000 pulses.
6	Command speed	Set 100 pulses/s.
7	Dwell time	Set 1 ms.
8	M code	Set 0.
9	M code ON signal output timing	Set 0.
10	ABS direction in degrees	Set the ABS clockwise rotation.

Program

• Positioning start

The operation pattern is set to the continuous positioning control using M+FX5PG_StartPositioning (positioning start), and 1000 pulses are output to the drive module with the acceleration/deceleration time of 1000 ms and the command speed of 100 (pulses/s) to drive the motor. The positioning complete signal will turn on 1 ms after the completion of positioning output.

• Axis number Settings

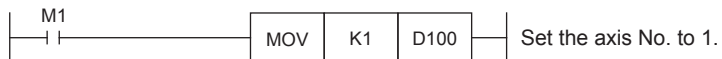

• Positioning start No. Settings

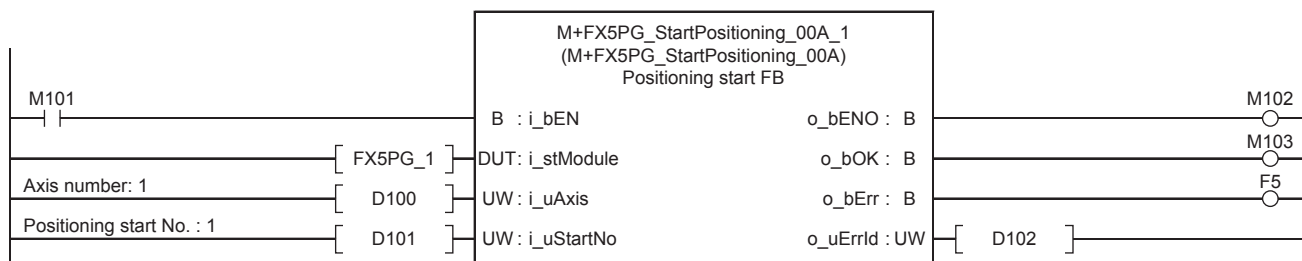
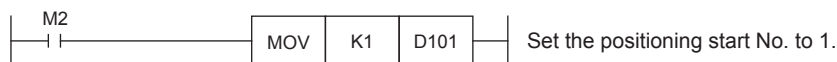

When the public labels are used

System Configuration

Refer to  Page 9 System Configuration

Outline of example of program (when the public labels are used)

Refer to  Page 78 When the parameters are used

Parameter setting

Since the public labels are used for setting, no parameter setting is required.

Program

- Public label Settings

Set the positioning data values to be written to the buffer memory on the public labels by using M+FX5PG_SetPositioningData (positioning data setting).

Label	Device/label Setting	Set value	Description
pb_uOpePattern	Da.1: Operation pattern	K1	Set to the continuous positioning control.
pb_uCtrlSys	Da.2: Control method	H1	Set to the linear control (ABS) of axis 1.
pb_uAccTimeNo	Da.3: Acceleration time No.	K3	Set the acceleration time No. to 3. The default value is 1000 ms.
pb_uDecTimeNo	Da.4: Deceleration time No.	K3	Set the deceleration time No. to 3. The default value is 1000 ms.
pb_uInterpolatedAx	Da.5: Axis to be interpolated	K0	Set K0 because interpolation is not used.
pb_uMcode	Da.10: M code	K0	Set K0 because the M code is not used.
pb_uDwellTime	Da.9: Dwell time	K1	Set the dwell time to 1 ms.
pb_uMcodeOnTiming	Da.27: M code ON signal output timing	K0	Set K0 as the set value of M code ON signal output timing.
pb_uABS	Da.28: ABS direction in degrees	K1	Set K1.
pb_uInterpolateSpd	Da.29: Interpolation speed specification method	K0	Set K0 because the interpolation axis is not used.
pb_udCmdSpd	Da.8: Command speed	K100	Set the command speed to 100.
pb_dPositAdr	Da.6: Positioning address	K1000	Set the positioning address to 1000.
pb_dArcAdr	Da.7: Arc address	K0	Set K0 because the circular control is not used.

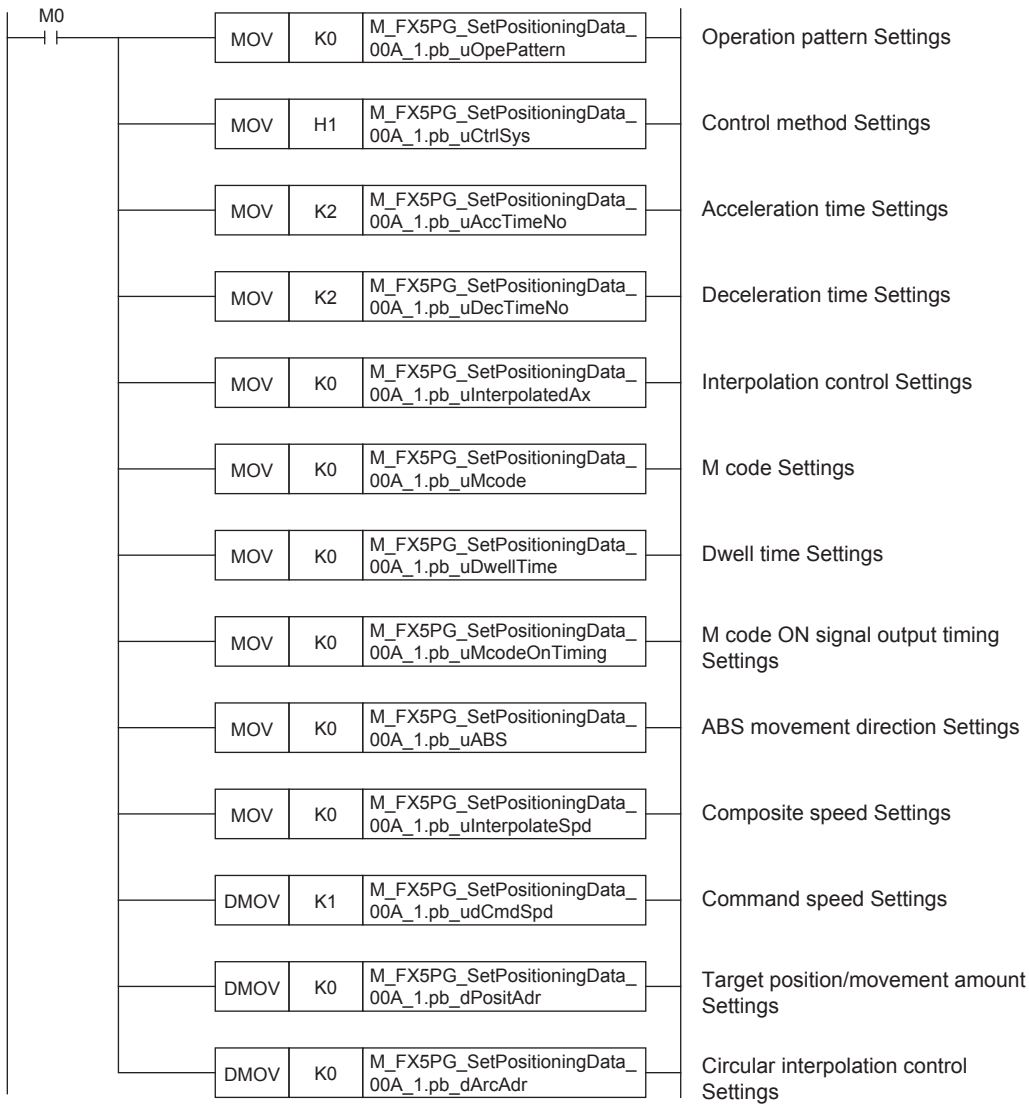

- Positioning data Settings

Write the set public labels to the buffer memory by using M+FX5PG_SetPositioningData (positioning data setting).

- Axis number Settings

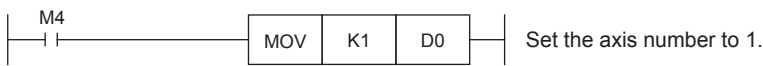

- Positioning data No. Settings

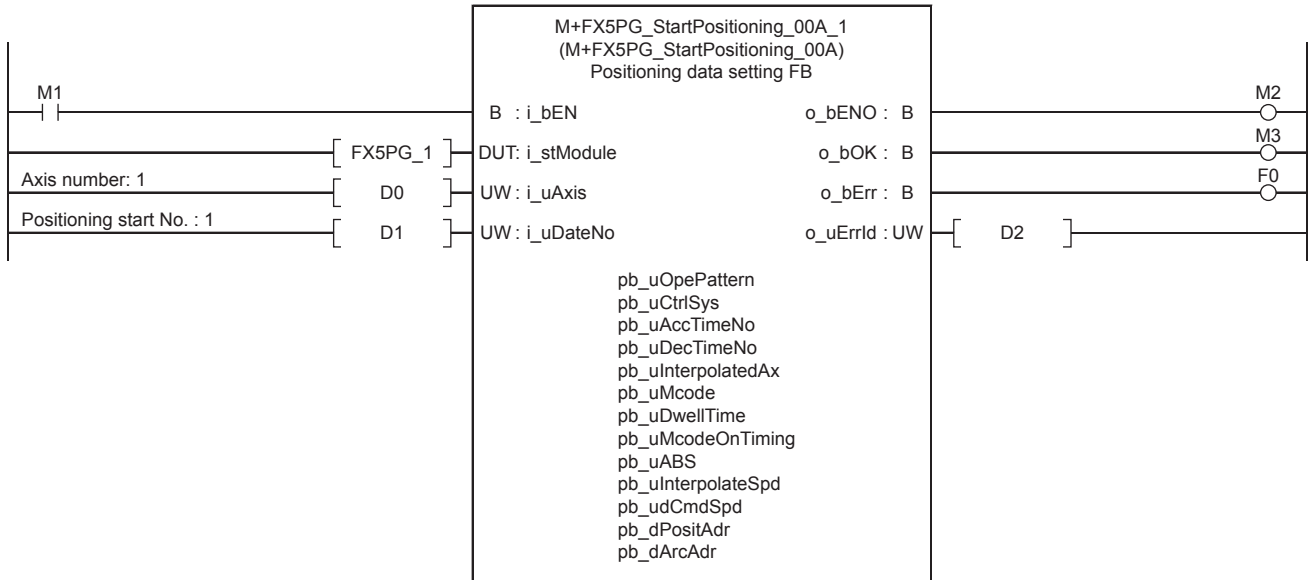
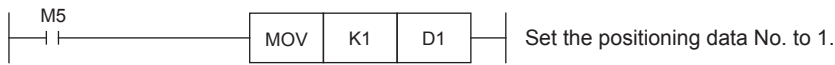

- Positioning start

The operation pattern is set to the continuous positioning control using M+FX5PG_StartPositioning (positioning start), and 1000 pulses are output to the drive module with the acceleration/deceleration time of 1000 ms and the command speed of 100 (pulses/s) to drive the motor. The positioning complete signal will turn on 1 ms after the completion of positioning output.

- Axis number Settings



- Positioning start No. Settings

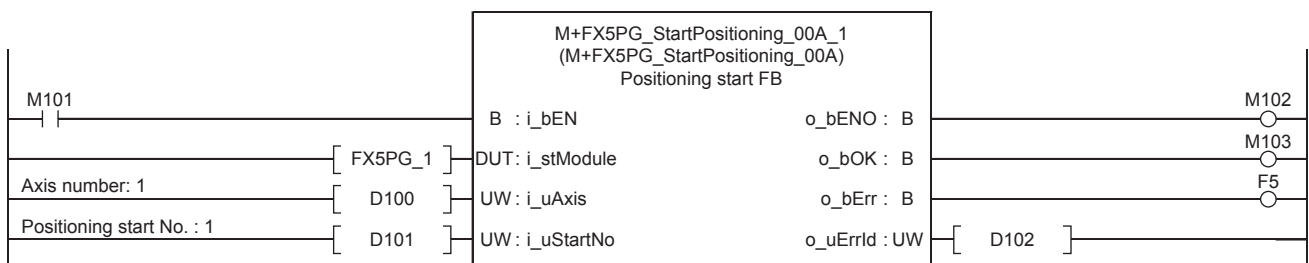
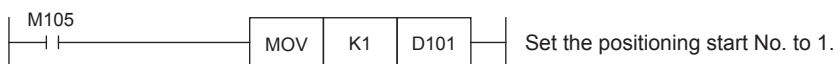

INSTRUCTION INDEX

M

M+FX5PG_ABRST	60
M+FX5PG_ChangeAccDecTime	35
M+FX5PG_ChangePosition	40
M+FX5PG_ChangeSpeed	31
M+FX5PG_InitializeParameter	54
M+FX5PG_JOG	22
M+FX5PG_MPG.	27
M+FX5PG_OperateError	49
M+FX5PG_Restart	45
M+FX5PG_SetPositioningData.	10
M+FX5PG_SetTimeOffsetPositioning	71
M+FX5PG_StartAddressOffsetPositioning	64
M+FX5PG_StartPositioning	18
M+FX5PG_WriteFlash.	57



MEMO

REVISIONS

Revision date	Revision	Description
April 2017	A	First Edition
October 2018	B	■Added or modified parts Chapter 2
October 2019	C	■Added or modified parts SAFETY PRECAUTIONS, INTRODUCTION, RELEVANT MANUALS, TERMS, Generic terms and abbreviations, Chapter 1, 2, 3, TRADEMARKS
April 2022	D	■Added or modified parts RELEVANT MANUALS, TERMS
October 2023	E	■Added or modified parts RELEVANT MANUALS, TERMS, GENERIC TERMS AND ABBREVIATIONS, Chapter 2

Japanese manual number: JY997D75001E

This manual confers no industrial property rights or any rights of any other kind, nor does it confer any patent licenses. Mitsubishi Electric Corporation cannot be held responsible for any problems involving industrial property rights which may occur as a result of using the contents noted in this manual.

© 2017 MITSUBISHI ELECTRIC CORPORATION

TRADEMARKS

The company names, system names and product names mentioned in this manual are either registered trademarks or trademarks of their respective companies.

In some cases, trademark symbols such as [™] or [®] are not specified in this manual.

Manual number: JY997D75101E

MITSUBISHI ELECTRIC CORPORATION

HEAD OFFICE: TOKYO BLDG., 2-7-3, MARUNOUCHI, CHIYODA-KU, TOKYO 100-8310, JAPAN
NAGOYA WORKS: 1-14, YADA-MINAMI 5-CHOME, HIGASHI-KU, NAGOYA 461-8670, JAPAN

When exported from Japan, this manual does not require application to the
Ministry of Economy, Trade and Industry for service transaction permission.

Specifications subject to change without notice.