



Numerical Protection Relay

MELPRO™-A Series
EARTH FAULT OVER VOLTAGE RELAY
MODEL
MVG-A4V-R, MVG-A4V-RD

INSTRUCTION MANUAL

Request

Ensure that this Instruction Manual is delivered to the end users and the maintenance manager.

— Safety precautions —

Before installation, operation, maintenance, and inspection, please be sure to read this instruction manual and all other attached documents thoroughly in order to work safely with the equipment. Please ensure that you fully understand the equipment, safety information, and precautions that need to be taken before working with the equipment. Safety precautions are classified as “Caution.”

 Caution	The case where a dangerous situation can arise and there is the possibility that moderate or minor injuries can occur, or property damage can take place if the equipment is handled incorrectly.
--	---

Furthermore, even with items described as  Caution, there is the possibility of serious consequences depending on the situation. All of the described contents are important. Therefore, be sure to comply with them.

	Caution
---	----------------

1. Installation and Wiring work

 Caution	<ul style="list-style-type: none"> * Ensure that the equipment is mounted and connected correctly. Otherwise, there are risks of failure, burning, or maloperation. * Securely tighten the terminal connection screws. Otherwise, there are risks of failure and burning. <p>For tightening torque of screws, refer to the following Table.</p>				
	Material	Nominal dia.	Standard value of torque	Allowable range	Place of use
	Steel	M3.5	1.10N·m (11.2kgf·cm)	0.932~1.27N·m (9.5~12.9kgf·cm)	Terminal block
	Steel	M4	1.65N·m (16.8kgf·cm)	1.39~1.89N·m (14.2~19.3kgf·cm)	Drawer fixing screw of unit-drawer type (RD type)
	Steel	M6	5.49N·m (56kgf·cm)	4.71~6.37N·m (48~65kgf·cm)	Fixing screw for mounting
	Steel	M10	26.5N·m (270kgf·cm)	22.6~30.4N·m (230~310kgf·cm)	MPD-3C bottom screw
	Brass	M4	0.961N·m (9.8kgf·cm)	0.824~1.11N·m (8.4~11.3kgf·cm)	MZT primary terminal (k, l) MPD-3T terminal
<ul style="list-style-type: none"> * The equipment must be correctly grounded using the designated grounding terminals where they exist. Failure to do so may lead to the risk of electric shock, equipment failure, malfunction or failure to operate. * Ensure that the equipment is connected correctly in accordance with the details (e.g.: polarity or phase sequence) shown on the connection terminals. Otherwise, there is the risk of failure, burning, malfunction, or maloperation. * All power supplies and transformers to the equipment must be of suitable capacity and rated load to avoid the risk of malfunction and maloperation. * Be sure to return all terminal covers, protection covers to their original positions once any work is complete. If they remain uncovered there is a risk of electrical shock. * The appropriate connectors must be used to ensure compatibility with the connector terminals to avoid the risks of failure or fire. * When inserting subunit into the case, please ensure that there is no gap between front side of the subunit and the case. In addition, tighten lower screw surely. If the subunit is inserted inadequately, there are risks of malfunction or generation of heat. 					

2. Operating and Setting

The equipment must be used within the following range limits. Otherwise, there is a risk of reducing the performance and life of the product.

- Variation range of auxiliary power supply voltage Within -15 to +10% of the rated voltage
- Frequency variation Within ±5% of the rated frequency
- Ambient temperature -20 to +60°C
(under the state where dew condensation or freezing does not occur)
- Relative humidity 30 to 80% on daily average
- Altitude 2000m or lower
- The state where abnormal vibration, shock, inclination, magnetic field(※) are not applied
- The state where it is not exposed to harmful smoke/gas, saline gas, water droplet or vapor, excessive dust or fine powder, explosive gas or fine powder, wind & rain

(※) If there is a large amount of current on main circuit surrounding the relay, the operation indicator may be magnetized and turned from black to orange color. In that case, please shield back of the relay by iron plate.

 Caution	<ul style="list-style-type: none"> * The equipment must only be operated and handled by qualified personnel. Otherwise, there are risks of electric shock, injury, failure, malfunction, and maloperation. * Handling and maintenance of the equipment must only be carried out after gaining a thorough understanding of the instruction manual. Otherwise, there is the risk of electric shock, injury, failure, malfunction, or maloperation. * While energized, do not remove any components other than those which have been designated. Otherwise, there is a risk of failure, malfunction, or maloperation. * While energized, do not draw out the internal unit (subunit). Otherwise, there is a risk of electric shock, injury, failure, malfunction, or maloperation. * When changing the setting value during the energized state, ensure that all trip circuits are locked in order not to operate. Otherwise, there is a risk of malfunction. * Use in rated range. Otherwise, there is a risk of malfunction.
--	---

3. Maintenance and Inspection

We recommend that any tests or inspections are carried out under the following conditions, as well as any additional conditions described in the instruction manual.

- Ambient temperature 20±10°C
 - Relative humidity 90% or less
 - External magnetic field 80A/m or less
 - Atmospheric pressure 86~106×10³ Pa
 - Mounting angle Regular direction ±2°
 - Frequency Rated frequency ±1%
 - Waveform (in the case of AC) Distortion factor: 2% or less
- $$\text{Distortion factor} = \frac{\text{Effective value of higher harmonics only}}{\text{Effective value of fundamental wave}} \times 100(\%)$$
- AC component (in the case of DC) Ripple factor: 3% or less
- $$\text{Ripple factor} = \frac{\text{Max. value} - \text{Min. value}}{\text{Average value of DC}} \times 100(\%)$$
- Auxiliary power supply voltage Rated voltage ±2%

 Caution	<ul style="list-style-type: none"> * The equipment must only be operated and handled by qualified personnel. Otherwise, there are risks of electric shock, injury, failure, malfunction, and maloperation. * Handling and maintenance of the equipment must only be carried out after gaining a thorough understanding of the instruction manual. Otherwise, there is the risk of electric shock, injury, failure, malfunction, or maloperation. * When replacing the equipment, use a product of same model, rating, and specifications. Otherwise, there is the risk of failure or fire.. If any other product is to be used, the manufacturer must be consulted. * Do not exceed the overload capacity for voltage and current. Otherwise, equipment failure or fire could occur. * Do not touch any live parts, such as terminals, etc. Otherwise, there is a risk of electric shock. * Do not clean the equipment while energised. When the cover needs to be cleaned, make use of a damp cloth.
--	---

4. Transportation

- * Transport the equipment in the correct orientation.
- * Do not apply excessive shock and/or vibration as this could affect the performance and life of the product.

5. Storage

The storage environment shall comply with the following conditions. Otherwise, there is a risk of reducing the performance and life of the product.

- Ambient temperature -20 to +60°C
(under the state where dew condensation or freezing does not occur)
- Relative humidity 30 to 80% on daily average
- Altitude 2000m or lower
- The equipment must not be exposed to abnormal vibration, shock, inclination, or magnetic fields.
- The equipment must not be exposed to harmful smoke/gas, saline gas, water droplets or vapor, excessive dust or fine powder, explosive gas or fine powder, wind & rain.

6. Repair and Modification

- * When carrying out repair and/or modification, please consult with the manufacturer in advance. We will not take any responsibility for any repair and/or modification (including software) which has been carried out without prior consent.

7. Disposal

Disposal must take place in accordance with the applicable legislation

Guarantee

1. Guarantee period

The guarantee period of this product should be one year after delivery, unless otherwise specified by both parties.

2. Scope of guarantee

When any fault or defect is detected during the period of guarantee and such fault or defect is proved to be caused apparently at the responsibility of MITSUBISHI ELECTRIC CORPORATION, the defective unit concerned will be repaired or replaced with substitute with free of charge. However, the fee for our engineer dispatching to site has to be covered by the user. Also, site retesting or trial operation caused along with replacing the defect units should be out of scope of our responsibilities.

It is to be acknowledged that the following faults and defects should be out of this guarantee.

- (1) When the faults or defects are resulted from the use of the equipment at the range exceeding the condition/environment requirements stated in the catalogue and manual.
- (2) When the faults or defects are resulted from the reason concerning without our products.
- (3) When the faults or defects are resulted from the modification or repair carried out by any other entity than MITSUBISHI ELECTRIC CORPORATION.
- (4) When the faults or defects are resulted from a phenomenon which cannot be predicted with the science and technology put into practical use at the time of purchase or contract
- (5) In case of integrating our products into your equipment, when damages can be hedged by the proper function or structure in the possession of your equipment which should be completed according to the concept of the de fact standard of industry.
- (6) In case of that the faults or defects are resulted from un-proper application being out of instruction of MITSUBISHI ELECTRIC CORPORATION.
- (7) In case that the faults or defects are resulted from force majeure such a fire or abnormal voltage and as an act of God such as natural calamity or disaster.

3. Exclusion of loss in opportunity and secondary loss from warranty liability

Regardless of whether in guarantee period or not, MITSUBISHI ELECTRIC CORPORATION shall not be liable for compensation of damages caused by any cause found not be the responsibility of MITSUBISHI ELECTRIC CORPORATION, loss in opportunity, lost profits incurred to the user by failures of MITSUBISHI ELECTRIC CORPORATION products, special damages and secondary damages whether foreseeable or not, compensation for accidents, and compensation for damages to products other than MITSUBISHI ELECTRIC CORPORATION products and other tasks.

4. Applications of products

- (1) The user is requested to confirm the standards, the regulations and the restrictions which should be applied, in case of utilizing this product and another one in combination. Also, the user is requested to confirm the suitability of our products to your applied system or equipment or apparatus by yourself. MITSUBISHI ELECTRIC CORPORATION shall not be liable for any suitability of our products to your utilization.
- (2) This product has been designed and manufactured for application in general industries, etc. Thus, application in which the life or an asset could be affected by special application such as medical system for life-sustaining, in nuclear power plants, power plants, aerospace, transportation devices (automobile, train, ship, etc.) shall be excluded from the application. In addition to above, application in which the life or an asset could be affected by potentially chemical contamination or electrical interference and also in which the circumstances and condition are not mentioned in this manual shall be excluded from the application. Note even if the user wants to use for these applications with user's responsibility, the user to be requested to approve the specification of MITSUBISHI ELECTRIC CORPORATION products and to contact to the technical section of MITSUBISHI ELECTRIC CORPORATION prior to such applications. If the user applies MITSUBISHI ELECTRIC CORPORATION products to such applications without any contact to our technical section, MITSUBISHI ELECTRIC CORPORATION shall not be liable for any items and not be insured, independently from mentioned in this clause.
- (3) In using this product, the working conditions shall be that the application will not lead to a major accident even if any problem or fault occur, and that backup or duplicate system built in externally which should be decided based on the importance of facility, is recommended.
- (4) The application examples given in this manual are reference only and you are requested to confirm function and precaution for equipment and apparatus and then, use our products.
- (5) The user is requested to understand and to respect completely all warning and caution items so that unexpected damages of the user or the third party arising out of incorrect application of our products would not be resulted.

5. Onerous repair term after discontinuation of product

(1) MITSUBISHI ELECTRIC CORPORATION shall accept onerous product repairs for 7 years after production is discontinued. (However, the product which was made over 15 years is recommended to replace.)

(2) Product supply (including repair parts) is not available after production is discontinued.

6. Changes in product specification

The specification given in the catalogue, manuals or technical documents are subject to change without prior notice.

7. Scope of service

The technical service fee such as engineer dispatching fee is excluded in the price of our products.

Please contact to our agents if you have such a requirement.

MVG-A4 Series Earth Fault Overvoltage Relay [Standard: JEC 2520(2018)]

Features

1. Earth fault overvoltage relay for EVT correspondence.
2. Wide setting range enables flexible protection coordination.
3. Reset method of output contacts can be switchable between auto-reset and self-hold.
4. The fault value record function is installed.
5. Good operability and visibility design is adopted. The numerical display turns on for 3 seconds when the setting value is changed, which enables to check setting values easily.
6. Panel cutout is the same as previous MELPRO-A series and E series.

Ratings and Specifications

Type name		MVG-A4V-R	MVG-A4V-RD																			
Style No.		109PGA	524PGA																			
Ratings	Zero-sequence voltage	110V/190V (switchable by input terminals)																				
	Frequency	50/60Hz (switchable)																				
	Auxiliary power supply	AC110V (Range: 90~120V)																				
Settings	V ₀ Operation value	LOCK(*)-2-3-4-5-6-8-10-12-14-16-18-20-25-30% (Ratio to V ₀ voltage on single-phase perfect fault: 100%=110V/190V)																				
	Operating time	Instantaneous(*)-0.2-0.5-1.0-1.5-2.0-2.5-3.0-4.0-5.0s																				
	Using condition	Frequency	50Hz (SW1-ON) - 60Hz(*) (SW1-OFF)																			
		Output contact	Self-hold(SW2-ON) - Auto-reset(*) (SW2-OFF)																			
Display	Self-monitoring	The "RUN" indicator (green-color) is lighted in normal condition.																				
	Operation indicator	The indicator turns from black into orange color when the protection element is put into operation. (Manual resetting type)																				
	Numerical display	<table border="1"> <thead> <tr> <th>Indication item</th> <th>Range</th> </tr> </thead> <tbody> <tr> <td>V₀ measurement</td> <td>1.0~40.0%</td> </tr> <tr> <td>Pickup</td> <td>U.</td> </tr> <tr> <td>V₀ setting</td> <td>Lo. (※1), 2~30%</td> </tr> <tr> <td>Operating time setting</td> <td>In. (※2), 0.2~5.0s</td> </tr> <tr> <td>Frequency setting</td> <td>50, 60Hz</td> </tr> <tr> <td>Output contact setting</td> <td>Ho., FU.</td> </tr> <tr> <td>Fault record</td> <td>2.0~40.0%</td> </tr> <tr> <td>Clear fault record</td> <td>O.K.</td> </tr> <tr> <td>TEST (Forced operation)</td> <td>F.O.</td> </tr> </tbody> </table> <p>※1 "Lo." means LOCK setting (the protection element is locked). ※2 "In." is the display for instantaneous setting.</p>		Indication item	Range	V ₀ measurement	1.0~40.0%	Pickup	U.	V ₀ setting	Lo. (※1), 2~30%	Operating time setting	In. (※2), 0.2~5.0s	Frequency setting	50, 60Hz	Output contact setting	Ho., FU.	Fault record	2.0~40.0%	Clear fault record	O.K.	TEST (Forced operation)
Indication item	Range																					
V ₀ measurement	1.0~40.0%																					
Pickup	U.																					
V ₀ setting	Lo. (※1), 2~30%																					
Operating time setting	In. (※2), 0.2~5.0s																					
Frequency setting	50, 60Hz																					
Output contact setting	Ho., FU.																					
Fault record	2.0~40.0%																					
Clear fault record	O.K.																					
TEST (Forced operation)	F.O.																					
Test button (Forced operation)		By turning the indicator select switch to "TEST" and pushing "TEST" button for 2 seconds or more, output contact can be forced to operate (except for the case of LOCK setting).																				
Power consumption	V ₀ circuit	0.1VA at rated voltage																				
	Power supply	Normal : 3.0VA Operating : 4.0VA																				
Case (Munsell color)		Unit-fixed type (Fig. 8-8) (0.6B7.6/0.2)	Unit-drawer type (Fig. 8-9) (0.6B7.6/0.2)																			
Mass		Approx. 0.6kg	Approx. 0.7kg																			

(*) shows factory setting.

Note) It is necessary to combine commercially available EVT (compliance with JEC-1201) with MVG-A4V relay.
 Don't combine other transformers with this relay.

Characteristics

Item	Characteristics																																																
Standard use conditions	Ambient temperature: -20 to +60°C (Under the state where dew condensation or freezing does not occur) Relative humidity: 30 to 80% on daily average Altitude: 2000m or lower - The state where abnormal vibration, shock, and inclination are not applied. - The state where it is not exposed to harmful gas, excessive dust, and water droplet or vapor.																																																
Operation value characteristics	Setting: Operating time = Minimum Criteria: Within $\pm 10\%$ of each setting value <table border="1"> <tr> <td>V₀ setting (%)</td> <td>2</td> <td>3</td> <td>4</td> <td>5</td> <td>6</td> <td>8</td> <td>10</td> </tr> <tr> <td>190V terminal input (V)</td> <td>3.8</td> <td>5.7</td> <td>7.6</td> <td>9.5</td> <td>11.4</td> <td>15.2</td> <td>19</td> </tr> <tr> <td>110V terminal input (V)</td> <td>2.2</td> <td>3.3</td> <td>4.4</td> <td>5.5</td> <td>6.6</td> <td>8.8</td> <td>11</td> </tr> </table> <table border="1"> <tr> <td>V₀ setting (%)</td> <td>12</td> <td>14</td> <td>16</td> <td>18</td> <td>20</td> <td>25</td> <td>30</td> </tr> <tr> <td>190V terminal input (V)</td> <td>22.8</td> <td>26.6</td> <td>30.4</td> <td>34.2</td> <td>38</td> <td>47.5</td> <td>57</td> </tr> <tr> <td>110V terminal input (V)</td> <td>13.2</td> <td>15.4</td> <td>17.6</td> <td>19.8</td> <td>22</td> <td>27.5</td> <td>33</td> </tr> </table>	V ₀ setting (%)	2	3	4	5	6	8	10	190V terminal input (V)	3.8	5.7	7.6	9.5	11.4	15.2	19	110V terminal input (V)	2.2	3.3	4.4	5.5	6.6	8.8	11	V ₀ setting (%)	12	14	16	18	20	25	30	190V terminal input (V)	22.8	26.6	30.4	34.2	38	47.5	57	110V terminal input (V)	13.2	15.4	17.6	19.8	22	27.5	33
V ₀ setting (%)	2	3	4	5	6	8	10																																										
190V terminal input (V)	3.8	5.7	7.6	9.5	11.4	15.2	19																																										
110V terminal input (V)	2.2	3.3	4.4	5.5	6.6	8.8	11																																										
V ₀ setting (%)	12	14	16	18	20	25	30																																										
190V terminal input (V)	22.8	26.6	30.4	34.2	38	47.5	57																																										
110V terminal input (V)	13.2	15.4	17.6	19.8	22	27.5	33																																										
Reset value characteristics	Setting: Operating time = Minimum Criteria: 90% or more of operating value																																																
Operating time characteristics	Setting: Operation value = Minimum Input: 0V → 150% of setting value <table border="1"> <tr> <td rowspan="3">Time setting</td> <td>Voltage</td> <td>150% of setting value</td> </tr> <tr> <td>Instantaneous</td> <td>60ms or less</td> </tr> <tr> <td>0.2s or more</td> <td>$\pm 10\%$ of setting time</td> </tr> </table>	Time setting	Voltage	150% of setting value	Instantaneous	60ms or less	0.2s or more	$\pm 10\%$ of setting time																																									
Time setting	Voltage		150% of setting value																																														
	Instantaneous		60ms or less																																														
	0.2s or more	$\pm 10\%$ of setting time																																															
Resetting time characteristics	Setting: Operation value = Minimum Input: 150% of setting value → 0V Criteria: 250ms \pm 50ms																																																
Frequency characteristics	Frequency variations: $\pm 5\%$ of rated frequency Setting: Operation value = Minimum, Operating time = Minimum Operation value: Within $\pm 10\%$ of the value at rated frequency																																																
Variation characteristics of auxiliary power supply voltage	Input: Auxiliary power supply = AC90V~AC120V Criteria: Within $\pm 10\%$ of operation value at rated voltage																																																
Temperature characteristics	Setting: Operation value = Minimum, Operating time = Minimum Operation value at ambient temperature of 0, +40°C: Within $\pm 5\%$ of the value at 20°C Operation value at ambient temperature of -20, +60°C: Within $\pm 10\%$ of the value at 20°C																																																
Vibration	<table border="1"> <tr> <td rowspan="2">Frequency (Hz)</td> <td colspan="3">Peak-to-peak amplitude mm (Acceleration m/s²)</td> <td rowspan="2">Vibration time (s)</td> <td rowspan="4"> Setting: Minimum operation value and minimum operating time Input: Rated auxiliary power supply V₀ = 0 Criteria: No malfunction and no abnormal indication </td> </tr> <tr> <td>Forward/backward</td> <td>Right/left</td> <td>Up/down</td> </tr> <tr> <td>10</td> <td colspan="2">5 (10)</td> <td>2.5 (5)</td> <td>30</td> </tr> <tr> <td>16.7</td> <td colspan="2">0.4 (2)</td> <td></td> <td>600</td> </tr> </table>	Frequency (Hz)	Peak-to-peak amplitude mm (Acceleration m/s ²)			Vibration time (s)	Setting: Minimum operation value and minimum operating time Input: Rated auxiliary power supply V ₀ = 0 Criteria: No malfunction and no abnormal indication	Forward/backward	Right/left	Up/down	10	5 (10)		2.5 (5)	30	16.7	0.4 (2)			600																													
Frequency (Hz)	Peak-to-peak amplitude mm (Acceleration m/s ²)			Vibration time (s)	Setting: Minimum operation value and minimum operating time Input: Rated auxiliary power supply V ₀ = 0 Criteria: No malfunction and no abnormal indication																																												
	Forward/backward	Right/left	Up/down																																														
10	5 (10)		2.5 (5)	30																																													
16.7	0.4 (2)			600																																													
Shock	Maximum acceleration: 300m/s ² Direction: 3 directions in forward/backward, right/left, and up/down Criteria: No abnormality when applying three shocks in each direction																																																
Insulation resistance	Test circuit: Between all circuits and earth (E terminal), between separate circuits, and between the poles of contacts Criteria: More than 10M Ω by DC500V megger. (Note) The test is held under the condition that relative humidity is less than 80%.																																																
Withstand voltage	Between all circuits and earth (E terminal): AC2000V, for 1 minute Between separate circuits: AC2000V, for 1 minute Between the poles of contacts (a11-a12, a21-a22): AC1000V for 1 minute																																																
Lightning impulse withstand voltage	Apply standard waveform (1.2/50 μ s) to positive/negative pole for 3 times respectively. Between all circuits of the relay and earth (E terminal): 4.5kV Between EVT secondary and control circuit: 4.5kV Between mutual control circuits: 3.0kV Between terminals of power supply: 3.0kV Between terminals of EVT circuit: 3.0kV																																																

Noise-proof	Apply damped oscillatory wave prescribed in JEC-2501 for 2 seconds. • Between EVT secondary and earth (E terminal) • Between power supply terminal and earth (E terminal) • Between terminals of power supply • Between contact terminal and earth (E terminal) Setting: Minimum operation value and minimum operating time Input: Rated auxiliary power supply, $V_0 = 0$ Criteria: No malfunction															
Radio disturbance	Intermittently irradiate radio waves to the front panel of the relay with a transceiver of 150MHz or 400MHz band (5W output) from a distance of 0.5m. Setting: Minimum operation value and minimum operating time Input: Rated auxiliary power supply, $V_0 = 0$ Criteria: No malfunction															
Contact capacity	<table border="1" data-bbox="454 459 630 560"> <tr> <td data-bbox="454 459 630 504">Making (Closing)</td> <td data-bbox="630 459 933 504">DC110V 15A (L/R=0ms)</td> </tr> <tr> <td data-bbox="454 504 630 537"></td> <td data-bbox="630 504 933 537">DC220V 10A (L/R=0ms)</td> </tr> <tr> <td data-bbox="454 537 630 560"></td> <td data-bbox="630 537 933 560">AC110V 10A ($\cos \phi = 0.1$)</td> </tr> </table>	Making (Closing)	DC110V 15A (L/R=0ms)		DC220V 10A (L/R=0ms)		AC110V 10A ($\cos \phi = 0.1$)		<table border="1" data-bbox="933 459 1093 560"> <tr> <td data-bbox="933 459 1093 504">Breaking (Opening)</td> <td data-bbox="1093 459 1525 504">DC110V 0.3A (L/R=7ms)</td> </tr> <tr> <td data-bbox="933 504 1093 537"></td> <td data-bbox="1093 504 1525 537">AC110V 5A ($\cos \phi = 0.1$)</td> </tr> <tr> <td data-bbox="933 537 1093 560"></td> <td data-bbox="1093 537 1525 560">AC220V 1A ($\cos \phi = 0.1$)</td> </tr> </table>	Breaking (Opening)	DC110V 0.3A (L/R=7ms)		AC110V 5A ($\cos \phi = 0.1$)		AC220V 1A ($\cos \phi = 0.1$)	
Making (Closing)	DC110V 15A (L/R=0ms)															
	DC220V 10A (L/R=0ms)															
	AC110V 10A ($\cos \phi = 0.1$)															
Breaking (Opening)	DC110V 0.3A (L/R=7ms)															
	AC110V 5A ($\cos \phi = 0.1$)															
	AC220V 1A ($\cos \phi = 0.1$)															

Note) For details, refer to JEC 2520 (2018).

Structure

RUN indicated LED (Green)
It shows the result of self-monitoring. It lights up in normal condition.

Numerical display LED
Following item is displayed by indicator select switch setting.

- V_0 measurement
- Pickup
- Setting value
- Fault record
- Clear fault record
- Forced operation (test)

Indicator select switch
The numerical display shows according to this selection switch. Don't leave this switch with halfway state.

Setting switches for operation value and time
Set the setting values. The black part is equal to maximum value, but the numerical display is turned off. Don't leave the switches with halfway state.

Operation indicator reset lever
Move this lever up and down, then the operation indicator resets. (Note) Don't pull the lever strongly.

Test button
By turning the indicator select switch to "TEST" and pushing "TEST" button for 2 seconds or more, output contact can be forced to operate (except for the case of LOCK setting).

CPU reset button
While this button is pressed, the relay function is locked and the RUN indicated LED is turned off. In addition, the output contact is reset from self-hold state.

Setting switches for using condition
Don't use any tool with a sharp point when the switches are set. (It may cause damage to the switch lever.)

SW1	Frequency
ON	50Hz
OFF	60Hz

SW2	Output contact
ON	Self-hold (Ho.)
OFF	Auto-reset (FU.)

Factory settings are set to a default of OFF.

Operation indicator
The indicator turns from black into orange color when the protection element is put into operation.

Fig. 8-1 Structure of MVG-A4 series (front view)

Internal connection diagram

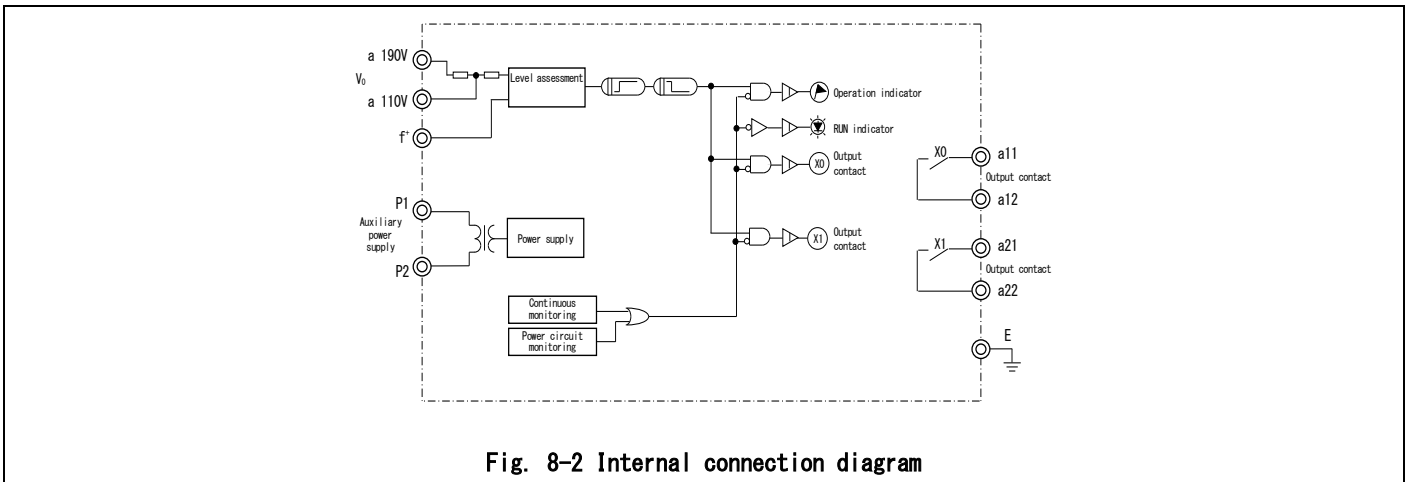

Fig. 8-2 Internal connection diagram

Operating Description

1. Protection function

- ①The power supply can be derived from VT secondary.
- ②Set using condition switches according to your using condition (frequency and output contact).
- ③Zero-sequence voltage input is supplied from secondary output of commercially available EVT (compliance with JEC-1201).
- ④If input zero-sequence voltage is greater than or equal to the setting value, the operation timer starts. The relay actuates the output contact and operation indicator after a preset time of the operation timer.
- ⑤After the relay operation, if input zero-sequence voltage falls below the setting value, the output contact will be in the state set by the using condition setting switch (auto-reset or self-hold). The operation indicator keeps the operation status (orange color). To reset the indicator, move the reset lever up and down.

2. RUN display (Self-monitoring function)

This relay monitors control voltage, electric circuit, and program data at all time. The RUN LED (green) lights up in the normal condition.

In the abnormal condition, the RUN LED goes out and the error message **E r r** is displayed on the numerical display LED, with the output contact locked.

3. Numerical display function

By switching the position of the indicator select switch, following items can be displayed on the numerical display LED.

①V₀ voltage measurement

The display shows the value of zero-sequence voltage. The display range is from 1.0% to 40%.

(If input voltage is less than 1.0%, the display goes out. If input voltage is more than 40%, the error message **O. F.** is displayed.)

Here, "100%" denotes complete single-phase fault, that is, the rated input voltage of the relay (110V/190V).

This function makes it possible to measure the residual V₀ voltage in sound condition.

②Pickup

When input zero-sequence voltage is greater than or equal to the setting value, **U.** is displayed.

This function can be used for operation value tests.

③Setting value

It displays the setting condition of the relay including V₀ value and operating time setting.

④Frequency setting

It displays the setting condition of frequency in accordance with the setting switch of SW1.

⑤Output contact setting

It displays the setting condition of output contact in accordance with the setting switch of SW2.

The setting is self-hold, the display shows

H o.

The setting is auto-reset, the display shows

F U.

4. Fault record function

①Display of fault records

When a fault occurs, the relay outputs the operating signal, and at the same time the input value of zero-sequence voltage is recorded. When the indicator select switch is set to the position of fault record, the records are displayed starting from the latest record to the oldest one at approximately 2 second intervals. The relay can save the newest five phenomena.

The records are saved in the non-volatile memory, therefore the records can be read again after shutting the power off.

Note that the fault record may not be saved if the auxiliary power supply is turned off soon after the relay operation.

②Clearing of fault records

Set indicator select switch to "CLEAR FAULT REC." and hold for 5s or more, then **O. K.** is displayed and all of the fault record are cleared.

5. Display function of setting change

When a setting is changed, the setting value after changing is displayed for approx. 3s preferentially.

External connection diagram (Example)

Application value of EG-5 type current limiting resistance.

V ₀ Rating	System voltage	
	EG-5 style No.	
190V	191PHA	25 Ω
110V	192PHA	8 Ω

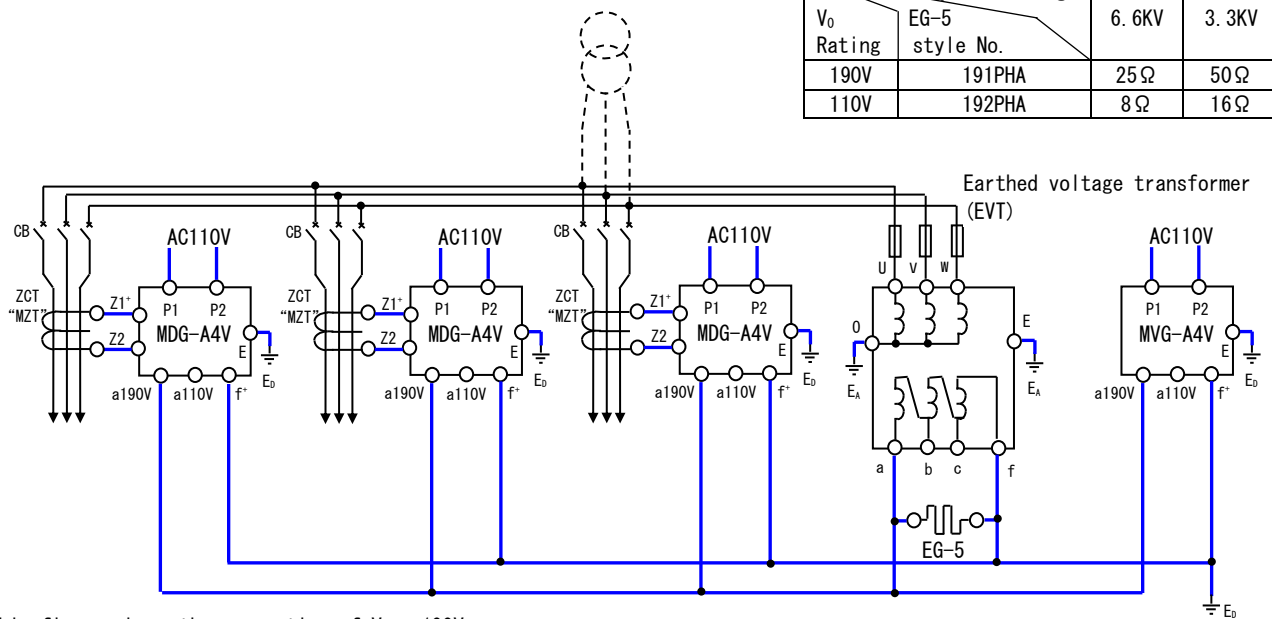

Note) This figure shows the connection of V₀ = 190V.
 ● Connect — line.

Fig. 8-3 External connection diagram

Handling precautions

1. Panel mounting

- ① Be sure to connect the "E" terminal of the relay to D-class grounding.
- ② The relay of unit-drawer type (RD type) can be drawn out from the case.

2. Use and operation

- ① About the setting switches for using condition, factory settings are set to a default of OFF. So it is necessary to set the switches according to the conditions.

- ② Please refrain from changing the setting value during operation, since unwanted operation may occur. However, if the setting change is unavoidable, please press the CPU reset button in order to lock the relay function.
- ③ Don't leave rotary switches with halfway (indefinite) state.
- ④ The RUN LED lights up in the normal condition when the rated auxiliary power supply is input. If it still turns off when the auxiliary power supply voltage exceeds 85V, please contact our local agent and branch office since the relay may fail.

Test

A relay test is carried out sufficiently before shipment, but at the following cases, it is recommended the test should be carried out again.

- a. When the products are delivered and unpacked
- b. At the time of starting operation of equipment
- c. At the time of periodic inspection (Usually once a year)

1. At the time of testing

- ① The input waveform should be a sine wave with little distortion.
- ② During the test, set the position of the indicator select switch to "V₀ MEASURE". Set the other setting switches according to the test conditions of the operating characteristic control point.
- ③ If user-defined control point is specified (e.g. accuracy of relay characteristic is controlled at service conditions), execute the test at the manufacturer-defined characteristic control point before in-service operation and then check accuracy of the relay. After that, execute the test at the user-defined control point, and use this data as a later reference.

2. Withstand voltage test

- a. Apply 2000V AC (commercial frequency) between all circuits and earth (E terminal) for one minute, and make sure that there is no problem.

Voltage applied terminals	

- b. Apply 2000V AC (commercial frequency) between separate circuits for one minute, and make sure that there is no problem.

Voltage applied terminals	

3. Operation characteristics test

- ① When the rated power supply voltage is applied, the RUN display LED (green) lights up. This indicates that the relay works properly.
- ② When adjusting the test voltage during the operating time test, it is recommended to press the CPU reset button to lock the operation of this relay. If the operation is locked and the test voltage is adjusted, an accurate test is possible.
- ③ By turning the indicator select switch to "TEST" and pushing "TEST" button for 2 seconds or more, output contact can be forced to operate (except for the case of LOCK setting).

4. Operation characteristic control point

Perform the test periodically according to the following test conditions and criteria.

Test item	Test condition			Criteria
	Input	Operation value	Operating time	
Operation value	-	Each setting	Instantaneous	±10% of setting value
Operating time	0V ↓ 150% of setting	Minimum setting	Instantaneous	60ms or less
		Minimum setting	0.2s or more	±10% of setting time

Terminal layout

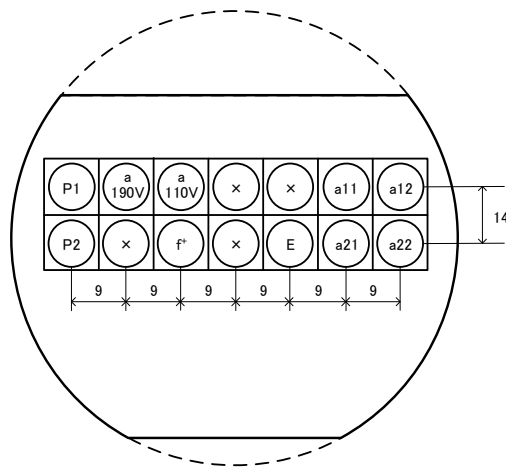

MVG-A4V-R/RD

Do not connect to the "x" terminals, or the relay may not operate properly.

Fig. 8-4 Terminal layout

Drawing out and housing operation of subunit (Unit-drawer type)

For unit-drawer type (RD type), it is possible to draw out the subunit from the case without removing external wiring, which makes easier to carry out inspection and testing.

When drawing out and housing, be careful not to touch the electrical circuit (e.g. substrate, capacitor, and transformer) and be sure to hold the drawer handle or the frame part when transporting. (Touching the electrical circuit may cause electric shock or damage to the circuit.)

Before the subunit is to be drawn out, ensure that the following items are checked in order not to carry out the work in hot-line condition.

- Lock of the tripping circuit
- Turning off the main circuit
- Disconnect CT/VT circuit
- Turning off the auxiliary power supply

The CT circuit is equipped with an automatic short circuit piece so that the CT secondary circuit won't be opened even if the relay subunit is drawn out without disconnecting the CT circuit.

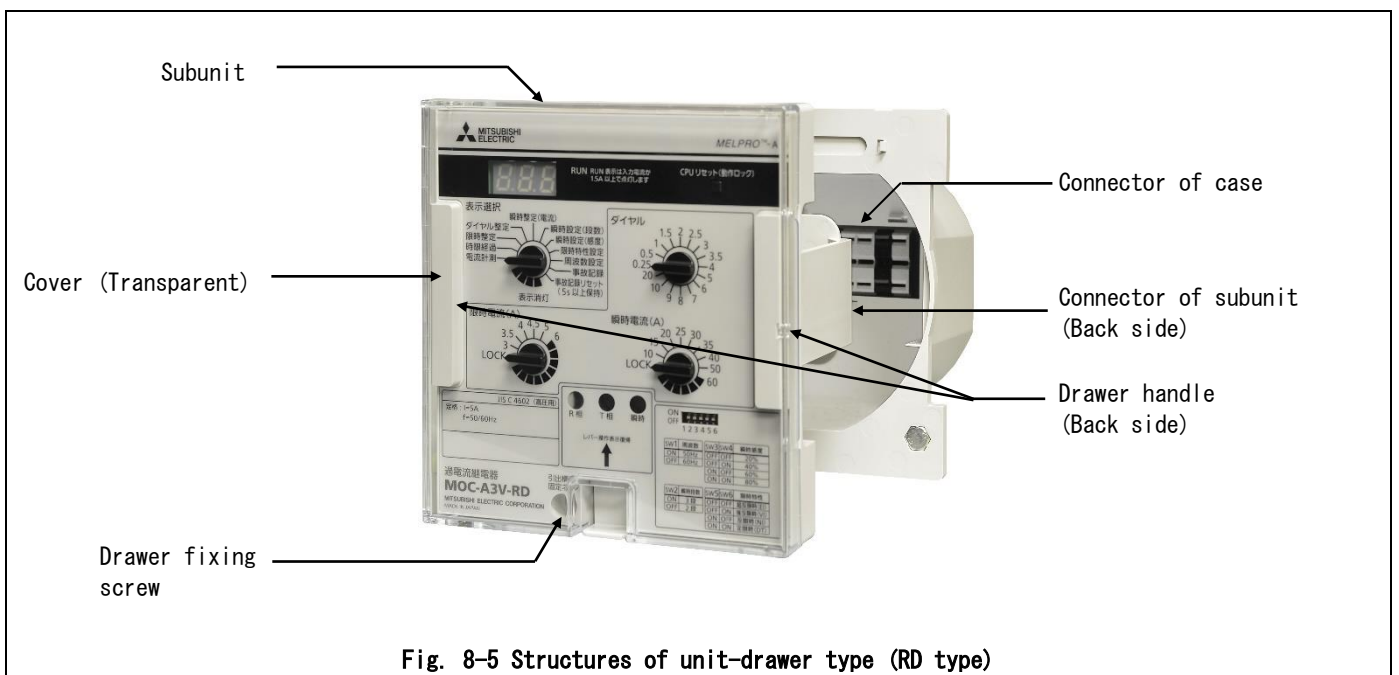
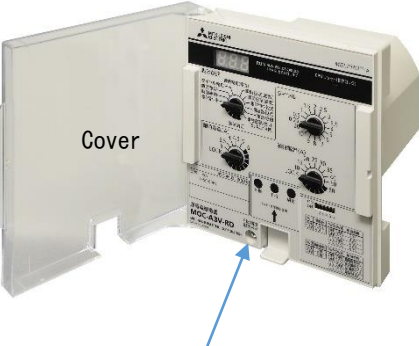

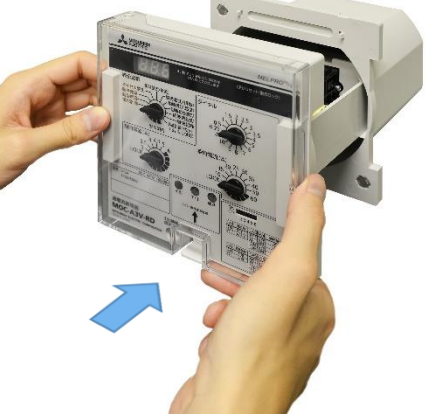

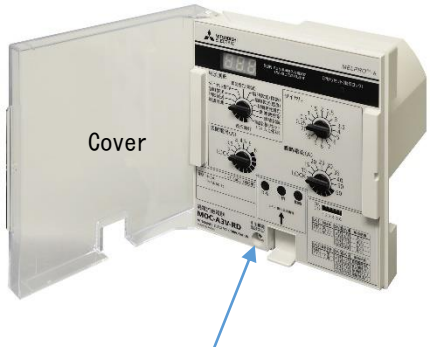

Fig. 8-5 Structures of unit-drawer type (RD type)

1. Procedure of drawing out

 <p>Cover</p> <p>Drawer fixing screw</p>		
<p>① Open the cover and remove the drawer fixing screw.</p>	<p>② Close the cover and pull out the subunit with your finger hooked on the drawer handle on both sides.</p>	<p>③ Support the frame of subunit and pull out.</p>

2. Procedure of housing

		 <p>Cover</p> <p>Drawer fixing screw</p>
<p>① Support the frame of subunit and place the subunit in the case along the rails.</p>	<p>② Insert the subunit into the case horizontally.</p>	<p>③ Open the cover and tighten the drawer fixing screw.</p>

Handling of the cover

1. Opening and closing

Please open the cover by placing your fingertip on the convex part in the right side of the cover as shown in Fig. 8-6.



Fig. 8-6

2. How to replace the cover

·Removing the cover

Open the cover, and lightly push up the upper side of the cover from the inner surface. Then, remove from the protrusion of the body.

·Installing the cover

As shown in Fig. 8-7, mount the holes on the upper side of the cover to the protrusion of the body. Then, press down lightly on the lower side of the cover and mount to the protrusion of the body in the same way as above.

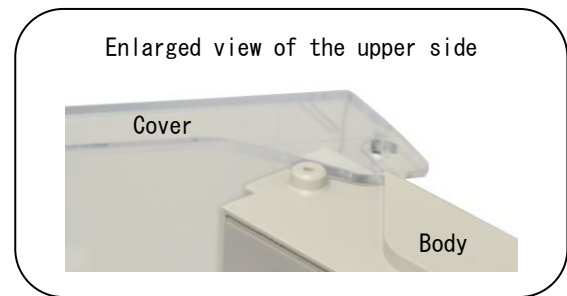
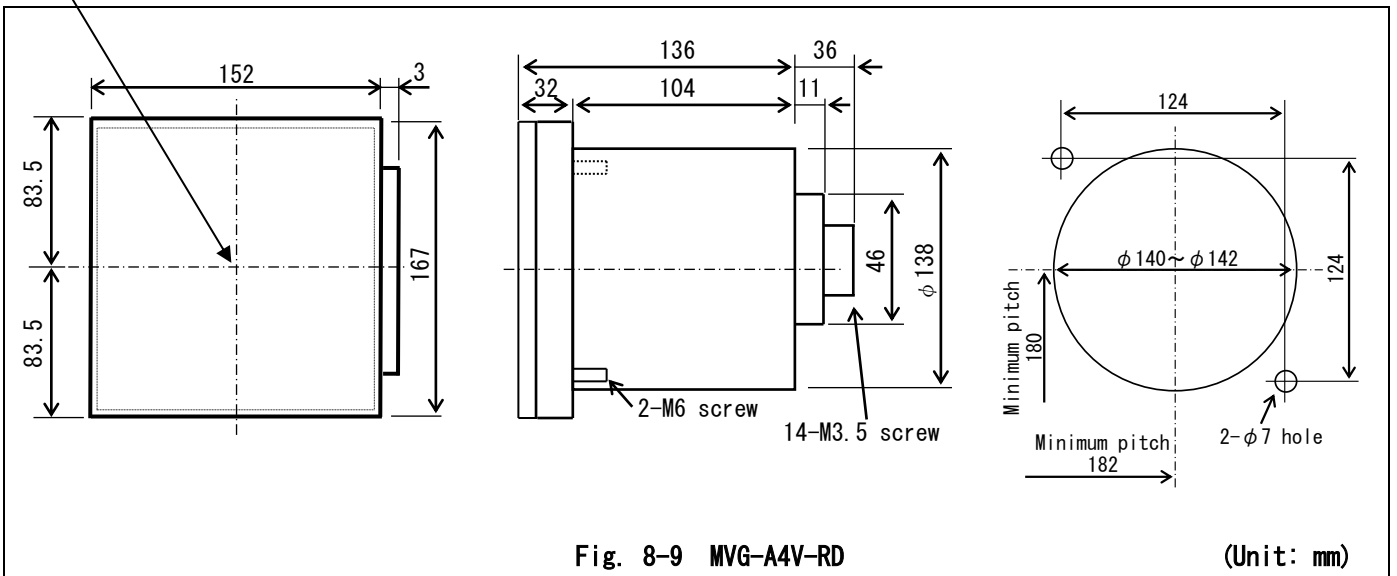
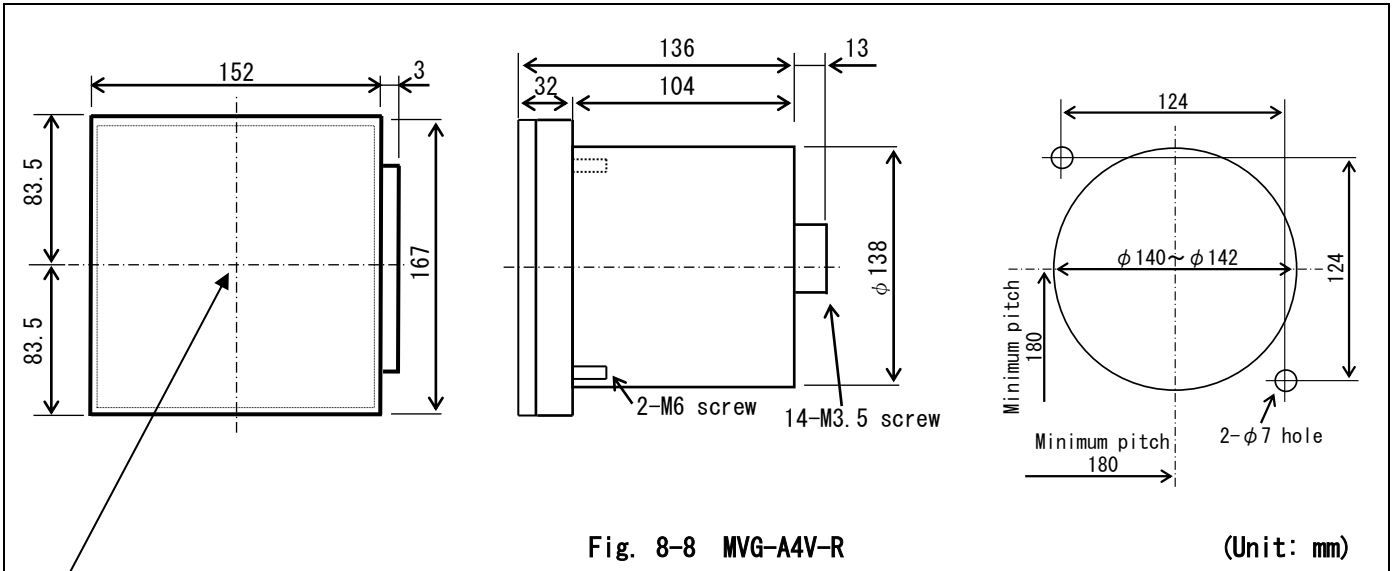

Fig. 8-7

· When replacing the cover during operation, be careful not to touch the switches.

External dimensions and Panel cut-out



Improvement on the reliability of protection function

Any parts and materials applied to the protection relay have limited lifetime which will bring the degradation to the relay. The degree of degradation will be variable depending on the purpose, aging, usage environment, and unevenness on the performance of each part.

Our company designs its products so that the recommended renewal period is 15 years or more.

However, there may be some possibilities to occur any failures before reaching 15 years due to above reasons.

To prevent unwanted operation or no operation of relay, it is recommended to apply the relay with self-diagnosis function and/or multiplexing relay system such as dual or duplex scheme.

mitsubishi electric corporation

HEAD OFFICE : 7-3 MARUNOUCHI 2-CHOME, CHIYODA-KU TOKYO, 100-8310, JAPAN

First edition: Mar. 2021