

Positioning Control

Training Manual



Cautions on Safety

Make sure to read the manuals and pay careful attention to safety when designing a system. In practice, pay attention to the following contents and handle any products or demonstration units correctly.

Cautions on practice



DANGER

- Never touch any terminal while the power is supplied. If you touch a terminal, you may get an electrical shock.
- Turn off the power before connecting / disconnecting units, or opening any safety covers.
- Never insert your hand or any other object into a moving part.



CAUTION

- Never change the wiring or configuration of demonstration equipment without permission or if you are unsure of how to configure a system correctly. Such actions may cause failure, malfunction, injury or fire.
- If a simulation unit (such as an X-Y table) generates an abnormal smell or sound, immediately turn off the power switch.
- If you detect any abnormality, immediately turn off the power and contact a qualified engineer.

Positioning Control

Manual number : JY992D89901

Manual revision : A

Date : July 2000

FAX BACK

Mitsubishi has a world wide reputation for its efforts in continually developing and pushing back the frontiers of industrial automation. What is sometimes overlooked by the user is the care and attention to detail that is taken with the documentation. However,to continue this process of improvement, the comments of the Mitsubishi users are always welcomed. This page has been designed for you,the reader,to fill in your comments and fax them back to us. We look forward to hearing from you.

Fax numbers:	Your name.....
Mitsubishi Electric....
America (01) 847-478-2253	Your company
Australia (02) 638-7072
Germany (0 21 02) 4 86-1 12	Your location:
South Africa (0 27) 11 444-0223
United Kingdom (01707) 278-695	

Please tick the box of your choice

What condition did the manual arrive in? Good Minor damage Unusable

Will you be using a folder to store the manual? Yes No

What do you think to the manual presentation? Tidy Un-friendly

Are the explanations understandable? Yes Not too bad Unusable

Which explanation was most difficult to understand:

.....

Are there any diagrams which are not clear? Yes No

If so,which:.....

What do you think to the manual layout? Good Not too bad Un-helpful

If there one thing you would like to see improved,what is it?.....

.....

.....

Could you find the information you required easily using the index and/or the contents,if possible please identify your experience:

.....

.....

.....

Do you have any comments in general about the Mitsubishi manuals?

.....

.....

.....

Thank you for taking the time to fill out this questionnaire. We hope you found both the product and this manual easy to use.

Introduction

This manual describes basic operation for those who learn positioning control for the first time, the aim being so that they can get training using demonstration units of Mitsubishi FA equipment.

The following relevant manuals are available and should be referred to

Manual Name	Number
FX-10GM/FX(E)-20GM Hardware and Programming manual	JY992D60401
FX-10GM Users Guide	JY992D68401
FX ₂ N-10GM/FX ₂ N-20GM Hardware and Programming manual	JY992D77801
FX ₂ N-10GM Users Guide	JY992D77701
FX ₂ N-20GM Users Guide	JY992D77601
FX-PCS-VPS Win-E Software Manual	JY992D86801
FX ₂ N-10GM/FX ₂ N-20GM Connection Manual	JY992D81601

1. The World of Positioning Control.....	1-1
1.1 Welcome to the new world!	1-1
1.2 Diversified actuators	1-2
1.3 Positioning method type	1-4
2. Positioning by AC Servo System.....	2-1
2.1 When an AC servo system is introduced.....	2-1
2.2 Examples of AC servo systems.....	2-3
3. Components of Positioning Control and Their Roles	3-1
3.1 Positioning controller	3-4
3.1.1 Command pulse and feed quantity.....	3-4
3.1.2 Command pulse and feed speed	3-4
3.1.3 Setting the acceleration/deceleration time	3-5
3.1.4 Backlash correction function	3-5
3.1.5 Zero point return function	3-6
3.2 Servo amplifier and servo motor.....	3-7
3.2.1 Positioning control in accordance with command pulse.....	3-7
3.2.2 Deviation counter function	3-7
3.2.3 Servo lock function	3-7
3.2.4 Regenerative brake function	3-8
3.2.5 Dynamic brake function	3-8
3.3 Drive mechanism.....	3-9
3.3.1 Concept of drive system movement quantity	3-9
3.3.2 Setting the target position.....	3-11
4. Advanced Positioning	4-1
4.1 Interpolation control	4-1
4.2 Other controls	4-3
5. Actual Positioning.....	5-1
5.1 Demonstration Equipment	5-1
5.1.1 Basic Set	5-1
5.1.2 Comprehensive Set.....	5-1
5.2 Operation of the demonstration equipment	5-2
5.2.1 Program example	5-3
5.2.2 Writing the program	5-4
5.2.3 Parameters	5-5
5.2.4 Operation.....	5-7
6. Product Line up	6-1
6.1 Position controller	6-1
6.2 Servo amplifier.....	6-5
6.3 Servo motor	6-7
Appendix A:	A-1
A-1: Tentative Selection of Motor Capacity	A-1
A-1-1: Motor effective torque.....	A-2
A-1-2: Load inertia moment.....	A-4

1	The World of Positioning Control
2	Positioning by AC Servo System
3	Components of Positioning Control and Their Roles
4	Advanced Positioning
5	Actual Positioning
6	Product Line up
A	Appendix A: Tentative Selection of Motor Capacity

1. The World of Positioning Control

1.1 Welcome to the new world!

The positioning controller, together with the programmable controller, personal computer and operator interface, is one of the four main units of FA (factory automation).

Among them, the positioning controller is important as the basis of FA, and regarded as the center of the mechatronics field in which many senior engineers have been playing active parts.

Positioning is all about motion, and motion often involves speed and precision. As speed can be related to productivity, it is an area of much development. But, when the machine speed increases, a problem with the stop precision is often generated. In order to solve this problem, diversified grades of position controllers have been required and developed.

Improvement of the machine efficiency generates immeasurable added value, including reduction of labour and the machine floor area for the same quantity of production.

If there are no problems related to the positioning aspect of a machine, it may mean that the machine is not running most efficiently. Here is where the science of developing an optimum positioning control system comes in.

1.2 Diversified actuators

- A power source which moves an element in a system is called actuator. A unit which detects a position of a work piece or moving part is called sensor.
- Diversified actuators and sensors, from simple ones to enhanced ones, are used in positioning.
- This paragraph describes representative types, their features and weak points.

Pneumatic	<p>The diagram illustrates a pneumatic actuator system. It features a cylindrical compressor at the bottom left, connected by a network of pipes (labeled 'Piping') to an air cylinder. The air cylinder is connected to a rectangular workpiece, which is shown in a partially extended position.</p>
<ul style="list-style-type: none"> • Air source and high grade piping are required. • High torque is not available. • Multi-point positioning is complex and very difficult to achieve. • Change in positioning is difficult. 	

Brake motor	<p>The diagram shows a motor with a brake mechanism. The motor is connected to a rectangular workpiece. A limit switch is mounted on the workpiece to detect its position.</p>
<ul style="list-style-type: none"> • Positioning mechanism is simple. • Repeatability is poor. • Change in positioning is difficult. <p>(When optical sensors or limit switches are used for stop)</p>	

Clutch brake	<p>The diagram depicts a can feed mechanism. It includes a motor at the bottom left, which drives a speed reducer. The speed reducer is connected to a clutch brake unit. This unit is part of a constant quantity feed hopper that dispenses material into a can feed mechanism. An optical sensor is positioned to detect the position of the can feed mechanism.</p>
<ul style="list-style-type: none"> • Frequent positioning is available. • Life of friction plate is limited. • Change in positioning is difficult. <p>(When optical sensors or limit switches are used for stop)</p>	

Stepping motor	
<ul style="list-style-type: none"> • Positioning mechanism is simple. • If load is heavy, motor may step out and displacement can occur. • Motor capacity is small. • Precision is poor at high speed. 	

DC servo system	
<ul style="list-style-type: none"> • Positioning precision is good. • Maintenance is required for motor brushes. • It is not suitable for rotation at high speed. 	

General purpose inverter and general purpose motor	
<ul style="list-style-type: none"> • Multi-speed positioning is available using high-speed counter. • High precision positioning is not available. • Large torque is not available at start. (Specialized inverter is required) 	

AC servo system	
<ul style="list-style-type: none"> • Precision is good. • Maintenance is not required. • Positioning address can be easily changed. • It is compact, and offers high power. 	

1.3 Positioning method type

1) There are three types of positioning method

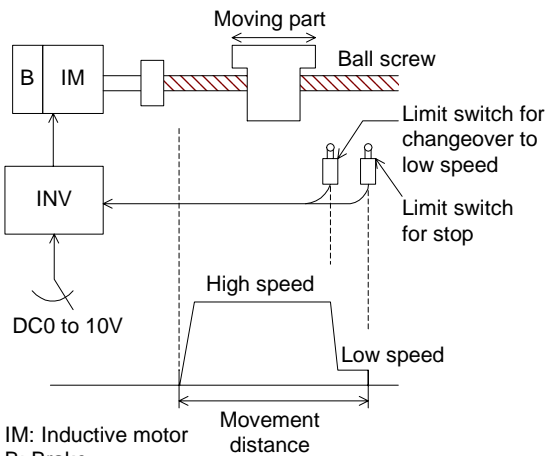
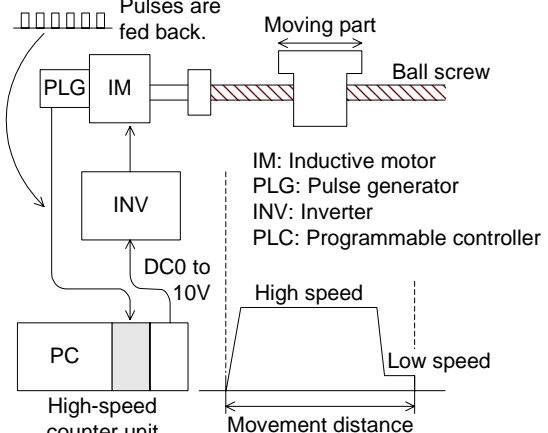
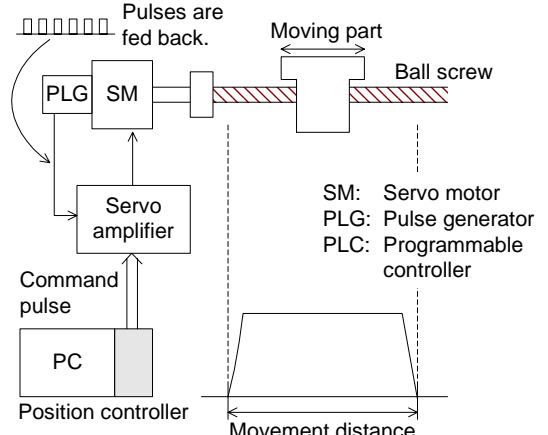
Control method	Description	Schematic drawing
<p>Speed control</p>	<p>Limit switch method</p> <p>Two limit switches are provided in places where a systems moving part passes. At the first limit switch, the motor speed is reduced. At the second limit switch, the motor turns off and the brake turns on, to stop the moving part. In this method, because position controllers are not required, the system configuration can be realized at reasonable cost.</p>	 <p>The schematic shows a motor system with a moving part on a ball screw. It includes an inverter (INV) and a brake (B) connected to an inductive motor (IM). Two limit switches are positioned along the path: one for speed changeover and one for stop. A speed profile graph shows high speed followed by low speed and then a stop. A DC0 to 10V power source is indicated.</p> <p>IM: Inductive motor B: Brake INV: Inverter</p>
	<p>(Guideline of stopping precision: Approximately ± 1.0 to 5.0 mm)*</p>	
<p>Speed control</p>	<p>Pulse count method</p> <p>A position detector (such as pulse encoder) is set up in a motor or rotation axis. The pulse number generated from the position detector is counted by a high-speed counter. When the pulse number reaches the preset value, the moving part stops. In this method, because limit switches are not used, the stop position can be easily changed.</p>	 <p>The schematic shows a motor system with a moving part on a ball screw. It includes a pulse generator (PLG) on the motor, an inverter (INV), and a programmable controller (PC). The PC is connected to a high-speed counter unit. A speed profile graph shows high speed followed by low speed and then a stop. DC0 to 10V power is provided.</p> <p>IM: Inductive motor PLG: Pulse generator INV: Inverter PC: Programmable controller</p>
<p>Position control</p>	<p>Pulse command method</p> <p>An AC servo motor which rotates in proportion to the input pulse number is used as the drive motor. When the pulse number corresponding to the movement distance is input to the servo amplifier of the AC servo motor, positioning can be performed at high speed in proportion to the pulse frequency.</p>	 <p>The schematic shows a motor system with a moving part on a ball screw. It includes a servo amplifier, a pulse generator (PLG), and a servo motor (SM). A position controller (PC) provides a command pulse to the servo amplifier. A speed profile graph shows high speed followed by low speed and then a stop. DC0 to 10V power is provided.</p> <p>SM: Servo motor PLG: Pulse generator PC: Programmable controller</p>

*1 The stop precision shows a value in a case where low speed is 10 to 100 mm/s.

2) Positioning method and stop precision

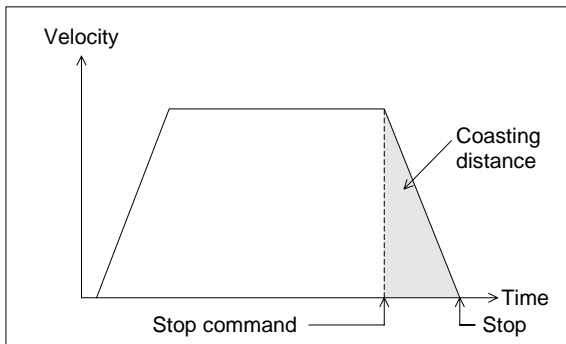

< Limit switch method >

- When automatically stopping a moving part driven by a motor, stop the motor by a position signal, detected by a limit switch (in general conditions, turn on the brake at the same time).

- The moving part continues by a coasting distance until it completely stops, after the stop command is given. The coasting distance is shaded in the figure.

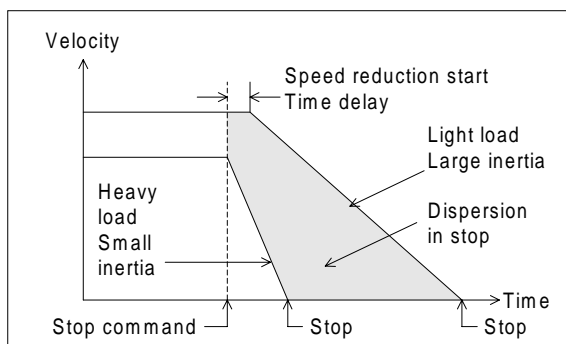

- The stop precision is equivalent to the dispersion in the shaded area as shown in the figure on the left.

The dispersion is affected by the speed when the stop command is given, the load size and the time delay since the stop command is given, until speed reduction actually starts.

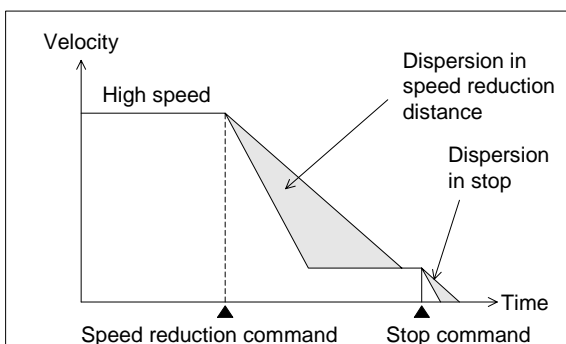

- If the required stop precision is not satisfactory when stopping from the normal operation speed, the most effective method to improve the stop precision is to reduce the operation speed.

- However, if the operation speed is simply reduced, the machine efficiency may also be reduced. In actual operation, the motor speed can be reduced from high speed to low speed once, then the motor stopped.

< Pulse count method >

- When a pulse encoder is attached to a moving part, and the motor speed is controlled by a number steps while the pulse number is counted, the movement quantity per pulse is determined in accordance with the relationship between the pulse number generated by one rotation of the encoder, and the movement quantity of the moving part (workpiece) realized by one rotation of the motor. The movement quantity per pulse is regarded as the minimum unit for the stop command.
- However, the coasting distance at stop is not eliminated.

< Pulse command method >

- In this method using a servo system, the weak points described above are improved. A pulse encoder is attached to the servo motor, detecting the motor rotation quantity (workpiece movement distance), to continuously and directly control the speed from the high-speed operation to the target position, which allows the workpiece to stop with good precision.
- As the coasting distance at stop is eliminated, the positioning precision is improved.

1	The World of Positioning Control
2	Positioning by AC Servo System
3	Components of Positioning Control and Their Roles
4	Advanced Positioning
5	Actual Positioning
6	Product Line up
A	Appendix A: Tentative Selection of Motor Capacity

2. Positioning by AC Servo System

2.1 When an AC servo system is introduced

- Positioning can be performed by many diversified methods. Recently, AC servo methods which offer many advantages are often introduced.
- In the positioning system of an AC servo method, a position controller, servo amplifier and servo motor are generally required. The representative system configuration is shown below.

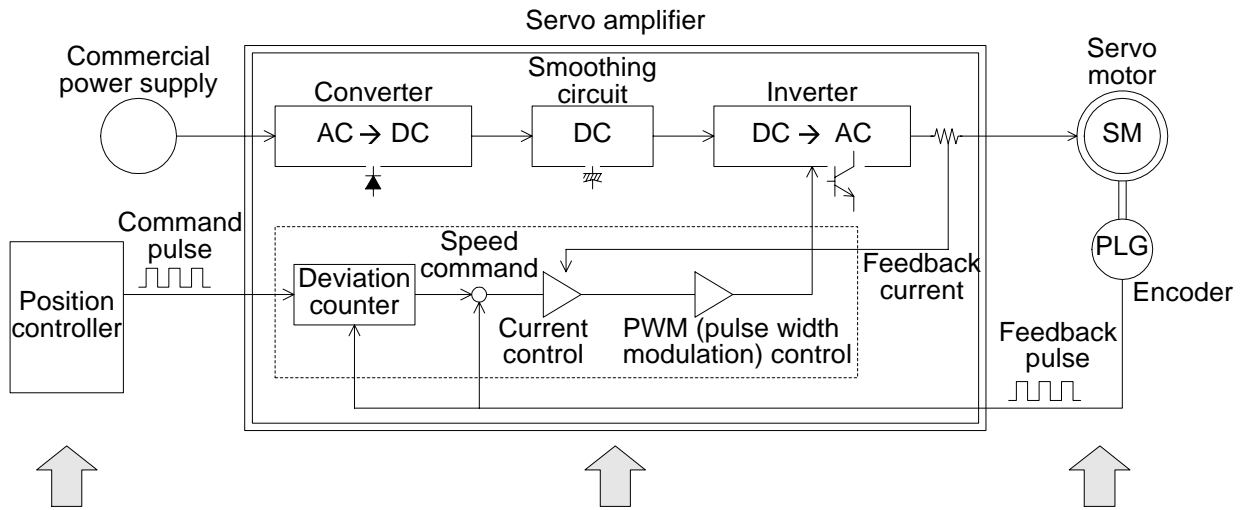

The position controller generates a specified quantity of forward rotation (or reverse rotation) pulses at a specified frequency.

The command pulse number is subtracted by the feedback pulse number, and the speed command to drive the servo motor is made from the deviation (accumulated pulse number).
When the accumulated pulse number becomes 0, the servo motor stops.

The servo motor is equipped with a built-in encoder (pulse generator), dedicated to high speed response, and suitable to positioning control.

Why is the AC servo system attracting attention?

The AC servo system satisfies the needs for multi-model small-lot production through only simple changes in the program.

AC servo systems are easier to handle than hydraulic equipment.

As an AC servo system can generate large torque, it can satisfy the needs for down sizing and high power.

- Release from oil management

Robots in conjunction with an AC servo system can satisfy the needs for labor saving and automation.

- Release from dangerous, hard and dirty working environments

In the latest AC servo systems, conventional weak points have been improved as follows.

- Though the latest systems are completely digital, they are equipped with parameters in conformance to diversified mechanical specifications and electrical specifications so that simple setting is possible.
- As frequent operation is enabled by a low inertia motor, the maximum torque is increased and the system can be applied to diversified machines.
- The latest systems are equipped with an auto tuning function, with which the servo amplifier automatically detects the load inertia moment and adjusts the gain. This is possible even if the load inertia moment is unknown.

Aspects described below are now incorporated to AC servo systems which offer marked improvements from previous products.

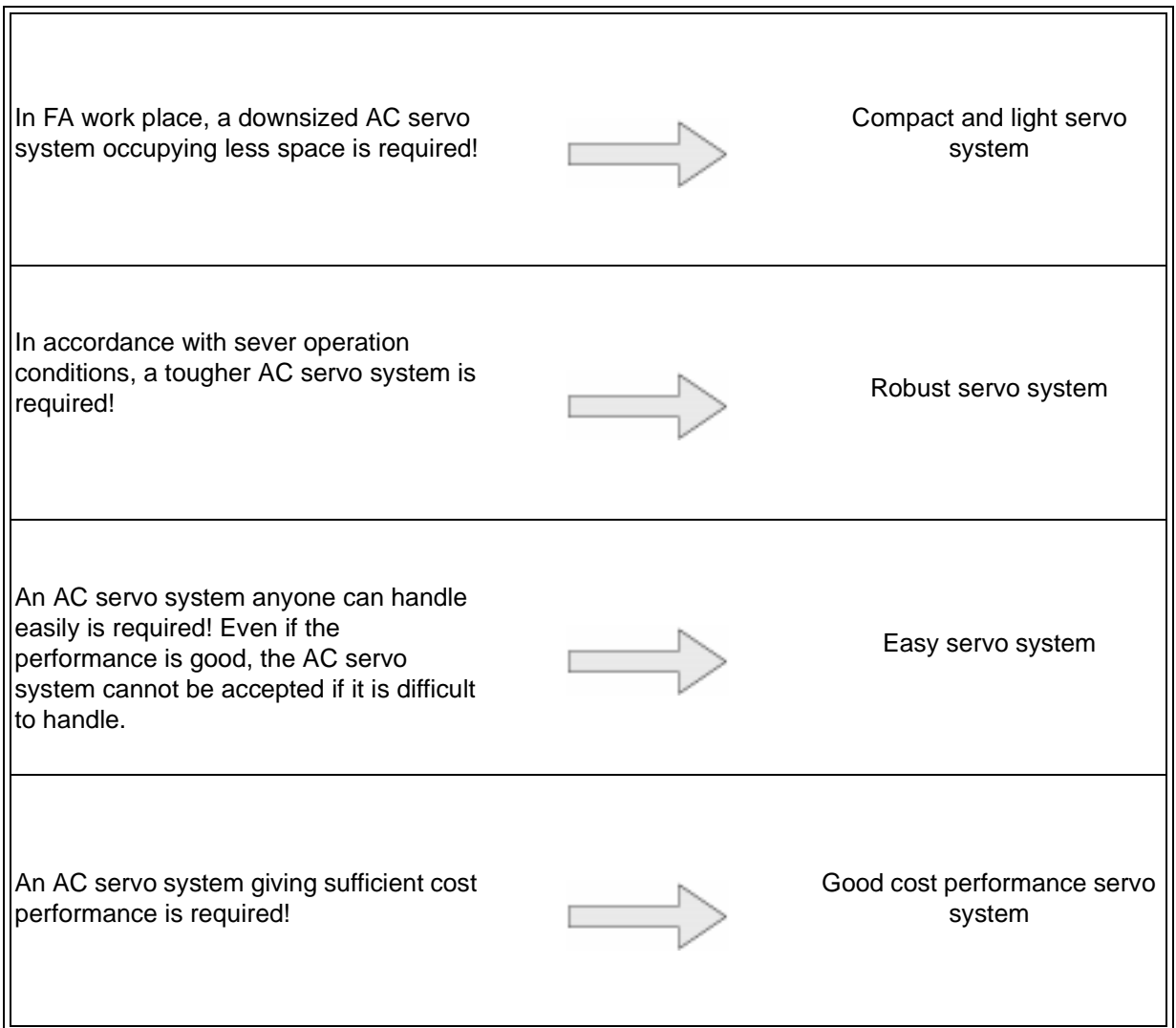

2.2 Examples of AC servo systems

- Positioning indicates the operation to move an element, such as a workpiece or tool (drill or cutter) from a certain position (point) to another target position (point) and stop it with high efficiency and high precision.
- In other words, the principle of positioning is the control of speed in accordance with the position, performed to promptly eliminate the remaining distance to the target position. The flexibility to change the target position electrically and easily is an important requirement.
- Several cases of positioning using an AC servo motor are systematically shown below.

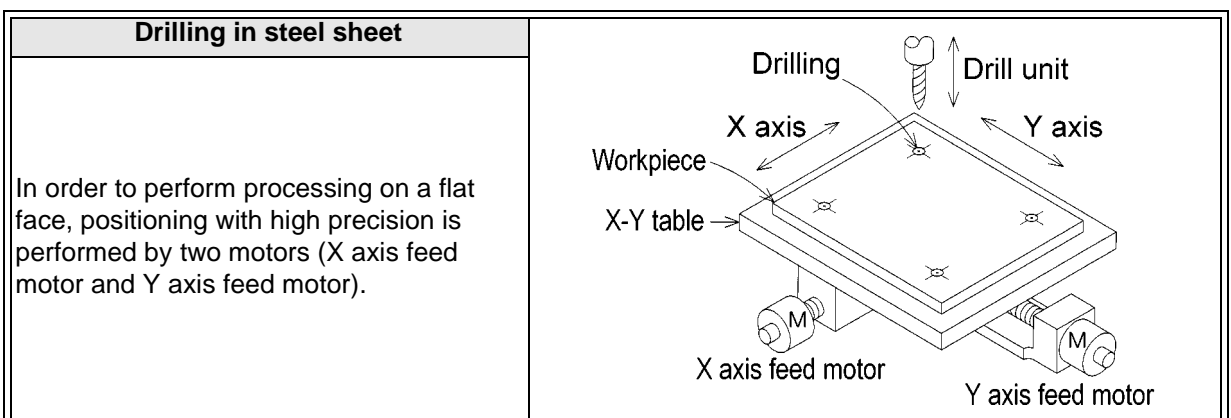
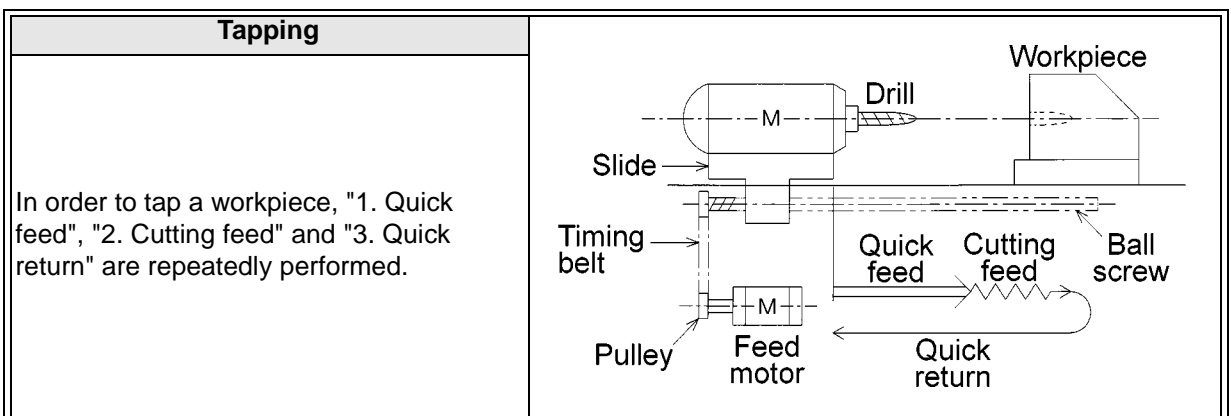
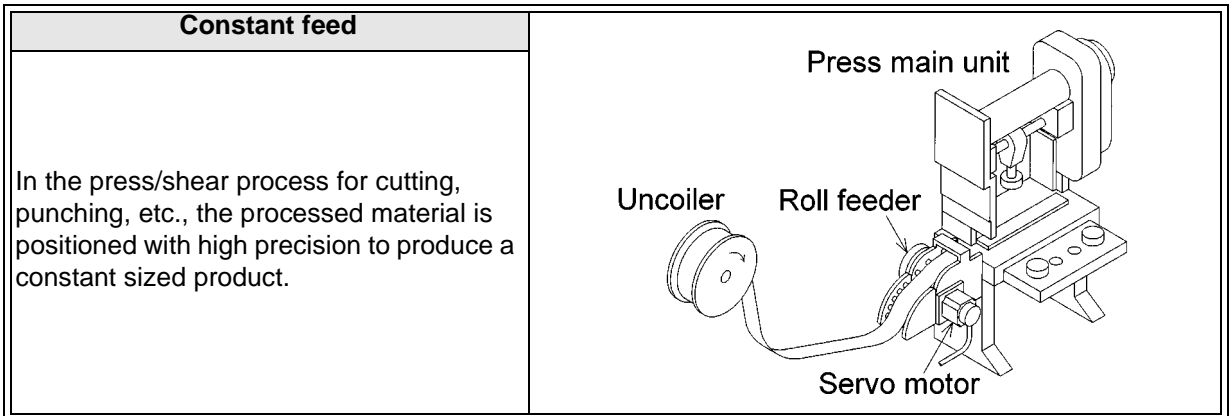

Index table	<p style="text-align: center;">Index table</p> <p style="text-align: center;">Worm wheel</p> <p style="text-align: right;">Servo motor</p>
<p>The position of the circular table is indexed.</p> <p>The index position is set on the outside (digital switch) or the inside (program). Shortcut drive is performed depending on the index position.</p>	

Lifter moving-up/down	<p style="text-align: center;">Lifter</p> <p style="text-align: center;">Servo amplifier</p> <p style="text-align: right;">Regenerative option</p> <p style="text-align: center;">Servo motor</p>
<p>As negative load is applied on the servo motor in positioning of the lifter in the vertical direction, a regenerative option is used also.</p> <p>In order to hold the lifter stationary and prevent drop of the lifter by power interruption, a servo motor with electromagnetic brake is used.</p>	

Cart travel control	<p style="text-align: center;">Cart</p> <p style="text-align: center;">Drive wheel (on each of left and right sides)</p>
<p>A servo motor is mounted in the travel cart as the drive source.</p> <p>A mechanism such as rack and pinion is adopted to prevent slippage between the wheels and rails.</p>	

Carrier robot	<p style="text-align: center;">Travel head</p> <p style="text-align: center;">Y direction</p> <p style="text-align: center;">Slide arm</p> <p style="text-align: center;">X direction</p> <p style="text-align: center;">Palette</p> <p style="text-align: center;">Workpiece</p> <p style="text-align: center;">Conveyor</p> <p style="text-align: center;">Arm vertical axis (driven by air cylinder)</p> <p style="text-align: right;">Servo motor to drive slide arm</p> <p style="text-align: right;">Servo motor to drive travel head</p>
<p>After the conveyor stops, the 2-axis servo system and the arm lifting mechanism transfer workpieces to a palette.</p> <p>The workpiece input positions on the palette can be set to many points so that setup change can be easily performed, even if the palette position and the palette shape change.</p>	

1	The World of Positioning Control
2	Positioning by AC Servo System
3	Components of Positioning Control and Their Roles
4	Advanced Positioning
5	Actual Positioning
6	Product Line up
A	Appendix A: Tentative Selection of Motor Capacity

3. Components of Positioning Control and Their Roles

Positioning control requires a number of components such as a positioning controller, servo amplifier, servo motor and drive mechanism. This section describes the role of each component.

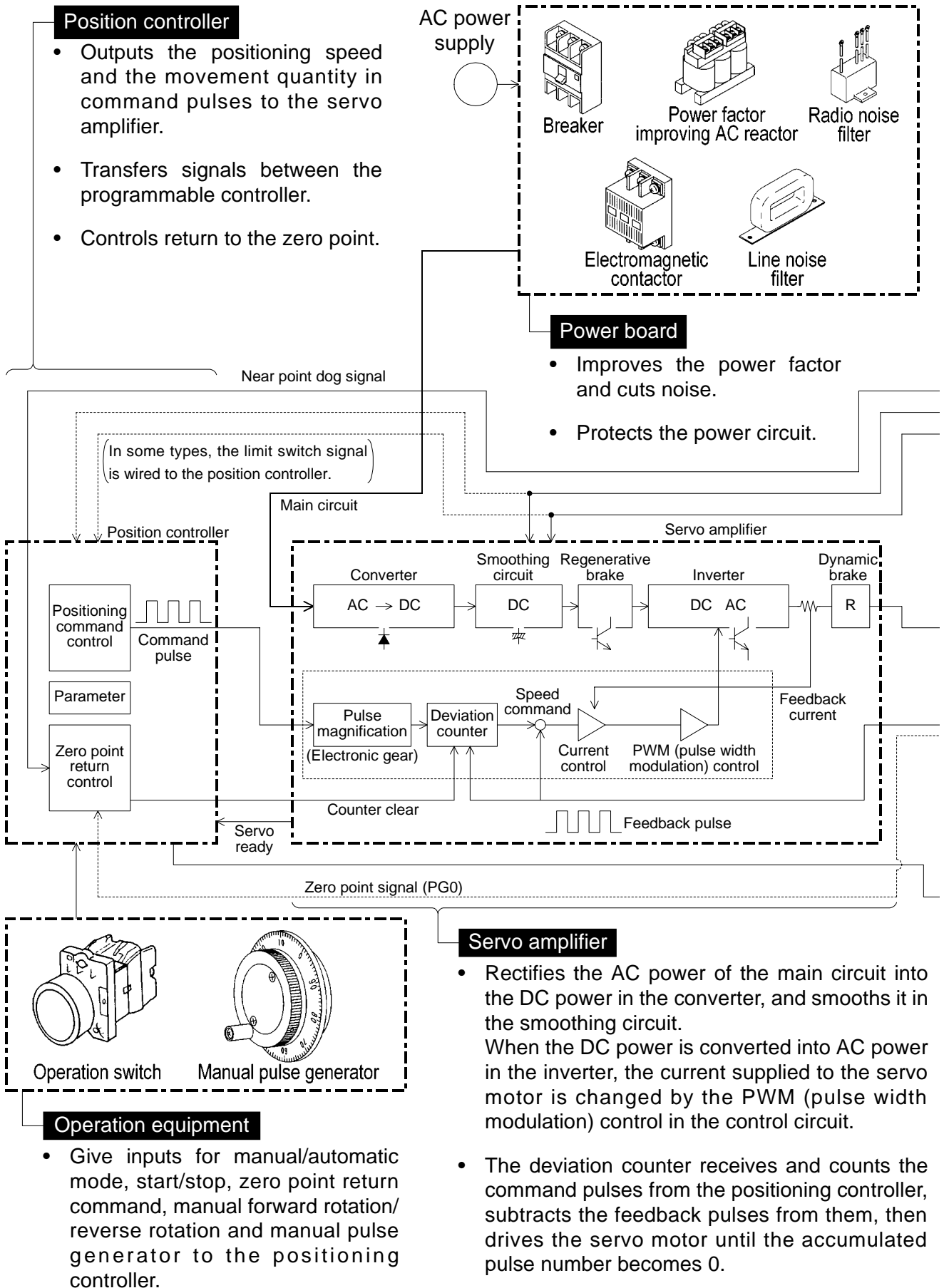

Servo motor

- Dedicated to high speed response optimal to positioning control, has large start torque, large maximum torque and wide variable speed range 1/1 or more (1/1,000 to 1/5,000).

When a moving element goes beyond a limit switch (LS), the motor stops.

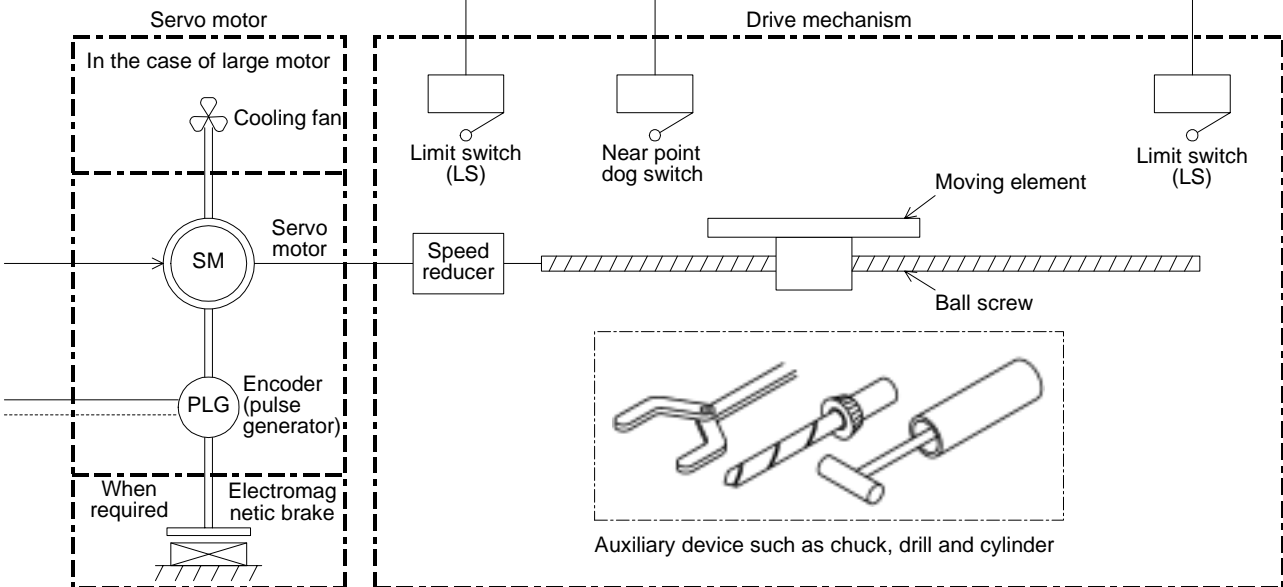

Sensor, actuator, auxiliary device

- The actuator (moving part drive mechanism) is equipped with speed reducer, timing belt, ball screw and limit switch.
- Diversified auxiliary devices are also controlled in accordance with positioning.
- The PLC or the positioning controller also controls auxiliary devices.
- The auxiliary device operation completed signal is output to the PLC or the position controller.

Setting / display unit

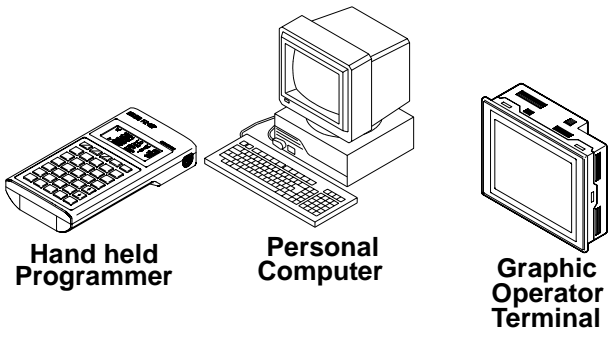

- Used to write programs to the position controller, allows setting and display of the data.

3.1 Positioning controller

As the positioning controller gives position commands to the servo amplifier, positioning programs should be created, and parameters defined. The contents related to programs and parameters are described below.

3.1.1 Command pulse and feed quantity

There are the following three types of command pulse output modes.

- PLS/SIGN mode
- CW/CCW mode
- A phase/B phase mode

From the three, the CW/CCW mode is picked up for explanation.

- When the servo motor encoder generates 8,192 pulses for one rotation, the command pulse number "8,192" should be output to rotate the servo motor by 1 rotation. The workpiece feed quantity is in proportion to the pulse number.

< Forward rotation command >

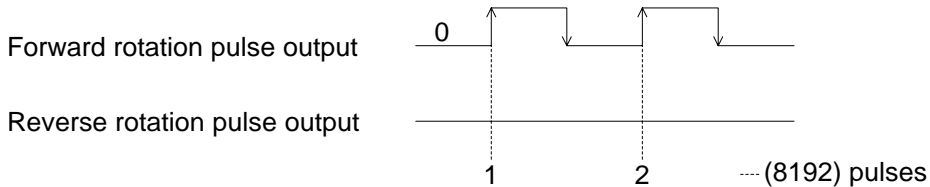

< Reverse rotation command >

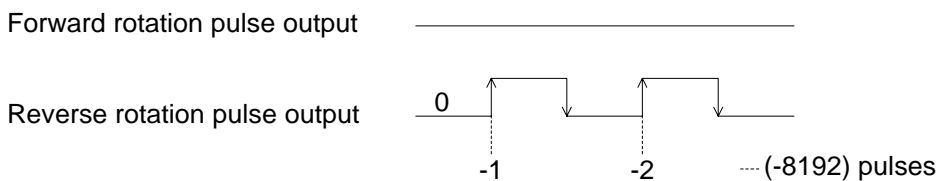

3.1.2 Command pulse and feed speed

- When the servo motor encoder generates 8,192 pulses for one rotation, the command pulse frequency (speed) "8,192 pulses/s" should be output to rotate the servo motor by 1 rotation per second.

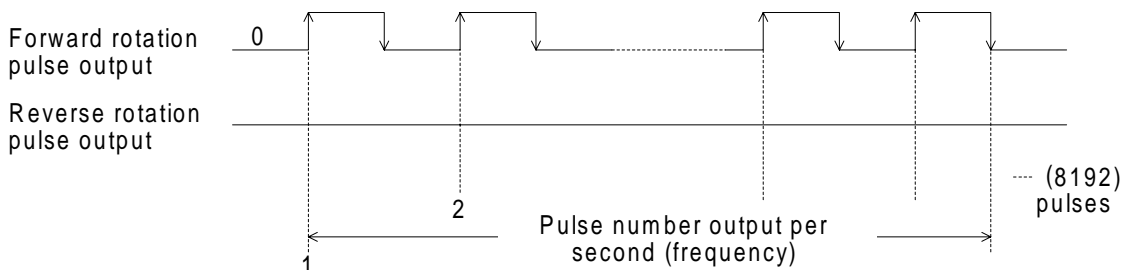

- Decrease the pulse frequency to rotate the servo motor at lower speed.
- Increase the pulse frequency to rotate the servo motor at higher speed.

3.1.3 Setting the acceleration/deceleration time

- When the start command is given, acceleration, operation at constant speed and deceleration are performed for positioning. Set the acceleration time and the deceleration time in the parameters.

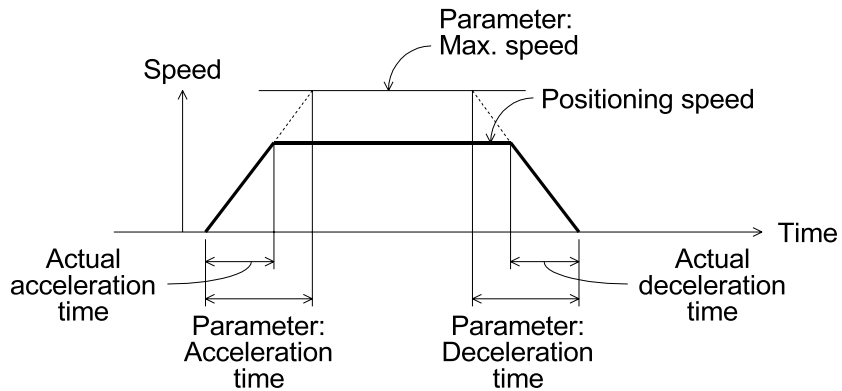

- This operation pattern is effective during return to the zero point, positioning and jog operation.

3.1.4 Backlash correction function

- The positioning controller can output excessive pulses, only when the movement direction is inverted so that the backlash of the mechanical system is corrected.

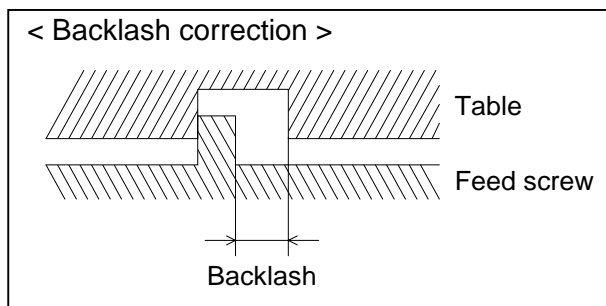

3.1.5 Zero point return function

- There are two types of servo motor encoders, incremental type (pulse count method) and absolute type (absolute position detection method).
- Incremental type is constructed so that the current value stored in the position controller does not increase or decrease, even if the workpiece stop position changes by some reason while the power is turned off, therefore the positioning address is not assured.
- Accordingly, when the power is turned on, the machine should be moved to the reference point to update the zero point address. This operation is called return to zero point.
- Absolute type is constructed so that the current value stored in the position controller increases or decreases if the workpiece stop position changes while the power is turned off, thus the positioning address is assured. Accordingly, when the power is turned on, return to the zero point is not required.
However, when the machine is used for the first time, it should be returned to the zero point so that it recognizes the zero point address.

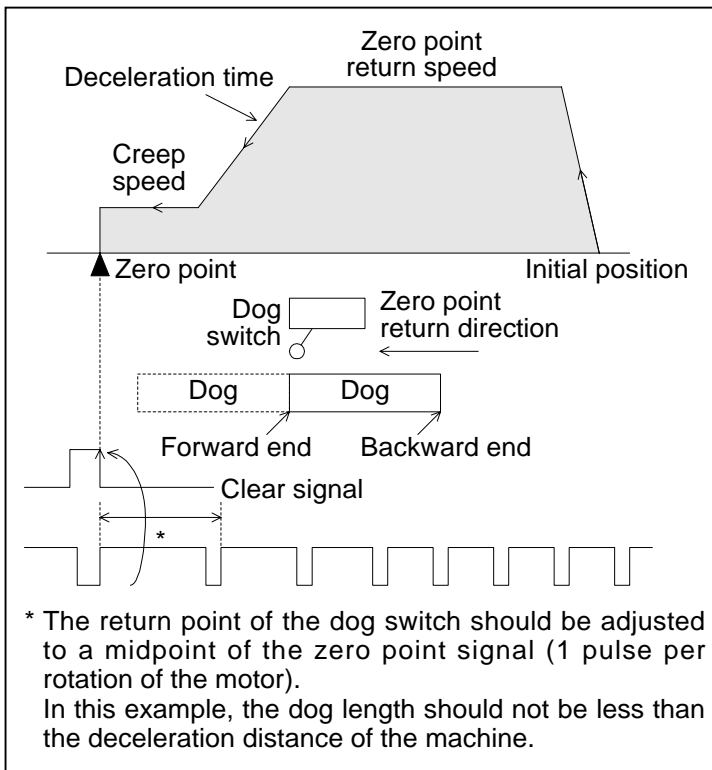

< Operation to return to the zero point >

- The zero point return direction, return speed, deceleration time and creep speed are set by parameters in the positioning controller.
- There are several zero point return methods. For example, when the forward end of the dog reaches the dog switch, the motor resumes its creep speed. At the first zero point signal after the dog reaches the backward end, the deviation counter clear signal is output and the motor stops.
- The zero point address set by a parameter is written to the current value register of the position controller.

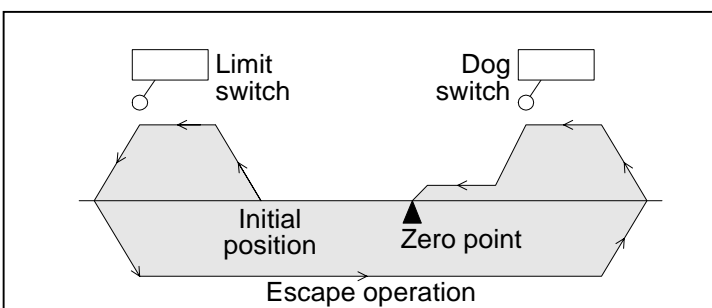

- In some models, if the zero point return operation is performed while the work piece is stopped beyond the dog switch, the machine moves once until the limit switch is actuated, inverts the direction, then returns to the zero point again (dog search function, zero point return retry function).

3.2 Servo amplifier and servo motor

The servo amplifier controls the movement quantity and the speed in accordance with commands given by the positioning controller. The servo motor transmits rotation to the drive mechanism after receiving a signal from the servo amplifier.

3.2.1 Positioning control in accordance with command pulse

- By PWM (pulse width modulation) control, performed to the servo amplifier main circuit with regard to the position command and the speed command, in accordance with the command pulses of the position controller, the servo motor is driven. The rotation speed and the rotation quantity are fed back from the encoder attached to the servo motor.

3.2.2 Deviation counter function

- The difference between the command pulses and the feedback pulses counted by the deviation counter in the servo amplifier is called accumulated pulses.
- While the machine is operating at a constant speed, the accumulated pulse quantity is almost constant. During acceleration and deceleration, the accumulated pulse quantity changes more dramatically.
- When the accumulated pulse quantity becomes equivalent to or less than the specified quantity (in-position set value) after command pulses have stopped, the servo amplifier outputs the positioning completed signal.

The servo motor continues operation even after that. Then, when the accumulated pulse quantity becomes 0, the servo motor stops.

The time after the servo motor outputs the positioning completed signal, until it stops is called stop settling time.

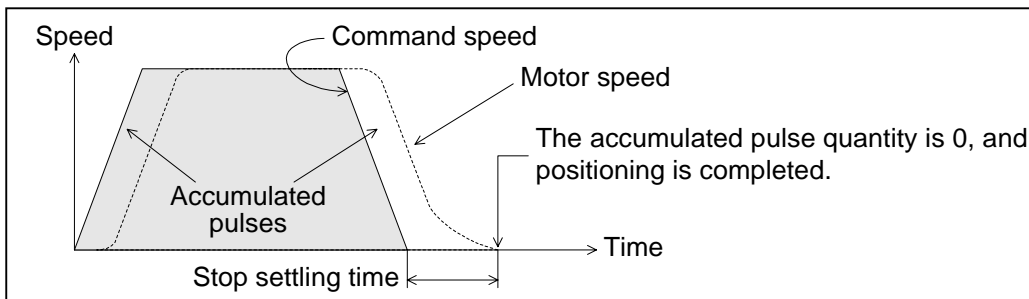

3.2.3 Servo lock function

- The servo motor is controlled so that the accumulated pulse quantity counted in the deviation counter becomes 0.
- For example, if an external force for forward rotation is applied on the servo motor, the servo motor performs the reverse rotation operation to eliminate the accumulated pulses.

Accumulated pulses in deviation counter	Servo motor
Minus pulses	Reverse rotation operation
Plus pulses	Forward rotation operation
0 (zero)	Stop

3.2.4 Regenerative brake function

- During deceleration, because the servo motor rotates by the load inertia of the drive mechanism, it functions as a generator and electric power returns to the servo amplifier. The regenerative resistor absorbs this electric power, and functions as a brake (called a regenerative brake.)
- The regenerative brake is required to prevent regenerative over voltage in the servo amplifier when the load inertia is large and the operation is frequently performed.
- The regenerative resistor is required when the regenerative power generation quantity during deceleration exceeds the allowable regenerative electric power of the servo amplifier.

3.2.5 Dynamic brake function

- When a circuit inside the servo amplifier is disabled by a power interruption in the AC power of the main circuit or actuation of the protective circuit, the terminals of the servo motor are short-circuited via resistors, the rotation energy is consumed as heat, then the motor immediately stops without free run.
- When the motor stops by elimination of the rotation energy, the brake is not effective and the motor runs freely.

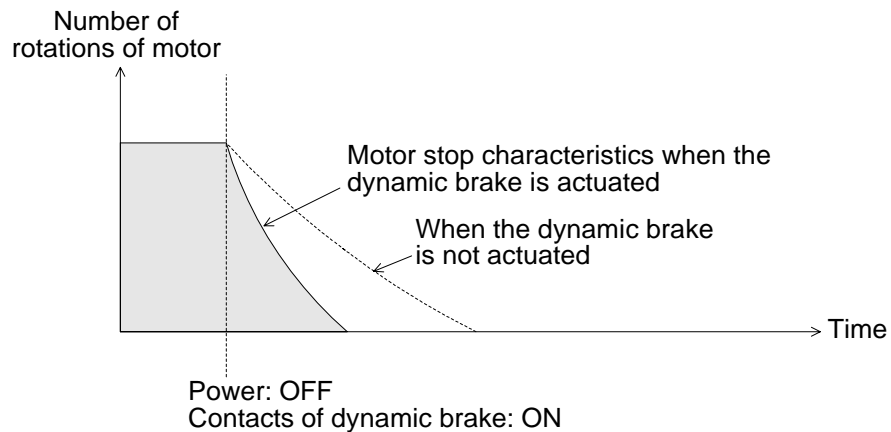
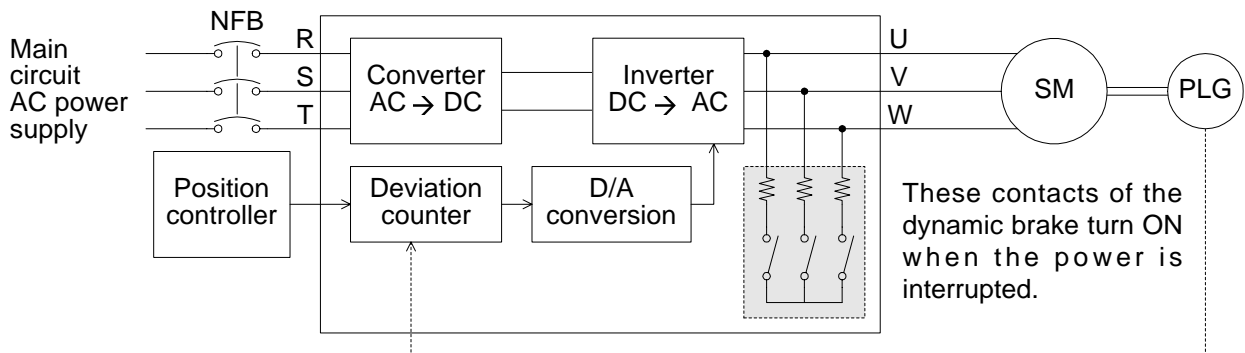

3.3 Drive mechanism

The drive mechanism converts the rotation motion of the servo motor into the reciprocating or vertical motion through a speed reducer, timing belt, ball screw, etc. to move the machine.

3.3.1 Concept of drive system movement quantity

1) Representative positioning system using AC servo motor

*2 In the structure design, parameters (such as Δl and V_0) should be determined in advance.

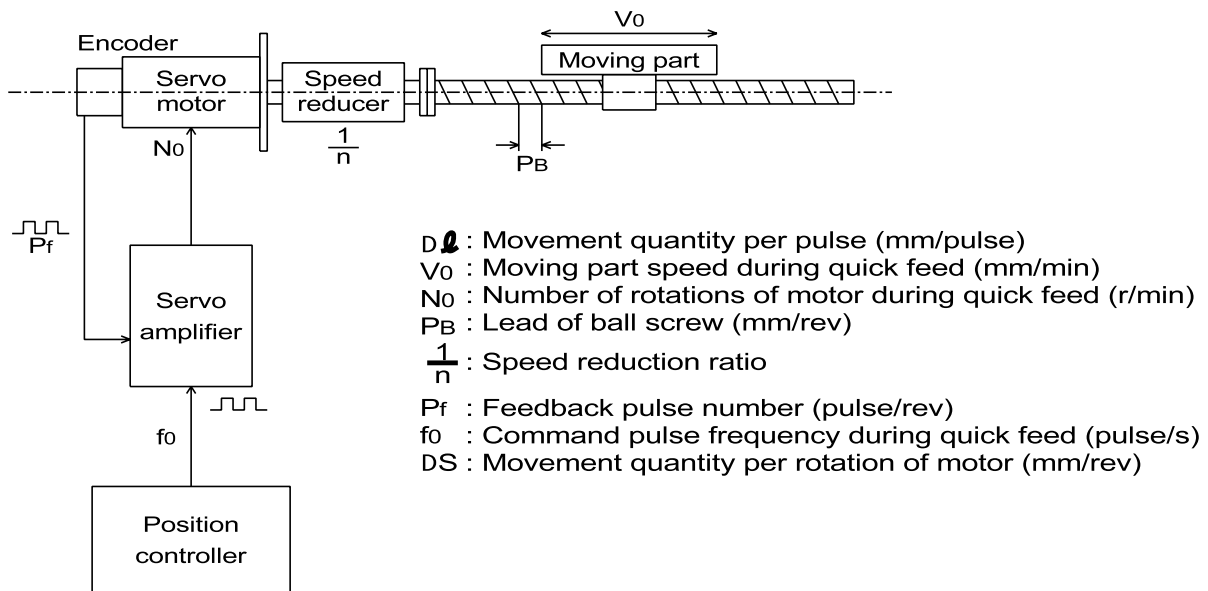

- The servo motor stops with the precision ($\pm \Delta l$) which is within ± 1 pulse against the command pulse.
- The movement quantity of the work piece is
 "Output pulses from position controller $\times \Delta l$ ".
 The moving part speed is
 "Command pulse frequency from position controller $\times \Delta l$ ".
- Either "mm", "inch", "degree" or "pulse" can be selected as the positioning command unit. Accordingly, when data such as the movement quantity per pulse, positioning speed or the positioning address in accordance with the positioning command unit are set, the pulse trains calculated inside the positioning controller are output for the target address, and positioning is performed.

2) Examples of calculation equations

a) Movement quantity per rotation of motor (mm/rev)

$$\begin{array}{l} \text{Movement} \\ \text{quantity per} \\ \text{rotation of motor} \end{array} = \text{Lead of ball screw (mm/rev)} \times \text{Speed reduction ratio}$$

b) Number of rotations of motor (rev/min.)

(The maximum number of rotations is realized during quick feed.)

$$\begin{array}{l} \text{Number of} \\ \text{rotations of} \\ \text{motor} \end{array} = \frac{\text{Moving part speed during quick feed (mm/min)}}{\text{Movement quantity per rotation of motor}} \leq \text{Rated number of rotations of servo motor}$$

Note: The number of rotations of a motor during quick feed should not exceed the rated number of rotations.

The moving part speed during quick feed should not exceed the parameter "speed limiting value" of the positioning controller.

a) Movement quantity per pulse (mm/pulse)

$$\begin{array}{l} \text{Movement} \\ \text{quantity} \\ \text{per pulse} \end{array} = \frac{\text{Movement quantity per rotation of motor (mm/rev)}}{\text{Feedback pulse number (pulse/rev)}} \times \text{Electronic gear ratio}$$

b) Command pulse frequency during quick feed (pulse/s)

$$\begin{array}{l} \text{Command} \\ \text{pulse} \\ \text{frequency} \\ \text{during} \\ \text{quick feed} \end{array} = \frac{\text{Number of rotations of motor during quick feed (r/min)} \times \text{Movement quantity per rotation of motor (mm/rev)}}{60 \times \text{Movement quantity per pulse (mm/pulse)}}$$

Note: The command pulse frequency during quick feed should not exceed the maximum input pulse frequency of the servo amplifier.

a) Maximum movement distance

In each of the absolute and incremental methods, the entire movement distance should not exceed the maximum pulse number of the positioning controller.

3.3.2 Setting the target position

In positioning control, the target position can be set by the following two methods. (Available command units are "mm", "inch", "degree" or "pulse".)

1) Absolute method

In this method, a point (absolute address) is specified for positioning while the zero point is regarded as the reference. The start point is arbitrary.

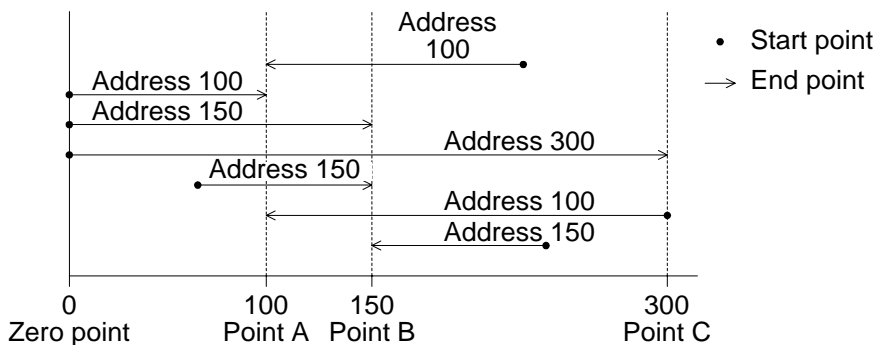

2) Incremental method

In this method, positioning is performed through specification of the movement direction and the movement quantity while the current stop position is regarded as the start point.

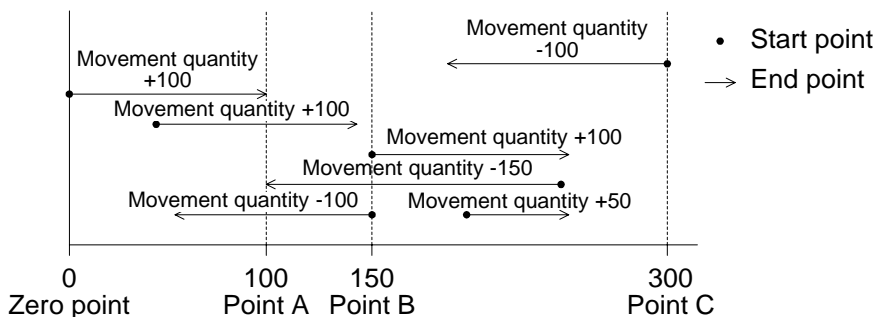

1	The World of Positioning Control
2	Positioning by AC Servo System
3	Components of Positioning Control and Their Roles
4	Advanced Positioning
5	Actual Positioning
6	Product Line up
A	Appendix A: Tentative Selection of Motor Capacity

4. Advanced Positioning

4.1 Interpolation control

The interpolation function controls two or more axes alternately or simultaneously. Linear interpolation and circular interpolation are usually offered.

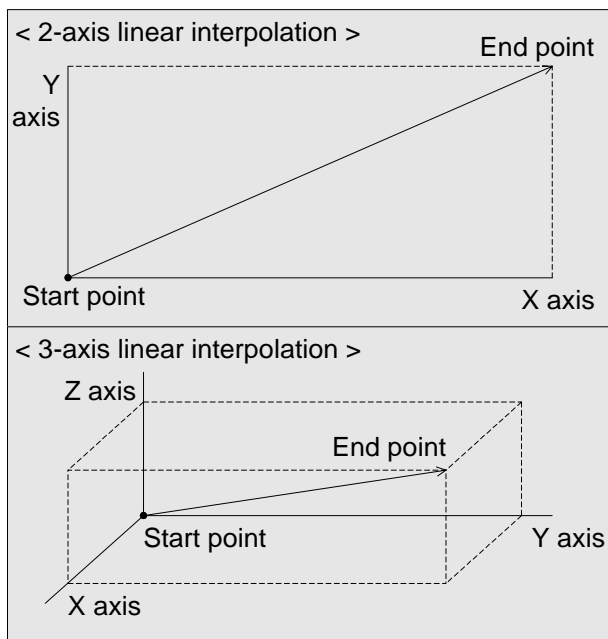

< Linear interpolation >

- Linear interpolation controls two or more axes so that the start point and the end point (target position) are connected in the shortest way.
- In this case, the locus is linear.
- Models applicable to 2-axis linear interpolation control
[FX-20GM,E-20GM,FX2N-20GM AD75P2/P3,AD75M2/M3, QD75P2/P4,QD75D2/D4, A171SH,A172SH,A173UH,A273UH]
- Models applicable to 3 or 4-axis linear interpolation control
[A171SH,A172SH,A173UH,A273UH]

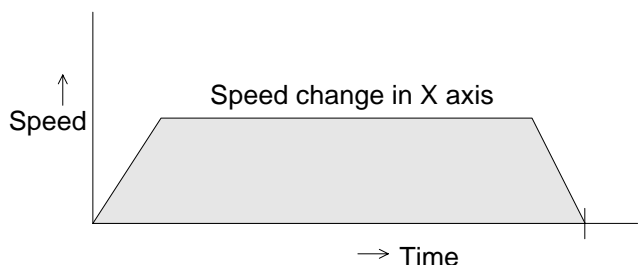

- Application examples
[Drilling on steel sheet, insertion of parts into PCB, automatic warehouse, automatic crane, etc.]

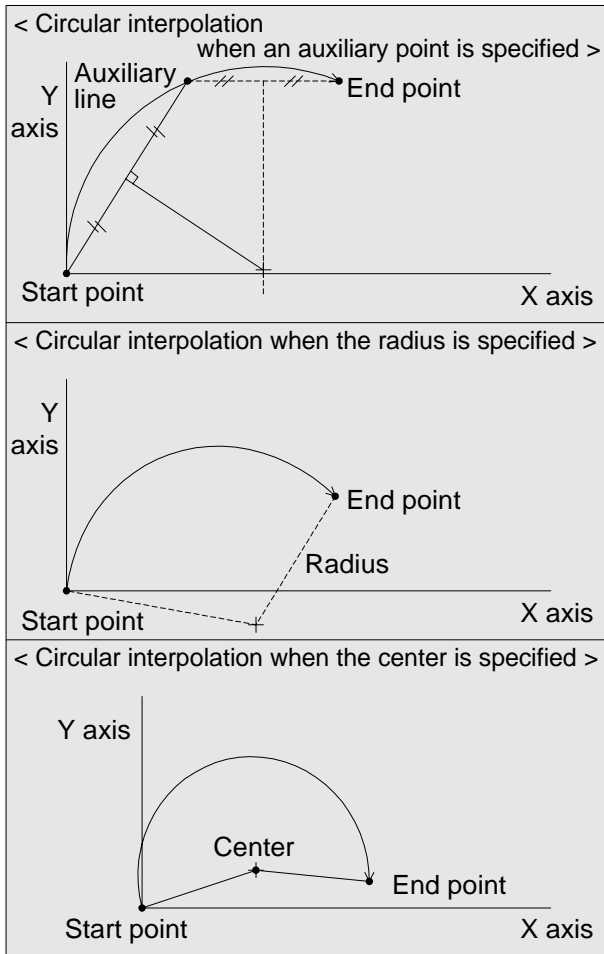

< Circular interpolation >

- Circular interpolation controls two or more axes so that the start point and the end point (target position) are connected with circular arc.
- As there are innumerable number of arc locus connecting two points, an auxiliary point, the arc radius, the center or the direction should be specified in addition to the start point and the end point to determine the circular arc.
- Models applicable to 2-axis circular interpolation control
[FX-20GM,E-20GM,FX_{2N}-20GM, AD75P2/P3,AD75M2/M3, QD75P2/P4,QD75D2/D4, A171SH,A172SH,A173UH,A273UH]
- Models applicable to 3-axis circular interpolation control
[A171SH,A172SH,A273UH]

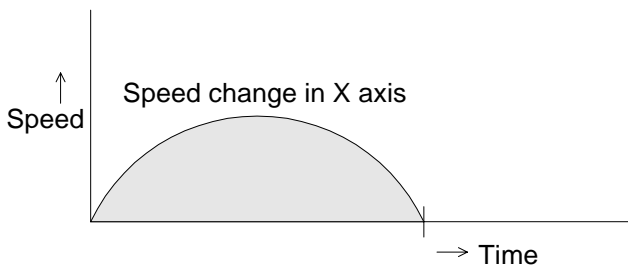

- Application examples
[Steel sheet fusing, welder, applicator, crane, etc.]

4.2 Other controls

In some models, controls in accordance with diversified special needs such as speed control, position follow-up control and three-dimensional interpolation control shown below are available.

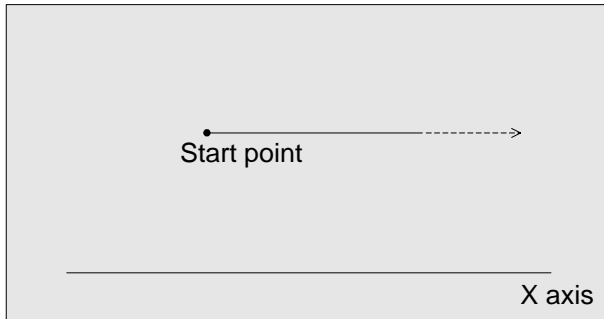

< Speed control >

- After movement starts from the start point, it then continues at the specified speed until the stop command is input.
- Applicable models
[FX-1PG,FX_{2N}-1PG
AD75P1/P2/P3,AD75M1/M2/M3,
QD75P1/P2/P3,QD75D1/D2/D3,
A171SH,A172SH,A173UH,A273UH]
- Application examples
[Conveyor, carrier unit, roller feed,
crane, etc.]

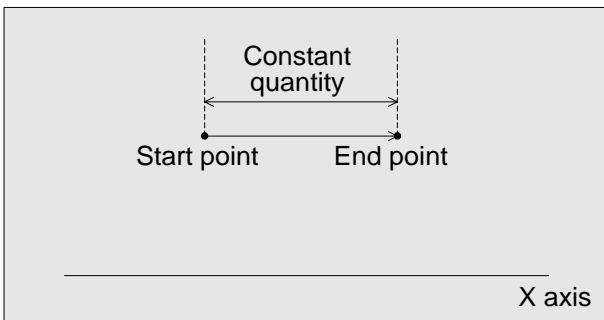
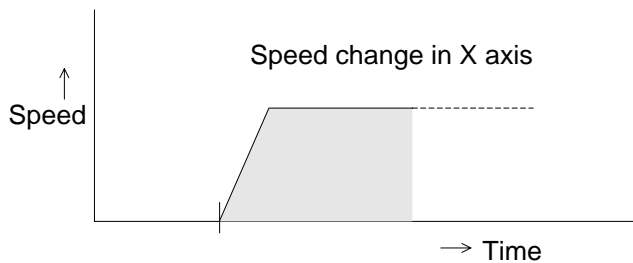

< Constant feed >

- After start, a workpiece moves by the specified constant quantity, but the current value does not increase even if the operation is repeated.
- Applicable models
[FX-10GM,FX-20GM,E-20GM,
FX_{2N}-10GM,FX_{2N}-20GM
AD75P1/P2/P3,AD75M1/M2/M3,
A171SH,A172SH,A273UH]
- Application examples
[Press, shear, conveyor, transfer unit,
assembly line, etc.]

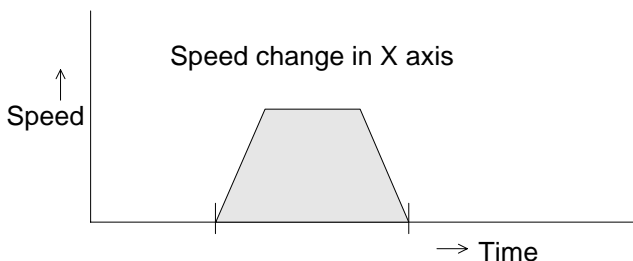

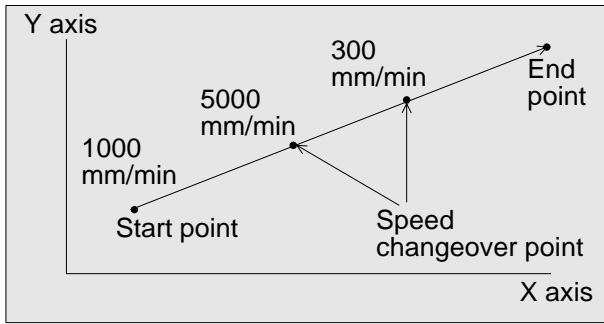

< Speed changeover control >

- From the start point which is the current stop address, positioning control is performed to the end point address while the speed changes at speed changeover points.
- The address for speed change can be determined in advance.
- Applicable models
[FX2N-1PG,FX-10GM,FX-20GM, E-20GM,FX2N-10GM,FX2N-10GM, AD75P1/P2/P3,AD75M1/M2/M3, QD75P1/P2/P4,QD75D1/D2/D4, A171SH,A172SH,A173UH,A273UH]
- Application examples
[Conveyor, carrier unit, roller feed, crane, etc.]

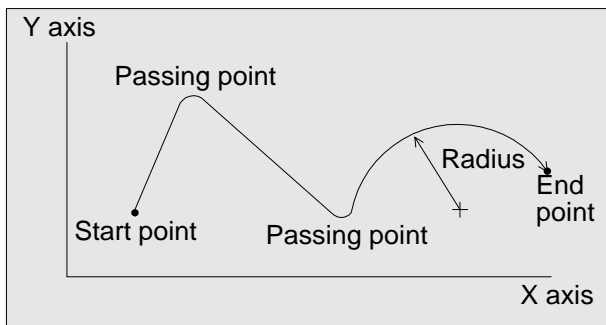
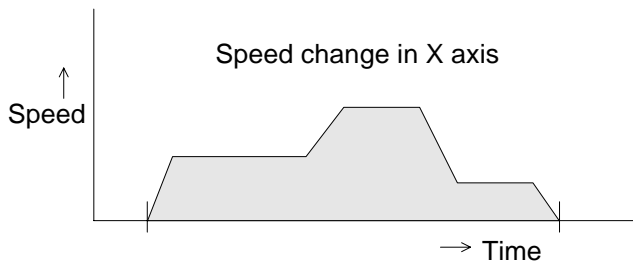

< Constant speed control >

- From the start point which is the current stop address, positioning control is performed to the end point address at an equal speed by way of passing points.
- Passing points make small circular arc.
- Applicable models
[AD75P1/P2/P3,AD75M1/M2/M3, QD75P1/P2/P3,QD75D1/D2/D4, A171SH,A172SH,A273UH]
- Application examples
[Steel sheet fusing, welder, applicator, crane, transfer robot, etc.]

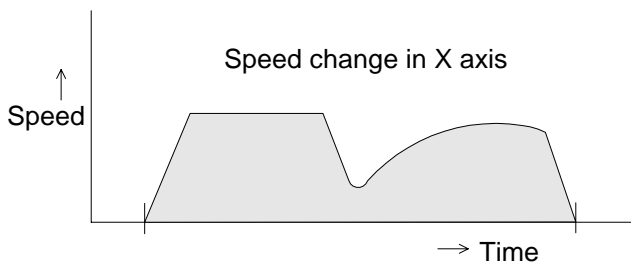

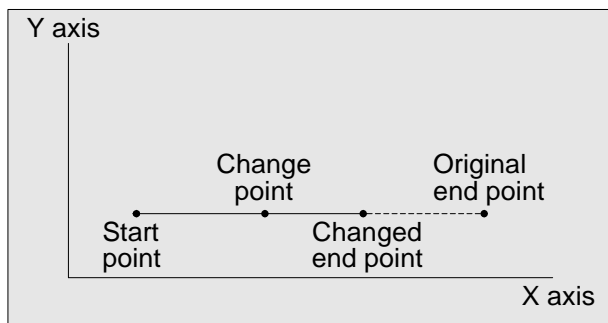

< Position follow-up control >

- If the end point address is changed while a positioning control movement is being executed, positioning is controlled to the new end point address.
- Applicable models
[A171SH,A172SH,A273UH]

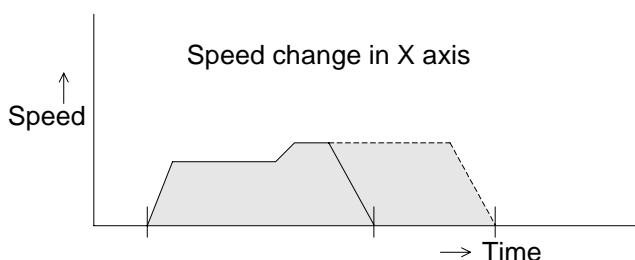

- Application examples
[Product follow-up type, application line and welding line]

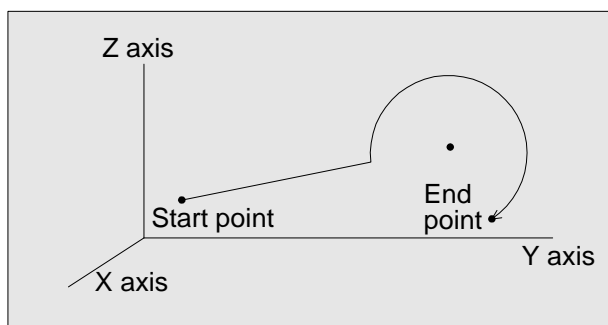

< Three-dimensional interpolation control >

- From the start point which is the current stop address, 3-axis linear interpolation control and 3-axis circular interpolation control are performed to the end point address by way of passing points.
- Applicable models
[A171SH,A172SH,A273UH]

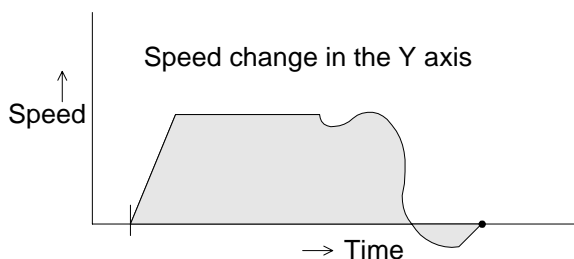

- Application examples
[Assembly robot, welding robot, application robot and transfer robot]

1	The World of Positioning Control
2	Positioning by AC Servo System
3	Components of Positioning Control and Their Roles
4	Advanced Positioning
5	Actual Positioning
6	Product Line up
A	Appendix A: Tentative Selection of Motor Capacity

5. Actual Positioning

Terms required for positioning control have been explained in the first three sections. In this section, let's experience actual positioning control based on the knowledge you have learned so far.

The position controller FX_{2N}-20GM is used for the demonstration as show below. An FX-20GM can also be used in place of the FX_{2N}-20GM.

5.1 Demonstration Equipment

Two different levels of demonstration equipment can be used for this example, depending on what is available. The basic set utilizes the live monitoring function of the FX-PCS-VPS software, where as, the more comprehensive set makes use of an X Y plotting table, to actually see the axes move, and draw the resulting locus.

5.1.1 Basic Set

The demonstration items required for the basic setup are as follows;

- FX_{2N}-20GM
- F2-422 CAB0 Communications cable
- FX-232AW(C) Converter
- FX-232 CAB-1 Communications cable
- Personal computer
- FX-PCS-VPS\Win software

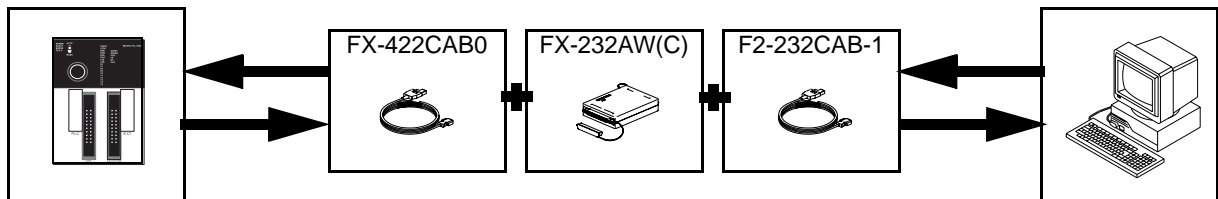

5.1.2 Comprehensive Set

The demonstration items required for the comprehensive setup are as follows;

- FX_{2N}-20GM
- F2-422 CAB0 Communications cable
- FX-232AW(C) Converter
- FX-232 CAB-1 Communications cable
- Personal computer
- FX-PCS-VPS\Win software
- Plotter Communications cable (*1 Specific to plotter)
- X Y Plotting table

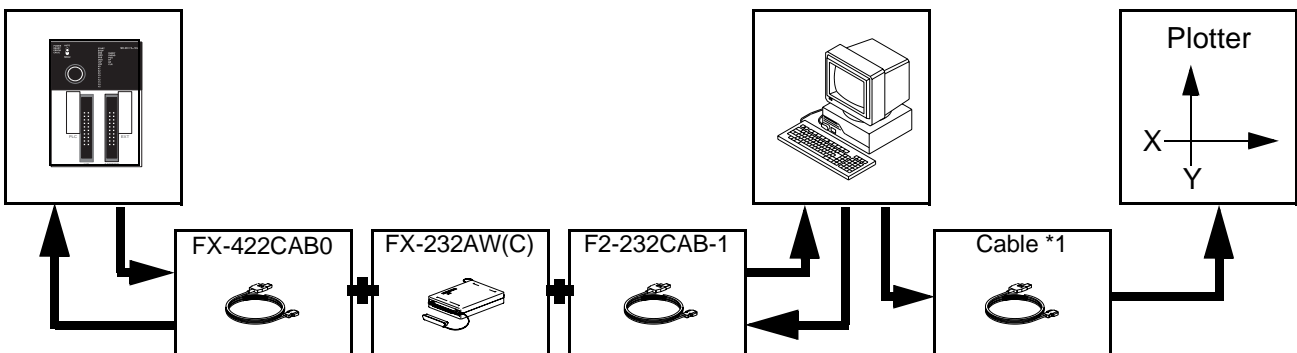

5.2 Operation of the demonstration equipment

Source the required demonstration equipment, and setup as in section 5.1. If a plotter is being used refer to the operations manual for the particular unit and setup accordingly.

Throughout this example it is assumed that you will have read and understood both the FX_{2N}-20GM Hardware / Programming manual (JY992D77801) and the FX-PCS-VPS/Win-E software manual (JY992D86801) or you will have then close at hand for reference.

For this example we will use the basic setup of Personal computer and FX_{2N}-20GM.

Let's draw the locus shown below driven by the X and Y axes simultaneously. The output Y0 is added to imitate a pen, or other end effector.

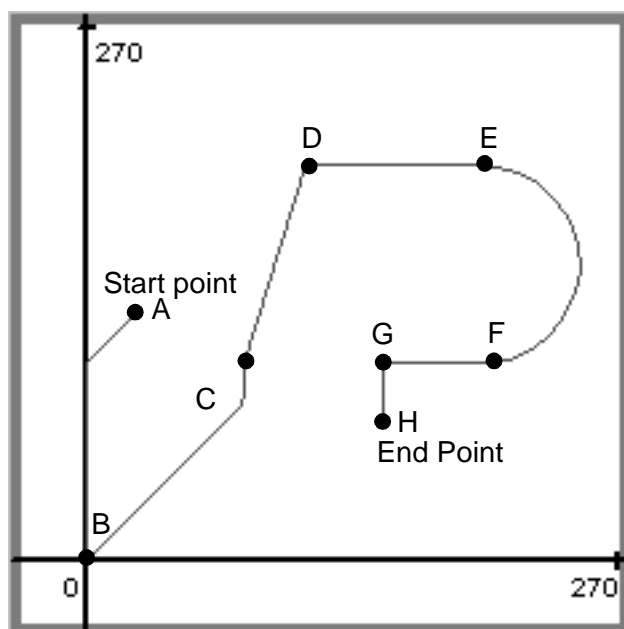

A: Start point, this point can be anywhere.

B: (0,0), Zero point, wait for 2 seconds.

C: (80,100), Output Y0 turns ON, wait for 2 seconds.

D: (110,200).

E: (200,200).

F: (200,100).

G: (150,100), Output Y0 turns OFF, wait for 2 seconds.

H: (150,70), End point.

A to B - Return to Electrical Zero.

B to C - High speed positioning.

C to D - Linear interpolation.

D to E - High speed positioning.

E to F - Clockwise circular interpolation.

F to G - High speed positioning.

G to H - High speed positioning.

5.2.1 Program example

The program below demonstrates basic positioning using the FX_{2N}-20GM. As this program is designed to be used without a mechanical plotter, the electrical zero point is used for reference.

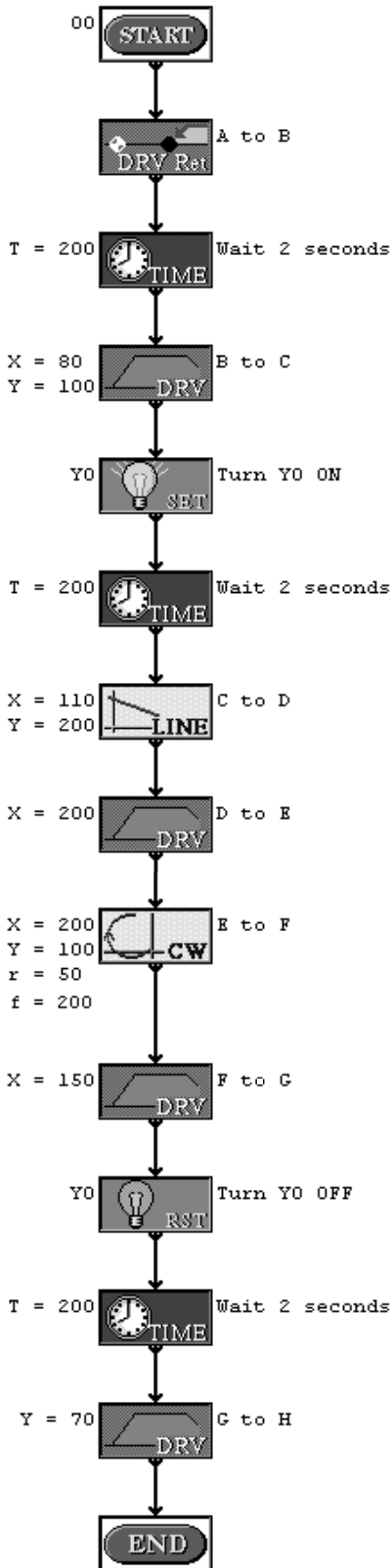

Many programs can be stored in a GM unit at one time. This example uses program number 0.

This command is to move from the start point, to the electrical zero point

Here the program waits for 2 seconds, using a 10ms timer.

This command indicates the rapid command to position C.

Here Y0 is turned on, to mimic the use of an end effector tool.

This timer allows a tool to be activated, or an operation executed.

This command is the start of a continuous steady path, first using linear interpolation to position D

To position E, only the X axis need move.

For a smooth arc, circular interpolation is used. This example shows the start and end positions (F), as well as the radius and a speed f.

To position G, only the X axis need move.

Here Y0 is turned off, to mimic the the end of the end effector use.

Again a timer related to the operation above.

This command rapidly moves only the Y axis a short distance to position H.

The end of the program, and a wait for the next start command.

5.2.2 Writing the program

Using FX-PCS-VPS\Win-E, re-create the flow chart program shown in section 5.2.1.

If assistance is required in the operation of the software, please refer to the Software manual JY992D86801.

When opening a new file in VPS, choose 'FX(2N)/E-20GM with simultaneous 2 axis'

The example program is designed to utilize the real time monitor function of VPS software. If a mechanical plotter is being used substitute the 'DRV Ret' command for a 'DRVZ', return to origin command. Be sure to set up the plotter in accordance with the instructions and guidelines applicable to and supplied with your specific plotter.

Along with the Flow chart, create a monitoring window similar to the one shown below.

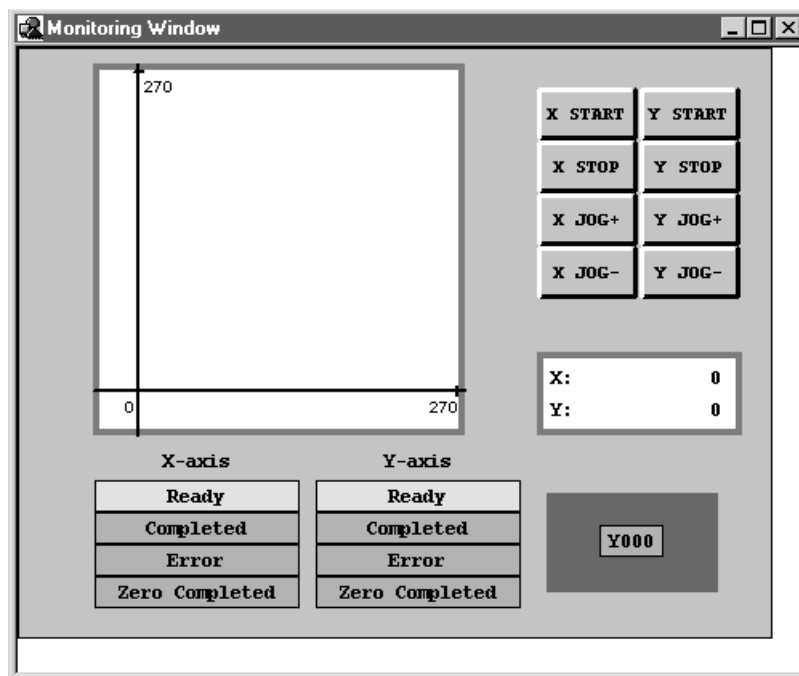

All of the items on the monitoring window can be found under the insert tab on the main menu at the top of the screen.

Items inserted include:

Current Position

Plotting (double click on plot area to change the scale)

Device Status (Y0)

Manual Operation (Start, Stop, Jog -, Jog +, for both X and Y axes, each inserted separately)

FX-GM Status

Plus, a rectangle from the drawing tool bar, to highlight the Y0 indicator.

5.2.3 Parameters

In addition to the preparation of a positioning program, diversified parameters should be set in the FX2N-20GM.

In this example, only a few parameters need be set. If a plotting table is used, the parameters should be set in accordance with its mechanism. These will depend upon the specific plotter type, and should be found in the documentation provided with the plotter.

Below are the four positioning parameter windows from VPS, copy these settings into your program. *The values for both the X and Y axes are the same for all parameters.*

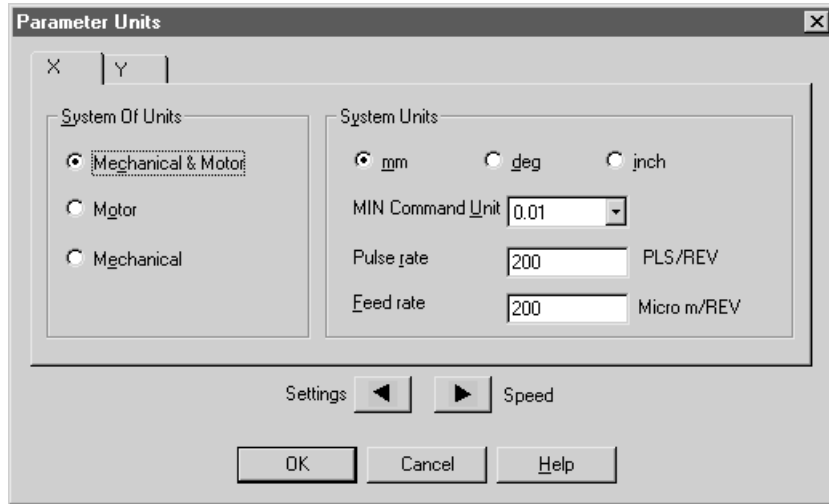

The system of units we will be using is both mechanical and motor, so that the position can be controlled in mm, deg, 1/10 inch etc. while the speed can be controlled by the number of pulses. The system units should be set to 'mm', and all other options left as default.

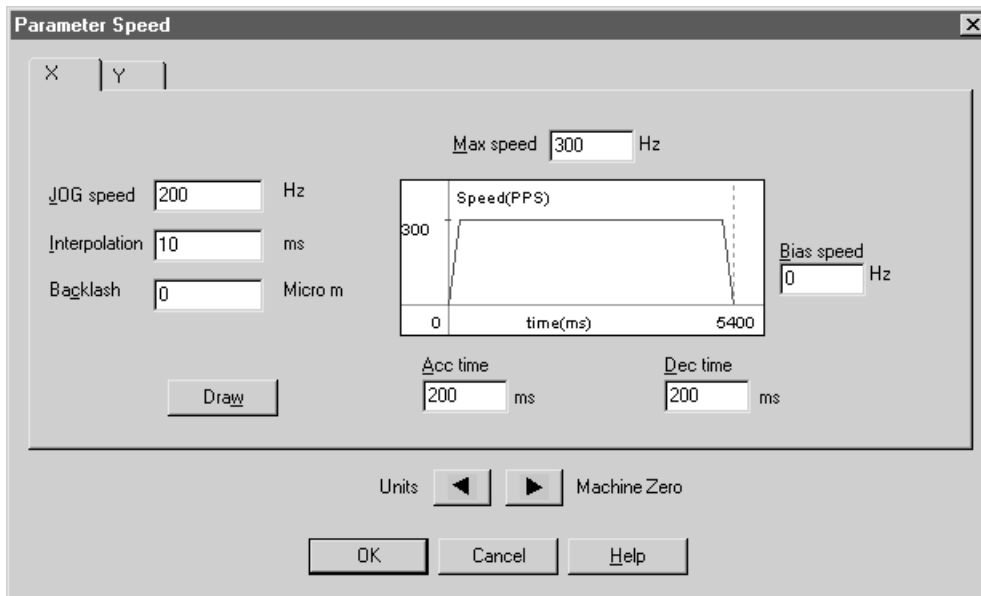

So that we can follow the path created by the FX2N-20GM, the Max speed should be set quite low. Intern both the JOG speed and the Interpolation value must be reduced. In practice, it is impossible to have the JOG speed faster than the Max speed setting.

Remember to change the setting for the Y axis also.

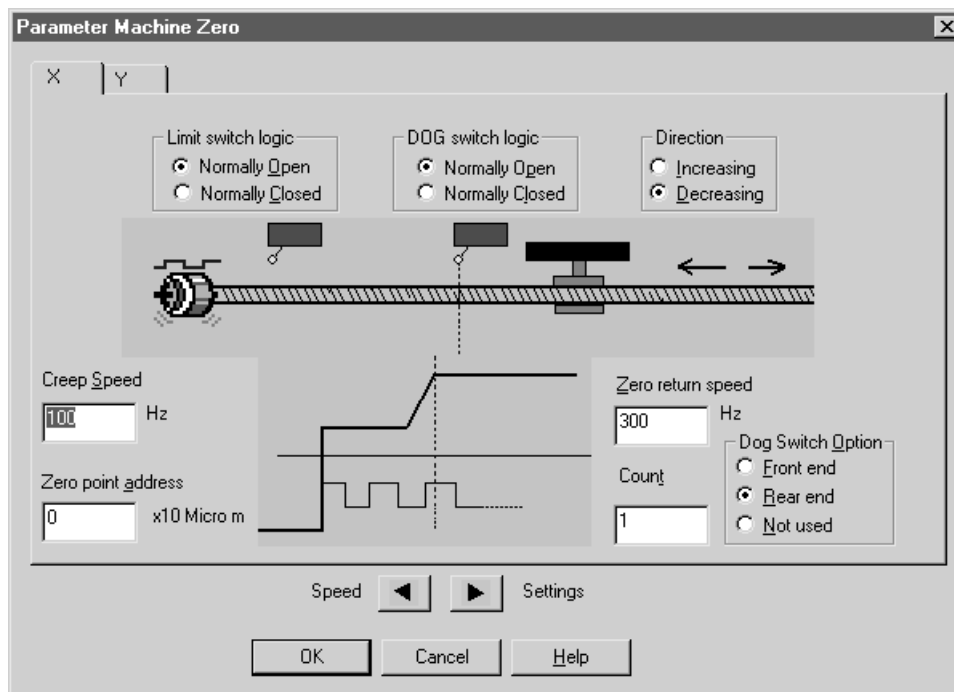

As we will not be connecting any mechanical hardware to the FX2N-20GM, the limit switch and DOG switch settings do not require setting. We do however need to reduce the Creep speed and the Zero return speed.

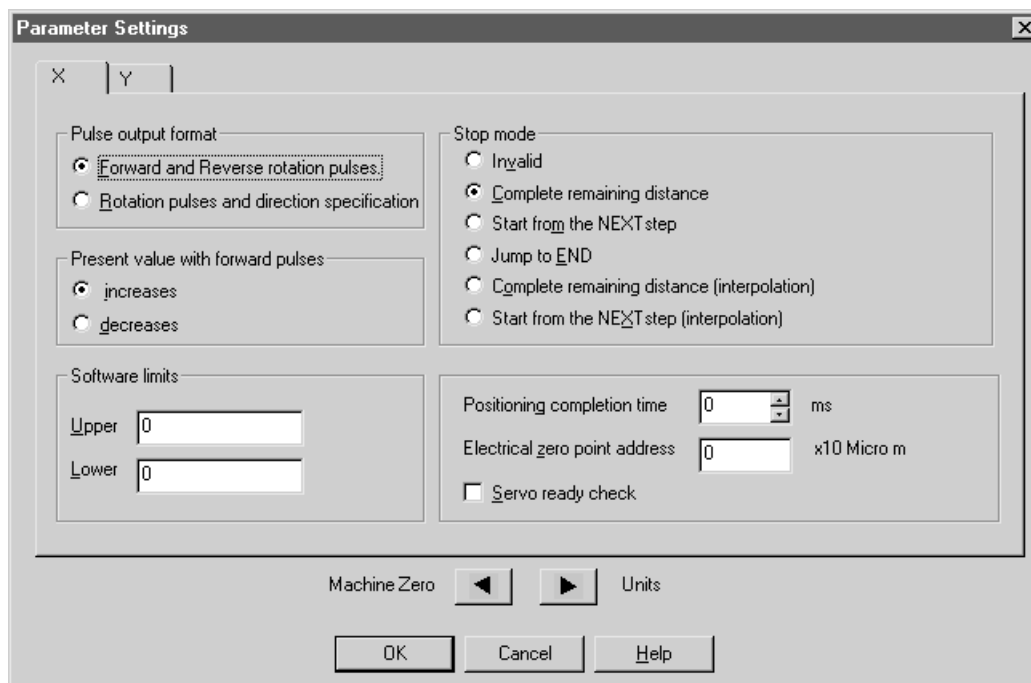

All of the parameter settings on this screen window can be left as their default values, they are already optimized for our program.

If a plotter table is being used, all of the above parameters will need to be checked before power ON, or operation.

5.2.4 Operation

Now that your program has been written, check the communication cables between the FX2N-20GM and PC, then download your program to the FX2N-20GM. Make sure that the GM unit is in 'MANU' mode before download, or it will be impossible to communicate.

In VPS, start the Monitor mode by clicking the Monitor icon on the tool bar, shown below.



The Monitor mode screen will appear. Here, the flow icon menu and program map have been removed. Three windows are displayed;

Monitoring window: This is the window you created, and will use to control the FX2N-20GM and view the resulting locus.

Sub-task - Monitor mode: This window is not needed as we do not use any sub routines in our programs, it can be minimized to create more space on the screen.

X-axis and Y-axis - Monitor mode - At first this window will be empty, but as soon as you start your program, the flow chart will appear, and scroll through, keeping the live instruction highlighted in red.

After minimizing the Sub-task monitor window, resize the Monitoring window and then the X-axis and Y-axis window.

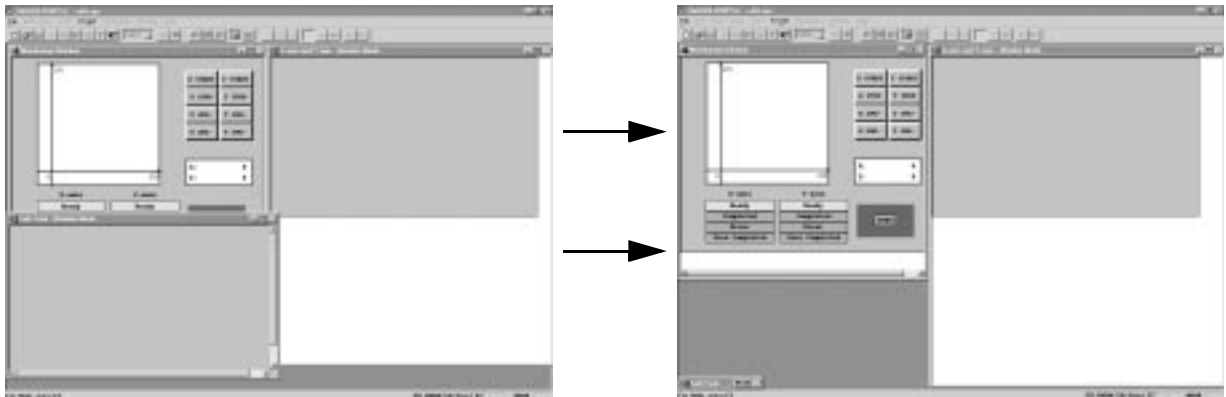

Now you are ready to begin.

Firstly set the start point, this can be done by either using the X and Y axis JOG buttons, or by double clicking on the current position display.

Double clicking the current position display brings up this window;

For X, replace 0 with 50, and click on the 'Write to FX-GM' button.

For Y, replace 0 with 125, and click on the 'Write to FX-GM' button.

As you write that data to the GM, you will see a red line being drawn on the plot in the Monitoring window. This shows the current position.

We want a clean plot area to begin with, so double click on the plotting area, and click on the clear button.

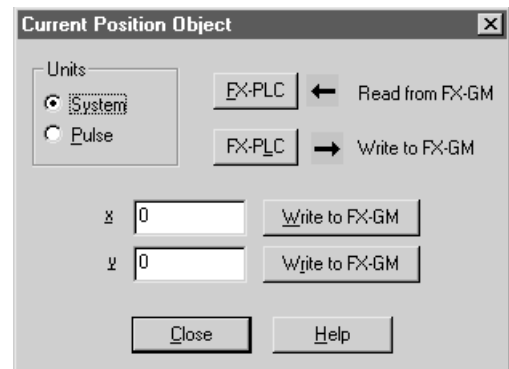

The next step, it to switch the FX2N-20GM to 'AUTO' mode, so that the program can be executed.

Finally, on the Monitor screen click on either the X or Y axis start buttons. It does not matter which one, as both will start the program. Sit back and see what you have produced.

Your screen should look similar to the one shown below, the plot should be identical.

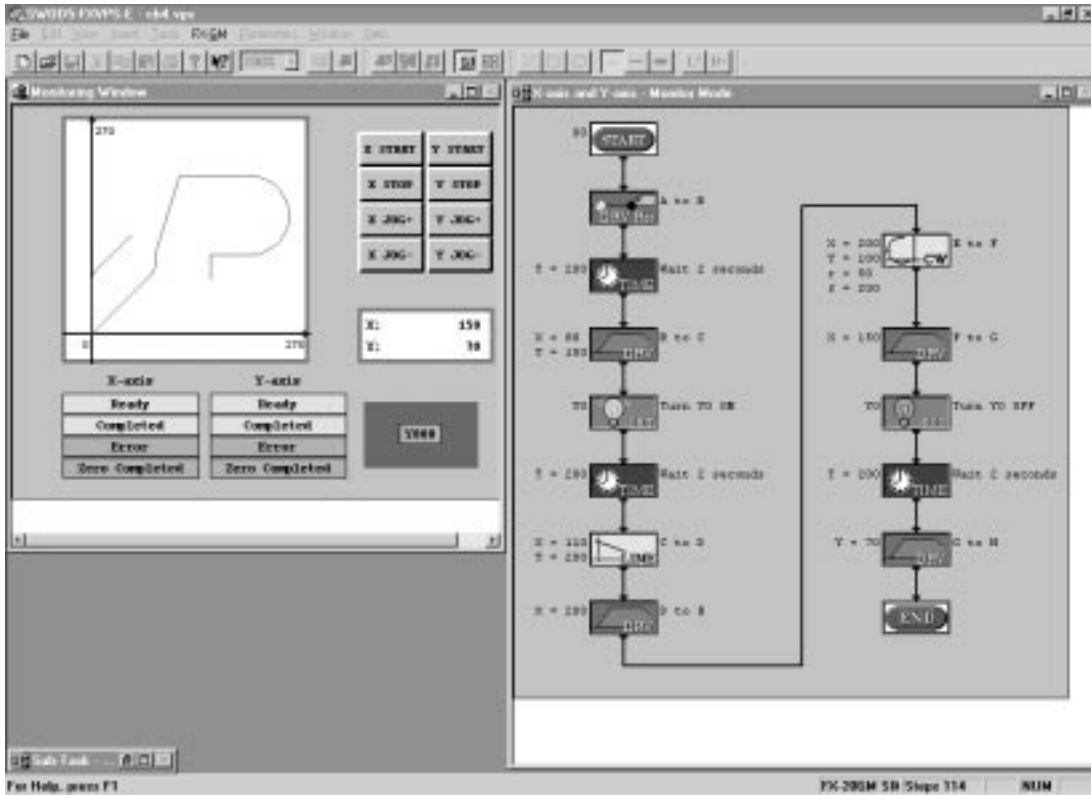

To run the program again, set a new start position (or let it start from where it is), clean the plot area, and press start.

If your plot does not look the same as the one above, check your program against the one in section 5.2.1.

If it does, now is the time to experiment some more. Try a new program, perhaps include sub-tasks and multiple flow charts. Only a sample of the functionality available in VPS has been used in this example program, try using some of the other programming aspects.

1	The World of Positioning Control
2	Positioning by AC Servo System
3	Components of Positioning Control and Their Roles
4	Advanced Positioning
5	Actual Positioning
6	Product Line up
A	Appendix A: Tentative Selection of Motor Capacity

6. Product Line up

We are offering diversified position controllers, servo amplifiers and servo motors. You can select desired units in accordance with your system and application.

For the details, refer to the catalog of each product.

6.1 Position controller

1) Outline of position controller models

In the position controller, the positioning function is built in or extended. For some position controllers, an PLC executes positioning programs. Other position controllers execute programs using their unique positioning language without regard to any PLC.

	Model name/unit name	Positioning language	Outline	
FX Series	FX1S/FX1N Series PLC	FX sequence language	Pulse output type for independent 2 axes Through application instructions in the PLC main unit, absolute position detection, return to mechanical zero point and one-speed constant positioning are available.	
	1-axis position controller FX-10GM FX2N-10GM	Dedicated language	Pulse output type for 1 axis	Easy sequence function is provided. Bus connection to FX Series PLC is available. (Position controller can be used independently also.)
	2-axis position controller FX-20GM FX2N-20GM		Pulse output type for 2 axes Independent 2 axes or simultaneous 2 axes (linear interpolation, circular interpolation)	
	2-axis position controller E-20GM		Easy sequence function is provided. (Position controller can be used independently also.)	
	1-axis pulse output block FX2N-1PG	FX sequence language	Pulse output block for FX2N Series PLC Used as an extension block	
A Series	1- to 3-axis position controller AD75P1 to AD75P3	A sequence language + Positioning data	Pulse output type for 1 to 3 axes Simultaneous 1 to 3 axes, independent 1 to 3 axes, 2-axis linear interpolation, 2-axis circular interpolation	
	1- to 3-axis position controller AD75M1 to AD75M3		SSC net connection type for 1 to 3 axes Simultaneous 1 to 3 axes, independent 1 to 3 axes, 2-axis linear interpolation, 2-axis circular interpolation	
Q Series	1- to 4-axis position controller QD75P1 to QD75P4	Q sequence language + Positioning data	Pulse output type for 1 to 4 axes (open collector output) Simultaneous 1 to 4 axes, independent 1 to 4 axes, 2 to 4-axis linear interpolation, 2-axis circular interpolation	
	1- to 4-axis position controller QD75D1 to QD75D4		Pulse output type for 1 to 4 axes (differential output) Simultaneous 1 to 4 axes, independent 1 to 4 axes, 2 to 4-axis linear interpolation, 2-axis circular interpolation	

	Model name/ unit name	Positioning language	Outline
Motion controller	A171SH A172SH A173SH	Language dedicated to servo system [4-, 32-axis independent control, 2- to 4-axis linear interpolation control, 2-axis circular interpolation control, speed control, equal speed control, position follow-up control] NC language [Control using G codes]	A171UHCPU (512 I/O points): 4-axis control A172SHCPU (512 I/O points): 8-axis control A173UHCPU (2,048 I/O points): 32-axis control Servo amplifier (0.05 to 55 kw are dedicated to SSC net connection.)
	A273UH	Dedicated robot [Three-dimensional linear/circular interpolation control] Mechanical support language [Synchronous operation control]	A3UCPU (2,048 I/O points): 32-axis control Servo amplifier (0.05 to 0.6 kw allow built-in type also.) (0.05 to 55 kw are dedicated to SSC net connection.)

Mechanical support language in motion controller

A new world of synchronous mechanism is open.

Programming in virtual world

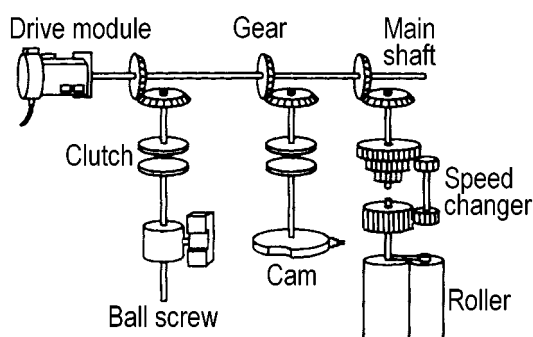

By simply connecting and laying out a transmission module and an output module to a virtual main shaft on the screen, while regarding diversified synchronous mechanism as software mechanical modules, you can easily program a synchronous system.

1) When and which position controller?

In addition to the PLC series, take into account the following contents to determine the position controller to be used.

a) Determine the position controller to be used in accordance with the number of controlled axes (motors).

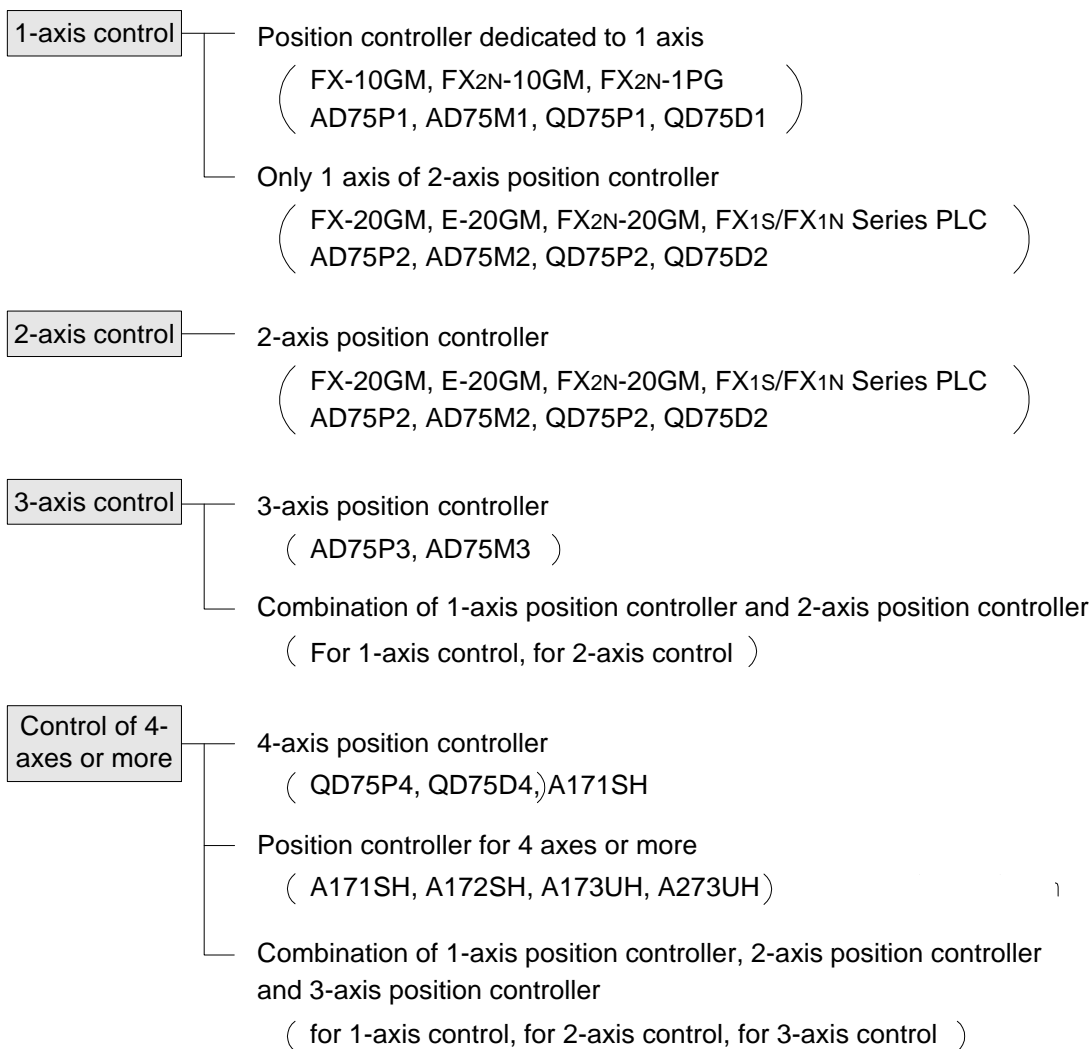

- b) Determine the position controller to be used in accordance with the output pulse frequency.
 However, the pulse frequency actually used inside the servo amplifier can be increased by electronic gearing.

- 100kp/sec — When the required command pulse is 100 kpps or less
 (FX2N-1PG, FX1S/FX1N Series PLC)
- 200kp/sec — When the required command pulse is 200 kpps or less
 (FX-10GM, FX-20GM, E-20GM, FX2N-10GM, FX2N-20GM)
 AD75P□, QD75P□
- 400kp/sec — When the required command pulse is 400 kpps or less
 (AD75P□, QD75P□)
- 1Mkp/sec — When the required command pulse is 1 Mpps or less
 (AD75M□, A171SH, A172SH, A173UH, A273UH)

- c) Determine the position controller to be used in accordance with handling of the feedback pulse.

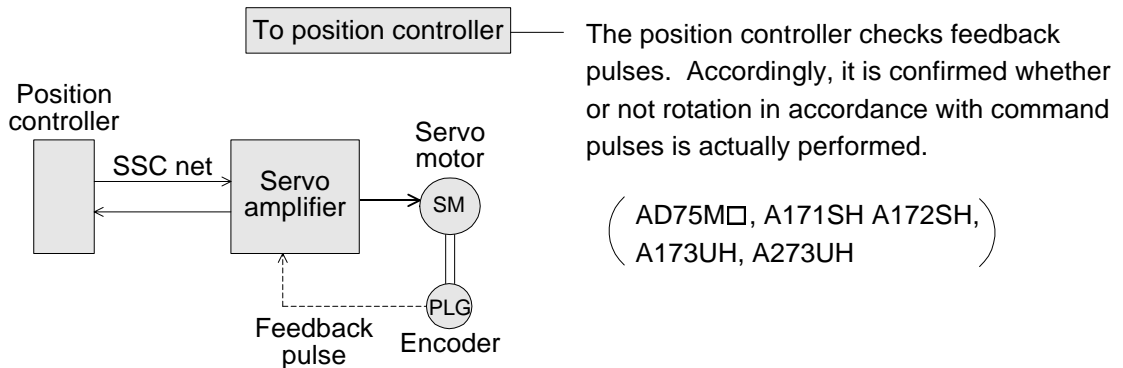
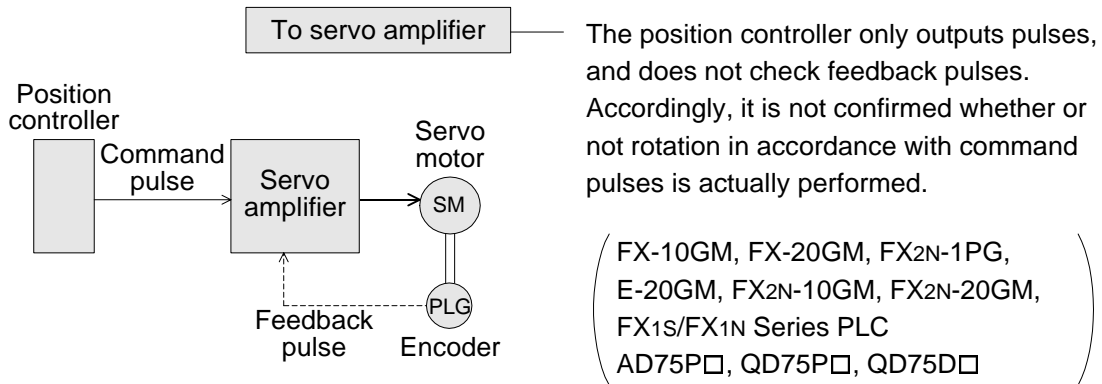

6.2 Servo amplifier

1) Outline of servo amplifier models

Model name	Outline
MR-J2-Jr Series	<ul style="list-style-type: none"> • DC 24V • Size is extremely small, and capacity is small. • Applicable to 10 to 30 w. • Used for semiconductor manufacturing unit and small robots. • Setup software by personal computer is available.
MR-C Series	<ul style="list-style-type: none"> • General-purpose type optimal to use instead of stepping motor (dedicated to position control). • Size is extremely small. • Applicable to 30 to 400 w. • Real-time auto tuning eliminates adjustment in setup. • Inertia is extremely low. • Speed can increase at constant torque without step out until high speed area, and operation is smooth even at low speed. • Setup software by personal computer is available.
MR-J2/J2S Series	<ul style="list-style-type: none"> • General-purpose type in compact body easy to use. • Applicable to 50 w to 7 kw. 100 VAC input type is offered as a series. • Real-time auto tuning eliminates adjustment in setup. • Convenient test run function and diagnosis function are provided. • Applicable to low noise operation. • Setup software by personal computer is available.
MR-H Series	<ul style="list-style-type: none"> • General-purpose type of high performance and high response. • Applicable to 50 w to 55 kw. • Real-time auto tuning eliminates adjustment in setup. • Applicable to low noise operation. • Interactive parameters facilitate maintenance. • Setup software by personal computer is available.
MR-H-ACN Series	<ul style="list-style-type: none"> • 1-axis positioning function is built in. • Applicable to 50 w to 55 kw. • Frequent operation of high precision is available. • Real-time auto tuning eliminates adjustment in setup. • Applicable to low noise operation, absolute value and diversified ways of return to zero point.

2) When and which servo amplifier?

In addition to the series, take into account the following contents to determine the servo amplifier to be used.

a) Determine the servo amplifier to be used in accordance with the rated output of the servo motor.

400w or less — Extremely small capacity type servo amplifier
(MR-J2-Jr, MR-C)

7kw or less — Small capacity type servo amplifier
(MR-J2□)

55kw or less — Medium or large capacity type servo amplifier
(MR-H-□)

b) Determine the servo amplifier to be used in accordance with the servo motor model.

When the servo motor is determined in accordance with the purpose of use, the rated torque and the inertia moment, select a connectable servo amplifier while taking into account the responsibility and the extensibility.

6.3 Servo motor

Servo motors are classified into series in accordance with the application, the outside dimensions and the motor inertia moment. In each series, models of different output capacity are lined up.

Motor model name (encoder resolution)	Rated rotation speed (r/min.)	Rated output capacity	Features		Application
HC-AQ (8192P/rev)	3000	10W to 30W	Extremely small size, small capacity and 24 VDC specification (compatible with speed reducer). Optimal to application for small capacity using servo amplifier MR-J2-JR.		<ul style="list-style-type: none"> • Small slider • Small actuator • Cylinder
HC-PQ (4000P/rev)	3000	30W to 400W	Extremely low inertia and small capacity (compatible with speed reducer). Optimal to use instead of stepping motor.		<ul style="list-style-type: none"> • Extremely small robot • Tip of robot • In-circuit tester
HC-KF (8192P/rev) HC-KFS (131072P/rev)	3000	50W to 400W	Low inertia and small capacity (compatible with speed reducer). Optimal to machine with load inertia moment fluctuation and machine of low rigidity such as belt drive type because motor inertia moment is large.		<ul style="list-style-type: none"> • Belt drive, robot • Mounter, sawing machine • X-Y table, food machine
HC-MF (8192P/rev) HC-MFS (131072P/rev)	3000	50W to 750W	Extremely small inertia and small capacity (compatible with speed reducer). Optimal to frequent operation directly connected to ball screw because motor inertia moment is small.		<ul style="list-style-type: none"> • Inserter, mounter, bonder • Drilling unit for PCB • Label printer, knitting machine • Extremely small robot
HA-FF (8192P/rev)	3000	50W to 600W	Small inertia and small capacity (compatible with speed reducer). Applicable to wide range of applications because control is stable from low speed to high speed.		<ul style="list-style-type: none"> • LCD/wafer carrier unit • Food machine, printer • Small robot, X-Y table
HC-SF (16384P/rev) HC-SFS (131072P/rev)	3000	500W to 3.5kW	For high speed	Medium inertia and medium capacity. Selectable in accordance with motor rated rotation speed from low speed to high speed.	<ul style="list-style-type: none"> • Winder, tension unit • Carrier unit, dedicated machine • Robot, testing machine • X-Y table, turret • Loader, unloader • Winder, tension unit
	2000	500W to 7kW	For speed reducer (compatible with speed reducer)		
	1000	850W to 3kW	For high torque		

Motor model name (encoder resolution)	Rated rotation speed (r/min.)	Rated output capacity	Features		Application
HC-RF (16384P/rev) HC-RFS (131072P/rev)	3000	1kW to 5kW	Low inertia and medium capacity (compatible with speed reducer). Optimal to frequent operation directly connected to ball screw because motor inertia moment is low.		<ul style="list-style-type: none"> • Frequent carrier unit • Roll feeder • Loader, unloader
HC-UF (16384P/rev) HC-UFS (131072P/rev)	3000	100W to 750W	Small capacity	Flat type Optimal to application in which mounting is restricted.	<ul style="list-style-type: none"> • Robot • Food processor • Carrier unit • Winder, tension unit
	2000	750W to 5kW	Medium capacity		
HA-LH (16384P/rev)	2000	11kW to 22kW	Low inertia and large capacity. Suitable to frequent positioning because motor inertia is low.		<ul style="list-style-type: none"> • Press feeder, injection molding unit • Semiconductor manufacturing unit, carrier line • Press transfer unit • Lifter, automatic warehouse
HA-LF (16384P/rev)	2000	30kW to 55kW	Large capacity and 400 VAC specification. Suitable to positioning requiring large force because motor capacity is large.		<ul style="list-style-type: none"> • Injection molding unit • Semiconductor manufacturing unit • Large carrier unit

*3 The model name "HC-□□S" is compatible with the servo amplifier MR-J2S.

1	The World of Positioning Control
2	Positioning by AC Servo System
3	Components of Positioning Control and Their Roles
4	Advanced Positioning
5	Actual Positioning
6	Product Line up
A	Appendix A: Tentative Selection of Motor Capacity

Appendix A:

A-1: Tentative Selection of Motor Capacity

Temporarily select the motor capacity at first while taking into account the following two points, and determine the model.

- The rated torque of the motor should be larger than the effective torque.

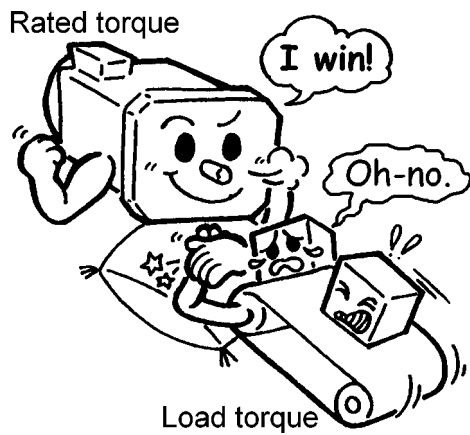

- The load inertia moment should not exceed approximately 10 times of the inertia moment of the motor itself.

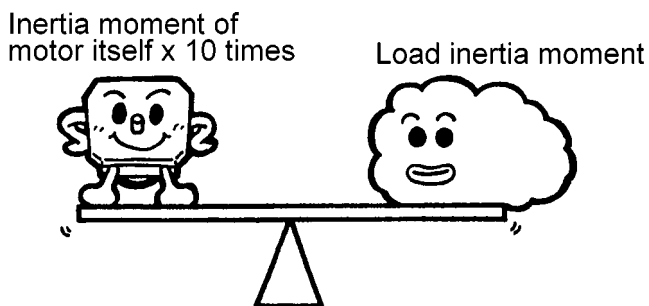

A-1-1: Motor effective torque

When the motor effective torque obtained by the calculation below does not exceed the rated torque (100%) of the servo motor specifications, it is suitable.

If the obtained effective torque exceeds 100%, increase the motor capacity and perform the calculation again.

$$\text{Effective torque (Trms)} = \sqrt{\frac{(\text{Torque during acceleration})^2 \times \text{Acceleration time} + (\text{Torque during constant speed})^2 \times \text{Constant speed time} + (\text{Torque during deceleration})^2 \times \text{Deceleration time}}{\text{Cycle time (including rest time)}}}$$

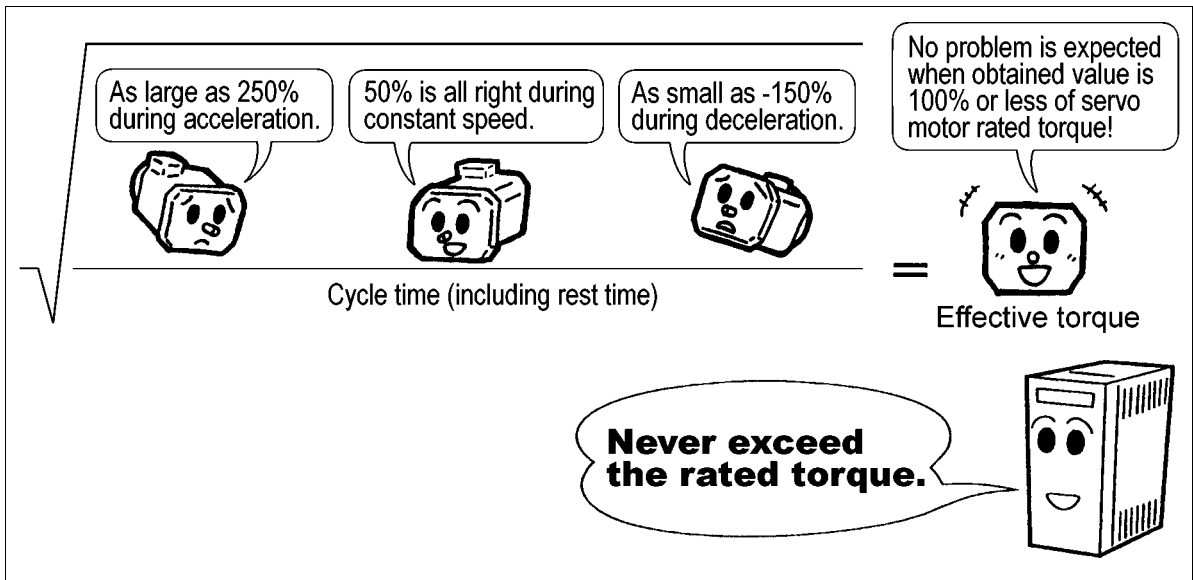

In the effective torque calculation equation, the torque during acceleration, constant speed, deceleration, the cycle time and the machine load are as follows.

- 1) The torque during acceleration is the torque required to reach the constant speed after startup and acceleration.

$$\text{Torque during acceleration (Tma)} = \text{Torque to accelerate load inertia moment (Ta)} + \text{Load torque (TL)}$$

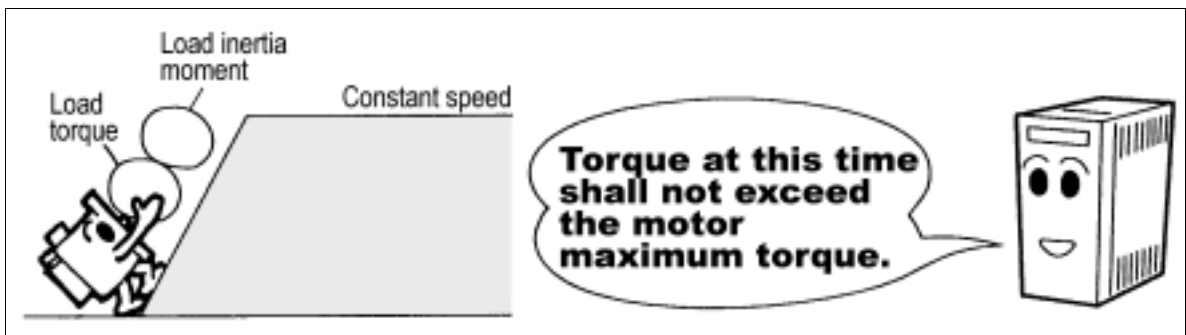

- 2) The torque during constant speed is the torque required to move the load at the constant speed.

$$\boxed{\text{Motor torque during constant speed}} = \boxed{\text{Load torque}}$$

(TML) (TL)

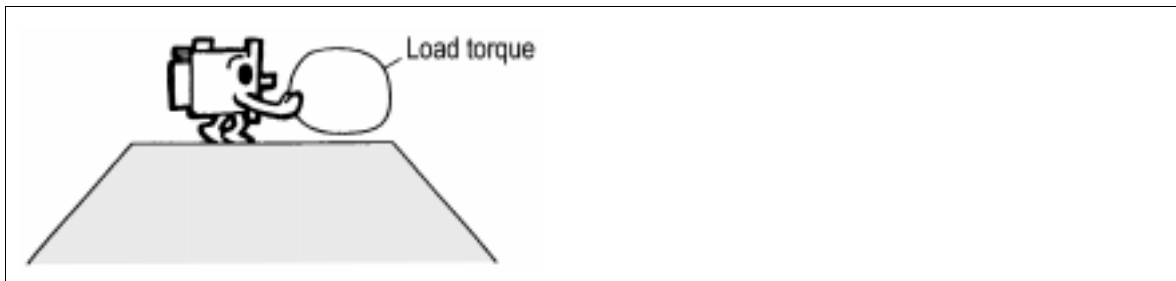

- 3) The torque during deceleration is the torque required for deceleration and stop.

$$\boxed{\text{Torque during deceleration}} = \boxed{\text{Torque to decelerate load inertia moment}} + \boxed{\text{Load torque}}$$

(TMD) (-Ta) (TL)

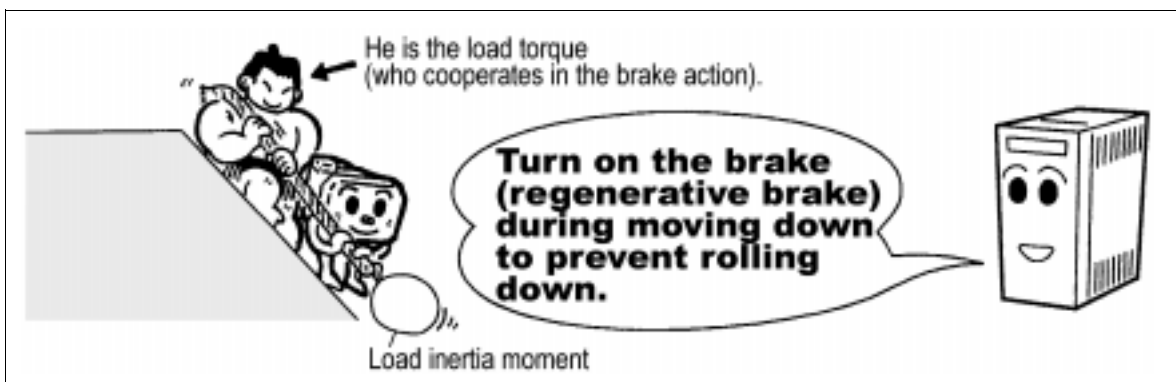

- 4) How to obtain the cycle time
 The representative machine operation pattern consists of acceleration, constant speed, deceleration and rest.
 The cycle time indicates the total time required for these actions.

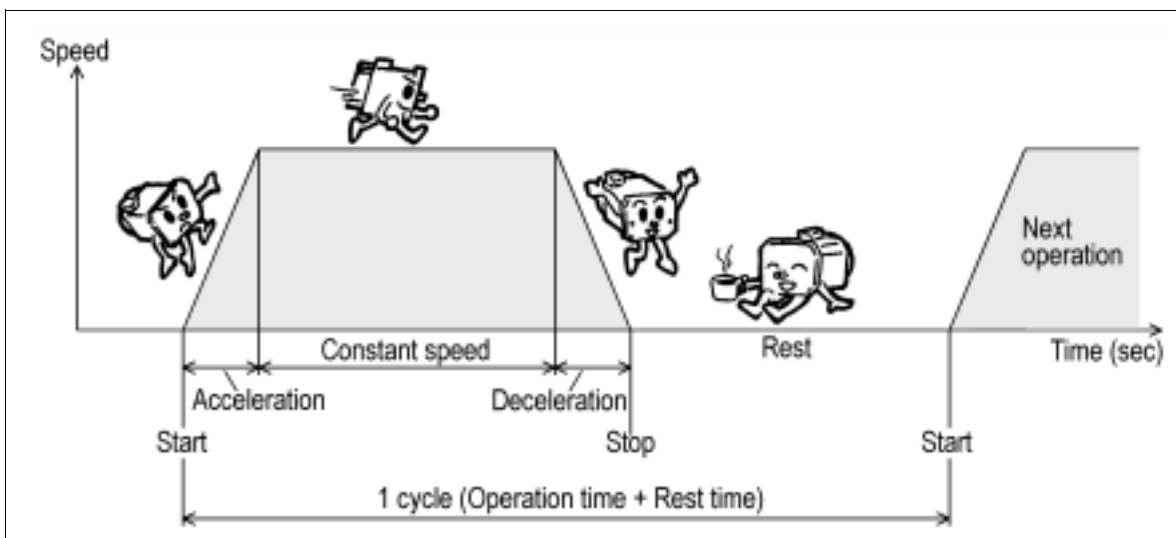

5) Machine load torque (TL)

The rotation force required to move or cut an object is called load torque.

During operation at constant speed, the motor is outputting the torque balancing this load torque.

- The calculation equation to obtain the load torque varies depending on the motion type (horizontal, rotation or vertical).
- In the case of rotation, the load torque is calculated based on the product of the rolling resistance coefficient of the bearing (ball bearing, for example) and the load applied in the radius direction of the bearing.

A-1-2: Load inertia moment

Difficulty to move a stationary object or difficulty to stop a moving object is called inertia moment. As the inertia moment is larger, the load is more difficult to move and stop. In the servo motor, the inertia moment gives considerable effect especially at the time of start and stop.

Accordingly, calculate the load inertia moment, then select a servo motor so that the obtained load inertia moment does not exceed 10 times of the inertia moment of the servo motor itself.

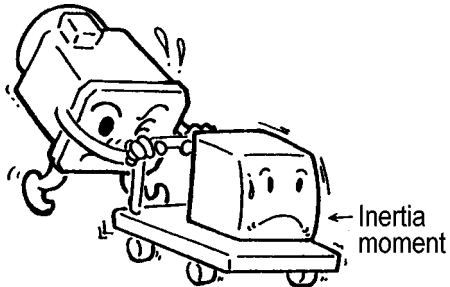

Start

The motor starts to move an object while overcoming the inertia moment.

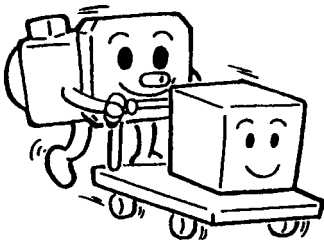

Operation at constant speed

The inertia moment gives no effect.

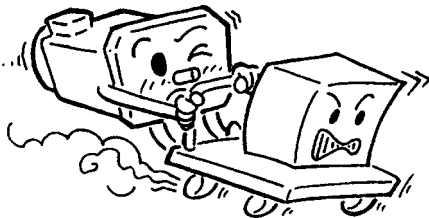

Stop (deceleration → stop)

The motor stops an object while overcoming the inertia moment.

Under no circumstances will Mitsubishi Electric be liable or responsible for any consequential damage that may arise as a result of the installation, use and/or programming of the products associated with this manual.

All examples and diagrams shown in this manual are intended as an aid to understanding the text, not to guarantee operation. Mitsubishi Electric will accept no responsibility for actual use of the product based on these illustrative examples.

Owing to the very great variety of possible applications, users must satisfy themselves as to the suitability of each specific application.



HEAD OFFICE: MITSUBISHI DENKI BLDG MARUNOUCHI TOKYO 100-8310 TELEX: J24532 CABLE MELCO TOKYO
HIMEJI WORKS: 840, CHIYODA CHO, HIMEJI, JAPAN

JY992D89901A
(MEE0007)

Effective July. 2000
Specifications are subject
to change without notice.