

FATEC

Mitsubishi Programmable Controllers Training Manual Redundant System Basic Course

SAFETY PRECAUTIONS

(Read these precautions before exercise.)

When designing the system, always read the relevant manuals and give sufficient consideration to safety.

During the exercise, pay full attention to the following points and handle the product correctly.

[EXERCISE PRECAUTIONS]

WARNING

- Do not touch the terminals while the power is on to prevent electric shock.
 - Before opening the safety cover, turn off the power or ensure the safety.
-

CAUTION

- Follow the instructor's direction during the exercise.
 - Do not remove the module of the demonstration machine or change wirings without permission.
Doing so may cause failures, malfunctions, personal injuries and/or a fire.
 - Turn off the power before mounting or removing the module.
Failure to do so may result in malfunctions of the module or electric shock.
 - When the demonstration machine emits abnormal odor/sound, press the "Power switch" or "Emergency switch" to turn off.
 - When a problem occurs, notify the instructor as soon as possible.
-

REVISIONS

*The manual number is given on the bottom left of the back cover.

Revision date	*Manual number	Description
September 2020	SH(NA)-082368ENG-A	First edition

This manual confers no industrial property rights or any rights of any other kind, nor does it confer any patent licenses. Mitsubishi Electric Corporation cannot be held responsible for any problems involving industrial property rights which may occur as a result of using the contents noted in this manual.

© 2020 MITSUBISHI ELECTRIC CORPORATION

TRADEMARKS

Ethernet is a registered trademark of Fuji Xerox Co., Ltd. in Japan.

Microsoft and Windows are either registered trademarks or trademarks of Microsoft Corporation in the United States and/or other countries.

The company names, system names and product names mentioned in this manual are either registered trademarks or trademarks of their respective companies.

In some cases, trademark symbols such as [™] or [®] are not specified in this manual.

CONTENTS

SAFETY PRECAUTIONS	1
REVISIONS	2
TRADEMARKS	3
INTRODUCTION	7
RELEVANT MANUALS	7
CHAPTER 1 REDUNDANT SYSTEM	9
1.1 Features	9
1.2 Redundant System	9
Redundant configuration of basic systems	10
Redundant configuration of power supply modules	10
Redundant configuration of networks	11
1.3 Engineering Tool	15
GX Works3	15
RnPCPU	18
PX Developer monitor tool	19
1.4 Configuration Devices	23
MELSEC iQ-R series	23
MELSEC-Q series	26
CHAPTER 2 STARTUP OF DEMONSTRATION MACHINE	29
2.1 Configuration	29
Hardware configuration	29
System configuration	31
2.2 Wiring	32
Ethernet	32
CC-Link IE Controller Network	33
CC-Link IE Field Network	34
Redundant function module	35
2.3 Start-up Procedure	36
Overview	36
2.4 Operation	38
Screen transition	38
Basic operations	39
Details of each screen	41
CHAPTER 3 REDUNDANT SYSTEM OVERVIEW	51
3.1 Basic Concept and Functions of a Redundant System	51
Concept of 'systems' in a redundant system	51
Scan configurations	52
System switching between control system and standby system	53
Operation modes of the Process CPU	53
Operation modes of a redundant system	54
System determination	56
State transition of a redundant system	60
System consistency check	61
Memory copy from control system to standby system	65
Program execution in both systems	73

3.2	Network Overview	77
	Redundant system function of Ethernet	77
	Redundant system function of CC-Link IE Controller Network	79
	Redundant system function of CC-Link IE Field Network	83
3.3	Specifications	92
	Process CPU	92
	Redundant function module	96
	Performance specifications of Ethernet	97
	Performance specifications of CC-Link IE Controller Network	98
	Performance specifications of CC-Link IE Field Network	99
	Performance specifications of the remote head module	101
CHAPTER 4 NETWORK CONFIGURATION FOR REDUNDANT SYSTEMS		103
4.1	Powering on the System	107
4.2	Creating a Project (Master Station)	109
	Creating a new project	109
	Setting the system (system A or system B)	110
	Setting the module configuration	114
	Setting network parameters	118
4.3	Creating a Project (Slave Station)	131
	Creating a new project	131
	Setting the module configuration	132
	Setting network parameters	136
4.4	Converting the Projects	138
4.5	Writing the Projects	140
4.6	TCP/IP Settings on the Personal Computer	147
4.7	Checking Windows® Firewall	151
4.8	Checking the Operation	155
	Redundant system	155
	Ethernet network	157
	CC-Link IE Controller Network	160
	CC-Link IE Field Network	161
CHAPTER 5 SIGNAL INPUT/OUTPUT IN THE REDUNDANT SYSTEM		163
5.1	Setting Parameters	164
5.2	Programming	175
5.3	Converting the Project	184
5.4	Writing the Projects	184
5.5	Checking the Operation	185
	Redundant system	185
	Signal input/output	186
CHAPTER 6 MAINTENANCE AND INSPECTION OF A REDUNDANT SYSTEM		189
6.1	Module Replacement Procedure	189
	Replacing the CPU module	190
	Replacing the power supply module	192
	Replacing the redundant function module	192
	Replacing the I/O module	193
	Replacing the network module	193
	Replacing the remote head module	194

6.2	Online Module Change	195
	Overview	195
	Configuration devices	196
	Specifications	198
	Changing a module directly	202

CHAPTER 7 TROUBLESHOOTING **209**

7.1	Troubleshooting Procedure	209
7.2	Troubleshooting with LED Indicators	210
7.3	Troubleshooting Using the Engineering Tool	210
7.4	Clearing Errors in the CPU Module of the Standby System	213

APPENDIX **215**

Appendix 1	Functions	215
-------------------	------------------------	------------

INTRODUCTION

To help users acquire the knowledge required for configuring a process control system using the MELSEC iQ-R series process control, this manual describes the functions and specifications of hardware and software, and how to configure a redundant system.

RELEVANT MANUALS

Manual name [manual number]	Description	Available form
MELSEC iQ-R CPU Module User's Manual (Startup) [SH-081263ENG]	Specifications, procedures before operation, and troubleshooting of the CPU module	e-Manual PDF
MELSEC iQ-R CPU Module User's Manual (Application) [SH-081264ENG]	Memory, functions, devices, and parameters of the CPU module	e-Manual PDF
MELSEC iQ-R Ethernet/CC-Link IE User's Manual (Startup) [SH-081256ENG]	Specifications, procedures before operation, system configuration, wiring, and communication examples of Ethernet, CC-Link IE Controller Network, and CC-Link IE Field Network	e-Manual PDF
MELSEC iQ-R Ethernet User's Manual (Application) [SH-081257ENG]	Functions, parameter settings, programming, troubleshooting, I/O signals, and buffer memory of Ethernet	e-Manual PDF
MELSEC iQ-R CC-Link IE Controller Network User's Manual (Application) [SH-081258ENG]	Functions, parameter settings, troubleshooting, and buffer memory of CC-Link IE Controller Network	e-Manual PDF
MELSEC iQ-R CC-Link IE Field Network User's Manual (Application) [SH-081259ENG]	Functions, parameter settings, programming, troubleshooting, I/O signals, and buffer memory of CC-Link IE Field Network	e-Manual PDF
MELSEC iQ-R Programming Manual (Program Design) [SH-081265ENG]	Program specifications (ladder, ST, FBD/LD, and SFC programs)	e-Manual PDF
GX Works3 Operating Manual [SH-081215ENG]	System configuration, parameter settings, and online operations of GX Works3	e-Manual PDF
MELSEC iQ-R Programming Manual (CPU Module Instructions, Standard Functions/Function Blocks) [SH-081266ENG]	Instructions for the CPU module and standard functions/function blocks	e-Manual PDF
MELSEC iQ-R Programming Manual (Process Control Function Blocks/Instructions) [SH-081749ENG]	General process FBs, tag access FBs, tag FBs, and process control instructions designed for process control	e-Manual PDF
MELSEC iQ-R Programming Manual (Module Dedicated Instructions) [SH-081976ENG]	Dedicated instructions for the intelligent function modules	e-Manual PDF



e-Manual refers to the Mitsubishi Electric FA electronic book manuals that can be browsed using a dedicated tool.

e-Manual has the following features:

- Required information can be cross-searched in multiple manuals.
- Other manuals can be accessed from the links in the manual.
- The hardware specifications of each part can be found from the product figures.
- Pages that users often browse can be bookmarked.
- Sample programs can be copied to an engineering tool.

MEMO

1 REDUNDANT SYSTEM

1.1 Features

Multi-level redundancy using MELSEC iQ-R products, such as a redundant configuration with the control system CPU module and the standby system CPU module, a redundant configuration with two CC-Link IE Field Network lines, and a redundant configuration with two remote head modules being mounted on the same remote station, reduces the risk of single-point failures. In a redundant system, modules can be changed online without stopping the system operation. A redundant system can be applied to special systems requiring high reliability, such as dedicated systems.

1.2 Redundant System

A redundant system consists of two systems that have the same configuration (CPU module, power supply module, network module, and other modules). Even if an error occurs in one system, the other system takes over the control of the entire system.

I/O modules and intelligent function modules used in a redundant system are mounted to the intelligent device station (remote head module) on CC-Link IE Field Network.

A redundant configuration of power supply modules is available with redundant power supply base units and redundant power supply modules. (Redundant power supply system)

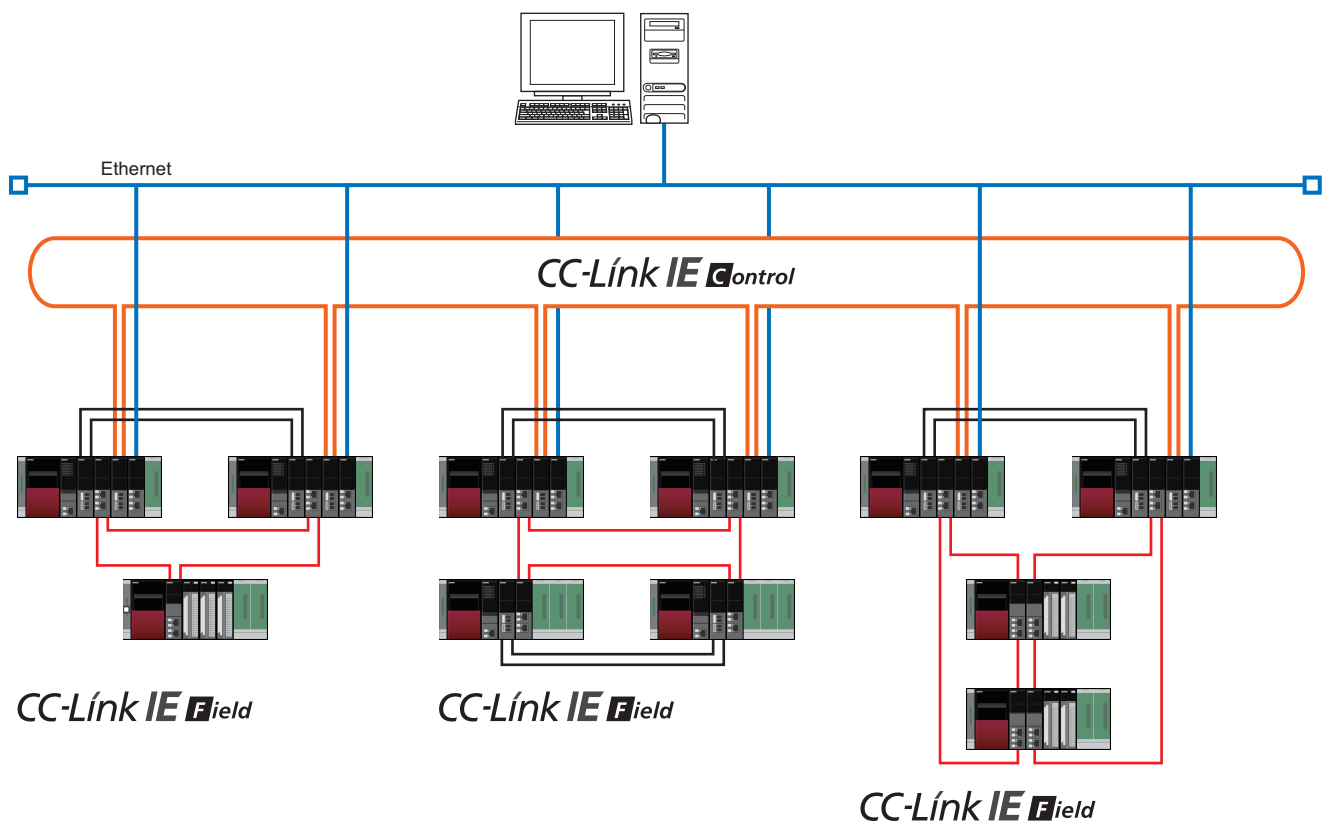

The redundant system is categorized into the following types.

- ☞ Page 10 Redundant configuration of basic systems
- ☞ Page 10 Redundant configuration of power supply modules
- ☞ Page 11 Redundant system for Ethernet
- ☞ Page 11 Redundant system for CC-Link IE Controller Network
- ☞ Page 12 Redundant system for CC-Link IE Field Network

Redundant configuration of basic systems

A basic system (CPU module, power supply module, network module, and other modules on a main base unit) can be redundant using a redundant function module and operating the Process CPU used in redundant mode. To configure a redundant system, configure two basic systems that have the same configuration including a redundant function module, and connect the redundant function modules in those two systems with tracking cables. Connecting the redundant function modules with two tracking cables also makes the cables to be redundant.

Mount modules of the same model on the same slot of each main base unit. The redundant function module can be mounted on any slot of the main base unit. (It does not need to be mounted on the right side of the CPU module.)

In the redundant system, the CPU module in one system executes programs and controls the entire redundant system. The other system will be in the standby state and does not perform control. The system that performs control is called 'control system' and the system in the standby state is called 'standby system'.

Data link is performed between redundant function modules connected with tracking cables. If an error occurs in the control system, the system is switched to the standby system and the standby system continues the operation.

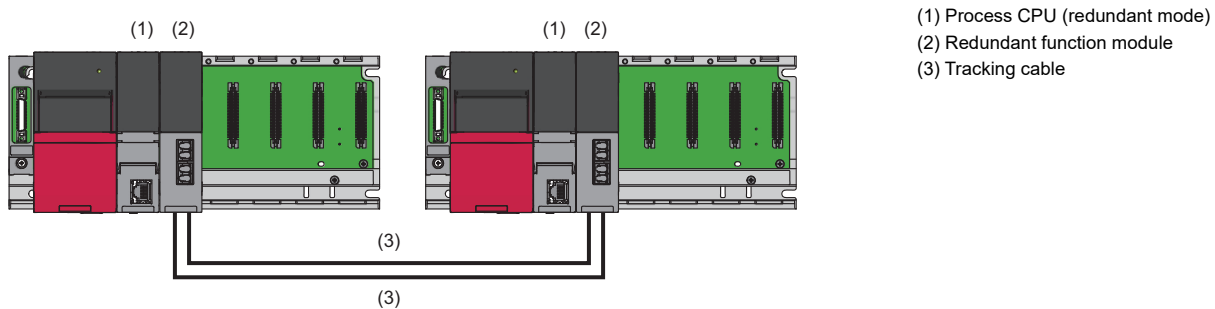

For details, refer to "WHEN USING THE PROCESS CPU (REDUNDANT MODE)" in the following.

MELSEC iQ-R CPU Module User's Manual (Application)

Redundant configuration of power supply modules

A redundant power supply module can be redundant by mounting two redundant power supply modules on a redundant power supply base unit. (Redundant power supply system)

Even if the power supply module fails or an error occurs in the power supply source connected to the power supply module in one system, system operation will be continued with the power supply module in the other system.

The power supply system error can be cleared or the failed power supply module can be replaced online. The power supply module can also be replaced online as preventive maintenance.

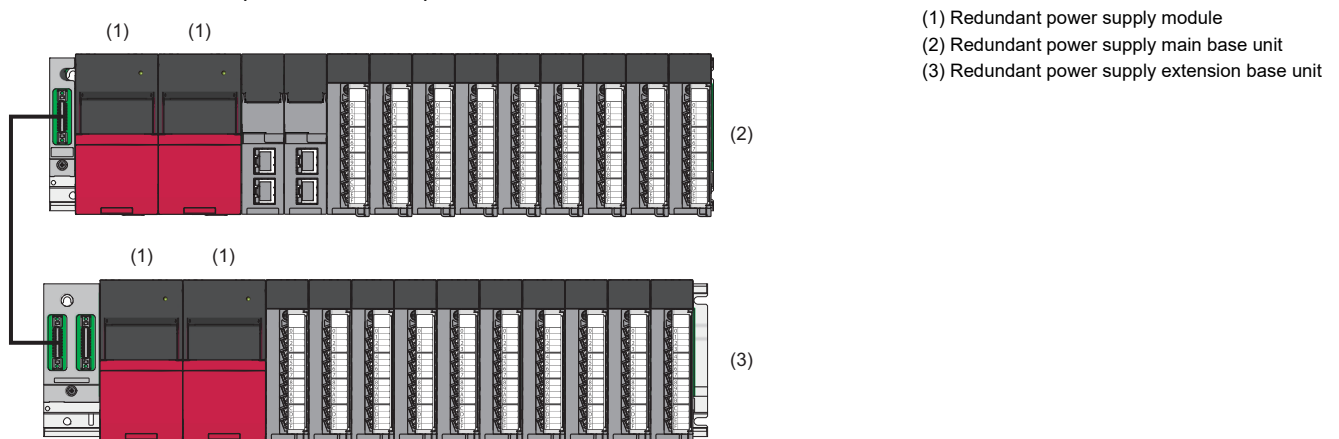

Redundant configuration of networks

Redundant system for Ethernet

Mounting an Ethernet interface module on the base unit of both the control system and the standby system enables data communications to be continued by the new control system when an error occurs in the control system.

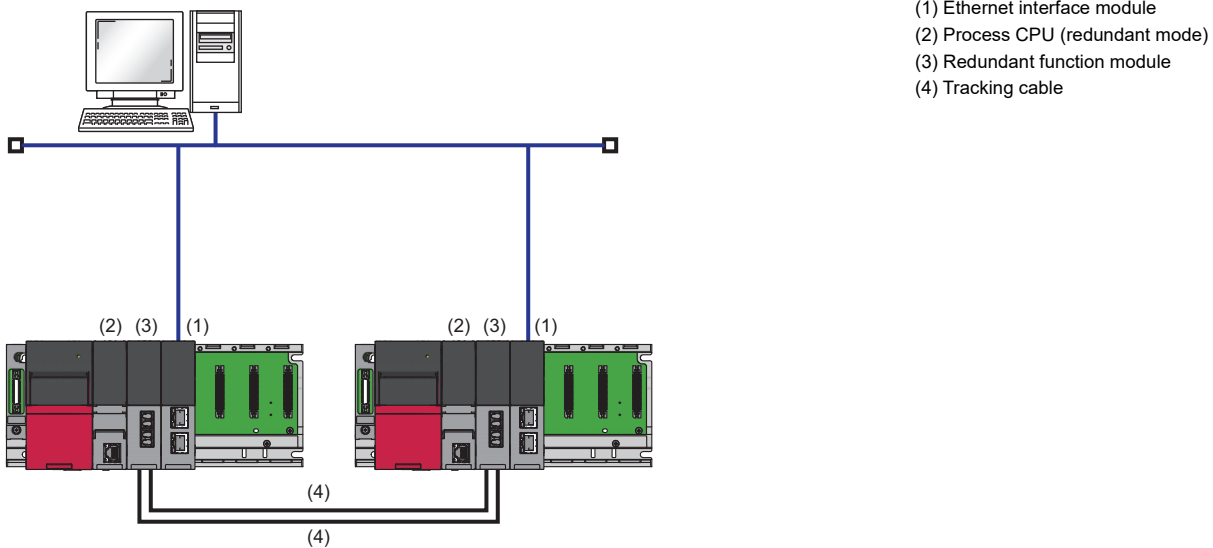

In addition, the Ethernet network line can be redundant by setting a redundant group. When the Ethernet network line becomes redundant, data communications by the control system can be continued without switching the systems when an error occurs in one network.

There are two types of redundant group setting: redundant module group setting and port group setting.

For details, refer to "Redundant System Function" in the following.

MELSEC iQ-R Ethernet User's Manual (Application)

Redundant system for CC-Link IE Controller Network

Mounting a CC-Link IE Controller Network module on the base unit of both the control system and the standby system enables a data link to be continued by the new control system when an error occurs in the control system.

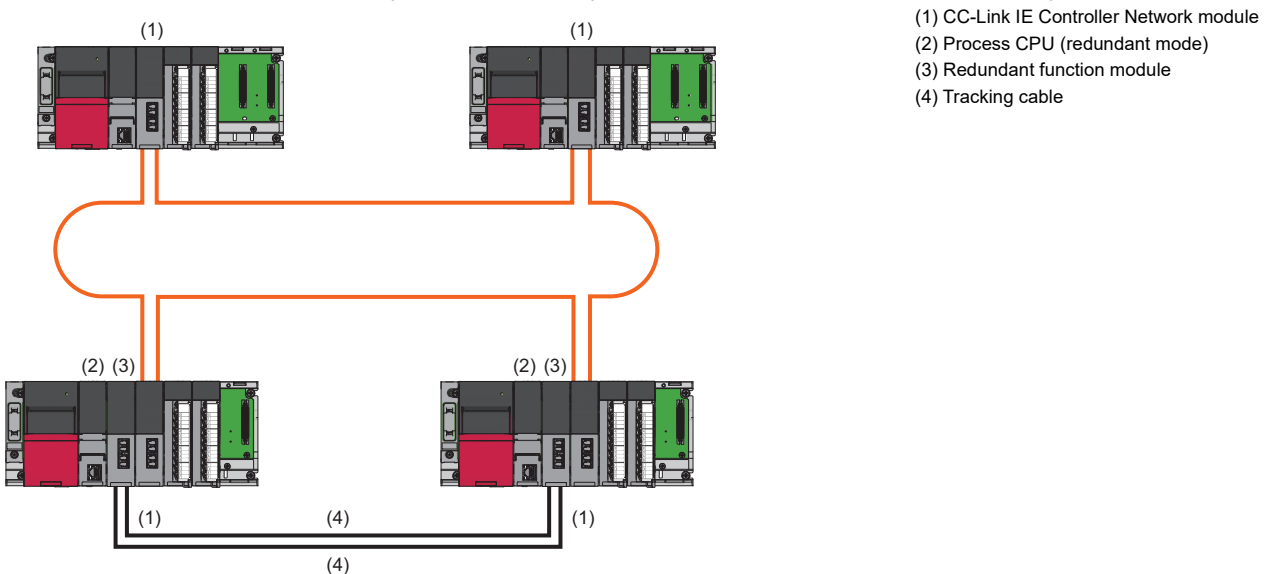

For details, refer to "Redundant System Function" in the following.

MELSEC iQ-R CC-Link IE Controller Network User's Manual (Application)

Redundant system for CC-Link IE Field Network

Making a CC-Link IE Field Network master/local module or a remote head module redundant enables a data link to be continued by the new control system when an error occurs in the control system.

The following table lists the redundant system configurations for CC-Link IE Field Network.

System configuration		Overview
Specified station	Redundant master station	A master station is configured to be redundant. When a redundant master station is configured, the station can be connected to the following. <ul style="list-style-type: none"> • Slave station • Redundant slave station
	Redundant slave station	A slave station is configured to be redundant. When a redundant slave station is configured, the station can be connected to the following. <ul style="list-style-type: none"> • Master station or redundant master station • Slave station • Redundant slave station
Entire network	Redundant line	The entire network including the master stations, slave stations, and transmission path is configured to be redundant. The redundant line is configured in combination with the redundant master station and the redundant slave station using two remote head modules. When a communication error occurs in the master station or slave station, the control is continued by switching the entire network system instead of switching only the faulty station. The time required for system switching of the redundant line configuration is shorter than that of the redundant master station or redundant slave station configuration.

There are no restrictions on network topologies in a redundant system. However, the ring topology is recommended to configure a redundant system because system switching can be avoided by the loopback function when a cable is disconnected or a faulty station is detected in a system other than the redundant system.

■ Redundant master station

Mount a CC-Link IE Field Network master/local module on the base unit of both the control system and the standby system. If an error occurs in the master station of the control system, the submaster station of the standby system performs control.

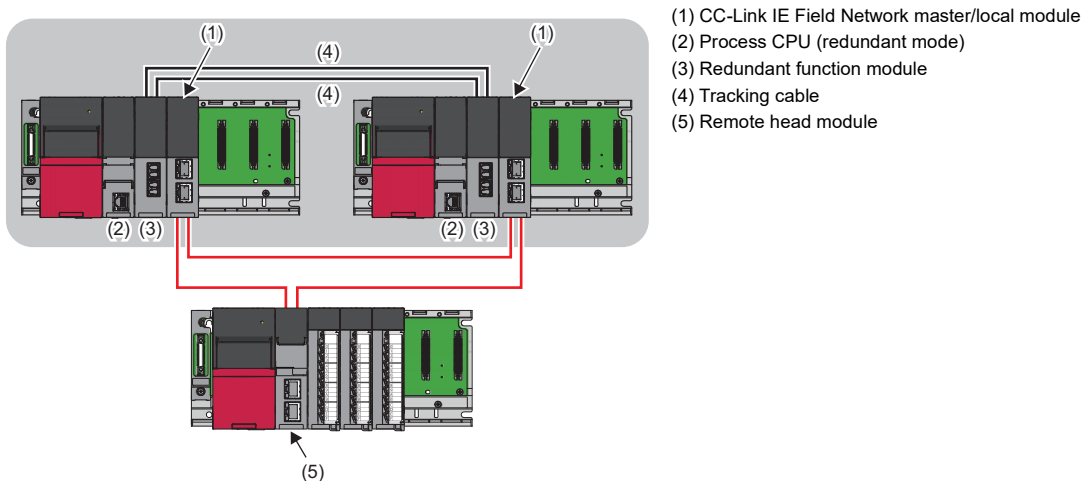

For details, refer to "Redundant System Function" in the following.

MELSEC iQ-R CC-Link IE Field Network User's Manual (Application)

■Redundant slave station

There are two types of redundant slave station: redundant configuration of local stations and redundant configuration of remote head modules.

- Redundant configuration of local stations

Mount a CC-Link IE Field Network master/local module on the base unit of both the control system and the standby system. If an error occurs in the local station of the control system, the local station of the standby system performs control.

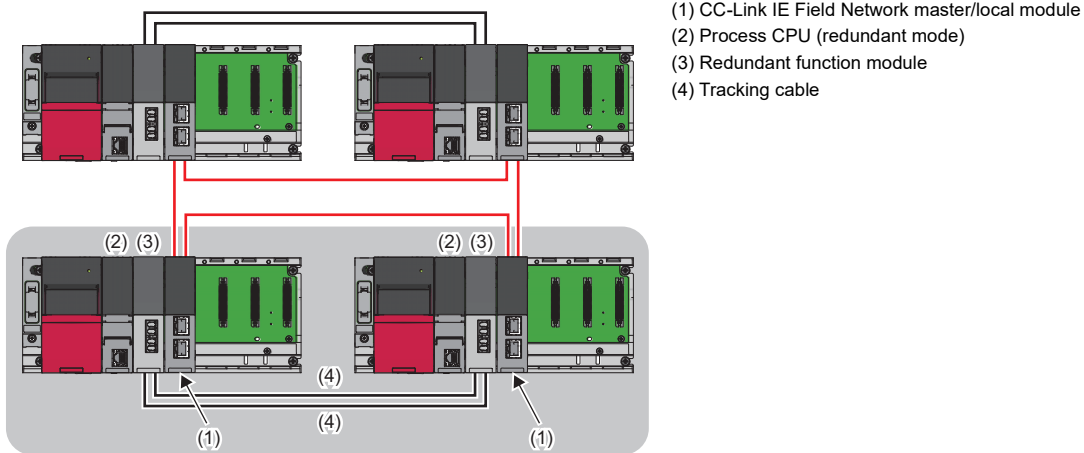

For details, refer to "Redundant System Function" in the following.

📖 MELSEC iQ-R CC-Link IE Field Network User's Manual (Application)

- Redundant configuration of remote head modules

Mount two remote head modules on the same base unit (one on the CPU slot and the other on the slot No.0). If an error occurs in the remote head module of the control system, the remote head module of the standby system performs control.

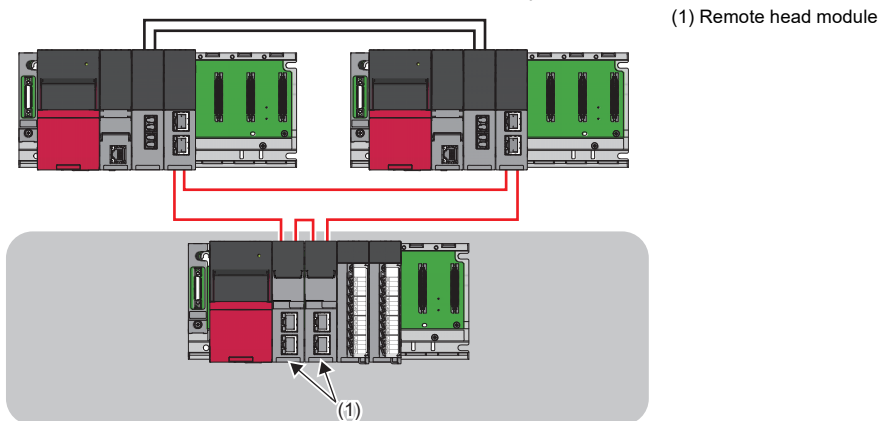

For details, refer to "Redundant Function" in the following.

📖 MELSEC iQ-R CC-Link IE Field Network Remote Head Module User's Manual (Application)

■Redundant line

A network line can be redundant.

Mount a CC-Link IE Field Network master/local module on the base unit of both the control system and the standby system to configure the redundant master station. Mount two remote head modules on the base unit of a slave station to configure the redundant slave configuration. Connect the master station of the control system and the remote head modules of the control system, and do the same for the standby system. When a network line is redundant, control is switched to the network of the standby system when an error occurs on the network of the control system.

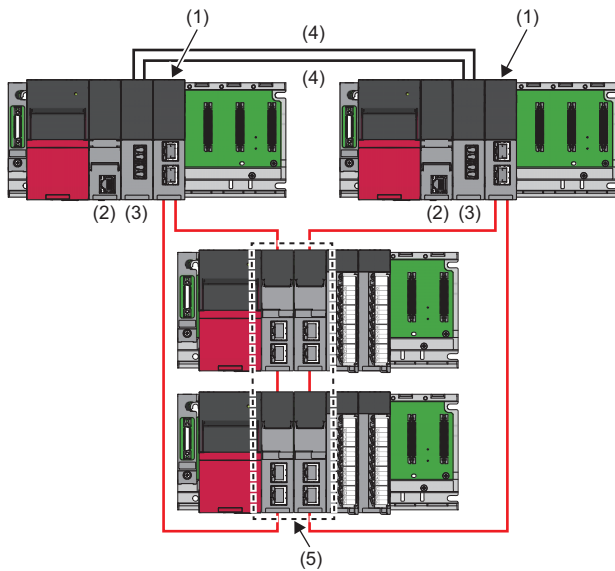

- (1) CC-Link IE Field Network master/local module
- (2) Process CPU (redundant mode)
- (3) Redundant function module
- (4) Tracking cable
- (5) Remote head module

For slave stations, only a redundant slave station with two remote head modules can be used.

For details, refer to "Redundant System Function" in the following.

📖 MELSEC iQ-R CC-Link IE Field Network User's Manual (Application)

1.3 Engineering Tool

GX Works3

GX Works3 manages programs and parameters for each CPU module in units of projects. The main functions of GX Works3 are as follows.

Program creation function

This function creates programs. Programs can be created in programming languages best suited for the processing.

<Ladder program>

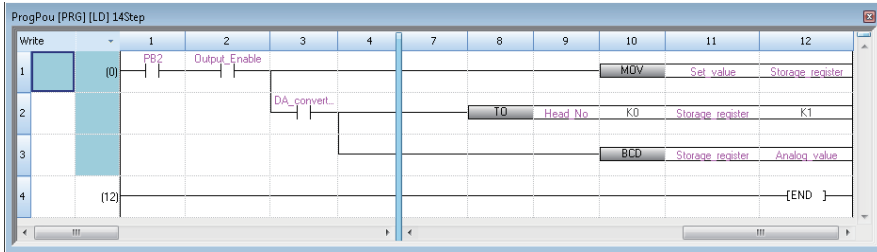

<ST program>

```
1 FOR counter1 := 0 TO 10 BY 2 DO
2 IF Var1 > 12345 THEN
3   Var1 := Var1 + counter1;
4   ELSEIF Var1 < 22500 THEN
5     Var1 := Var1 - Var2;
6   ELSE
7     FOR count_01 := 0 TO 123 DO
8       FOR...END_FOR;
9     END_FOR;
10  END_IF;
11 END_FOR;
12
```

<FBD/LD program>

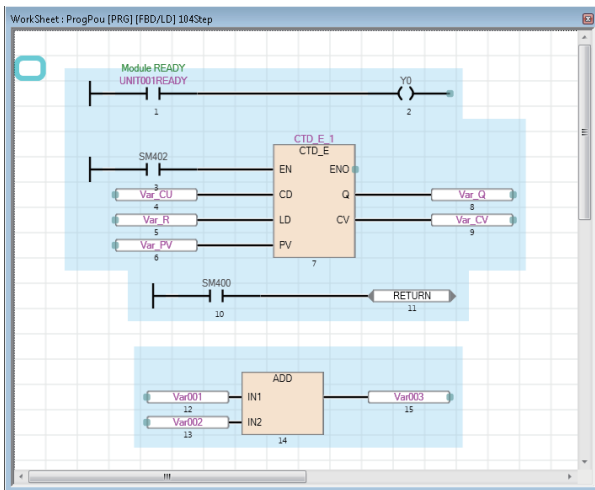

<SFC program>

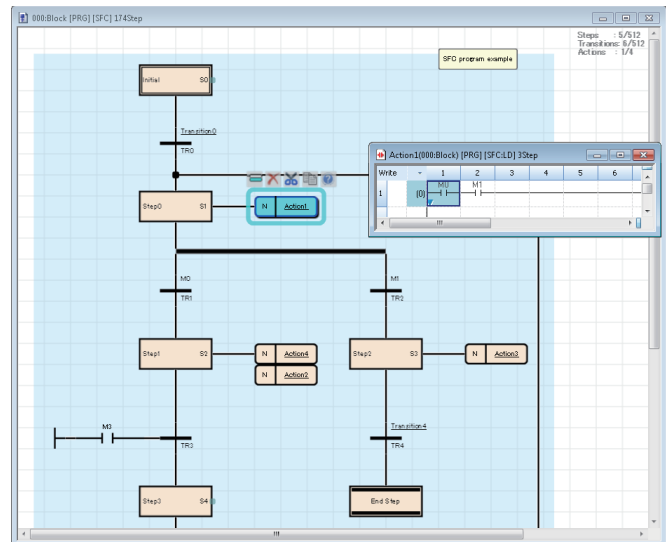

Parameter setting function

This function sets parameters of CPU modules, I/O modules, and intelligent function modules.

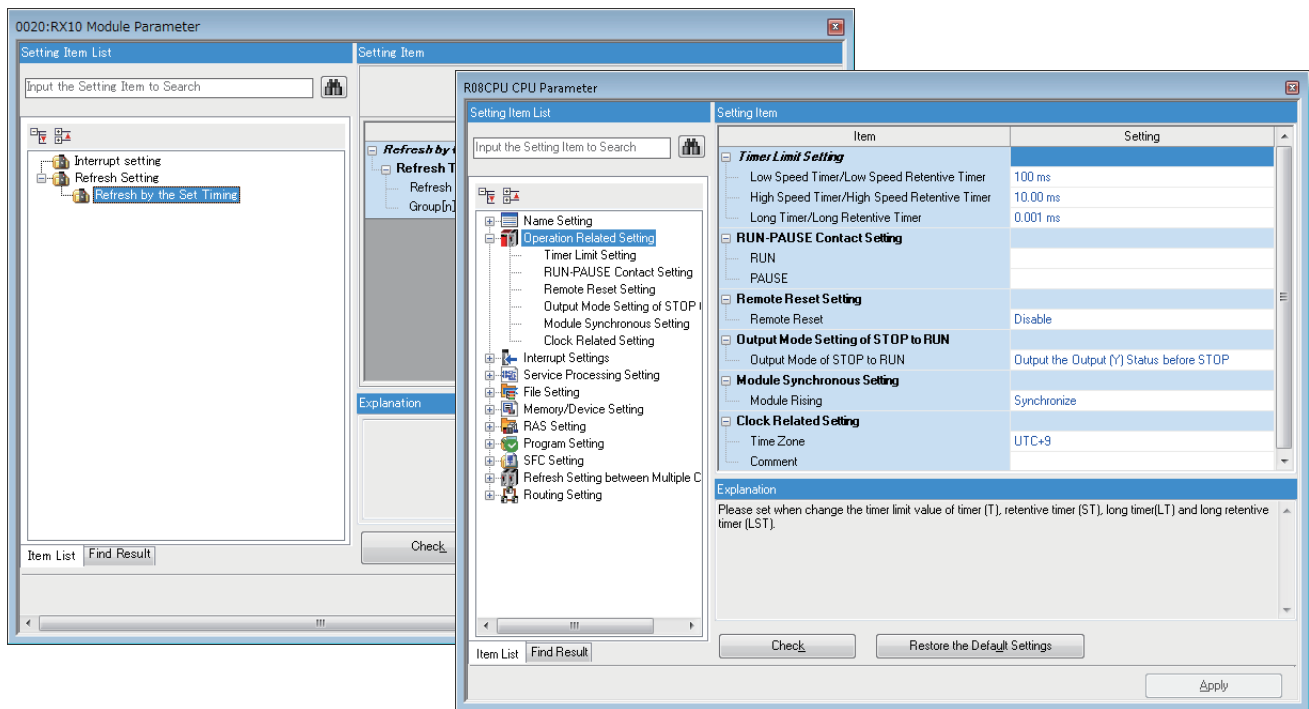

Read from PLC function, write to PLC function

These functions read/write created sequence programs from/to the CPU module.

In addition, sequence programs can be modified online using the online change function.

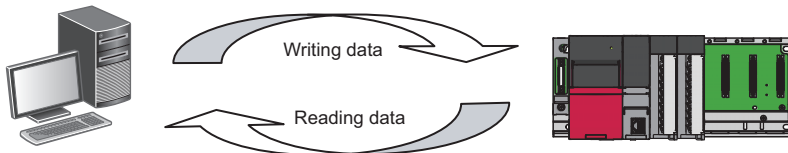

Monitor/debug function

This function monitors data such as device values when created sequence programs are written to the CPU module and executed.

Even when the engineering tool is not connected to the CPU module, programs can be debugged using a virtual programmable controller (simulation function).

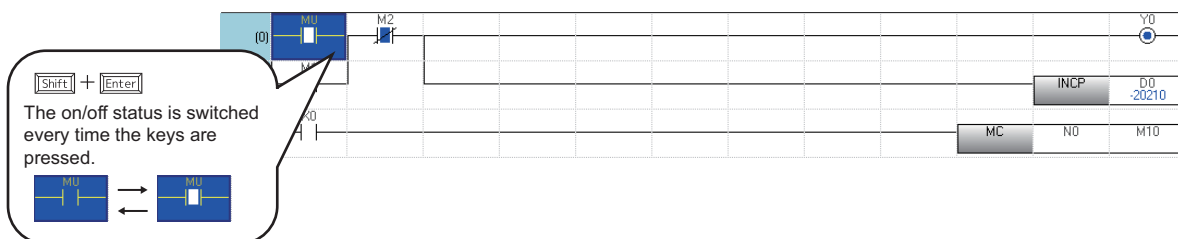

Diagnostic function

This function diagnoses the current error status and error history of the CPU module and network. The function helps to shorten the recovery time.

In addition, detailed information of modules such as intelligent function modules can be checked using the system monitor function. This feature further shortens the recovery time when an error occurs.

■ CPU module diagnostics ("Module Diagnostics" window)

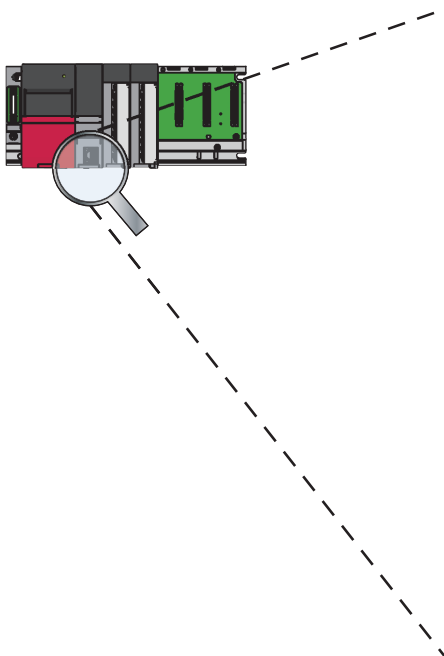

The screenshot displays the 'Module Diagnostics' window for a CPU (PLC No. 1) Start I/O No. 3E00. The window is titled 'Module Diagnostics(CPU (PLC No. 1) Start I/O No. 3E00)'. It features a 'Module Name' field containing 'R08CPU' and a 'Production information' field with '--'. A 'Supplementary Function' dropdown menu is set to 'Ethernet diagnostics', with 'Execute' and 'Monitoring' buttons. A 'Monitoring' button is highlighted in green, and a 'Stop Monitoring' button is visible below it.

The 'Error Information' tab is active, showing a table with the following data:

No.	Occurrence Date	Status	Error Code	Overview
1	2015/05/31 18:21:50.291		2200	Parameter error

Buttons for 'Error Jump', 'Event History', and 'Clear Error' are located to the right of the table. A 'Detail' button is at the bottom right of the table area. Below the table is a 'Legend' section with icons for Major (red triangle), Moderate (orange triangle), and Minor (yellow triangle).

The 'Detailed Information' section is expanded, showing the following details:

Detailed Information	Parameter information
Type of parameter :System parameter	-
Parameter drive :Data memory	-
Cause	- The system parameter file and CPU parameter file do not exist. - The memory card parameter file or module extension parameter file stored in the memory card cannot be accessed because the memory card is disable by SM606 (SD memory card forced disable instruction).
Corrective Action	- Write the system parameter file and CPU parameter file to the CPU module. - Turn off SM606. (Cancel the disabled state.)

Buttons for 'Create File...' and 'Close' are located at the bottom of the window.

RnPCPU

GX Works3 supports the MELSEC iQ-R series RnPCPU, which is used to construct a process control system and a redundant system, and process control programs.

There are two operation modes for the RnPCPU: process mode and redundant mode. The type of project which can be created differs depending on the selected mode.

Mode	Description
Process	A mode to create a project for process control programs
Redundant	A mode to create a project for process control programs and functions for a redundant system

Redundant system

A project for the CPU module in a redundant system configuration can be created by selecting "Redundant" for the operation mode when creating a new project.

The project for the CPU module in a redundant system configuration controls two systems (control system and standby system).

■Functions for a redundant system

GX Works3 has the following functions to operate the CPU module in a redundant system configuration.

Function	Description
Operation mode change	Switches the operation mode (backup mode or separate mode).
System A/B setting	Sets the system (system A or system B).
System switching	Switches the control system to the standby system.
Memory copy	Transfers data in the CPU module of the control system to the CPU module of the standby system.
Forced start of control system while waiting for the other system to start	Starts the CPU module that is waiting for the other system to start as the control system.
Redundant function module communication test	Checks the communications of the redundant function module itself (R6RFM only).

■Operation modes of the RnPCPU (redundant mode)

The RnPCPU (redundant mode) has two operation modes: backup mode and separate mode.

The following table lists the operation of each mode in GX Works3.

Operation mode	Description
Backup mode	An online operation is performed for both systems. When writing data, the same data is written to both systems.
Separate mode	An online operation is performed only for the connected system.

PX Developer monitor tool

Overview

PX Developer is a software package that enables DDC processing in the CPU module.

PX Developer consists of two tools: programming tool for programming in FBD language and monitor tool for monitoring DDC processing using tag data.

The monitor tool is a software tool that monitors and controls DDC processing being performed in the CPU module.

The monitor tool monitors and controls DDC processing implemented in the form of a tag FB through the programming tool.

A tag FB internally has a data area called "tag data". This tag data is allocated to a device of the programmable controller so that the status of the DDC processing logic is reflected whenever a program including the corresponding tag FB is executed.

The DDC processing logic itself is controlled by parameters stored in the tag data.

The monitor tool communicates with the CPU module to monitor and control this tag data. Users can read and display the tag data on various monitor screens, and also can write values to the tag data. Global labels and current device values can be read and displayed as well.

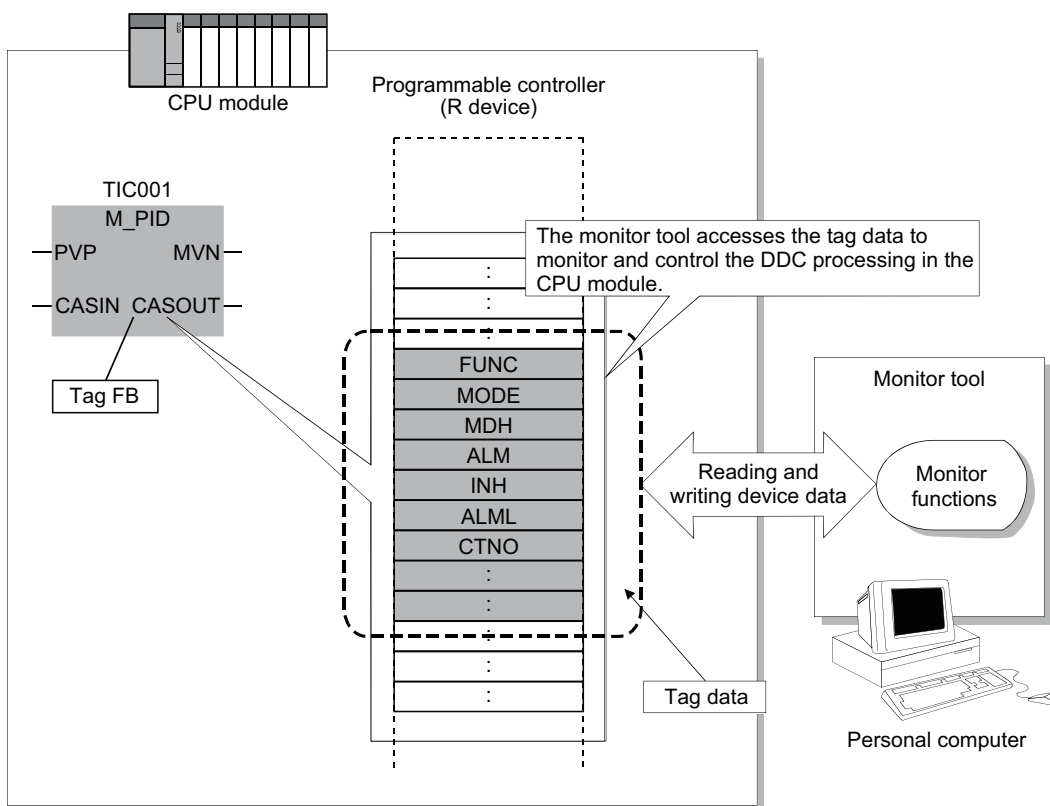

To allow users to create any desired user graphic screens (user monitor screens) using Microsoft® Visual Basic®, the monitor tool provides ActiveX controls to acquire/set values from/to the tag data and to display faceplates.

User graphic screens created with ActiveX controls can be easily opened by clicking buttons on the monitor tool.

Features

■Tag monitoring control functions that reduce the time required before the process control system operation

The monitor tool has various standard functions for tag monitoring control, which are required for the start-up adjustment of the process control system. Only simple settings are required to monitor tags created using the programming tool, and there is no need to program communication processing for monitoring.

■Various connection methods with the CPU modules

The monitor tool can simultaneously monitor up to 16 CPU modules via CC-Link IE Controller Network and Ethernet network. Use the serial/USB connection for adjustment.

○: Available, ×: Not available

Communication path	Adjustment	Operation
Serial/USB	○	×
CC-Link IE Controller Network	○	○
Ethernet	○	○ ^{*1}

*1 Not available when the monitor tool is directly connected to a built-in Ethernet port of the Built-in Ethernet port type CPU module

■Operation environment supporting single- and multi-window applications

Depending on their application, users can select the single-window mode and the multi-window mode. The single-window mode always displays a single window at the maximum size. The multi-window mode displays multiple windows at the same time.

In multi-window mode, the monitor windows can be freely resized and organized with simple settings.

■User name and password management to prevent erroneous operations by unauthorized users

Users whose name and password are not registered (not having the access privileges) cannot change the mode to edit tag data values and settings. When leaving the seat, users can lock the mode to prevent unintended operations by unauthorized users.

■Linkage with GT SoftGOT

Graphic screens created using GT Designer2 or GT Designer3 can be displayed by starting up GT SoftGOT from the monitor tool. Users can use existing GOT screens and create graphics using familiar GT Designer2 and GT Designer3.

The monitor tool functions such as the faceplate can be called from GT SoftGOT, reducing the time required to create screens.

■Auto generation of a GOT screen project

A GOT screen project can be automatically generated from the PX Developer project by performing simple settings such as screen placement and entering required information as prompted by the wizard in the monitor tool, reducing the time required to create monitoring operation screens.

■Creating user graphic screens using Microsoft® Visual Basic®

The monitor tool provides ActiveX control to acquire/set values from/to tag data. The tag data can be monitored with this ActiveX control on the screen created using Microsoft® Visual Basic®.

■Application to a redundant system

The monitor tool can monitor and control a redundant system.

Auto-tracking when system switching occurs is supported.

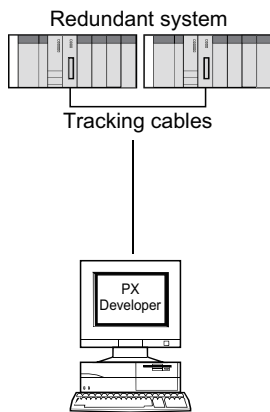

■Stand-alone monitoring by the monitor tool

With PX Developer version 1.06G or later, the monitor tool can be operated alone in the personal computer where GX application is not installed.

■Simulator connection

With PX Developer version 1.28E or later, offline debugging using Simulator is supported. This enables users to check the settings and simulate monitor operations without connecting to the CPU module.

■ Server/client monitoring system

- Communication performance enhancement between the monitor tool and the programmable controller

The server performs batch data communications with programmable controllers. This reduces the communication load on programmable controllers and increases communication performance.

- Same display on the monitor screen of all operator station (OPS) monitor tools

The monitoring data collected and managed by the server is also displayed on the client side. This enables the same display on the monitor screen of all OPS monitor tools.

- Continuous monitoring even if an error occurs on the server

The monitoring system consists of two servers (primary and secondary). When an error occurs on the primary server, a client automatically switches the server to the secondary server to continue monitoring.

- Synchronized buzzer stop and alarm/event check/deletion

If a buzzer is stopped or an alarm/event is checked/deleted in any one of the OPSs in the monitoring system, the operation is reflected to all OPSs in the monitoring system.

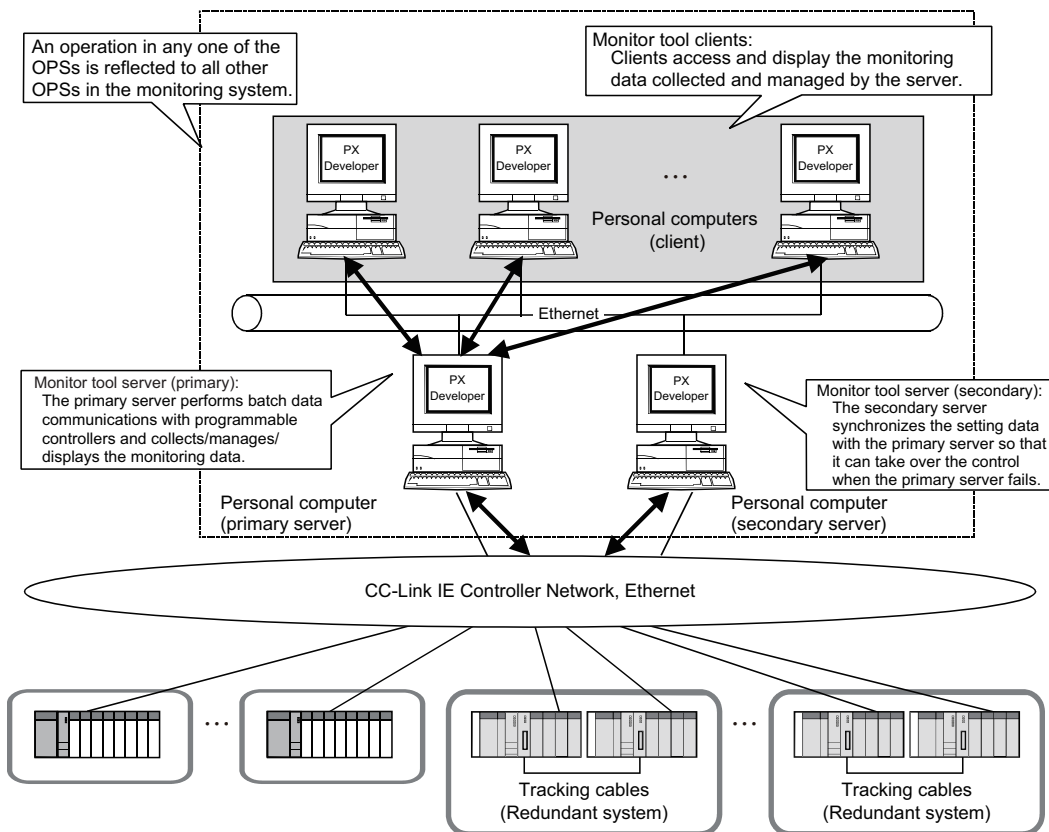

Point

- When a redundant server system is configured, the settings can be modified on the primary server. The secondary server starts up based on the setting data of the primary server.
- Monitoring data is not equalized between the primary and secondary servers. Equalizing the monitoring data means synchronizing the monitoring data, such as trends and alarms, between the primary and secondary servers.

1.4 Configuration Devices

This section lists products that can be used in the MELSEC iQ-R series system.

MELSEC iQ-R series

The following tables list the configuration devices. Use the lists to check whether the devices can be used with the Process CPU and the remote head module.

Note that there are restrictions on the usable functions or the firmware version of usable modules, depending on the combination of modules used. Refer to the manuals for each module used as well.

The Process CPU and the remote head module are abbreviated as follows:

- RnP(P): Process CPU (process mode)
- RnP(R): Process CPU (redundant mode)
- Rem: Remote head module
- Rem(R): Remote head module (redundant system)

○: Can be used, ×: Cannot be used

Main base unit

Product	Model	RnP(P)	RnP(R)	Rem	Rem(R)
Main base unit	R35B, R38B, R312B	○	○	○	○
Extended temperature range main base unit	R310B-HT	○	○	○	○
Redundant power supply main base unit	R310RB	○	○	○	○
Extended temperature range redundant power supply main base unit	R38RB-HT	○	○	○	○

Extension base unit and extension cable

Product	Model	RnP(P)	RnP(R)	Rem	Rem(R)
Extension base unit	R65B, R68B, R612B	○	×	○	○
Extended temperature range extension base unit	R610B-HT	○	×	○	○
Redundant power supply extension base unit	R610RB	○	×	○	○
Extended temperature range redundant power supply extension base unit	R68RB-HT	○	×	○	○
RQ extension base unit	RQ65B, RQ68B, RQ612B	○	×	○	○
Extension cable	RC06B, RC12B, RC30B, RC50B, RC100B	○	×	○	○

Power supply module

Product	Model	RnP(P)	RnP(R)	Rem	Rem(R)
Power supply module	R61P, R63P	○	○	○	○
	R62P, R64P	○	○	○	○
Redundant power supply module	R63RP, R64RP	○	○	○	○

CPU module

Product	Model
Process CPU*1	R08PCPU, R16PCPU, R32PCPU, R120PCPU

*1 To configure a redundant system, use a redundant function module and operate a Process CPU in redundant mode. When the firmware version of the Process CPU (redundant mode) used is 06 or earlier, use the Process CPUs with firmware version 06 or earlier in both systems.

For the configuration of a redundant system, refer to the following.

 Page 9 Redundant System



The Process CPU (redundant mode) cannot be used in a multiple CPU system.

CPU module extension

Product	Model	RnP(P)	RnP(R)	Rem	Rem(R)
Redundant function module	R6RFM	×	○	×	×

Remote head module

Product	Model	RnP(P)	RnP(R)	Rem	Rem(R)
CC-Link IE Field Network	RJ72GF15-T2	—	—	—	—

Memory extension

Product	Model	RnP(P)	RnP(R)	Rem	Rem(R)
SD memory card	NZ1MEM-2GBSD, NZ1MEM-4GBSD, NZ1MEM-8GBSD, NZ1MEM-16GBSD	○	○	×	×
Extended SRAM cassette	NZ2MC-8MBSE	○	○	×	×

Battery

Product	Model	RnP(P)	RnP(R)	Rem	Rem(R)
Battery	Q6BAT, Q7BAT, Q7BAT-SET	○	○	×	×

I/O module

Product	Model	RnP(P)	RnP(R)	Rem	Rem(R)
AC input module	RX10	○	○	○	○
	RX28	○	○	○	○
DC input module	RX40C7, RX41C4, RX42C4	○	○	○	○
DC high-speed input module	RX40PC6H, RX40NC6H	○	○	○	○
	RX41C6HS, RX61C6HS	○	○	○	○
Input module with diagnostic functions	RX40NC6B	○	○	○	○
Contact output module	RY10R2	○	○	○	○
	RY18R2A	○	○	○	○
Triac output module	RY20S6	○	○	○	○
Transistor output module	RY40NT5P, RY41NT2P, RY42NT2P, RY40PT5P, RY41PT1P, RY42PT1P	○	○	○	○
Transistor high-speed output module	RY41NT2H, RY41PT2H	○	○	○	○
Output module with diagnostic functions	RY40PT5B	○	○	○	○
I/O combined module	RH42C4NT2P	○	○	○	○

Intelligent function module

Product	Model	RnP(P)	RnP(R)	Rem	Rem(R)
Analog-digital converter module	R60AD4, R60ADI8, R60ADV8	○	×	○	○
Channel isolated analog-digital converter module	R60AD8-G, R60AD16-G ^{*2}	○	×	○	○
High-speed analog-digital converter module	R60ADH4	○	×	○	○
HART-enabled analog-digital converter module	R60ADI8-HA	○	×	○	○
Digital-analog converter module	R60DA4, R60DAI8, R60DAV8	○	×	○	○
Channel isolated digital-analog converter module	R60DA8-G, R60DA16-G ^{*2}	○	×	○	○
High speed digital-analog converter module	R60DAH4	○	×	○	○
Simple Motion module	RD77MS2, RD77MS4, RD77MS8, RD77MS16	○	×	○ ^{*4}	×
	RD77GF4, RD77GF8, RD77GF16, RD77GF32	○	×	×	×
Channel isolated RTD input module	R60RD8-G	○	×	○	○
Channel isolated thermocouple input module	R60TD8-G	○	×	○	○
Temperature control module ^{*5}	R60TCTRT2TT2, R60TCTRT2TT2BW, R60TCRT4, R60TCRT4BW	○	×	○	○
High-speed counter module	RD62P2, RD62D2, RD62P2E	○	×	○	○
Channel isolated pulse input module	RD60P8-G	○	×	○	○
Flexible high-speed I/O control module	RD40PD01	○	×	○	○
MES interface module ^{*6}	RD81MES96	○	×	×	×
High speed data logger module	RD81DL96	○	×	×	×
OPC UA server module	RD81OPC96	○	×	×	×
C intelligent function module	RD55UP06-V	○	×	×	×
Positioning module ^{*4}	RD75P2, RD75P4, RD75D2, RD75D4	○	×	○	×
Ethernet ^{*3*5}	RJ71EN71	○	○	○	○
CC-Link IE Controller Network	RJ71GP21-SX ^{*5}	○	○	×	×
	RJ71EN71 ^{*1}	×	×	×	×
CC-Link IE Field Network	RJ71GF11-T2 ^{*5}	○	○	×	×
	RJ71EN71	○	×	×	×
CC-Link ^{*5}	RJ61BT11	○	○	○	○
Serial communication ^{*5}	RJ71C24, RJ71C24-R2, RJ71C24-R4	○	×	○	○
AnyWireASLINK master module	RJ51AW12AL	○	×	○	×
BACnet module	RJ71BAC96	○	×	○	×
CANopen module	RJ71CN91	○ ^{*7}	×	×	×
DeviceNet master/slave module	RJ71DN91	○ ^{*9}	×	×	×
PROFIBUS-DP module ^{*8}	RJ71PB91V	○	○	○	○

*1 To use the CC-Link IE Controller Network functions, there are restrictions on the firmware versions of the RnCPU, C Controller module, and RJ71EN71 used. (📖 User's Manual (Application) for the module used)

*2 These modules occupy two slots. When these modules are used with an RnCPU or a C Controller module, there are restrictions on the firmware version. (📖 User's Manual (Application) for the CPU module used)

*3 When this module is used with a remote head module, there are restrictions on network combinations. (📖 MELSEC iQ-R Ethernet/CC-Link IE User's Manual (Startup))

*4 When a redundant master station of CC-Link IE Field Network is configured, these modules cannot be used with a remote head module.

*5 There are restrictions on the firmware version to configure a redundant system. (📖 Manual for each module used)

*6 There are restrictions on the firmware version depending on the CPU module used. (📖 MELSEC iQ-R MES Interface Module User's Manual (Application))

*7 Use the RnCPU with firmware version 28 or later, RnENCPU with firmware version 17 or later, and the Process CPU with firmware version 12 or later. When the CPU module with a firmware version earlier than these versions is used, the refresh target cannot be set to "RPDO" and "TPDO" under "Refresh Setting" in "Module Parameter". If set, a parameter error (error code: 2220H) occurs.

*8 There are restrictions on the firmware version. (📖 Manuals for each module used)

*9 Use the RnCPU with firmware version 28 or later, the RnENCPU with firmware version 17 or later, the Process CPU (process mode) with firmware version 12 or later, and the Safety CPU with firmware version 14 or later. When the CPU module with a firmware version earlier than these versions is used, there are restrictions on "Refresh Setting" in "Module Parameter".

Blank cover module

Product	Model	RnP(P)	RnP(R)	Rem	Rem(R)
Blank cover module	RG60	○	○	○	○

MELSEC-Q series

The following table lists the MELSEC-Q series modules and extension cables which can be used in a MELSEC iQ-R series system.

To use MELSEC-Q series modules and extension cables in a MELSEC iQ-R series system, connect an RQ extension base unit and then a MELSEC-Q series extension base unit(s) to the lower level of the RQ extension base unit. (📖 MELSEC iQ-R Module Configuration Manual)

When a MELSEC-Q series module is used, refer to the following.

📖 MELSEC iQ-R Module Configuration Manual

Product	Model	
Base unit	Extension base unit	Q52B, Q55B, Q63B, Q65B, Q68B, Q612B
	Q series large type extension base unit ^{*5}	Q55BL, Q65BL, Q68BL
	Q series large type extension base unit (AnS series size) ^{*5}	Q55BLS, Q65BLS, Q68BLS, Q55BLS-D, Q65BLS-D, Q68BLS-D
Extension cable	QC05B, QC06B, QC12B, QC30B, QC50B, QC100B	
Power supply module	Q61P, Q61P-A1, Q61P-A2, Q62P, Q63P, Q64P, Q64PN, Q61P-D	
I/O module	AC input module	QX10, QX10-TS, QX28
	DC input module	QX40, QX40-TS, QX40-S1, QX41, QX41-S1, QX41-S2, QX42, QX42-S1, QX70, QX71, QX72, QX80, QX80-TS, QX81, QX81-S2, QX82, QX82-S1
	DC high-speed input module ^{*4}	QX40H, QX70H, QX80H, QX90H
	AC/DC input module	QX50
	Contact output module	QY10, QY10-TS, QY18A
	Triac output module	QY22
	Transistor output module	QY40P, QY40P-TS, QY41P, QY42P, QY50, QY68A, QY70, QY71, QY80, QY80-TS, QY81P, QY82P
	Transistor high-speed output module	QY41H
	I/O combined module	QH42P, QX48Y57, QX41Y41P
	Interrupt module	QI60 ^{*2}
	Large type AC input module ^{*5}	QX11L, QX21L
	Large type contact output module ^{*5}	QY11AL, QY13L
	Large type triac output module ^{*5}	QY23L
Large type transistor output module ^{*5}	QY51PL	

Product		Model
Intelligent function module	Analog-digital converter module ^{*6}	Q64AD, Q68ADV, Q68ADI
	Channel isolated high resolution analog-digital converter module ^{*6}	Q64AD-GH
	Channel isolated high resolution analog-digital converter module (with signal conditioning function) ^{*6}	Q62AD-DGH
	Channel isolated analog-digital converter module ^{*6}	Q68AD-G
	Channel isolated analog-digital converter module (with signal conditioning function) ^{*6}	Q66AD-DG
	High speed analog-digital converter module ^{*6}	Q64ADH
	Digital-analog converter module ^{*6}	Q62DA, Q62DAN, Q64DA, Q64DAN, Q68DAV, Q68DAVN, Q68DAI, Q68DAIN
	Channel isolated digital-analog converter module ^{*6}	Q62DA-FG, Q66DA-G
	High speed digital-analog converter module ^{*6}	Q64DAH
	Analog input/output module ^{*6}	Q64AD2DA
	Load cell input module ^{*6}	Q61LD
	Current transformer input module ^{*6}	Q68CT
	RTD input module ^{*6}	Q64RD
	Channel isolated RTD input module ^{*6}	Q64RD-G, Q68RD3-G
	Thermocouple input module ^{*6}	Q64TD
	Channel isolated thermocouple/micro voltage input module ^{*6}	Q64TDV-GH
	Channel isolated thermocouple input module ^{*6}	Q68TD-G-H01, Q68TD-G-H02
	Temperature control module ^{*6}	Q64TCTTN, Q64TCRTN, Q64TCTTBWN, Q64TCRTBWN
	Loop control module	Q62HLC
	Multichannel high-speed counter module	QD63P6
	4Mpps capable high-speed counter module	QD64D2
	Channel isolated pulse input module	QD60P8-G
	Multi function counter/timer module	QD65PD2
	Positioning module ^{*3}	QD70P4, QD70P8, QD70D4, QD70D8, QD73A1
	Positioning module with built-in counter function ^{*3}	QD72P3C3
	MES interface module ^{*2*5*7}	QJ71MES96, QJ71MES96N
	Web server module ^{*2*5*7}	QJ71WS96
	CC-Link/LT master module	QJ61CL12
	AnyWire DB A20 master module	QJ51AW12D2
	MELSECNET/H network module ^{*1}	QJ71LP21 ^{*5} , QJ71LP21-25, QJ71LP21S-25, QJ71LP21G, QJ71BR11, QJ71NT11B
	MODBUS/TCP interface module	QJ71MT91
	MODBUS interface module	QJ71MB91
	FL-net (OPCN-2) interface module	QJ71FL71, QJ71FL71-T, QJ71FL71-B2, QJ71FL71-B5, QJ71FL71-F01, QJ71FL71-T-F01, QJ71FL71-B2-F01, QJ71FL71-B5-F01
AS-i master module ^{*2}	QJ71AS92	
Intelligent communication module ^{*5}	QD51, QD51-R24	
AnyWireASLINK master module	QJ51AW12AL	
Energy measuring module	QE81WH, QE84WH, QE81WH4W, QE83WH4W	
Insulation monitoring module	QE82LG	
Blank cover module	Blank cover	QG60
	Large type blank cover ^{*5}	QG69L
	Q series large type blank cover (AnS series size) ^{*5}	QG69LS

*1 There are restrictions on the firmware versions of the RnCPU and the C Controller module used. Note that the modules can only be used with a programmable controller CPU and a C Controller module. (☞ User's Manual (Application) for the CPU module used)
In a multiple CPU system where a Process CPU or a Safety CPU is used, these modules cannot be used even when the programmable controller CPU or the C Controller module is set as a control CPU.

*2 These modules cannot be used with a remote head module.

*3 These modules cannot be used with a remote head module (when configured as redundant).

*4 These modules cannot be used as an interrupt module when a remote head module is used.

*5 These modules cannot be used with a C Controller module.

- *6 The method for enabling parameters differs depending on the firmware version of the C Controller module used. (📖 MELSEC iQ-R C Controller Module User's Manual (Startup))
- *7 There are restrictions on the supported CPU modules. (📖 MELSEC iQ-R Module Configuration Manual)

2 STARTUP OF DEMONSTRATION MACHINE

2.1 Configuration

Hardware configuration

The following is the hardware configuration of the demonstration machine. The power supply switches supply power to each power supply module of the programmable controller. The heater is equipped with a thermocouple for temperature control. The emergency stop button (push-lock, turn-reset) is used to stop temperature control. The operation is performed from the GOT2000.

Front side of the demonstration machine

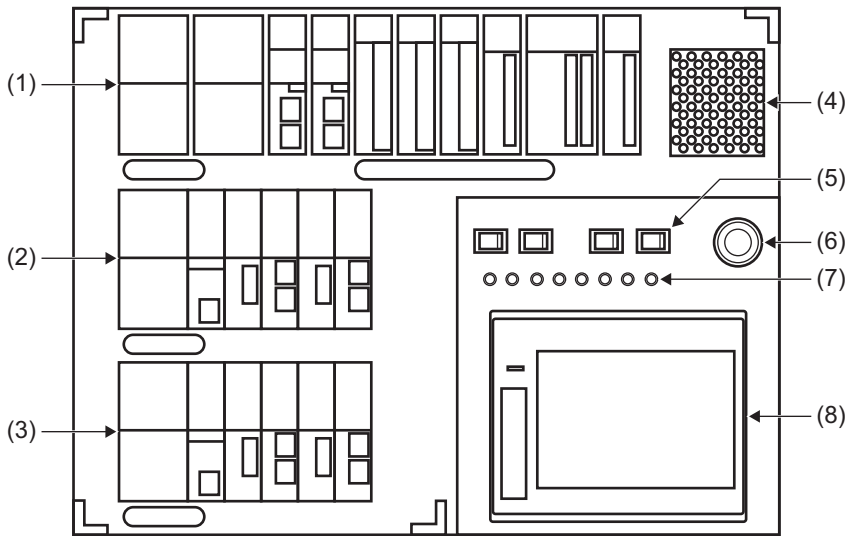

Left side

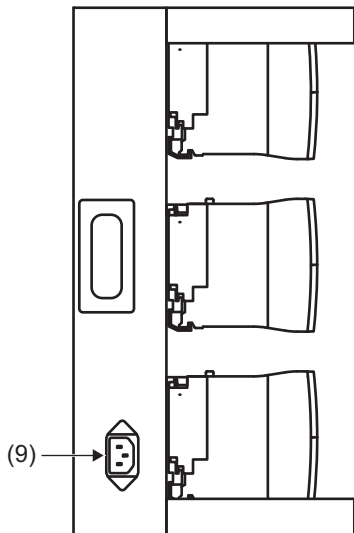

Right side

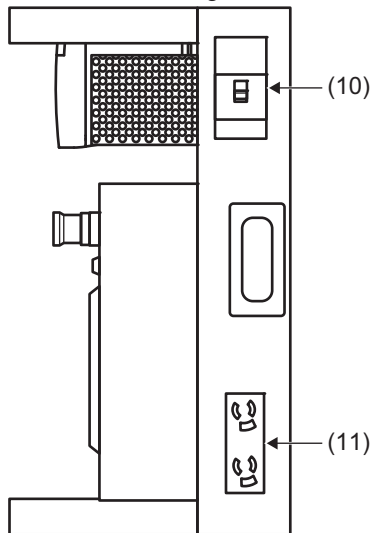

No.	Name		Product model
(1)	Slave station	Power supply module	R64RP
		CC-Link IE Field Network remote head module	RJ72GF15-T2
		DC input module with diagnostic functions	RX40NC6B
		Transistor output module with diagnostic functions	RY40PT5B
		Contact output module	RY10R2
		Channel isolated thermocouple input module	R60TD8-G
		Channel isolated digital-analog converter module	R60DA16-G
		Channel isolated analog-digital converter module	R60AD8-G
		Base unit	R38RB-HT
(2)(3)	Master station system A (redundant) Master station system B (redundant)	Power supply module	R61P
		Process CPU ^{*1}	R32PCPU
		Redundant function module	R6RFM
		Ethernet module ^{*2}	RJ71EN71
		CC-Link IE Controller Network module ^{*2}	RJ71GP21-SX
		CC-Link IE Field Network module ^{*2}	RJ71GF11-T2
		Base unit	R35B
(4)	Heater	—	—
(5)	Power supply switch	—	—
(6)	Emergency stop button (for temperature control stop)	—	—
(7)	LED (flashing in 10ms intervals)	—	—
(8)	GOT2000	GT2705-V	—
(9)	Main power supply	—	—
(10)	Main breaker	—	—
(11)	Outlet (100V, 2 ports)	—	—

*1 A module with firmware version 4 or later supports the redundant function.

*2 To execute redundant system functions, use a module with firmware version 12 or later.

System configuration

The following is the system configuration of the demonstration machine. The redundant system (master station) is configured with the redundant slave station and the CC-Link IE Field Network redundant line.

The demonstration machine is operated from the personal computer (monitor tool) and GOT2000 via Ethernet. CC-Link IE Controller Network is used to read the status of the other system.

In this exercise, GX Works3 version 1.047Z is used to configure modules and create programs.

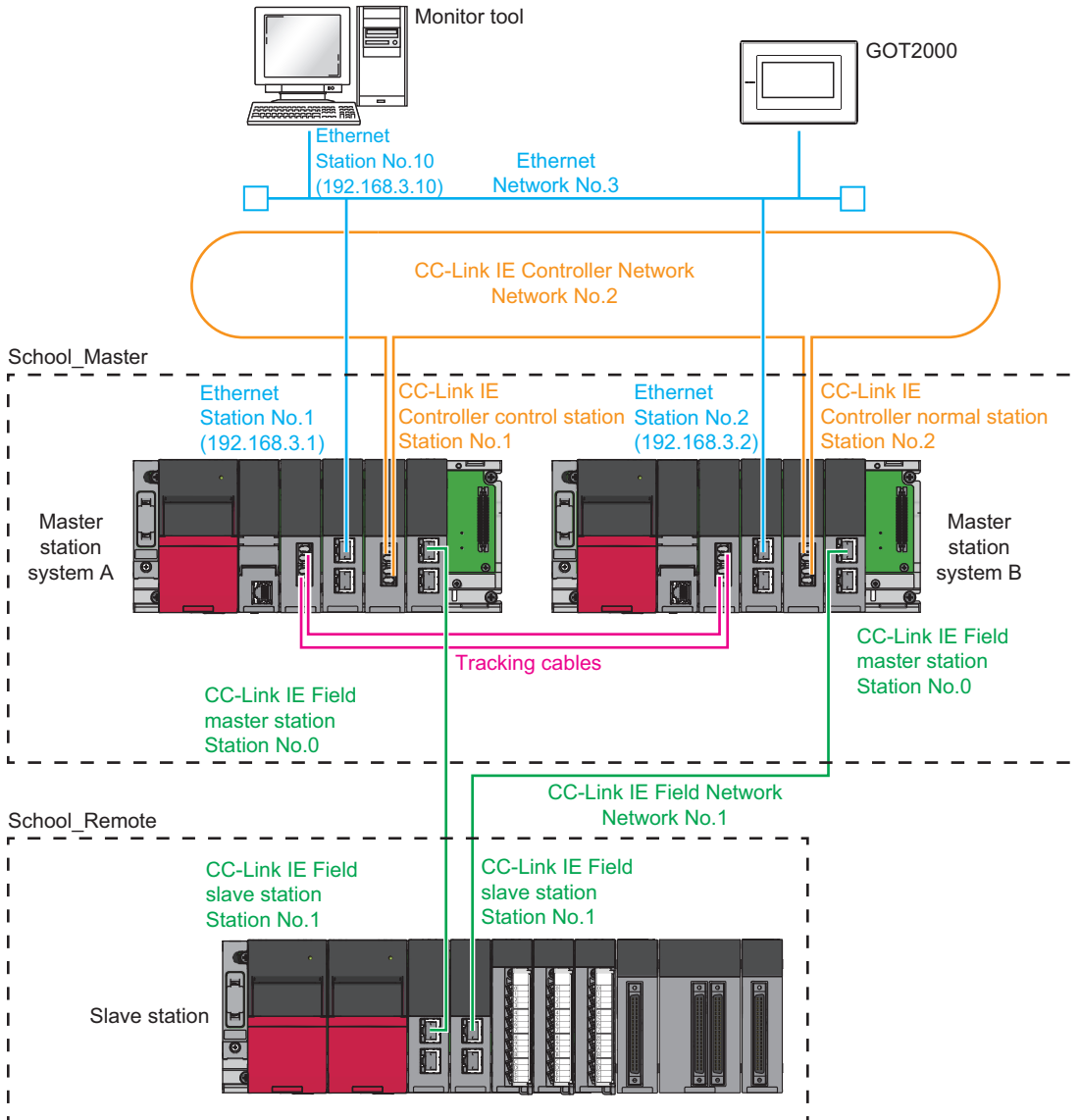

2.2 Wiring

Ethernet

This section describes the wiring for Ethernet.

1. Connect an Ethernet cable to "P1" of the RJ71EN71 of the master station system A.
This Ethernet cable is connected to the hub inside the demonstration machine, through which the master station system A and system B, GOT2000, and personal computer are connected.

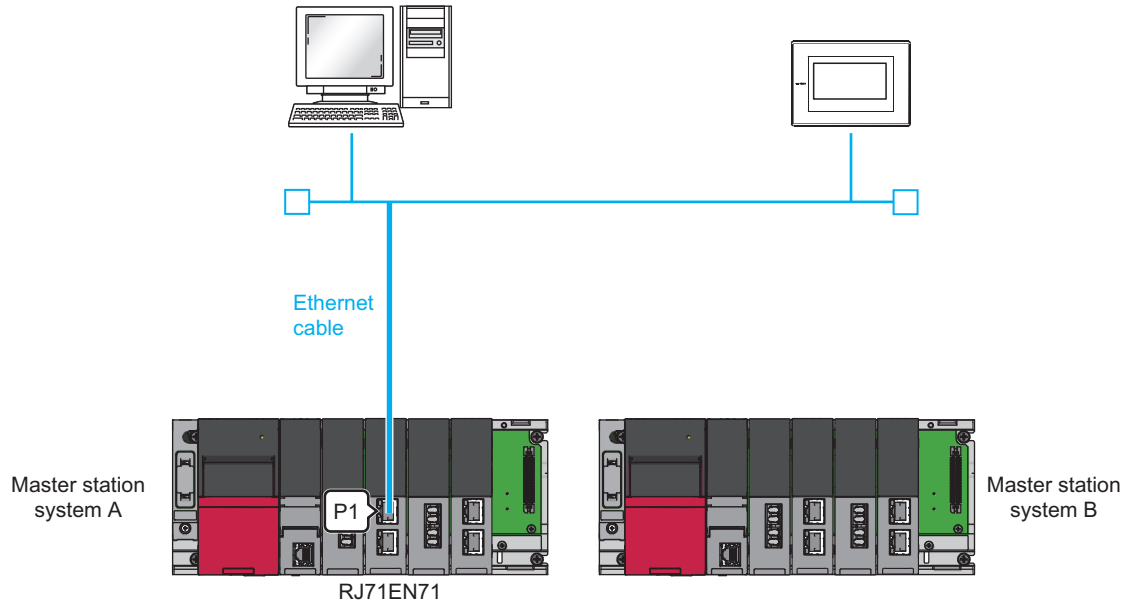

2. Connect an Ethernet cable to "P1" of the RJ71EN71 of the master station system B.

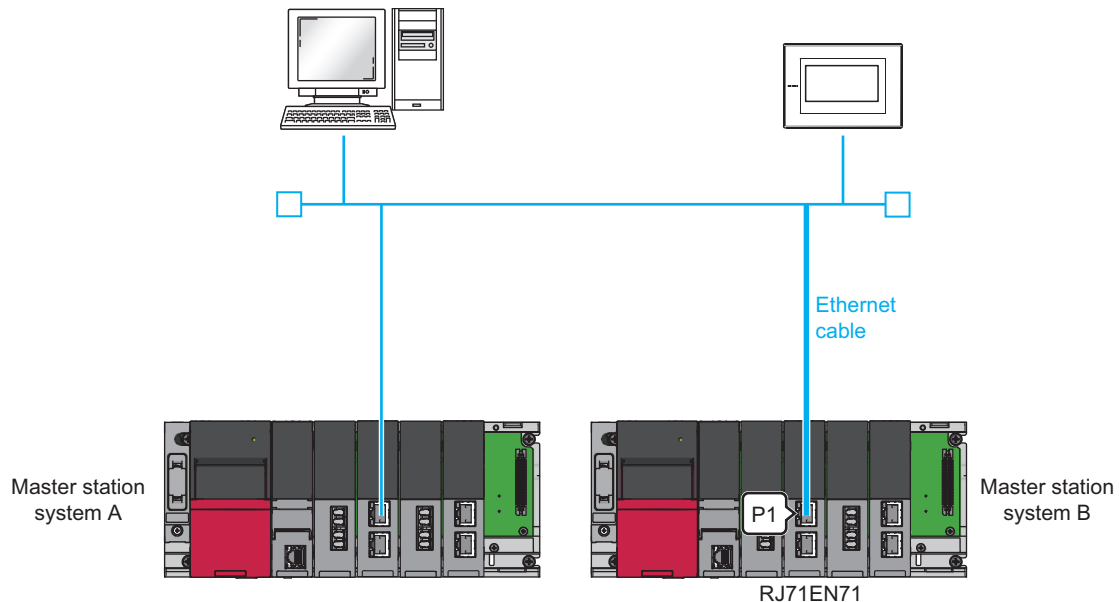

Point

A hub is installed inside the demonstration machine. Connect the Ethernet cable to the hub in advance, and route the cable through the hole located on the front of the demonstration machine and pull out the connector.

CC-Link IE Controller Network

This section describes the wiring for CC-Link IE Controller Network.

1. Connect "IN" of the RJ71GP21-SX of the master station system A and "OUT" of the RJ71GP21-SX of the master station system B with an optical fiber cable.

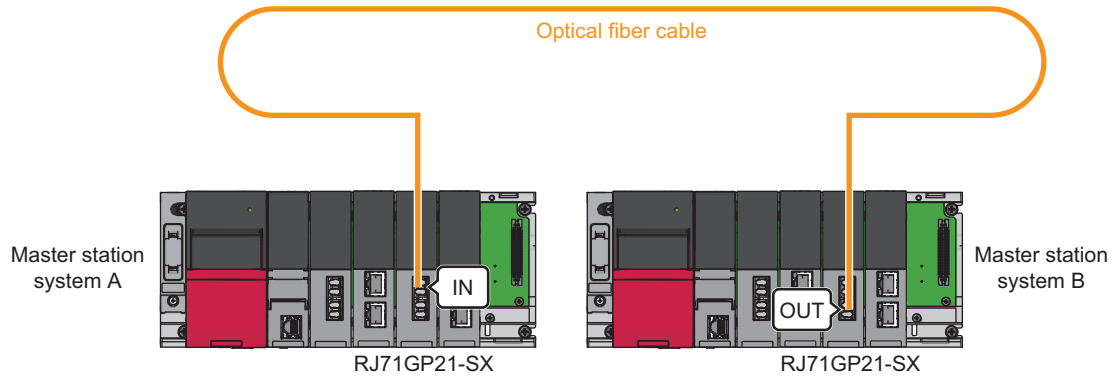

2. Connect "IN" of the RJ71GP21-SX of the master station system B and "OUT" of the RJ71GP21-SX of the master station system A with an optical fiber cable.

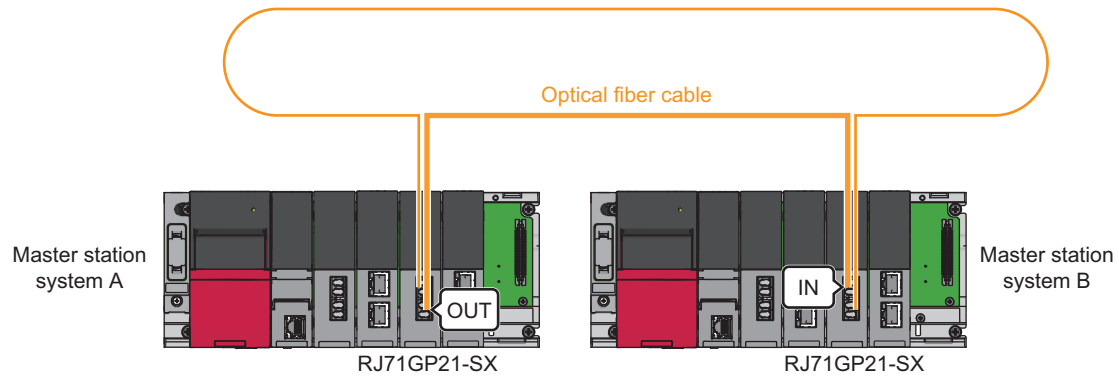

CC-Link IE Field Network

This section describes the wiring for CC-Link IE Field Network.

1. Connect "P1" of the RJ71GF11-T2 of the master station system A and "P1" of the RJ72GF15-T2 of the slave station with an Ethernet cable.

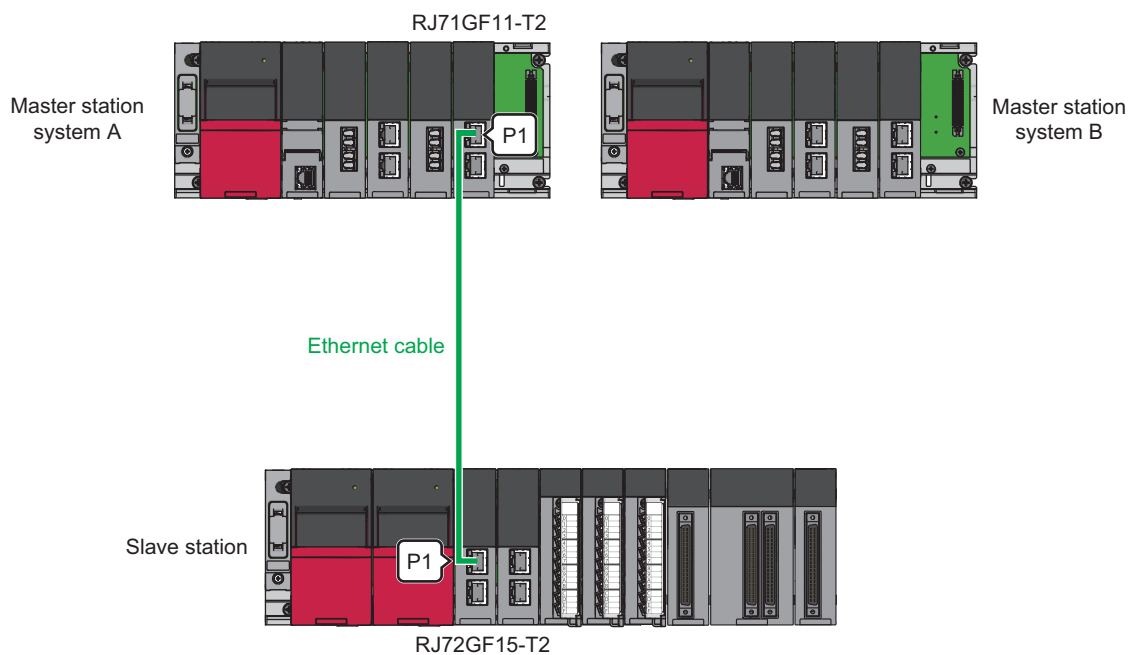

2. Connect "P1" of the RJ71GF11-T2 of the master station system B and "P1" of the RJ72GF15-T2 of the slave station with an Ethernet cable.

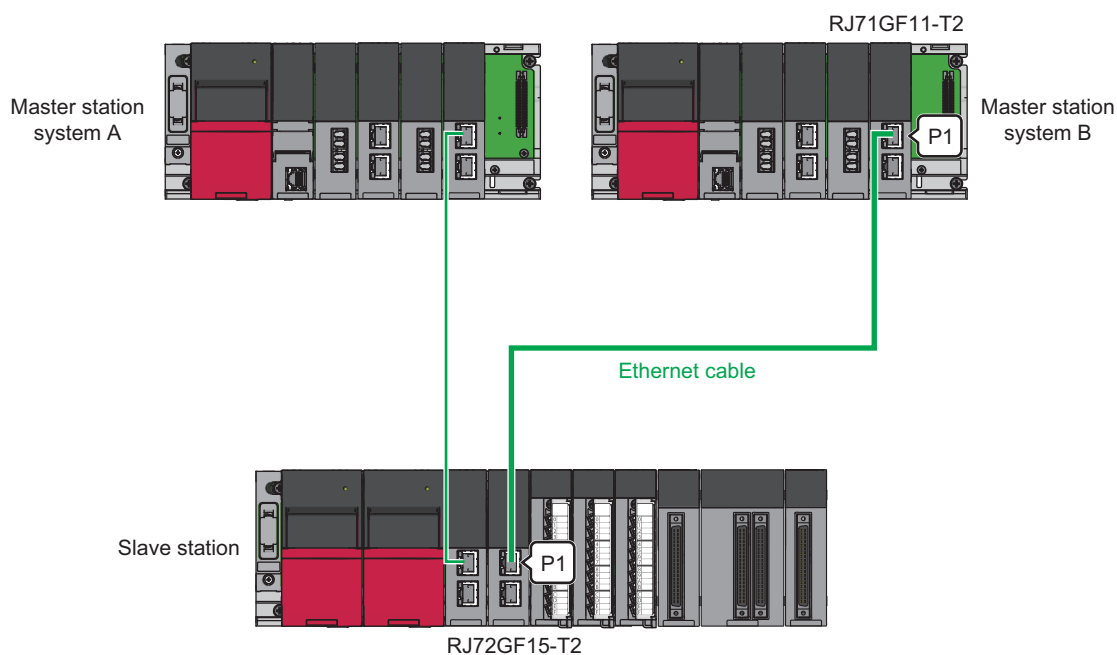

Redundant function module

This section describes how to wire the redundant function modules.

1. Connect "IN" of the R6RFM of the master station system A and "OUT" of the R6RFM of the master station system B with a tracking cable.

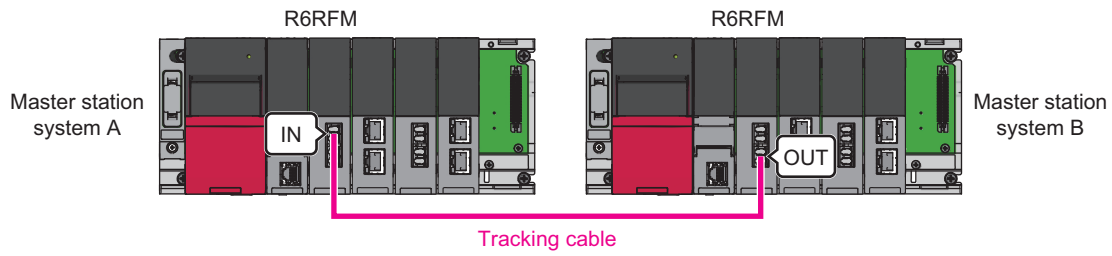

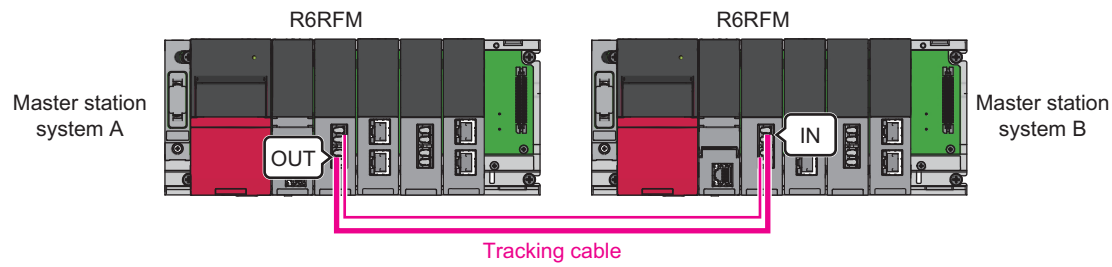

2. Connect "IN" of the R6RFM of the master station system B and "OUT" of the R6RFM of the master station system A with a tracking cable.



2.3 Start-up Procedure

Overview

There are two ways to start up a redundant system.

Start-up procedure	Description
Starting up both systems simultaneously	Configure two systems, and follow this procedure to start up both systems as a redundant system when the systems are powered on.  Page 36 Starting up both systems simultaneously
Starting up the systems one by one	Follow this procedure to start up a control system first to perform control, and then start up a standby system to configure a redundant system. <ul style="list-style-type: none">• Debugging before operation can be performed with only one system.• One system has failed and the redundant system is powered off before the failed module is replaced. In this case, only one system can be started up when the redundant system is powered on next time. For details, refer to the following.  MELSEC iQ-R CPU Module User's Manual (Application)

Starting up both systems simultaneously

1. Installing a battery



Install a battery to the CPU module of each system. ( MELSEC iQ-R CPU Module User's Manual (Startup))

2. Inserting an extended SRAM cassette or an SD memory card

Insert an extended SRAM cassette or an SD memory card into the CPU module of each system as needed. ( MELSEC iQ-R CPU Module User's Manual (Startup))

Do not power off or reset the CPU module, or remove an SD memory card during an access to the SD memory card.

3. Mounting modules and connecting cables

Mount modules on the base unit of each system, and connect cables. Use modules of the same model, and mount them on the same slots on each base unit. ( MELSEC iQ-R Module Configuration Manual,  Page 32 Wiring)

4. Powering on the redundant system

Check the following on each system, and power on the redundant system.

- A cable is correctly connected to the power supply.
- The power supply voltage is within the range of the specifications.
- The CPU module is in the STOP state.

Check that the following LEDs turn on after the system is powered on.

- Power supply module: POWER LED
- CPU module: READY LED
- Redundant function module: RUN LED

In step 4, the ERROR LED of each CPU module flashes and the ERR LED of each redundant function module turns on.

Proceed to the next step.

5. Connecting a personal computer to the CPU module

Start up the engineering tool installed on a personal computer.

Connect the personal computer to the CPU module of one system.

6. Initializing the CPU module

Initialize the CPU module using the engineering tool. ( MELSEC iQ-R CPU Module User's Manual (Startup))

After initialing the CPU module of one system, connect the engineering tool to the CPU module of the other system.

Initialize the CPU module in the same way.

7. Setting parameters

Set system parameters, CPU parameters, and module parameters.

- To execute the functions that access the SD memory card, set memory card parameters.
- When an intelligent function module is used in the system, set intelligent function module parameters.

Point

Users can set system parameters by loading the actual system configuration to the "Module Configuration" window of the engineering tool.

8. Creating a program

Create a program using the engineering tool. After creating the program, convert the program and save the project.

9. Writing the system A/B setting

Set the system A or B using the engineering tool. (☞ Page 110 Setting the system (system A or system B))

10. Writing data to the programmable controller

Write the set parameters and created program to the CPU modules of both systems using the engineering tool. (☞ Page 140 Writing the Projects, ☞ Page 184 Writing the Projects)

11. Resetting the CPU modules

Restart both systems in either of the following ways.

- Powering off and on the system
- Resetting the CPU module

12. Checking the LEDs

Check that the LEDs of each CPU module and redundant function module are in the following states. The CARD READY LED status (on or off) depends on whether an SD memory card is inserted to the CPU module or not.

• LEDs of system A

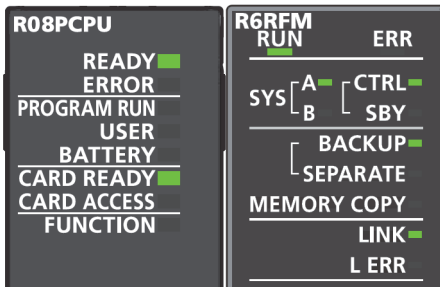

• LEDs of system B

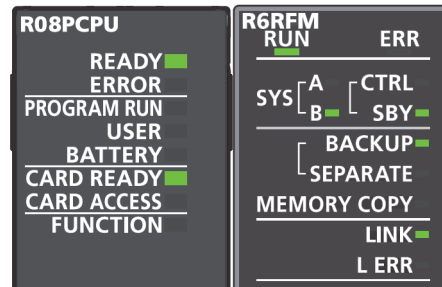

If an error has been detected, the following LEDs turn on. Identify the error using the engineering tool, and eliminate the error cause.

- CPU module: ERROR LED (☞ MELSEC iQ-R CPU Module User's Manual (Startup))
- Redundant function module: ERR LED, L ERR LED (☞ MELSEC iQ-R CPU Module User's Manual (Application))

To start up the system when the data logging function is used, refer to the following.

☞ MELSEC iQ-R CPU Module User's Manual (Application)

13. Executing the program

Power off both systems. Set the RUN/STOP/RESET switch of the CPU module of each system to the RUN position, and power on both systems.

Check that the PROGRAM RUN LED of the CPU module in the control system turns on.

Point

If the RUN/STOP/RESET switch of each CPU module is set to the RUN position while the CPU modules are powered on, a continuation error due to an operating status mismatch is detected in the CPU module of the standby system. Therefore, to start up both systems simultaneously, performing step 13 is recommended.

14. Monitoring the program

Check that the program operates normally on the engineering tool.

2.4 Operation

This section describes details of the exercise performed on each screen and how to operate each screen.

The demonstration machine is operated from the GOT2000 (GT2705-V).

Write Master_forGOT.gx3 to the Process CPU, R32PCPU, and Remote_forGOT.gx3 to the remote head module, RJ72GF15-T2, in advance.

☞ Page 184 Writing the Projects

Screen transition



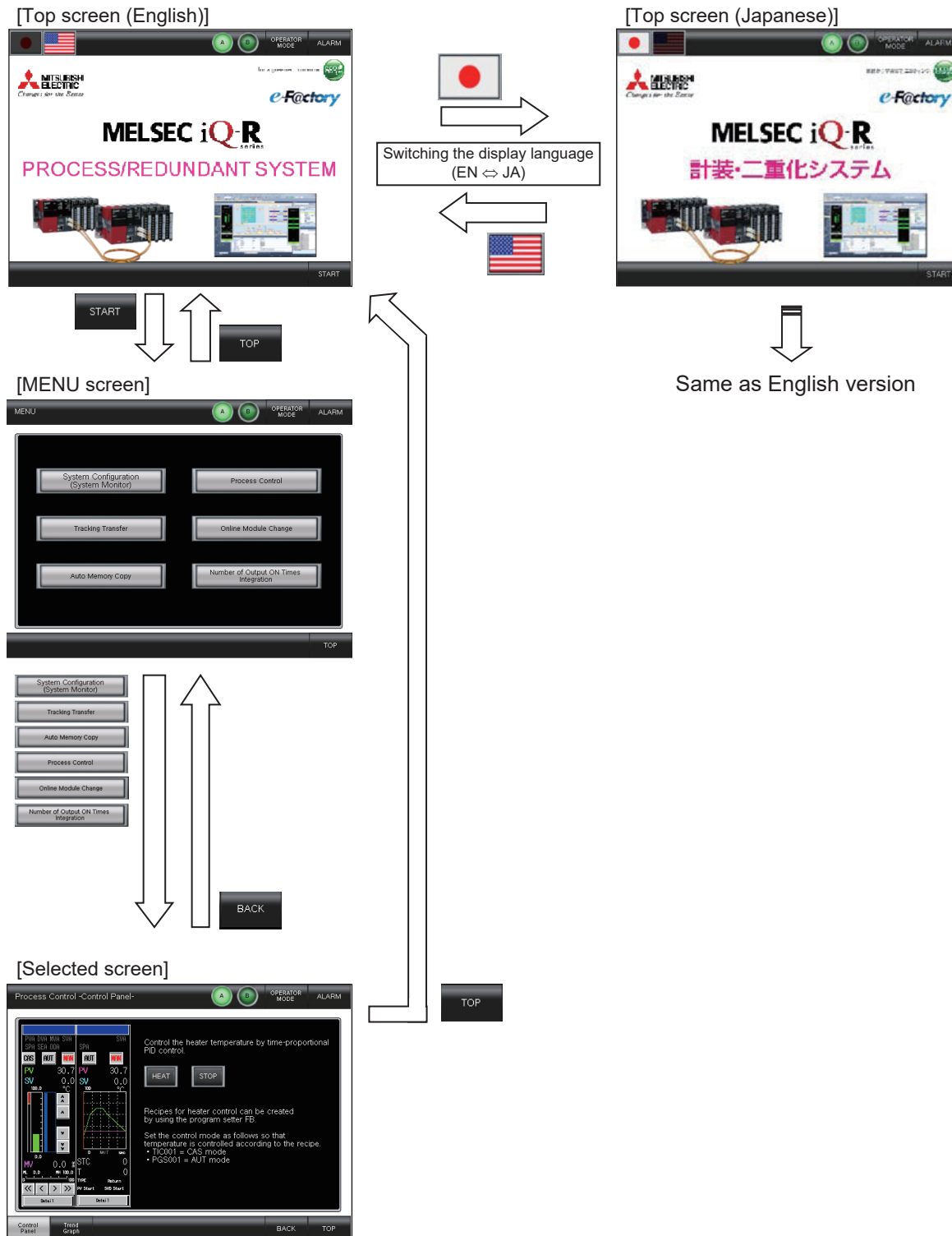



The following shows screen transition of the GOT2000.

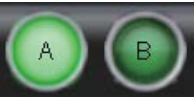

Basic operations

The following are the basic operations of the demonstration machine.

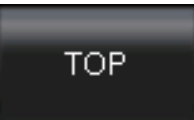
Lamps/buttons

Item	Description
<p>System A/B indicator lamps</p> <div style="display: flex; justify-content: space-around;"> <div style="text-align: center;"> <p>System A</p>  </div> <div style="text-align: center;"> <p>System B</p>  </div> </div>	<p>Indicate whether the current control system is system A or system B. The lamp for the current control system turns on.</p>
<p>[ALARM] button</p> <div style="display: flex; justify-content: space-around;"> <div style="text-align: center;"> <p>Normal operation</p>  </div> <div style="text-align: center;"> <p>Error</p>  <p>(Flashing)</p> </div> </div>	<p>Flashes in red when an error occurs. Touch the button to display the ALARM screen. The button color changes to black when the alarm is cleared. For details on the ALARM screen, refer to the following. ☞ Page 40 ALARM screen</p>
<p>[BACK] button</p> 	<p>Moves back to the previously displayed screen.</p>
<p>[TOP] button</p> 	<p>Moves to the title screen.</p>
<p>Language selector</p> <div style="display: flex; justify-content: space-around;">   </div>	<p>Switches the display language of the GOT2000 between English and Japanese. The default language is English.</p>

ALARM screen

This section describes how to operate the ALARM screen. On the ALARM screen, alarms that have occurred can be checked and reset.

The ALARM screen consists of the PROCESS ALARM screen and the SYSTEM ALARM screen. Alarms regarding process control (such as sensor errors) are displayed on the PROCESS ALARM screen, and errors that have occurred in the Process CPU and GOT2000 are displayed on the SYSTEM ALARM screen.

The PROCESS ALARM screen is displayed by default when switched to the ALARM screen.

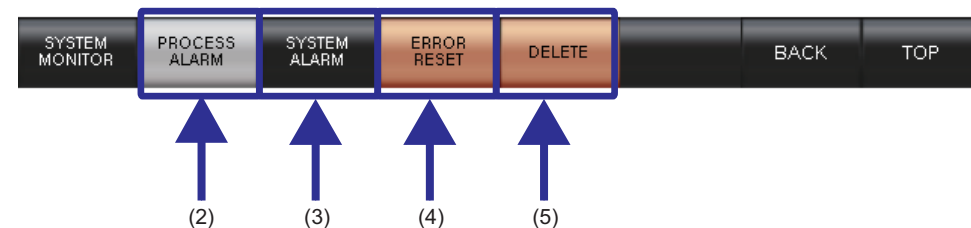
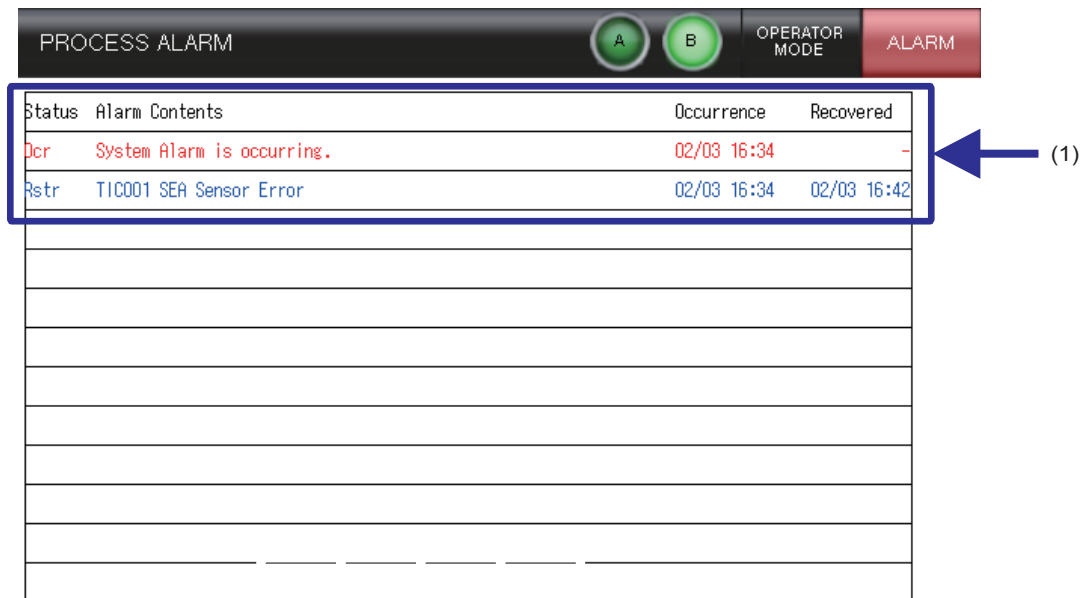

No.	Item	Description
(1)	Alarm display	Displays existing alarms. <ul style="list-style-type: none"> Alarms that have not been reset are displayed in red. Alarms that have been reset are displayed in blue.
(2)	[PROCESS ALARM] button	Switches to the PROCESS ALARM screen. On the PROCESS ALARM screen, alarms regarding process control (such as sensor errors) are displayed.
(3)	[SYSTEM ALARM] button	Switches to the SYSTEM ALARM screen. On the SYSTEM ALARM screen, errors that have occurred in the Process CPU and GOT2000 are displayed.
(4)	[ERROR RESET] button	Resets the existing alarms. This operation resets both process alarms and system alarms. Therefore, errors that have occurred in the CPU module and other modules are also cleared. The display color of the alarms that have been reset changes from red to blue.
(5)	[DELETE] button	Deletes alarms that have been reset (displayed in blue). If the [ALARM] button flashes red, it changes to black when all alarms are deleted.

Details of each screen

This section describes details of the exercise performed on each screen and how to operate each screen.

The following six screens are used in this exercise. The screens can be accessed by touching each button on the MENU screen.

- ☞ Page 42 System Configuration (System Monitor) screen
- ☞ Page 43 Process Control screen
- ☞ Page 47 Tracking Transfer screen
- ☞ Page 48 Online Module Change screen
- ☞ Page 49 Auto Memory Copy screen
- ☞ Page 50 Number of Output ON Times Integration screen



System Configuration (System Monitor) screen

This screen can be displayed by touching the [System Configuration (System Monitor)] button on the MENU screen.

On the screen, the configuration diagram of the redundant system is displayed. The LED status of the Process CPU and the remote head module and the network status are also displayed.

The screen can be projected via a projector to explain the redundant system configuration and also to demonstrate the system switching operation and the standby system diagnostic function. (The network error detection function for the standby system is achieved through "program executed in both systems + standby system data read via CC-Link IE Controller Network".)

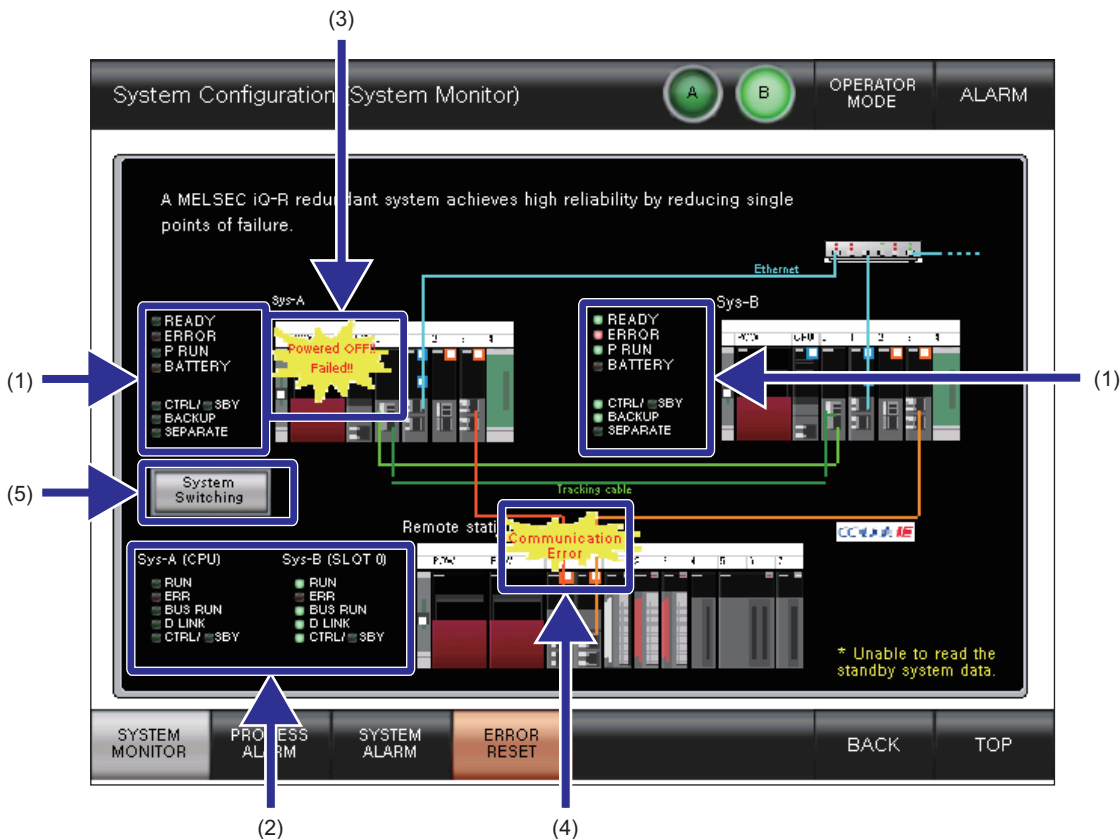

No.	Item	Description
(1)	CPU LED indication (master station)	The LED status of the following modules can be checked. <ul style="list-style-type: none"> • Process CPU • Redundant function module
(2)	CPU LED indication (slave station)	The LED status of the following module can be checked. <ul style="list-style-type: none"> • Remote head module
(3)	CPU error	A message is displayed when either of the following errors occur in the master station. <ul style="list-style-type: none"> • Process CPU stop error • Power-off/reset
(4)	Network status	A message is displayed on the following network where a communication error has been detected. <ul style="list-style-type: none"> • Ethernet • CC-Link IE Controller • CC-Link IE Field • Tracking
(5)	[System Switching] button	Switches the systems.

Process Control screen

This screen can be displayed by touching the [Process Control] button on the MENU screen.

On the screen, temperature control of a heater is performed. The heater is equipped with a thermocouple. The thermocouple inputs a measured temperature value to CH1 of the R60TD8-G on the slave station and outputs a 24V signal from CH1 of the RY40PT5B to perform time proportional control.

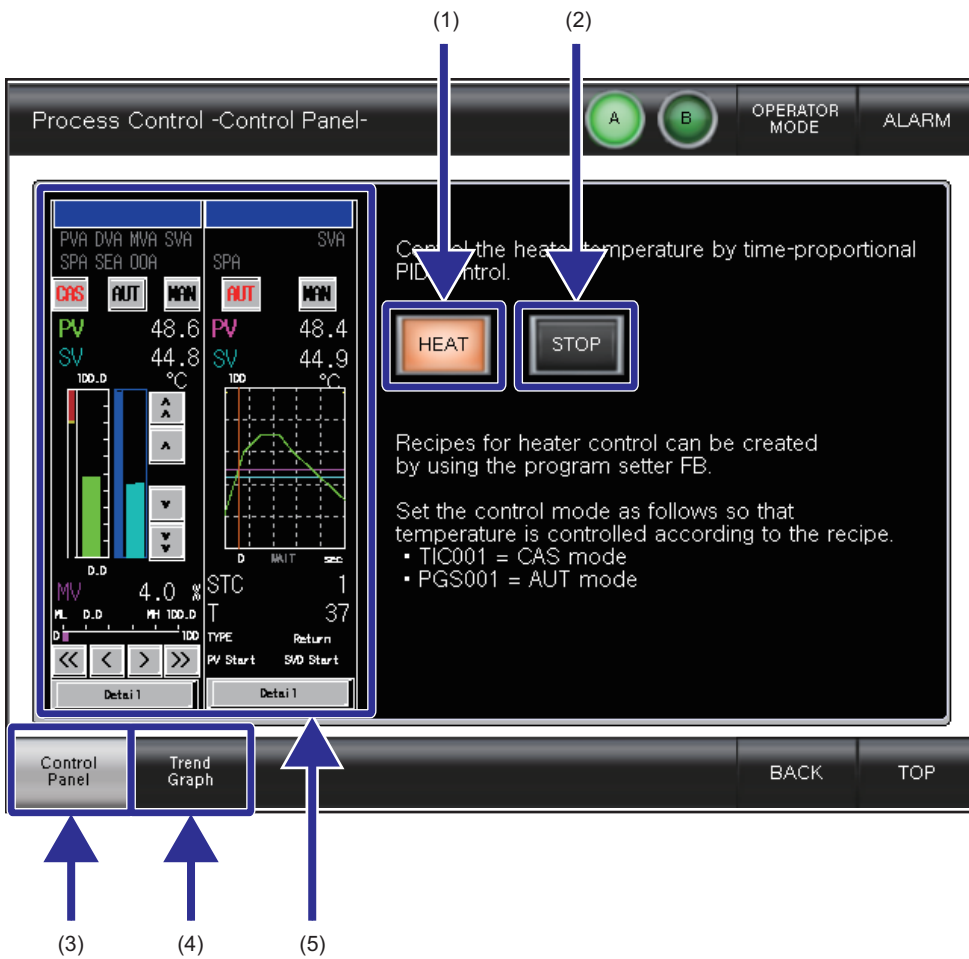

• Temperature control program

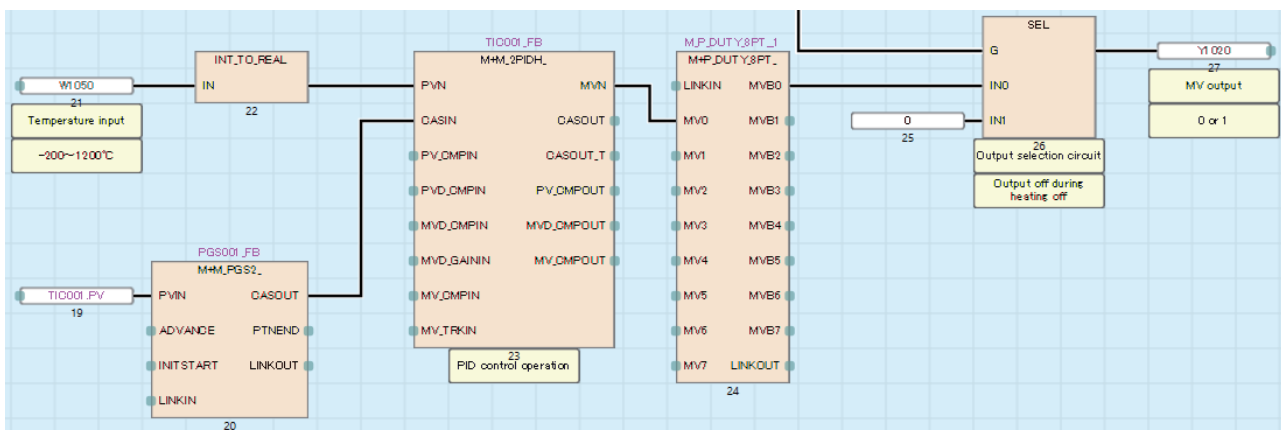

No.	Item	Description
(1)	[HEAT] button	Starts temperature control. To perform temperature control, turn on this switch first. This switch has the following interlocks. <ul style="list-style-type: none"> • Temperature high high limit (TC temperature 80°C or higher) • Communication error (Ethernet, CC-Link IE Field) • Thermocouple disconnection • Module being changed online (R60TD8-G, RY40PT5B)
(2)	[STOP] button	Stops temperature control.

No.	Item	Description
(3)	[Control Panel] button	Switches the screen to the Control Panel screen. On the Control Panel screen, the temperature control function can be turned on/off, and the faceplate can be operated.
(4)	[Trend Graph] button	Switches the screen to the Trend Graph screen. On the Trend Graph screen, the temperature control trend graph is displayed.
(5)	Faceplate	The "TIC001" and "PGS001" faceplates are displayed. For details, refer to the following. ☞ Page 45 "TIC001" faceplate ☞ Page 46 "PGS001" faceplate

■ "TIC001" faceplate

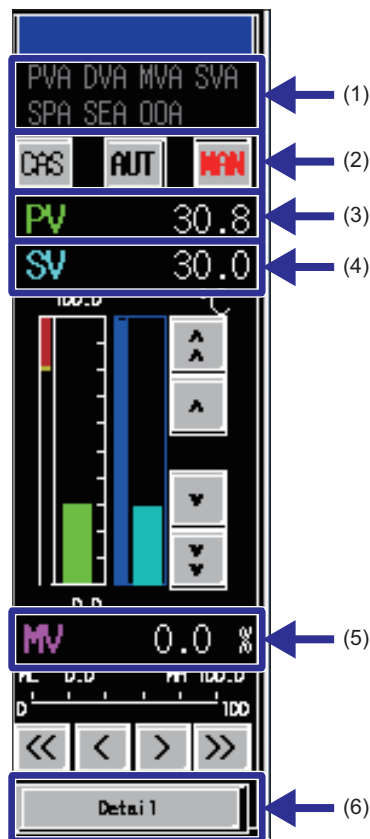

No.	Item	Description
(1)	Alarm display	Displays the alarm status. The alarm that currently occurs turns on.
(2)	Mode selector	Switches the control mode (MANUAL, AUTO, CASCADE). The current mode is indicated in red. <ul style="list-style-type: none"> CAS: CASCADE mode AUT: AUTO mode MAN: MANUAL mode
(3)	PV value	Displays the current PV value.
(4)	SV value	Displays the current SV value. The SV value can be changed in AUTO or MANUAL mode.
(5)	MV value	Displays the current MV value. The MV value can be changed in MANUAL mode.
(6)	[Detail] button	Switches the screen to the TIC001 tag tuning screen.

Touching the [Detail] button on the "TIC001" faceplate switches the screen to the TUNING screen.

Touch the [SETTING] button to switch the screen to the SETTING screen, and touch the [TUNING] button to switch the screen to the TUNING screen.

For details on the operation method, refer to the following.

📖 PX Developer Version 1 Operating Manual (GOT Screen Generator)

TUNING screen

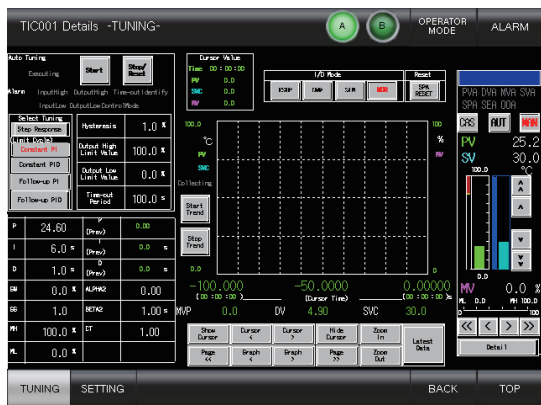

SETTING screen

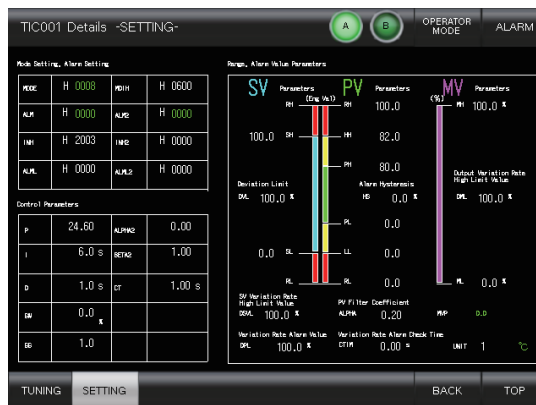

■ "PGS001" faceplate

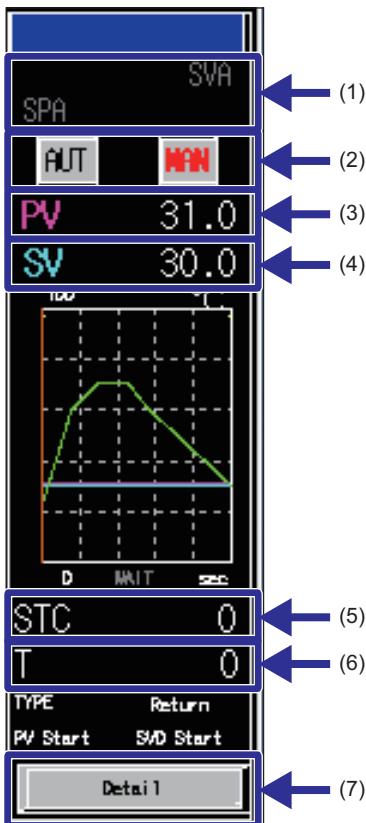

No.	Item	Description
(1)	Alarm display	Displays the alarm status. The alarm that currently occurs turns on.
(2)	Mode selector	Switches the control mode (MANUAL, AUTO). The current mode is indicated in red. <ul style="list-style-type: none"> • AUT: AUTO mode • MAN: MANUAL mode
(3)	PV value	Displays the current PV value.
(4)	SV value	Displays the current SV value. The SV value can be changed in AUTO or MANUAL mode.
(5)	STC value	Displays/changes the current step.
(6)	T value	Displays/changes the current elapsed time.
(7)	[Detail] button	Switches the screen to the PGS001 tag tuning screen.

Touching the [Detail] button on the "PGS001" faceplate switches the screen to the TUNING screen.

Touch the [SETTING] button to switch the screen to the SETTING screen, and touch the [TUNING] button to switch the screen to the TUNING screen.

For details on the operation method, refer to the following.

📖 PX Developer Version 1 Operating Manual (GOT Screen Generator)

TUNING screen

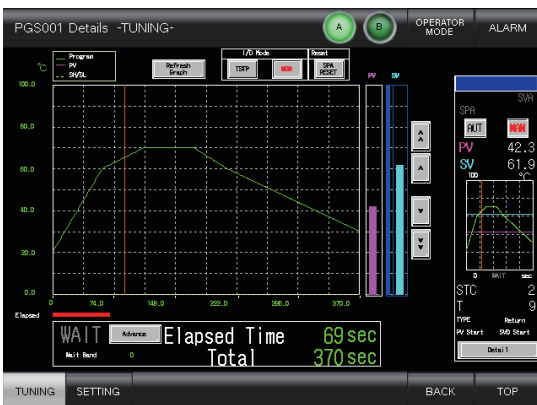

SETTING screen

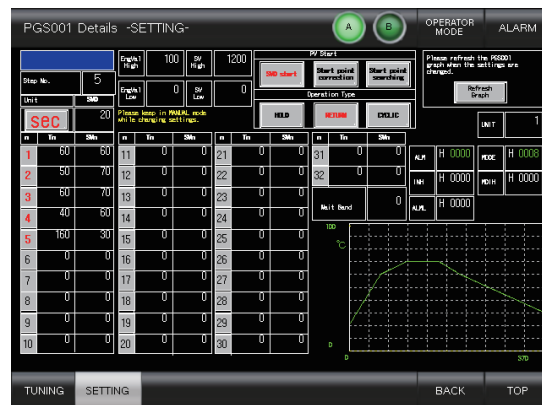

Tracking Transfer screen

This screen is displayed by touching the [Tracking Transfer] button on the MENU screen.

On the screen, the tracking transfer capacity can be switched and each scan time can be measured.

The current scan time value is the total of the tracking transfer time and the program execution time.



No.	Item	Description
(1)	Tracking Transfer Capacity	Switches the tracking transfer capacity to the value indicated on the button. The currently selected setting is indicated in green.
(2)	Current Scan Time	Displays the current scan time.
(3)	In Q Series (Reference)	Displays a theoretical scan time of when transferring the current tracking capacity in the Q series.

Online Module Change screen

This screen is displayed by touching the [Online Module Change] button on the MENU screen.

On the screen, the replacement procedure for the selected module on the slave station is displayed.

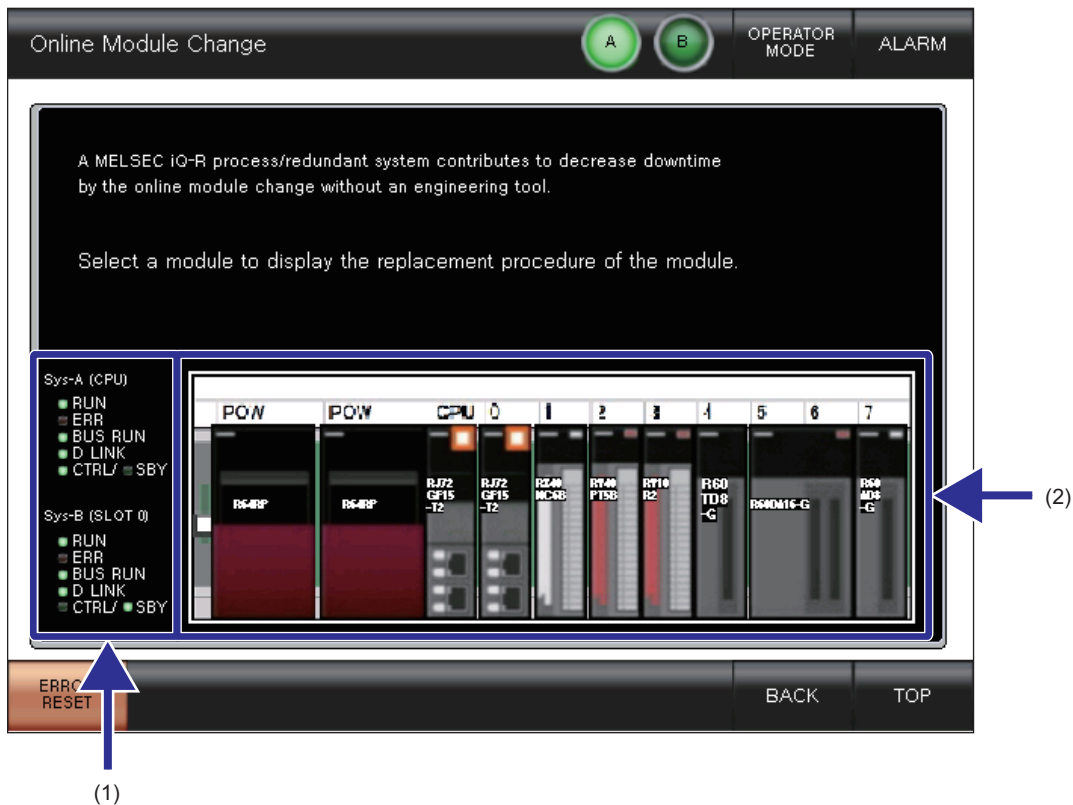

No.	Item	Description
(1)	Head module LED indication	Displays the LED status of the remote head module.
(2)	Module selector	Select a module to be replaced online. The replacement procedure for the selected module is displayed. The [NEXT] or [END] button is displayed at the bottom right of the replacement procedure screen. <ul style="list-style-type: none"> • Touch the [NEXT] button to display the next procedure. • Touch the [END] button to end the procedure. Touching the [CANCEL] button switches the screen back to the Online Module Change screen.

Auto Memory Copy screen

This screen is displayed by touching the [Auto Memory Copy] button on the MENU screen.

On the screen, the auto memory copy operation is displayed. This screen is useful when the actual module LED indicators cannot be visually checked.

During the memory copy, the MEMORY COPY LED of the redundant function module flashes in both systems.

2

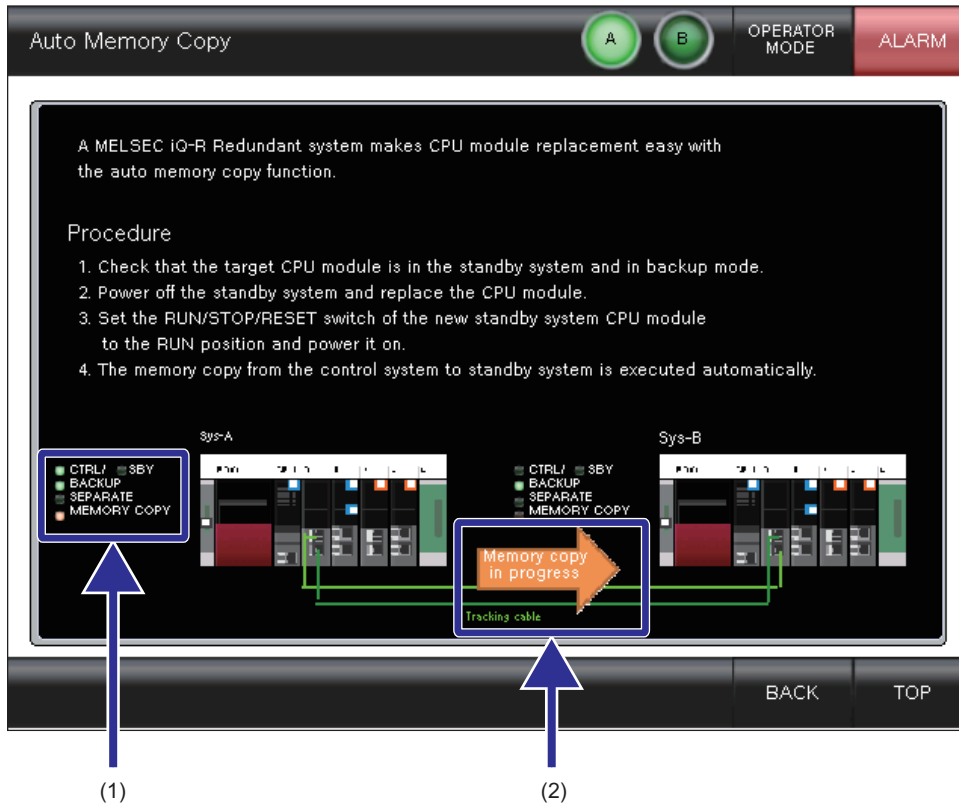

No.	Item	Description
(1)	CPU LED indication	Displays the LED status of the CPU module.
(2)	Memory copy status	A message is displayed during the memory copy.

Number of Output ON Times Integration screen

This screen can be displayed by touching the [Number of Output ON Times Integration] button on the MENU screen. On the screen, the number of output ON times of the output module with diagnostic functions (RY40PT5B) is counted. For channels where the alarm setting is "Valid", an alarm is issued when the total value exceeds the threshold.

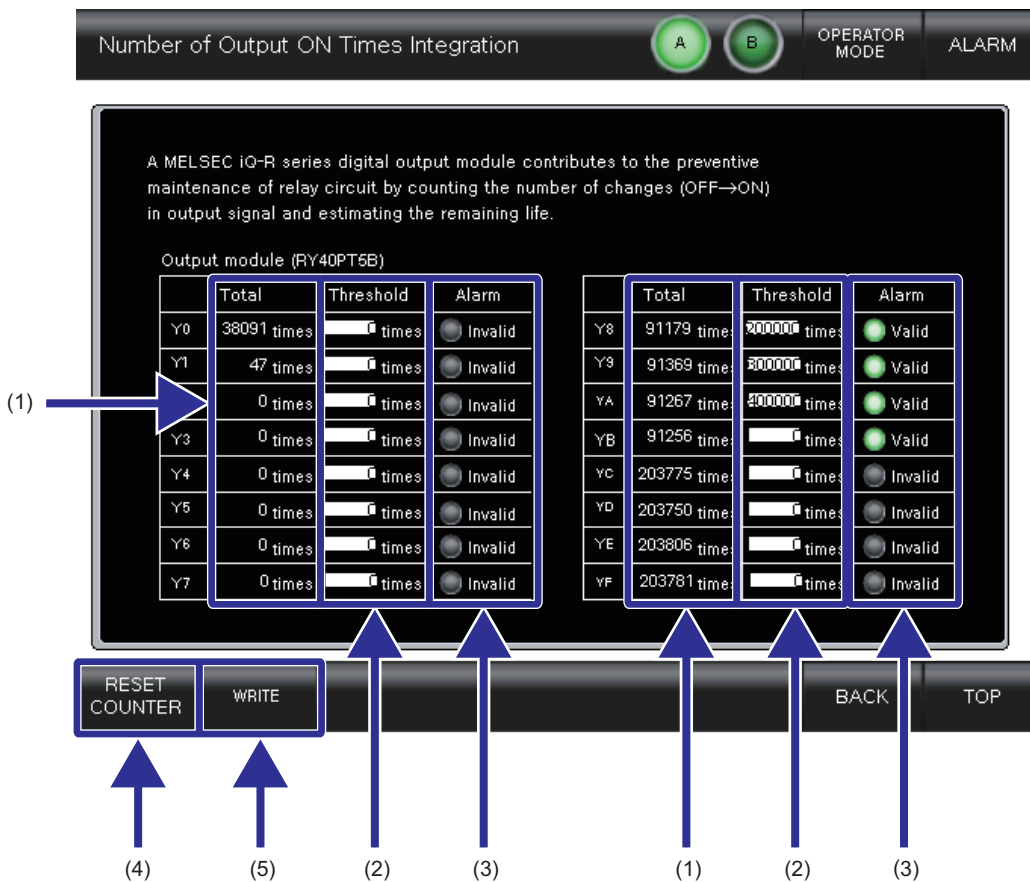

No.	Item	Description
(1)	Total	Displays the total number of output ON times for each channel.
(2)	Threshold	Set the threshold value for issuing an alarm for each channel. Touch the entry field to display the keypad, and enter a value. * Touch the [WRITE] button to write the set value to the programmable controller. The set value is not reflected if this button is not touched.
(3)	Alarm	Switches the alarm status (valid/invalid) for each channel. Touch this area of each channel to switch the alarm status. * Touch the [WRITE] button to write the set status to the programmable controller. The set status is not reflected if this button is not touched.
(4)	[RESET COUNTER] button	Resets the total value of the selected channel.
(5)	[WRITE] button	Writes the settings of "Threshold" and "Alarm" to the programmable controller. * The settings of "Threshold" and "Alarm" are not reflected to the programmable controller until this button is touched.

3 REDUNDANT SYSTEM OVERVIEW

3.1 Basic Concept and Functions of a Redundant System

Concept of 'systems' in a redundant system

System A and system B

A redundant system consists of two identical systems. One system is called 'system A' and the other is called 'system B' to distinguish two systems connected with tracking cables. The system A or B is set using the engineering tool. (📖 Page 110 Setting the system (system A or system B))

Point

When one system is set as 'system A', the other system is automatically set as 'system B', and vice versa.

Control system and standby system

In a redundant system, the CPU module of one system executes programs and controls the entire redundant system. The other system will be in the standby state and does not perform control. The system that controls the entire redundant system is called 'control system' and the system in the standby state is called 'standby system'.

The control or standby system is determined when both systems are started up and tracking communications between the two systems are established. (📖 Page 56 System determination)

Scan configurations

This section describes the scan configurations of the CPU modules in a redundant system.

In a redundant system, tracking transfer is performed in the END processing.

(MELSEC iQ-R CPU Module User's Manual (Application))

The following are the scan configurations of the CPU modules when both systems are simultaneously started up in backup mode.

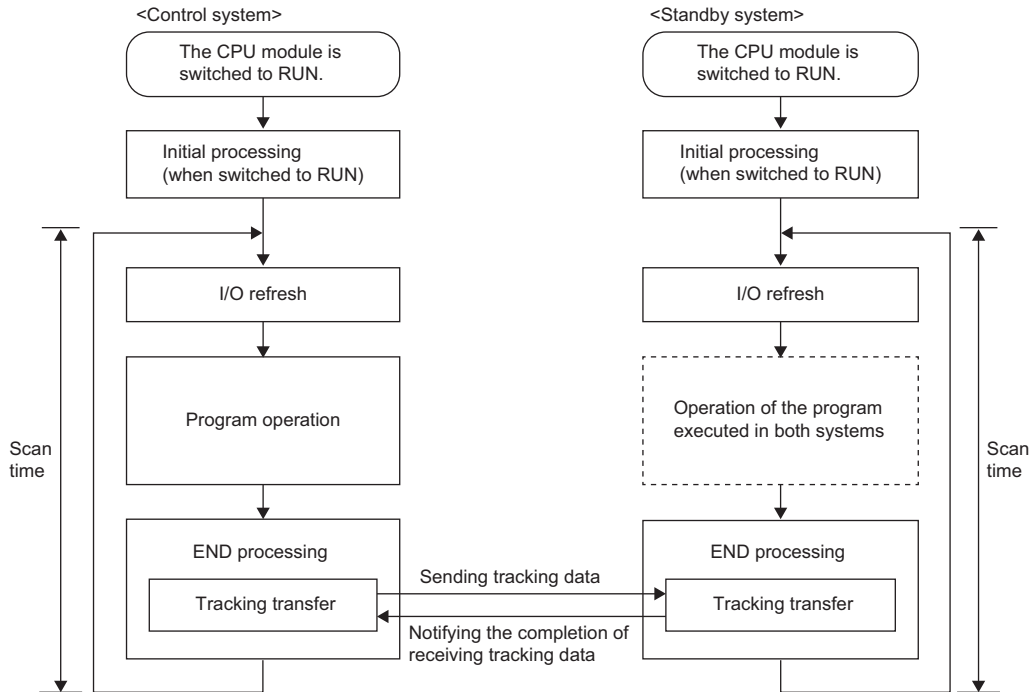

Processing differs depending on the system (control system or standby system) and the operation mode (backup mode of separate mode).

○: Performed, ×: Not performed

Processing	Backup mode		Separate mode	
	Control system	Standby system	Control system	Standby system
Initial processing/initial processing (when switched to RUN)	○	○	○*3	○*3
I/O refresh	○	○*1	○	○
Program operation	○	×*2	○	○
Tracking transfer	○	○	○	○
END processing	○	○	○	○

*1 Only the input refresh is performed. Whether to perform the output refresh or not depends on "Standby System Output Setting" of "CPU Parameter".

(MELSEC iQ-R CPU Module User's Manual (Application))

*2 This processing is not performed by default. Programs are executed according to "Both Systems Program Executions Setting" in "Program Setting" of "CPU Parameter". (Page 73 Program execution in both systems)

*3 This processing is not performed when the operation mode is switched from the backup mode to the separate mode.

System switching between control system and standby system

In a redundant system, data link is performed between the redundant function modules connected with tracking cables and data required for operation is transferred from the control system to the standby system at every scan. If an error occurs in the control system, the standby system will function as the new control system and continue operation using the data that has been received.

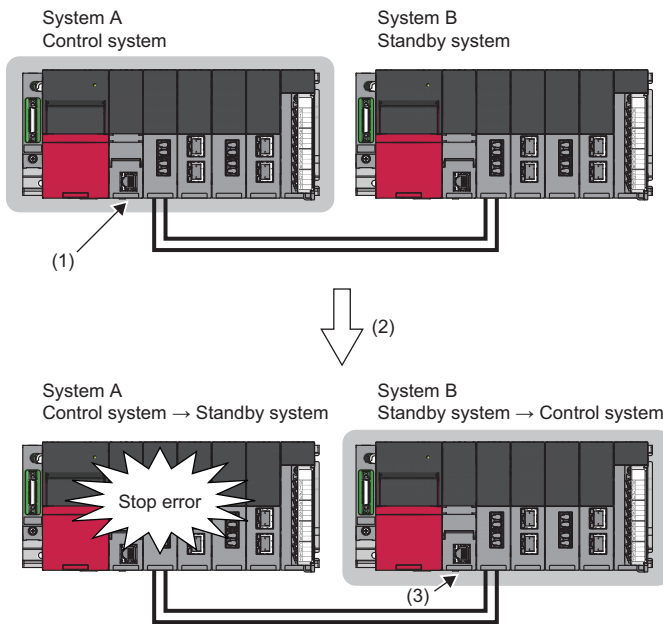

- (1) The control system is operating normally. (The control system transfers data to the standby system at every scan.)
- (2) A stop error has occurred in the control system.
- (3) The standby system functions as the new control system and continues operation using the data that has been received.

For details on the system switching, refer to the following.

📖 MELSEC iQ-R CPU Module User's Manual (Application)

Operation modes of the Process CPU

The Process CPU operates in one of the following two modes.

Process mode

A mode to use the Process CPU in a system other than a redundant system. Select "Process" for "Mode" when creating a project using the engineering tool. The Process CPU starts up in process mode.

Redundant mode

A mode to use the Process CPU in a redundant system. Select "Redundant" for "Mode" when creating a project using the engineering tool. The Process CPU starts up in redundant mode. (📖 Page 109 Creating a Project (Master Station))

Point

In a redundant system, set the redundant mode for the Process CPU in both systems.

Operation modes of a redundant system



A redundant system operates in one of the following two modes.

Operation mode	Description
Backup mode	A mode to operate a redundant system. When an error or a failure occurs in the control system, the standby system is switched to the new control system and continues operation. When a system failure occurs in the control system, the standby system can take over the control because data is transferred from the control system to the standby system at every scan.
Separate mode	A mode to perform system maintenance of a redundant system without stopping control. In separate mode, the CPU module of the control system and the CPU module of the standby system can execute different programs. In the standby system, programs can be modified and the operation of programs can be checked with the data transferred from the control system without stopping the control operation of the control system.

A redundant system starts up in backup mode. To switch the operation mode, use the engineering tool.

( MELSEC iQ-R CPU Module User's Manual (Application))

The following table summarizes the differences between the backup mode and the separate mode.

Item	Backup mode	Separate mode
Program operation	The control system executes programs. The standby system executes programs according to "Both Systems Program Executions Setting" in "Program Setting" of "CPU Parameter". The standby system does not execute programs by default. For how to change the mode to the backup mode, refer to the following.  MELSEC iQ-R CPU Module User's Manual (Application)	Both of the control system and the standby system execute programs. For how to change the mode to the separate mode, refer to the following.  MELSEC iQ-R CPU Module User's Manual (Application)
System switching	Both automatic system switching and manual system switching are supported.	Only manual system switching is supported.
Tracking transfer	Data is transferred according to "Tracking Setting" of "CPU Parameter".	Data is transferred according to "Tracking Setting" of "CPU Parameter". However, the following data is not transferred. <ul style="list-style-type: none"> • Local devices, local labels • Special relay, special register • PID control instruction information • Signal flow memory
Memory copy from control system to standby system	The following copy operations can be performed. <ul style="list-style-type: none"> • Auto memory copy • Memory copy using the engineering tool • Memory copy using the special relay and special register 	The following copy operations can be performed. <ul style="list-style-type: none"> • Memory copy using the engineering tool • Memory copy using the special relay and special register
System consistency check	The system consistency is checked.	The system consistency is not checked.
Program execution type	■When the operation mode is changed to the backup mode The control system and the standby system take over the program execution type before the operation mode change.	■When the operation mode is changed to the separate mode The operation differs between the control system and the standby system. <ul style="list-style-type: none"> • The control system takes over the program execution type before the operation mode change. • The standby system executes the program with the execution type specified in the CPU parameter.
Interrupt program execution enable/disable status	■When the operation mode is changed to the backup mode The control system and the standby system take over the interrupt program execution enable/disable status before the operation mode change.	■When the operation mode is changed to the separate mode The operation differs between the control system and the standby system. <ul style="list-style-type: none"> • The control system takes over the interrupt program execution enable/disable status before the operation mode change. • The standby system can no longer execute interrupt programs.
I/O refresh	The output (Y) refresh of the standby system depends on "Standby System Output Setting" of "CPU Parameter". The output (Y) of the standby system is not refreshed by default.	Even if "Standby System Output Setting" is set to "Disable" in "CPU Parameter", the output (Y) of the standby system is enabled.
Link refresh	In the standby system, data is not refreshed from devices of the CPU module to link devices.	In the standby system, data is refreshed from devices of the CPU module to link devices (only the link special relay (SB) and link special register (SW)). (CC-Link is excluded.)
Writing data to the programmable controller	Data can be simultaneously written to both systems. Or, data can be written to only a system specified in the connection destination setting.	Data can be written to only a system specified in the connection destination setting.

Item	Backup mode	Separate mode
Remote operation function	Remote operations can be performed on both systems.	Remote operations by the engineering tool can be performed only on a system specified in the connection destination setting.
Time synchronization	Time of the standby system is synchronized with that of the control system.	Time is not synchronized.

System determination

This section describes how the control or standby system is determined.

When both systems are started up

The control or standby system is determined as described below.

■Determination method

The control or standby system is determined when both systems are started up by powering on or resetting the system and tracking communications between the two systems are established.

- When both systems are simultaneously started up

The system A will be 'control system' and the system B will be 'standby system'.

"Simultaneously" here means when one system is started up within three seconds of the other.

- When the system A or the system B is started up first

The started system will enter the state that waits for the other system to start in three seconds. (👉 Page 58 State that waits for the other system to start)

When tracking communications between the two systems are established, the system A will be 'control system' and the system B will be 'standby system'.

■Check method

Check the LED status of the redundant function module to check which system is the control system.

System	LED status of the redundant function module
Control system	
Standby system	

Point

Users can also check which system is the control system using the engineering tool. (📖 GX Works3 Operating Manual)

- System monitor
- Monitor status bar

■Precautions

- If the system A/B setting has not been set or the same system A/B setting has been set

A stop error occurs. To determine the control and standby systems, properly set the system A/B setting for both systems.

- If both systems are restarted when a stop error has occurred in the standby system (system A)

A stop error may occur in both systems.

If the stop error cause of the system A is a program error, a stop error occurs in the system A again after the systems are restarted. Even if the system B normally operates as the control system before the restart, a stop error also occurs in the system B if a file mismatch is detected in the system consistency check after the restart. As a result, a stop error occurs in both systems.

In this case, eliminate the cause of the error that has occurred in the system A, and restart both systems.

- When the READY LED of the CPU module in one of the systems is flashing

Do not power off the other system.

The system may start up without checking the system consistency even when a mismatch exists between the two systems.

(📖 MELSEC iQ-R CPU Module User's Manual (Application))

- If the system configurations differ between the two systems (for example, the insertion status of an SD memory card)

It may take time to start communications between the two systems. Check that the system configuration is the same between the two systems following the procedure for starting up both systems simultaneously, and then start up the redundant system.

(👉 Page 36 Starting up both systems simultaneously)

- When an SD memory card is used

Do not power off the system, reset the CPU module, or remove the SD memory card during an access to the SD memory card. A stop error may occur in both systems and the systems may not be started as a redundant system.

If the system is powered off, the CPU module is reset, or the SD memory card is removed during an access to the SD memory card, the data in the SD memory card may corrupt. In this case, the SD memory card diagnostics (such as a file system check and restoration processing) is performed when the system is powered off and on or reset.

During the SD memory card diagnostics, tracking communications are disabled. If the SD memory card diagnostics of the other system does not complete within the timeout period set in "Other system Start-up Timeout Setting", a stop error occurs in the own system. In this case, a stop error occurs in the other system as well. As a result, a stop error occurs in both systems and the systems cannot be started as a redundant system. Restart both systems.

Point

If the SD memory card diagnostics of the other system takes time, only the own system can be started up. ( MELSEC iQ-R CPU Module User's Manual (Application))

When only one system is started up

Only one system, system A or system B, can be started up as the control system.

■Start-up method

To start up one system as the control system, perform one of the following operations to the CPU module that is waiting for the other system to start.

- Online operation

Perform the following operation on the engineering tool.

 [Online] ⇒ [Redundant PLC Operation] ⇒ [Redundant Operation]

Select "Forced Start of Control System while Waiting for Other System to Start", and click the [Execute] button.

- Switch operation

Set the RUN/STOP/RESET switch of the CPU module to RUN → STOP → RUN.

Set "Control System Start-up Setting (Switch Operation)" to "Enable" in the CPU parameter in advance. ( MELSEC iQ-R CPU Module User's Manual (Application))

- Operation with the input (X)

Turn on the input (X) set in the parameter.

Set "Control System Start-up Setting (Input (X))" to "Enable" in the CPU parameter in advance. ( MELSEC iQ-R CPU Module User's Manual (Application))

■State that waits for the other system to start

If tracking communications with the other system cannot be established when the Process CPU (redundant mode) is started up, the CPU module enters the state that waits for the other system to start in three seconds.

The CTRL LED and the SBY LED of the redundant function module turn off because the control system cannot be determined at this point. In addition, the BACKUP LED of the redundant function module flashes because a system switching disable cause exists.

After tracking communications with the other system is established, the control system is determined and the system switching disable cause is eliminated.

- Operation of the CPU module in the state that waits for the other system to start

Even when the RUN/STOP/RESET switch of the CPU module is set to the RUN position, the CPU module will be in the STOP state while it is in the state that waits for the other system to start because the control system has not been determined yet.

The CPU module does not execute programs.

The following table lists the refresh operations to be performed while the CPU module is in the state that waits for the other system to start.

Type	Operation
I/O refresh	Only the input refresh is performed. The output refresh is not performed.
Network module link refresh	Data is refreshed from the network module to the CPU module and from the CPU module to the network module (SB/SW). Data is not refreshed from the CPU module to the network module (other than SB/SW).
Intelligent function module refresh	Data is refreshed between the intelligent function module and the CPU module.

- Timeout of the state that waits for the other system to start

Time measurement starts for the state that waits for the other system to start upon completion of the initial processing.

Set the timeout time in "Other system Start-up Timeout Setting" of "CPU Parameter". (📖 MELSEC iQ-R CPU Module User's Manual (Application))

When a timeout is detected, a stop error occurs. To not to generate a stop error, set "Other system Start-up Timeout Setting" of "CPU Parameter" to "Not Set".

Precautions

- To start up the system that is waiting for the other system to start as the control system, check that the other system is not operating as the control system.
- When tracking communications are established by connecting tracking cables and powering on or resetting the other system, the CPU module that has been waiting for the other system to start enters the RUN state and starts executing programs. For this reason, check that program execution by the CPU module does not cause any problems before connecting tracking cables and starting up the other system.
- If a stop error has occurred in the other system when tracking communications are established between the two systems, a stop error occurs in the CPU module that has been waiting for the other system to start as well. In this case, take action against the error of the other system, and power off and on or reset both systems.
- When tracking communications cannot be established due to power-off of the other system or a problem with tracking cables, the CPU module enters the state that waits for the other system to start. Check that the other system is powered on and there is no problem with tracking cables.
- Do not remove the SD memory card or power off or reset the system during an access to the SD memory card.

When the previous control system is started up as the control system

In a redundant system, when both systems are simultaneously started up, the system A always will be the control system. Even when both systems are temporarily powered off due to a power failure or other causes while the system B is operating as the control system, the system A will start up as the control system when both systems are powered on.

To start up the system B, which was operating as the control system before power-off, as the control system again, use SM1636 (Previous control system identification flag) in the program.

Note that if a network module is included in the system, wait until the network module of the other system starts up, and execute the SP.CONTSW instruction.

Program example

The following program switches the system B from the standby system to the control system by executing a system switching instruction when the operating status of the CPU module in the system A is changed to RUN for the first time.

Turn on SM1646 (System switching by a user) in advance.



Operation

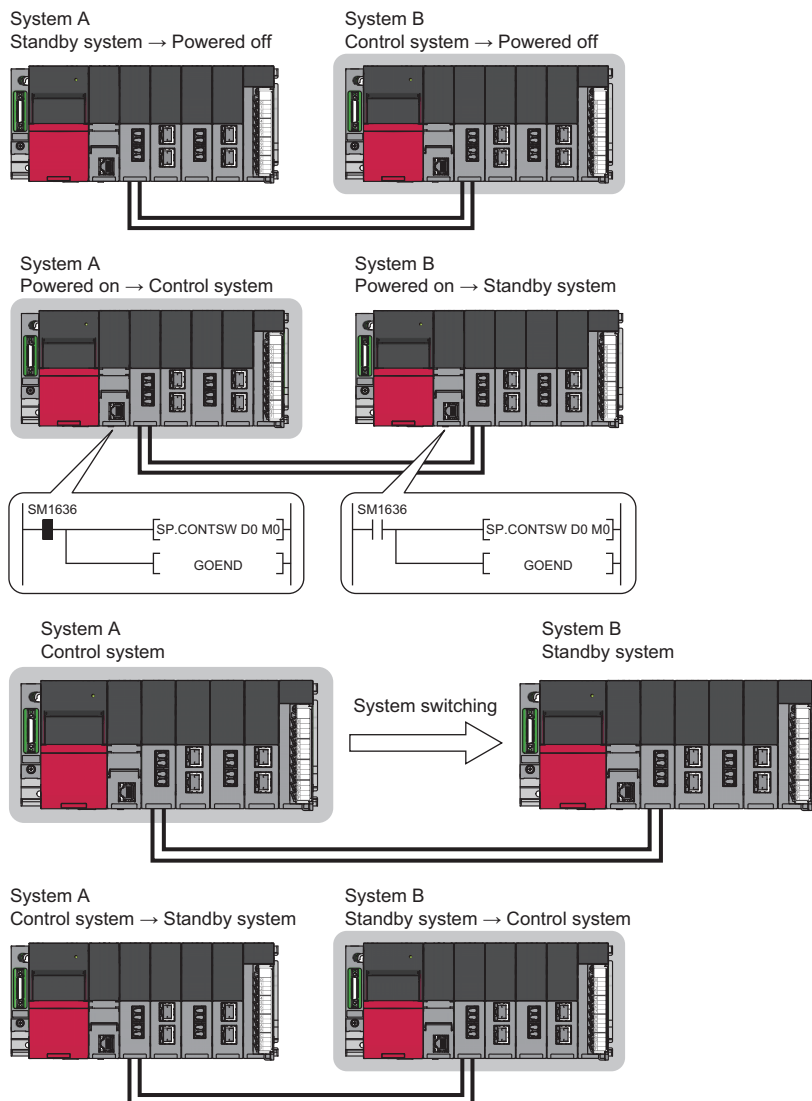

1. Both systems are temporarily powered off due to a power failure or other causes while the system B is operating as the control system.
2. When both systems are powered on, the system A starts up as the control system. SM1636 turns on for only one scan after the operating status of the CPU module has changed to RUN.
3. The systems are switched by the SP.CONTSW instruction.
4. The system B is switched from the standby system to the control system.

State transition of a redundant system

The following figure shows the state transition of a redundant system after start-up based on the operation mode change and system switching.

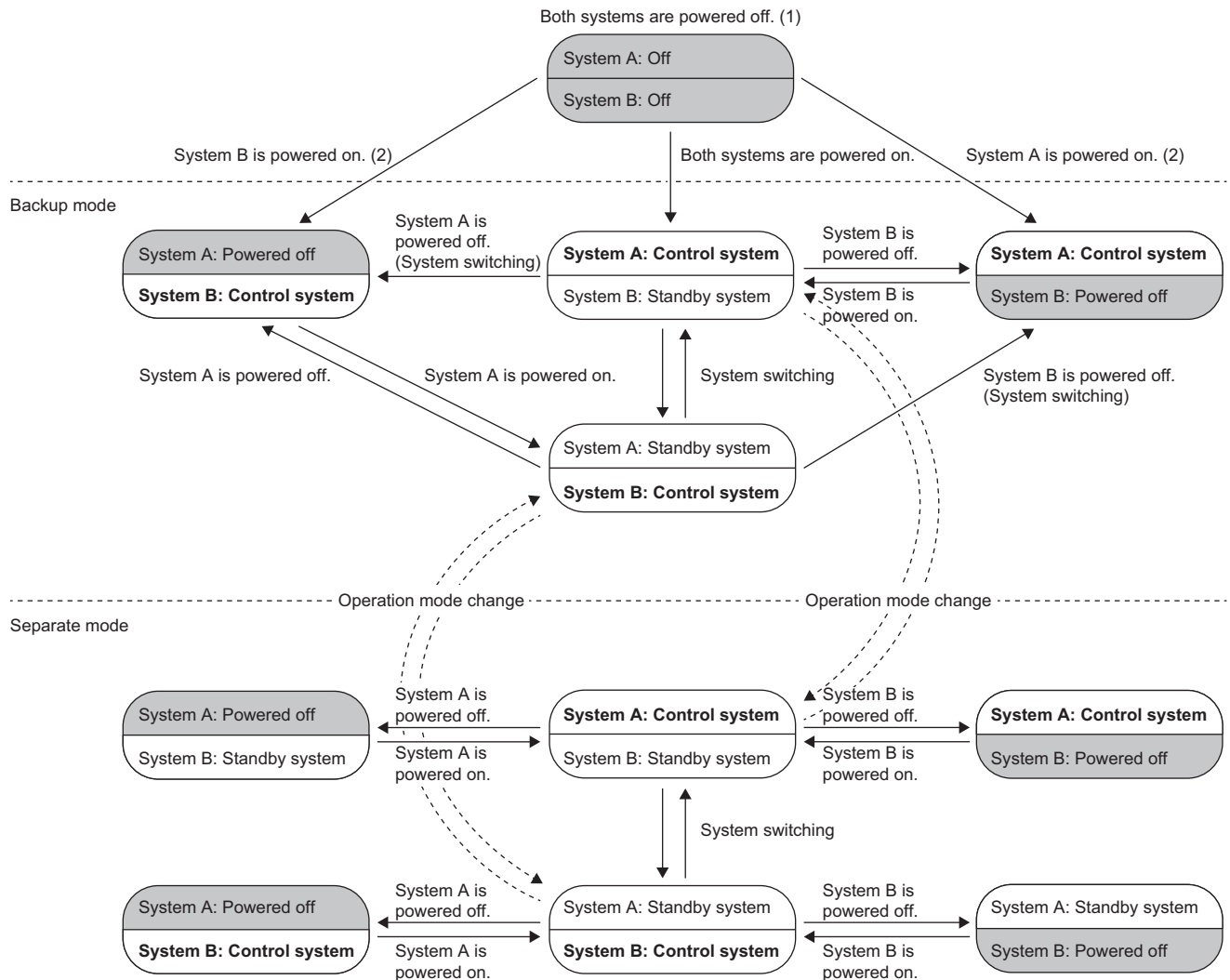

(1) When both systems are powered off, both systems transition to the power-off state regardless of the operation mode or system type.

(2) A system that is powered on starts up as the control system. (Page 57 When only one system is started up)

System consistency check

This function checks whether the system configuration and files in the CPU module are the same between the control system and the standby system when the redundant system is in backup mode.

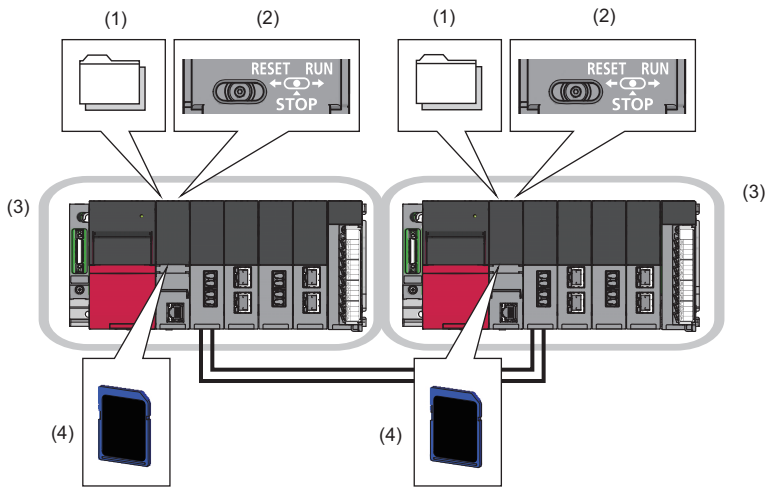

The function checks the following items.

No.	Item	Description
(1)	Files	Parameter file, program file, and other files
(2)	Operating status	Operating status of the CPU module (RUN/STOP/PAUSE)
(3)	Modules on the main base unit	CPU module and other modules mounted on the main base unit
(4)	SD memory card	Insertion status of an SD memory card and status of the write protect switch

Execution timing

The following table lists the execution timing of the system consistency check.

Item	Execution timing
Files	<ul style="list-style-type: none"> • When both systems are simultaneously powered on or reset • When the other system is powered on or reset while one system is waiting for the other system to start • When the standby system is powered on or reset while the control system is operating • When the operation mode is changed to the backup mode • When the operating status of the CPU module is switched from STOP to RUN • When the END processing is performed • When the online program change is completed • When the systems are switched • When tracking cables are reconnected
Operating status*1	<ul style="list-style-type: none"> • When the standby system is powered on or reset while the control system is operating • When the operation mode is changed to the backup mode • When the operating status of the CPU module is switched from STOP to RUN • When the END processing is performed • When tracking cables are reconnected
Modules on the main base unit	<ul style="list-style-type: none"> • When both systems are simultaneously powered on or reset • When the other system is powered on or reset while one system is waiting for the other system to start • When the standby system is powered on or reset while the control system is operating • When the operation mode is changed to the backup mode • When tracking cables are reconnected
SD memory card	<ul style="list-style-type: none"> • When both systems are simultaneously powered on or reset • When the other system is powered on or reset while one system is waiting for the other system to start • When the standby system is powered on or reset while the control system is operating

*1 Checking the operating status can be disabled in "Backup Mode Setting" of "Redundant Behavior Setting". (MELSEC iQ-R CPU Module User's Manual (Application))

The function is not executed in the following cases.

- One of the systems has not started up (powered off, reset, or initial processing being performed).
- A stop error has occurred in the CPU module.
- The redundant system is in separate mode.
- The memory copy is being executed.

Files

Whether files are the same between the control system and the standby system is checked.

The following table lists the files used by the CPU module together with their check status.

○: Checked, ×: Not checked, —: Cannot be stored

File type	Check target memory	
	CPU built-in memory	SD memory card ^{*3}
Program ^{*1}	○	×
FB file ^{*1}	○	×
CPU parameter	○	×
System parameter	○	×
Module parameter	○	×
Module extension parameter	○	○
Module-specific backup parameter	×	×
Memory card parameter	—	○
Device comment	×	×
Initial device value	○	○
Global label setting file	○	×
Initial label value file	Initial global label value file	○
	Initial local label value file	○
File register ^{*2}	○	×
Event history	×	×
Device data storage file	×	×
General-purpose data	×	×
Data logging setting file	Common setting file	—
	Individual setting file	×
Remote password	○	×

*1 The reserved area for online change and the program restoration information write status are also checked. (MELSEC iQ-R CPU Module User's Manual (Application))

*2 Whether a file exists or not is checked. The file contents are not checked.

*3 Files are not checked at the point when an SD memory card is inserted during operation.

■When a mismatch is detected

A stop error occurs in the CPU module of the standby system.

Perform either of the following operations to match the files in the CPU modules of both systems.

- Write files to the CPU modules of both systems.
- Execute the memory copy function to match the files stored in both systems. (Page 65 Memory copy from control system to standby system)

Operating status

Whether the operating status (RUN/STOP/PAUSE) of the CPU module is the same between the control system and the standby system is checked.

■When a mismatch is detected

A continuation error occurs in the CPU module of the standby system. In addition, the BACKUP LED of the redundant function module flashes in both systems because a system switching disable cause exists.

■Backup mode setting

To not to generate a continuation error when the operating status is switched during operation, checking the operating status can be disabled.

When disabled, a continuation error will not occur in the CPU module of the standby system even when the operating status of the CPU module differs in the two systems.

 [CPU Parameter] ⇒ [Redundant System Settings] ⇒ [Redundant Behavior Setting]

Window

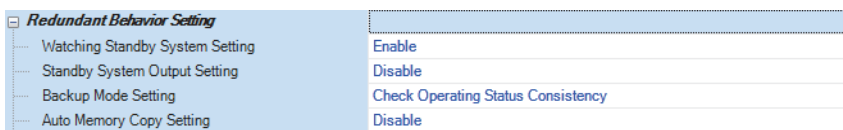

Displayed items

Item	Description	Setting range	Default
Backup Mode Setting	Set whether to check the operating status consistency between the two systems or not when the redundant system is in backup mode.	<ul style="list-style-type: none">Do Not Check Operating Status ConsistencyCheck Operating Status Consistency	Check Operating Status Consistency

Modules on the main base unit

Whether the following items are the same between the control system and the standby system is checked.

- Model of the CPU module
- Model and type of modules mounted on each slot

■When a mismatch is detected

A stop error occurs in the CPU module of the standby system. If a stop error is detected when both systems are simultaneously powered on or reset, a stop error occurs in the CPU module of the control system as well.

("Simultaneously" here means when one system is started up within three seconds of the other.)

SD memory card

Whether the insertion status of an SD memory card and the status of the write protect switch are the same between the control system and the standby system is checked. The type and capacity of an SD memory card is not checked.

Point

The insertion status of an SD memory card is checked even when only the standby system is powered off and on or reset while the control system is operating. When an SD memory card is used, it is recommended to remove it only when necessary.

■When a mismatch is detected

A stop error occurs in the CPU module of the standby system. If a stop error is detected when both systems are simultaneously powered on or reset, a stop error occurs in the CPU module of the control system as well.

Memory copy from control system to standby system

This function transfers data, such as programs and parameters, of the CPU module in the control system to the CPU module in the standby system to match the memory data between the two CPU modules.

Ex.

Replacing the CPU module of the standby system using this function

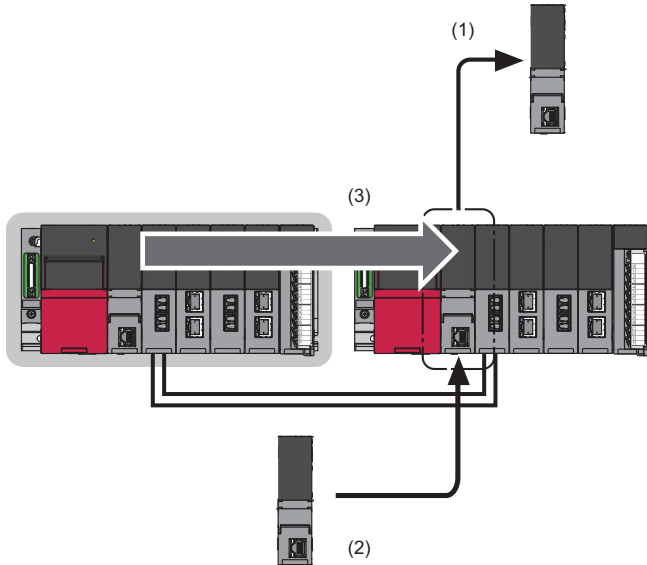

(1) Remove the CPU module of the standby system.

(2) Mount a new CPU module.

(3) Execute the memory copy function to match the memory data between the two CPU modules.

Data in the following memory is copied.

- Program memory
- Device/label memory (only the file register file area)
- Data memory (only the files in the system folder (\$MELPRJ\$))
- SD memory card (only the files in the system folder (\$MELPRJ\$))

Data is copied only when data in the memory differs between the control system and the standby system. When data is the same between the two systems, data is not copied.

Point

For the module replacement method and the maintenance procedure using this function, refer to the following.

☞ Page 189 MAINTENANCE AND INSPECTION OF A REDUNDANT SYSTEM

Files to be copied

The following table lists the files to be copied by the memory copy function.

○: Copied, ×: Not copied, —: Cannot be stored

File type	Copy target memory			
	CPU built-in memory			SD memory card
	Program memory	Device/label memory	Data memory	
Program	○	—	○	○
FB file	○	—	○	○
CPU parameter	—	—	○	○
System parameter	—	—	○	○
Module parameter	—	—	○	○
Module extension parameter	—	—	○	○
Module-specific backup parameter	—	—	×	×
Memory card parameter	—	—	—	○
Device comment	—	—	○	○
Initial device value	—	—	○	○
Global label setting file	—	—	○	○
Initial label value file	Initial global label value file	—	○	○
	Initial local label value file	—	○	○
File register	—	○	—	×
Event history	—	—	×	×
Device data storage file	—	—	○	×
General-purpose data	—	—	×	×
Data logging setting file	Common setting file	—	—	○
	Individual setting file	—	○	○
Remote password	—	—	○	○

Point

When the memory copy function is executed, the memory of the standby system, where data is different from that of the control system, is initialized first, and then files are copied. (☞ Page 72 Precautions)

For this reason, files that cannot be copied, such as an event history file, will be deleted from the memory of the CPU module in the standby system. Back up the files before executing the function if necessary.

■When the security key authentication function is used

The security key of the CPU module is not copied to the standby system. Write the security key from the personal computer where the security key is registered after completion of the memory copy.

If the memory copy is executed using the CPU module with the security key written, the program file and its security key are copied but the security key of the CPU module is not copied. If the replaced CPU module is started up without writing the security key after completion of the memory copy, an error occurs in the CPU module because the security keys do not match between the program file and the CPU module.

Point

If the security key of the CPU module is written to an extended SRAM cassette, the replaced CPU module can take over the security key by simply inserting the extended SRAM cassette to which the security key has been written. In this case, writing the security key to the replaced CPU module after completion of the memory copy is not required.

Execution methods

There are three methods for executing the memory copy.

Method	Description	Application
Auto memory copy	The system automatically executes the memory copy. CPU parameter settings are required in advance.	For executing the memory copy without using an engineering tool or an external device (such as a GOT)
Memory copy using the engineering tool	The memory copy is executed by an online operation of the engineering tool connected to the CPU module of the control system.	For executing the memory copy using the engineering tool
Memory copy using the special relay and special register	The memory copy is executed by operations of the special relay and special register.	For executing the memory copy using an external device (such as a GOT)

3

Execution conditions

The memory copy can be executed regardless of the operating status (RUN, STOP, PAUSE, stop error) of the CPU module in both control and standby systems.

The auto memory copy can be executed only when the redundant system is in backup mode.

Auto memory copy

The execution procedure for the auto memory copy is described below.

The auto memory copy is executed when the standby system is powered off and on or reset while the control system is operating.

Point

- The auto memory copy needs to be set in the CPU parameter in advance. For this reason, consider whether to use the auto memory copy or not when determining the maintenance policy in the system design phase.
- The auto memory copy is executed when the parameter has been set for the CPU module of the control system. Even when the parameter has not been set for the CPU module of the standby system, the auto memory copy is executed when the parameter has been set for the CPU module of the control system.

Parameter

To execute the auto memory copy, set "Auto Memory Copy Setting" to "Enable" in the CPU parameter.

[CPU Parameter] ⇒ [Redundant System Settings] ⇒ [Redundant Behavior Setting]

Window

Redundant Behavior Setting	
Watching Standby System Setting	Enable
Standby System Output Setting	Disable
Backup Mode Setting	Check Operating Status Consistency
Auto Memory Copy Setting	Disable

Displayed items

Item	Description	Setting range	Default
Auto Memory Copy Setting	Set whether to enable the auto memory copy function or not.	<ul style="list-style-type: none"> • Disable • Enable 	Disable

Restriction

- When the control system and the standby system are simultaneously powered on, the auto memory copy is not executed.
- The CPU module of the standby system does not perform boot operation using an SD memory card, but operates based on the files copied by the auto memory copy. However, when the auto memory copy cannot be executed due to a communication error or other causes at power-on or reset of the standby system, the CPU module of the standby system operates with the files transferred by the boot operation.

Execution procedure

1. When the redundant system is in separate mode, switch the operation mode to the backup mode. (MELSEC iQ-R CPU Module User's Manual (Application))

2. Power off and on or reset the standby system. The system executes the memory copy. During the memory copy, the MEMORY COPY LED of the redundant function module flashes (in 200ms intervals) in both systems.

Control system

Standby system

MEMORY COPY 

MEMORY COPY 

3. The standby system is automatically reset and restarted, and the memory copy is completed. The MEMORY COPY LED turns off in both systems.

Control system

Standby system

MEMORY COPY

MEMORY COPY

Memory copy using the engineering tool

The execution procedure for the memory copy using the engineering tool is described below.

■ Execution procedure

1. Connect the engineering tool to the CPU module of the control system.
2. Open the "Redundant Operation" window of the engineering tool.

 [Online] ⇒ [Redundant PLC Operation] ⇒ [Redundant Operation]

3. Select "Memory Copy" in the "Redundant Operation" window, and click the [Execute] button. During the memory copy, the MEMORY COPY LED of the redundant function module flashes (in 200ms intervals) in both systems.

Control system

Standby system

MEMORY COPY 

MEMORY COPY 

4. When the memory copy is completed, the MEMORY COPY LED turns off in the control system and turns on in the standby system.

Control system

Standby system

MEMORY COPY

MEMORY COPY 

5. Power off and on or reset the standby system. The MEMORY COPY LED turns off in the standby system.

Control system

Standby system

MEMORY COPY

MEMORY COPY

Memory copy using the special relay and special register

The execution procedure for the memory copy using the special relay and special register is described below.

■Special relay to be used

The memory copy function uses the following special relay areas.

SM number	Name
SM1653	Memory copy start
SM1654	Memory copy being executed
SM1655	Memory copy completion
SM1656	Auto memory copy

For details on the special relay (SM), refer to the following.

MELSEC iQ-R CPU Module User's Manual (Application)

■Special register to be used

The memory copy function uses the following special register areas.

SD number	Name
SD988*1	Memory copy completion status (latch)
SD1653	Memory copy destination I/O number
SD1654	Memory copy completion status

*1 This is a latch area. Even when the system is powered off and on or reset, the result of the memory copy executed immediately before power-on or reset can be checked.

For details on the special register (SD), refer to the following.

MELSEC iQ-R CPU Module User's Manual (Application)

■Execution procedure

To execute the memory copy using the special relay and special register, use the special relay and special register of the CPU module in the control system.

1. Check that SM1654 (Memory copy being executed) and SM1655 (Memory copy completion) are off.
 - When SM1654 is on, the memory copy is being executed. Another memory copy cannot be started until the current memory copy is completed.
 - When SM1655 is on, the memory copy using the special relay and special register cannot be started. Turn off SM1655, and execute the memory copy.
2. Store 03D1H (CPU module of the standby system) in SD1653 (Memory copy destination I/O number).
3. Turn on SM1653 (Memory copy start) to execute the memory copy. During the memory copy, the MEMORY COPY LED of the redundant function module flashes (in 200ms intervals) in both systems.

Control system

Standby system

MEMORY COPY

MEMORY COPY

4. When the memory copy is completed, the MEMORY COPY LED turns off in the control system and turns on in the standby system.

Control system

Standby system

MEMORY COPY

MEMORY COPY

5. Power off and on or reset the standby system. The MEMORY COPY LED turns off in the standby system.

Control system

Standby system

MEMORY COPY

MEMORY COPY

■ Operation of the special relay and special register

The following chart shows the operation of the special relay and special register.

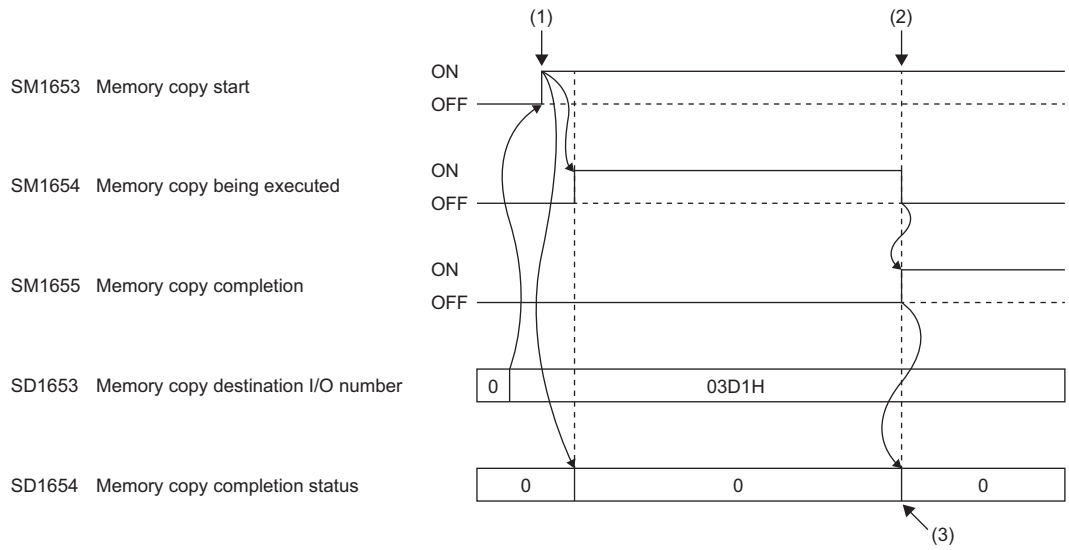

- (1) The memory copy starts.
- (2) The memory copy is completed.
- (3) When the memory copy is successfully completed, 0 is stored. When it is completed with an error, an error code is stored.

Precautions

The following are the precautions for the memory copy function.

■Auto memory initialization

When data in the data memory or the SD memory card differs between the control system and the standby system, the "\$MELPRJ\$" folder in the data memory or the SD memory card is deleted first, and then the memory copy is executed.

When data in the program memory or the device/label memory differs between the control system and the standby system, the program memory or the device/label memory is initialized first, and then the memory copy is executed.

Therefore, when the memory copy using the engineering tool or using the special relay and special register is executed, the ERROR LED of the CPU module may flash in the standby system. This is, however, not an error. Power off and on or reset the standby system, following the procedure.

In addition, back up the data that is stored in the "\$MELPRJ\$" folder but cannot be copied, such as an event history file, before executing the memory copy.

■Restrictions on memory copy execution

Do not execute the memory copy in the following cases.

- The CPU module of the standby system is powered off or being reset.
- The initial processing (when switched to RUN) is being performed.
- The tracking cable has an error or is not connected.
- The redundant function module has an error.
- The two systems cannot perform communications via the redundant function module.
- The model of the CPU module in the control system differs from that of the CPU module in the standby system.
- An online operation is being performed by the engineering tool.
- The systems are being switched.
- A module (a redundant function module or any module of the standby system) is being changed online.
- The redundant system is in separate mode. (Restriction for the auto memory copy)
- The CPU module is set as the standby system.
- The memory copy is being executed.
- A value other than 03D1H is stored in SD1653. (Restriction for the memory copy using the special relay and special register)
- The control system CPU module to which the program restoration information is not written has executed the memory copy to the standby system CPU module that does not support the program restoration information write selection.

■Restrictions during memory copy execution

Do not execute the following operations during memory copy execution.

- Online operation by the engineering tool
- RUN/STOP/RESET switch operation
- Removing the SD memory card
- Online module change
- Powering off or resetting the systems
- Disconnecting tracking cables

■Errors during memory copy execution

When the memory copy is completed with an error, the MEMORY COPY LED of the redundant function module turns off in the control system and the MEMORY COPY LED flashes (in 1s interval) in the standby system. In this case, the memory copy has not been normally executed to the CPU module of the standby system.

Check the error code stored in SD1654 (Memory copy completion status), eliminate the error cause, and execute the memory copy again. (📖 MELSEC iQ-R CPU Module User's Manual (Application))

Program execution in both systems

This function detects an error in the external device or network of the systems (control system and standby system) respectively by executing a program that diagnoses external devices and networks in both systems.

When "Both Systems Executions" is set to a program in "Both Systems Program Executions Setting", the program is executed by the CPU modules of both systems.

Ex.

When an error is detected in the external device connected to the standby system, the error is notified by generating a continuation error.

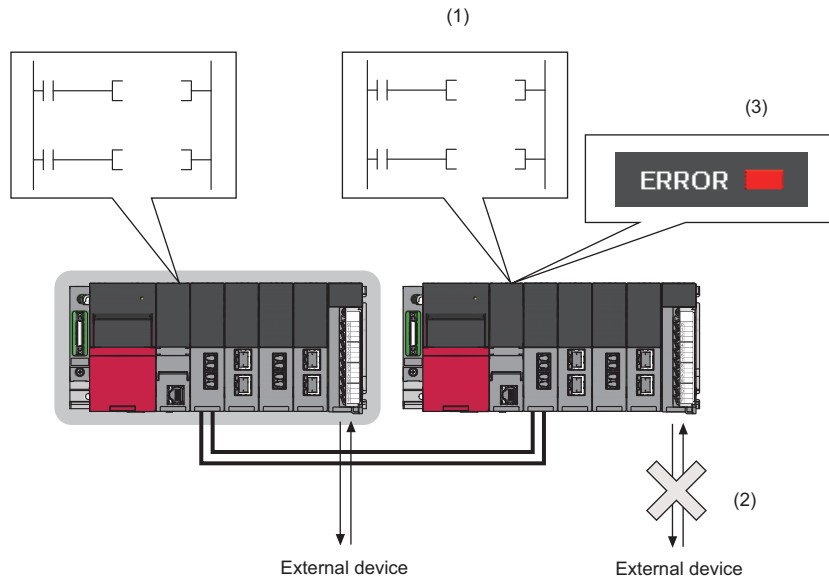

(1) A diagnostic program that is set as a program executed in both systems is executed.

(2) An error is detected in the external device connected to the standby system by the diagnostic program.

(3) The PALERT instruction is executed, and the detected error is displayed in the detailed information of the continuation error.

- Parameter setting

Set the parameter for each program to be executed in both systems.

 [CPU Parameter] ⇔ [Program Setting]

Window

Setting Item						
Change Execution Order						
Up(N)						
Down(M)						
Execute Order	Program Name	Execution Type		Refresh Group Setting	Device/File Use or not	Both Systems Program Executions Setting
		Type	Detailed Setting Information			
1	MAIN	Scan		(Do not Set)	<Detailed Setting>	Control System Execution
2						
3						
4						
5						

Displayed items

Item	Description	Setting range	Default
Both Systems Program Executions Setting	Set whether to execute a program only in the CPU module of the control system or in the CPU modules of both systems. <ul style="list-style-type: none"> • "Both Systems Executions" can be set for programs whose execution type is the initial execution type, scan execution type, and standby type. • "Control System Execution" can be set for programs whose execution type is the fixed scan execution type and event execution type. 	<ul style="list-style-type: none"> • Control System Execution • Both Systems Executions 	Control System Execution

Point

To enable the output (Y) to external devices connected to the standby system in a program executed in both systems, set "Enable" in "Standby System Output Setting" of the CPU parameter.

Operation of a program executed in both systems

The following table summarizes the operation of a program executed in both systems.

System	Backup mode	Separate mode
Control system	A program is executed according to its execution type.	A program is executed according to its execution type regardless of the setting in "Both Systems Program Executions Setting".
Standby system	A program executed in both systems is executed according to its execution type. When an initial execution type program is set as a program executed in both systems, the program is executed in the first scan when the operating status of the CPU module is changed to RUN. When an initial execution type program is not set as a program executed in both systems, a scan execution type program that is set as a program executed in both systems is executed in the first scan when the operating status of the CPU module is changed to RUN.	

- To perform different diagnostic processing in the control system and the standby system by using a program executed in both systems, use the special relay. SM1634 (Control system judgment flag) turns on only in the control system and SM1635 (Standby system judgment flag) turns on only in the standby system. The following is a program example that performs different processing by using the special relay. For the processing (1) and (2), use the SET instruction or another instruction to prevent duplication of a coil in the processing.

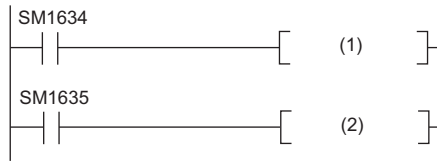

(1) Diagnostic processing in the control system, (2) Diagnostic processing in the standby system

- In a program executed in both systems, device/label values may differ between the control system and the standby system. If the systems are switched in this state, the program is executed using the different data and an unintended operation may be performed. To prevent this, the device/label values to be used can be initialized by using SM1643 (ON for only one scan after system switching (standby system to control system)) and SM1644 (ON for only one scan after system switching (control system to standby system)). For the processing (1) and (2), use the SET instruction or another instruction to prevent duplication of a coil in the processing.

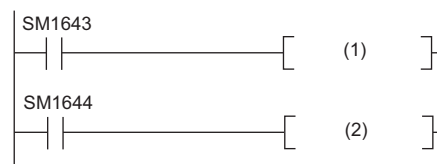

(1) Initialization processing (standby system → control system), (2) Initialization processing (control system → standby system)

■Operation at system switching

The operation of a program executed in both systems differs at system switching. The following table summarizes the operation at system switching.

Item		CPU module of the new control system	CPU module of the new standby system
Program execution	Initial execution type program	When an initial execution type program has not been completed in the old control system at system switching, it is executed again from the start.	When an initial execution type program has not been completed in the old standby system at system switching, it is not executed in the new standby system because the systems are switched after the program is completed in the old standby system.
	Scan execution type program	A scan execution type program is executed from the step 0.	
Direct access input (DX)		Data is input when an instruction using the direct access input (DX) is executed in the program after system switching.	
Direct access output (DY)		Data is not output. However, if "Standby System Output Setting" of the CPU parameter is set to "Enable", data is output when an instruction using the direct access output (DY) is executed in the program after system switching.	
FROM/TO instructions		These instructions are executed when the instruction execution condition is satisfied in the program after system switching.	
Instruction that requires several scans		<ul style="list-style-type: none"> • The instruction is executed when the instruction execution condition is satisfied in the program after system switching. • When the systems are switched while the instruction is being executed, the instruction execution continues and the completion device turns on upon completion of the instruction execution. 	

For the operation at system switching as for programs which are not set as those executed in both systems, refer to the following.

 MELSEC iQ-R CPU Module User's Manual (Application)

3.2 Network Overview

Redundant system function of Ethernet

The redundant system function improves system reliability by mounting the RJ71EN71 on the base unit of both systems in a redundant system so that the new control system can continue communications even if an error occurs on the network line of the control system.

To use the redundant system function, check the versions of the CPU module and the RJ71EN71 used.

Point

To switch the systems when a communication error or a cable disconnection on Ethernet is detected, use the RJ71EN71.

The systems are not switched when a communication error or a cable disconnection of the CPU module (built-in Ethernet port part) occurs.

3

System configuration

The following is the redundant system configuration using the RJ71EN71.

Prepare two base units, and mount a Process CPU, redundant function module, and RJ71EN71 on each base unit, creating two systems.

A redundant system is configured by connecting the RJ71EN71s of both systems with Ethernet cables.

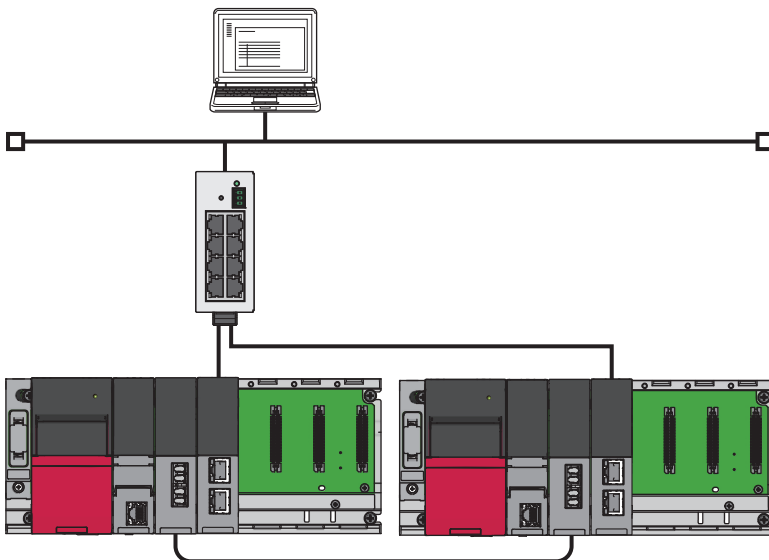

Point

Set either of the following for the network type of the RJ71EN71.

- Set "Ethernet" in "Port 1 Network Type" and "Port 2 Network Type".
- Set "Q Compatible Ethernet" in "Port 1 Network Type".

System switching operation

In a redundant system, if an error occurs in the control system, the control system and the standby system are switched. The data communications with external devices over Ethernet will continue by changing the connection destination to the Ethernet-equipped module of the new control system after system switching.

The following shows the system switching operation when a communication error occurs in the control system.

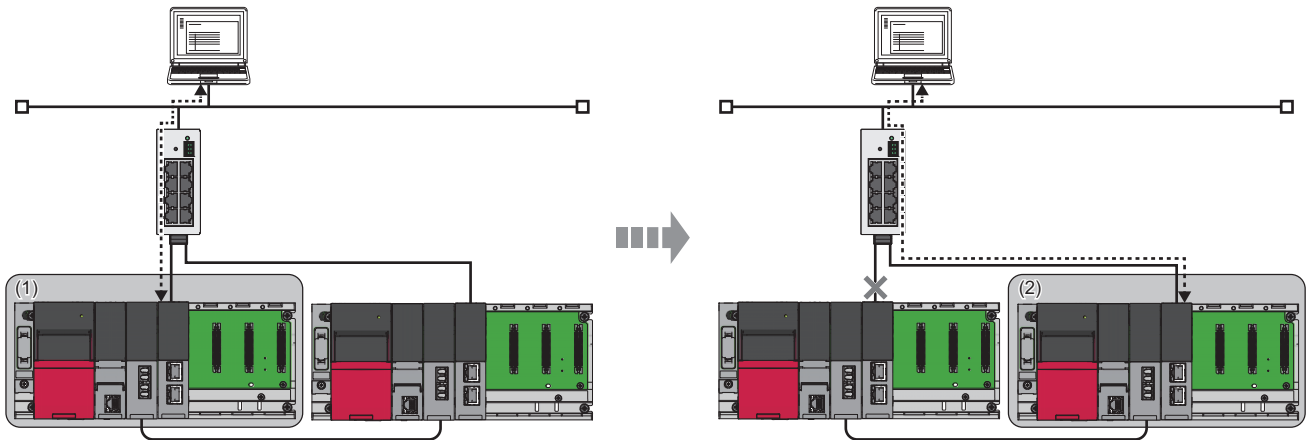

1. A communication error occurs in the control system (1).
2. The RJ71EN71 of the control system (1) issues a system switching request to the CPU module.
3. System switching occurs in the redundant system.
4. The standby system (2) starts operating as the new control system to continue the control of network.

Point

For OPS connection, through establishing a TCP/IP connection with both systems, communications can be smoothly continued simply by changing the communication destination even when system switching occurs.

Redundant system function of CC-Link IE Controller Network

The redundant system function improves system reliability by mounting the CC-Link IE Controller Network-equipped module on the base unit of both systems in a redundant system so that the new control system can continue data link even if an error occurs in the control system.

Restriction

The following modules are required to use the redundant system function.

- Process CPU
- Redundant function module
- RJ71GP21-SX with firmware version 12 or later

To use the redundant system function, check the versions of the Process CPU and the engineering tool used.
( MELSEC iQ-R CPU Module User's Manual (Application))

System configuration

The following is the redundant system configuration using the CC-Link IE Controller Network-equipped module.

Mount a CC-Link IE Controller Network-equipped module on the base unit of both systems in a redundant system.

A redundant system is configured by connecting the CC-Link IE Controller Network-equipped modules of both systems with optical fiber cables.

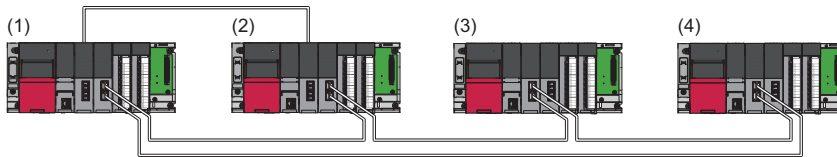

- (1) Control station (station No.1) of the control system (system A)
- (2) Normal station (station No.2) of the standby system (system B)
- (3) Normal station (station No.3)
- (4) Normal station (station No.4)

System switching operation

In a redundant system, if an error occurs in the control system, the control system and the standby system are switched. The data link over CC-Link IE Controller Network will continue by transferring send data to the new control system after system switching.

The following shows the system switching operation when a communication error occurs in the control system.

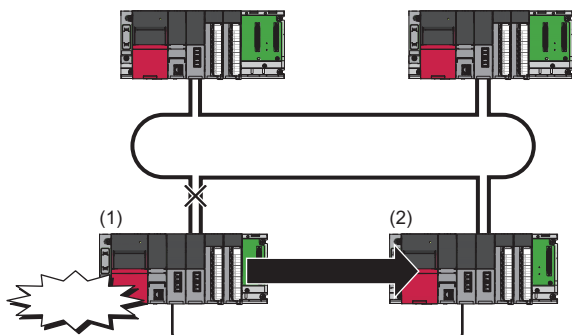

1. A communication error occurs in the control system (1).
2. The CC-Link IE Controller Network-equipped module of the control system (1) issues a system switching request to the CPU module.
3. System switching occurs in the redundant system.
4. The standby system (2) starts operating as the new control system to continue the control of network.

Point

- If the systems are switched due to the cause not generating a communication error, the control station is not switched.
- While the control is being switched to the station of the new control system, the cyclic data output is held.

Setting method

For the module used in a redundant system, select "RJ71GP21-SX (R)" for "Module Name" in the "Add New Module" window. Note that pairing needs to be set for the CC-Link IE Controller Network-equipped module of both systems. Pairing is set under "Network Range Assignment" in "Required Settings" of the control station.

■Cyclic transmission send/receive processing

When pairing is set for the CC-Link IE Controller Network-equipped module of both systems, send data is transferred to the new control system at the time of system switching to continue cyclic transmission.

The send range of cyclic transmission will be as follows in both systems when pairing is set.

- The own station send range of the link devices (LB, LW) becomes the same in both systems.
- The station operating as the control system sends and receives cyclic data.
- The station operating as the standby system only receives cyclic data.

Each number in the following figure, from No.1 to No.4, represents a station number.

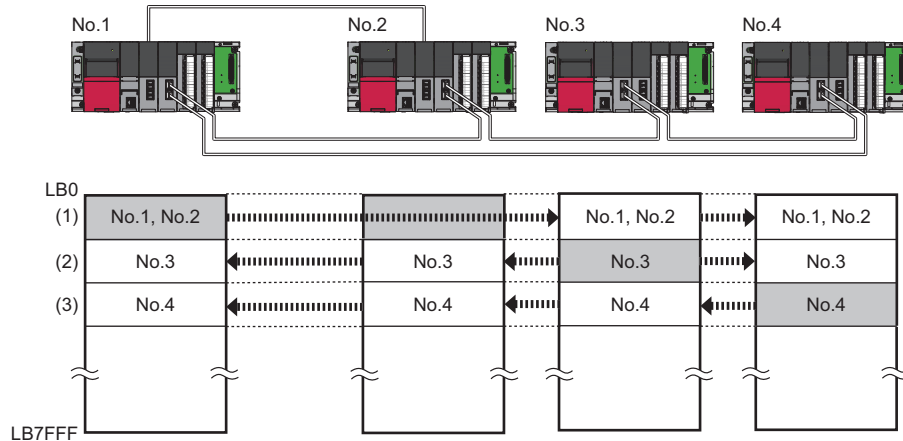

■ Send range of station number □

- (1) From station No.1 operating as the control system, data in the send ranges of stations No.1 and No.2 are sent to station No.3 and station No.4. If system switching occurs due to an error in station No.1, data in the send ranges of stations No.1 and No.2 are sent from station No.2, which starts operating as the new control system.
- (2) Data in the send range of station No.3 is sent to all stations including station No.2 operating as the standby system.
- (3) Data in the send range of station No.4 is sent to all stations including station No.2 operating as the standby system.

■Precautions

- Tracking transfer
- Data in the own station send range of devices (B, W), which are the refresh target of link devices (LB, LW), needs to be transferred.
- Link direct devices cannot be transferred.
- Do not transfer the link special relay (SB0020 to SB01FF), which is turned on/off by the system, and the link special register (SW0020 to SW01FF), where data is stored by the system.

Point

For details on the tracking transfer, refer to the following.

 MELSEC iQ-R CPU Module User's Manual (Application)

- Programming

CC-Link IE Controller Network detects a temporary communication error by the state of the power supply (on/off), cables, noise, and others. Create a program for CC-Link IE Controller Network so that control operation will not be stopped even if such a temporary communication error is detected.

- Detection of an error when another station is powered on/off

When either of the following operations is performed, a temporary data link error may be detected and a system switching request may be issued.

- Another station (including the standby system) is powered on/off.
- A personal computer where a CC-Link IE Controller Network interface board has been connected is booted or shut down.

If the above system switching request is issued before the standby system starts up, the CPU module of the control system may detect a continuation error (system switching error). At this time, the control of the redundant system by the control system continues normally. Create a program so that control operation will not be stopped due to an error detection.

To clear the continuation error (system switching error) detected, check that the standby system and the CC-Link IE Controller Network-equipped modules operate correctly by using the special register before clearing the error. ( MELSEC iQ-R CPU Module User's Manual (Application))

Redundant system function of CC-Link IE Field Network

The redundant system function improves system reliability by configuring the master/local module or the remote head module to be redundant so that the new control system can continue data link even if an error occurs in the control system.

Restriction

The following modules are required to use the redundant system function.

- Process CPU
- Redundant function module
- RJ71GF11-T2 with firmware version 12 or later

To use the redundant system function, check the versions of the Process CPU and the engineering tool used. (MELSEC iQ-R CPU Module User's Manual (Application))

System configuration

This section describes the redundant system configuration of CC-Link IE Field Network.

There are three types of redundant system configurations for CC-Link IE Field Network.

System configuration	Description	Reference
Redundant master station	The master station is configured to be redundant.	Page 84 Redundant master station
Redundant slave station	The slave station is configured to be redundant.	Page 84 Redundant slave station
Redundant line	The control system and standby system are configured on a different network line. The network line is configured to be redundant.	Page 85 Redundant line

There are no network topology restrictions even when a redundant system is configured. However, configuring a redundant system using a ring topology is recommended. This is because system switching can be avoided by the loopback function when a cable disconnection occurs or a faulty station occurs in a system other than the redundant system.

Restriction

When configuring a CC-Link IE Field Network system including a redundant system, the master/local module with firmware version 12 or later must be used for the master and local stations.

The following modules must be used for the MELSEC Q/L series local stations.

- MELSEC-Q series: Local station with a serial number (first five digits) of "18042" or later
- MELSEC-L series: Local station with a serial number (first five digits) of "18042" or later

MELSEC-QS series local stations cannot be used.

When connecting a GOT or CC-Link IE Field Network interface board, refer to the manual for the product used.

■Redundant master station

In a redundant master station configuration, the master station (1) and the submaster station (2) are connected with tracking cables. When an error occurs in the master station of the control system, the control is switched to the submaster station of the standby system to continue the control of slave stations and data link.

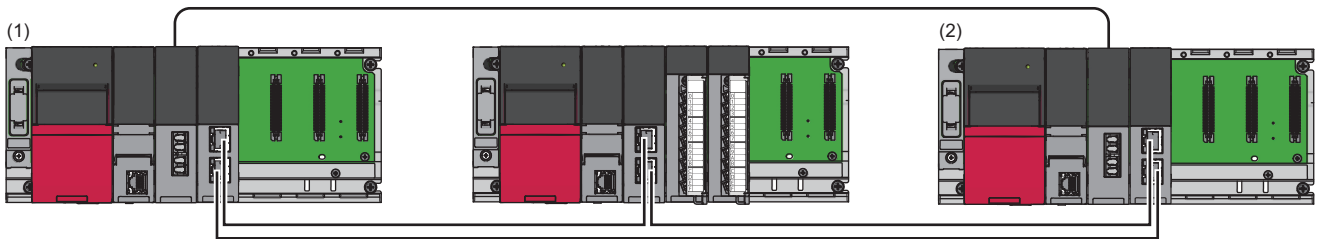

• Setting method

For the module used in a redundant master station configuration, select "RJ71GF11-T2(MR)" for "Module Name" in the "Add New Module" window.

Set the station number of the submaster station of the standby system in "Network Configuration Settings" under "Basic settings." Station numbers of both systems do not need to be set consecutively.

Point

In a redundant system, send data in the send range are transferred from the control system (master station) to the standby system (submaster station) by tracking transfer. The same data as those of the control system (master station) do not need to be set to the standby system (submaster station).

■Redundant slave station

In a redundant slave station configuration, the slave station is configured to be redundant on one network line. When an error occurs in the slave station (1) of the control system, the control is switched to the slave station (2) of the standby system to continue the control of slave stations and data link.

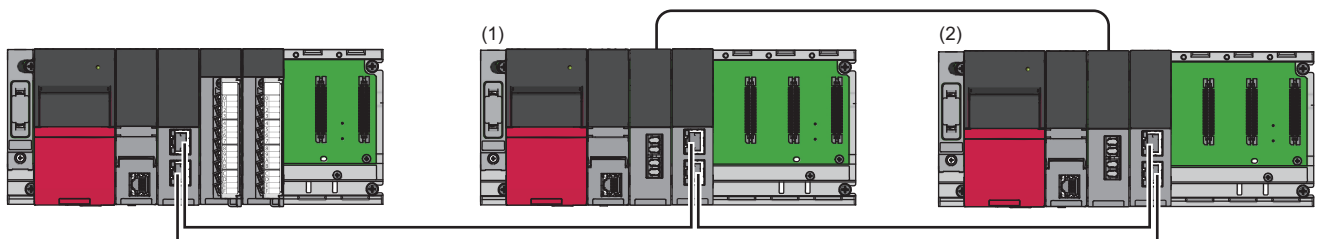

Point

The remote head module can be mounted on slave stations. For the redundant slave station configuration using the remote head module, refer to the following.

📖 MELSEC iQ-R CC-Link IE Field Network Remote Head Module User's Manual (Application)

• Setting method

For the modules used in a redundant slave station configuration, select the following models in the project of each station. The station numbers of the slave stations configured to be redundant (in the system A and the system B) are set consecutively.

Project	Setting item	Station type	Model
Master station project	"Network Configuration Settings" in "Basic Settings"	Local station	RJ71GF11-T2(SR)
		Intelligent device station	RJ72GF15-T2(SR)
Slave station project	"Add New Module" window	Local station	RJ71GF11-T2(SR)
	"New" window of the project	Intelligent device station	RJ72GF15-T2(SR)

By setting the above models in "Network Configuration Settings" under "Basic Settings" for the master station, pairing is set and the send range becomes the same in both systems.

■Redundant line

In a redundant line configuration, two network lines are prepared, and the same master station and slave station are connected to each network line. (The master/local module of both systems operate as a master station of each network line.) When an error occurs in the network (1) of the control system, the control is switched to the network (2) of the standby system to continue the control of the redundant system and data link.

The network configuration must be the same in both systems.

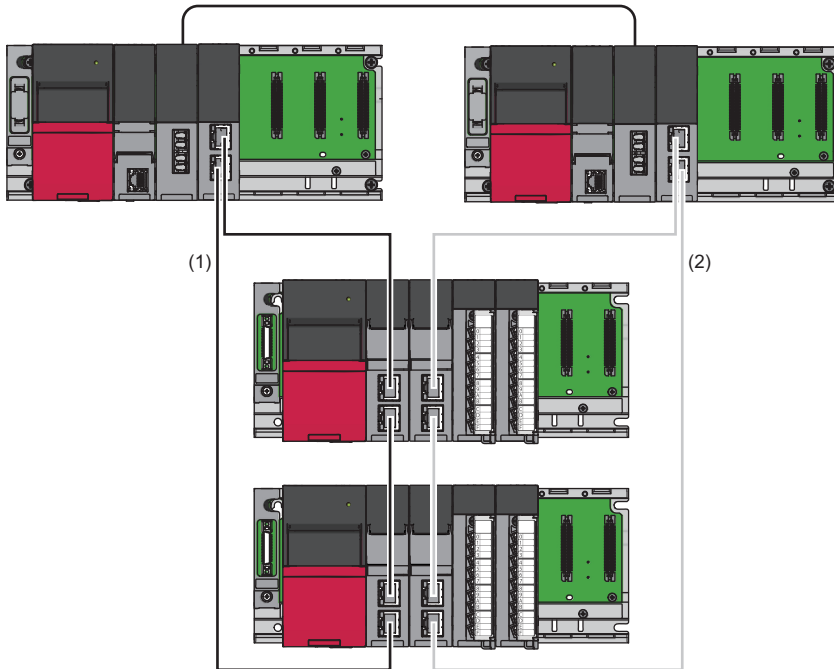

Restriction

For slave stations, only remote head modules configured as a redundant system can be used.

Point

It is recommended to use the same network topology and connect an Ethernet cable to the same Ethernet port. In addition, visually check the actual network configuration of both systems. The "CC-Link IE Field Diagnostics" window may display a configuration different from the actual system configuration.

• Setting method

For the modules used in a redundant line configuration, select the following models in the project of each station.

Project	Setting item	Station type	Model
Master station project	"Add New Module" window	Master station	RJ71GF11-T2(LR)
	"Network Configuration Settings" in "Basic Settings"	Intelligent device station	RJ72GF15-T2(LR)
Slave station project	"New" window of the project	Intelligent device station	RJ72GF15-T2(LR)

System switching operation

In a redundant system, if an error occurs in the control system, the control system and the standby system are switched. The data link over CC-Link IE Field Network will continue by transferring send data to the new control system after system switching.

This section describes system switching operations for each redundant system configuration.

Point

While the control is being switched to the station or network of the new control system, the cyclic data output is held. For the cyclic data holding time (output holding time) when system switching occurs, refer to the following.

 MELSEC iQ-R CC-Link IE Field Network User's Manual (Application)

■Redundant master station

When an error occurs in the control system, system switching occurs in the redundant system.

The master station (1) stops master operation and the submaster station (2) of the new control system takes over master operation to continue the control.

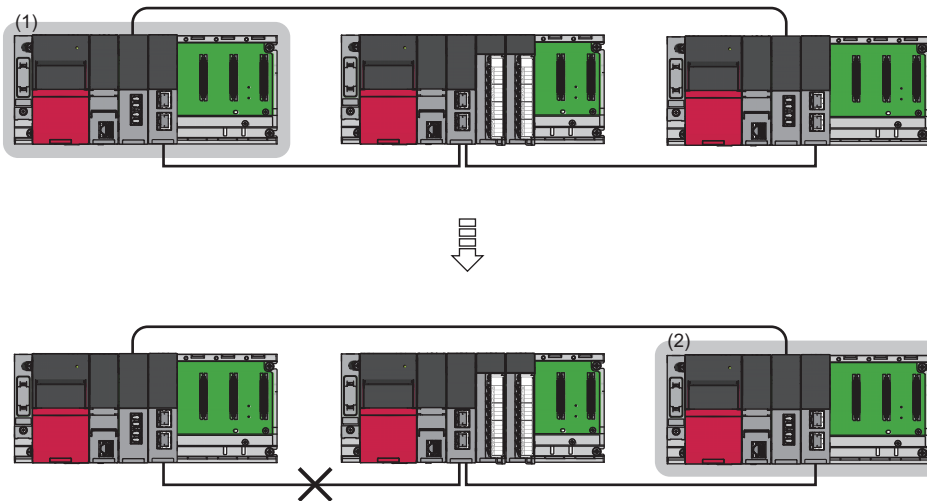

• Cyclic transmission send/receive processing

The master/local module continues cyclic transmission by transferring send data to the new control system when system switching occurs.

The send range of cyclic transmission will be as follows in both systems.

- The own station send range of the link devices (RY, RWw) becomes the same in both systems.
- The master operating station operating as the control system sends and receives cyclic data.
- The submaster operating station operating as the standby system only receives cyclic data.

Each number in the following figure, from No.0 to No.2, represents a station number.

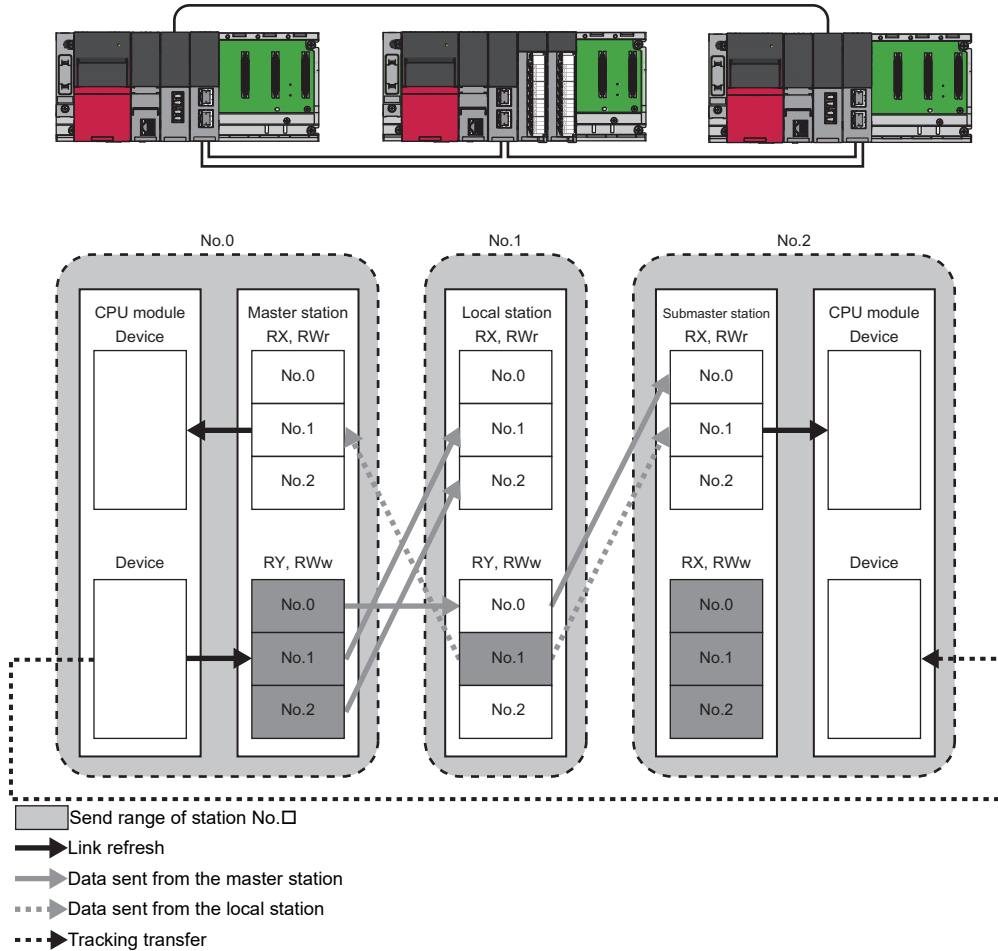

If system switching occurs due to an error in the master station (station No.0), the cyclic data is sent from the submaster station (station No.2), which starts operating as the new control system.

• Precautions

- When using the module in a redundant master station configuration, check the submaster function precautions before use. (MELSEC iQ-R CC-Link IE Field Network User's Manual (Application))
- Manual switching cannot be performed using 'Forced master switching command' (SB0019) of the submaster function.
- As shown below, if the redundant configuration splits into two systems due to a problem such as a cable disconnection, a continuation error occurs in the CPU module of the standby system because a network configuration mismatch occurs between the master station (1) and the submaster station (2). As a result, the submaster station becomes the master operating station (2). However, the station does not send cyclic data because it remains as the standby system. By connecting the disconnected cable and restoring the original system, the submaster station operates as the submaster operating station (3) again.

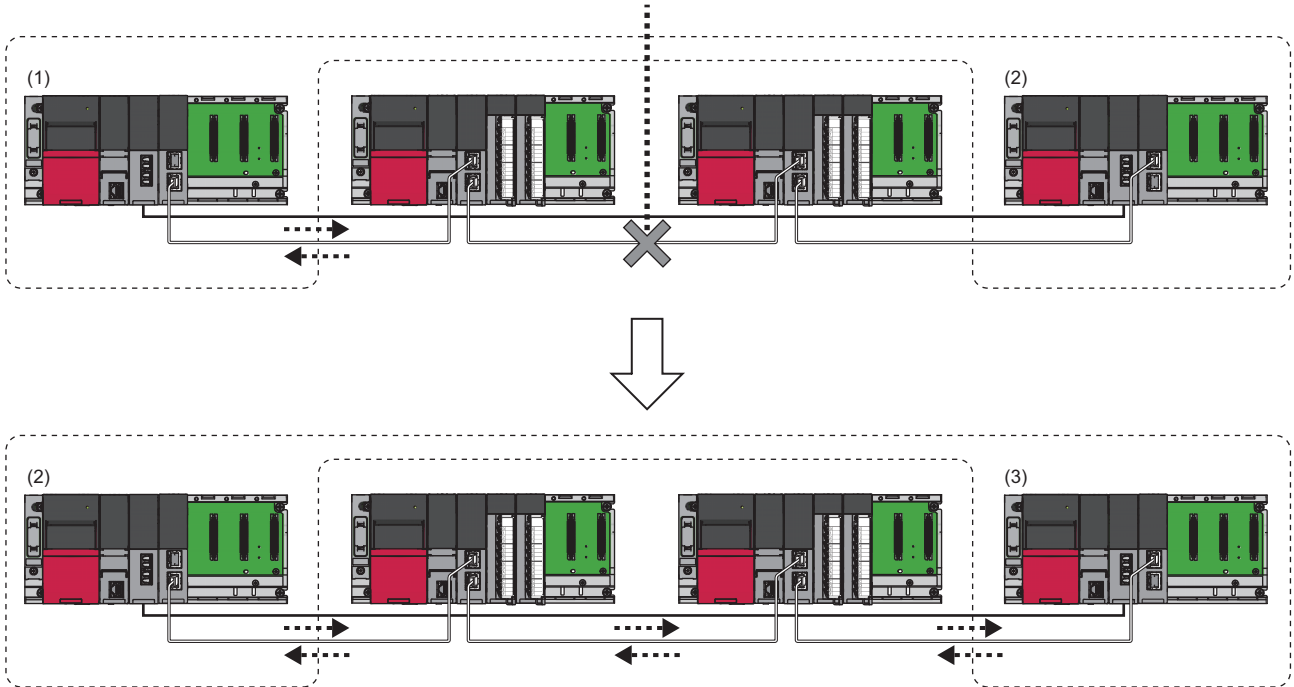

■ Redundant slave station

When an error occurs in the control system, system switching occurs in the redundant system.

The slave station (1) of the control system stops sending data and send data is transferred to the slave station (2) of the new control system to continue data link.

For the system switching operation of the redundant slave station configuration using the remote head modules, refer to the following.

MELSEC iQ-R CC-Link IE Field Network Remote Head Module User's Manual (Application)

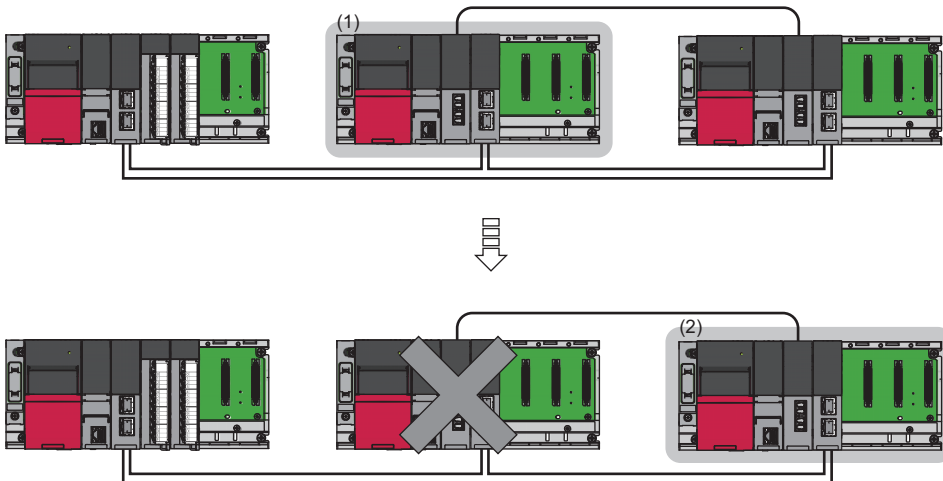

- Cyclic transmission send/receive processing

The slave station continues cyclic transmission by transferring send data to the new control system when system switching occurs.

The send range of cyclic transmission will be as follows in both systems.

- The own station send range of the link devices (RY, RWw) becomes the same in both systems by the pairing setting.
- The slave station operating as the control system sends and receives cyclic data.
- The slave station operating as the standby system only receives cyclic data.

Each number in the following figure, from No.0 to No.2, represents a station number.

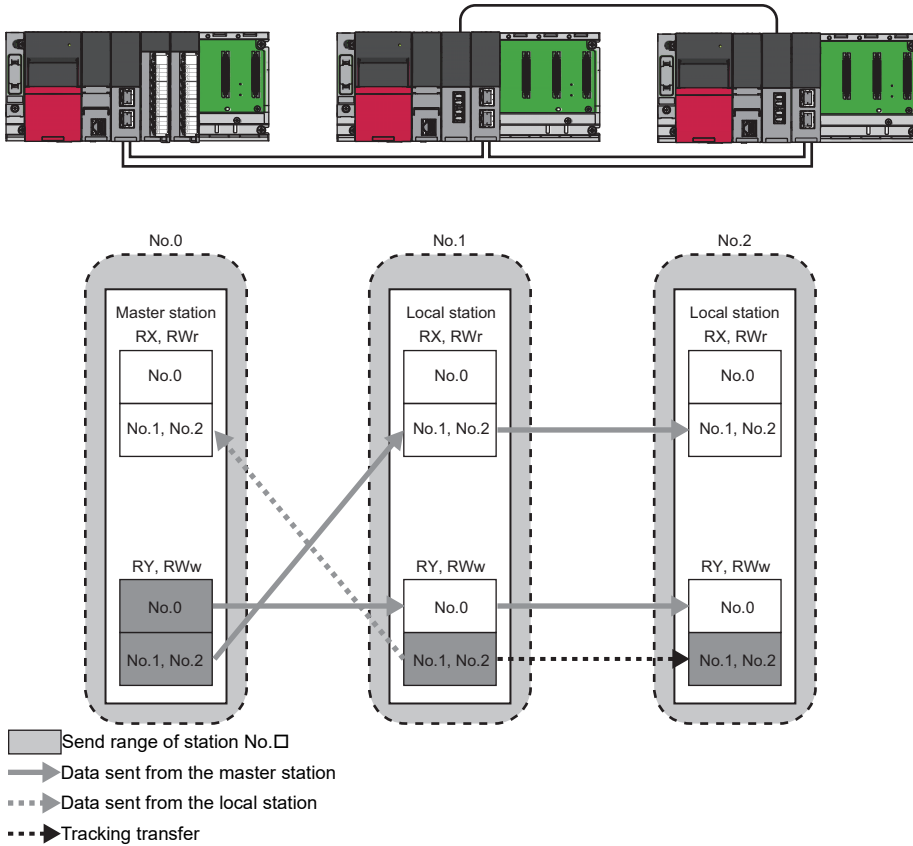

If system switching occurs due to an error in the local station (station No.1), the cyclic data is sent from the local station (station No.2), which starts operating as the new control system.

Redundant line

In a redundant line configuration, two network lines are prepared, and the same master station and slave station are connected to each network line. (The master/local module of both systems operate as a master station of each network line.)

When an error occurs in the control system, system switching occurs in the redundant system.

After system switching, the new control system continues the control of network.

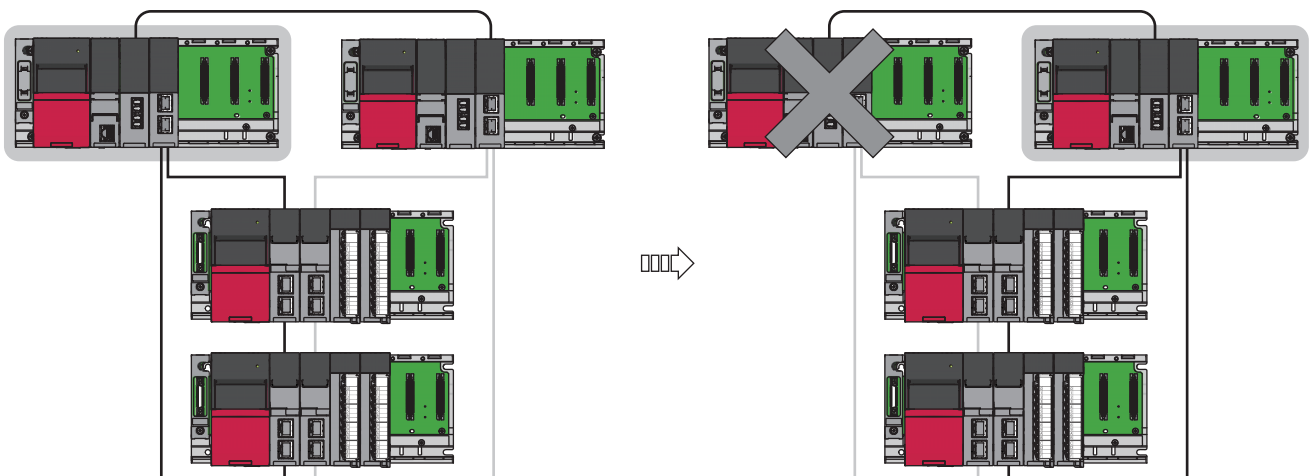

- Cyclic transmission send/receive processing

The master station and slave station continue cyclic transmission by transferring send data to the new control system when system switching occurs.

The send range of cyclic transmission will be as follows in both systems.

- The own station send range of the link devices (RY, RWw) of the master station becomes the same in both systems.
- The own station send range of the link devices (RY, RWw) of the slave station becomes the same in both systems.
- The network line independently sends/receives cyclic data in both systems.

Each number in the following figure, from No.0 to No.1, represents a station number.

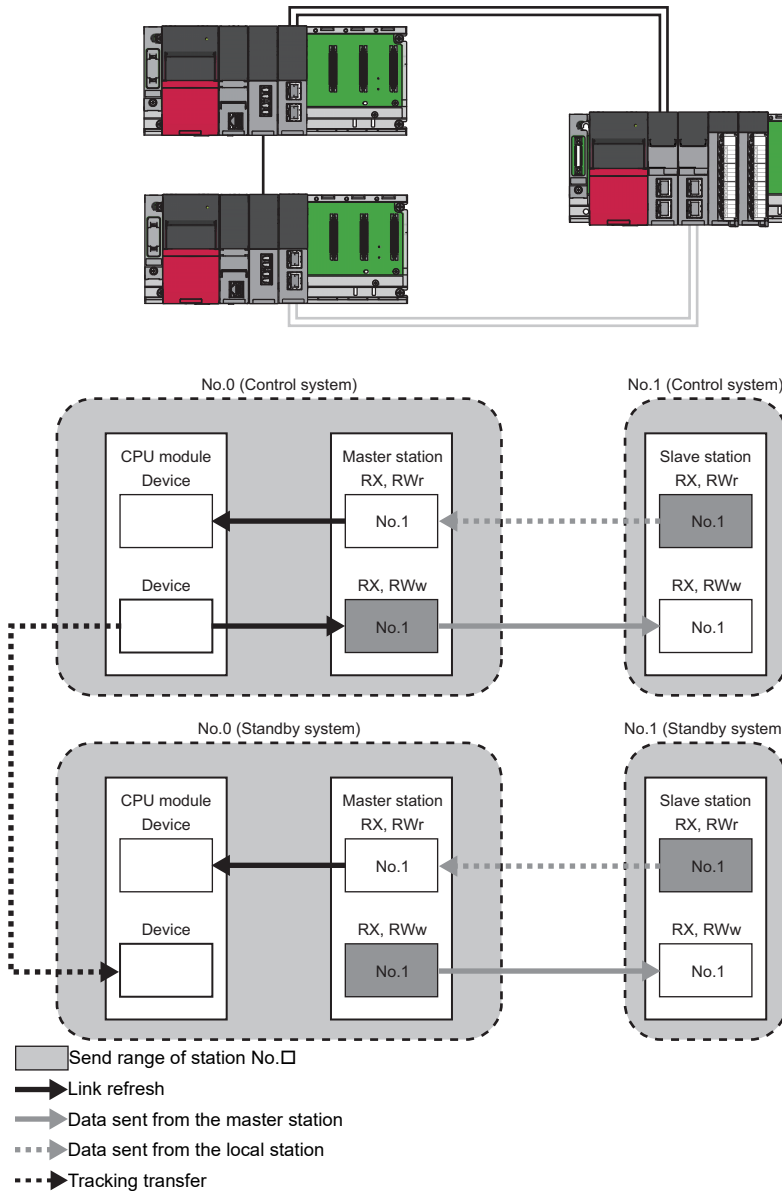

When system switching occurs due to an error in the control system, the control is switched to the network of the new control system.

Point

Between the networks of both systems, an error (maximum of one link scan time) occurs in the cyclic transmission delay time.

■Precautions

- Tracking transfer
- Data in the own station send range of devices, which are the refresh target of link devices (RY, RWw), needs to be transferred.
- Link direct devices cannot be transferred.
- Do not transfer the link special relay (SB0020 to SB01FF), which is turned on/off by the system, and the link special register (SW0020 to SW01FF), where data is stored by the system.



For details on the tracking transfer, refer to the following.

MELSEC iQ-R CPU Module User's Manual (Application)



- Operation after return

When the master/local module is disconnected due to a communication error, switched from the control system to the standby system, and then returns to the system, it returns as the standby system.

3.3 Specifications

Process CPU

Hardware specifications

Item		R08P	R16P	R32P	R120P	
Operation control method		Stored program cyclic operation				
I/O control mode		Refresh mode (The direct access input/output is available by specifying the direct access input/output (DX, DY).)				
Instruction processing time	LD X0	0.98ns				
	MOV D0 D1	1.96ns				
Instruction processing time (structured text)	IF	1.96ns				
	CASE	1.96ns				
	FOR	1.96ns				
Memory capacity	Program capacity	80K steps (320K bytes)	160K steps (640K bytes)	320K steps (1280K bytes)	1200K steps (4800K bytes)	
	Program memory	320K bytes	640K bytes	1280K bytes	4800K bytes	
	SD memory card	Differs depending on the SD memory card used. (SD/SDHC memory card: 32G bytes maximum)				
	Device/label memory	Total	1188K bytes	1720K bytes	2316K bytes	3380K bytes
		Device area ^{*1}	80K bytes			
		Label area ^{*1}	80K bytes	100K bytes	180K bytes	220K bytes
		Latch label area ^{*1}	4K bytes			8K bytes
	File storage area ^{*1}	1024K bytes	1536K bytes	2048K bytes	3072K bytes	
		Signal flow memory	10K bytes	20K bytes	40K bytes	150K bytes
	Area for function blocks	256K bytes ^{*5}				
		Data memory	5M bytes	10M bytes	20M bytes	40M bytes
CPU buffer memory	1072K bytes (536K words) (including the fixed scan communication area (24K words))					
Refresh memory	2048K bytes ^{*2}					
Number of storable files	Program memory (P: number of program files, FB: number of FB files)	P: 252, FB: 128 (One FB file can store 64 function blocks.)				
	Device/label memory (file storage area)	324 (with or without an extended SRAM cassette) ^{*3}				
	Data memory	512 ^{*4}				
	SD memory card	<ul style="list-style-type: none"> • NZ1MEM-2GBSD: 256^{*4} • NZ1MEM-4GBSD, NZ1MEM-8GBSD, NZ1MEM-16GBSD: 32767^{*4} 				
Number of storable folders	Data memory	512 ^{*4}				
	SD memory card	<ul style="list-style-type: none"> • NZ1MEM-2GBSD: 256^{*4} • NZ1MEM-4GBSD, NZ1MEM-8GBSD, NZ1MEM-16GBSD: 32767^{*4} 				
USB port	USB2.0 High Speed (miniB) × 1					
Ethernet port	Refer to the following.  MELSEC iQ-R Ethernet/CC-Link IE User's Manual (Startup)					
Clock function	Year, month, date, hour, minute, second, and day of the week (automatic leap year adjustment) -1.00 to +1.00s/d at 0 to 55°C					
Allowable momentary power failure time	The time differs depending on the power supply module used. ( MELSEC iQ-R Module Configuration Manual)					
Internal current consumption (5VDC)	0.76A					
External dimensions	Height	106mm (Base unit mounting side: 98mm)				
	Width	27.8mm				
	Depth	110mm				
Weight	0.20kg					

- *1 The capacity of the device area, label area, latch label area, and file storage area can be changed in parameter. The capacity of the device/label memory can be increased by inserting an extended SRAM cassette. (📖 MELSEC iQ-R CPU Module User's Manual (Application))
- *2 This is the total capacity of the device area and module label area.
- *3 System files are included.
- *4 The number indicates the number of files and folders (including system files and system folders) can be created in the root directory on the condition that the number of characters in the file or folder name is 13 or less. In a subdirectory, up to 32767 files and folders can be created.
Note that the number of storable files and folders will decrease if many files and folders with a long name, more than 13 characters (including an extension), are created.
- *5 For the Process CPU with firmware version 06 or earlier, the memory capacity is 20K bytes.

Programming specifications

Item		R08P	R16P	R32P	R120P
Programming language		<ul style="list-style-type: none"> • Ladder diagram (LD) • Sequential function chart (SFC)^{*5*6} • Structured text (ST) • Function block diagram (FBD/LD) 			
Programming supporting function		<ul style="list-style-type: none"> • Function block (FB) • Label programming (system/local/global) 			
Program operation	Execution type	<ul style="list-style-type: none"> • Initial execution type • Scan execution type • Fixed scan execution type • Event execution type • Standby type 			
	Type of interrupt	<ul style="list-style-type: none"> • Interrupt using the internal timer (I28 to I31) • High-speed internal timer interrupt 1 (I49) • High-speed internal timer interrupt 2 (I48) • Interrupt by a module • Inter-module synchronous interrupt (I44)^{*6} • Multiple CPU synchronous interrupt (I45)^{*6} 			
Number of executable programs		252			
Number of FB files		128			
Tact performance	Constant scan		0.2 to 2000ms (The value can be set in increments of 0.1ms.)		
	Fixed scan interrupt	Interrupt using the internal timer (I28 to I31)	0.5 to 1000ms (The value can be set in increments of 0.5ms.)		
		High-speed internal timer interrupt 1 (I49)	0.05 to 1000ms (The value can be set in increments of 0.05ms.)		
		High-speed internal timer interrupt 2 (I48)	0.05 to 1000ms (The value can be set in increments of 0.05ms.)		
		Inter-module synchronous interrupt (I44) ^{*6}	0.1 to 10.00ms (The value can be set in increments of 0.05ms.)		
		Multiple CPU synchronous interrupt (I45) ^{*6}	0.1 to 10.00ms (The value can be set in increments of 0.05ms.)		
Timer performance	Low-speed timer		1 to 1000ms (Default: 100ms)		
	High-speed timer		0.01 to 100ms (Default: 10ms)		
	Long timer		0.001 to 1000ms (Default: 0.001ms)		
Number of I/O points		4096 points			
Number of user device points (default)	Input (X)		12288 points (fixed)		
	Output (Y)		12288 points (fixed)		
	Internal relay (M)		12288 points (user-changeable) ^{*1}		
	Link relay (B)		8192 points (user-changeable) ^{*1}		
	Link special relay (SB)		2048 points (user-changeable) ^{*1}		
	Annunciator (F)		2048 points (user-changeable) ^{*1}		
	Edge relay (V)		2048 points (user-changeable) ^{*1}		
	Step relay (S) ^{*4*5*6}		0 points (user-changeable) ^{*1}		
	Timer device	Timer (T)	1024 points (user-changeable) ^{*1}		
		Long timer (LT)	1024 points (user-changeable) ^{*1}		
	Retentive timer device	Retentive timer (ST)	0 points (user-changeable) ^{*1}		
		Long retentive timer (LST)	0 points (user-changeable) ^{*1}		
	Counter device	Counter (C)	512 points (user-changeable) ^{*1}		
		Long counter (LC)	512 points (user-changeable) ^{*1}		
	Data register (D)		18432 points (user-changeable) ^{*1}		
	Link register (W)		8192 points (user-changeable) ^{*1}		
	Link special register (SW)		2048 points (user-changeable) ^{*1}		
Latch relay (L)		8192 points (user-changeable) ^{*1}			

Item		R08P	R16P	R32P	R120P
Number of system device points	Special relay (SM)	4096 points (fixed)			
	Special register (SD)	4096 points (fixed)			
	Function input (FX)	16 points (fixed)			
	Function output (FY)	16 points (fixed)			
	Function register (FD)	5 points × 4 words (fixed)			
Number of file register points (default)	File register (R/ZR)	0 points (user-changeable) ^{*1}			
Number of index register points (default)	Index register (Z)	20 points (user-changeable, up to 24 points)			
	Long index register (LZ)	2 points (user-changeable, up to 12 points)			
Number of pointer points	Pointer (P) (global/local) (default)	8192 points (user-changeable, up to 16384 points)			16384 points (user-changeable, up to 32768 points)
	Interrupt pointer (I)	1024 points (fixed)			
Number of link direct device points	Link input (J□\X□)	16384 points maximum ^{*2}			
	Link output (J□\Y□)	16384 points maximum ^{*2}			
	Link relay (J□\B□)	32768 points maximum ^{*2}			
	Link register (J□\W□)	131072 points maximum ^{*2}			
	Link special relay (J□\SB□)	512 points maximum ^{*2}			
	Link special register (J□\SW□)	512 points maximum ^{*2}			
Number of module access device points	Intelligent function module device (U□\G□)	268435456 points maximum ^{*2}			
Number of CPU buffer memory access device points	Buffer memory (U3E□\G□)	524288 points			
	Fixed scan communication area in the buffer memory (U3E□\HG□) ^{*6}	12288 points maximum ^{*3}			
Number of refresh data register points (default)	Refresh data register (RD)	524288 points (1048576 points maximum)			
Number of nesting points	Nesting (N)	15 points			
Number of other device points	SFC block device (BL) ^{*4*5*6}	320 points			
	SFC transition device (TR) ^{*4*5*6}	0 points (Used only as device comments.)			

*1 For the setting range, refer to the following.

 MELSEC iQ-R CPU Module User's Manual (Application)

*2 These are the maximum points that can be handled in the CPU module. The number of points actually used differs depending on the module used.

*3 The maximum point differs depending on the parameter setting (Multiple CPU Setting).

*4 These devices are used in SFC programs. For details on SFC programs, refer to the following.

 MELSEC iQ-R Programming Manual (Program Design)

*5 To use these devices, check the versions of the CPU module and the engineering tool used. ( MELSEC iQ-R CPU Module User's Manual (Application))

*6 The Process CPU (redundant mode) does not support these items.

Redundant function module

This section describes the specifications of the redundant function module.

Item		R6RFM
Tracking cable	Cable specifications	An optical fiber cable compliant with the following standards (multimode optical fiber (GI)) <ul style="list-style-type: none"> • IEEE 802.3 (1000BASE-SX) • IEC 60793-2-10 Types A1a.1
	Maximum cable length	550m
Optical fiber specifications		Standard: IEEE 802.3, IEC 60793-2-10 (Types A1a.1) Outside diameter of the core/clad: 50μm/125μm Transmission loss: 3.5dB/km or lower [$\lambda = 850\text{nm}$] Transmission band: 500MHz·km or more [$\lambda = 850\text{nm}$]
Connector specifications		Duplex LC connector Standard: IEC 61754-20 (Type LC connector) Connection loss: 0.3dB or lower Polished surface: PC (Physical Contact) polishing
Laser class (IEC 60825-1)		Class 1 laser product
Number of occupied I/O points		32 points ^{*1}
Internal current consumption (5VDC)		0.88A
External dimensions	Height	106mm (Base unit mounting side: 98mm)
	Width	27.8mm
	Depth	110mm
Weight		0.18kg

*1 All I/O signals are use prohibited.

Point

Optical fiber cables with connectors are available from Mitsubishi Electric System & Service Co., Ltd. (Catalogs of the optical fiber cables are also available.)

- Type: Multimode optical fiber (GI)
- Model: QG series

In addition, on-site connector polishing, terminal assembly, and fusion splicing are available. Please consult Mitsubishi Electric System & Service Co., Ltd.

Performance specifications of Ethernet

The following table lists the performance specifications of Ethernet.

Item		RJ71EN71		
		Ethernet	Q-compatible Ethernet	
Transmission specifications	Data transmission speed	1Gbps/100Mbps/10Mbps		
	Communication mode	1000BASE-T	Full-duplex	—
		100BASE-TX	Full-duplex/half-duplex	
		10BASE-T	Full-duplex/half-duplex	
	Interface	RJ45 connector (Auto MDI/MDI-X)		
	Transmission method	Base band		
	Maximum frame size	<ul style="list-style-type: none"> • 1518 bytes • 9022 bytes (when jumbo frames are used) 	1518 bytes	
	Jumbo frame	Available	Not available	
	Maximum segment length	100m (length between hub and node) ^{*2}		
	Number of cascade connections	1000BASE-T	^{*3}	
100BASE-TX		2 levels maximum ^{*4}		
10BASE-T		4 levels maximum ^{*4}		
IP version	Compatible with IPv4			
Sending/receiving data storage memory	Number of simultaneous open connections	128 connections (connections usable on a program)	16 connections (connections usable on a program)	
	Fixed buffer	5K words × 16	1K words × 16	
	Socket communications	<ul style="list-style-type: none"> • 5K words × 48 (when only P1 is used) • 5K words × 112 (when P1 and P2 are used) 	—	
	Random access buffer	6K words × 1		
Hardware specifications	Number of occupied I/O points	32 points		
	Internal current consumption (5VDC)	0.82A		
	External dimensions	Height	106mm (Base unit mounting side: 98mm)	
		Width	27.8mm	
		Depth	110mm	
Weight	0.17kg			

- *1 When using 1Gbps, set "Communication Speed" under "Application Settings" to "Automatic Negotiation". ("1Gbps/Full Duplex" cannot be selected.)
- *2 For the maximum segment length (length between hubs), consult the manufacturer of the hub used.
- *3 Consult the manufacturer of the switching hub used.
- *4 This applies when a repeater hub is used. For the number of levels that can be constructed when a switching hub is used, consult the manufacturer of the switching hub used.

Point

The operation of commercial devices used for the following applications is not guaranteed. Check the operation before using the module.

- Internet (general public line) (Internet-access service offered by an Internet service provider or a telecommunications carrier)
- Firewall device(s)
- Broadband router(s)
- Wireless LAN

Performance specifications of CC-Link IE Controller Network

The following table lists the performance specifications of CC-Link IE Controller Network.

Item		RJ71GP21-SX	RJ71EN71, RnENCPU (network part)	
Maximum number of link points per network	LB	32K points (32768 points, 4K bytes)		
	LW	128K points (131072 points, 256K bytes)		
	LX	8K points (8192 points, 1K bytes)		
	LY	8K points (8192 points, 1K bytes)		
Maximum number of link points per station	LB	16K points (16384 points, 2K bytes), Extended mode: 32K points (32768 points, 4K bytes)		
	LW	16K points (16384 points, 32K bytes), Extended mode: 128K points (131072 points, 256K bytes)		
	LX	8K points (8192 points, 1K bytes)		
	LY	8K points (8192 points, 1K bytes)		
Transient transmission capacity		1920 bytes maximum		
Communication speed		1Gbps		
Network topology		Duplex loop	Line topology, star topology (coexistence of line topology and star topology is also possible), and ring topology	
Communication cable		Optical fiber cable which satisfies 1000BASE-SX standard: Multi-mode optical fiber (G)	Ethernet cable which satisfies 1000BASE-T standard: Category 5e or higher, straight cable (double shielded, STP)	
Maximum station-to-station distance		550m	100m (conforms to ANSI/TIA/EIA-568-B (Category 5e))	
Overall cable distance		66000m (when 120 stations are connected)	Line topology: 11900m (when 120 stations are connected) Star topology: Depends on the system configuration. Ring topology: 12000m (when 120 stations are connected)	
Number of cascade connections		—	20 levels maximum	
Maximum number of connectable stations		120 stations (control station: 1, normal station: 119)*1		
Maximum number of networks		239		
Maximum number of groups		32		
Communication method		Token ring	Token passing	
Optical fiber specifications		Standard: IEEE 802.3, IEC 60793-2-10 (Types A1a.1) Outside diameter of the core/clad: 50μm/125μm Transmission loss: 3.5dB/km or lower [$\lambda = 850\text{nm}$] Transmission band: 500MHz·km or more [$\lambda = 850\text{nm}$]	—	
Connector specifications		Duplex LC connector Standard: IEC 61754-20 Type LC connector Connection loss: 0.3dB or lower Polished surface: PC (Physical Contact) polishing	RJ45 connector	
Laser class (IEC 60825-1)		Class 1 laser product		
Hardware specifications	Number of occupied I/O points		32 points	
	Internal current consumption (5VDC)		0.88A	
	External dimensions	Height	106mm (Base unit mounting side: 98mm)	
		Width	27.8mm	
		Depth	110mm	
Weight		0.18kg	0.17kg	

*1 When a CC-Link IE Controller Network-equipped module is mounted on a normal station, the maximum number of connectable stations differs depending on the CPU module mounted on the control station. For details, refer to the user's manual for the control station used.

Performance specifications of CC-Link IE Field Network

The following table lists the performance specifications of CC-Link IE Field Network.

Item		RJ71GF11-T2	RJ71EN71, RnENCPU (network part)	
Maximum number of link points per network		RX	16K points (16384 points, 2K bytes)	
		RY	16K points (16384 points, 2K bytes)	
		RWr	8K points (8192 points, 16K bytes)	
		RWw	8K points (8192 points, 16K bytes)	
Maximum number of link points per station	Master station	RX	16K points (16384 points, 2K bytes)	
		RY	16K points (16384 points, 2K bytes)	
		RWr	8K points (8192 points, 16K bytes)	
		RWw	8K points (8192 points, 16K bytes)	
	When the submaster function is used ^{*3}	Master operating station	RX	16K points
			RY	16K points (Own station send range is 2K points.)
			RWr	8K points
			RWw	8K points (Own station send range is 1024 points.) 8K points when the communication mode is "High-Speed" (Own station send range is 256 points.)
		Submaster operating station ^{*1}	RX	2K points (assigned for the station number 0 or submaster station)
			RY	2K points (assigned for the station number 0 or submaster station)
			RWr	1024 points (assigned for the station number 0 or submaster station) 256 points when the communication mode is "High-Speed"
			RWw	1024 points (assigned for the station number 0 or submaster station) 256 points when the communication mode is "High-Speed"
	Local station ^{*1,3}	RX	2K points (2048 points, 256 bytes)	
		RY	2K points (2048 points, 256 bytes)	
		RWr	1K points (1024 points, 2K bytes) 256 points (512 bytes) when the communication mode is "High-Speed"	
		RWw	1K points (1024 points, 2K bytes) 256 points (512 bytes) when the communication mode is "High-Speed"	
Safety communication function ^{*2}	Maximum number of safety connections per network		1814 connections	
	Maximum number of safety connections per station		120 connections	
	Maximum number of link points per safety connection		8 words (Input: 8 words, output: 8 words)	
Transient transmission capacity		1920 bytes maximum		
Communication speed		1Gbps		
Network topology		Line topology, star topology (coexistence of line topology and star topology is also possible), and ring topology		
Communication cable		Ethernet cable which satisfies 1000BASE-T standard: Category 5e or higher, straight cable (double shielded, STP)		
Maximum station-to-station distance		100m (conforms to ANSI/TIA/EIA-568-B (Category 5e))		
Overall cable distance		Line topology: 12000m (when 121 stations are connected) Star topology: Depends on the system configuration. Ring topology: 12100m (when 121 stations are connected)		
Number of cascade connections		20 levels maximum		
Maximum number of connectable stations		121 stations (master station: 1, slave station: 120)		
Maximum number of networks		239		
Communication method		Token passing		
Hardware specifications	Number of occupied I/O points		32 points	
	Internal current consumption (5VDC)		0.82A	
	External dimensions	Height	106mm (Base unit mounting side: 98mm)	
		Width	27.8mm	
		Depth	110mm	
Weight		0.17kg		



- *1 These are the maximum number of points that the master station can assign per station. A submaster station and a local station can receive data from other stations in addition to this number of points.
- *2 The RJ71EN71 does not support this function. For the RJ71GF11-T2, availability depends on the firmware version.
( MELSEC iQ-R CC-Link IE Field Network User's Manual (Application))
- *3 When "Communication Mode" under "Application Settings" is set to "High-Speed Remote Net", a submaster station and local stations cannot be connected.

Performance specifications of the remote head module

This section describes the performance specifications of the remote head module.

For the specifications of entire CC-Link IE Field Network, refer to the following.

 User's manual for the master/local module used

Item		Specifications
Maximum number of link points per station	RX	2K points (2048 points, 256 bytes)
	RY	2K points (2048 points, 256 bytes)
	RWr	1K points (1024 points, 2K bytes)
	RWw	1K points (1024 points, 2K bytes)
Station type	Intelligent device station	
Station number	1 to 120	
Network number	1 to 239	
Communication speed	1Gbps	
Network topology	Line topology, star topology (coexistence of line topology and star topology is also possible), and ring topology	
Communication cable	Ethernet cable which satisfies 1000BASE-T standard: Category 5e or higher, straight cable (double shielded, STP)  User's manual for the master/local module used	
Maximum station-to-station distance	100m (conforms to ANSI/TIA/EIA-568-B (Category 5e))	
Number of cascade connections	20 levels maximum	
Number of I/O points	Input relay (X)	4096 points (Number of points accessible to the actual module)*1
	Output relay (Y)	4096 points (Number of points accessible to the actual module)*1
Number of user device points	Input (X)	12288 points (Number of points used in the program. Assign X0 to RX0.)
	Output (Y)	12288 points (Number of points used in the program. Assign Y0 to RY0.)
	Link special relay (SB)	8192 points (SB0000 to SB0FFF: For system use, SB1000 to SB1FFF: User-changeable)
	Link register (W)	8192 points (Assign 1024 points (W0 to W3FF) from RWw0. Assign 1024 points (W1000 to W13FF) from RWr0.)
	Link special register (SW)	8192 points (SW0000 to SW0FFF: For system use, SW1000 to SW1FFF: User-changeable)
Number of system device points	Special relay (SM)	4096 points
	Special register (SD)	4096 points
Number of module access device points	Intelligent function module device (U□\G□)	268435456 points*2
Number of refresh data register points	Refresh data register (RD)	12288 points
Label capacity	2048 words	
Memory capacity	Device/label memory	256K bytes
	Data memory	2049K bytes
Number of storable files	Device/label memory	One (A system file is stored.)
	Data memory	256*3
Allowable momentary power failure time	The time differs depending on the power supply module used. ( MELSEC iQ-R Module Configuration Manual)	
Internal current consumption (5VDC)	0.75A	
External dimensions	Height	106mm (Base unit mounting side: 98mm)
	Width	27.8mm
	Depth	110mm
	Weight	0.20kg

*1 These are the maximum number of points that can be assigned to an actual module in "I/O Assignment Setting" in the [I/O Assignment] tab of the "System Parameter" window of the engineering tool.

*2 This is the maximum points that can be handled in the remote head module. The number of points actually used differs depending on the module used.

*3 The number indicates the number of files and folders (including system files and system folders) can be created in the root directory on the condition that the number of characters in the file or folder name is 13 or less. In a subdirectory, up to 32767 folders can be created. Note that the number of storable files and folders will decrease if many files and folders with a long name, more than 13 characters (including an extension), are created.

4 NETWORK CONFIGURATION FOR REDUNDANT SYSTEMS

Network configuration example

The following is an example network configuration for redundant systems. The network configuration procedure is described here using the following example. In this example network configuration, the programmable controller and the personal computer for monitoring are connected over Ethernet. The system A and the system B are connected over CC-Link IE Controller Network. The master station and the slave station are connected over CC-Link IE Field Network (redundant line).

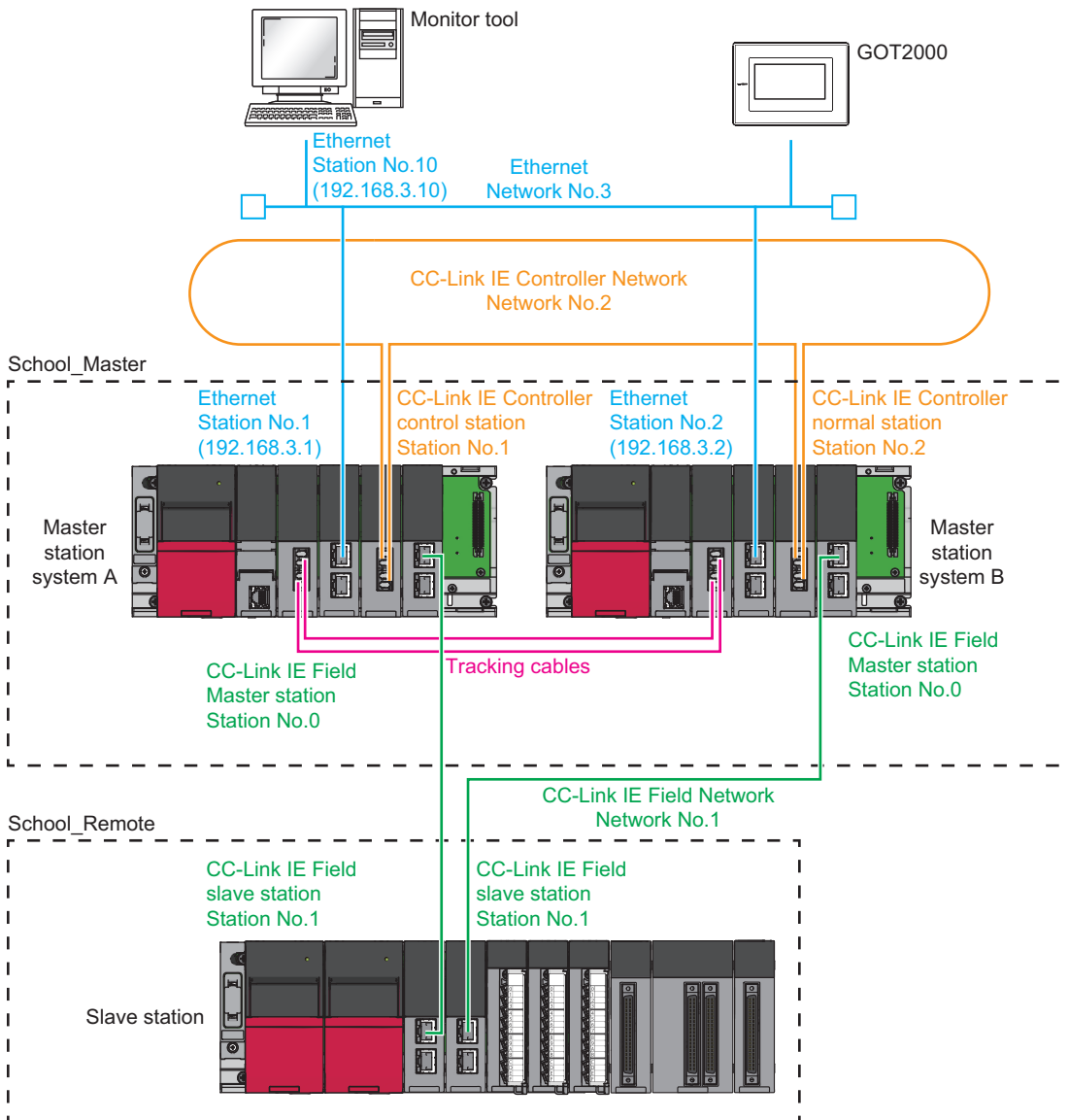

Device assignment example

Construct network in accordance with the example device assignments shown here. Arrows in the figure indicate the flow of data. Assign devices of the network modules to the devices of the CPU module, X, Y, and W, so that the communication areas do not overlap.

Note that the start device addresses for the refresh devices, RWw and RWr, of the remote head module (RJ72GF15-T2) are fixed to "RWw → W0, RWr → W1000". This cannot be changed.

■ Assignment map of X and Y devices

The following devices are used.

Device	Description
X	X device in the CPU module and the remote head module
Y	Y device in the CPU module and the remote head module
RX	A device in the CC-Link IE Field Network module. Bit data input from a slave station to the master station.
RY	A device in the CC-Link IE Field Network module. Bit data output from the master station to a slave station.

[Assignment map of X and Y devices]

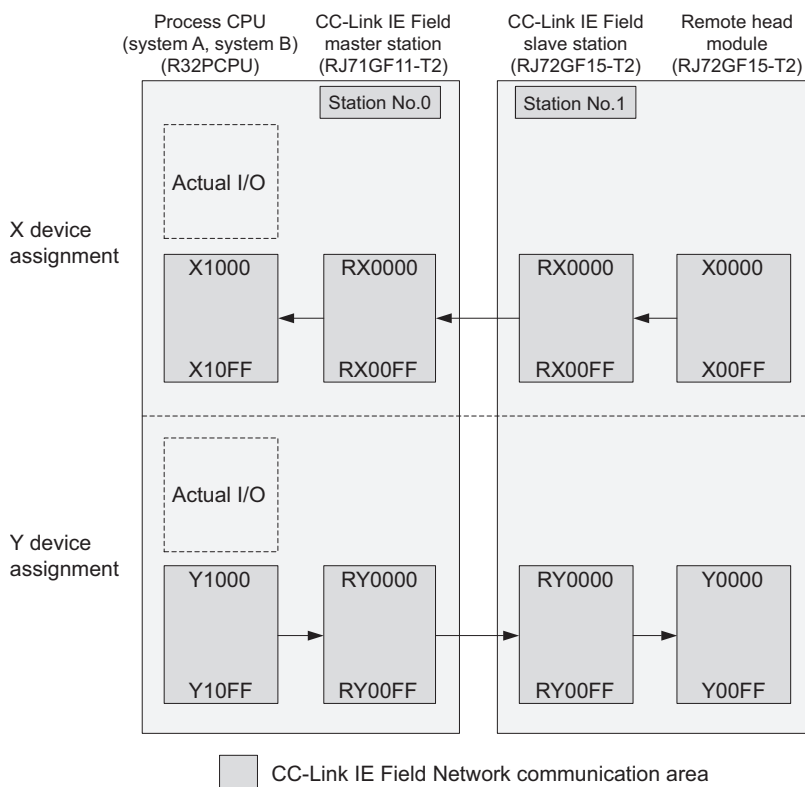

■Assignment map of W device

The following devices are used.

Device	Description
W	W device in the CPU module and the remote head module
RWr	A device in the CC-Link IE Field Network module. Word data input from a slave station to the master station.
RWw	A device in the CC-Link IE Field Network module. Word data output from the master station to a slave station.

[Assignment map of W device]

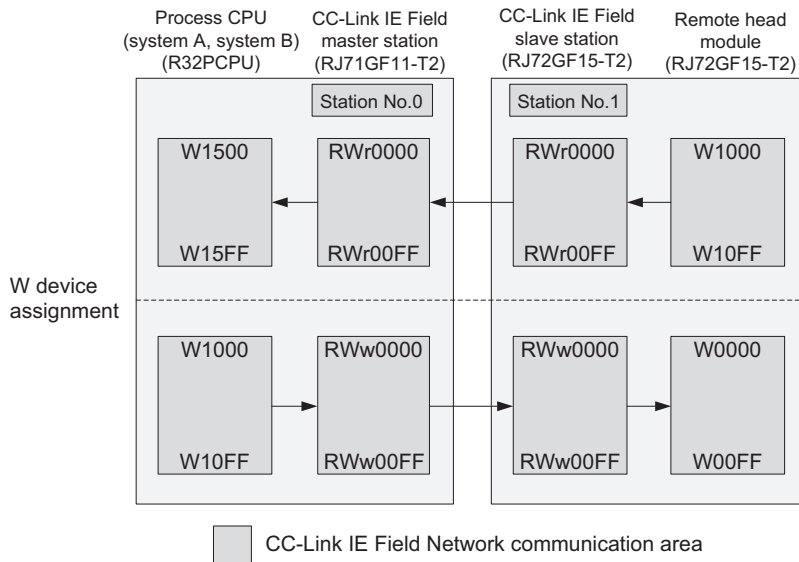

Role of CC-Link IE Field Network and example device assignment

In CC-Link IE Field Network communications, the CPU module sends/receives I/O signals to/from external devices through the input and output modules mounted on the slave station. The X, Y, and W devices are used as shown below.

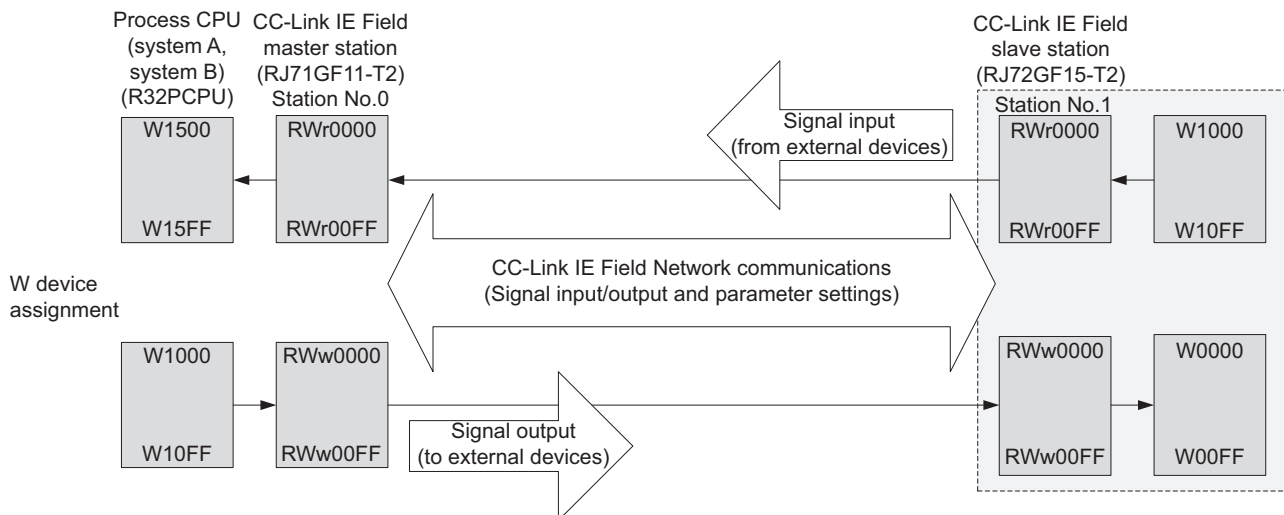
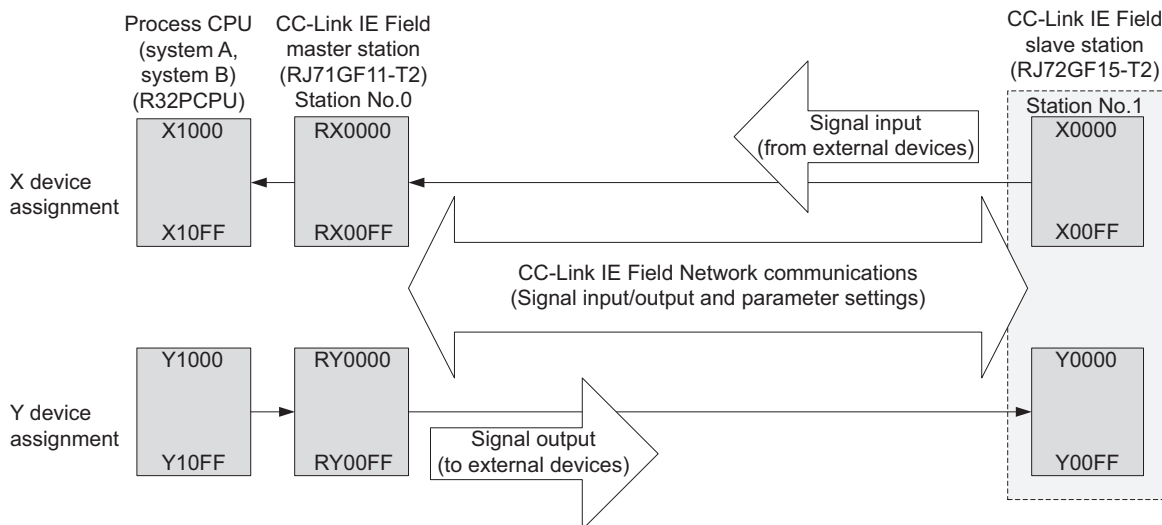

4.1 Powering on the System

Power on the configured system.

Master station

1. Check that the RUN/STOP/RESET switch of the Process CPU is in the STOP position.

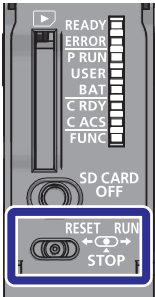

2. Power on the system. Check that the following LEDs turn on.

- (1) Power supply module: POWER
- (2) Process CPU: READY
- (3) Redundant function module: RUN
- (4) Ethernet module: RUN
- (5) CC-Link IE Field Network module: RUN
- (6) CC-Link IE Controller Network module: RUN

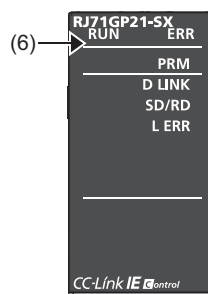
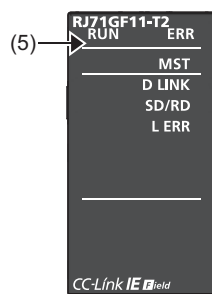
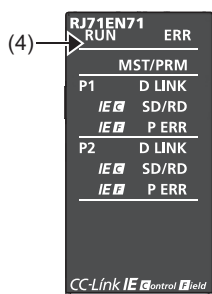
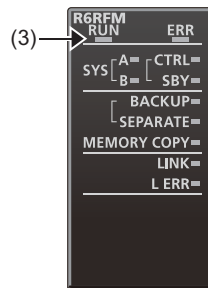
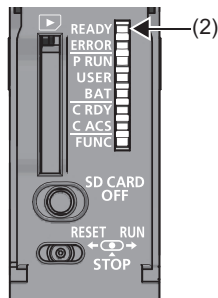

Slave station

1. Check that the RUN/STOP/RESET switch of the remote head module is in the STOP position.

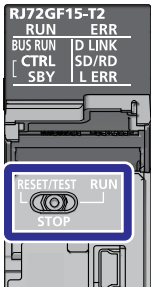

2. Power on the system. Check that the following LEDs turn on.

- (1) Power supply module: POWER
- (2) Remote head module: RUN

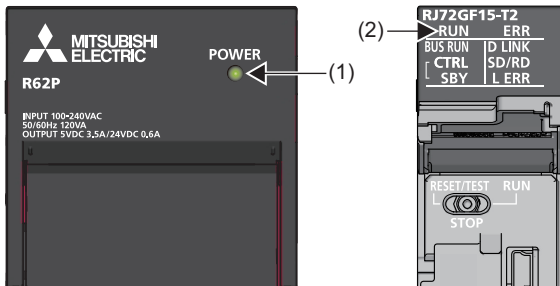

4.2 Creating a Project (Master Station)

This section describes how to create a new project for the master station using GX Works3.

Creating a new project

Create a project for the master station, "School_Master".

Operating procedure

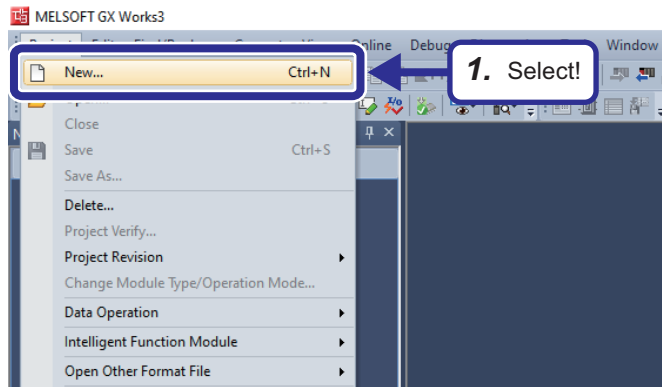

1. Select [Project] ⇒ [New].

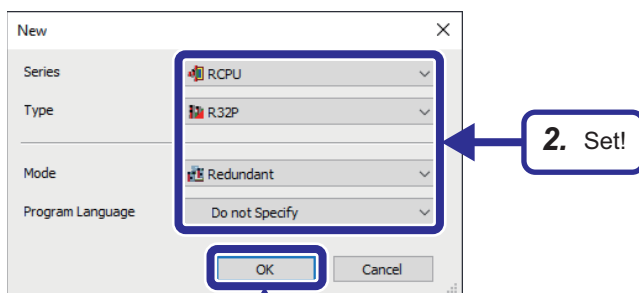

2. The "New" window appears. Set the CPU module model ("Type"), operation mode ("Mode"), and programming language ("Program Language") as shown on the left.

3. Click the [OK] button.

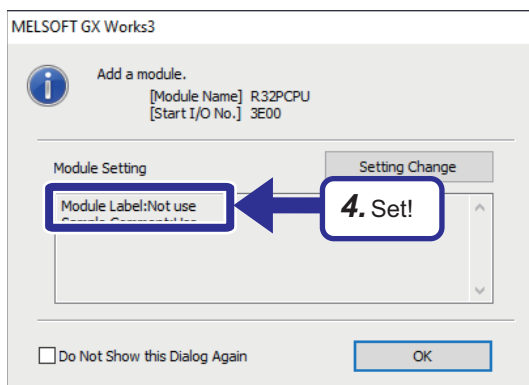

4. Set the R32PCPU module label to "Not use".

Setting the system (system A or system B)

Define system A and system B using GX Works3.

Operating procedure

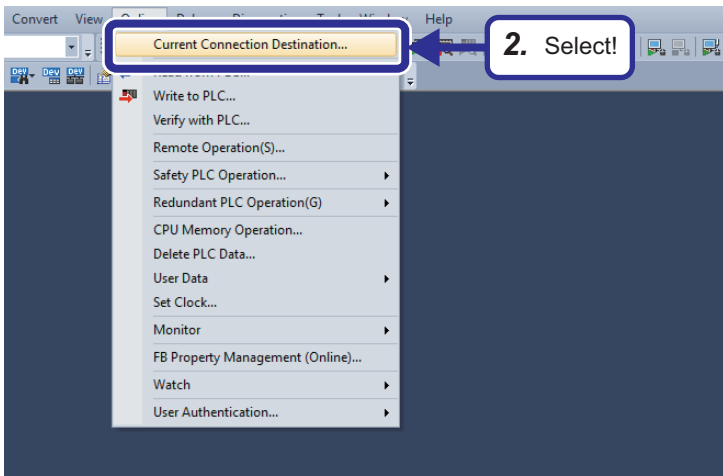

1. Connect a USB cable to the Process CPU to be set as system A.
2. Select [Online] ⇒ [Current Connection Destination] to open the "Specify Connection Destination" window.

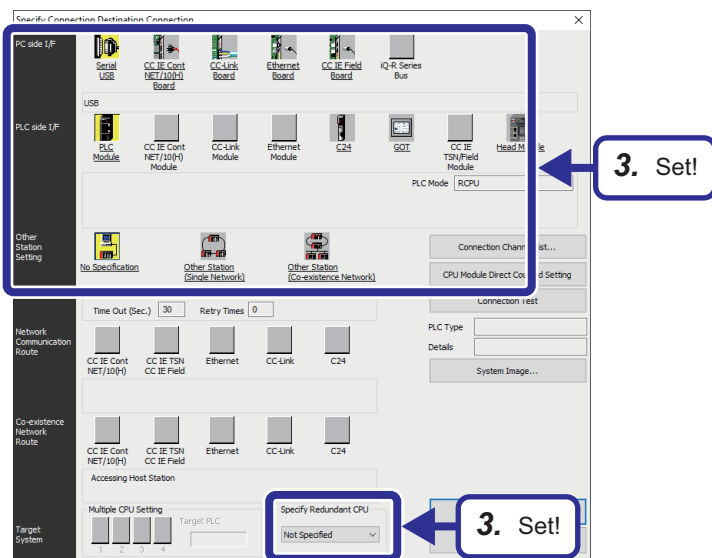

3. Set the following:
 [Settings]
 PC side I/F: Serial USB
 PLC side I/F: PLC Module
 Other Station Setting: No Specification
 Specify Redundant CPU: Not Specified

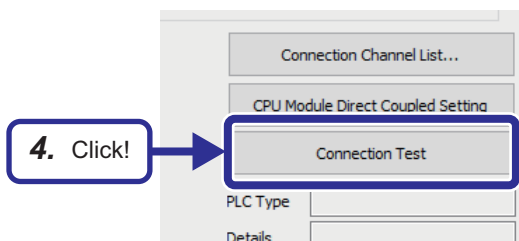

4. Click the [Connection Test] button.



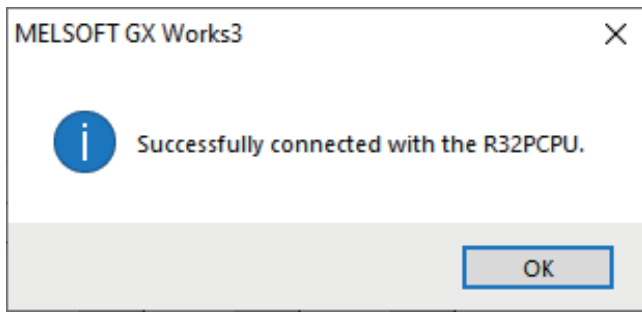

5. Check that the connection with the CPU module has been successfully established.

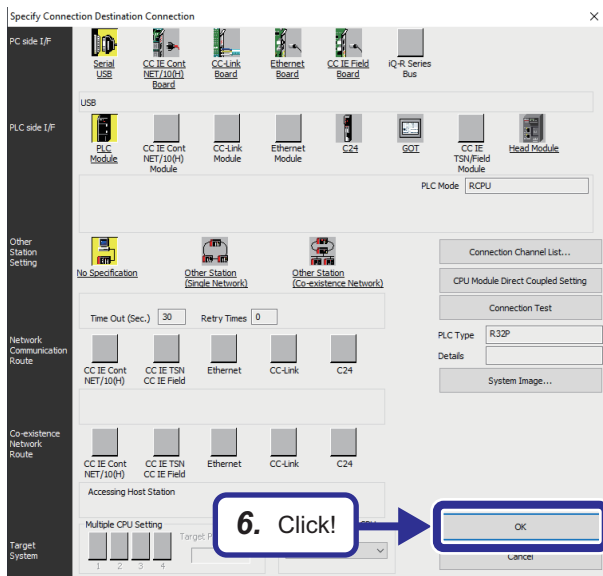

6. Click the [OK] button.

4

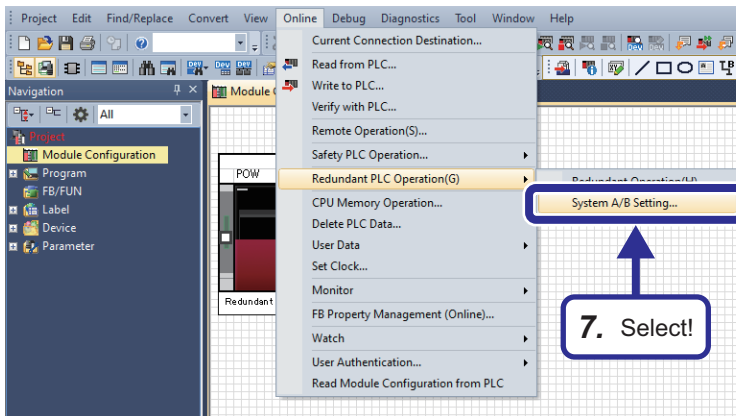

7. Select [Online] ⇒ [Redundant PLC Operation] ⇒ [System A/B Setting].



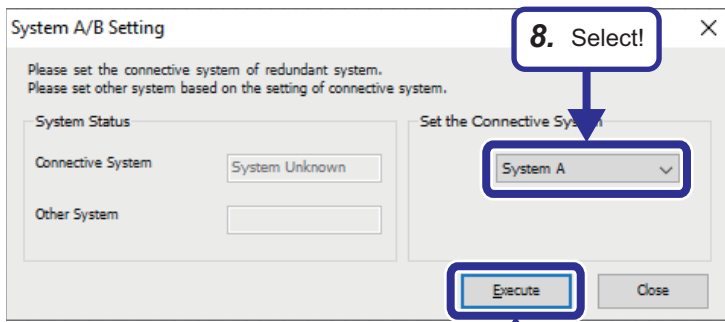

8. Select "System A" or "System B" for the connective system. Select "System A" here. When the system A is selected as the connective system, the other system automatically becomes system B.

9. Click the [Execute] button.

9. Click!

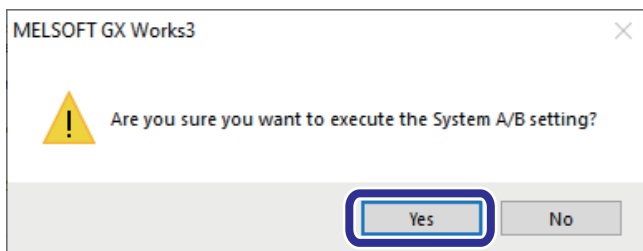

10. Click the [Yes] button.

10. Click!

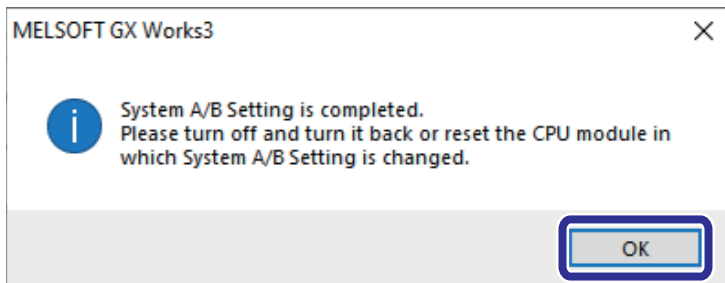

11. The window shown on the left appears. Click the [OK] button.

12. The "System A/B Setting" window is displayed again. Click the [Close] button.



13. Move the RUN/STOP/RESET switch of the CPU module to the RESET position once (for approximately one second) to reset the CPU module.*1

11. Click!

*1 If the system A/B setting is set to the Process CPU that is not running in redundant mode, powering off and on the system or resetting the CPU module turns off the SYS A LED or SYS B LED of the redundant function module. The LED turns on after the project is written. (Page 140 Writing the Projects)

■Checking method

Check the LEDs of each redundant function module to check the system status.

Setting of the engineering tool	LED of the redundant function module
System A	
System B	
When the setting is switched from "System A" to "System B"	 <p>When the setting is switched to "System B", the SYS B LED flashes. Powering off and on the system or resetting the CPU module turns off the SYS A LED and turns on the SYS B LED.</p>

Point

Users can also check the system status on the engineering tool. (📖 GX Works3 Operating Manual)

- System monitor
- "System A/B Setting" window
- Monitor status bar

Precautions

- Do not power off the system or reset the CPU module during the system A/B setting. The system A/B setting may not be reflected properly. If not reflected properly, set the system again.
- For the system A/B setting, use the CPU module that is connected with a USB cable or an Ethernet cable. If the connection destination has been changed on the engineering tool, the system A/B setting cannot be set.
- The system A/B information cannot be deleted once it is set. The information can only be changed.
- If the system A/B setting has not been set or the same system A/B setting has been set when both systems are started up simultaneously, a stop error occurs at the point when tracking communications are established. Set the system A/B setting correctly in both systems.
- If a system with no system A/B setting is started up first, a stop error occurs at the point when tracking communications are established. Set the system A/B setting correctly in both systems.
- Do not connect system A and system A or system B and system B with tracking cables while running. If connected, a continuation error occurs.

Point

Besides the method that uses the engineering tool, the system A/B setting can be automatically set by the systems themselves.

Setting one system as system A and bringing it into a tracking communicable state can automatically set the other system as system B, and vice versa.

In the system that is automatically set as system A or system B, the original system A/B setting will be overwritten. This can be checked in the event history. (Event code: 00700)

- When a system with no system A/B setting is connected to the system that is set as system A, the system with no system A/B setting is automatically set as system B. (This event is not recorded in the event history.)
- When a system that is set as system A is connected to another system that is also set as system A, the system that is powered off and on or whose CPU module is reset is automatically set as system B. (This event is recorded in the event history.)

Setting the module configuration

Set the module configuration in GX Works3, and define the system configuration of the master station.

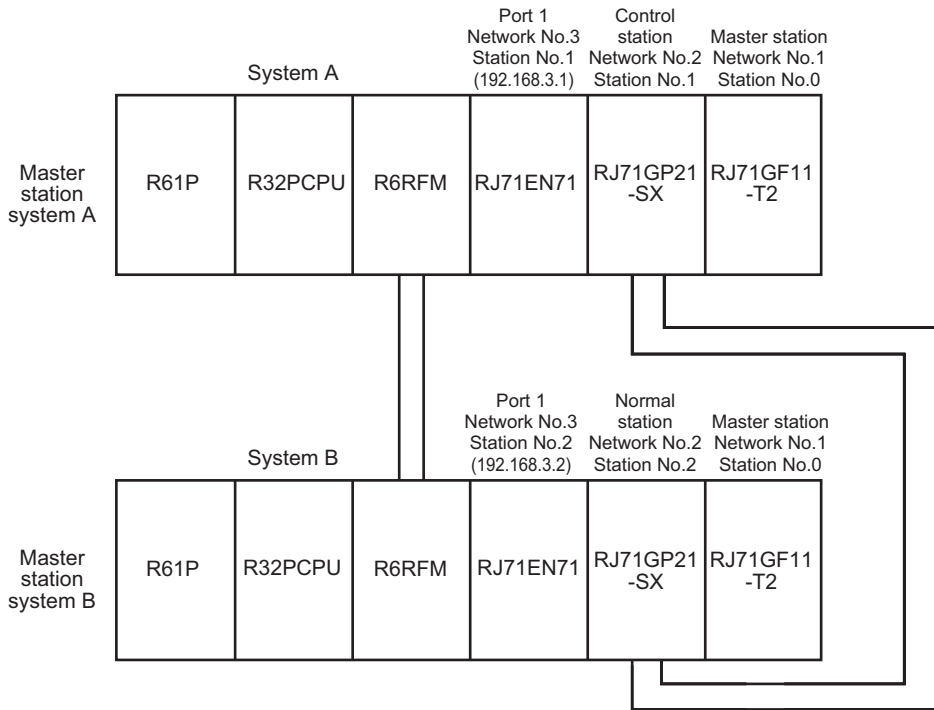

Operating procedure

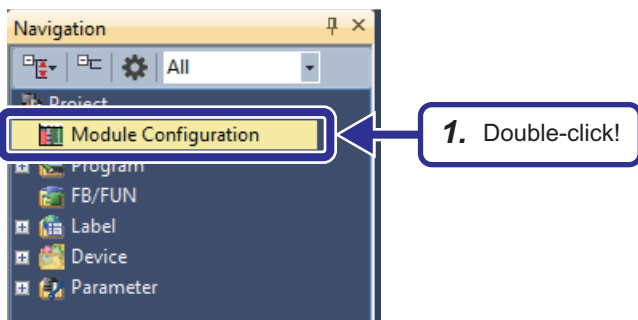

1. In the Navigation window, double-click [Module Configuration].

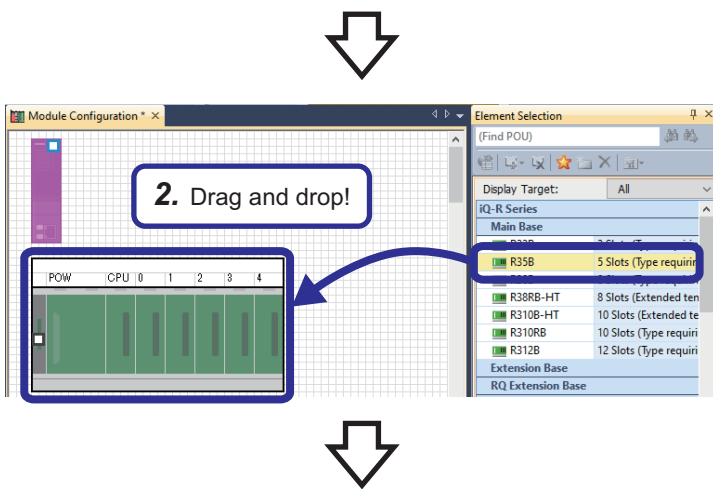

2. Select a main base unit "R35B" from "Main Base" in the "Element Selection" window, and drag and drop it to the "Module Configuration" window.

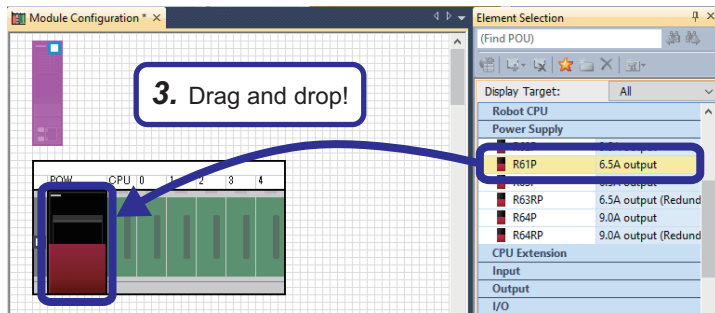

3. Select a power supply module "R61P" from "Power Supply" in the "Element Selection" window, and drag and drop it to the power supply slot of the R35B, which has been added to the "Module Configuration" window.

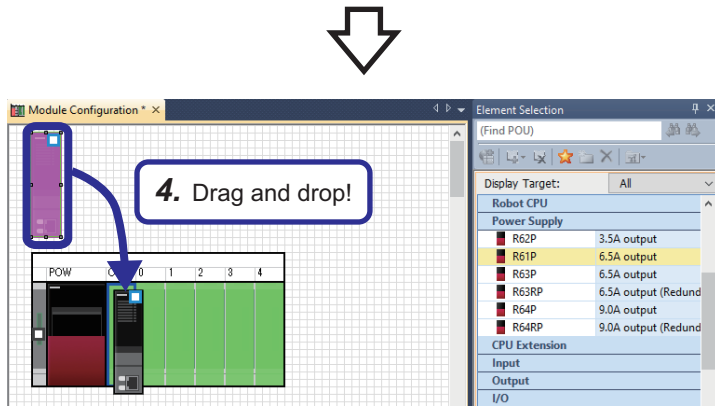

4. Drag and drop the R32PCPU displayed by default on the "Module Configuration" window to the CPU slot of the R35B. Do not use CPU modules in the "Element Selection" window because they are for a multiple CPU system.

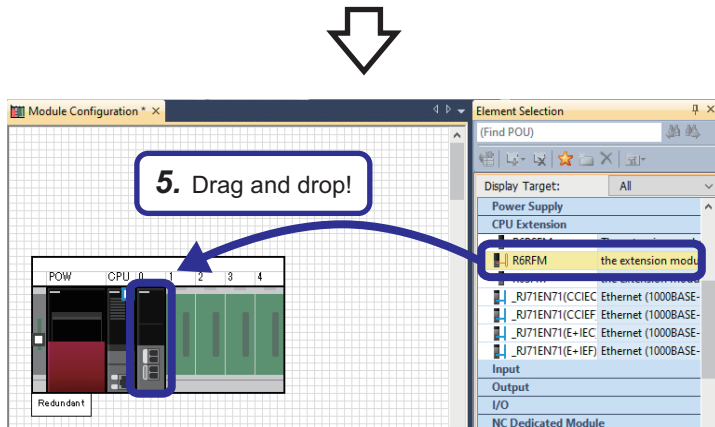

5. Select a redundant function module "R6RFM" from "CPU Extension" in the "Element Selection" window, and drag and drop it to the slot No.0 of the R35B.

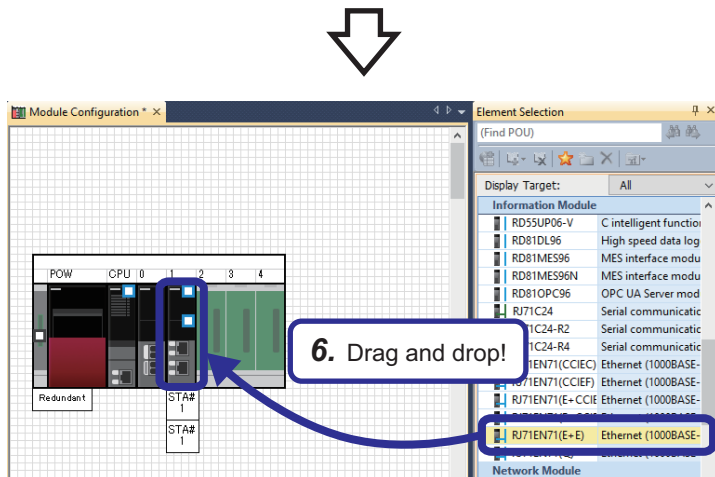

6. Select an Ethernet module "RJ71EN71(E+E)" from "Information Module" in the "Element Selection" window, and drag and drop it to slot No.1 of the R35B.

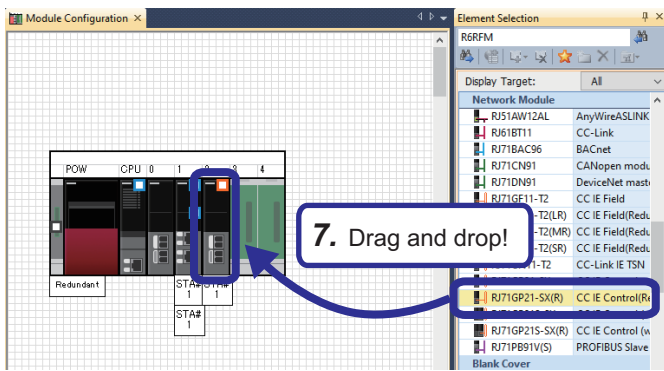

7. Select a CC-Link IE Controller Network module "RJ71GP21-SX(R)" from "Network Module" in the "Element Selection" window, and drag and drop it to slot No.2 of the R35B.

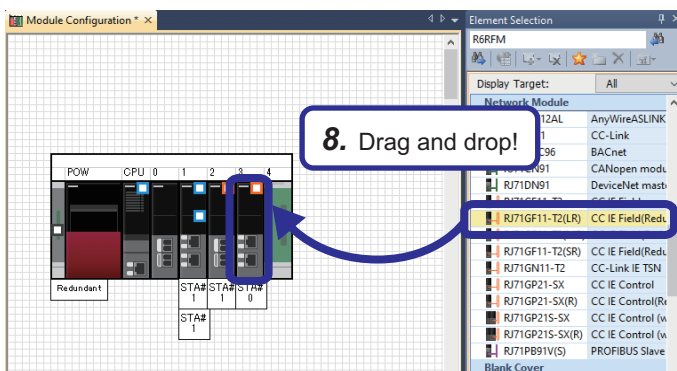

8. Select a CC-Link IE Field Network module "RJ71GF11-T2(LR)" from "Network Module" in the "Element Selection" window, and drag and drop it to slot No.3 of the R35B.

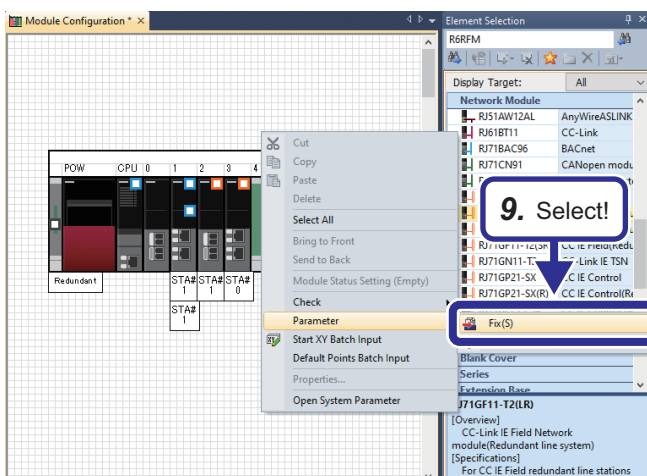

9. Right-click and select [Parameter] ⇒ [Fix] to fix the parameters.



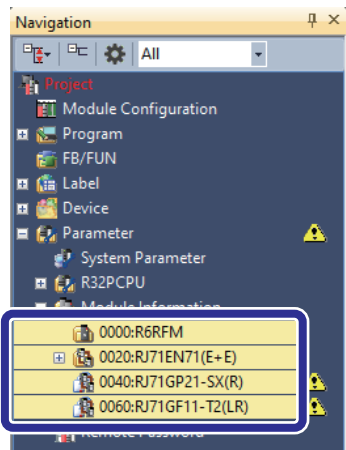
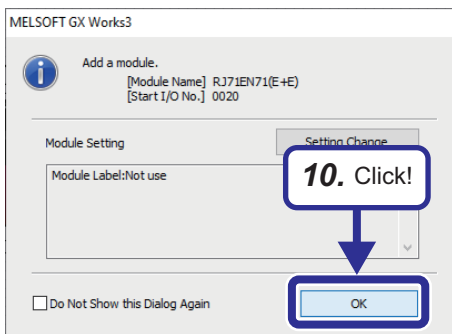

10. The window shown on the left appears for each module. Click the [OK] button.

11. The module information is automatically registered on the Navigation window.

Point 

Six types of elements are available for the Ethernet module (RJ71EN71). The differences between them are as follows. Note that only (E+E) or (Q) is available for the redundant system.

- (CCIEC): Both port 1 and port 2 are used for CC-Link IE Controller Network.
- (CCIEF): Both port 1 and port 2 are used for CC-Link IE Field Network.
- (E+CCIEC): Port 1 is used for Ethernet, and port 2 is used for CC-Link IE Controller Network.
- (E+CCIEF): Port 1 is used for Ethernet, and port 2 is used for CC-Link IE Field Network.
- (E+E): Both port 1 and port 2 are used for Ethernet.
- (Q): Port 1 is used for the Q-compatible Ethernet mode, and port 2 is not used. The Q-compatible Ethernet mode ensures that module I/O signals and buffer memory addresses are compatible with those of the MELSEC-Q series.

Four types of elements are available for the CC-Link IE Field Network module (RJ71GF11-T2). The differences between them are as follows.

- (LR): For a redundant line configuration
- (MR): For a redundant master station configuration
- (SR): For a redundant slave station configuration
- None: For a single system configuration

Two types of elements are available for the CC-Link IE Controller Network module (RJ71GP21-SX). The differences between them are as follows.

- (R): For a redundant system with a redundant line configuration
- None: For a single system configuration

Setting network parameters

Set parameters required for configuring each network.

Ethernet parameter settings

This section describes parameters required for Ethernet communications in the network configuration where the redundant system is connected to the personal computer via the Ethernet module (RJ71EN71).

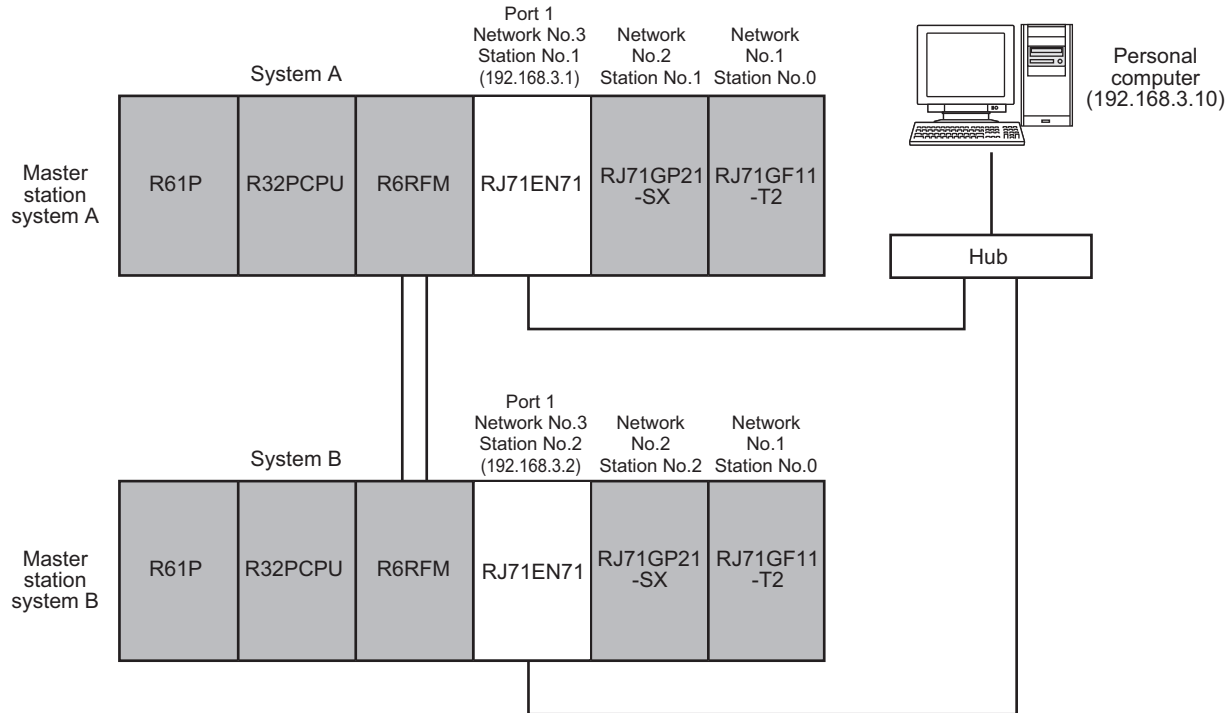

■Setting the module parameters

Set the module parameters of the RJ71EN71. Set different station numbers and IP addresses in the system A and the system B.

Operating procedure

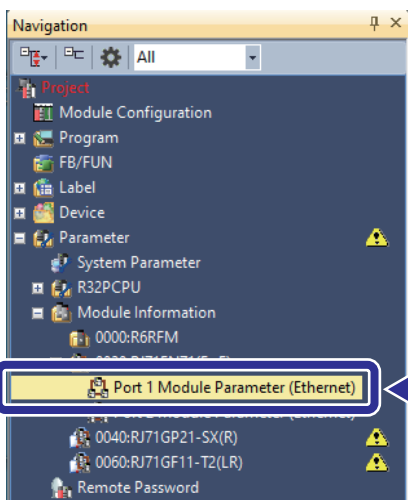

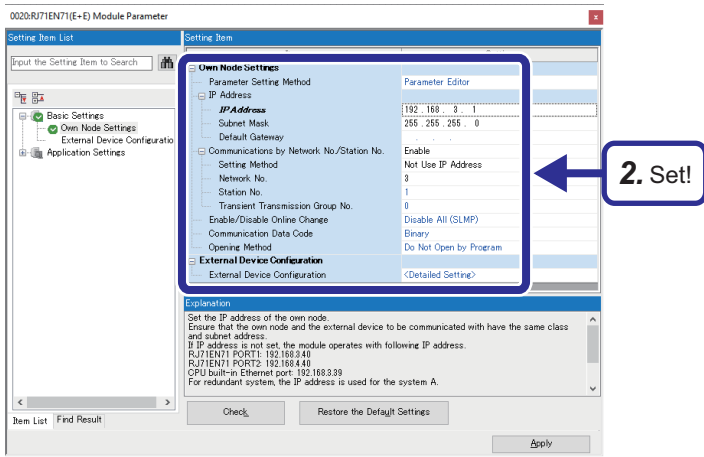

1. In the Navigation window, double-click "Port 1 Module Parameter (Ethernet)" of the Ethernet module.

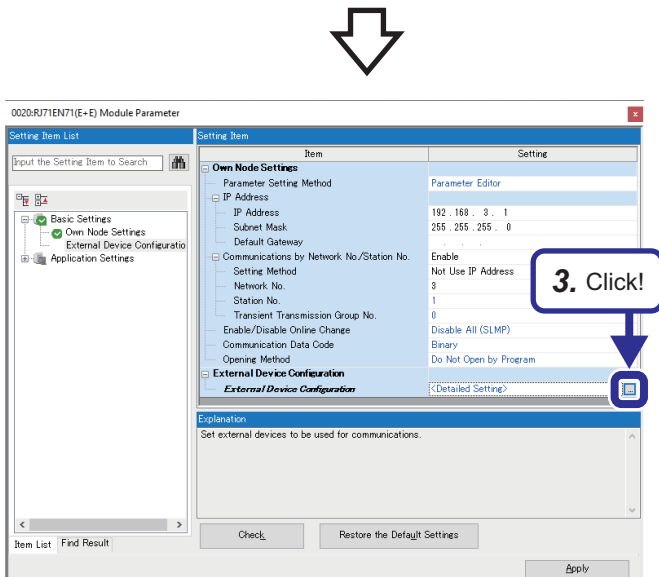

- Set "Basic Settings" as follows:
 [Settings]
 IP Address: 192.168.3.1
 Subnet Mask: 255.255.255.0
 Communications by Network No./Station No.:
 Enable
 Setting Method: Not Use IP Address
 Network No.: 3
 Station No.: 1

Point When writing the settings, the message "Overlap in module (00XX:RJ71XXXXX) network No." may be displayed. In this case, open the "Module Parameter" window of the displayed network module, and assign a different network number.



- Select "External Device Configuration", and click the  button.

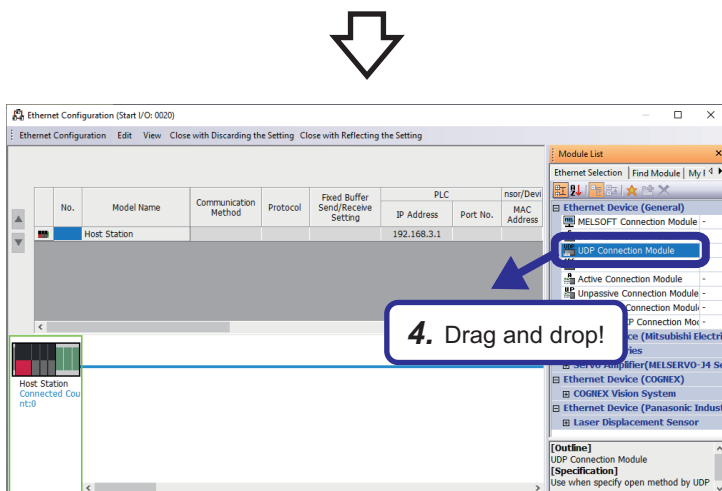

- The "Ethernet Configuration" window appears. Select "UDP Connection Module" from "Ethernet Device (General)" in "Module List", and drag and drop it to "List of devices" or "Device Map Area".

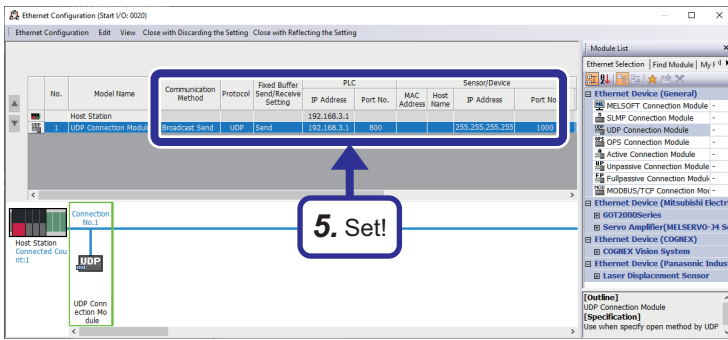

- A UDP connection module is added to "List of devices".
Set the following to the UDP connection module:
[Settings]
Communication Method: Broadcast Send
Port No. (PLC): 800
Port No. (Sensor/Device): 1000

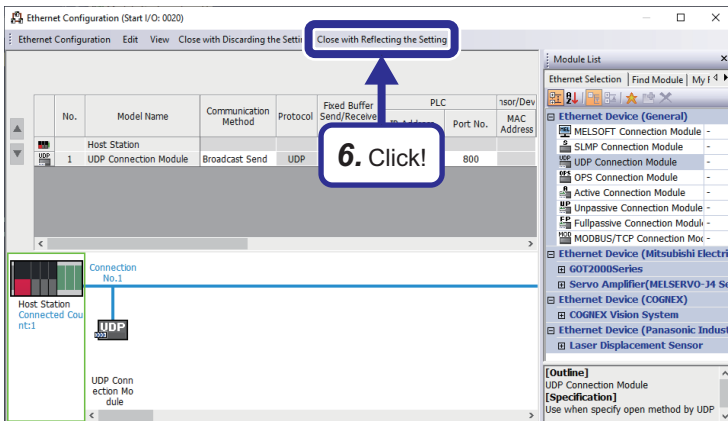

- Click [Close with Reflecting the Setting] on the menu bar to close the "Ethernet Configuration" window.

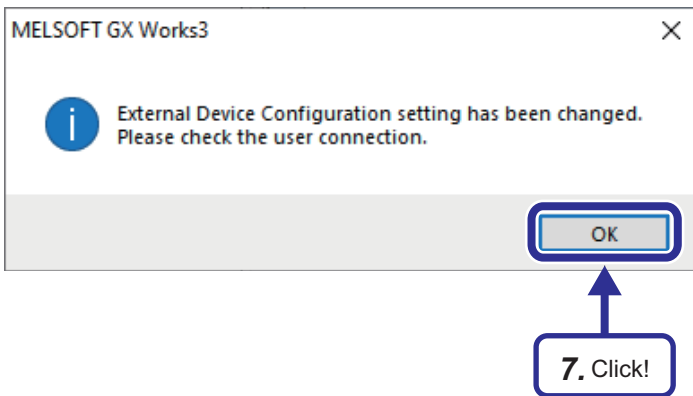

- The user connection confirmation window appears. Click the [OK] button.



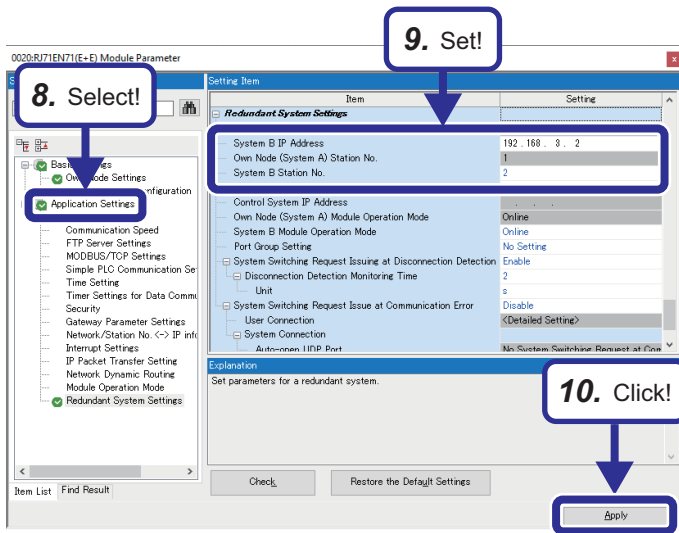

8. Select "Application Settings" in the "Setting Item List".

9. Set the "Redundant System Settings" as follows.

[Settings]

System B IP Address: 192.168.3.2

System B Station No.: 2

10. Click the [Apply] button.

Point

- When "Use IP Address" is selected for "Setting Method", the network number and station number are set from the third and fourth octets of the IP address. For example, when the IP address is set to 192.168.3.1, the network number is set to 3 and the station number is set to 1. For details, refer to the following.
 📖 MELSEC iQ-R Ethernet User's Manual (Application)
- Select "Not Use IP Address" for "Setting Method" for the Ethernet module used in the demonstration machine because the network number is set to 3.
- By setting the same IP address (control system IP address) for both system A and system B, the module can continue data communications without changing the connection destination in the program even when system switching occurs. (Both systems identical IP address setting function) For details, refer to the following.
 📖 MELSEC iQ-R Ethernet User's Manual (Application)
- For the demonstration machine, the control system IP address setting is not required.

■ Setting the options

Set the options to enable the event notification function. The event notification function monitors alarms and events using the monitor tool and suppresses communication traffic.

Operating procedure

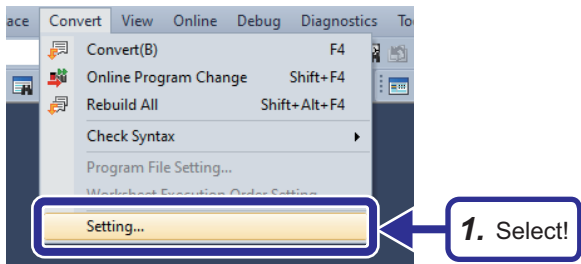

1. Select [Convert] ⇒ [Setting] to open the "Options" window.

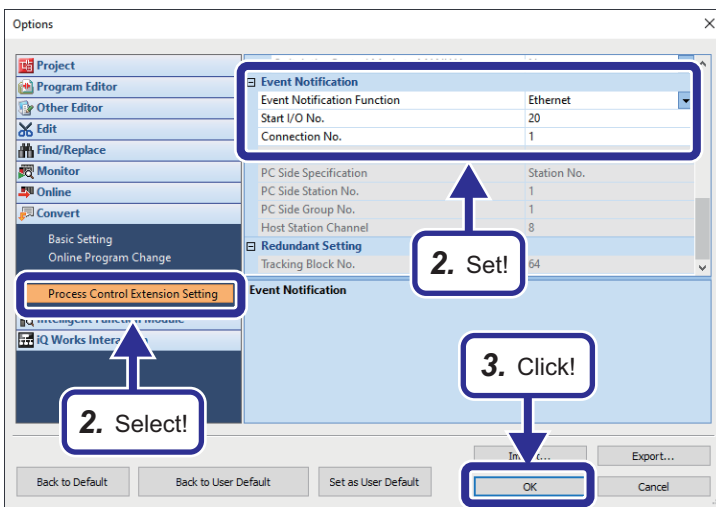

2. Select "Process Control Extension Setting" and set "Event Notification" as follows:
[Settings]
Event Notification Function: Ethernet
Start I/O No.: 20
Connection No.: 1
3. Click the [OK] button.

CC-Link IE Controller Network parameter settings

This section describes parameters required for CC-Link IE Controller Network communications in the network configuration where system A and system B in the redundant system are connected via the CC-Link IE Controller Network module (RJ71GP21-SX).

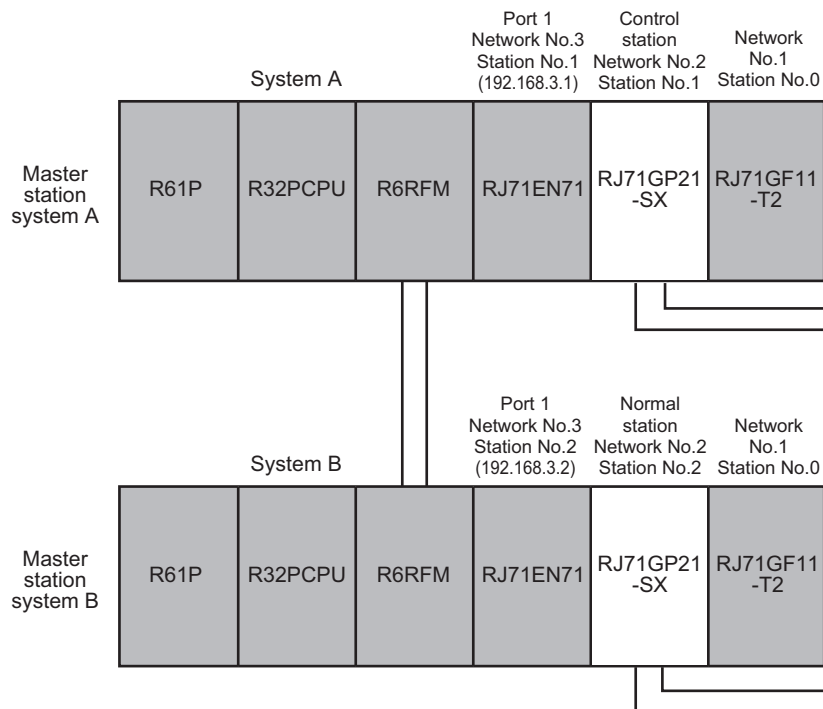

Setting the module parameters

Set the module parameters of the RJ71GP21-SX.

Operating procedure

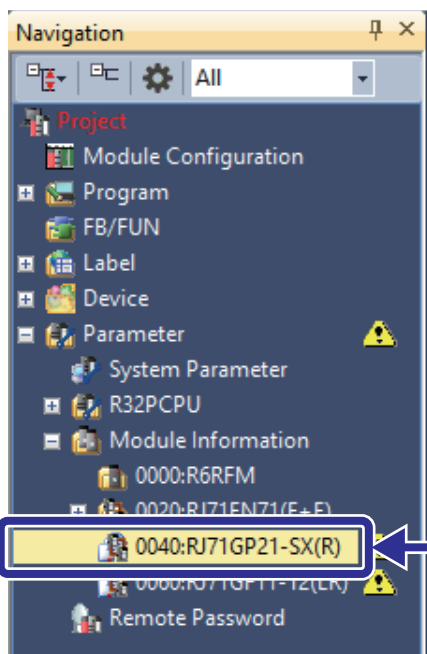

1. In the Navigation window, double-click "0040:RJ71GP21-SX(R)" (CC-Link IE Controller Network module).

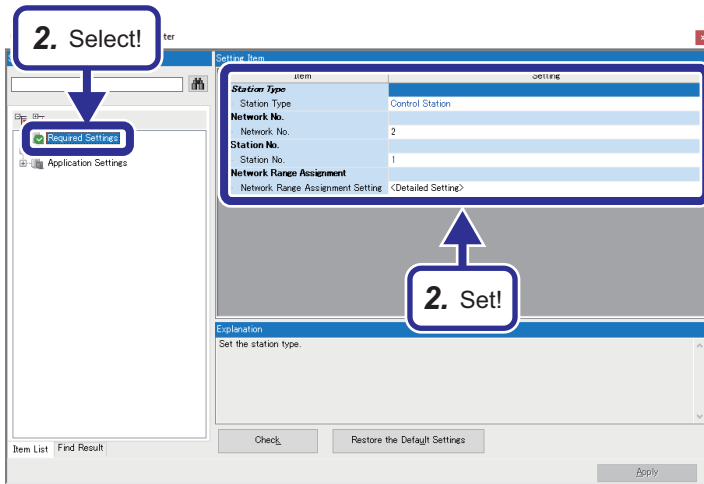

- Set "Required Settings" as follows:
[Settings]
Station Type: Control Station
Network No.: 2
Station No.: 1

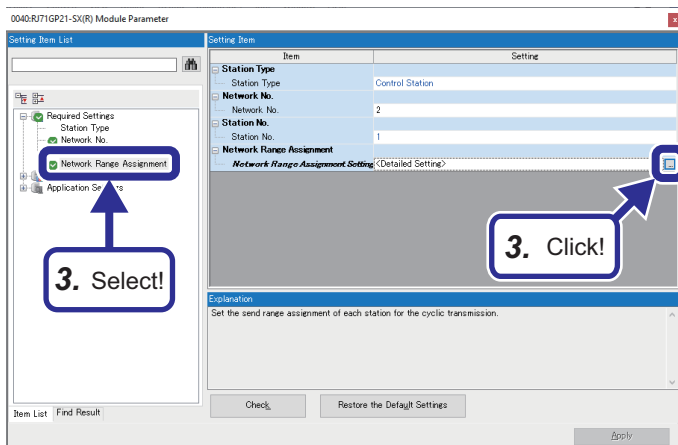

- Select "Network Range Assignment", and click the  button.

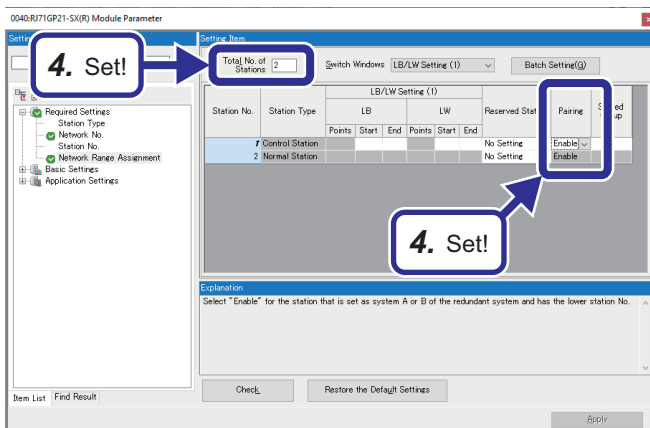

- Set "Network Range Assignment" as follows:
[Settings]
Total No. of Stations: 2
Pairing: Enable



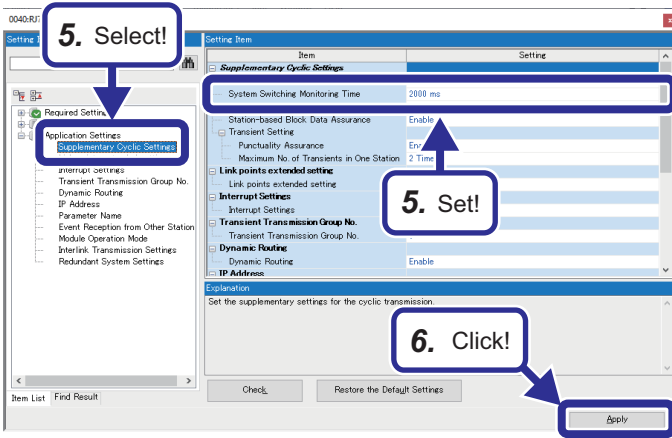

5. Select "Application Settings", and set "System Switching Monitoring Time" to "2000ms".
6. Click the [Apply] button.

4

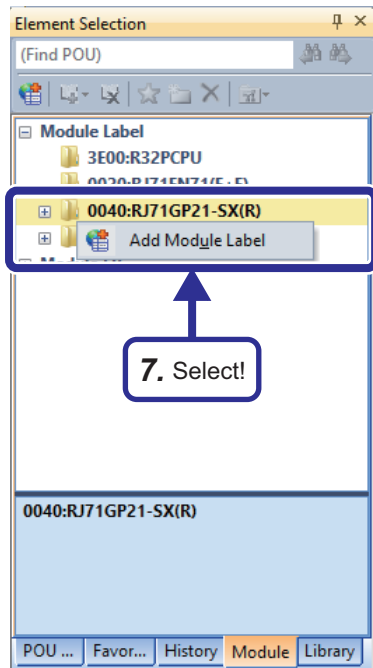

7. Add the module label. On the "Module" tab of the "Element Selection" window, right-click "0040:RJ71GP21-SX(R)", and select [Add Module Label].

CC-Link IE Field Network parameter settings

This section describes parameters required to start CC-Link IE Field Network communications in a redundant line network configuration where the CC-Link IE Field Network module (RJ71GF11-T2) is mounted on both master stations and two CC-Link IE Field remote head modules (RJ71GF15-T2) are mounted on the slave station.

Set parameters of the CC-Link IE Field Network module on the master station.

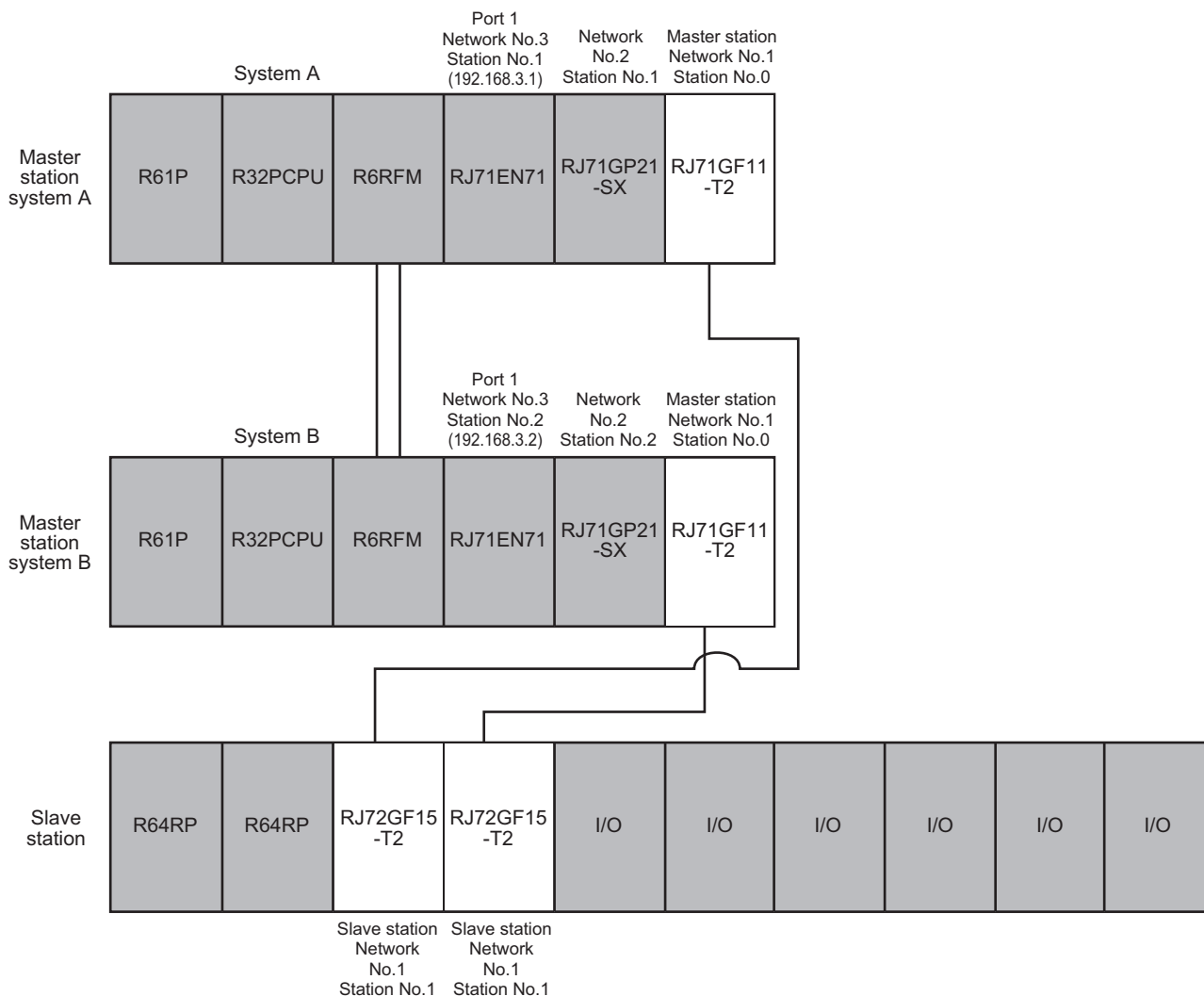

■Setting the module parameters

Set the refresh range referring to the following signal assignment table.

- CC-Link IE Field Network signal assignment table

Device of the R32PCPU on the master station	Refresh device of the RJ71GF11-T2 on the master station	Send direction	Refresh device of the RJ72GF15-T2 on the slave station*1	Device of the RJ72GF15-T2
X1000 to X10FF	RX0000 to RX00FF	←	RX1000 to RX10FF	X0000 to X00FF
Y1000 to Y10FF	RY0000 to RY00FF	→	RY1000 to RY10FF	Y0000 to Y00FF
W1500 to W15FF	RWr0000 to RWr00FF	←	RWr0000 to RWr00FF	W1000 to W10FF
W1000 to W10FF	RWw0000 to RWw00FF	→	RWw0000 to RWw00FF	W0000 to W00FF

*1 Note that the start device addresses for the refresh devices, RWw and RWr, of the remote head module (RJ72GF15-T2) are fixed to "RWw → W0, RWr → W1000".

Operating procedure

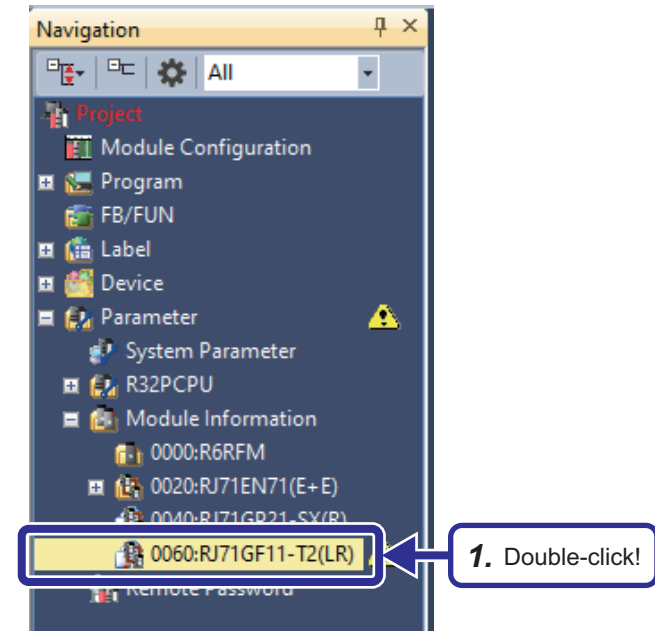

1. In the Navigation window, double-click "0060:RJ71GF11-T2(LR)" (CC-Link IE Field Network module).

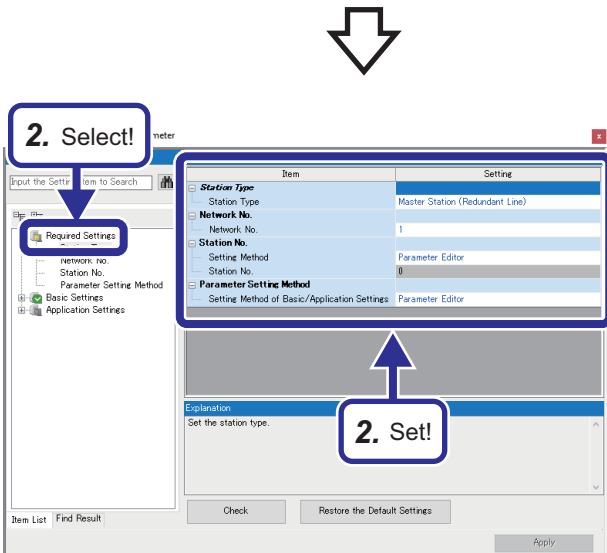

2. Set "Required Settings" as follows:
[Settings]
Station Type: Master Station (Redundant Line)
Network No.: 1
Setting Method: Parameter Editor
Setting Method of Basic/Application Settings: Parameter Editor

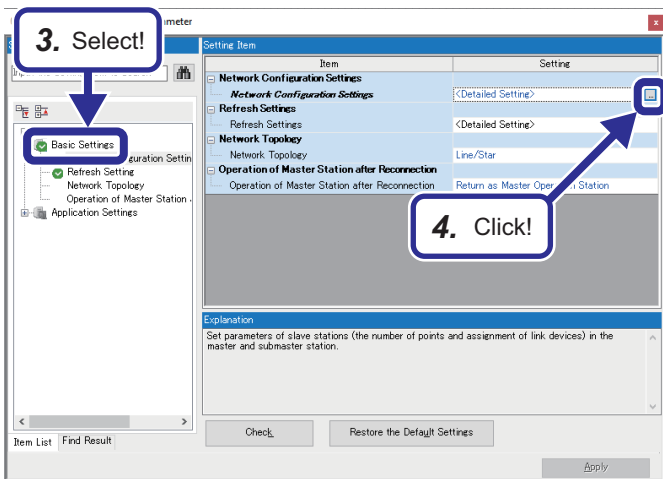

3. Select "Basic Settings" in the "Setting Item List".
4. Click the  button for "Network Configuration Settings".

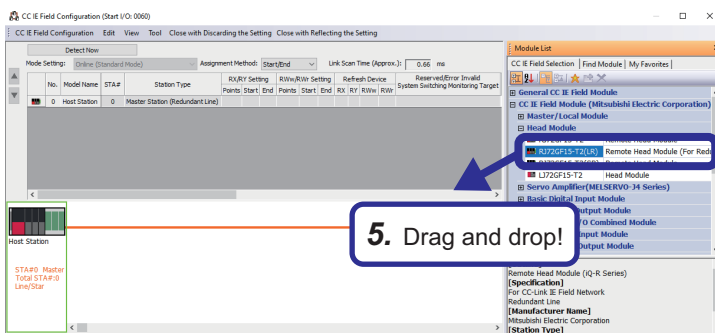

5. The "CC IE Field Configuration" window appears. Select "RJ72GF15-T2(LR)" from "Head Module" in "Module List", and drag and drop it to "List of devices" or "Device map area".

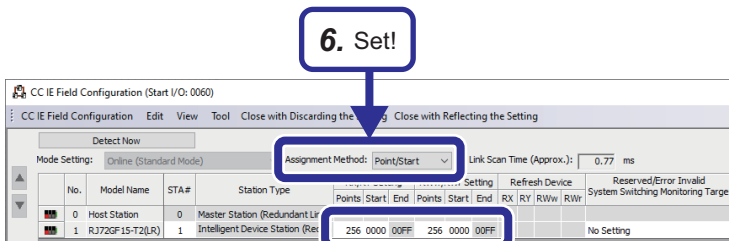

6. The RJ72GF15-T2(LR) is added to "List of devices". Change "Assignment Method" to "Point/Start", and set the following to the RJ72GF15-T2(LR):
 [Settings]
 Points (RX/Ry Setting): 256
 Start (RX/Ry Setting): 0000
 Points (RWw/RWw Setting): 256
 Start (RWw/RWw Setting): 0000



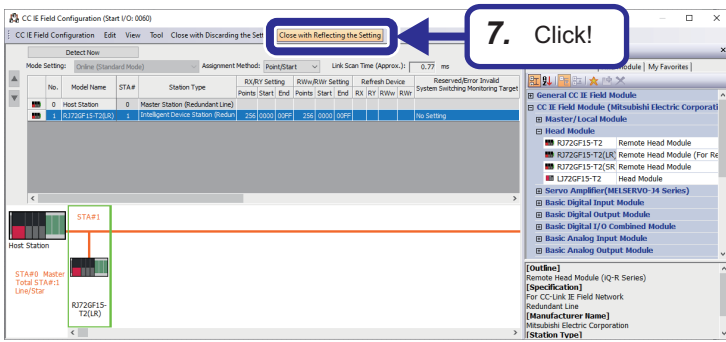

- Click [Close with Reflecting the Setting] on the menu bar to close the "CC IE Field Configuration" window.

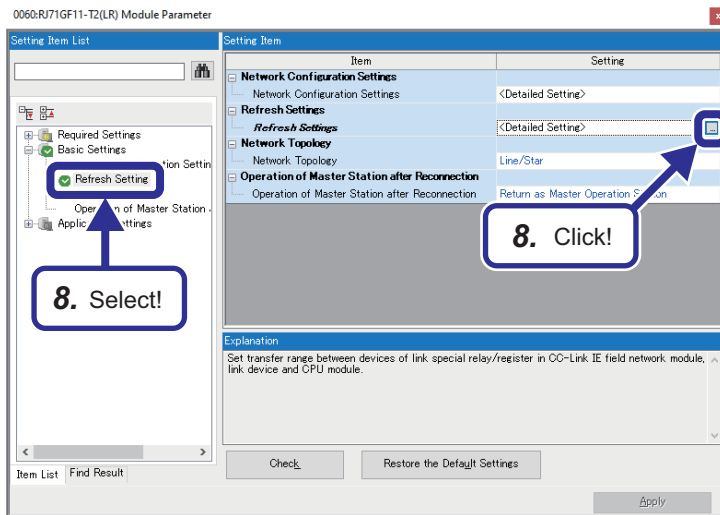

- Select "Refresh Setting", and click the button.

4



No.	Link Side					CPU Side				
	Device Name	Points	Start	End		Target	Device Name	Points	Start	End
-	SB	512	00000	001FF	↔	Module Label				
-	SW	512	00000	001FF	↔	Module Label				
1	RX	256	00000	000FF	↔	Specify Device	X	256	01000	010FF
2	RY	256	00000	000FF	↔	Specify Device	Y	256	01000	010FF
3	RW _r	256	00000	000FF	↔	Specify Device	W	256	01500	016FF
4	RW _w	256	00000	000FF	↔	Specify Device	W	256	01000	010FF
5					↔					
6					↔					
7					↔					

- Set the link devices and their ranges as shown on the left.



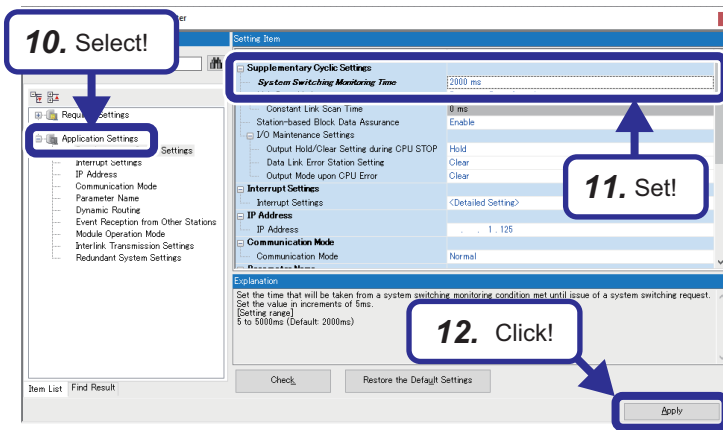

10. Select "Application Settings" in the "Setting Item List".

11. Set "System Switching Monitoring Time" to "2000ms".

12. Click the [Apply] button.

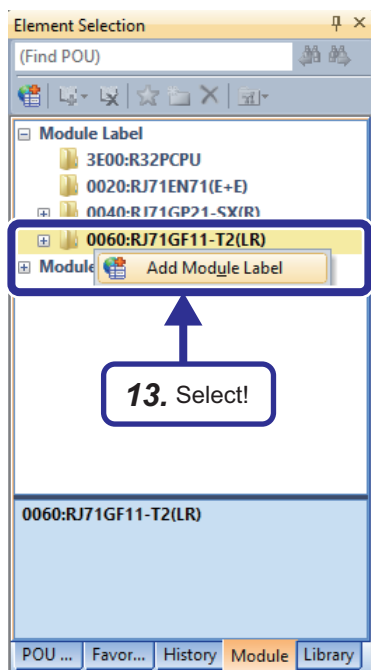

13. Add the module label. On the "Module" tab of the "Element Selection" window, right-click "0060:RJ71GF11-T2(LR)", and select [Add Module Label].

4.3 Creating a Project (Slave Station)

This section describes how to create a new project for the slave station using GX Works3.

Creating a new project

Create a project for the slave station, "School_Remote".

Operating procedure

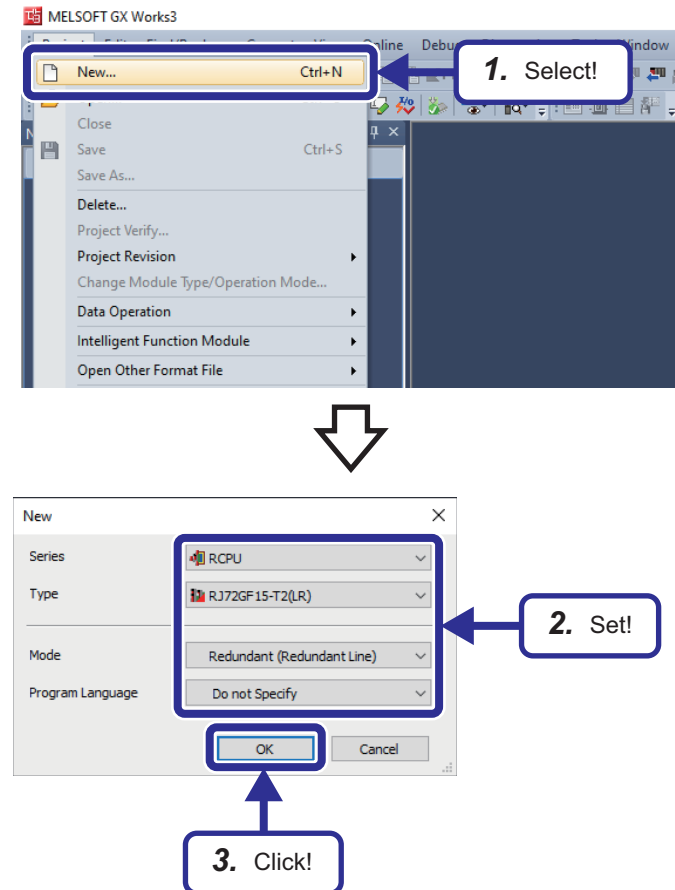

1. Select [Project] ⇒ [New].

2. The "New" window appears. Set the CPU module model ("Type"), operation mode ("Mode"), and programming language ("Program Language") as shown on the left.

3. Click the [OK] button.

4

Point

Three types of models are available for the remote head module (RJ72GF15-T2). The differences between them are as follows.

- (LR): For a redundant line configuration
- (SR): For a redundant slave station configuration
- None: For a redundant master station configuration or a single system configuration

For details on each configuration, refer to the following.

📖 MELSEC iQ-R CC-Link IE Field Network User's Manual (Application)

Setting the module configuration

Set the module configuration in GX Works3, and define the system configuration of the slave station. The following is the system configuration of the slave station.

Slave station	R64RP	R64RP	RJ72GF15-T2	RJ72GF15-T2	RX40NC6B	RY40PT5B	RY10R2	R60TD8-G	R60DA16-G	R60AD8-G
---------------	-------	-------	-------------	-------------	----------	----------	--------	----------	-----------	----------

Slave station Slave station
Network No.1 Network No.1
Station No.1 Station No.1

Operating procedure

1. In the Navigation window, double-click [Module Configuration].

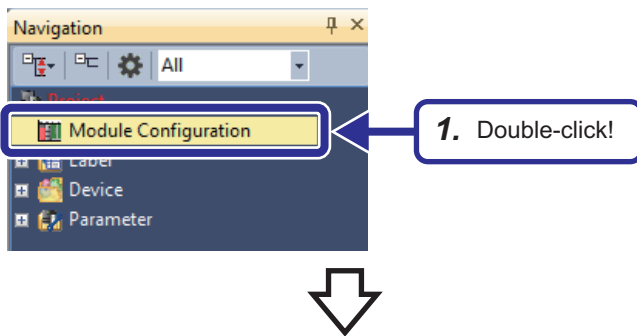

2. Select an extended temperature range redundant power supply main base unit "R38RB-HT" from "Main Base" in the "Element Selection" window, and drag and drop it to the "Module Configuration" window.

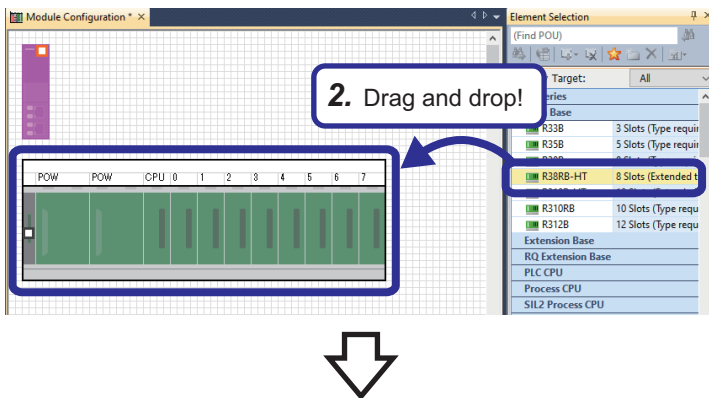

3. Select a power supply module "R64RP" from "Power Supply" in the "Element Selection" window, and drag and drop it to the power supply slots (two slots) of the R38RB-HT, which has been added to the "Module Configuration" window.

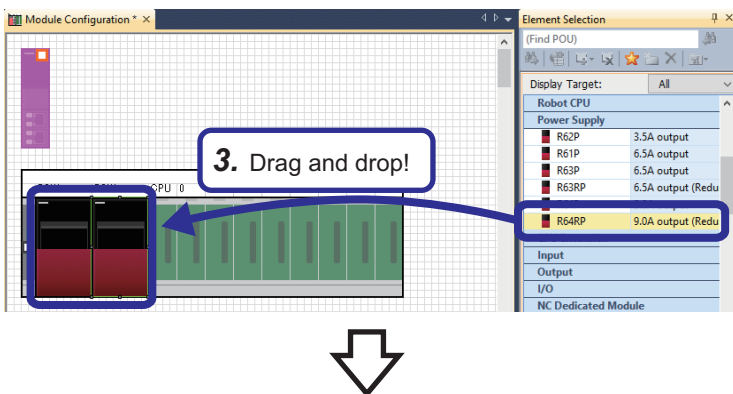

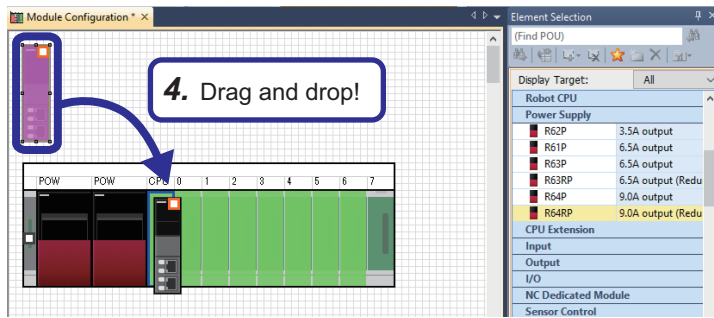

4. Drag and drop the RJ72GF15-T2(LR) displayed by default on the "Module Configuration" window to the CPU slot of the R38RB-HT. Do not use remote head modules in the "Element Selection" window because they are for a redundant configuration.

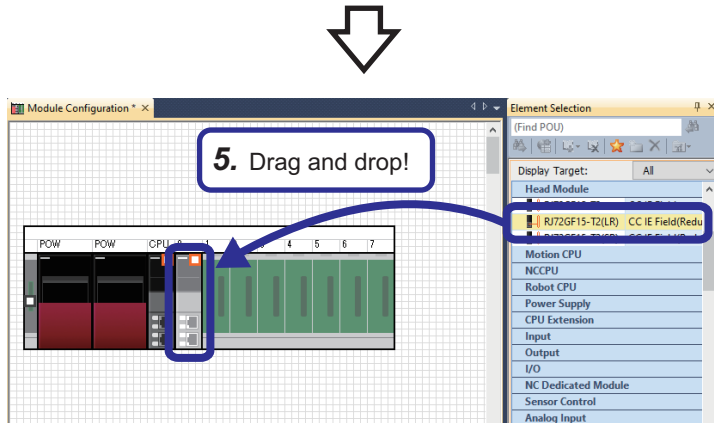

5. Select a remote head module "RJ72GF15-T2(LR)" from "Head Module" in the "Element Selection" window, and drag and drop it to slot No.0 of the R38RB-HT.

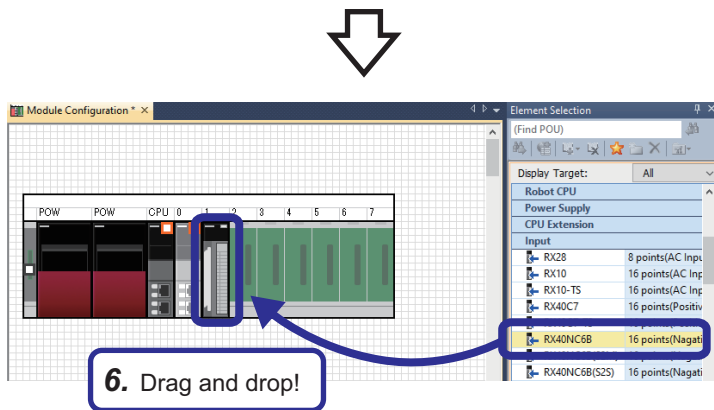

6. Select an input module with diagnostic functions "RX40NC6B" from "Input" in the "Element Selection" window, and drag and drop it to the slot No.1 of the R38RB-HT.

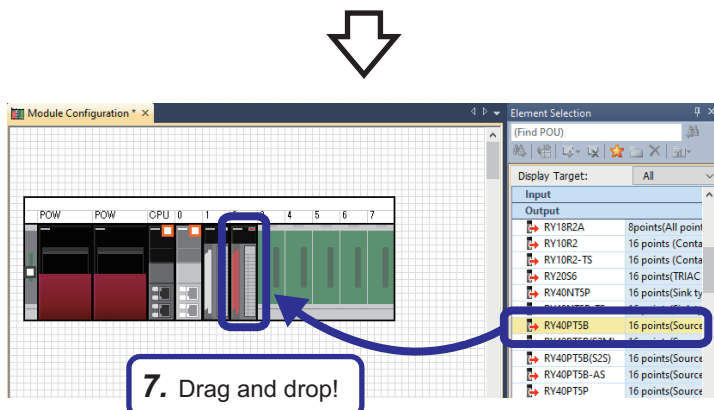

7. Select an output module with diagnostic functions "RY40PT5B" from "Output" in the "Element Selection" window, and drag and drop it to the slot No.2 of the R38RB-HT.

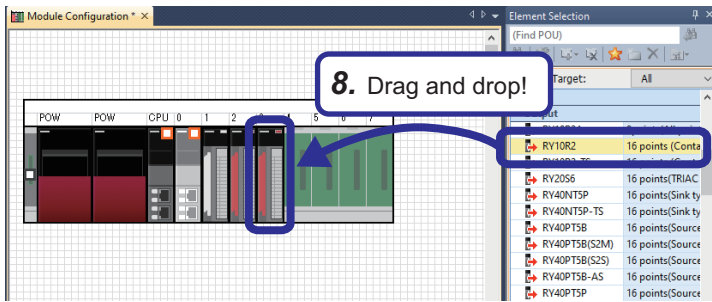

8. Select a contact output module "RY10R2" from "Output" in the "Element Selection" window, and drag and drop it to the slot No.3 of the R38RB-HT.

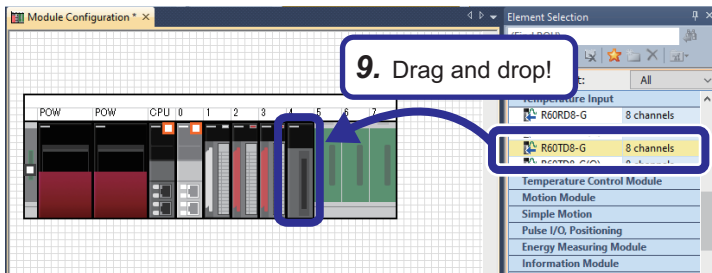

9. Select a channel isolated thermocouple input module "R60TD8-G" from "Temperature Input" in the "Element Selection" window, and drag and drop it to the slot No.4 of the R38RB-HT.

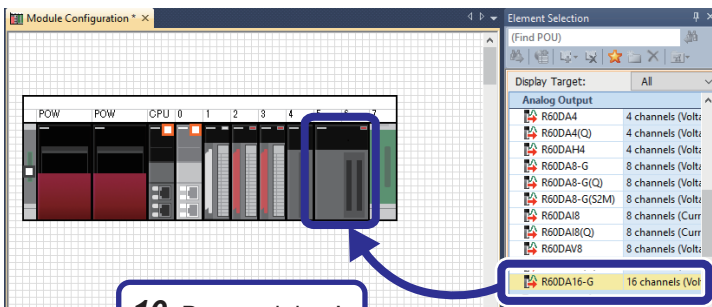

10. Select a channel isolated digital-analog converter module "R60DA16-G" from "Analog Output" in the "Element Selection" window, and drag and drop it to slot No.5 and No.6 of the R38RB-HT.

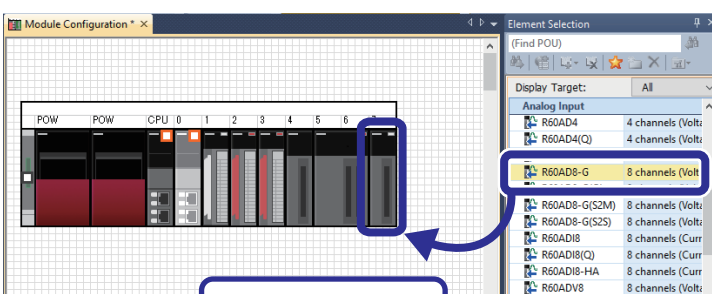

11. Select a channel isolated analog-digital converter module "R60AD8-G" from "Analog Input" in the "Element Selection" window, and drag and drop it to slot No.7 of the R38RB-HT.



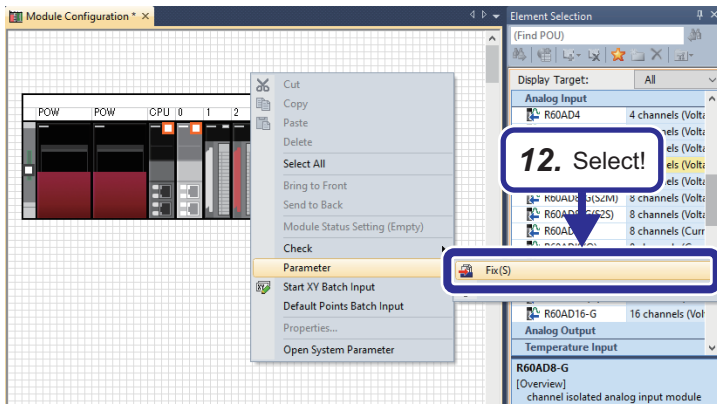

12. Right-click and select [Parameter] ⇒ [Fix] to fix the parameters.

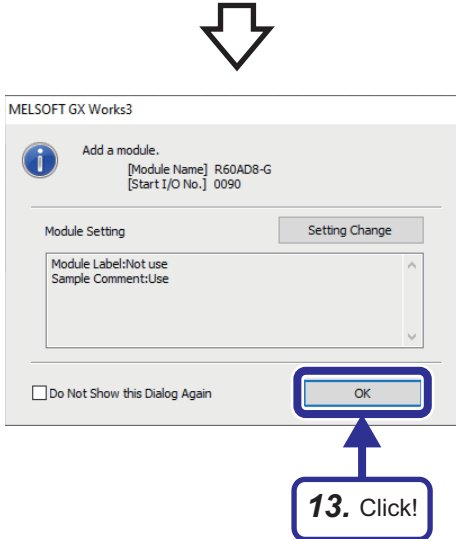

13. The window shown on the left appears for each module. Click the [OK] button.

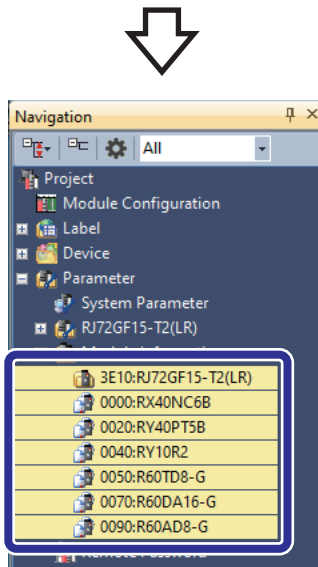

14. The module information is automatically registered on the Navigation window.

Setting network parameters

Set parameters required for configuring each network.

CC-Link IE Field Network parameter settings

Parameters of the RJ71GF11-T2 on the master station have already been set (Page 126 CC-Link IE Field Network parameter settings). Set parameters of the RJ72GF15-T2 on the slave station here.

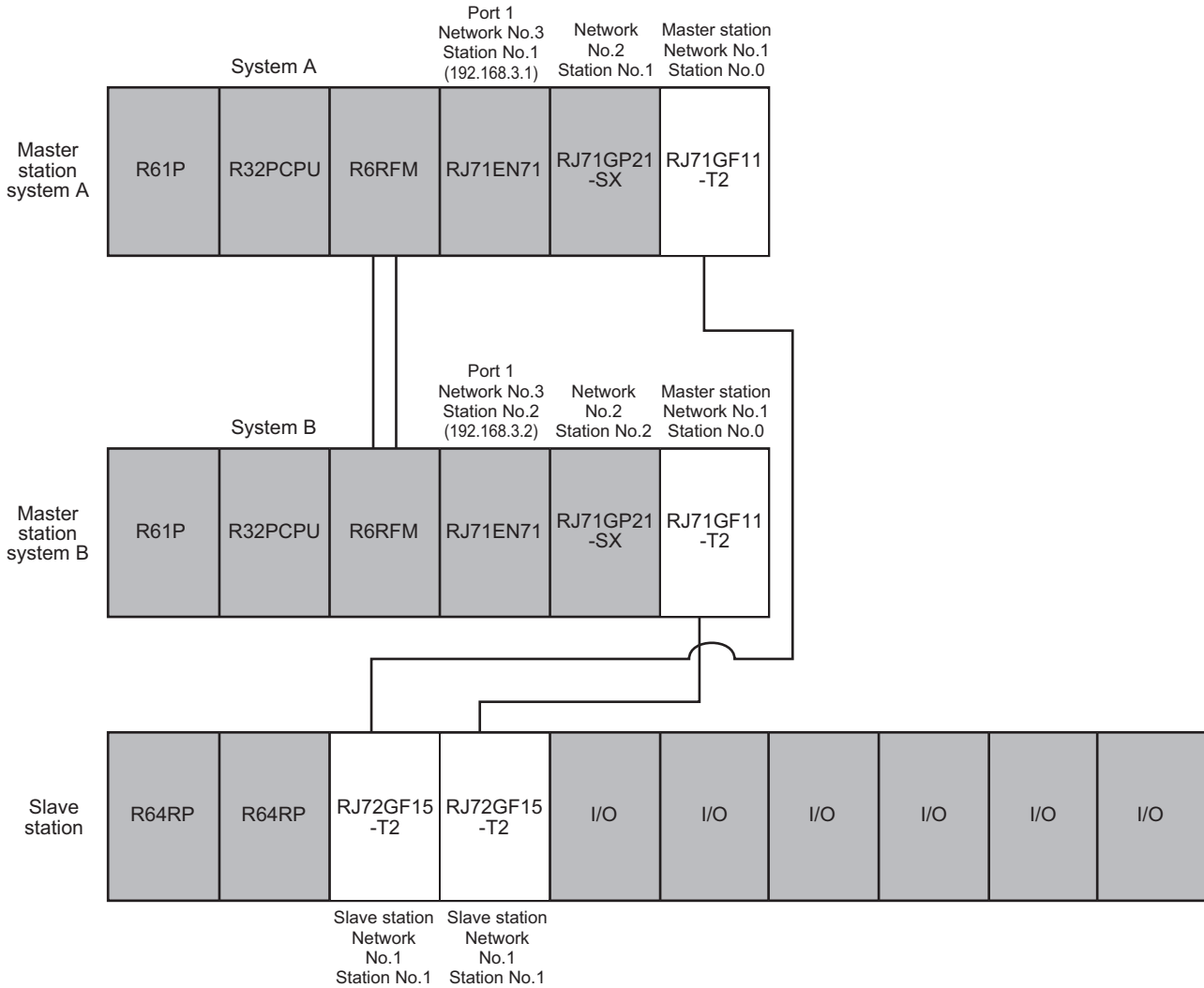

■ Setting the module parameters

Set the parameters of the CC-Link IE Field remote head module.

Operating procedure

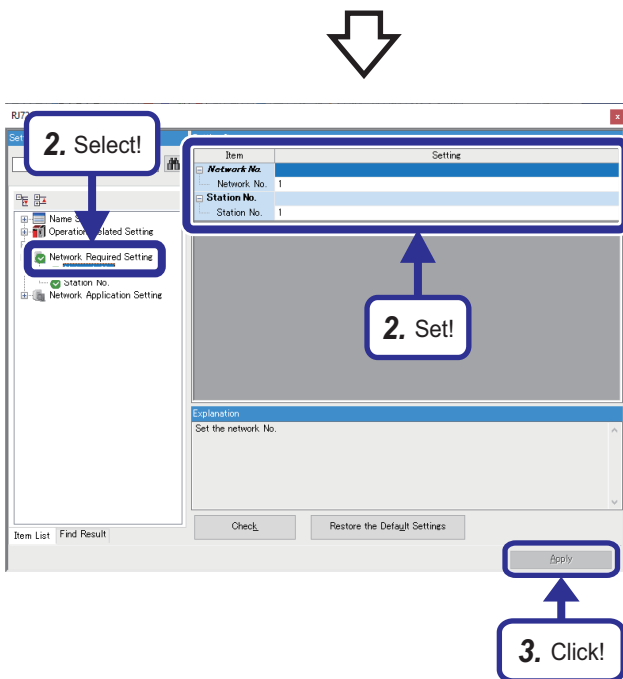
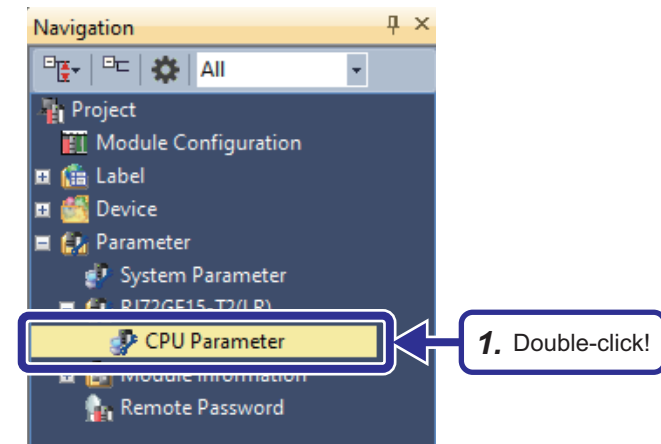

1. In the Navigation window, double-click "CPU Parameter" of the CC-Link IE Field remote head module.

2. Set "Network Required Setting" as follows:
[Settings]
Network No.: 1
Station No.: 1

3. Click the [Apply] button.

4.4 Converting the Projects

Convert the created projects "School_Master" and "School_Remote".

Operating procedure

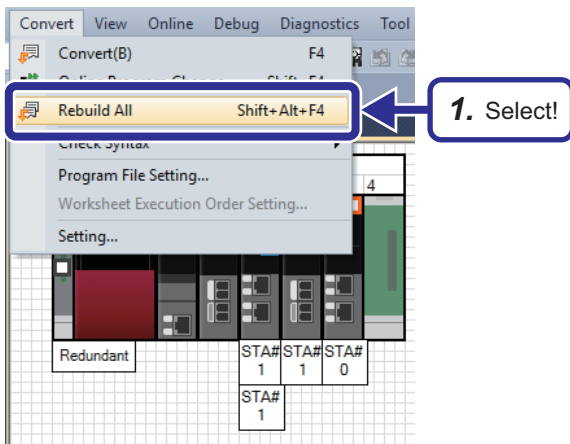

1. Select [Convert] ⇒ [Rebuild All] from the menu of the engineering tool.

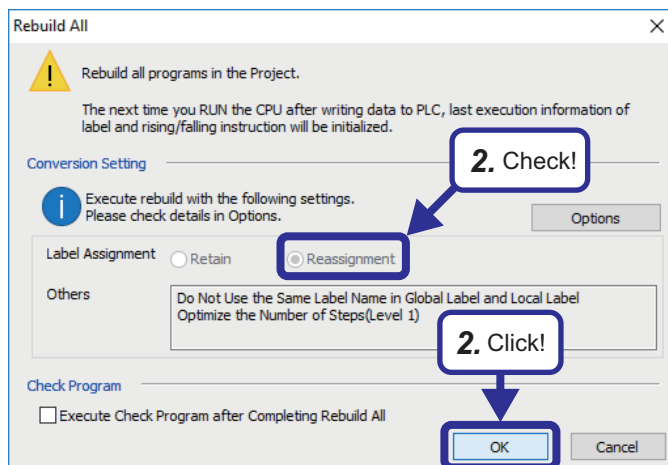

2. The "Rebuild All" window appears. Check that "Label Assignment" is set to "Reassignment", and click the [OK] button. If it is set to "Retain", click the [Options] button, and set "Reassign Labels in Executing Rebuild All" to "Yes".



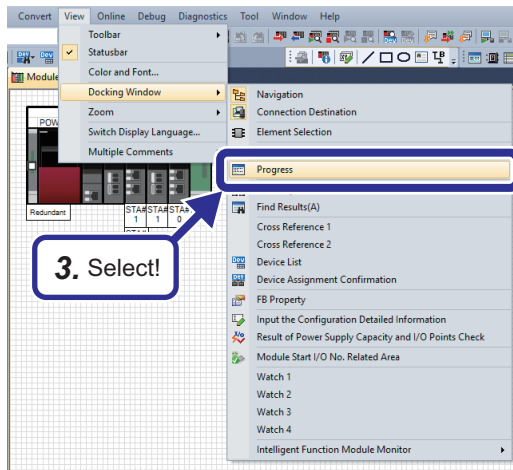

3. Select [View] ⇒ [Docking Window] ⇒ [Progress] from the menu of the engineering tool.

4. The "Progress" window appears. Check that the projects are converted and there is no error.

If an error has occurred, check and fix the error on the "Output" window. If an alarm has occurred, check the alarm and fix it only when there is any problem.

4.5 Writing the Projects

Write the project "School_Master" to the Process CPU (R32PCPU) and the project "School_Master" to the remote head module (RJ72GF15-T2).

Master station

■ Writing data to the programmable controller

Write the project "School_Master" from GX Works3 to the Process CPU of system A and system B.

Operating procedure

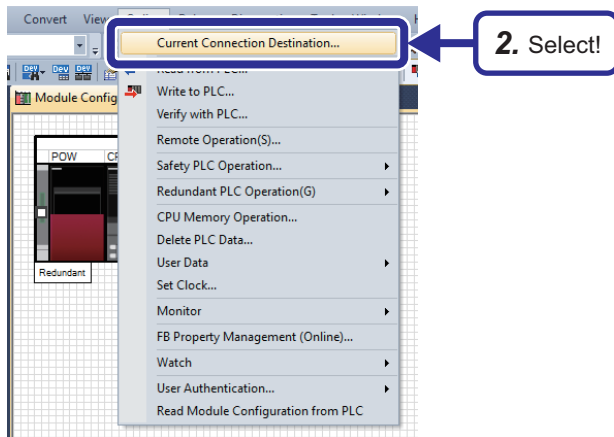

1. Connect a USB cable to the Process CPU of either system A or system B.
2. Open the project "School_Master", and select [Online] ⇒ [Current Connection Destination] to open the "Specify Connection Destination" window.

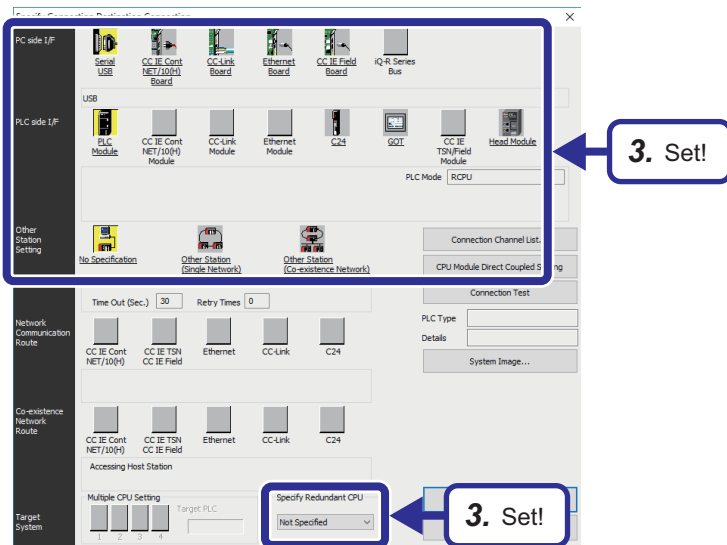

3. Set the following:
[Settings]
PC side I/F: Serial USB
PLC side I/F: PLC Module
Other Station Setting: No Specification
Specify Redundant CPU: Not Specified



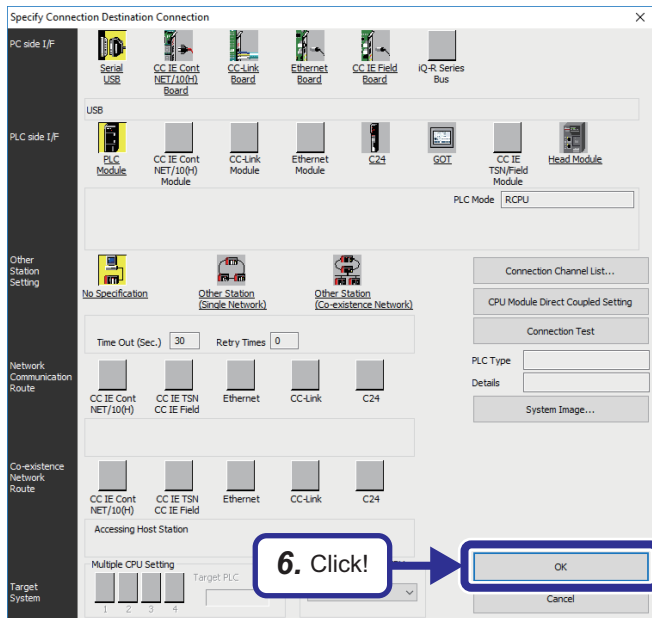
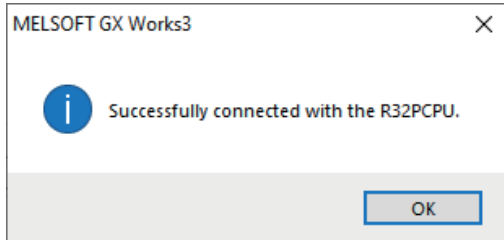
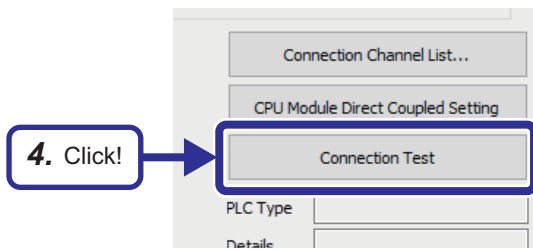

4. Click the [Connection Test] button.

5. Check that the connection with the CPU module has been successfully established.

6. Click the [OK] button.

4

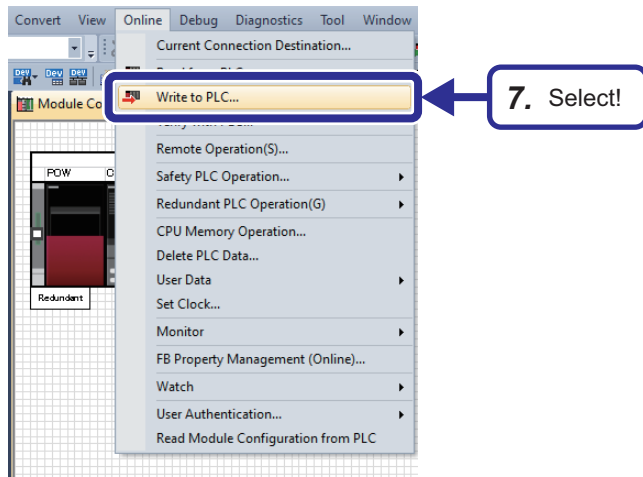

7. Select [Online] ⇒ [Write to PLC] from the menu of the engineering tool.

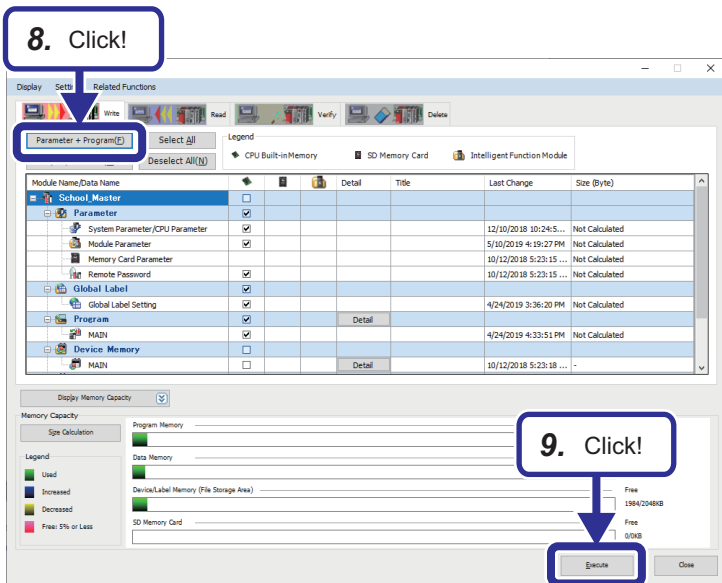

8. The "Online Data Operation" window appears. Click the [Parameter + Program] button.

9. Click the [Execute] button.

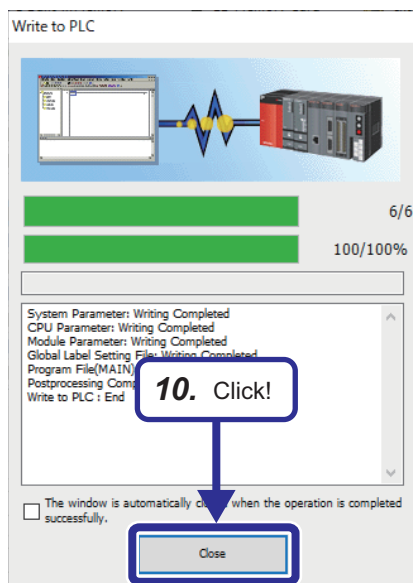

10. The "Write to PLC" window appears. When completed, a message, "Writing Completed", is displayed. Click the [Close] button.

■ Executing data link

1. Move the RUN/STOP/RESET switch of the CPU module to the RESET position once (for approximately one second) to reset the CPU module. Then, return it to the STOP position.

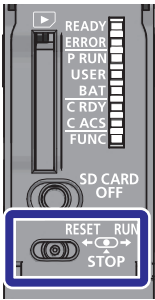

Slave station

■ Writing data to the programmable controller

Write the project "School_Remote" from GX Works3 to the remote head module.

Operating procedure

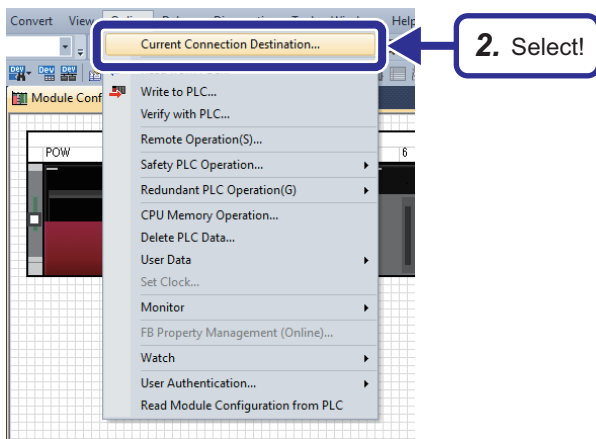

1. Connect a USB cable to the remote head module (on the CPU slot).
2. Open the project "School_Remote", and select [Online] ⇒ [Current Connection Destination] to open the "Specify Connection Destination" window.

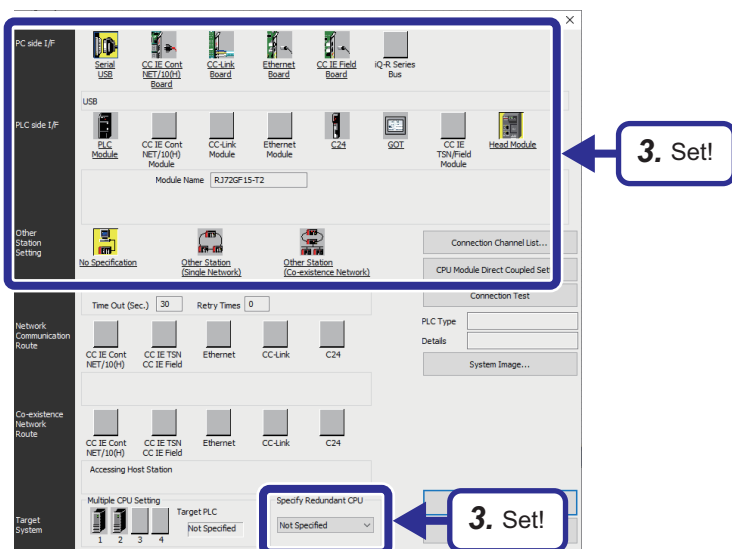

3. Set the following:
 [Settings]
 PC side I/F: Serial USB
 PLC side I/F: Head Module
 Other Station Setting: No Specification
 Specify Redundant CPU: Not Specified



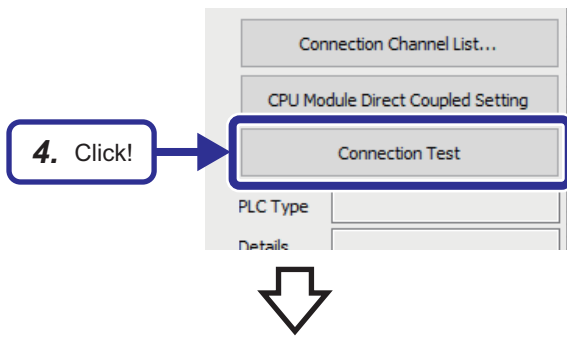

4. Click the [Connection Test] button.

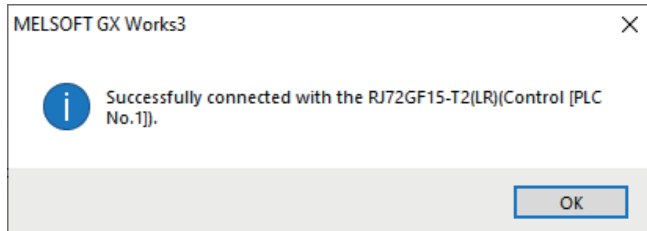

5. Check that the connection with the remote head module has been successfully established.

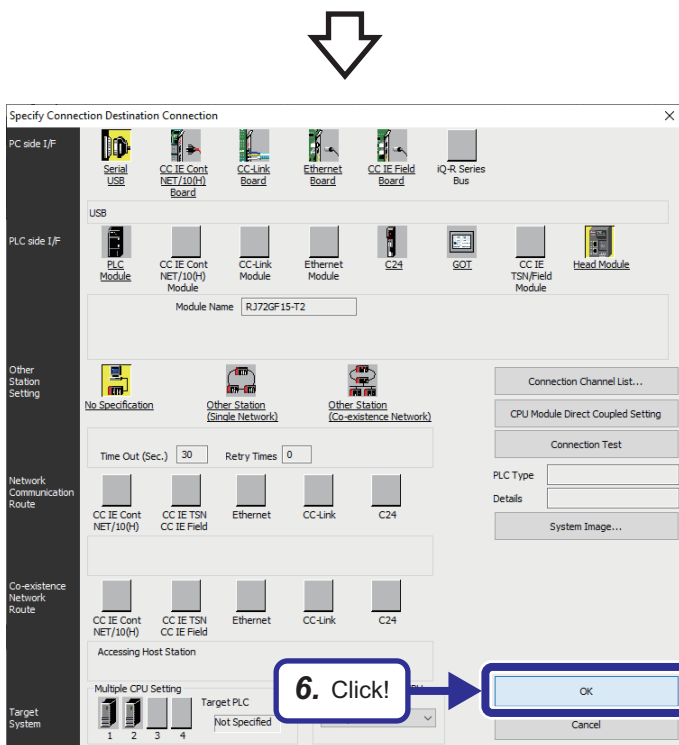

6. Click the [OK] button.

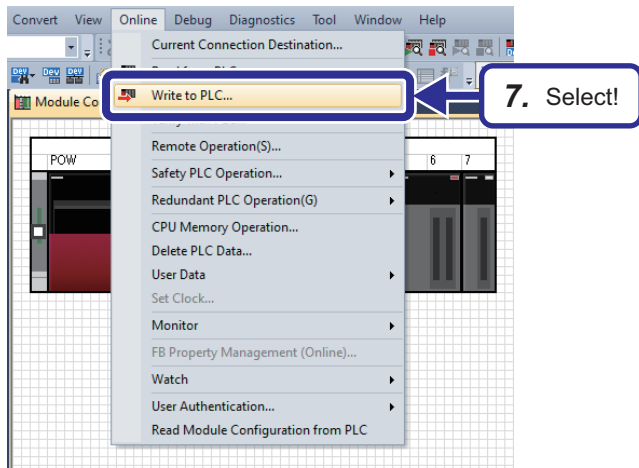

7. Select [Online] ⇒ [Write to PLC] from the menu of the engineering tool.

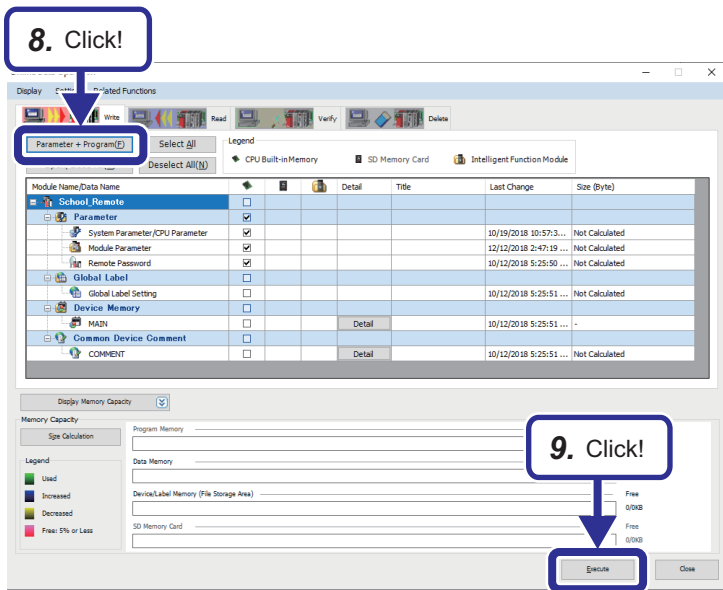

8. The "Online Data Operation" window appears. Click the [Parameter + Program] button.

9. Click the [Execute] button.



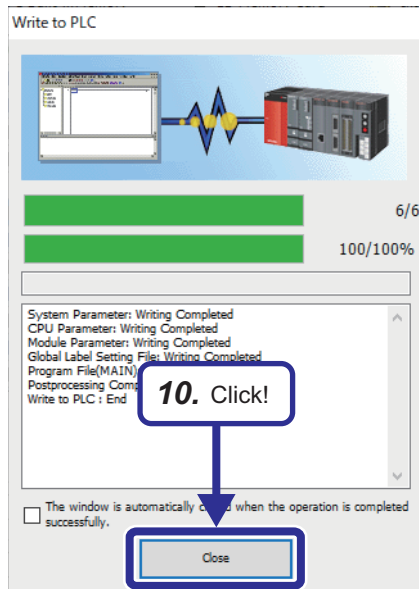

- 10.** The "Write to PLC" window appears.
When completed, a message, "Writing Completed", is displayed. Click the [Close] button.

■ Executing data link

- 1.** Move the RUN/STOP/RESET switch of the remote head module (on the CPU slot) to the RESET position once (for approximately one second) to reset the module. Then, return it to the STOP position. When the remote head module on the CPU slot is reset, data is automatically copied to the remote head module on slot No.0.



4.6 TCP/IP Settings on the Personal Computer

Change the TCP/IP setting on the personal computer.

This manual describes this procedure using a personal computer running Microsoft® Windows® 10 Operating System.

Operating procedure

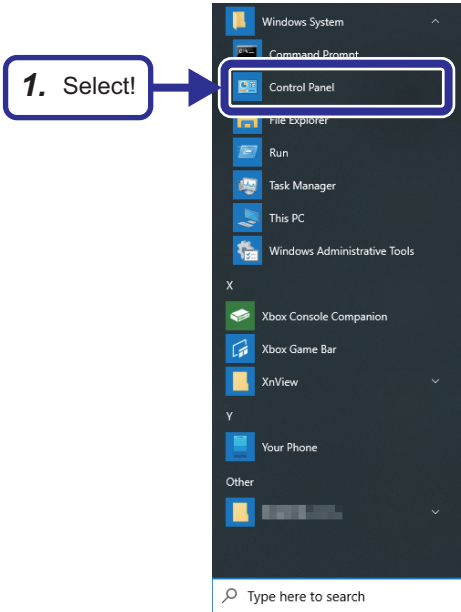

1. Open the Start menu of Windows®, and select [Control Panel].

4

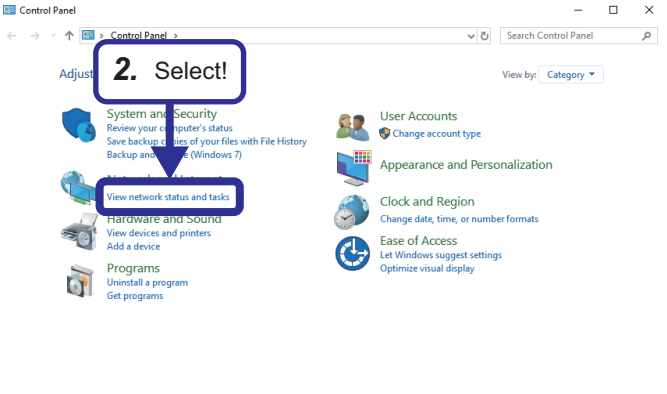

2. The "Control Panel" window appears. Select "View network status and tasks".



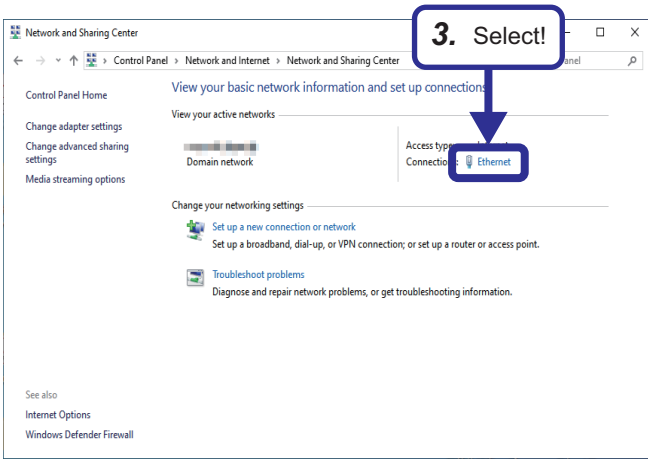

3. Select "Ethernet".

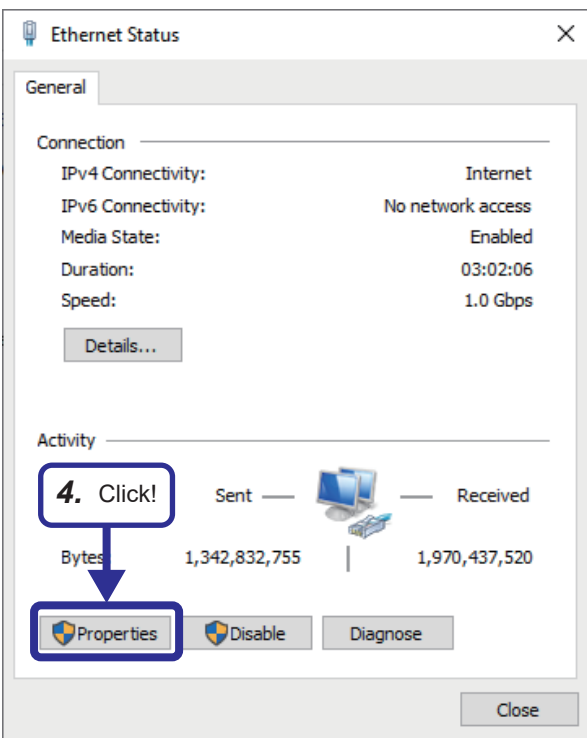

4. Click the [Properties] button.



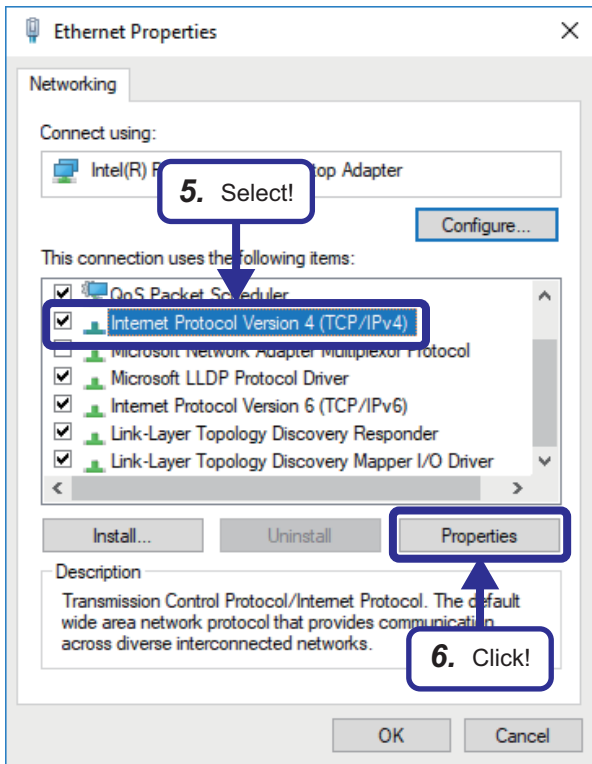

- 5. Select "Internet Protocol Version 4 (TCP/IPv4)".
- 6. Click the [Properties] button.

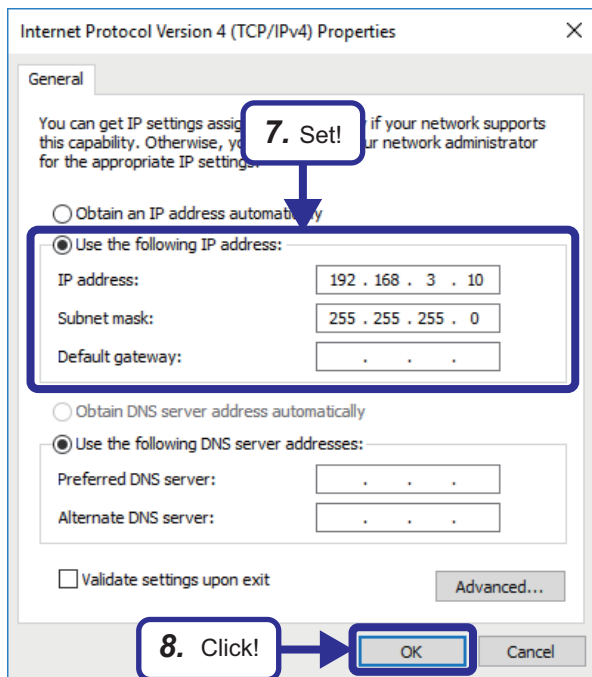

- 7. Select "Use the following IP address", and set the following:
[Settings]
IP address: 192.168.3.10
Subnet mask: 255.255.255.0
- 8. Click the [OK] button.



9. Click the [OK] button.

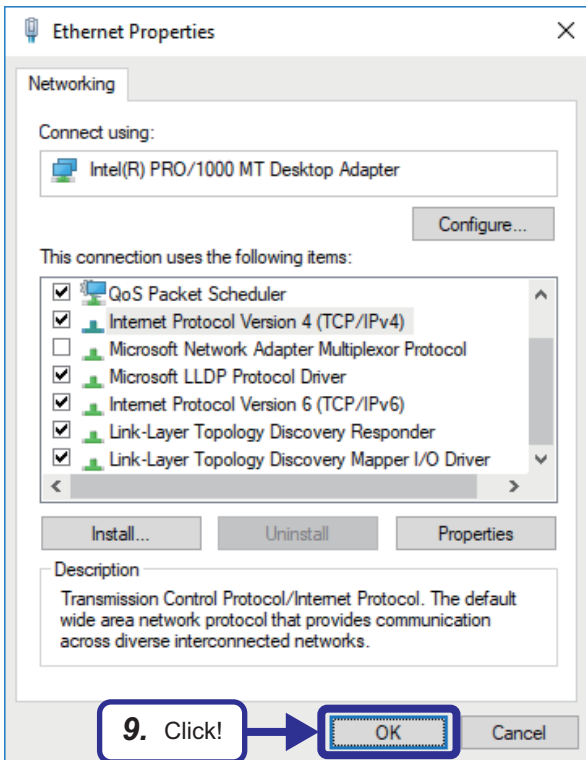

10. Click the [Close] button.

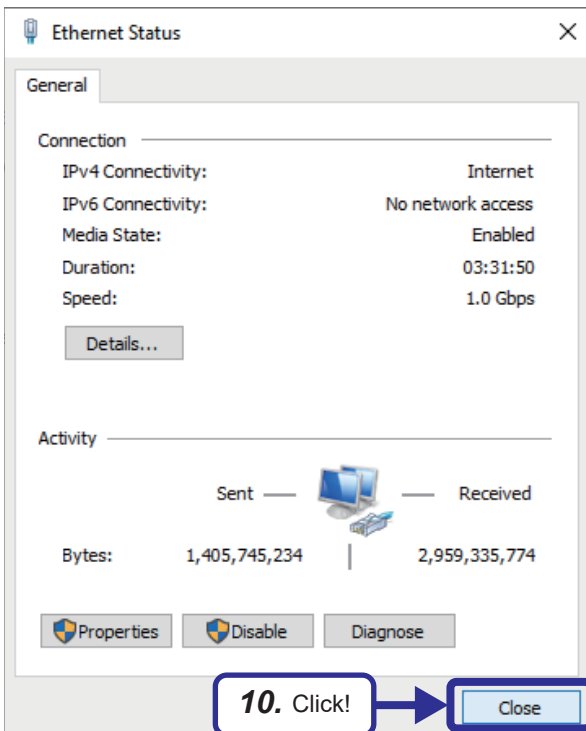

4.7 Checking Windows® Firewall

If Windows® firewall is enabled and communications by GX Works3 and the monitor tool are not permitted, communications may fail and a timeout error may occur. This section describes the firewall settings to permit communications. If other security software with a firewall function is used, permit communications of the monitor tool referring to the manual for the software used.

Operating procedure

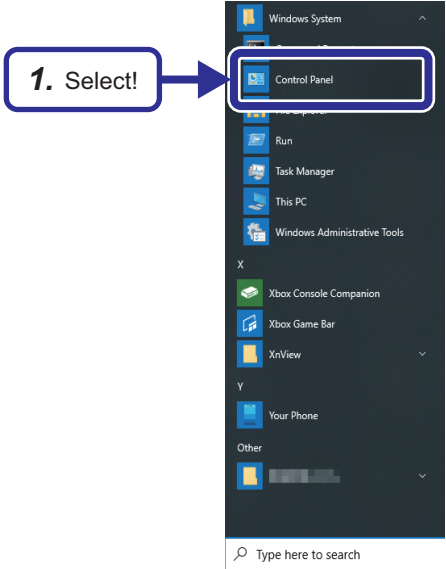

1. Open the Start menu of Windows®, and select [Control Panel].

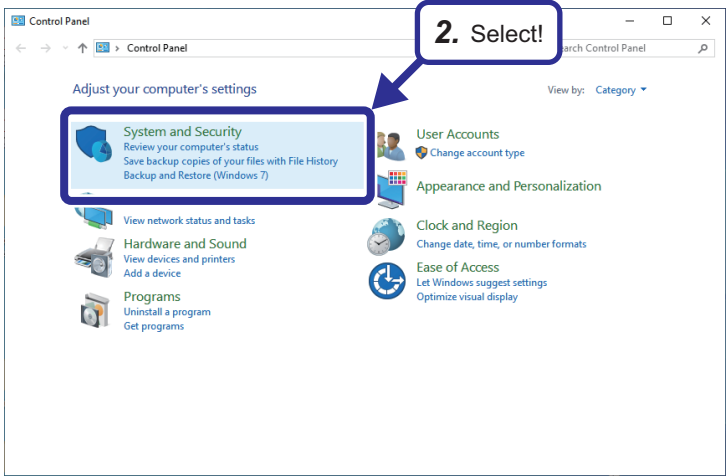

2. The "Control Panel" window appears. Select "System and Security".



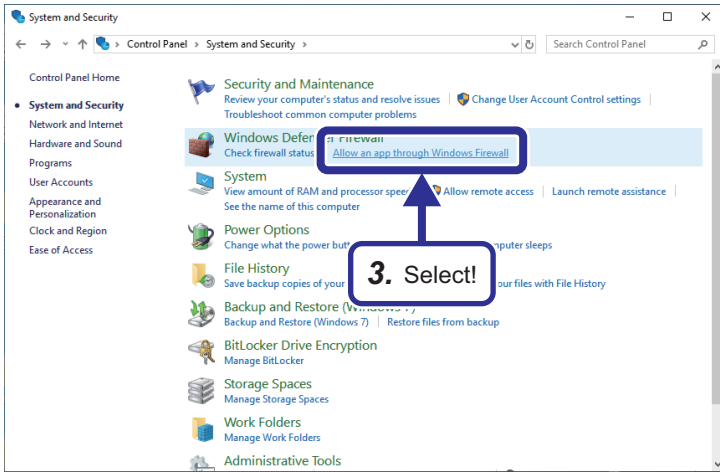

3. Select "Allow an app through Windows Firewall".

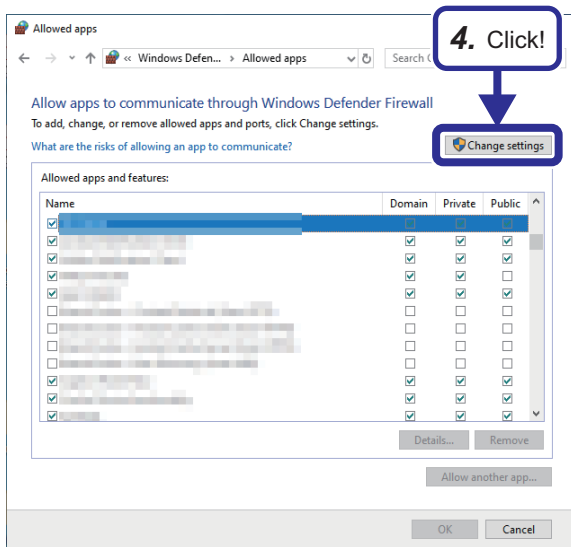

4. Click the [Change settings] button.



5. Click the [Allow another app] button.

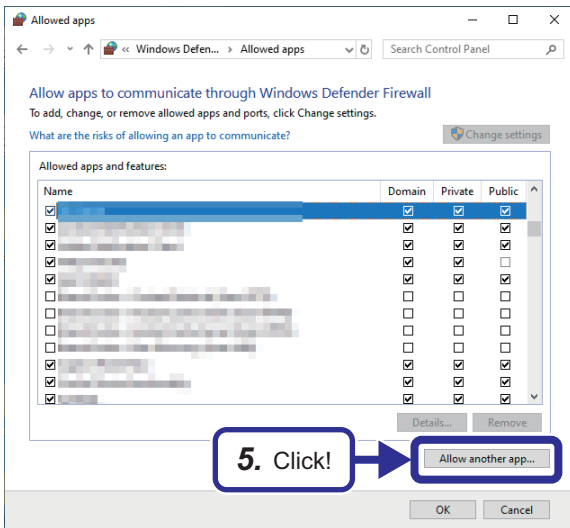

6. Select "GX Works3".

7. Click the [Add] button.

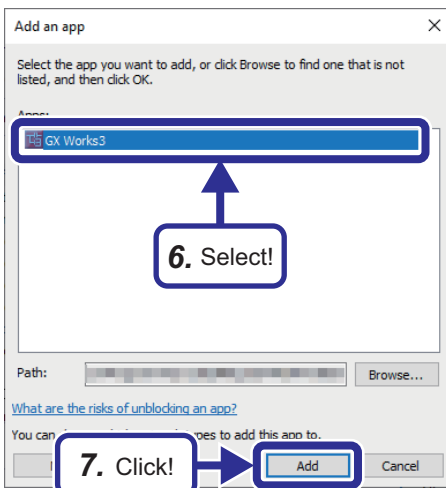

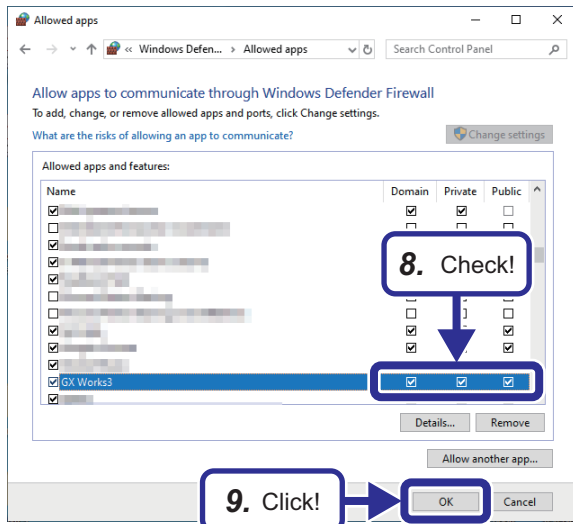

8. Check the "Private" and "Public" checkboxes for GX Works3 added on the list. Also check the "Domain" checkbox if it is present on the "Allowed apps and features" list.

9. Click the [OK] button.

10. Add the monitor tool to the "Allowed apps and features" list in the same way.

4.8 Checking the Operation

Check the operation of the configured redundant system and networks.

Redundant system

Master station

To check the operation, check the LED status of each module on the master station.

Process CPU

Operating procedure

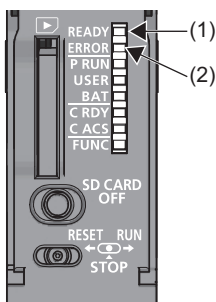

1. Check that the READY LED (1) is on.
2. Check that the ERROR LED (2) is off.

Ethernet module

Operating procedure

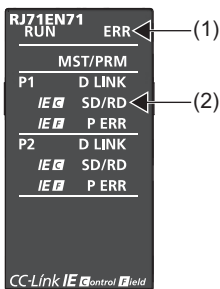

1. Check that the ERR LED (1) is off.
2. Check that the SD/RD LED (2) is flashing.

CC-Link IE Controller Network module

Operating procedure

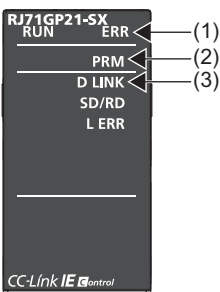

1. Check that the ERR LED (1) is off.
2. Check that the PRM LED (2) of the control station is on.
3. Check that the D LINK LED (3) of both the control station and the normal station is on.

■CC-Link IE Field Network module

Operating procedure

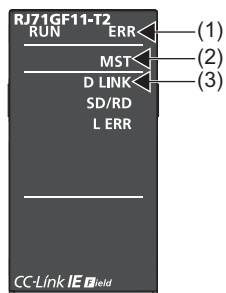

1. Check that the ERR LED (1) is off.
2. Check that the MST LED (2) is on.
3. Check that the D LINK LED (3) is on.

Slave station

To check the operation, check the LED status of the remote head modules on the slave station.

Operating procedure

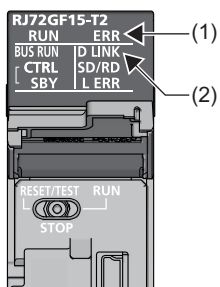

1. Check that the ERR LED (1) is off.
2. Check that the D LINK LED (2) is on.

Ethernet network

To check the operation, connect GX Works3 to the Process CPU, and perform a PING test.

Operating procedure

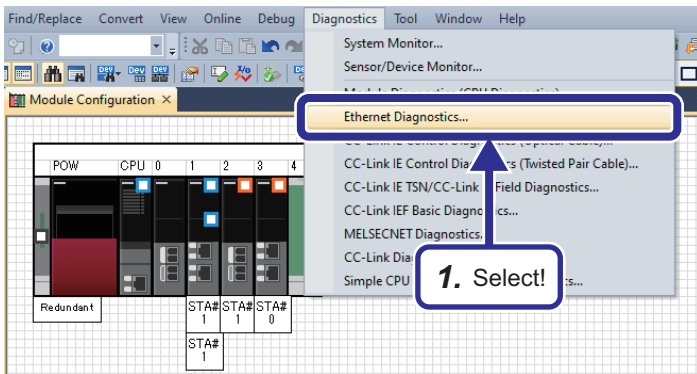

1. Select [Diagnostics] ⇒ [Ethernet Diagnostics].

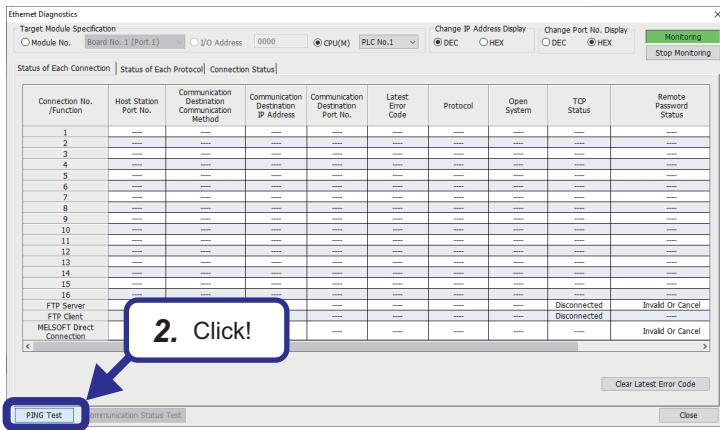

2. Click the [PING Test] button.



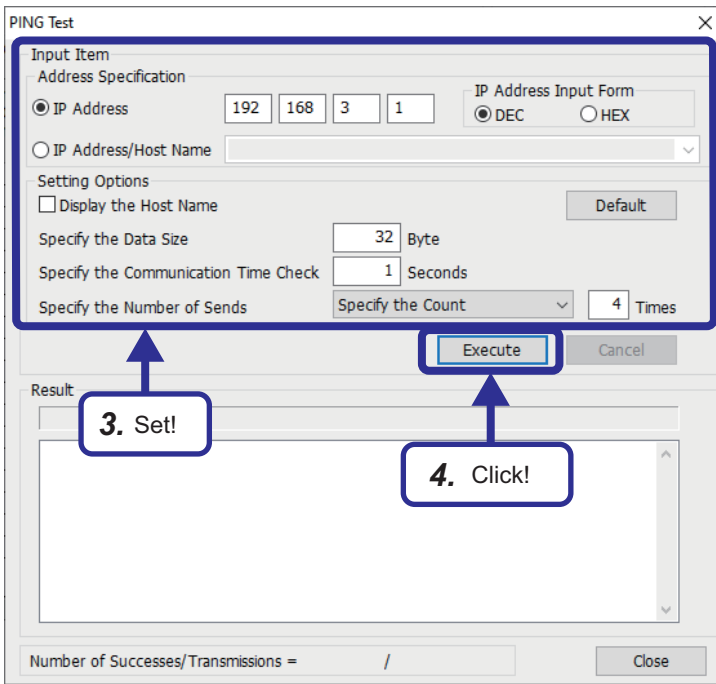

3. The "PING Test" window appears. Set the following:
 [Settings]
 IP Address: 192.168.3.1 (port 1 of system A),
 192.168.3.2 (port 1 of system B)
 Specify the Data Size: 32
 Specify the Communication Time Check: 1
 Specify the Number of Sends: Specify the Count, 4

4. Click the [Execute] button.

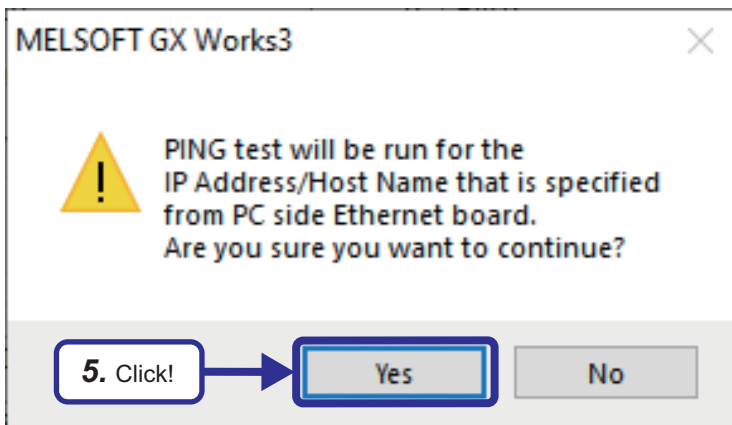

5. Click the [Yes] button to execute the PING test.

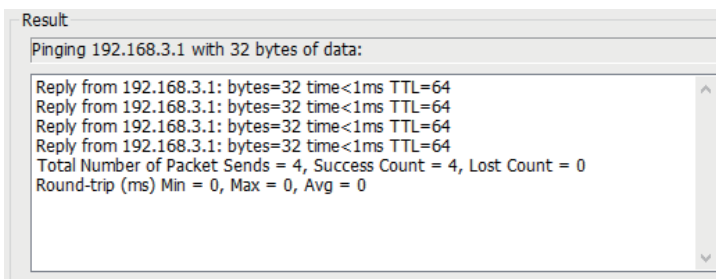

6. The PING test result is displayed. Check that "Success Count" is 4.



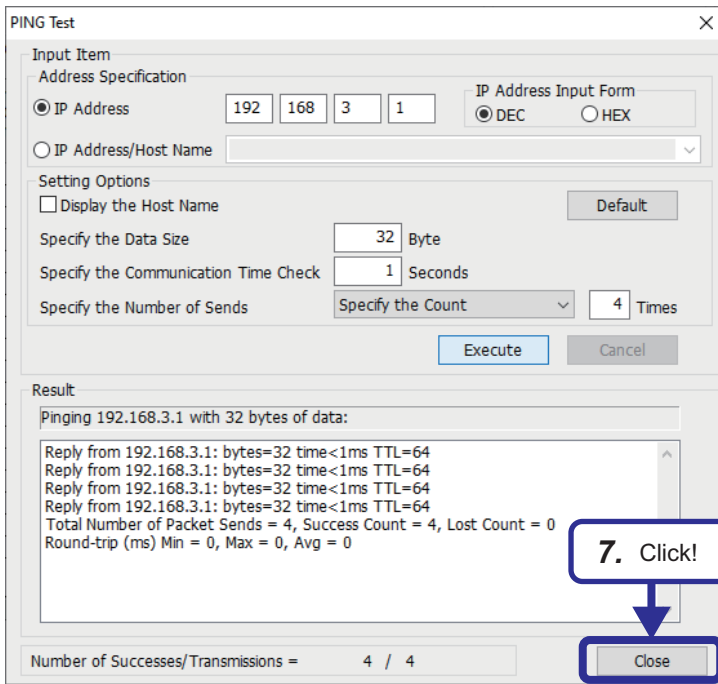

7. Click the [Close] button to end the PING test.

CC-Link IE Controller Network

To check the operation, connect GX Works3 to the Process CPU, and perform the CC-Link IE control diagnostics.

Operating procedure

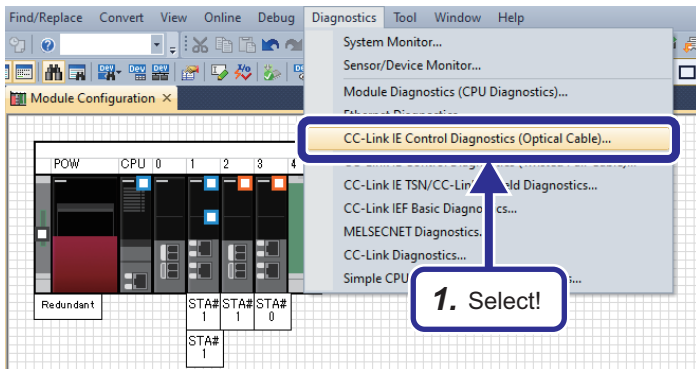

1. Select [Diagnostics] ⇒ [CC-Link IE Control Diagnostics (Optical Cable)] from the menu.



[Normal operation]

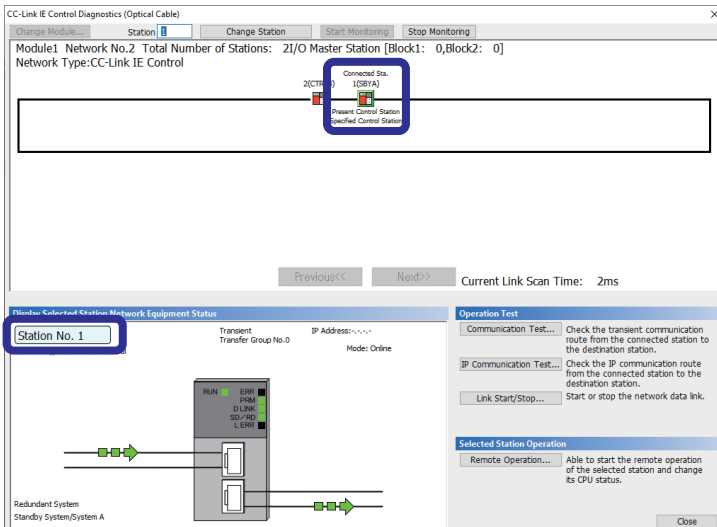

2. Check the diagnostic window.

[Normal operation]

Network map: A module that is operating normally is displayed as an icon .

Station number: A module that is operating normally is displayed in light blue.

[Error]

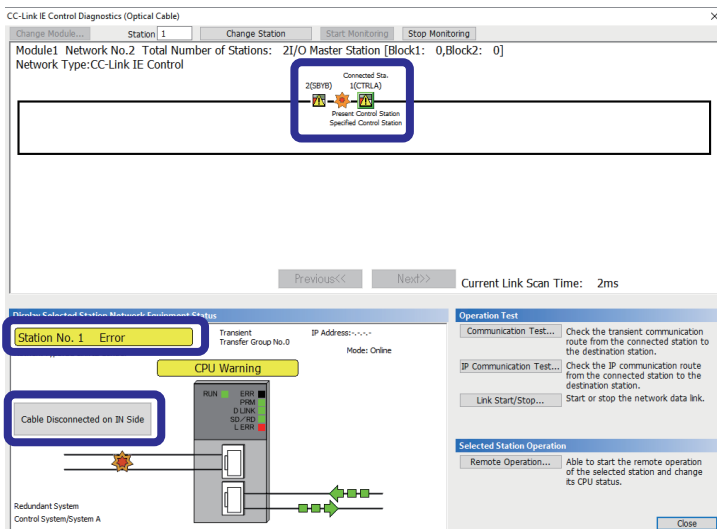

[Error]

Network map: An error module is displayed as an icon  or .  indicates a disconnection.

Station number: An error module is displayed in yellow or red together with a message "Error".

Error description: An error name is displayed. Clicking the name displays the error details and troubleshooting.

CC-Link IE Field Network

To check the operation, connect GX Works3 to the Process CPU, and perform the CC-Link IE Field diagnostics.

Operating procedure

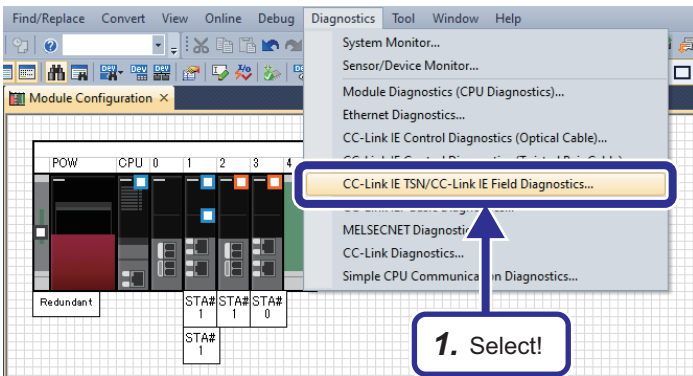

[Normal operation]

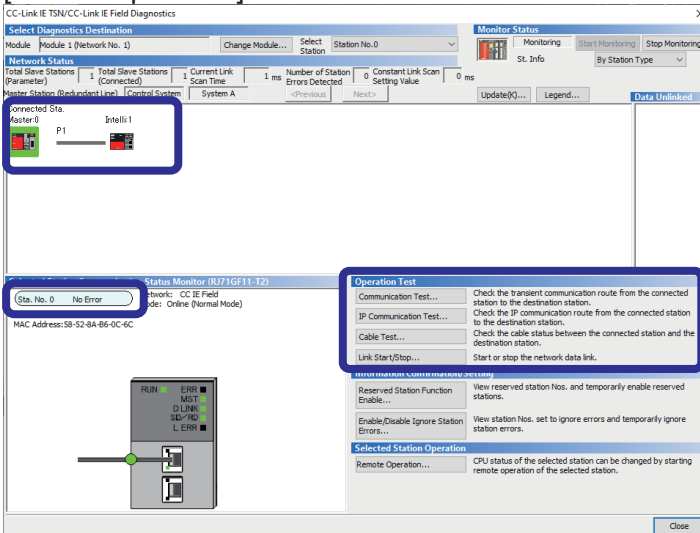

[Error]

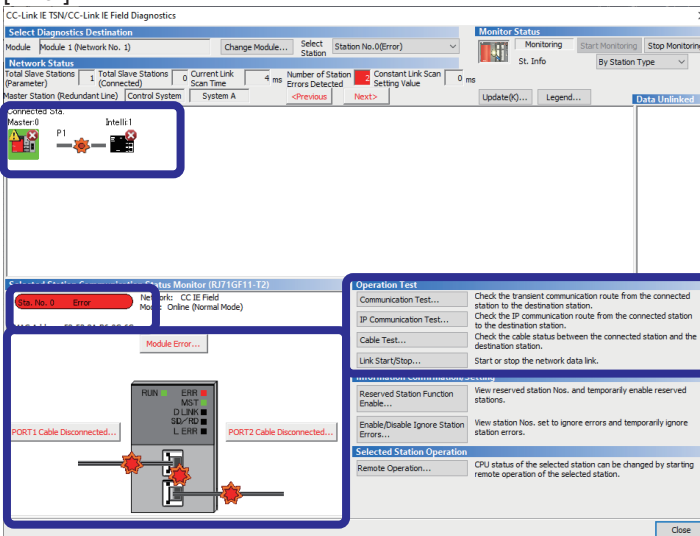

1. Select [Diagnostics] ⇒ [CC-Link IE TSN/CC-Link IE Field Diagnostics] from the menu.

2. Check the diagnostic window.

[Normal operation]

Network map: A module that is operating normally is displayed as an icon or .

Station number: A module that is operating normally is displayed in light blue.

Operation test: Various operation tests are performed by clicking these buttons.

Operation test: Various operation tests are performed by clicking these buttons.

[Error]

Network map: An error module is displayed as an icon or . A starburst icon indicates a disconnection.

Station number: An error module is displayed in yellow or red together with a message "Error".

Error description: An error name is displayed.

Clicking the name displays the error details and troubleshooting.

Operation test: Various operation tests are performed by clicking these buttons.

5 SIGNAL INPUT/OUTPUT IN THE REDUNDANT SYSTEM

On the slave station of the demonstration machine, the I/O modules with diagnostic functions (RX40NC6B and RY40PT5B), contact output module (RY10R2), thermocouple input module (R60TD8-G), channel isolated digital-analog converter module (R60DA16-G), and channel isolated analog-digital converter module (R60AD8-G) are mounted.

This chapter describes the parameter settings and programming for those modules to input/output signals.

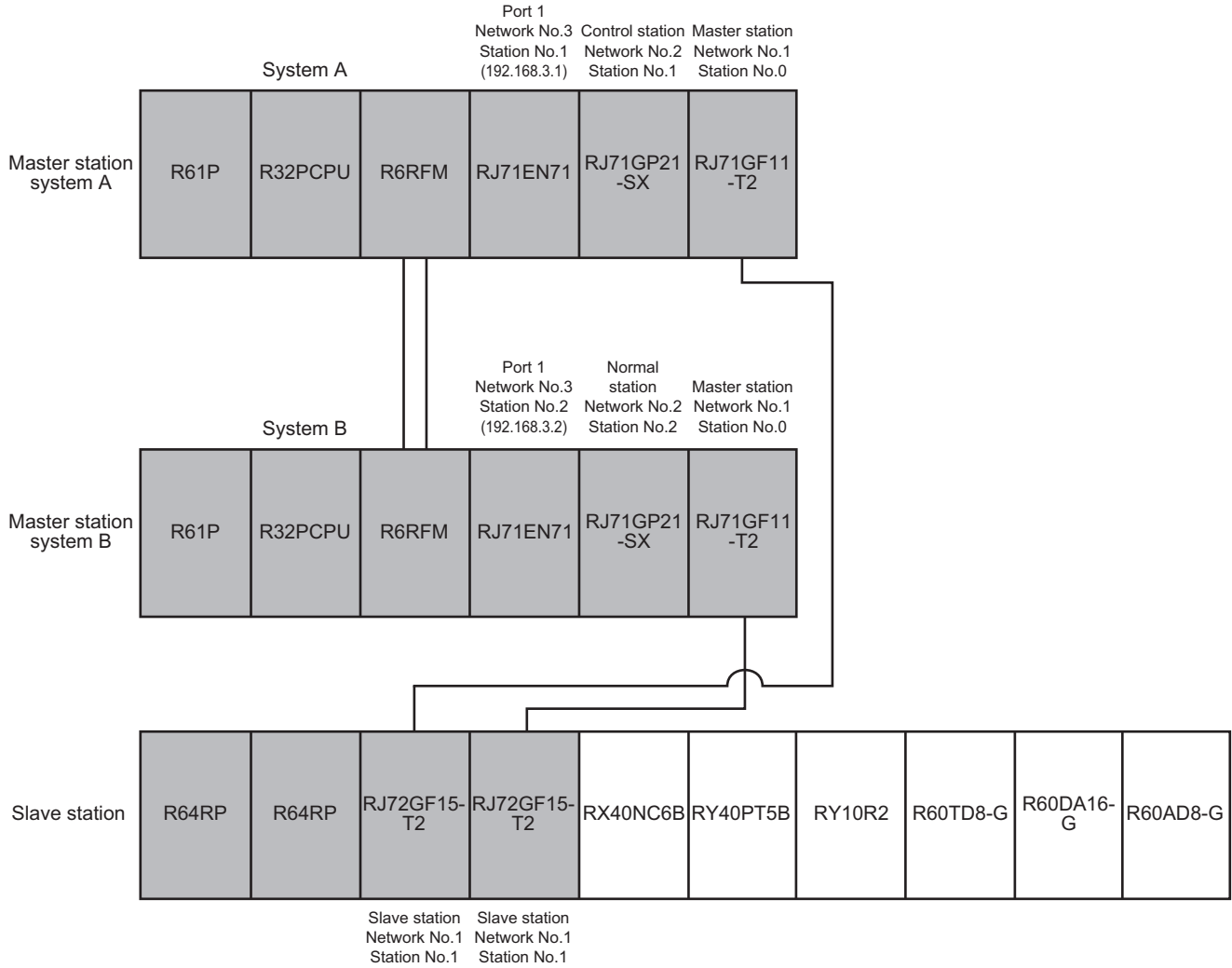

Wiring

All the modules must be wired. For details, refer to the manual for the module used and Page 32 Wiring.

5.1 Setting Parameters

Master station

Set tracking in CPU parameter of "School_Master".

Operating procedure

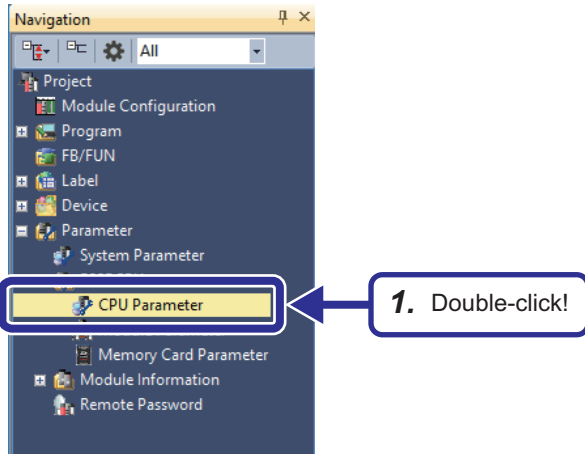

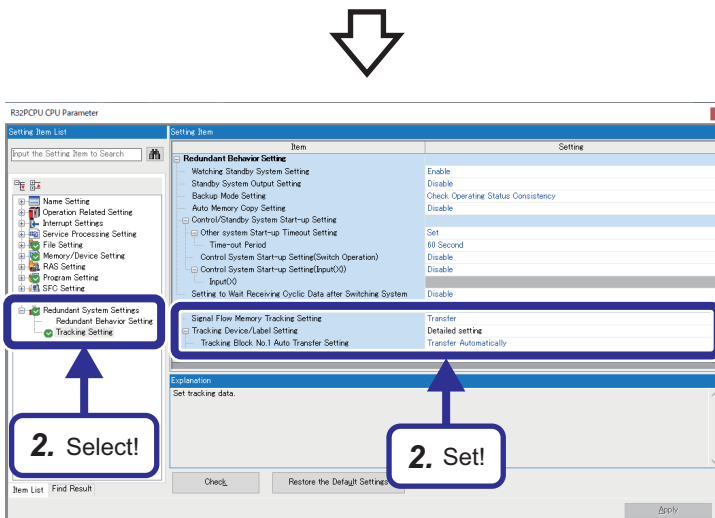

1. Open the project "School_Master", and double-click [CPU Parameter] in the Navigation window.



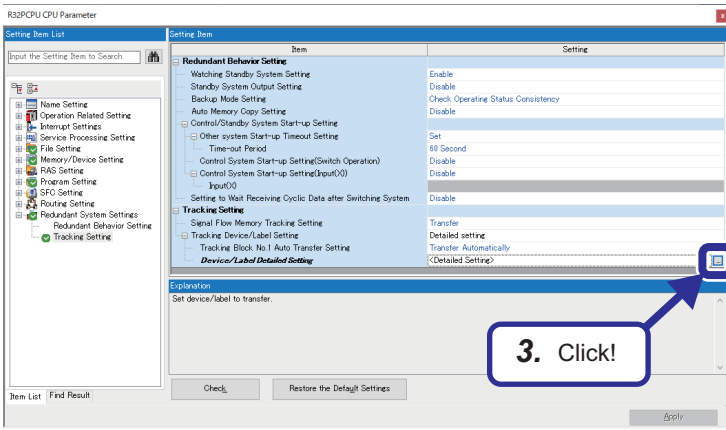

2. Select "Redundant System Settings" in the "Setting Item List" window, and set "Tracking Setting" as follows:
 [Settings]
 Signal Flow Memory Tracking Setting: Transfer
 Tracking Device/Label Setting: Detailed setting^{*1}
 Tracking Block No.1 Auto Transfer Setting: Transfer Automatically

*1 To use the process control extension, always set this item to "Detailed setting" because the file register (ZR) is not transferred when it is set to "Transfer collectively". (The file register is automatically registered to the block No.64 during conversion.)

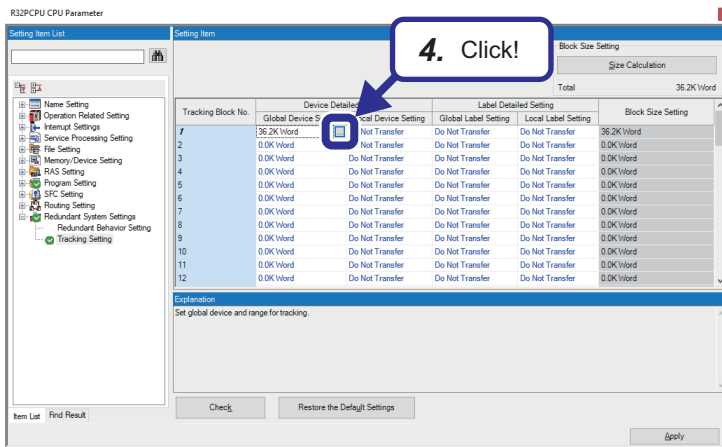

3. Select "Device/Label Detailed Setting", and click the  button.



4. Click the  button for "Global Device Setting" of the tracking block No.1.

5



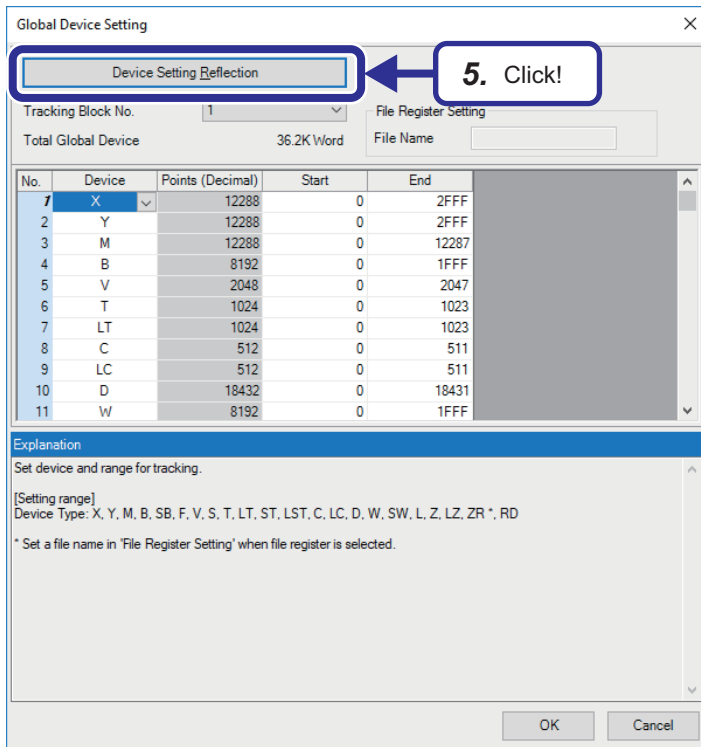

5. The "Global Device Setting" window appears. Click the [Device Setting Reflection] button.

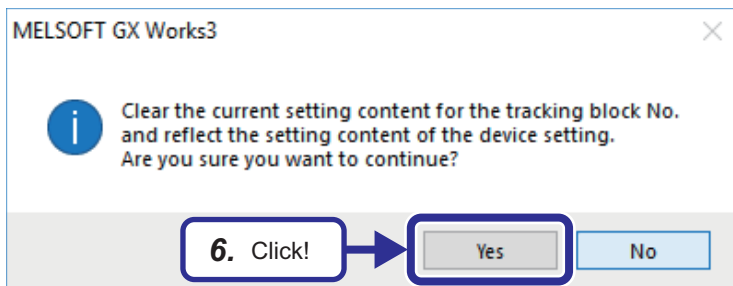

6. Click the [Yes] button to automatically reflect the device range being used.



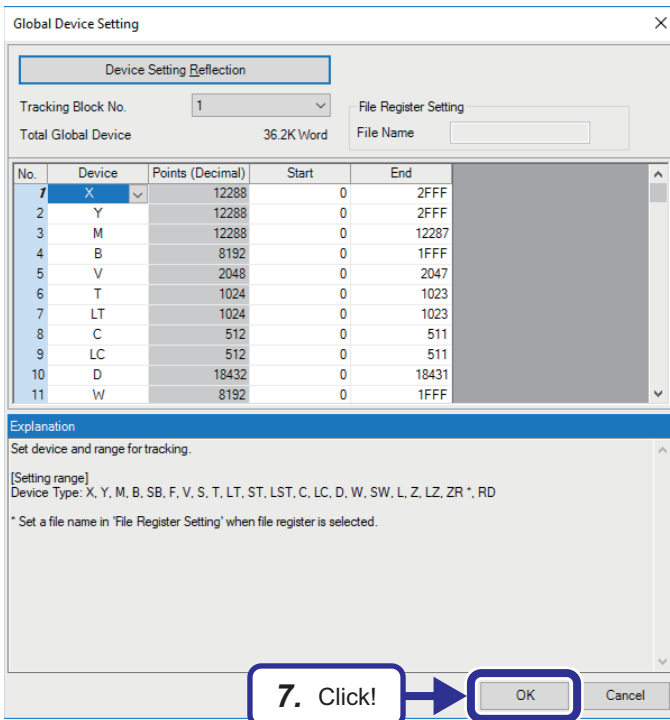

7. Click the [OK] button to close the "Global Device Setting" window.

5

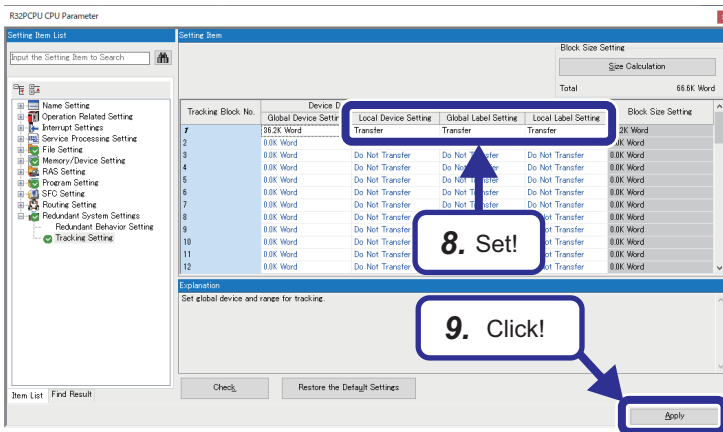

8. Set the tracking block No.1 as follows:
[Settings]
Local Device Setting: Transfer
Global Label Setting: Transfer
Local Label Setting: Transfer

9. Click the [Apply] button.

Point

Track all the device range being used, except for the special cases (for example when specific device values are different in a program executed in both systems).

Slave station

Set parameters to each input/output module using GX Works3.

In this exercise, the minimum parameters required for signal input/output are set based on the setting examples in the following table. Parameters must be set for modules that handle analog signals. Modules that handle 24VDC input/output and contact output operate with the default settings.

- Parameter setting examples

Module name	Model	Setting necessity	Setting example
Relay output module	RY10R2	Not required	—
Input module with diagnostic functions	RX40NC6B		
Output module with diagnostic functions	RY40PT5B		
Channel isolated thermocouple input module	R60TD8-G	Required	CH1: Type K thermocouple input
Channel isolated digital-analog converter module	R60DA16-G		CH1: 4 to 20mA output CH2: 1 to 5V output
Channel isolated analog-digital converter module	R60AD8-G		CH1: 4 to 20mA input CH2: 1 to 5V input

■Parameter settings of the thermocouple input module (R60TD8-G)

Set parameters required for signal input of the thermocouple input module (R60TD8-G). In this exercise, a type K thermocouple signal is input to CH1.

Operating procedure

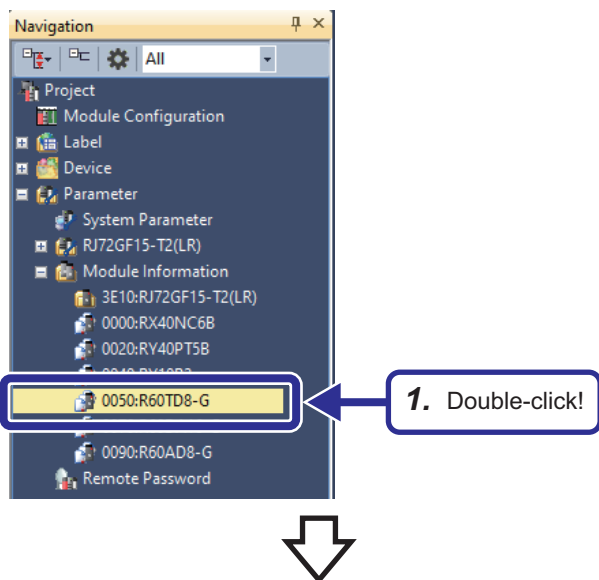

1. Open the project "School_Remote", and double-click "0050:R60TD8-G" in the Navigation window.

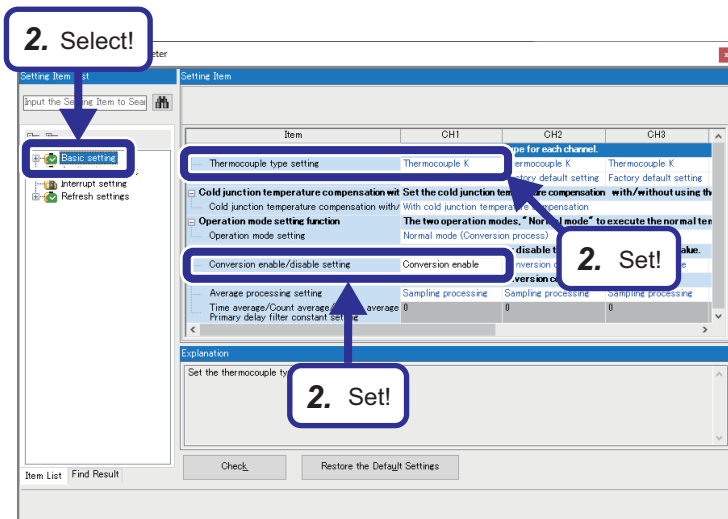

- Set "Basic setting" as follows:
[Settings]
Thermocouple type setting: Thermocouple K
Conversion enable/disable setting: Conversion enable

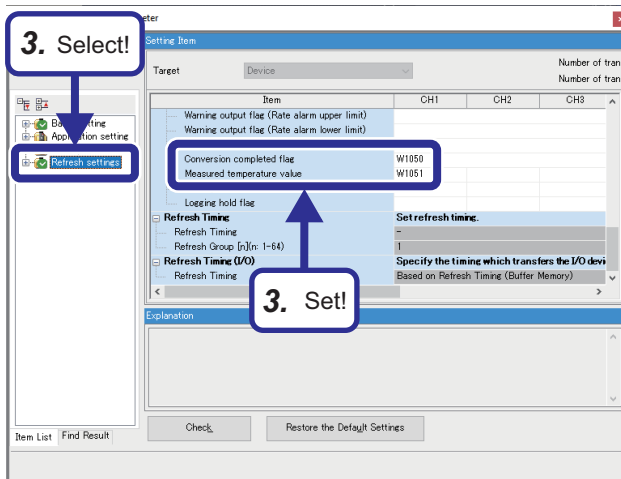

- Set "Refresh settings" as follows:
[Settings]
Conversion completed flag: W1050
Measured temperature value: W1051

Point

For channels where "Conversion enable/disable setting" is set to "Conversion disable", input signals are not converted to digital values. Set this setting to "Conversion enable" for channels where input signals are to be handled.

According to the refresh setting parameters set in the CC-Link IE Field Network module, data is refreshed to the device of the CPU module as follows:

- Conversion completed flag (Remote head module W1050 → Process CPU W1550)
- Measured temperature value (Remote head module W1051 → Process CPU W1551)

Parameter settings of the digital-analog converter module (R60DA16-G)

Set parameters required for signal output of the digital-analog converter module (R60DA16-G). In this exercise, 4 to 20mA is output from CH1 and 1 to 5V is output from CH2. These outputs are input to CH1 and CH2 of the analog-digital converter module (R60AD8-G).

Operating procedure

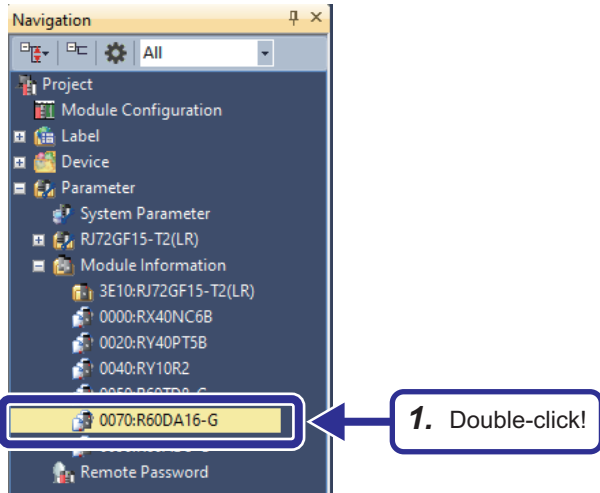

1. Open the project "School_Remote", and double-click "0070:R60DA16-G" in the Navigation window.

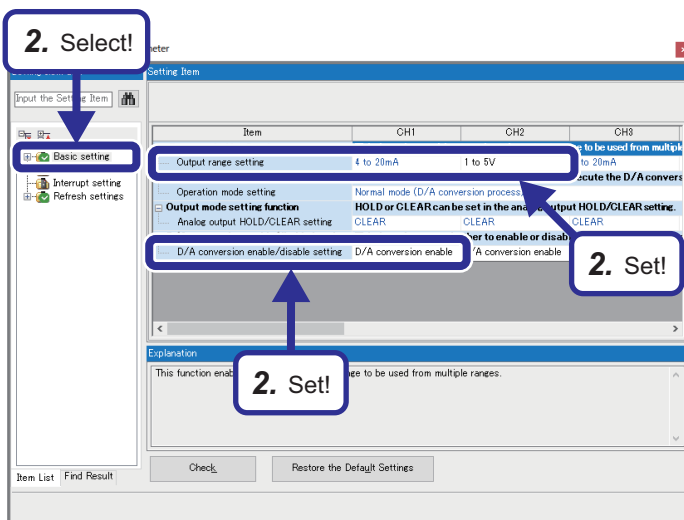

2. Set "Basic setting" as follows:
 [Settings]
 [CH1]
 Output range setting: 4 to 20mA
 D/A conversion enable/disable setting: D/A conversion enable
 [CH2]
 Output range setting: 1 to 5V
 D/A conversion enable/disable setting: D/A conversion enable

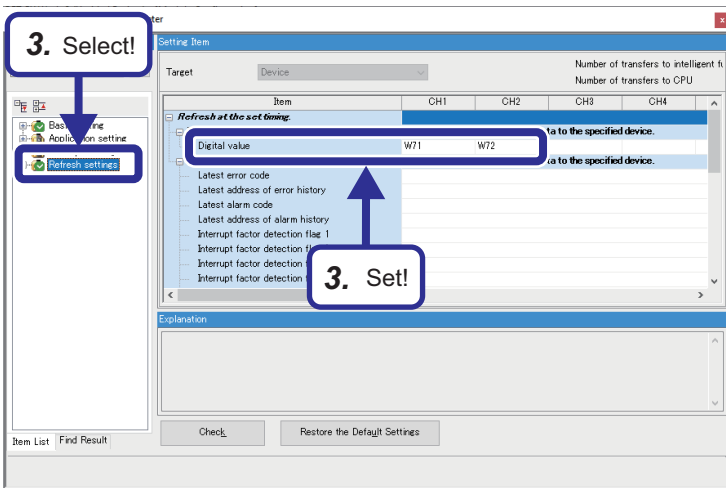

- Set "Refresh settings" as follows:
 [Settings]
 [CH1]
 Digital value: W71
 [CH2]
 Digital value: W72

Point

For channels where "D/A conversion enable/disable setting" is set to "D/A conversion disable", digital values are not converted to output signals. Set this setting to "D/A conversion enable" for channels from which signals are to be output.

According to the refresh setting parameters set in the CC-Link IE Field Network module, data is refreshed to the device of the CPU module as follows:

- CH1 Digital value (Remote head module W71 → Process CPU W1071)
- CH2 Digital value (Remote head module W72 → Process CPU W1072)

Parameter settings of the analog-digital converter module (R60AD8-G)

Set parameters required for signal input of the analog-digital converter module (R60AD8-G). In this exercise, 4 to 20mA is input to CH1 and 1 to 5V is input to CH2.

Operating procedure

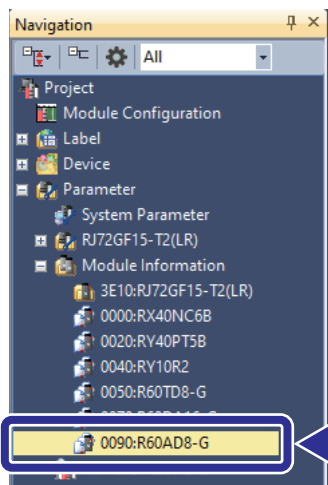

- Open the project "School_Remote", and double-click "0090:R60AD8-G" in the Navigation window.

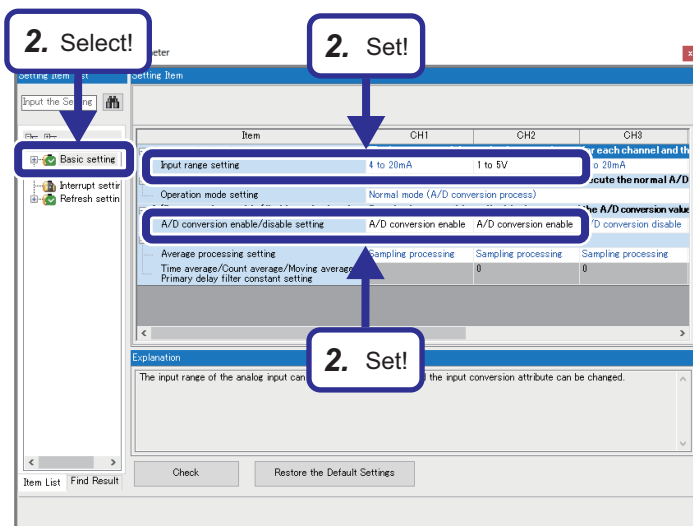

2. Set "Basic setting" as follows:
 [Settings]
 [CH1]
 Input range setting: 4 to 20mA
 A/D conversion enable/disable setting: A/D conversion enable
 [CH2]
 Input range setting: 1 to 5V
 A/D conversion enable/disable setting: A/D conversion enable

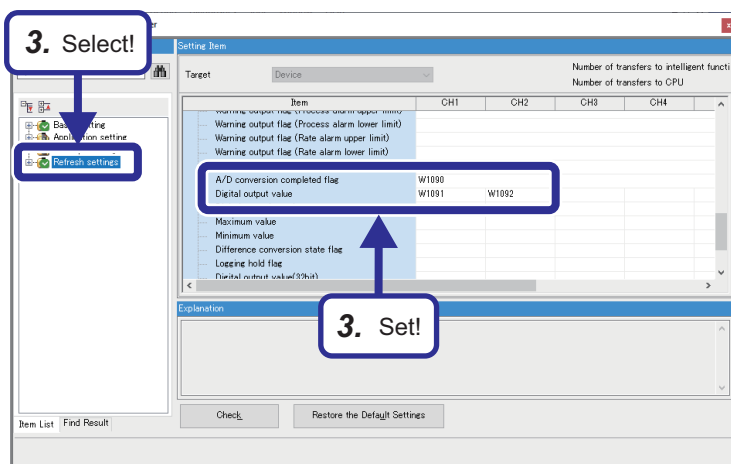

3. Set "Refresh settings" as follows:
 [Settings]
 A/D conversion completed flag: W1090
 Digital output value (CH1): W1091
 Digital output value (CH2): W1092

Point

For channels where "A/D conversion enable/disable setting" is set to "A/D conversion disable", input signals are not converted to digital values. Set this setting to "A/D conversion enable" for channels to which signals are to be input.

According to the refresh setting parameters set in the CC-Link IE Field Network module, data is refreshed to the device of the CPU module as follows:

- Conversion completed flag (Remote head module W1090 → Process CPU W1590)
- CH1 digital output value (Remote head module W1091 → Process CPU W1591)
- CH2 digital output value (Remote head module W1092 → Process CPU W1592)

Transfer setting between devices

Set the transfer setting between devices using GX Works3. These parameters are set to transfer the following devices of the remote head module to the master station as cyclic data.

- Link special relay (SB)
- Link special register (SW)
- Special relay (SM)
- Special register (SD)
- Link register (W)

Here, set parameters to transfer data in SM50 (Error clear), SD230 (Remote head No.1 operating status), and SD231 (Remote head No.2 operating status) of the remote head module to the master station as cyclic data. This setting enables the CPU module on the master station to clear errors of the remote head module and to monitor the operating status of the remote head module.

- Details of the transfer target devices of the remote head module

Device number	Data stored	Details
SM50	Error clear	<ul style="list-style-type: none"> • This relay clears the error state when the mode transfers from off to on. • This relay is turned on and off when the error clear has been completed.
SD230	Remote head No.1 operating status [CPU slot]	The operation information for each remote head number is stored. b0 to b3: Operating status <ul style="list-style-type: none"> • 0: RUN • 2: STOP • 4: INITIALIZE • FH: RESET b4, b5: Classification <ul style="list-style-type: none"> • 0: Normal • 1: Minor error • 2: Moderate error • 3: Major error b6: Empty
SD231	Remote head No.2 operating status [Slot 0]	CH1: Type K thermocouple input

Operating procedure

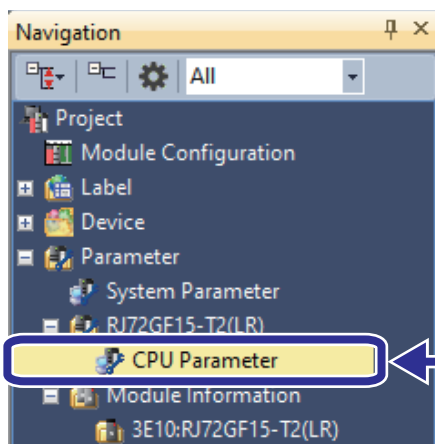

1. Double-click!

1. Open the project "School_Remote", and double-click [CPU Parameter] in the Navigation window.

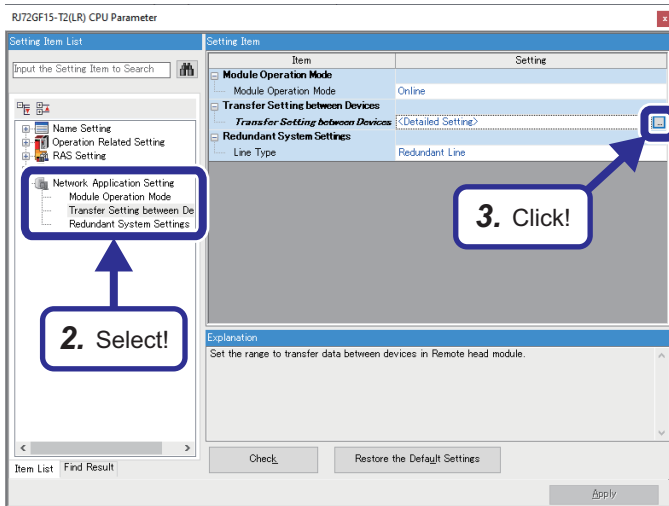

2. In the "Setting Item List" window, select "Network Application Setting" ⇒ "Transfer Setting between Devices".
3. Click the  button for "Transfer Setting between Devices".

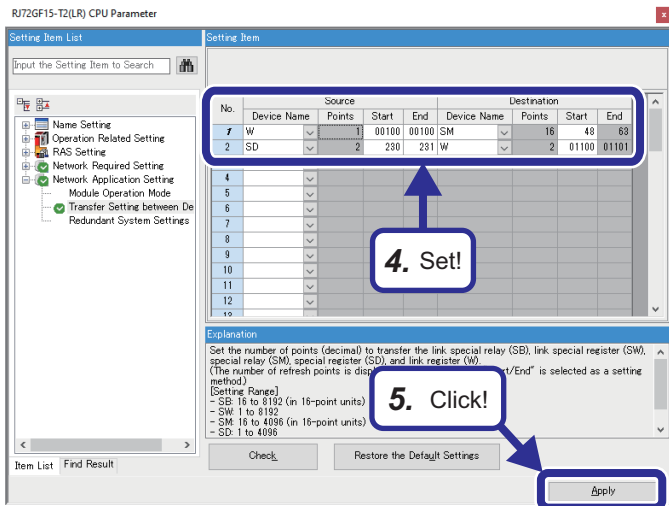

4. Set "Transfer Setting between Devices" as follows:
 [Settings]
 [No.1]
 <Source>
 Device Name: W
 Start: 100
 End: 100
 <Destination>
 Device Name: SM
 Start: 48
 [No.2]
 <Source>
 Device Name: SD
 Start: 230
 End: 231
 <Destination>
 Device Name: W
 Start: 1100
5. Click the [Apply] button.

Point 

According to the refresh setting parameters set in the CC-Link IE Field Network module, data is refreshed to the device of the CPU module as follows:

- Remote head module (W100 → Process CPU W1100)
- Remote head module (W1100 → Process CPU W1600)
- Remote head module (W1101 → Process CPU W1601)

5.2 Programming

Creating a new program file

Create a new program file in "School_Master". In this exercise, a scan execution type ladder program file will be created.

Operating procedure

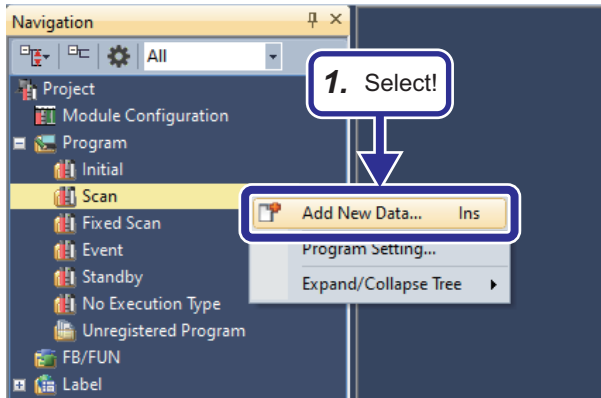

1. Open the project "School_Master", right-click [Scan] in the Navigation window, and select [Add New Data].

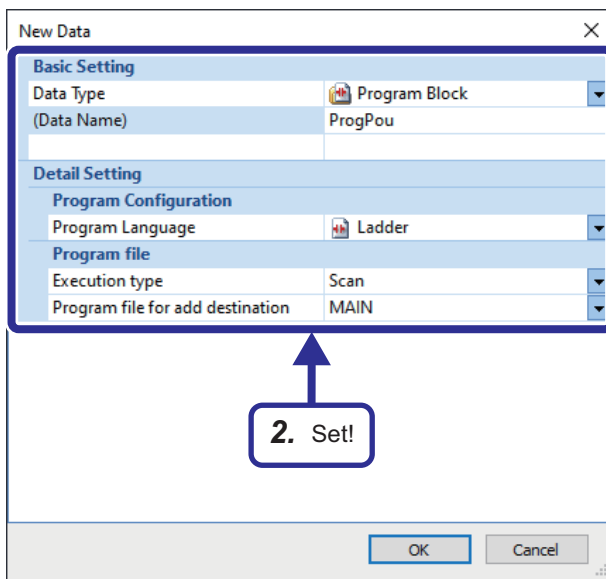

2. The "New Data" window appears. Set items as shown on the left. Enter any desired name for "(Data Name)" and "Program file for add destination".

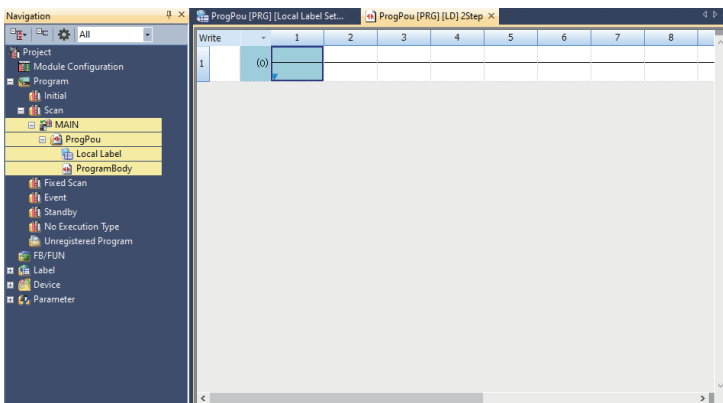

3. A new program file is created on the Navigation window, and the sheet is displayed.

Ladder programming

Create a program required for inputting/outputting signals in "School_Master". The program consists of the following five programs (ladder blocks).

- CC-Link IE Field Network interlock program
- 24VDC input/output and contact output transfer program (RY10R2, RX40NC6B, RY40PT5B)
- Measured temperature value read program (R60TD8-G)
- DA conversion execution program (R60DA16-G)
- AD conversion execution program (R60AD8-G)

Program example for inputting/outputting signals from/to the slave station

CC-Link IE Field Network interlock program										
(0)	GF11_1.bSts_DataLinkError	GF11_1.bnSts_RedundantSystemDataLinkError_Station[1]						MC	N0	M0 Communication ready flag
	N0	M0								Communication ready flag
RY10R2, RX40NC6B, RY40PT5B 24VDC input/output and contact output transfer program										
(38)	SM400							MOV	D0	K4Y1040 RY10R2 output temporary storage area
	Always On									RY10R2 output
								MOV	K4X1000	D1 RX40NC6B input temporary storage area
										RX40NC6B input temporary storage area
								MOV	D2	K4Y1020 RY40PT5B output temporary storage area
										RY40PT5B output temporary storage area
R60TD8-G Measured temperature value read program										
(89)	X1050	X105E	Y1059	W1550.0				MOV	W1551	D11 CH1 Measured temperature value temporary storage area
	Module READY	Conversion completed flag	Operating condition setting request	CH1 Conversion completed flag						CH1 Measured temperature value temporary storage area

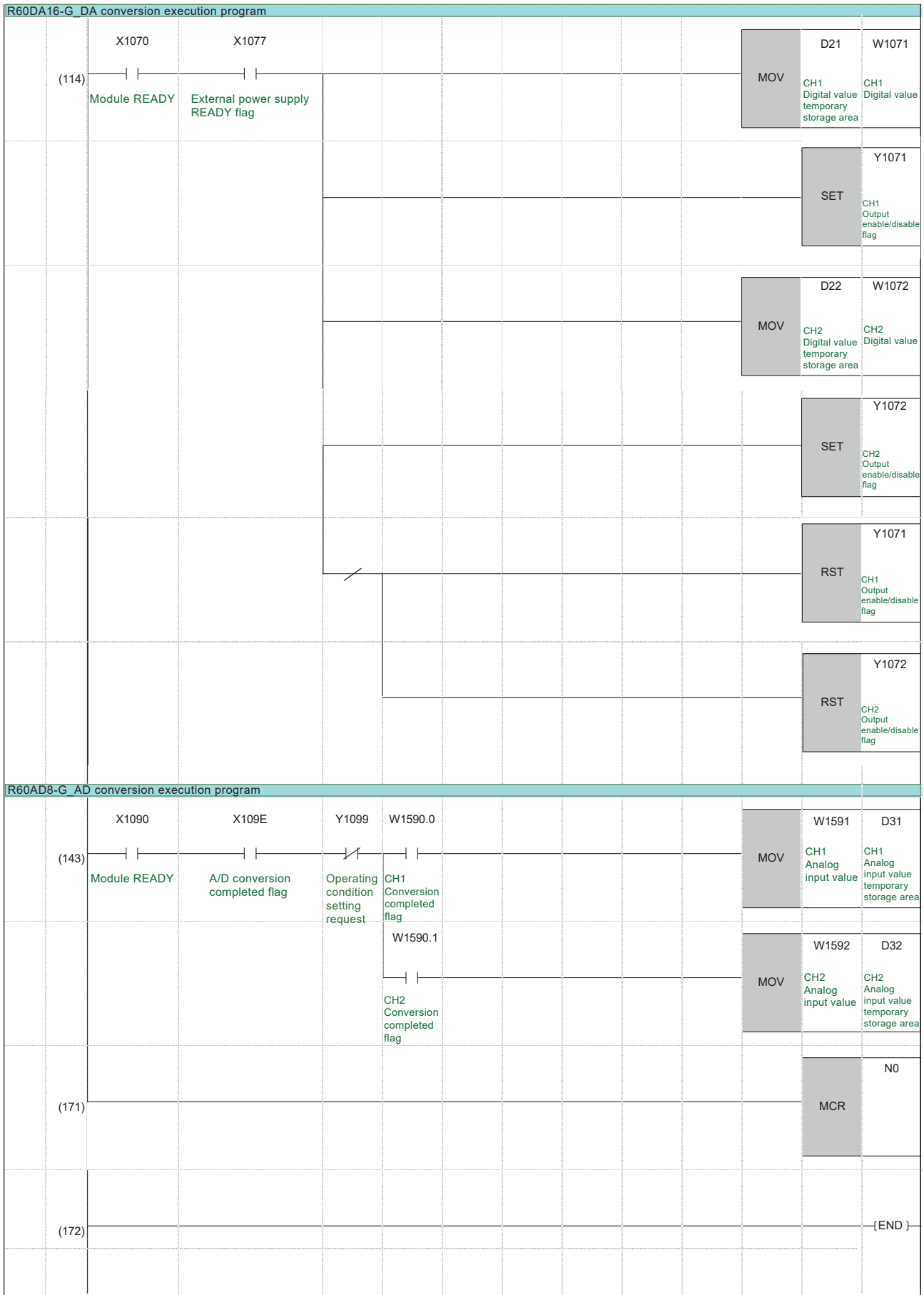

■CC-Link IE Field Network interlock program

An interlock program that monitors the data link status of the own station and other stations is required for CC-Link IE Field Network. Configure an interlock using the following module labels to prevent link refresh values from being used when a link-down occurs.*1

- Data link error status of own station (SB0049)
- Redundant system data link status of each station (SW01B0 to SW01B7)

*1 When the Process CPU with firmware version 18 or later is used, the "Setting to Wait Receiving Cyclic Data after Switching System" parameter can be used instead of the CC-Link IE Field Network interlock program to address the issue of cyclic data being turned off at the time of system switching. For details, refer to the following.

📖 MELSEC iQ-R CPU Module User's Manual (Application)

In the program example here, the MC instruction is used to interlock all the programs (ladder blocks) that use link refresh values. All the following programs (ladder blocks) are included between the MC instruction and the MCR instruction.

📖 Page 180 24VDC input/output and contact output transfer program (RX40NC6B, RY40PT5B, RY10R2)

📖 Page 181 Measured temperature value read program (R60TD8-G)

📖 Page 182 DA conversion execution program (R60DA16-G)

📖 Page 183 AD conversion execution program (R60AD8-G)

- Devices to be used

Device <Module label>	Name
SB0049 <GF11_1.bnSt_DataLink Error>	Data link error status of own station
SW01B0.0 <GF11_1.bnSts_RedundantSystemDataLinkError_Station[1]>	Redundant system data link status of each station (station No.1)
N0	Nesting
M0	Communication ready flag (station No.1)

- Program example

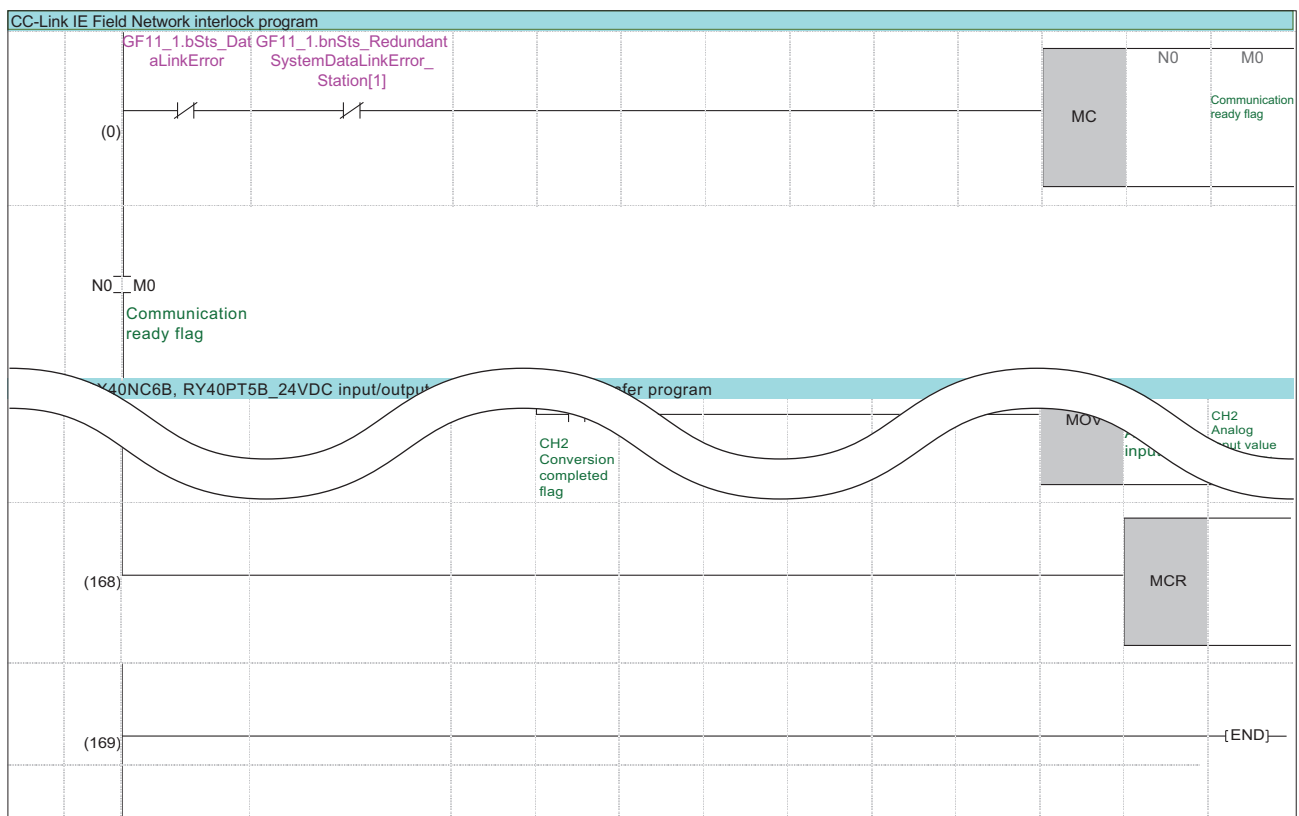

When a data link error occurs, the MC instruction is not executed.

When the execution command of the MC instruction is off, the operation result between the MC and MCR instructions will be as follows:

- Device used by the OUT instruction: Forced off
 - Device used by other instructions: Held
 - High-speed (low-speed) timer: The count value is set to 0, and the coil and contact are turned off.
 - High-speed (low-speed) retentive timer, counter: The coil is turned off, and the count value and contact are held.
-

■24VDC input/output and contact output transfer program (RX40NC6B, RY40PT5B, RY10R2)

A program to be used as a buffer is required to perform interlock processing for CC-Link IE Field Network at one time. In the program, the devices used as temporary storage areas are used for input/output processing in the project. By interlocking this program, there is no need to write multiple interlock programs in the project.

Note that CH1 of the contact output module (RY10R2) is used as a heating signal for the heater.

- Devices to be used

Device	Name	
SM400	Always On	Special relay
X1000 to X100F	RX40NC6B input	Slave station X0000 to X000F
Y1040 to Y104F	RY10R2 output	Slave station Y0040 to Y004F
Y1020 to Y102F	RY40PT5B output	Slave station Y0020 to Y002F
D0	RY10R2 output temporary storage area	
D1	RX40NC6B input temporary storage area	
D2	RY40PT5B output temporary storage area	

- Program example

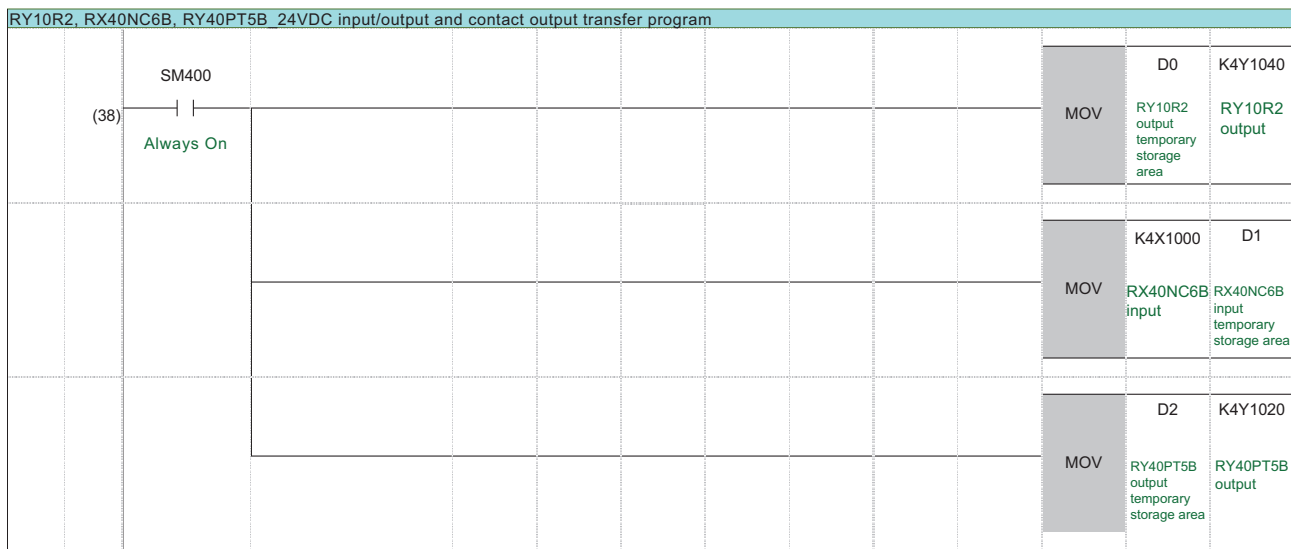

I/O status is always transferred between temporary storage devices and refresh devices.

■ Measured temperature value read program (R60TD8-G)

Create a program that inputs thermocouple signals input to the R60TD8-G.

Configure an interlock to prevent input values from being used when the signal input fails. To read measured temperature values in the project, use temporary storage devices.

- Devices to be used

Device	Name	
X1050	Module READY	Slave station X0050
X105E	Conversion completed flag	Slave station X005E
Y1059	Operating condition setting request	Slave station Y0059
W1550.0	[CH1] Conversion completed flag	Slave station W1050.0
W1551	[CH1] Measured temperature value	Slave station W1051
D11	[CH1] Measured temperature value temporary storage area	

- Program example

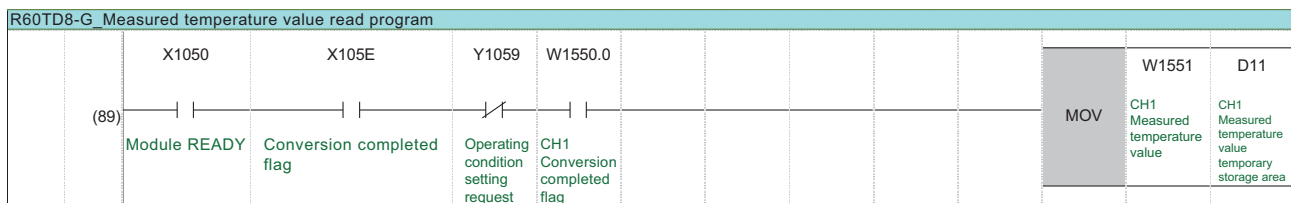

Point

Configure an interlock to prevent input values from being used when the signal conversion fails.

■ DA conversion execution program (R60DA16-G)

Create a program that outputs analog signals from the R60DA16-G.

Configure an interlock to prevent signals from being output when the signal output fails. To read or modify output values in the project, use temporary storage devices.

- Devices to be used

Device	Name	
X1070	Module READY	Slave station X0070
X1077	External power supply READY flag	Slave station X0077
Y1071	[CH1] Output enable/disable flag	Slave station Y0071
Y1072	[CH2] Output enable/disable flag	Slave station Y0072
W1071	[CH1] Digital value	Slave station W0071
W1072	[CH2] Digital value	Slave station W0072
D21	[CH1] Digital value temporary storage area	
D22	[CH2] Digital value temporary storage area	

- Program example

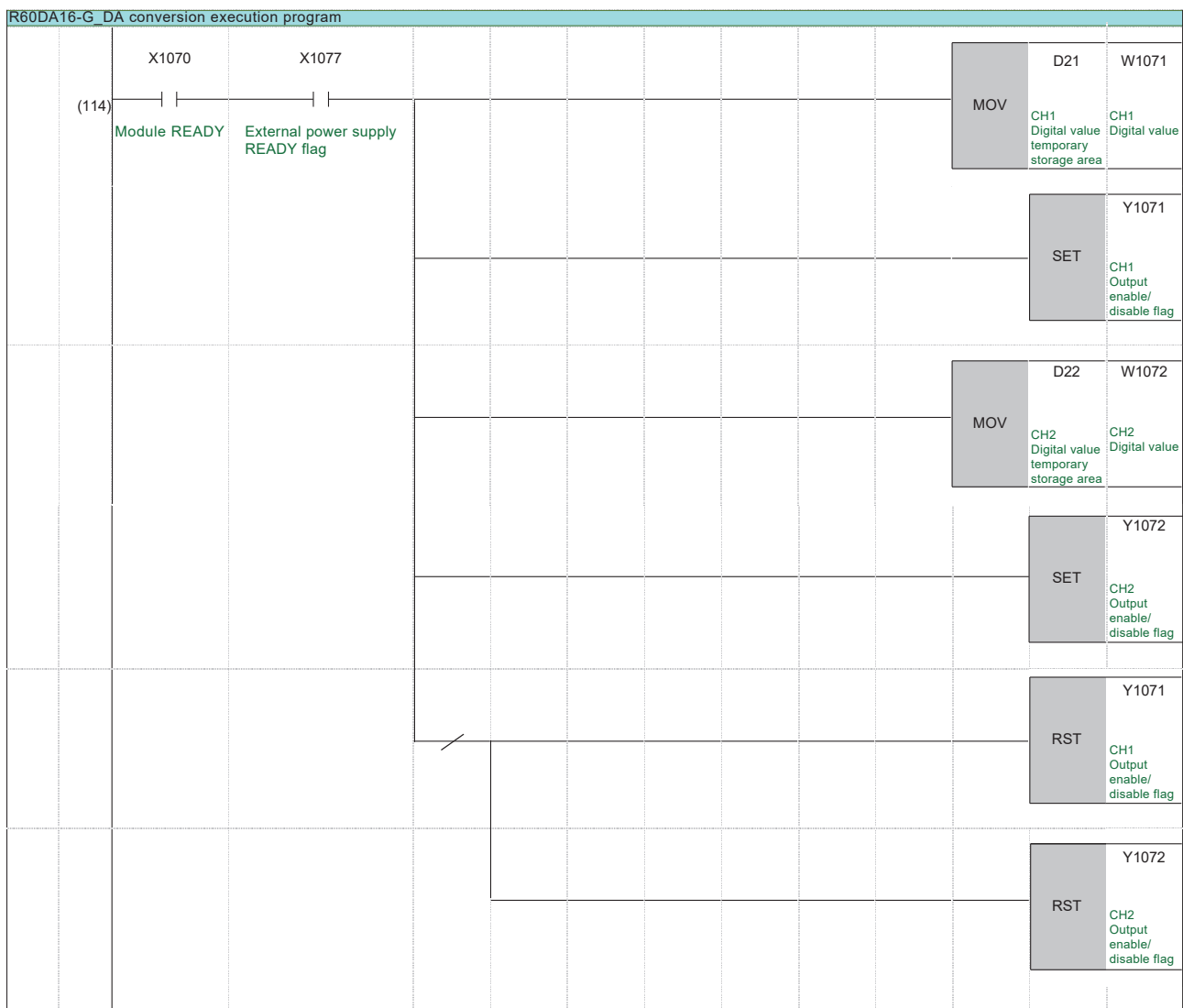

Point

Configure an interlock to prevent signals from being output when the signal output is abnormal. When the output enable/disable flags (Y1071, Y1072) of the R60DA16-G are off, analog output is stopped.

■AD conversion execution program (R60AD8-G)

Create a program that inputs analog signals input to the R60AD8-G.

Configure an interlock to prevent signals from being input when the signal input fails. To read input values in the project, use temporary storage devices.

- Devices to be used

Device	Name	
X1090	Module READY	Slave station X0090
X109E	A/D conversion completed flag	Slave station X009E
Y1099	Operating condition setting request	Slave station Y0099
W1590.0	[CH1] Conversion completed flag	Slave station W1090.0
W1590.1	[CH2] Conversion completed flag	Slave station W1090.1
W1591	[CH1] Analog input value	Slave station W1091
W1592	[CH2] Analog input value	Slave station W1092
D31	[CH1] Analog input value temporary storage area	
D32	[CH2] Analog input value temporary storage area	

- Program example

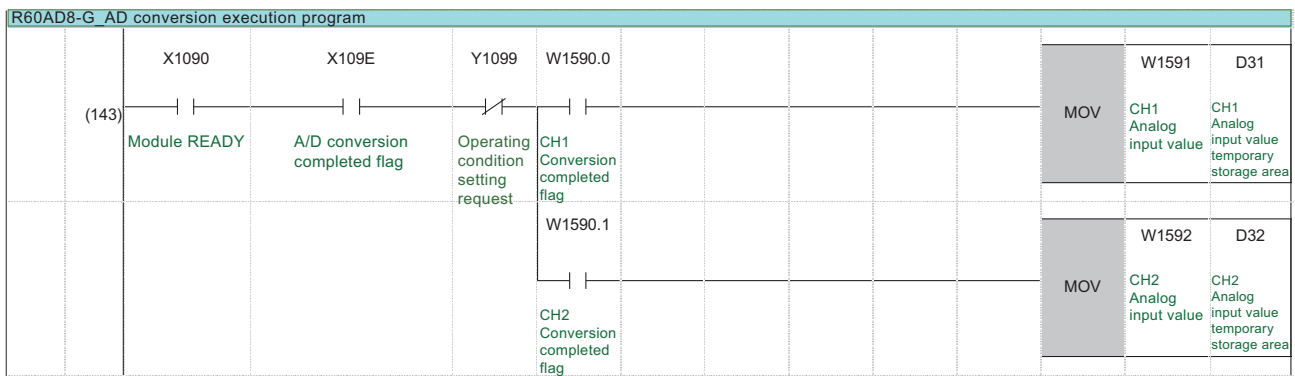

Configure an interlock to prevent input values from being used when the signal conversion fails.

5.3 Converting the Project

Convert the project created for the master station, "School_Master".
For the conversion procedure, refer to Page 138 Converting the Projects.

5.4 Writing the Projects

Write the project for the master station "School_Master" to the Process CPU (R32PCPU) and the project for the slave station "School_Master" to the remote head module (RJ72GF15-T2), and start signal input/output.
For the write procedure, refer to Page 140 Writing the Projects. For the data link procedure, refer to step **13.** of Page 37 Starting up both systems simultaneously.

5.5 Checking the Operation

Check the operation of I/O signals in the configured redundant system.

Redundant system

Master station

To check the operation, check the LED status of each module.

■Process CPU

Operating procedure

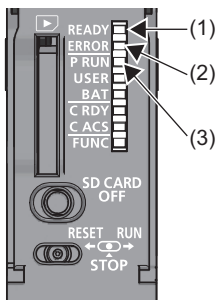

1. Check that the READY LED (1) is on.
2. Check that the ERROR LED (2) is off.
3. Check that the P RUN LED (3) is on.

■CC-Link IE Field Network module

Operating procedure

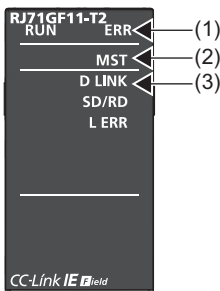

1. Check that the ERR LED (1) is off.
2. Check that the MST LED (2) is on.
3. Check that the D LINK LED (3) is on.

Slave station

To check the operation, check the LED status of the remote head modules on the slave station.

Operating procedure

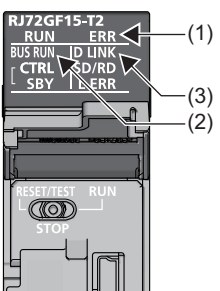

1. Check that the ERR LED (1) is off.
2. Check that the BUS RUN LED (2) is on.
3. Check that the D LINK LED (3) is on.

Signal input/output

Check that signals are normally input/output from/to the input/output module on the slave station.

The signal input/output of the RX40NC6B, RY40PT5B, and RY10R2 can be checked with the LEDs of each module.

The signal output of the R60DA16-G can be checked by monitoring the converted signal that is input of the R60AD8-G because CH1 and CH2 of these modules are connected.

The R60TD8-G is connected to the thermocouple of the heater. The signal input of the module can be checked by monitoring whether the input value matches the operating ambient temperature or not.

Operating procedure

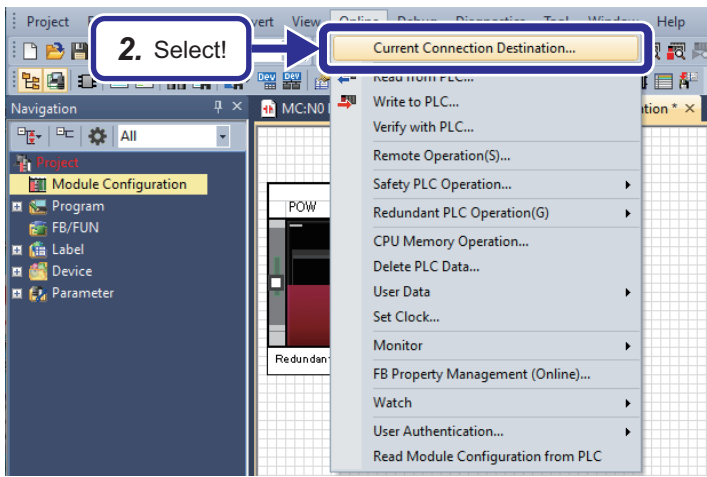

1. Connect a USB cable to the Process CPU of either system A or system B.
2. Open the project "School_Master", and select [Online] ⇒ [Current Connection Destination] to open the "Specify Connection Destination" window.

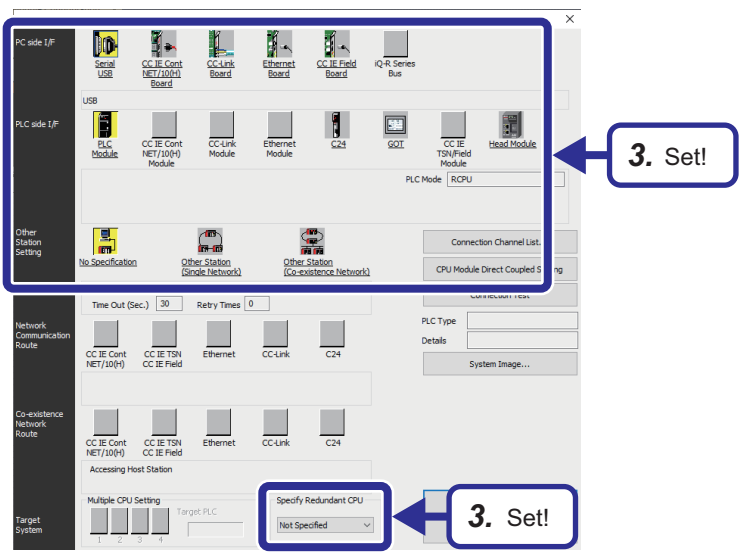

3. Set the following:
 [Settings]
 PC side I/F: Serial USB
 PLC side I/F: PLC Module
 Other Station Setting: No Specification
 Specify Redundant CPU: Not Specified



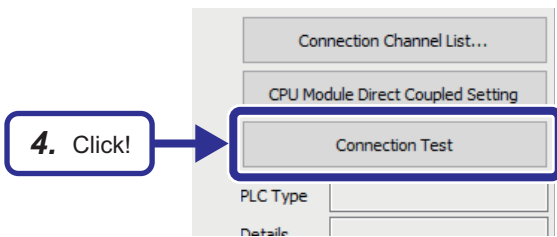

4. Click the [Connection Test] button.

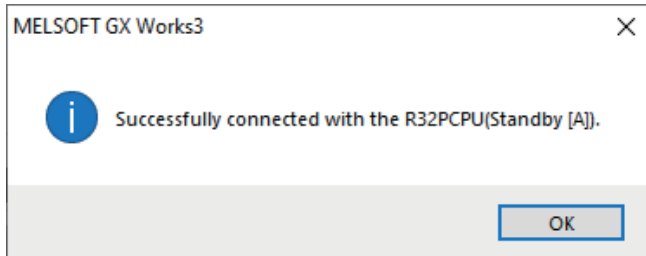

5. Check that the connection with the CPU module has been successfully established.

5

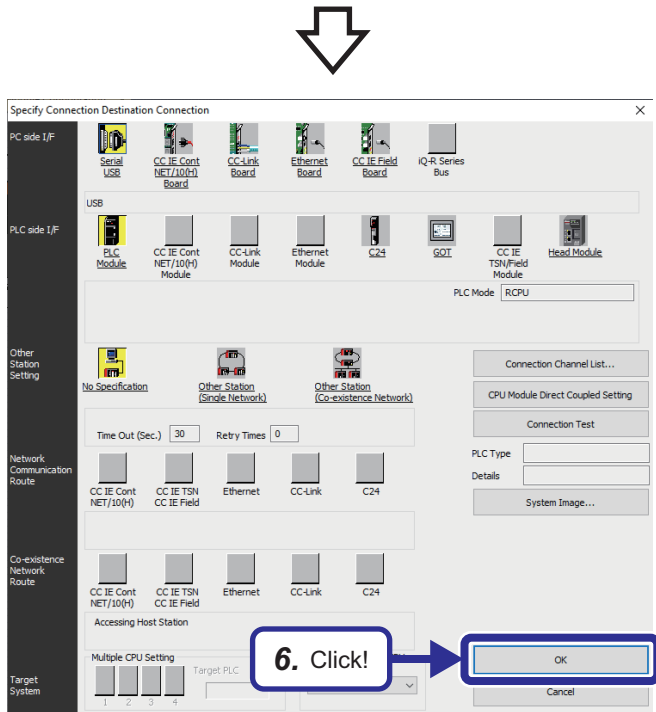

6. Click the [OK] button.

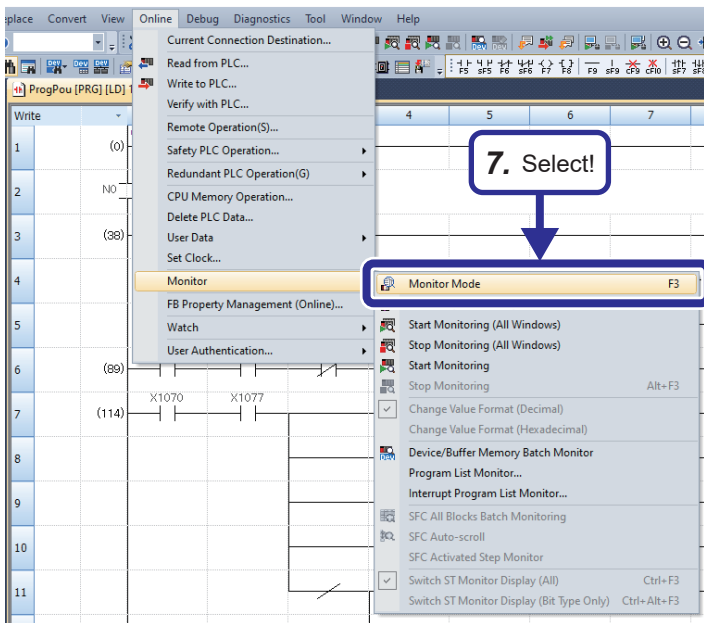

7. Select [Online] ⇒ [Monitor] ⇒ [Monitor Mode] from the menu of the engineering tool.

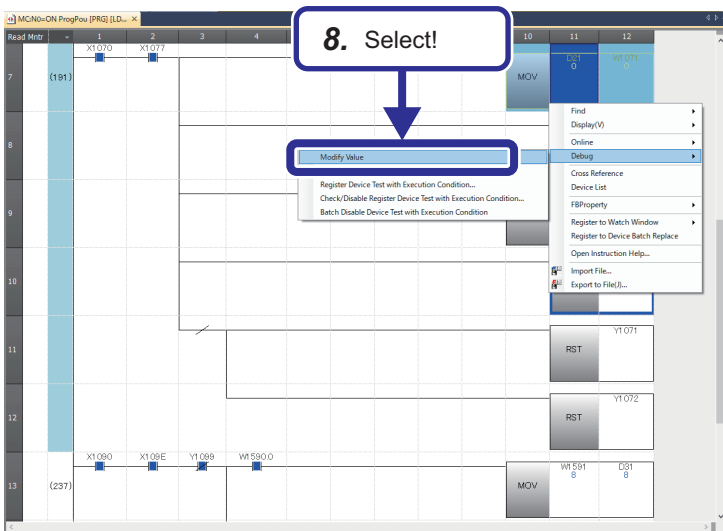

8. Check the output signal. Right-click the target device, select [Debug] ⇒ [Modify Value], and change the current value stored in the device.

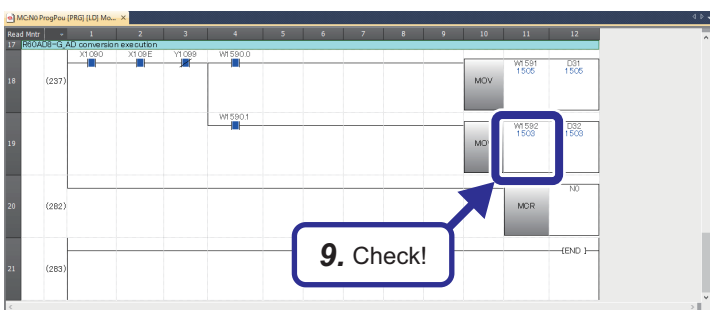

9. Check the input signal. Check that the changed output signal is correctly input to the CPU module.

6 MAINTENANCE AND INSPECTION OF A REDUNDANT SYSTEM

This chapter describes the maintenance and inspection of a redundant system.

6.1 Module Replacement Procedure

There are two ways to replace a module online in a redundant system.

- Replacing a module in the control system using the online module change function
- Replacing a module in the standby system (To replace a module in the standby system, power off the standby system or use the online module change function.)

○: Replaceable, ×: Not replaceable

Replacement target	Availability	
	Control system	Standby system
CPU module	×	○
Power supply module	×	○
Redundant power supply module	○*1	○
Redundant function module	○*3	○*2
I/O module	○*4	○*2
Network module	×	○
Main base unit	×	○

*1 This module can be replaced only when used in a redundant power supply system.

*2 To replace these modules without powering off the system, use the online module change function. (📖 MELSEC iQ-R Online Module Change Manual)

*3 When an error has been detected in the redundant function module of the control system, a continuation error occurs in the CPU module. As a result, the systems are not switched and the control system and the standby system continue their operation. When the redundant function module has failed, replace the module online. (📖 MELSEC iQ-R Online Module Change Manual)

*4 Use the online module change function. (📖 MELSEC iQ-R Online Module Change Manual)

Point

When the standby system is powered off, a continuation error occurs in the CPU module of the control system. After replacing a module, clear the continuation error that has occurred in the CPU module of the control system.

For the error clear method, refer to the following.

📖 MELSEC iQ-R CPU Module User's Manual (Application)

The rest of this section describes how to replace each module in the standby system by powering off the standby system.

Replacing the CPU module

The following is the procedure for replacing the CPU module.

The replacement procedure differs depending on the auto memory copy setting (enabled or disabled). ( Page 68 Auto memory copy)

When the auto memory copy setting is enabled

1. Checking the operation mode

Check the BACKUP LED of the redundant function module in the control system, and confirm that the CPU module in the control system is in backup mode.

- The BACKUP LED is on or flashing.

2. Checking the system of the replacement target CPU module

Check the CTRL LED and SBY LED of the redundant function module in the system to which the replacement target CPU module belongs, and confirm that the replacement target CPU module is set as the standby system.

- The CTRL LED is off and the SBY LED is on.

3. Powering off the standby system

Power off the standby system. When the standby system is powered off, the BACKUP LED of the redundant function module in the control system flashes.

4. Replacing the CPU module in the standby system

Replace the CPU module in the standby system with a new CPU module whose model is the same as that of the CPU module in the control system. If an SD memory card or an extended SRAM cassette has been inserted to the replacement target CPU module, insert it to the new CPU module.

5. Changing the switch position of the CPU module in the standby system

Set the RUN/STOP/RESET switch of the CPU module in the standby system to the RUN position.

6. Powering on the standby system

Power on the standby system.

7. Executing the memory copy from the control system to the standby system

The memory copy function automatically starts. Upon completion of the memory copy function, the MEMORY COPY LED of the redundant function module turns off in both systems. Then, the CPU module in the standby system is automatically reset and restarted. ( Page 68 Auto memory copy)

The BACKUP LED of the redundant function module in the control system turns on. (The control system no longer waits for the start-up of the other system.)

When the auto memory copy setting is disabled

1. Checking the system of the replacement target CPU module

Check the CTRL LED and SBY LED of the redundant function module in the system to which the replacement target CPU module belongs, and confirm that the replacement target CPU module is set as the standby system.

- The CTRL LED is off and the SBY LED is on.

2. Powering off the standby system

Power off the standby system. When the standby system is powered off, the BACKUP LED of the redundant function module in the control system flashes. (The control system enters the wait state for the start-up of the other system.)

3. Replacing the CPU module in the standby system

Replace the CPU module in the standby system with a new CPU module whose model is the same as that of the CPU module in the control system. If an SD memory card or an extended SRAM cassette has been inserted to the replacement target CPU module, insert it to the new CPU module.



4. Changing the switch position of the CPU module in the standby system

Set the RUN/STOP/RESET switch of the CPU module in the standby system to the RUN position.

5. Powering on the standby system

Power on the standby system.

6. Executing the memory copy from the control system to the standby system

Execute the memory copy using the engineering tool or the special relay and special register. ( Page 69 Memory copy using the engineering tool,  Page 70 Memory copy using the special relay and special register)

Upon completion of the memory copy function, the MEMORY COPY LED of the redundant function module in the control system turns off and that in the standby system turns on.

7. Restarting the standby system

Restart the standby system. When the standby system is powered on, the BACKUP LED of the redundant function module in the control system turns on. (The control system no longer waits for the start-up of the other system.)

Replacing the power supply module

The following is the procedure for replacing the power supply module.

1. Checking the system of the replacement target module

Check the CTRL LED and SBY LED of the redundant function module in the system to which the replacement target module belongs, and confirm that the replacement target module is in the standby system.

- The CTRL LED is off and the SBY LED is on.

2. Powering off the standby system

Power off the standby system. When the standby system is powered off, the BACKUP LED of the redundant function module in the control system flashes. (The control system enters the wait state for the start-up of the other system.)

3. Replacing the power supply module in the standby system

Replace the power supply module in the standby system.

4. Powering on the standby system

Check that the cables are correctly connected to the power supply module and the power supply voltage is normal, and then power on the standby system. When the standby system is powered on, the BACKUP LED of the redundant function module in the control system turns on. (The control system no longer waits for the start-up of the other system.)

Replacing the redundant function module

The following is the procedure for replacing the redundant function module.

1. Checking the system of the replacement target module

Check the CTRL LED and SBY LED of the redundant function module in the system to which the replacement target module belongs, and confirm that the replacement target module is in the standby system.

- The CTRL LED is off and the SBY LED is on.

2. Powering off the standby system

Power off the standby system. When the standby system is powered off, the BACKUP LED of the redundant function module in the control system flashes. (The control system enters the wait state for the start-up of the other system.)

3. Replacing the redundant function module in the standby system

Replace the redundant function module in the standby system.

4. Powering on the standby system

Power on the standby system. When the standby system is powered on, the BACKUP LED of the redundant function module in the control system turns on. (The control system no longer waits for the start-up of the other system.)

5. Checking the modules for errors

Check that no error has occurred in the CPU module or the redundant function module of the standby system. If the ERROR LED of either of the modules is on or flashing, identify the error and eliminate the error cause.

Replacing the I/O module

The following is the procedure for replacing the I/O module.

1. Checking the system of the replacement target module

Check the CTRL LED and SBY LED of the redundant function module in the system to which the replacement target module belongs, and confirm that the replacement target module is in the standby system.

- The CTRL LED is off and the SBY LED is on.

2. Powering off the standby system

Power off the standby system. When the standby system is powered off, the BACKUP LED of the redundant function module in the control system flashes. (The control system enters the wait state for the start-up of the other system.)

3. Replacing the I/O module in the standby system

Replace the I/O module in the standby system with a new I/O module whose model is the same as that of the I/O module in the control system.

4. Powering on the standby system

Power on the standby system. When the standby system is powered on, the BACKUP LED of the redundant function module in the control system turns on. (The control system no longer waits for the start-up of the other system.)

Replacing the network module

The following is the procedure for replacing the network module.

1. Checking the system of the replacement target module

Check the CTRL LED and SBY LED of the redundant function module in the system to which the replacement target module belongs, and confirm that the replacement target module is in the standby system.

- The CTRL LED is off and the SBY LED is on.

2. Powering off the standby system

Power off the standby system. When the standby system is powered off, the BACKUP LED of the redundant function module in the control system flashes. (The control system enters the wait state for the start-up of the other system.)

3. Replacing the network module in the standby system

Replace the network module in the standby system with a new network module whose model is the same as that of the network module in the control system.

4. Powering on the standby system

Power on the standby system. When the standby system is powered on, the BACKUP LED of the redundant function module in the control system turns on. (The control system no longer waits for the start-up of the other system.)

5. Diagnosing the network of the standby system

Check that the network module operates normally.

Replacing the remote head module

The following is the procedure for replacing the remote head module.

The remote head module in the standby system can be replaced while the remote head module in the control system is controlling the redundant system (online).

1. Checking the system of the replacement target module

Check that the remote head module to be replaced is set as the standby system. (The CTRL LED is off.) To replace the remote head module in the control system, switch the system to the standby system using the engineering tool.

 GX Works3 Operating Manual

2. Disconnecting the Ethernet cable

Disconnect the Ethernet cable from the remote head module to be replaced.

 MELSEC iQ-R CC-Link IE Field Network Remote Head Module User's Manual (Startup)

3. Removing the remote head module in the standby system

Set the switch of the remote head module in the standby system to the STOP position, and remove the module from the main base unit.

 MELSEC iQ-R Module Configuration Manual

4. Replacing the remote head module

Set the switch of a new remote head module to the STOP position, and mount the module on the main base unit.

 MELSEC iQ-R Module Configuration Manual

5. Resetting the remote head module

Reset the new remote head module in the standby system.

6. Checking the power supply

Check that the RUN LED of the remote head module in the standby system is on and that power is being supplied normally.

7. Restarting the remote head module

When a file mismatch is detected by the system consistency check, the memory copy function (from the control system to the standby system) is automatically executed. Then, the remote head module in the standby system is automatically reset and restarted.

8. Connecting the Ethernet cable

Connect the Ethernet cable to the remote head module.

 MELSEC iQ-R CC-Link IE Field Network Remote Head Module User's Manual (Startup)

9. Changing the switch position of the remote head module

Set the switch of the remote head module in the standby system to the same position as that of the remote head module in the control system.

Point

When the remote head module in the standby system is removed, a minor error occurs in the remote head module of the control system.

After replacing the remote head module of the standby system, clear the error in the remote head module of the control system if necessary.

6.2 Online Module Change

Overview

The online module change function allows users to replace a module mounted on a main base unit or an extension base unit with a new module while controlling the system online.

Users can replace a failed module with a new module of the same model without stopping the system operation.

Changing a module directly

By setting parameters in advance, the target module can be replaced with a new one without using the engineering tool or external devices. The special relay and special register are not used. Thus, the module can be replaced easily.

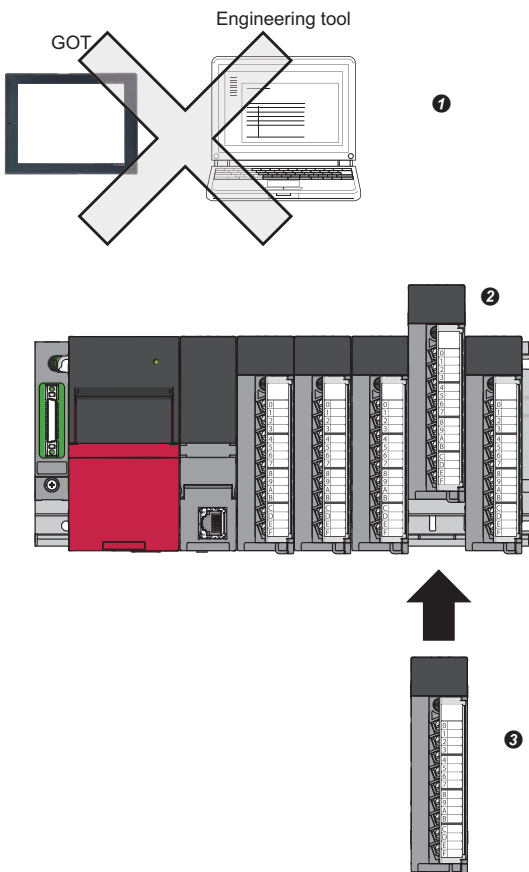

- ① The special relay and special register are not used.
- ② Remove the replacement target module.
- ③ Mount a new module.

For details, refer to the following.

📖 Page 202 Changing a module directly

Configuration devices

The following modules and engineering tool support the online module change function.

CPU module

When the system is configured with a Process CPU or SIL2 Process CPU, the CPU module can be changed online.

Remote head module

When the system is configured with a remote head module, the remote head module can be changed online.

Only direct change is available when a redundant system is configured using two remote head modules.

Engineering tool

Use an engineering tool with a version supporting the CPU module, remote head module, and modules to be replaced online.

For the versions of the engineering tool, refer to the following.

 GX Works3 Operating Manual

Modules that can be changed online

The following table lists the modules that can be changed online.

Module	Model	Remarks	
CPU module extension	Redundant function module ^{*1}	R6RFM	—
I/O module	AC input module	RX10, RX10-TS, RX28	—
	DC input module	RX40C7, RX40C7-TS, RX41C4, RX41C4-TS, RX42C4, RX70C4, RX71C4, RX72C4	
	DC high-speed input module	RX40PC6H, RX40NC6H, RX41C6HS, RX61C6HS	
	Input module with diagnostic functions	RX40NC6B ^{*2}	
	Contact output module	RY10R2, RY10R2-TS, RY18R2A	
	Triac output module	RY20S6	
	Transistor output module	RY40NT5P, RY40NT5P-TS, RY41NT2P, RY41NT2P-TS, RY42NT2P, RY40PT5P, RY40PT5P-TS, RY41PT1P, RY41PT1P-TS, RY42PT1P	
	Transistor high-speed output module	RY41NT2H, RY41PT2H	
	Output module with diagnostic functions	RY40PT5B ^{*2}	
I/O combined module	RH42C4NT2P		

Module	Model	Remarks	
Intelligent function module	Analog-digital converter module	R60AD4, R60ADI8, R60ADV8	The supported firmware version is 02 or later.
	Channel isolated analog-digital converter module	R60AD8-G, R60AD16-G	—
	High speed analog-digital converter module	R60ADH4	—
	HART-enabled analog-digital converter module	R60ADI8-HA	—
	Digital-analog converter module	R60DA4, R60DAI8, R60DAV8	The supported firmware version is 02 or later.
	Channel isolated digital-analog converter module	R60DA8-G, R60DA16-G	—
	High speed digital-analog converter module	R60DAH4	—
	Channel isolated thermocouple input module	R60TD8-G	—
	Channel isolated RTD input module	R60RD8-G	—
	Temperature control module	R60TCTRT2TT2, R60TCRT4, R60TCTRT2TT2BW, R60TCRT4BW	—
	Simple Motion module	RD77MS2, RD77MS4, RD77MS8, RD77MS16	The supported firmware version is 03 or later.
	High-speed counter module	RD62P2, RD62D2, RD62P2E	—
	Channel isolated pulse input module	RD60P8-G	—
	Flexible high-speed I/O control module	RD40PD01	—
	Positioning module	RD75P2, RD75P4, RD75D2, RD75D4	The supported firmware version is 02 or later.
	MES interface module	RD81MES96	The supported firmware version is 03 or later.
	High speed data logger module	RD81DL96	—
	C intelligent function module	RD55UP06-V	—
	OPC UA server module	RD81OPC96	—

*1 The direct change is not available for this module. Replace this module using the special relay and special register.

*2 These modules cannot be changed online when operated in SIL2 mode.

Restriction

MELSEC-Q series modules mounted on the RQ extension base unit or the MELSEC-Q series extension base unit cannot be changed online.

Specifications

This section describes the specifications of the online module change function.

- The following table summarizes the application and features of the online module change method.

Method	Application	Advantage	Disadvantage
Changing a module directly*1	To replace a module easily without any special operations	No special operations are required. A module can be replaced easily.	<ul style="list-style-type: none"> • When "Direct change setting" is set to "Enable" in the parameter, the system cannot determine whether the module has been accidentally removed or the online module change operation is being performed. • Until the removal of the module is detected, the scan time increases compared to other methods.







*1 The redundant function module cannot be changed online with this method.

- After the replacement, the module-specific information is restored to a new module from the module-specific backup parameter file saved in the CPU module or the remote head module. The new module can continue the same operation using the restored information.
- When the system is configured with a CPU module, modules can be changed online when there is no stop error occurred in the CPU module. Even when the operating status of the CPU module is switched from RUN to STOP/PAUSE while a module is being changed online, the online change operation can be continued. However, when the CPU module is reset or a stop error occurs, the online change operation cannot be continued.
- When the system is configured with a remote head module, modules can be changed online when there is no moderate error or major error in the remote head module. Even when the operating status of the remote head module is switched from RUN to STOP while a module is being changed online, the online change operation can be continued. However, when the remote head module is reset or a moderate or major error occurs, the online change operation cannot be continued.

Operating status	Online module change availability
RUN	○
STOP	○
PAUSE	○
Initial	×
Reset	×
Stop error (in the CPU module)	×
Moderate error or major error (in the remote head module)	×

Procedure of the online module change operation

The online module change is performed in the following steps.

1. Setting parameters in advance ( Page 202 Setting parameters in advance)
2. Checking the target module before replacement ( Page 203 Checking the target module before replacement)
3. Removing the module ( Page 204 Removing the module)
4. Mounting a new module ( Page 205 Mounting a new module)
5. Recognizing the module ( Page 205 Recognizing the module)
6. Starting the control of the module ( Page 206 Starting the control of the module)

LED status

The following tables list the LED status at each step of the online module change operation.

[When the system is configured with a CPU module]

Step	Transition of SD1617 (Online module change progress status) ^{*1}	LED status of the CPU module		LED status of the replacement target module ^{*3}
		READY LED	ERROR LED ^{*2}	RUN LED
Checking the target module before replacement	0	On	Off	On
Removing the module	0 → 5	On → Flashing (in 400ms intervals)	Off → On ^{*4}	—
Mounting a new module	5 → 7	Flashing (in 400ms intervals)	On	Off
Recognizing the module	7 → 9	Flashing (in 400ms intervals)	On	Off → On
Starting the control of the module	9 → 0	Flashing (in 400ms intervals) → On	On → Off ^{*5}	On

*1 The online module change progress status is stored.

- 0: Normal operation
- 1: Module being selected
- 2: Module selected
- 3: Module removal requested
- 4: Module removal ready
- 5: Module removed
- 6: Module mounted
- 7: Module being recognized
- 8: Module recognized
- 9: Module control resumed

*2 If a continuation error has occurred (the ERROR LED is on) before the online module change, the ERROR LED remains on during the online module change.

*3 If the module has failed, the LED status may differ from those described.

*4 When the replacement target module is removed by means of the direct change, the READY LED of the CPU module starts flashing (a module verification error) and the ERROR LED turns on. Even after the direct change has been completed successfully, the module verification error is not cleared and the ERROR LED remains on.

*5 To turn off the ERROR LED, the detected error needs to be cleared using the module diagnostic function of the engineering tool or other methods.

[When the system is configured with a remote head module]

Step	Transition of SD1617 (Online module change progress status) ^{*1}	LED status of the remote head module		LED status of the replacement target module ^{*3}
		RUN LED	ERR LED ^{*2}	RUN LED
Checking the target module before replacement	0	On	Off	On
Removing the module	0 → 5	On → Flashing (in 400ms intervals)	Off → On ^{*4}	—
Mounting a new module	5 → 7	Flashing (in 400ms intervals)	On	Off
Recognizing the module	7 → 9	Flashing (every 400ms)	On	Off → On
Starting the control of the module	9 → 0	Flashing (in 400ms intervals) → On	On → Off ^{*5}	On

*1 The online module change progress status is stored.

0: Normal operation

1: Module being selected

2: Module selected

3: Module removal requested

4: Module removal ready

5: Module removed

6: Module mounted

7: Module being recognized

8: Module recognized

9: Module control resumed

*2 If a minor error has occurred (the ERR LED is on) before the online module change, the ERR LED remains on during the module change.

*3 If the module has failed, the LED status may differ from those described.

*4 When the replacement target module is removed by means of the direct change, the RUN LED of the remote head module starts flashing (a module verification error) and the ERR LED turns on. Even after the direct change has been completed successfully, the module verification error is not cleared and the ERR LED remains on.

*5 To turn off the ERR LED, the detected error needs to be cleared using the module diagnostic function of the engineering tool or other methods.

Access to the modules

The following tables list the access to the replacement target modules at each step of the online module change operation.

- I/O modules

○: Executed, ×: Not executed

Step	I/O refresh		Direct access		FROM/TO instructions	Instruction that uses any module access device	Device test	Monitor
	Input (X)	Output (Y)	Input (DX)	Output (DY)				
Checking the target module before replacement	○	○	○	○	○	○	○	○
Removing the module	×	×	×	×	×	×	×	×
Mounting a new module	×	×	×	×	×	×	×	×
Recognizing the module	×	×	×	×	×	×	○	○
Starting the control of the module	○	○	○	○	○	○	○	○

- Intelligent function modules

○: Executed, ×: Not executed

Step	I/O refresh		Module dedicated instruction	Intelligent auto refresh	Direct access		FROM/TO instructions	Instruction that uses any module access device	Device test	Monitor
	Input (X)	Output (Y)			Input (DX)	Output (DY)				
Checking the target module before replacement	○	○	○	○	○	○	○	○	○	○
Removing the module	×	×	×	×	×	×	×	×	×	×
Mounting a new module	×	×	×	×	×	×	×	×	×	×
Recognizing the module	○	○	×	×	○	○	×	×	○	○
Starting the control of the module	○	○	○	○	○	○	○	○	○	○

Changing a module directly

This section describes how to change a module directly.



The redundant function module cannot be changed online with this method.

Setting parameters in advance

To change a module directly, "Direct change setting" must be set to "Enable" in the parameter in advance.

Navigation window ⇒ [Parameter] ⇒ Module model name ⇒ [CPU Parameter] ⇒ "RAS Setting" ⇒ "Online module change setting" ⇒ "Direct change setting"

■Setting "Direct change setting" to "Enable"

In direct change, an error occurs when a replacement target module is removed. However, setting "Direct change setting" to "Enable" allows the CPU module operation to continue even when "CPU Module Operation Setting at Error Detected" is set to "Stop". The following table lists the related parameter settings and errors.

Item	Setting	Error code	Error name
CPU Parameter ⇒ RAS Setting ⇒ CPU Module Operation Setting at Error Detected	Module Verify Error: "Stop"	2400H	Module verification error
		2401H	Module verification error
	Fuse Blown: "Stop"	2420H	Fuse blown error
System Parameter ⇒ I/O Assignment Setting (each module) ⇒ CPU Module Operation Setting at Error Detection	Moderate: Stop	1200H	Module moderate error
	Critical: Stop	2450H	Module major error
None	None	2440H	Module major error
None	None	2443H	Module major error

If any of the errors above does not stop the CPU module operation and this impacts the system, set "Direct change setting" to "Disable", and change a module by using the special relay and special register.

In a multiple CPU system, when "Direct change setting" is set to "Enable" in any of the CPU modules (including the case where "Direct change setting" is set to "Disable" in other CPU modules), all the CPU modules continue operation when any of the errors above occurs.

In a redundant system, even when the above errors, which can be a system switching cause, occur, the CPU module continues operation. Therefore, the system switching is not performed. In addition, the above errors that are caused by mounting or removing a module online do not stop the CPU module operation regardless of the parameter setting. Even when a module is removed or failed in the control system, the system switching is not performed.

■Precautions for direct change

If direct change is predicted, configure safety circuits external to the programmable controller to ensure that the entire system operates safely, and perform the following.

- Ensure safety of the system by configuring safety circuits, and perform direct change.
- To replace a module that outputs signals to external devices, configure an interlock circuit in the program so that the outputs are turned off interlocking with safety circuits.
- Before performing direct change in an actual system, ensure the applicability and confirm that it does not impact the system.

Before removing a module, shut off the external power supply connected to the module.

Checking the target module before replacement

The following is the procedure for checking the target module before replacement. Stop the control of the replacement target module so that the module can be safely changed online.

■Redundant function module

Check that the redundant function module of the other system is not being changed online.

■I/O modules

1. Stop all the outputs (Y) and inputs (X).
2. If the external power supply is connected to the module, shut off the external power supply with a switch or other means.

■I/O modules with diagnostic functions

1. Stop all the outputs (Y) and inputs (X).
2. Shut off the external power supply with a switch or other means.

■A/D converter module (R60AD4)

1. Set 'CH1 A/D conversion enable/disable setting' (Un\G500) of all the channels to "A/D conversion disable" (1) from an external device (such as a GOT).
2. Turn on and off 'Operating condition setting request' (Y9).
3. Turn off all the Y signals.
4. Check that the A/D conversion is stopped with 'A/D conversion completed flag' (Un\G42).

To change other A/D converter modules online, stop the A/D conversion in the same way. For details on the I/O signals and buffer memory areas of each A/D converter module, refer to the User's Manual (Application) for the A/D converter module used.

■D/A converter module (R60DA4)

1. Set 'CH1 D/A conversion enable/disable setting' (Un\G500) of all the channels to "D/A conversion disable" (1) from an external device (such as a GOT).
2. Turn on and off 'Operating condition setting request' (Y9).
3. Turn off all the Y signals.
4. Shut off the external power supply with a switch or other means.
5. Check that the D/A conversion is stopped and the analog output value is 0V/0mA.

To change other D/A converter modules online, stop the D/A conversion in the same way. For details on the I/O signals and buffer memory areas of each D/A converter module, refer to the User's Manual (Application) for the D/A converter module used.

■Temperature input module (R60TD8-G)

1. Set 'CH1 Conversion enable/disable setting' (Un\G500) of all the channels to "Conversion disable" (1) from an external device (such as a GOT).
2. Turn on and off 'Operating condition setting request' (Y9).
3. Turn off all the Y signals.
4. Check that the temperature conversion is stopped with 'Conversion completed flag' (Un\G42).

To change other temperature input modules online, stop the temperature conversion in the same way. For details on the I/O signals and buffer memory areas of each temperature input module, refer to the User's Manual (Application) for the temperature input module used.

Removing the module

The following is the procedure for removing the module. Remove the replacement target module from the base unit. This procedure is common to all modules.

In direct change, values input from the removed module to the CPU module or the remote head module may become undefined. Remove the module, checking that the system will not malfunction.

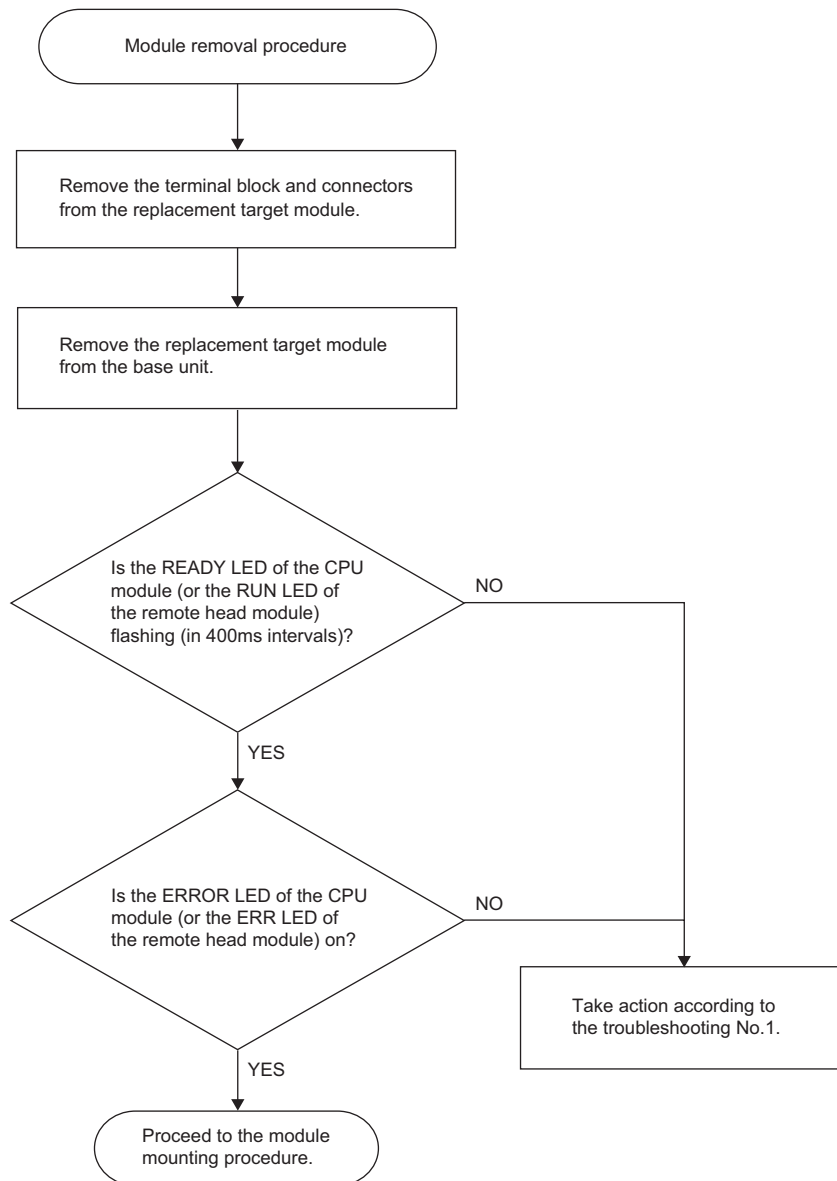

Mounting a new module

The following is the procedure for mounting a new module. Mount a new module on the base unit. This procedure is common to all modules.

In direct change, control starts immediately after a new module is mounted. Connect a terminal block and connectors to the new module. Then, mount the module on the base unit, checking that the system will not malfunction.

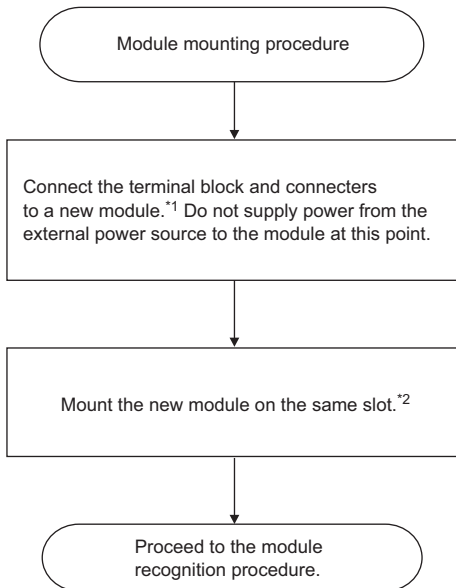

*1 If the target module is a MES interface module, high speed data logger module, C intelligent function module, or OPC UA server module, insert the SD memory card, which was removed when the module was removed, to the new module.

*2 If mounting a module fails, an error may occur in the next step "Recognizing the module". Remove the module and mount it again.

Recognizing the module

The following is the procedure for recognizing the module. The new module is automatically recognized by the system. Check that the module has been recognized correctly. This procedure is common to all modules.

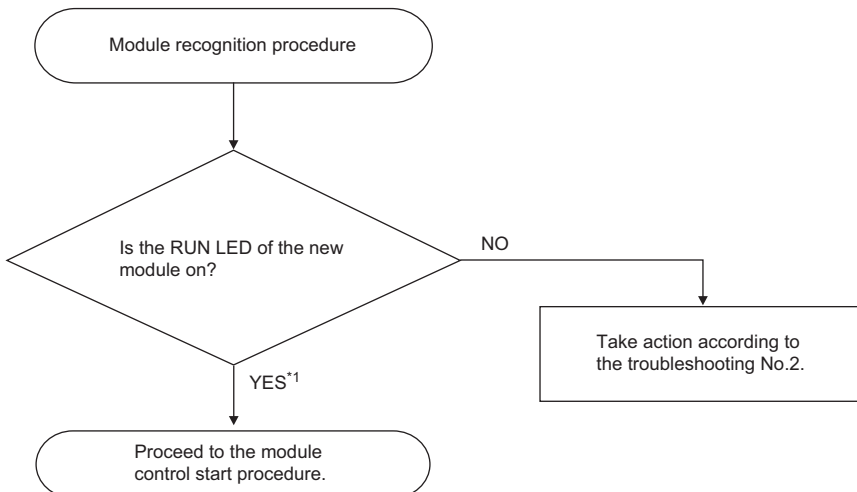

*1 When the initial settings are set in module parameters using the engineering tool, the parameter settings are reflected when the RUN LED turns on.

Starting the control of the module

The following is the procedure for restarting the module control. Complete the online module change and start the control of the new module. Before starting the control of the new module, check the following.

■Check points

- The new module is correctly mounted and the module fixing hook is securely fixed.
- The connectors and terminal blocks are securely connected to the module (no looseness and rattles).
- If the module has no module fixing hook, it is securely fixed with module fixing screws. (The RUN LED of the module turns on while the screws are being tightened.)

■Procedure

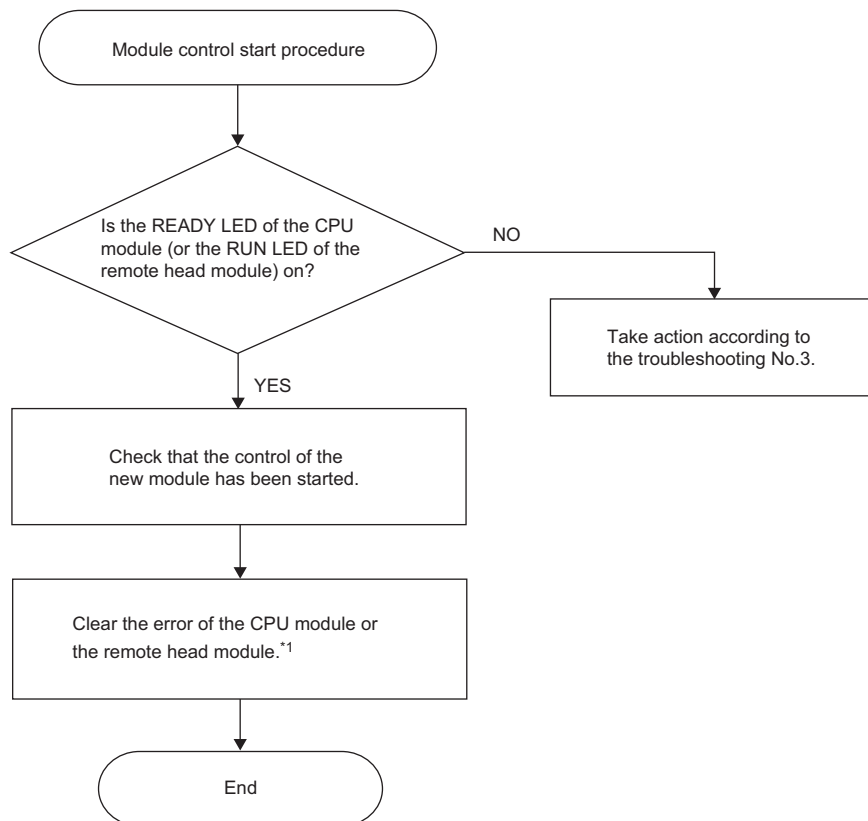

*1 There are two ways to clear errors of the CPU module and the remote head module.

- Using the engineering tool (📖 GX Works3 Operating Manual)
- Using SM/SD (📖 MELSEC iQ-R CPU Module User's Manual (Application), 📖 MELSEC iQ-R CC-Link IE Field Network Remote Head Module User's Manual (Application))

To check the restart of the control, check the following depending on the module.

■I/O modules

1. If the target module is an I/O module that requires an external power supply, connect an external power supply to the module.
2. The online module change has been completed.

■ I/O modules with diagnostic functions

1. Check that 'Module READY' (X1F) is off.

After the module is recognized, 'Module READY' (X1F) turns off. To perform initial settings using a program, design the program so that the initial settings are performed on the falling edge of 'Module READY' (X1F). Do not create a program that performs the initial settings for only one scan after the CPU module has started running. In this case, the initial settings will not be performed.

2. Connect an external power supply to the module.
3. The online module change has been completed.

For details on the I/O signals and buffer memory areas of the I/O modules with diagnostic functions, refer to the following.

📖 MELSEC iQ-R I/O Module (With Diagnostic Functions) User's Manual (Application)

■ A/D converter module (R60AD4), D/A converter module (R60DA4), temperature input module (R60TD8-G), temperature control module (R60TCTRT2TT2), and pulse input module (RD60P8-G)

1. Check that 'Module READY' (X0) is on.

After the module is recognized, 'Module READY' (X0) turns on. To perform initial settings using a program, design the program so that the initial settings are performed on the rising edge of 'Module READY' (X0). Do not create a program that performs the initial settings for only one scan after the CPU module has started running. In this case, the initial settings will not be performed.

2. If the target module is a HART-enabled analog-digital converter module or a D/A converter module, connect an external power supply to the module.
3. The online module change has been completed.

To change other modules online, check the signal in the same way. For details on the I/O signals and buffer memory areas of each module, refer to the User's Manual (Application) for the module used.

7 TROUBLESHOOTING

This chapter describes errors that may occur during system operation, error causes, and actions to be taken. For the troubleshooting specific to each module, refer to the manual for the module used.

Point







Saving the program and devices at the time of an error helps to analyze the error cause.

For reading data from the programmable controller, refer to the following.

 GX Works3 Operating Manual

7.1 Troubleshooting Procedure

When the system has any trouble, perform troubleshooting in the following order.

1. Check the LED status of the power supply module.
( MELSEC iQ-R Module Configuration Manual)
2. Check the LED status of the CPU module. ( Page 210 LED status of the CPU module)
3. Check the LED status of each I/O module and intelligent function module. ( User's Manual (Application) for the module used)
4. Connect an engineering tool, and execute the system monitor function. The error module can be identified. ( Page 211 System monitor)
5. Select the error module, and execute the module diagnostics function. The error cause and the action to be taken can be displayed. ( Page 211 Module diagnostics)
6. If the error cause cannot be identified by the module diagnostics, check the executed operations and detected error logs on the event history window. ( Page 212 Event history)
7. If the error cause cannot be identified in steps 1 to 6, perform troubleshooting by symptom. ( User's Manual (Application) for the module used)

7.2 Troubleshooting with LED Indicators

Check the LED status of each module as primary diagnostics.

LED status of the CPU module

The following table lists the check points on the LED status of the CPU module.

The error status can be checked visually using the READY LED and ERROR LED.

LED indicator		Error status	Program execution status	Description	Action
READY	ERROR				
On	Off	No error	Continued	Normal operation	—
	On	Minor error		A minor error or a warning has been detected. Program execution and data communications with network stations are continued.	Identify the error cause using the engineering tool, and take an action.
	Flashing	Moderate error	Stopped	A programming error, parameter setting error, or temporal noise has been detected. Program execution and data communications with network stations are stopped.	Identify the error cause using the engineering tool, and take an action.
Off	On/ flashing	Major error		A hardware failure has been detected. No operation can be performed.	Perform troubleshooting for the error module. If the problem still exists after troubleshooting, replace the error module. (MELSEC iQ-R CPU Module User's Manual (Application))
		Hardware failure		A hardware failure has been detected. No operation can be performed.	Check that the power is supplied to the system. If the power is supplied properly, the possible cause is a hardware failure. Perform troubleshooting for the error module. If the problem still exists after troubleshooting, replace the error module. (MELSEC iQ-R CPU Module User's Manual (Application))
	No error	Power is not supplied or power went out.		—	
Flashing	On	Minor error		A minor error has been detected during online module change.	Identify the error cause using the engineering tool, and take an action.
	Off	No error		<ul style="list-style-type: none"> The READY LED is flashing in 400ms intervals: A module is being changed online. The READY LED is flashing in 2s intervals: Initial processing is being performed. 	—

Point

The LED status can also be checked on the module diagnostics window using the engineering tool. (GX Works3 Operating Manual)

7.3 Troubleshooting Using the Engineering Tool

Check the error or history using the engineering tool, and identify the error cause. More detailed information on the error as well as the error cause and action to be taken can be checked.

The engineering tool has the following functions for troubleshooting.

Function	Description
System monitor	Displays the module configuration, and detailed information and error status of each module. (Page 211 System monitor)
Module diagnostics	Diagnoses the module. (The current error and its details can be checked.) (Page 211 Module diagnostics)
Event history	Displays the event information collected by the CPU module, such as errors occurred in each module, executed operations, and network errors. (Page 212 Event history)

For details on each function, refer to the following.

GX Works3 Operating Manual

System monitor

This function displays the module configuration, and detailed information and error status of each module. For the error module identified, the module diagnostics function can be executed from this window.

 [Diagnostics] ⇒ [System Monitor]

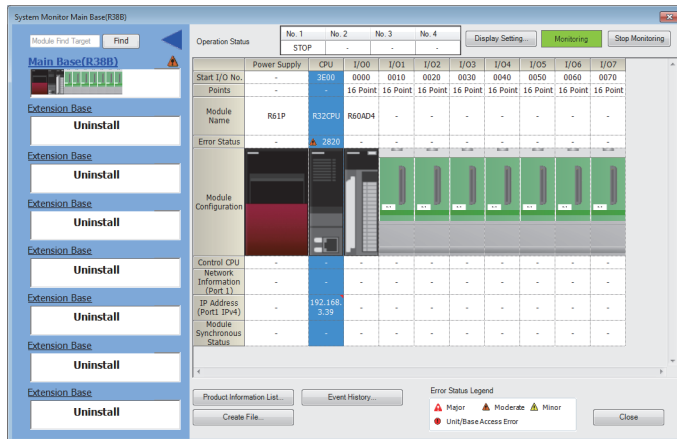

- When the RnENCPU is used, information of the RnENCPU (CPU part) and RnENCPU (network part) is displayed individually. When an error occurs, the module diagnostics function can be executed for each module.
- For a redundant system, both systems A and B are displayed on the Main Base information part. The detailed display of the system A or B can be switched here.

7

Module diagnostics

This function diagnoses the module. (The current error and its details can be checked.)

Information required for troubleshooting, such as the current error, details and cause of the error, and action to be taken, are displayed. The incorrect parameter setting and program error location can also be identified by selecting the error and clicking the [Error Jump] button.

On the [Module Information List] tab, the LED status and the switch status of the target module can be checked.

 [Diagnostics] ⇒ [System Monitor] ⇒ Double-click the error module.

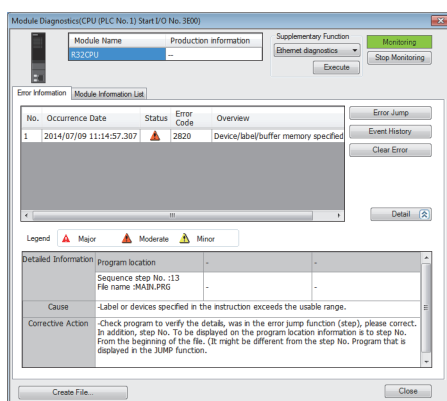

Event history

This function displays the event information, such as errors occurred in the module(s) mounted, executed operations, and network errors.

Since information collected before the CPU module is powered off or reset can also be displayed, the error cause can be identified based on the past operations and errors.

The displayed information can also be saved in CSV file format.

 [Diagnostics] ⇒ [System Monitor] ⇒ [Event History] button

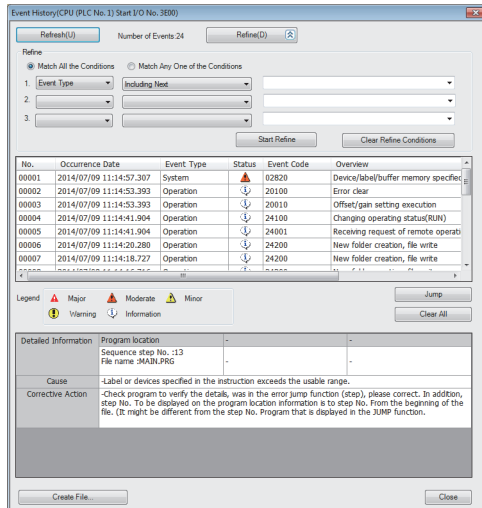

The screenshot shows the 'Event History (CPU)' window for PLC No. 1, Start I/O No. 2690. It features a 'Refresh(U)' button, a 'Number of Events: 24' indicator, and a 'Refine(D)' search box. Below these are 'Refine' options: 'Match All the Conditions' (selected) and 'Match Any One of the Conditions'. Three dropdown menus are provided for refining the search. 'Start Refine' and 'Clear Refine Conditions' buttons are also present.

No.	Occurrence Date	Event Type	Status	Event Code	Overview
00001	2014/07/09 11:14:57.207	System	▲	02620	Device/label/buffer memory specifier
00002	2014/07/09 11:14:53.393	Operation	↓	20100	Error clear
00003	2014/07/09 11:14:53.393	Operation	↓	20010	Offset/gain setting execution
00004	2014/07/09 11:14:41.904	Operation	↓	24100	Changing operating status(RUN)
00005	2014/07/09 11:14:41.904	Operation	↓	24001	Receiving request of remote operati
00006	2014/07/09 11:14:20.280	Operation	↓	24200	New folder creation, file write
00007	2014/07/09 11:14:18.727	Operation	↓	24200	New folder creation, file write

Legend: Major (▲), Moderate (▲), Minor (▲), Warning (⚠), Information (↓). Buttons: Jump, Clear All.

Detailed Information: Program location: -, Sequence step No.: 13, File name: 3MABL.PRG.

Cause: Label or devices specified in the instruction exceeds the usable range.

Corrective Action: Check program to verify the details, was in the error jump function (step), please correct. In addition, step No. To be displayed on the program location information is to step No. From the beginning of the file. (It might be different from the step No. Program that is displayed in the JUMP function.)

Buttons: Create File, Close.



Use this function for the following purposes:

- To check the error status of all the modules in the system and identify the cause of error occurred in machinery or equipment
- To check when and how the program and parameters of the programmable controller have been changed
- To check for unauthorized access

For details on this function and collected information, refer to the following.

 MELSEC iQ-R CPU Module User's Manual (Application)

7.4 Clearing Errors in the CPU Module of the Standby System

Errors in the standby system can be cleared from the CPU module of the control system by using SM1679 (Error reset (the other system)) in a program or external device.

Error clear procedure

Use SM1679 to clear errors.

1. Eliminate the causes of all the continuation errors that have occurred in the standby system.
2. Turn off and on SM1679 of the CPU module of the control system to clear the errors. When multiple continuation errors have occurred, all the errors are cleared at once.

Notes

- The error clear operation with SM1679 can be performed by the CPU module of the control system only. A continuation error in the CPU module of the standby system cannot be cleared by turning off and on SM1679 of the CPU module of the standby system.
- The error clear operation with SM1679 can be performed in backup mode only.
- The cause of an error which has occurred in a module other than the error clear target CPU module cannot be eliminated even though the error clear operation with SM1679 is performed.
- If the error cause has not been eliminated completely after the error clear operation, the same error will be detected again.
- The error clear processing is performed in the END processing. To clear an error, execute the END instruction while SM1679 is on.

APPENDIX

Appendix 1 Functions

This section describes the redundant functions and the functions that are different (modified or restricted) from those of the process mode.

For the availability of the functions in the redundant system, refer to the following.

📖 MELSEC iQ-R CPU Module User's Manual (Startup)

For details on the functions, refer to the following.

📖 MELSEC iQ-R CPU Module User's Manual (Application)

Function		Description
Redundant function	Operation mode change	Switches the operation mode of the redundant system between the backup mode for normal operation and the separate mode for system maintenance while it is running.
	System switching	Switches the systems between the control system and the standby system to continue operation of the redundant system when a failure or an error occurs in the control system. For debugging and maintenance purpose, users can switch the systems at any desired timing.
	Tracking transfer	Transfers the control data from the control system to the standby system and maintains the consistency of the data in the two systems to continue operation of the redundant system when a failure or an error occurs in the control system.
	Memory copy from control system to standby system	Transfers data such as parameters and programs in the CPU module of the control system to the CPU module of the standby system to maintain the consistency of the memory in the two CPU modules.
	System consistency check	Checks whether the system configurations and files in the CPU modules are the same between the control system and the standby system when the redundant system is in backup mode.
	Program execution in both systems	Detects an error in the external device or network of the systems (control system and standby system) by executing a program that diagnoses external devices or networks of both systems.
	Redundant function module communication test	Checks the redundant function module itself for errors when its communications are unstable.

Function		Description	
Function different (modified or restricted) from that of the process mode	Constant scan	<ul style="list-style-type: none"> When the standby system is powered off, a hardware failure has occurred in the standby system, a tracking cable has a failure, or the systems are switched in separate mode, a continuation error may occur due to an excess of the constant scan time. The constant scan is invalid in the standby system when the redundant system is in backup mode. 	
	Interrupt function	When the systems are switched during time measurement of I28 to I31, I48, or I49, the time measurement is interrupted and the new control system starts the time measurement from 0.	
	Clock function	Time synchronization	The time of the standby system is synchronized with the time of the control system when the redundant system is in backup mode. The time setting using the time setting function (SNTP client) is available only for the control system.
		System clock	After system switching, SM420 (User timing clock No.0) to SM424 (User timing clock No.4) remain off in the CPU module of the new control system. To use SM420 to SM424 in the CPU module of the new control system, execute the DUTY instruction again.
	Writing data to the CPU module	Online change (ladder block)	In backup mode, when the online change (ladder block) is executed to the CPU module of one system, the change is also reflected to the CPU module of the other system.
		File batch online change of the FB program file and the global label setting file	Files can be written only when the firmware version of the CPU modules in both systems supports writing of the FB program file and the global label setting file online.
	RAS function	Scan monitoring function	<ul style="list-style-type: none"> During system switching, scan time monitoring with the watchdog timer is interrupted. Thus, no error is detected even if the scan time monitoring time has elapsed. Therefore, a time taken for system switching does not need to be considered in the scan time monitoring time setting. Scan time monitoring with the watchdog timer is interrupted while the standby system is waiting for tracking data to be received. Thus, no error is detected even if the scan time monitoring time has elapsed while the standby system is waiting for tracking data to be received. Therefore, a time taken for tracking data to be received does not need to be considered in the scan time monitoring time setting.
		Self-diagnostic function	The following items related to the redundant system are added to the contents that can be checked with the system monitor. <ul style="list-style-type: none"> Tracking cable status Display of the main base units of systems A and B Module configuration on the base unit of the selected system Event history of own system System to which a CPU module is belonged (control system/standby system, system A/B) and operation mode of the CPU module (backup mode/separate mode)
		Error clear	A continuation error occurred in own system can be cleared by using the special relay (SM50) or the connected engineering tool. Also, errors in the CPU module of the standby system can be cleared by using the special relay (SM1679) in the CPU module of the control system.

Function		Description
Function different (modified or restricted) from that of the process mode	Remote operation	Using a contact When the backup mode setting is enabled in the CPU parameter, both systems may be recognized as being mismatched in the system consistency check even if the remote operation is simultaneously performed on the systems. This is because an operating status mismatch occurs depending on the timing.
		Using the engineering tool In a redundant system, the remote operations differ depending on the operation mode and type.
Boot operation		Use the boot operation only to simultaneously start up both systems. When only one system is restarted and the boot operation is used, an error occurs.
Test function		Changed values of devices and labels are transferred from the control system to the standby system in the END processing. If the systems are switched between the change and the tracking transfer, the changed values are not reflected to the CPU module of the new control system.
Data logging function		In a redundant system, the data logging function collects data only in the control system regardless of the operation mode.
Multiple CPU system function		This function cannot be used in redundant mode.
Security function		The security key setting is written to or deleted from both systems individually, regardless of the operation mode.
Latch function		When the systems are switched, the measurement of the latch interval set in "Interval Setting at Time Setting" in "Device Latch Interval Setting" starts from zero in both the new control system and the new standby system.
Label access setting from external device		In the transfer setup of external devices that communicate with the CPU module through GOT, SLMP, or other methods, select "Control System/Standby System", "System A/System B", or "Not Specified" to start communications with a global label name specified.
Program restoration information write selection		<ul style="list-style-type: none"> Only when the firmware version of the CPU modules in both systems supports the program restoration information write selection, "Not to Write" can be selected. The function cannot be set for online program change.
SFC function		This function cannot be used in redundant mode.
SLMP communications		<ul style="list-style-type: none"> There are notes for system switching when the system IP address matching function is not used. When a remote operation command is executed, an operating status mismatch occurs between the CPU modules and the system switching is disabled. In SLMP communications via the built-in Ethernet port of the CPU module, when communications are performed to the other system that cannot respond (power-off, reset, or tracking cable disconnection), a timeout error may occur. The SLMP frame send instruction (SP.SLMPSND) performs communications using different IP addresses in the system A and the system B.
Ethernet function	File transfer function (FTP client)	• This function performs communications using different IP addresses in the system A and the system B.
Inter-module synchronization function		This function cannot be used in redundant mode.

MEMO

Mitsubishi Programmable Controllers Training Manual

Redundant System Basic Course

MODEL	SCHOOL-R REDUNDANT-E
MODEL CODE	
SH(NA)-082368ENG-A(2009)MEE	

MITSUBISHI ELECTRIC CORPORATION

HEAD OFFICE: TOKYO BLDG., 2-7-3, MARUNOUCHI, CHIYODA-KU, TOKYO 100-8310, JAPAN
NAGOYA WORKS: 1-14, YADA-MINAMI 5-CHOME, HIGASHI-KU, NAGOYA 461-8670, JAPAN

When exported from Japan, this manual does not require application to the Ministry of Economy, Trade and Industry for service transaction permission.

Specifications subject to change without notice.