



General-Purpose AC Servo

MITSUBISHI SERVO AMPLIFIERS & MOTORS  
**MELSERV/o-J4**

# CC-Link IE Field Network Interface Servo Amplifier Instruction Manual (I/O Mode)

---

-MR-J4- \_GF\_  
-MR-J4- \_GF\_-RJ



# SAFETY PRECAUTIONS

---

Please read the instructions carefully before using the equipment.

To use the equipment correctly, do not attempt to install, operate, maintain, or inspect the equipment until you have read through this Instruction Manual, Installation guide, and appended documents carefully. Do not use the equipment until you have a full knowledge of the equipment, safety information and instructions.

In this Instruction Manual, the safety instruction levels are classified into "WARNING" and "CAUTION".



## WARNING

Indicates that incorrect handling may cause hazardous conditions, resulting in death or severe injury.



## CAUTION

Indicates that incorrect handling may cause hazardous conditions, resulting in medium or slight injury.

Note that the CAUTION level may lead to a serious consequence depending on conditions.

Please follow the instructions of both levels because they are important to personnel safety.

What must not be done and what must be done are indicated by the following diagrammatic symbols.



Indicates a forbidden action. For example, "No Fire" is indicated by .



Indicates a required action. For example, grounding is indicated by .

In this Instruction Manual, instructions at a lower level than the above, instructions for other functions, and so on are classified into "POINT".

After reading this Instruction Manual, keep it accessible to the operator.

## [To prevent electric shock, note the following]

---

### **WARNING**

- Before wiring and inspections, turn off the power and wait for 15 minutes or more until the charge lamp turns off. Then, confirm that the voltage between P+ and N- is safe with a voltage tester and others. Otherwise, an electric shock may occur. In addition, when confirming whether the charge lamp is off or not, be sure to look at the lamp from the front of the servo amplifier.
  - Ground the servo amplifier and servo motor securely.
  - Any person who is involved in wiring and inspection should be fully competent to do the work.
  - Do not attempt to wire the servo amplifier and servo motor until they have been installed. Otherwise, it may cause an electric shock.
  - Do not operate switches with wet hands. Otherwise, it may cause an electric shock.
  - The cables should not be damaged, stressed, loaded, or pinched. Otherwise, it may cause an electric shock.
  - During power-on or operation, do not open the front cover of the servo amplifier. Otherwise, it may cause an electric shock.
  - Do not operate the servo amplifier with the front cover removed. High-voltage terminals and charging area are exposed and you may get an electric shock.
  - Except for wiring and periodic inspection, do not remove the front cover of the servo amplifier even if the power is off. The servo amplifier is charged and you may get an electric shock.
  - To prevent an electric shock, always connect the protective earth (PE) terminal (marked ) of the servo amplifier to the protective earth (PE) of the cabinet.
  - To avoid an electric shock, insulate the connections of the power supply terminals.
- 

## [To prevent fire, note the following]

---

### **CAUTION**

- Install the servo amplifier, servo motor, and regenerative resistor on incombustible material. Installing them directly or close to combustibles will lead to smoke or a fire.
  - Always connect a magnetic contactor between the power supply and the main circuit power supply (L1/L2/L3) of the servo amplifier, in order to configure a circuit that shuts down the power supply on the side of the servo amplifier's power supply. If a magnetic contactor is not connected, continuous flow of a large current may cause smoke or a fire when the servo amplifier malfunctions.
  - Always connect a molded-case circuit breaker, or a fuse to each servo amplifier between the power supply and the main circuit power supply (L1/L2/L3) of the servo amplifier, in order to configure a circuit that shuts down the power supply on the side of the servo amplifier's power supply. If a moldedcase circuit breaker or fuse is not connected, continuous flow of a large current may cause smoke or a fire when the servo amplifier malfunctions.
  - When using the regenerative resistor, switch power off with the alarm signal. Otherwise, a regenerative transistor malfunction or the like may overheat the regenerative resistor, causing smoke or a fire.
  - Provide adequate protection to prevent screws and other conductive matter, oil and other combustible matter from entering the servo amplifier and servo motor.
-

[To prevent injury, note the following]

---

 **CAUTION**

---

- Only the power/signal specified in the Instruction Manual should be applied to each terminal. Otherwise, it may cause an electric shock, fire, injury, etc.
  - Connect cables to the correct terminals. Otherwise, a burst, damage, etc., may occur.
  - Ensure that polarity (+/-) is correct. Otherwise, a burst, damage, etc., may occur.
  - The servo amplifier heat sink, regenerative resistor, servo motor, etc., may be hot while the power is on and for some time after power-off. Take safety measures such as providing covers to avoid accidentally touching them by hands and parts such as cables.
- 

[Additional instructions]

The following instructions should also be fully noted. Incorrect handling may cause a malfunction, injury, electric shock, fire, etc.

## [Transportation and installation]

---

### CAUTION

- Transport the products correctly according to their mass.
- Stacking in excess of the specified number of product packages is not allowed.
- Do not hold the front cover, cables, or connectors when carrying the servo amplifier. Otherwise, it may drop.
- Install the servo amplifier and the servo motor in a load-bearing place in accordance with the Instruction Manual.
- Do not get on or put heavy load on the equipment. Otherwise, it may cause injury.
- The equipment must be installed in the specified direction.
- Maintain specified clearances between the servo amplifier and the inner surfaces of a control cabinet or other equipment.
- Do not install or operate the servo amplifier and servo motor which have been damaged or have any parts missing.
- Do not block the intake and exhaust areas of the servo amplifier. Otherwise, it may cause a malfunction.
- Do not drop or apply heavy impact on the servo amplifiers and the servo motors. Otherwise, it may cause injury, malfunction, etc.
- Do not strike the connector. Otherwise, it may cause a connection failure, malfunction, etc.
- When you keep or use the equipment, please fulfill the following environment.

Item		Environment
Ambient temperature	Operation	0 °C to 55 °C (non-freezing)
	Storage	-20 °C to 65 °C (non-freezing)
Ambient humidity	Operation	5 %RH to 90 %RH (non-condensing)
	Storage	
Ambience	Indoors (no direct sunlight); no corrosive gas, inflammable gas, oil mist or dust	
Altitude	2000 m or less above sea level (Contact your local sales office for the altitude for options.)	
Vibration resistance	5.9 m/s <sup>2</sup> , at 10 Hz to 55 Hz (X, Y, Z axes)	

- When the product has been stored for an extended period of time, contact your local sales office.
  - When handling the servo motor, be careful with the sharp edges of the servo motor.
  - The servo amplifier must be installed in a metal cabinet.
  - When fumigants that contain halogen materials, such as fluorine, chlorine, bromine, and iodine, are used for disinfecting and protecting wooden packaging from insects, they cause a malfunction when entering our products. Please take necessary precautions to ensure that remaining materials from fumigant do not enter our products, or treat packaging with methods other than fumigation, such as heat treatment. Additionally, disinfect and protect wood from insects before packing the products.
  - To prevent a fire or injury in case of an earthquake or other natural disasters, securely install, mount, and wire the servo motor in accordance with the Instruction Manual.
-

## [Wiring]

### CAUTION

- Wire the equipment correctly and securely. Otherwise, the servo motor may operate unexpectedly.
- Make sure to connect the cables and connectors by using the fixing screws and the locking mechanism. Otherwise, the cables and connectors may be disconnected during operation.
- Do not install a power capacitor, surge killer, or radio noise filter (optional FR-BIF(-H)) on the servo amplifier output side.
- To avoid a malfunction, connect the wires to the correct phase terminals (U/V/W) of the servo amplifier and servo motor.
- Connect the servo amplifier power output (U/V/W) to the servo motor power input (U/V/W) directly. Do not connect a magnetic contactor and others between them. Otherwise, it may cause a malfunction.

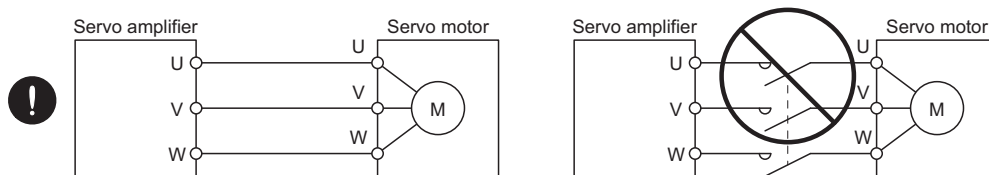

- The connection diagrams in this Instruction Manual are shown for sink interfaces, unless stated otherwise.
- The surge absorbing diode installed to the DC relay for control output should be fitted in the specified direction. Otherwise, the converter unit and the drive unit will malfunction and will not output signals, disabling the emergency stop and other protective circuits.

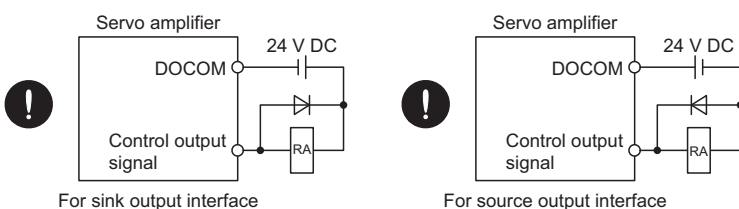

- When the wires are not tightened enough to the terminal block, the wires or terminal block may generate heat because of the poor contact. Be sure to tighten the wires with specified torque.
- Connecting a servo motor of the wrong axis to U, V, W, or CN2 of the servo amplifier may cause a malfunction.
- Configure a circuit to turn off EM2 or EM1 when the main circuit power supply is turned off to prevent an unexpected restart of the servo amplifier.
- To prevent malfunction, avoid bundling power lines (input/output) and signal cables together or running them in parallel to each other. Separate the power lines from the signal cables.

## [Test run and adjustment]

---

### **CAUTION**

---

- When executing a test run, follow the notice and procedures in this instruction manual. Otherwise, it may cause a malfunction, damage to the machine, or injury.
  - Before operation, check and adjust the parameter settings. Improper settings may cause some machines to operate unexpectedly.
  - Never make a drastic adjustment or change to the parameter values as doing so will make the operation unstable.
  - Do not get close to moving parts during the servo-on status.
-



### CAUTION

- Provide an external emergency stop circuit to stop the operation and shut the power off immediately.
  - For equipment in which the moving part of the machine may collide against the load side, install a limit switch or stopper to the end of the moving part. The machine may be damaged due to a collision.
  - Do not disassemble, repair, or modify the product. Otherwise, it may cause an electric shock, fire, injury, etc. Disassembled, repaired, and/or modified products are not covered under warranty.
  - Before resetting an alarm, make sure that the run signal of the servo amplifier is off in order to prevent a sudden restart. Otherwise, it may cause an accident.
  - Use a noise filter, etc., to minimize the influence of electromagnetic interference. Electromagnetic interference may affect the electronic equipment used near the servo amplifier.
  - Do not burn or destroy the servo amplifier. Doing so may generate a toxic gas.
  - Use the servo amplifier with the specified servo motor.
  - Wire options and peripheral equipment, etc. correctly in the specified combination. Otherwise, it may cause an electric shock, fire, injury, etc.
  - The electromagnetic brake on the servo motor is designed to hold the motor shaft and should not be used for ordinary braking.
  - For such reasons as incorrect wiring, service life, and mechanical structure (e.g. where a ball screw and the servo motor are coupled via a timing belt), the electromagnetic brake may not hold the motor shaft. To ensure safety, install a stopper on the machine side.
  - If the dynamic brake is activated at power-off, alarm occurrence, etc., do not drive the servo motor by an external force. Otherwise, it may cause a malfunction of the dynamic break or fire.
-

## [Corrective actions]

---

### CAUTION

- Ensure safety by confirming the power off, etc. before performing corrective actions. Otherwise, it may cause an accident.
- If it is assumed that a power failure, machine stoppage, or product malfunction may result in a hazardous situation, use a servo motor with an electromagnetic brake or provide an external brake system for holding purpose to prevent such hazard.
- Configure an electromagnetic brake circuit which is interlocked with an external emergency stop switch.

Contacts must be opened when ALM (Malfunction) or MBR (Electromagnetic brake interlock) turns off.      Contacts must be opened with the emergency stop switch.

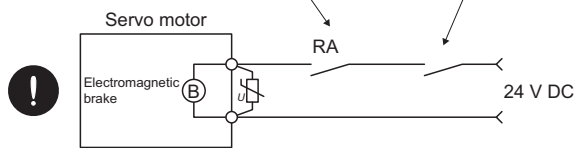

- When an alarm occurs, eliminate its cause, ensure safety, and deactivate the alarm to restart operation.
  - If the molded-case circuit breaker or fuse is activated, be sure to remove the cause and secure safety before switching the power on. If necessary, replace the servo amplifier and recheck the wiring. Otherwise, it may cause smoke, fire, or an electric shock.
  - Provide an adequate protection to prevent unexpected restart after an instantaneous power failure.
  - After an earthquake or other natural disasters, ensure safety by checking the conditions of the installation, mounting, wiring, and equipment before switching the power on to prevent an electric shock, injury, or fire.
- 

## [Maintenance, inspection and parts replacement]

---

### CAUTION

- Make sure that the emergency stop circuit operates properly such that an operation can be stopped immediately and a power is shut off by the emergency stop switch.
  - It is recommended that the servo amplifier be replaced every 10 years when it is used in general environment.
  - When using the servo amplifier that has not been energized for an extended period of time, contact your local sales office.
- 

## [General instruction]

---

- To illustrate details, the equipment in the diagrams of this Instruction Manual may have been drawn without covers and safety guards. When the equipment is operated, the covers and safety guards must be installed as specified. Operation must be performed in accordance with this Instruction Manual.
-

# DISPOSAL OF WASTE

---

Please dispose a servo amplifier, battery (primary battery) and other options according to your local laws and regulations.

# EEP-ROM LIFE

---

The number of write times to the EEPROM, which stores parameter settings, etc., is limited to 100,000. If the total number of the following operations exceeds 100,000, the servo amplifier may malfunction when the EEPROM reaches the end of its useful life.

- Write to the EEPROM due to parameter setting changes
- Write to the EEPROM due to device changes
- Write to the EEPROM due to point table changes

# STO FUNCTION OF THE SERVO AMPLIFIER

---

When using the STO function of the servo amplifier, refer to chapter 13 of "MR-J4-\_GF\_(-RJ) Servo Amplifier Instruction Manual (Motion Mode)".

For the MR-J3-D05 safety logic unit, refer to app. 5 of "MR-J4-\_GF\_(-RJ) Servo Amplifier Instruction Manual (Motion Mode)".

# COMPLIANCE WITH GLOBAL STANDARDS

---

For the compliance with global standards, refer to app. 4 of "MR-J4-\_GF\_(-RJ) Servo Amplifier Instruction Manual (Motion Mode)".

# ABOUT THE MANUAL

You must have this Instruction Manual and the following manuals to use this servo. Ensure to prepare them to use the servo safely.

## Relevant manuals

Manual name	Manual No.
MELSERVO MR-J4-_GF_(-RJ) Servo Amplifier Instruction Manual (Motion Mode)	SH(NA)030218ENG
MELSERVO-J4 Servo Amplifier Instruction Manual (Troubleshooting)	SH(NA)030109ENG
MELSERVO MR-D30 Instruction Manual <sup>*5</sup>	SH(NA)030132ENG
MELSERVO Servo Motor Instruction Manual (Vol. 3) <sup>*1</sup>	SH(NA)030113ENG
MELSERVO Linear Servo Motor Instruction Manual <sup>*2</sup>	SH(NA)030110ENG
MELSERVO Direct Drive Motor Instruction Manual <sup>*3</sup>	SH(NA)030112ENG
MELSERVO Linear Encoder Instruction Manual <sup>*2,4</sup>	SH(NA)030111ENG
EMC Installation Guidelines	IB(NA)67310ENG

- \*1 It is necessary for using a rotary servo motor.
- \*2 It is necessary for using a linear servo motor.
- \*3 It is necessary for using a direct drive motor.
- \*4 It is necessary for using a fully closed loop system.
- \*5 It is necessary for using an MR-D30 functional safety unit.

This Instruction Manual does not describe the following items. For details of the items, refer to each chapter/section of the detailed explanation field. "MR-J4-\_GF\_" means "MELSERVO MR-J4-\_GF\_(-RJ) Servo Amplifier Instruction Manual (Motion Mode)".

Item	Detailed explanation
Installation	MR-J4-_GF_ Chapter 2
Signals and wiring	MR-J4-_GF_ Chapter 3
Normal gain adjustment	MR-J4-_GF_ Chapter 6
Special adjustment functions	MR-J4-_GF_ Chapter 7
Outline drawings	MR-J4-_GF_ Chapter 9
Characteristics	MR-J4-_GF_ Chapter 10
Options and auxiliary equipment	MR-J4-_GF_ Chapter 11
Absolute position detection system	MR-J4-_GF_ Chapter 12
Using STO Function	MR-J4-_GF_ Chapter 13
Using a Linear servo motor	MR-J4-_GF_ Chapter 14
Using a direct drive motor	MR-J4-_GF_ Chapter 15
Fully closed loop system	MR-J4-_GF_ Chapter 16
Application of functions	MR-J4-_GF_ Chapter 17

## U.S. CUSTOMARY UNITS

U.S. customary units are not shown in this manual. Convert the values if necessary according to the following table.

Quantity	SI (metric) unit	U.S. customary unit
Mass	1 [kg]	2.2046 [lb]
Length	1 [mm]	0.03937 [inch]
Torque	1 [N.m]	141.6 [oz.inch]
Moment of inertia	1 [ $(\times 10^{-4} \text{ kg.m}^2)$ ]	5.4675 [oz.inch <sup>2</sup> ]
Load (thrust load/axial load)	1 [N]	0.2248 [lbf]
Temperature	N [ $^{\circ}\text{C}$ ] $\times 9/5 + 32$	N [ $^{\circ}\text{F}$ ]

# CONTENTS

SAFETY PRECAUTIONS	1
DISPOSAL OF WASTE	9
EEP-ROM LIFE	9
STO FUNCTION OF THE SERVO AMPLIFIER	9
COMPLIANCE WITH GLOBAL STANDARDS	9
ABOUT THE MANUAL	10
U.S. CUSTOMARY UNITS	10
<b>CHAPTER 1 FUNCTIONS AND CONFIGURATION</b>	<b>14</b>
1.1 For proper use of the I/O mode	14
1.2 I/O mode specification list	15
1.3 Function list	18
1.4 Configuration including peripheral equipment	21
<b>CHAPTER 2 POINT TABLE OPERATION</b>	<b>22</b>
2.1 Link device	22
Profile	22
Detailed explanation of the RYn/RXn profile	26
Detailed explanation of the RWwn/RWrn profile	30
Code	33
Data communication timing chart	44
Remote register-based position/speed setting	47
2.2 Switching power on for the first time	50
2.3 Automatic operation mode	52
Command method	52
Automatic operation using point table	56
2.4 Manual operation mode	89
JOG operation	89
2.5 Home position return mode	92
Outline of home position return	92
Method -5 (Home position ignorance (Servo-on position as home position))	98
Automatic positioning to home position function	98
2.6 Point table setting method	100
Setting procedure	100
Detailed setting window	102
Single-step feed	103
2.7 Application of the point table function	104
Infinite feed function (setting degree)	104
Roll feed display function	104
Backlash compensation	106
2.8 Programming example by function	109
System configuration example	109
Reading the servo amplifier status	112
Writing an operation command	113
Reading data	115
Writing data	117
Operation	120
2.9 Program example for continuous operation	122

<b>CHAPTER 3</b>	<b>PARAMETERS</b>	<b>125</b>
<b>3.1</b>	<b>Parameter list</b> . . . . .	<b>125</b>
	Basic setting parameters ([Pr. PA_ _]) . . . . .	126
	Gain/filter setting parameters ([Pr. PB_ _]) . . . . .	127
	Extension setting parameters ([Pr. PC_ _]) . . . . .	129
	I/O setting parameters ([Pr. PD_ _]) . . . . .	131
	Extension setting 2 parameters ([Pr. PE_ _]) . . . . .	132
	Extension setting 3 parameters ([Pr. PF_ _]) . . . . .	134
	Linear servo motor/DD motor setting parameters ([Pr. PL_ _]) . . . . .	135
	Positioning control parameters ([Pr. PT_ _]) . . . . .	137
	Network setting parameters ([Pr. PN_ _]) . . . . .	140
<b>3.2</b>	<b>Detailed list of parameters</b> . . . . .	<b>141</b>
	Basic setting parameters ([Pr. PA_ _]) . . . . .	141
	Extension setting parameters ([Pr. PC_ _]) . . . . .	142
	I/O setting parameters ([Pr. PD_ _]) . . . . .	143
	Positioning control parameters ([Pr. PT_ _]) . . . . .	145
	Network setting parameters ([Pr. PN_ _]) . . . . .	156
<b>3.3</b>	<b>How to set the electronic gear</b> . . . . .	<b>158</b>
	Electronic gear settings in the point table method . . . . .	158
	Electronic gear setting in the indexer method . . . . .	159
<b>3.4</b>	<b>Stop method at stroke limit detection</b> . . . . .	<b>161</b>
<b>3.5</b>	<b>Stop method at software limit detection</b> . . . . .	<b>163</b>
<b>CHAPTER 4</b>	<b>TROUBLESHOOTING</b>	<b>164</b>
<b>4.1</b>	<b>Explanation for the lists</b> . . . . .	<b>164</b>
<b>4.2</b>	<b>Alarm list</b> . . . . .	<b>165</b>
<b>4.3</b>	<b>Warning list</b> . . . . .	<b>173</b>
<b>4.4</b>	<b>Troubleshooting at power on</b> . . . . .	<b>175</b>
<b>CHAPTER 5</b>	<b>INDEXER OPERATION</b>	<b>176</b>
<b>5.1</b>	<b>Link device</b> . . . . .	<b>176</b>
	Profile . . . . .	176
	Detailed explanation of the RYn/RXn profile . . . . .	180
	Detailed explanation of the RWwn/RWrn profile . . . . .	183
	Code . . . . .	185
	Data communication timing chart . . . . .	192
	Remote register-based position/speed setting . . . . .	193
<b>5.2</b>	<b>Switching power on for the first time</b> . . . . .	<b>195</b>
<b>5.3</b>	<b>Automatic operation mode</b> . . . . .	<b>197</b>
	Automatic operation mode . . . . .	197
	Rotation direction specifying indexer . . . . .	198
	Shortest rotating indexer operation . . . . .	208
<b>5.4</b>	<b>Manual operation mode</b> . . . . .	<b>217</b>
	Station JOG operation . . . . .	217
	JOG operation . . . . .	219
<b>5.5</b>	<b>Home position return mode</b> . . . . .	<b>220</b>
	Outline of home position return . . . . .	220
	Torque limit changing dog type home position return (front end detection, Z-phase reference) . . . . .	221
	Torque limit changing dog type home position return (rear end detection, Z-phase reference) . . . . .	224
	Torque limit changing data set type . . . . .	227

Homing method 35, 37 (Homing on current position) .....	229
<b>5.6 Application of indexer function .....</b>	<b>230</b>
Backlash compensation .....	230
<b>CHAPTER 6 SPEED CONTROL OPERATION .....</b>	<b>232</b>
<b>6.1 Link device .....</b>	<b>232</b>
Profile .....	232
Detailed explanation of the RYn/RXn profile .....	236
Detailed explanation of the RWwn/RWrn profile .....	238
Code .....	240
Data communication timing chart .....	246
<b>6.2 Switching power on for the first time .....</b>	<b>247</b>
<b>6.3 Speed control mode (point table method) .....</b>	<b>249</b>
Operating method which does not use the speed command execution demand .....	250
Operating method which uses the speed command execution demand .....	252
<b>CHAPTER 7 APPLICATION OF FUNCTIONS .....</b>	<b>256</b>
<b>7.1 Simple cam function .....</b>	<b>256</b>
Outline of simple cam function .....	256
Simple cam function block .....	257
Simple cam specification list .....	258
Control of simple cam function .....	259
Operation in combination with the simple cam .....	260
Setting list .....	261
Data to be used with simple cam function .....	262
Function block diagram for displaying state of simple cam control .....	274
Operation .....	275
Cam No. setting method .....	280
Stop operation of cam control .....	281
Restart operation of cam control .....	282
Cam axis position at cam control switching .....	283
Clutch .....	290
Cam position compensation target position .....	291
Cam position compensation time constant .....	292
Backup restore function .....	292
<b>7.2 Override .....</b>	<b>293</b>
Analog override .....	293
Digital override .....	294
<b>7.3 Internal torque limit selection .....</b>	<b>296</b>
Device/parameter .....	296
Details of internal torque limit selection .....	296
REVISIONS .....	299
WARRANTY .....	301
TRADEMARKS .....	302

# 1 FUNCTIONS AND CONFIGURATION

The items shown in the following table are the same as those for the motion mode. For details, refer to each section indicated in the detailed explanation field. "MR-J4-\_GF\_" means "MR-J4-\_GF\_(-RJ) Servo Amplifier Instruction Manual (Motion Mode)".

Item	Detailed explanation
Function block diagram	MR-J4-_GF_ section 1.2
Combinations of servo amplifiers and servo motors	MR-J4-_GF_ section 1.4
Model designation	MR-J4-_GF_ section 1.6
Structure (parts identification)	MR-J4-_GF_ section 1.7
Configuration including peripheral equipment	MR-J4-_GF_ section 1.8

## 1.1 For proper use of the I/O mode

### Servo amplifier/MR Configurator2

The I/O mode is available with the servo amplifier and MR Configurator2 with the following software versions.

Product name	Model	Software version	
		Point table method	Indexer method
Servo amplifier	MR-J4-_GF_(-RJ)	A1 or later	A3 or later
MR Configurator2	SW1DNC-MRC2_	1.52E or later	1.60N or later

### Parameter setting

#### ■ Selection of station-specific mode

Set [Pr. PN03 Station-specific mode setting] to "1" to select the I/O mode as the station-specific mode.

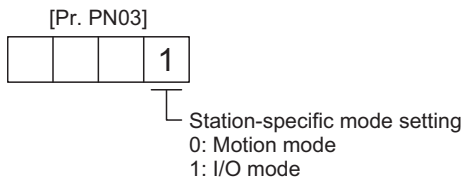

#### ■ Selection of control mode

Select a control mode with [Pr. PA01 Operation mode] to use.

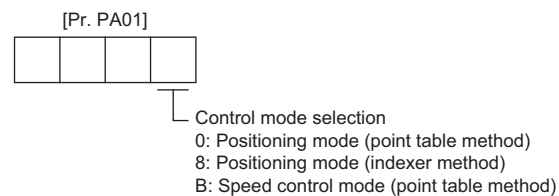



# 1.2 I/O mode specification list

Only the specifications of the I/O mode are listed here. For other specifications, refer to section 1.3 of "MR-J4-\_GF\_(-RJ) Servo Amplifier Instruction Manual (Motion Mode)".

Item		Description		
Servo amplifier model		MR-J4-_GF_(-RJ)		
Command method	Point table	Operational specifications		Positioning with specification of point table No. (255 points)
		Position command input *1	Absolute value command method	Set in the point table. Setting range of feed length per point: -999999 to 999999 [ $\times 10^{\text{STM}}$ $\mu\text{m}$ ], -99.9999 to 99.9999 [ $\times 10^{\text{STM}}$ inch], -999999 to 999999 [pulse] Rotation angle setting range: -360.000 to 360.000 [degree] *4
			Incremental value command method	Set in the point table. Setting range of feed length per point: 0 to 999999 [ $\times 10^{\text{STM}}$ $\mu\text{m}$ ], 0 to 99.9999 [ $\times 10^{\text{STM}}$ inch], 0 to 999999 [pulse] Rotation angle setting range: 0 to 999.999 [degree] *4
		Speed command input		Set the acceleration/deceleration time constants in the point table. Set the S-pattern acceleration/deceleration time constants with [Pr. PT51].
		System		Signed absolute value command method/incremental value command method
		Torque limit		Set with a parameter or link device.
		Position command data input	Operational specifications	
	Position command input *1		Absolute value command method	Set the position command data with a remote register. Setting range of feed length: -999999 to 999999 [ $\times 10^{\text{STM}}$ $\mu\text{m}$ ], -99.9999 to 99.9999 [ $\times 10^{\text{STM}}$ inch], -999999 to 999999 [pulse] Rotation angle setting range: -360.000 to 360.000 [degree] *4
			Incremental value command method *4	Set the position command data with a remote register. Setting range of feed length: 0 to 999999 [ $\times 10^{\text{STM}}$ $\mu\text{m}$ ], 0 to 99.9999 [ $\times 10^{\text{STM}}$ inch], 0 to 999999 [pulse] Rotation angle setting range: 0 to 999.999 [degree]
	Speed command input		Select from point tables with a remote register. Set the speed command data (speed) with a remote register. Set the S-pattern acceleration/deceleration time constants with [Pr. PT51].	
	System		Signed absolute position command method, incremental value command method	
	Indexer*2		Operational specifications	
		Speed command input		Select from point tables with a remote register. Set speed command data (rotation speed and acceleration/deceleration time constants) by the remote register.
		System		Rotation direction specifying indexer/shortest rotating indexer
Torque limit		Set with a parameter or link device.		
Operation mode	Automatic operation mode	Point table	Each positioning operation	Point table No. input method/position data input method Operates each positioning based on position command and speed command.
			Automatic continuous positioning operation	Varying-speed operation (2 to 255 speeds)/automatic continuous positioning operation (2 to 255 points)/ Automatic continuous operation to a point table selected at startup/automatic continuous operation to the point table No. 1
		Indexer	Rotation direction specifying indexer	Positions to the specified station. Rotation direction settable
			Shortest rotating indexer	Positions to the specified station. Rotates in the shorter direction from the current position.
	Manual operation mode	Point table	JOG operation	In accordance with the speed data set in parameters, JOG operation is performed by using CC-Link IE Field Network communication.
		Indexer	JOG operation	Decelerates to a stop regardless of the station.
Station JOG operation	Rotates in a direction specified by the rotation direction decision when the start signal turns on. Positions to the nearest station where the servo motor can decelerate to a stop when the start signal turns off.			

Item		Description
Home position return mode	Point table	Dog type (rear end detection, Z-phase reference)
		Stopper type (stopper position reference)
		Count type (front end detection, Z-phase reference)
		Dog type (rear end detection, rear end reference)
		Count type (front end detection, front end reference)
		Dog cradle type
		Dog type last Z-phase reference
		Dog type front end reference
		Dogless Z-phase reference
		Home position ignorance (servo-on position as home position)
		Homing on positive home switch and index pulse (method 3)
		Homing on positive home switch and index pulse (method 4)
		Homing on negative home switch and index pulse (method 5)
		Homing on negative home switch and index pulse (method 6)
		Homing on home switch and index pulse (method 7)
		Homing on home switch and index pulse (method 8)
		Homing on home switch and index pulse (method 11)
		Homing on home switch and index pulse (method 12)
		Homing without index pulse (method 19)
		Homing without index pulse (method 20)
		Homing without index pulse (method 21)
		Homing without index pulse (method 22)
		Homing without index pulse (method 23)
		Homing without index pulse (method 24)
		Homing without index pulse (method 27)
		Homing without index pulse (method 28)
		Homing on index pulse (method 33)
Homing on index pulse (method 34)		
Homing on current position (method 35)		
Homing on current position (method 37)		
Indexer <sup>*2</sup>	Torque limit changing dog type (front end detection, Z-phase reference) <sup>*3</sup>	
	Torque limit changing dog type (rear end detection, Z-phase reference) <sup>*3</sup>	
	Torque limit switching data set type	
	Homing on current position (method 35)	
	Homing on current position (method 37)	
Automatic positioning to home position function		High-speed automatic positioning to a defined home position
Other functions		Absolute position detection/external limit switch/software stroke limit/analog override/digital override/backlash compensation

- \*1 STM is the ratio to the setting value of the position data. STM can be changed with [Pr. PT03 Feeding function selection].
- \*2 The indexer method is available with servo amplifiers with software version A3 or later. When using the indexer method, use MR Configurator2 with software version 1.60N or later.
- \*3 Front end detection or rear end detection of the proximity dog can be selected with "torque limit changing dog type home position return" in [Pr. PT70].
- \*4 This is available with servo amplifiers with software version A6 or later.

# 1.3 Function list



The symbol in the control mode column means as follows:

- CP: Positioning mode (point table method)
- PS: Positioning mode (indexer method)
- SP: Speed control mode (point table method)

The following table lists the functions of this servo. For details of the functions, refer to each section indicated in the detailed explanation field. "MR-J4-\_GF\_" means "MR-J4-\_GF\_(-RJ) Servo Amplifier Instruction Manual (Motion Mode)".

Function	Description	Control mode			Detailed explanation
		CP	PS	SP	
Model adaptive control	This function achieves a high response and stable control following the ideal model. The two-degrees-of-freedom model adaptive control enables you to set a response to the command and response to the disturbance separately. Additionally, this function can be disabled. To disable this function, refer to section 7.5 of "MR-J4-_GF_(-RJ) Servo Amplifier Instruction Manual (Motion Mode)".	○	○	○	—
Positioning mode (point table method)	Set 255 point tables in advance, then select any point table to perform operation in accordance with the set values. The position command and speed command can also be set with the remote register.	○	—	—	☞ Page 22 POINT TABLE OPERATION
Positioning mode (indexer method)	Set 2 to 255 divided stations in advance to perform operation to the station positions. The position command and speed command can also be set with the remote register. This is available with servo amplifiers with software version A3 or later.	—	○	—	☞ Page 176 INDEXER OPERATION
Speed control mode (point table method)	Set 255 point tables in advance, then select any point table to perform operation in accordance with the set speed, acceleration time constant, and deceleration time constant. The speed command can also be set with the remote register. This is available with servo amplifiers with software version A6 or later.	—	—	○	—
Roll feed display function	Positions based on specified travel distance from a status display "0" of current/command positions at start. This is available with servo amplifiers with software version A7 or later.	○	—	—	—
Home position return	For the home position return types, refer to the following. ☞ Page 92 Home position return mode ☞ Page 220 Home position return mode	○	○	—	☞ Page 92 Home position return mode ☞ Page 220 Home position return mode
High-resolution encoder	Rotary servo motors compatible with the MELSERVO-J4 series are equipped with a high-resolution encoder of 4194304 pulses/rev.	○	○	○	—
Absolute position detection system	Home position return is required only once, and not required at every power-on.	○	○	—	MR-J4-_GF_ chapter 12
Gain switching function	You can switch gains during rotation/stop, and can use input devices to switch gains during operation.	○	○	○	MR-J4-_GF_ section 7.2
Advanced vibration suppression control II	This function suppresses vibration at an arm end or residual vibration.	○	○	—	MR-J4-_GF_ section 7.1
Machine resonance suppression filter	This filter function (notch filter) decreases the gain of the specific frequency to suppress the resonance of the mechanical system.	○	○	○	MR-J4-_GF_ section 7.1
Shaft resonance suppression filter	When a load is mounted to the servo motor shaft, resonance by shaft torsion during driving may generate a mechanical vibration at high frequency. The shaft resonance suppression filter suppresses the vibration.	○	○	○	MR-J4-_GF_ section 7.1
Adaptive filter II	The servo amplifier detects mechanical resonance and sets filter characteristics automatically to suppress mechanical vibration.	○	○	○	MR-J4-_GF_ section 7.1
Low-pass filter	Suppresses high-frequency resonance which occurs as the servo system response is increased.	○	○	○	MR-J4-_GF_ section 7.1
Machine analyzer function	Analyzes the frequency characteristic of the mechanical system by simply connecting an MR Configurator2 installed personal computer and the servo amplifier. MR Configurator2 is necessary for this function.	○	○	○	—

Function	Description	Control mode			Detailed explanation
		CP	PS	SP	
Robust filter	For roll feed axis, etc. of which a response level cannot be increased because of the large load to motor inertia ratio, this function improves a disturbance response.	○	○	○	[Pr. PE41]
Slight vibration suppression control	Suppresses vibration of ±1 pulse generated at a servo motor stop.	○	○	—	[Pr. PB24]
Electronic gear	Position commands can be multiplied by 1/864 to 271470.	○	—	—	[Pr. PA06]
	Position commands can be multiplied by 1/9999 to 9999.	—	○	—	[Pr. PA07]
Auto tuning	Automatically adjusts the gain to optimum value if load applied to the servo motor shaft varies.	○	○	○	MR-J4-_GF_ section 6.3
Brake unit	Used when the regenerative option cannot provide enough regenerative power. Can be used for the 5 kW or more servo amplifier.	○	○	○	MR-J4-_GF_ section 11.3
Power regeneration converter	Used when the regenerative option cannot provide enough regenerative power. Can be used for the 5 kW or more servo amplifier.	○	○	○	MR-J4-_GF_ section 11.4
Regenerative option	Use a regenerative option when the built-in regenerative resistor of the servo amplifier does not have sufficient regenerative capacity for a large regenerative power generated.	○	○	○	MR-J4-_GF_ section 11.2
Alarm history clear	Alarm history is cleared.	○	○	○	[Pr. PC21]
Input signal selection (device settings)	The input devices including PC (Proportional control (PID control)) can be assigned to certain pins of the CN3 connector.	○	○	○	[Pr. PD03] to [Pr. PD05]
Output signal selection (device settings)	The output devices including MBR (electromagnetic brake interlock) can be assigned to certain pins of the CN3 connector.	○	○	○	[Pr. PD07] to [Pr. PD09]
Output signal (DO) forced output	Turns on/off the output signals forcibly independently of the servo status. Use this function for checking output signal wiring, etc.	○	○	○	MR-J4-_GF_ section 4.5
Torque limit	Limits the servo motor torque.	○	○	○	[Pr. PA11] [Pr. PA12]
Test operation mode	Jog operation/positioning operation/motor-less operation/DO forced output/program operation/single-step feed Note that MR Configurator2 is necessary for positioning operation, program operation, and single-step feed.	○	○	○	 Page 103 Single-step feed MR-J4-_GF_ section 4.5
Analog monitor output	Outputs servo status with voltage in real time.	○	○	○	[Pr. PC09] [Pr. PC10]
MR Configurator2	Using a personal computer, you can perform the parameter setting, test operation, monitoring, and others.	○	○	○	MR-J4-_GF_ section 11.7
Linear servo system	Linear servo systems can be configured using a linear servo motor and linear encoder.	○	—	○	MR-J4-_GF_ chapter 14
Direct drive servo system	Direct drive servo system can be configured to drive a direct drive motor.	○	○	○	MR-J4-_GF_ chapter 15
Fully closed loop system	Fully closed loop system can be configured using the load-side encoder.	○	—	—	MR-J4-_GF_ chapter 16
One-touch tuning	Adjusts gains just by pressing buttons on the servo amplifier or by clicking a button on MR Configurator2. In I/O mode, one-touch tuning via network is not possible.	○	○	○	MR-J4-_GF_ section 6.2
SEMI-F47 function	This servo amplifier complies with the SEMI-F47 standard. Thus, even when an instantaneous power failure occurs during operation, the electrical energy charged in the capacitor is used and [AL. 10 Undervoltage] is not triggered.	○	○	○	MR-J4-_GF_ section 7.4 [Pr. PA20] [Pr. PF25]
Tough drive function	This function makes the equipment continue operating even under the condition that an alarm occurs. The tough drive function includes two types: the vibration tough drive and the instantaneous power failure tough drive.	○	○	○	MR-J4-_GF_ section 7.3
Drive recorder function	This function continuously monitors the servo status and records the status transition before and after an alarm for a fixed period of time. You can check the recorded data on the drive recorder window on MR Configurator2 by clicking the "Graph" button. However, the drive recorder is not available when: <ul style="list-style-type: none"> <li>• The graph function of MR Configurator2 is being used.</li> <li>• The machine analyzer function is being used.</li> <li>• [Pr. PF21] is set to "-1".</li> <li>• The controller is not connected (except the test operation mode).</li> <li>• An alarm related to the controller is occurring.</li> </ul>	○	○	○	[Pr. PA23]

Function	Description	Control mode			Detailed explanation
		CP	PS	SP	
STO function	This amplifier complies with the STO function as functional safety of IEC/EN 61800-5-2. You can create a safety system for the equipment easily.	○	○	○	MR-J4-_GF_ chapter 13
Servo amplifier life diagnosis function	You can check the cumulative energization time and the number of on/off times of the inrush relay. This function gives an indication of the replacement time for parts of the servo amplifier including a capacitor and a relay before they malfunction. MR Configurator2 is necessary for this function.	○	○	○	—
Power monitoring function	This function calculates the power running energy and the regenerative power from the data in the servo amplifier such as speed and current. Power consumption and others are displayed on MR Configurator2.	○	○	○	—
Machine diagnosis function	From the data in the servo amplifier, this function estimates the friction and vibrational component of the drive system in the equipment and recognizes an error in the machine parts, including a ball screw and bearing. MR Configurator2 is necessary for this function.	○	○	○	MR-J4-_GF_ section 17.5
Limit switch	External limit switches can be used to limit travel intervals of the servo motor.	○	○	○	—
S-pattern acceleration/ deceleration	Enables smooth acceleration and deceleration. Set S-pattern acceleration/deceleration time constants with [Pr. PT51]. As compared with linear acceleration/deceleration, the acceleration/ deceleration time will be longer for the S-pattern acceleration/deceleration time constants regardless of command speed.	○	—	○	[Pr. PT51]
Software limit	Limits travel intervals by address using parameters. Enables the same function with the limit switch by setting parameters.	○	—	—	MR-J4-_GF_ section 5.3
Analog override	Changes the servo motor speed using link devices. The speed can be changed by 0 to 200 % in relation to the set speed. This is available with servo amplifiers with software version A6 or later.	○	○	—	—
Digital override	The actual servo motor speed can be obtained by multiplying the command speed and an override value selected in RY (n + 1) C (Digital override selection 1) to RY (n + 1) F (Digital override selection 4). The speed can be changed by 0 to 360 % in relation to the set speed. This is available with servo amplifiers with software version A6 or later.	○	○	—	—
Speed limit	The servo motor speed can be limited.	—	—	—	—
Lost motion compensation function	This function improves the response delay generated when the machine moving direction is reversed.	○	○	—	MR-J4-_GF_ section 7.6
Super trace control	This function sets constant and uniform acceleration/deceleration droop pulses to almost 0.	○	○	—	MR-J4-_GF_ section 7.7
SLMP	SLMP (SeamLess Message Protocol) is a protocol to access SLMP-compatible devices from external devices (such as a personal computer and an HMI) or CPU module via Ethernet. The parameters of servo amplifiers can be set (read or written) and monitored.	○	○	○	—
Functional safety unit	MR-D30 can be used to expand the safety observation function. This is available with servo amplifiers with software version A3 or later.	○	○	○	—
Simple cam function	This function enables synchronous control by using software instead of controlling mechanically with cam. Synchronous operation can be performed using the encoder following function, the cam position compensation function, and the positioning data. This is available with servo amplifiers with software version A3 or later.	○	—	—	📖 Page 256 APPLICATION OF FUNCTIONS
Infinite feed function (setting degree)	If the position data unit for the automatic or manual operation in the point table method is set to degree, the detection of [AL. E3.1 Multi-revolution counter travel distance excess warning] will be disabled even if the servo motor is rotated 32768 rev or more in one direction, making the home position remain. Therefore, the current position will be restored after the power is cycled. This function is supported by the absolute position detection system. This is available with servo amplifiers with software version A6 or later.	○	○	—	—

# 1.4 Configuration including peripheral equipment

## ⚠ CAUTION

- Connecting a servo motor of the wrong axis to U, V, W, or CN2 of the servo amplifier may cause a malfunction.
- The CN1A and CN1B connectors are dedicated for CC-Link IE Field Network. Do not connect a network other than CC-Link IE Field Network. Otherwise, a malfunction may occur.

### Point

Equipment other than the servo amplifier and servo motor are optional or recommended products.

The following illustration is an example of MR-J4-20GF-RJ.

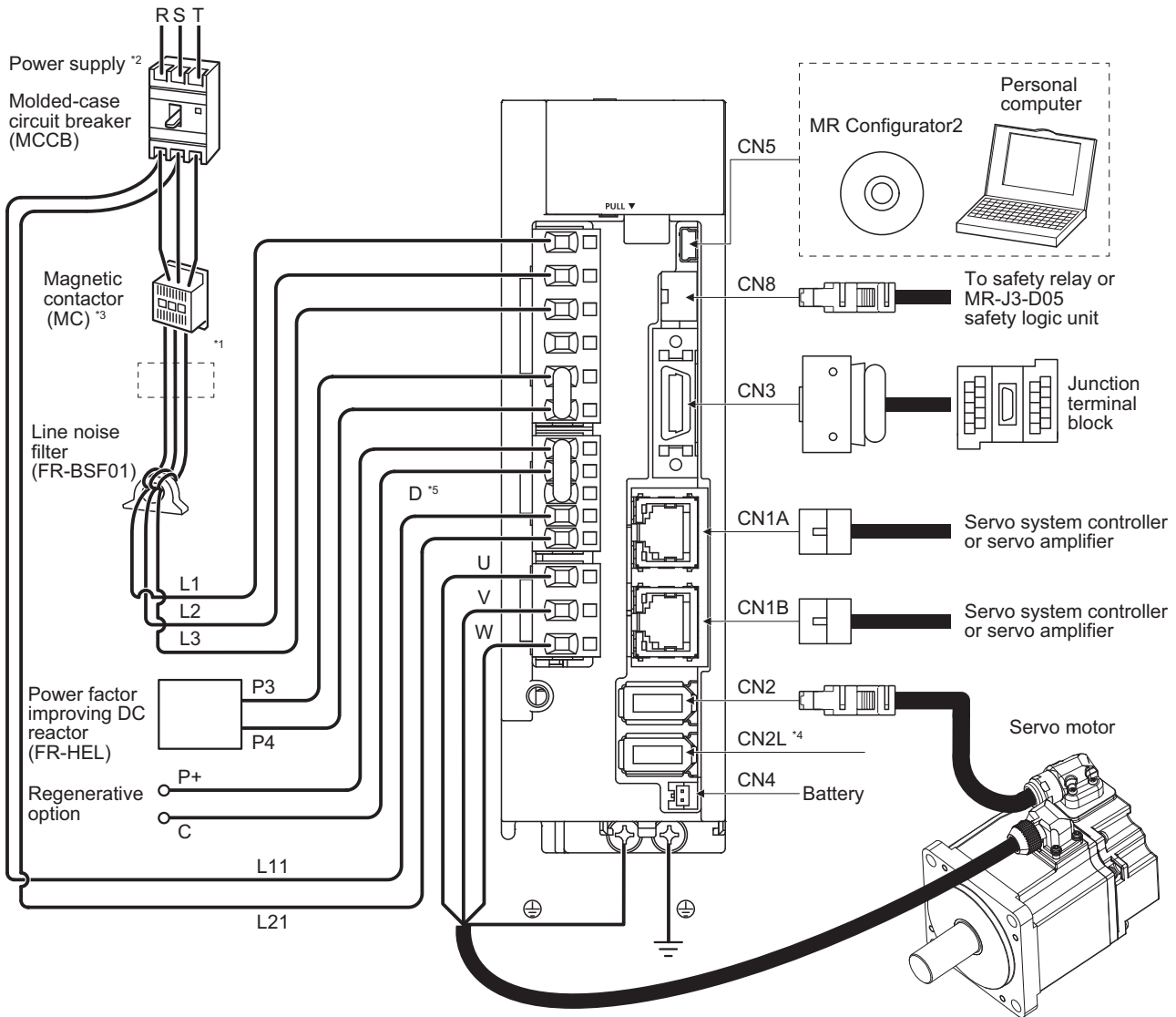

- \*1 The power factor improving AC reactor can also be used. In this case, the power factor improving DC reactor cannot be used. When not using the power factor improving DC reactor, short P3 and P4.
- \*2 For 1-phase 200 V AC to 240 V AC, connect the power supply to L1 and L3. Leave L2 open. Refer to section 1.3 of "MR-J4-GF-(RJ) Servo Amplifier Instruction Manual (Motion Mode)" for the power supply specifications.
- \*3 Depending on the main circuit voltage and operation pattern, bus voltage decreases, and that may cause the forced stop deceleration to shift to the dynamic brake deceleration. When dynamic brake deceleration is not required, slow the time to turn off the magnetic contactor.
- \*4 This is for MR-J4-GF-RJ servo amplifier. MR-J4-GF- servo amplifier does not have CN2L connector. When using MR-J4-GF-RJ servo amplifier in the linear servo system or in the fully closed loop system, connect an external encoder to this connector. Refer to section 1.1 of "MR-J4-GF-(RJ) Servo Amplifier Instruction Manual (Motion Mode)" and "Linear Encoder Instruction Manual" for the connectable external encoders.
- \*5 Always connect between P+ and D terminals. When using a regenerative option, refer to section 11.2 of "MR-J4-GF-(RJ) Servo Amplifier Instruction Manual (Motion Mode)".

# 2 POINT TABLE OPERATION

The items shown in the following table are the same as those for the motion mode. For details, refer to each section indicated in the detailed explanation field. "MR-J4-\_GF\_" means "MR-J4-\_GF\_(-RJ) Servo Amplifier Instruction Manual (Motion Mode)".

Item	Detailed explanation
Startup	MR-J4-_GF_ section 4.2
Switch setting and display of the servo amplifier	MR-J4-_GF_ section 4.3
Test operation	MR-J4-_GF_ section 4.4
Test operation mode	MR-J4-_GF_ section 4.5

## Point

When you use a linear servo motor, replace the following left words to the right words.

- Load to motor inertia ratio → Load to motor mass ratio
- Torque → Thrust

## 2.1 Link device

### Profile

Some input devices can be assigned to the CN3 pin using [Pr. PD03] to [Pr. PD05]. When using the CC-Link IE Field Network communication and CN3 connector's input signal, assigned devices other than upper stroke limit, lower stroke limit and proximity dog can be used simultaneously.

Some output devices can be assigned to the CN3 pin with [Pr. PD07] to [Pr. PD09]. The assigned devices can be used together when using the CC-Link IE Field Network communication and CN3 connector's output signal.

When turning off input/output signals, turn off both CC-Link IE Field Network communication and external I/O signals of the CN3 connector. The following shows the profile of link devices communicated with the master station in cyclic transmission.



## RYn profile

Master station → Servo amplifier (RYn)			
Device No. *1	Device	Symbol	CN3 connector pin No.
RYn0	Servo-on	SON	—
RYn1	Forward rotation start	ST1	—
RYn2	Reverse rotation start	ST2	—
RYn3	Proximity dog	DOG	19
RYn4	Not used	—	—
RYn5			
RYn6	Automatic/manual selection	MD0	—
RYn7	Temporary stop/restart	TSTP	—
RYn8	Monitor output execution demand	MOR	—
RYn9	Instruction code execution demand	COR	—
RYnA to RYnE	Not used	—	—
RYnF	Clear *3	CR	—
RY (n + 1) 0	Upper stroke limit	FLS	—
RY (n + 1) 1	Lower stroke limit	RLS	—
RY (n + 1) 2	Operation alarm reset	ORST	—
RY (n + 1) 3	Cam control command	CAMC	—
RY (n + 1) 4	Not used	—	—
RY (n + 1) 5	Clutch command	CLTC	—
RY (n + 1) 6 to RY (n + 1) A	Not used	—	—
RY (n + 1) B	Analog override selection *2	OVR	—
RY (n + 1) C	Digital override selection 1 *2	OV0	—
RY (n + 1) D	Digital override selection 2 *2	OV1	—
RY (n + 1) E	Digital override selection 3 *2	OV2	—
RY (n + 1) F	Digital override selection 4 *2	OV3	—
RY (n + 2) 0	Position command execution demand	PSR	—
RY (n + 2) 1	Speed command execution demand	SPR	—
RY (n + 2) 2 to RY (n + 2) 5	Not used	—	—
RY (n + 2) 6	Internal torque limit selection *3	CTL	—
RY (n + 2) 7	Proportional control (PID control)	PC	—
RY (n + 2) 8	Gain switching	CDP	—
RY (n + 2) 9	Not used	—	—
RY (n + 2) A	Position/speed specifying method selection	CSL	—
RY (n + 2) B	Absolute value/incremental value selection	CAOR	—
RY (n + 2) C to RY (n + 2) F	Not used	—	—
RY (n + 3) 0 to RY (n + 3) 9	Not used	—	—
RY (n + 3) A	Reset	RES	—
RY (n + 3) B to RY (n + 3) F	Not used	—	—

\*1 "n" depends on the station No. setting.

\*2 This is available with servo amplifiers with software version A6 or later.

\*3 This is available with servo amplifiers with software version A7 or later.

## RXn profile

Servo amplifier → Master station (RXn)			
Device No. *1	Device	Symbol	CN3 connector pin No.
RXn0	Ready	RD	—
RXn1	In-position	INP	9
RXn2	Rough match	CPO	—
RXn3	Not used	—	—
RXn4	Limiting torque	TLC	—
RXn5	Not used	—	—
RXn6	Electromagnetic brake interlock	MBR	13
RXn7	During a temporary stop	PUS	—
RXn8	Monitoring	MOF	—
RXn9	Instruction code execution completion	COF	—
RXnA	Warning	WNG	—
RXnB	Battery warning	BWNG	—
RXnC	Travel completion	MEND	—
RXnD	Dynamic brake interlock	DB	—
RXnE	Position range output	POT	—
RXnF	Not used	—	—
RX (n + 1) 0	Home position return completion 2	ZP2	—
RX (n + 1) 1	Not used	—	—
RX (n + 1) 2			
RX (n + 1) 3			
RX (n + 1) 4	Under cam control	CAMS	—
RX (n + 1) 4	Cam position compensation execution completed	CPCC	—
RX (n + 1) 5	Clutch on/off status	CLTS	—
RX (n + 1) 6	Clutch smoothing status	CLTSM	—
RX (n + 1) 7 to RX (n + 1) F	Not used	—	—
RX (n + 2) 0	Position command execution completion	PSF	—
RX (n + 2) 1	Speed command execution completion	SPF	—
RX (n + 2) 2 to RX (n + 2) F	Not used	—	—
RX (n + 3) 0 to RX (n + 3) 9	Not used	—	—
RX (n + 3) A	Malfunction	ALM	15
RX (n + 3) B	Remote station communication ready	CRD	—
RX (n + 3) C to RX (n + 3) F	Not used	—	—

\*1 "n" depends on the station No. setting.

## RWwn profile

Master station → Servo amplifier (RWwn)	
Device No. <sup>*1</sup>	Device
RWwn0	Monitor 1
RWwn1	Not used
RWwn2	Monitor 2
RWwn3	Not used
RWwn4	Instruction code - Lower 16 bits
RWwn5	Instruction code - Upper 16 bits
RWwn6	Point table No. selection
RWwn7	Not used
RWwn8	Position command data - Lower 16 bits/Point table No.
RWwn9	Position command data - Upper 16 bits
RWwnA	Speed command data - Lower 16 bits/Point table No.
RWwnB	Speed command data - Upper 16 bits
RWwnC	Writing data - Lower 16 bits
RWwnD	Writing data - Upper 16 bits
RWwnE	Cam No. setting
RWwnF	Analog override <sup>*2</sup>

\*1 "n" depends on the station No. setting.

\*2 This is available with servo amplifiers with software version A6 or later.

## RWrn profile

Servo amplifier → Master station (RWrn)	
Device No. <sup>*1</sup>	Device
RWrn0	Monitor 1 data - Lower 16 bits
RWrn1	Monitor 1 data - Upper 16 bits
RWrn2	Monitor 2 data - Lower 16 bits
RWrn3	Monitor 2 data - Upper 16 bits
RWrn4	Respond code
RWrn5	Not used
RWrn6	Point table No. output
RWrn7	Not used
RWrn8	
RWrn9	
RWrnA	
RWrnB	
RWrnC	Reading data - Lower 16 bits
RWrnD	Reading data - Upper 16 bits
RWrnE	Cam No. during control
RWrnF	Not used

\*1 "n" depends on the station No. setting.

## Detailed explanation of the RYn/RXn profile

### RYn profile

Device No.	Device	Description
RYn0	Servo-on	Turn on RYn0 to power on the base circuit, and make the servo amplifier ready to operate. (servo-on status) Turn it off to shut off the base circuit, and coast the servo motor.
RYn1	Forward rotation start	<p>■ Absolute value command method</p> <ul style="list-style-type: none"> <li>Turning on RYn1 during automatic operation will execute one positioning based on the position data set in the point tables.</li> <li>Turning on RYn1 during home position return will also start home position return.</li> <li>Turning on RYn1 during JOG operation will rotate the servo motor in the forward rotation direction while it is on.</li> <li>The forward rotation means address increasing direction.</li> </ul> <p>■ Incremental value command method</p> <ul style="list-style-type: none"> <li>Turning on RYn1 during automatic operation will execute one positioning in the forward rotation direction based on the position data set in point tables.</li> <li>Turning on RYn1 during home position return will also start home position return.</li> <li>Turning on RYn1 during JOG operation will rotate the servo motor in the forward rotation direction while it is on.</li> <li>The forward rotation means address increasing direction.</li> </ul> <p>Turning on both RYn1 and RYn2 during JOG operation will stop the servo motor.</p>
RYn2	Reverse rotation start	Use this device with the incremental value command method. Turning on RYn2 during automatic operation will execute one positioning in the reverse rotation direction based on the position data set in point tables. Turning on RYn2 during JOG operation will rotate the servo motor in the reverse rotation direction while it is on. The reverse rotation means address decreasing direction. Turning on RYn2 during home position return will execute automatic positioning to the home position. Turning on both RYn1 and RYn2 during JOG operation will stop the servo motor.
RYn3	Proximity dog	When RYn3 is turned off, a proximity dog will be detected. The polarity for dog can be changed with [Pr. PT29]. [Pr. PT29] (Polarity for proximity dog detection) ___ 0 (initial value): Detection with off ___ 1: Detection with on
RYn6	Automatic/manual selection	Turning on RYn6 sets automatic operation mode, and turning it off sets manual operation mode.
RYn7	Temporary stop/restart	Turning on RYn7 will temporarily stop the servo motor. Turning on RYn7 again will restart. However, if RYn7 is turned on during home position return, turning on RYn7 again does not restart the home position return operation. Turning on RYn1 (Forward rotation start)/RYn2 (Reverse rotation start) during a temporary stop will not rotate the servo motor. Changing the automatic operation mode to manual operation mode during a temporary stop will erase a travel remaining distance.
RYn8	Monitor output execution demand	Turning on RYn8 sets the following data. At this time, RXn8 turns on. While RYn8 is on, the monitor value is always updated. RWm0: Lower 16 bits of data requested with RWwn0 (Monitor 1) RWm1: Upper 16 bits of data requested with RWwn0 (Monitor 1) RWm2: Lower 16 bits of data requested with RWwn2 (Monitor 2) RWm3: Upper 16 bits of data requested with RWwn2 (Monitor 2) RWm4: Respond code indicating a normal or error result
RYn9	Instruction code execution demand	Turning on RYn9 executes the processing corresponding to the instruction code set with RWwn4 and RWwn5. After executing the instruction code is completed, a respond code indicating a normal or error result is stored in RWm4, and RXn9 turns on. Refer to the following for details of the instruction code.  Page 35 Instruction code
RYnF	Clear	Turning on RYnF clears the droop pulses and the command remaining distance in the position control counter at the rising edge. The pulse width should be 10 ms or more. If [Pr. PD42] is set to "___ 1", the droop pulses and the command remaining distance will always be cleared while RYnF is on.

Device No.	Device	Description
RY (n + 1) 0	Upper stroke limit	To execute the operation, turn on RY (n + 1) 0 and RY (n + 1) 1. Turning off the device corresponding to the address increasing or decreasing direction will bring the servo motor to a slow stop and make it servo-locked. The stop method can be changed with [Pr. PD12].
RY (n + 1) 1	Lower stroke limit	
RY (n + 1) 2	Operation alarm reset	Turn on RY (n + 1) 2 from off to reset [AL. F4 Positioning warning].
RY (n + 1) 3	Cam control command	When using cam control command, set [Pr. PT35] to "_ 1 _" to enable it. Turning RY (n + 1) 3 on switches the control from the normal positioning control to the cam control.
RY (n + 1) 5	Clutch command	This is used to turning on/off the main shaft clutch command. This is used when [Cam control data No. 36 - Main shaft clutch control setting] is set to "_ _ _ 1".
RY (n + 1) B	Analog override selection	When using this device, set "Override selection" of [Pr. PT38] to "2" to enable the analog override function. Turning on RY (n + 1) B enables the setting value of the analog override (RWwnF).
RY (n + 1) C	Digital override selection 1	When using this device, set "Override selection" of [Pr. PT38] to "1" to enable the digital override function. The actual servo motor speed can be obtained by multiplying the command speed and a digital override value selected in the digital override selection 1 to 4.
RY (n + 1) D	Digital override selection 2	
RY (n + 1) E	Digital override selection 3	
RY (n + 1) F	Digital override selection 4	
RY (n + 2) 0	Position command execution demand	Turning on RY (n + 2) 0 sets the point table No. or position command data set in RWwn8 and RWwn9. If a point table No. or position command data is set to the servo amplifier, a respond code indicating a normal or error result is set in RWrn4 and RX (n + 2) 0 (Position command execution completion) turns on. ☞ Page 47 Remote register-based position/speed setting
RY (n + 2) 1	Speed command execution demand	Turning on RY (n + 2) 1 sets the point table No. or speed command data set in RWwnA and RWwnB. If a point table No. or speed command data is set to the servo amplifier, a respond code indicating a normal or error result is set in RWrn4 and RX (n + 2) 1 (Position command execution completion) turns on. ☞ Page 47 Remote register-based position/speed setting
RY (n + 2) 6	Internal torque limit selection	If RY (n + 2) 6 is turned on, the setting value of [Pr. PA11 Forward rotation torque limit] or [Pr. PA12 Reverse rotation torque limit] is compared with [Pr. PC77 Internal torque limit] and the lower one will be enabled.
RY (n + 2) 7	Proportional control (PID control)	Turn on RY (n + 2) 7 to switch the speed amplifier from the proportional integral type to the proportional type. If the servo motor at a stop is rotated even one pulse due to any external factor, it generates torque to compensate for a position shift. When the servo motor shaft is to be locked mechanically after RXnC (Travel completion) is turned off, switching on RY (n + 2) 7 upon turning RXnC off will suppress the unnecessary torque generated to compensate for a position shift. When the shaft is to be locked for a long time, turn on RY (n + 2) 7 and make the torque less than the rated torque with the torque limit. This function will be enabled by selecting "PI control enabled (_ _ _ 0)" in "PI-PID switching control selection" of [Pr. PB24].
RY (n + 2) 8	Gain switching	Turn on RY (n + 2) 8 to use the values of [Pr. PB29] to [Pr. PB36] and [Pr. PB56] to [Pr. PB60] as the load to motor inertia ratio and gain values.
RY (n + 2) A	Position/speed specifying method selection	Select how to give a position command and speed command. Off: Specify a point table No. with RWwn6 (Point table No. selection) to give a position command and speed command. On: Set position command data and speed command data in RWwn8 to RWwnB to give a position command and speed command. To turn on RY (n + 2) A, set [Pr. PT62] to "_ _ _ 2".
RY (n + 2) B	Absolute value/incremental value selection	Select the command method of position data with RY (n + 2) B. RY (n + 2) B is enabled when the position/speed specifying method using remote registers is selected with RY (n + 2) A (Position/speed specifying method selection) and the absolute value command method is selected with [Pr. PT01]. Off: Position data is used as an absolute value. On: Position data is used as an incremental value.
RY (n + 3) A	Reset	Turn on RY (n + 3) A to reset alarms. However, some alarms cannot be cleared with RY (n + 3) A.

## RXn profile

Device No.	Device	Description
RXn0	Ready	When the servo-on is on and the servo amplifier is ready to operate, RXn0 turns on.
RXn1	In-position	When the number of droop pulses is in the preset in-position range, RXn1 turns on. The in-position range can be changed with [Pr. PA10]. When the in-position range is increased, INP may be always on during low-speed rotation.
RXn2	Rough match	When a command remaining distance is lower than the rough match output range set with [Pr. PT12], RXn2 turns on. This is not outputted during base circuit shut-off.
RXn4	Limiting torque	RXn4 turns on when a generated torque reaches a value set with [Pr. PA11 Forward rotation torque limit] or [Pr. PA12 Reverse rotation torque limit].
RXn6	Electromagnetic brake interlock	When using the device, set operation delay time of the electromagnetic brake in [Pr. PC02]. When a servo-off status or alarm occurs, RXn6 turns off.
RXn7	During a temporary stop	When a deceleration begins for a stop, RXn7 turns on by RYn7 (Temporary stop/restart). When RYn7 (Temporary stop/restart) is enabled again and an operation is restarted, RXn7 turns off.
RXn8	Monitoring	Refer to RYn8 (Monitor output execution demand).
RXn9	Instruction code execution completion	Refer to RYn9 (Instruction code execution demand).
RXnA	Warning	When a warning occurs, RXnA turns on. When a warning is not occurring, turning on the power will turn off RXnA after 4 s to 5 s.
RXnB	Battery warning	RXnB turns on when [AL. 92 Battery cable disconnection warning] or [AL. 9F Battery warning] has occurred. When the battery warning is not occurring, turning on the power will turn off RXnB after 4 s to 5 s.
RXnC	Travel completion	When the number of droop pulses is within the in-position output range set with [Pr. PA10] and the command remaining distance is "0", RXnC turns on. When turning on RYn0 (servo-on), RXnC turns on at the same time.
RXnD	Dynamic brake interlock	RXnD turns off when the dynamic brake needs to operate.
RXnE	Position range output	When the current position is within the range set with [Pr. PT19] to [Pr. PT22], RXnE turns on. This will be off when a home position return is not completed or base circuit shut-off is in progress.
RX (n + 1) 0	Home position return completion 2	1. When the incremental system is set When a home position return completes normally, RX (n + 1) 0 turns on. When a home position return starts or if [AL. 69 Command error] occurs, RX (n + 1) 0 turns off. In addition, while [Pr. PT01] is set for the incremental value command method in the positioning mode, RX (n + 1) 0 turns off if the following conditions are met: 1) In servo-off status (servo-off, EM1 or EM2 is turned off, an alarm has occurred, STO is turned off, or [AL. E9 Main circuit off warning] has occurred) 2) The stroke limit is turned off 3) During software limit detection  2. When the absolute position detection system is set When a home position return completes normally, RX (n + 1) 0 turns on. When a home position return starts or if [AL. 69 Command error] occurs, RX (n + 1) 0 turns off. In addition, ZP2 turns off if any of the following conditions are met: 1) [AL. 25 Absolute position erased] has occurred 2) [AL. E3 Absolute position counter warning] has occurred 3) [Pr. PA01], [Pr. PA06], [Pr. PA07], [Pr. PA14], [Pr. PT01 (_ x _)], [Pr. PT08], [Pr. PT28], or [Pr. PT47] has been modified When [Pr. PT01] is set for the incremental value command method in the positioning mode, the absolute position detection system cannot be configured. Review the parameter setting value.
RX (n + 1) 3	Under cam control	It turns on when the control switches to the cam control. It turns off when the control switches to the normal positioning control.
RX (n + 1) 4	Cam position compensation execution completed	It turns on when the control switches to the cam control. It turns off when the position compensation is executed during cam control. It turns on when the position compensation is complete.
RX (n + 1) 5	Clutch on/off status	It turns on with clutch-on. It is always off when [Cam control data No. 36 - Main shaft clutch control setting] is set to "_ _ _ 0".

Device No.	Device	Description
RX (n + 1) 6	Clutch smoothing status	It outputs clutch smoothing status. The output depends on the setting in [Cam control data No. 42 - Main shaft clutch smoothing system] as follows: 0: Direct Always off 1: Time constant method (index) Always on in clutch-on status. It turns off when the clutch is off and the smoothing is complete.
RX (n + 2) 0	Position command execution completion	Refer to RY (n + 2) 0 (Position command execution demand).
RX (n + 2) 1	Speed command execution completion	Refer to RY (n + 2) 1 (Speed command execution demand).
RX (n + 3) A	Malfunction	When an alarm occurs, RX (n + 3) A will turn on. When an alarm is not occurring, turning on the power will turn off RX (n + 3) A after 4 s to 5 s.
RX (n + 3) B	Remote station communication ready	Turning on the power turns on RX (n + 3) B. When an alarm occurs, RX (n + 3) B will turn off.

## Detailed explanation of the RWwn/RWrn profile

### RWwn profile

Device No.	Device	Description	Setting range
RWwn0	Monitor 1	Setting a monitor code to monitor in RWwn0 and turning on RYn8 store data in RWrn0 and RWrn1. At this time, RXn8 turns on. Refer to the following for monitor codes for status display. ☞ Page 33 Monitor code	☞ Page 33 Monitor code
RWwn2	Monitor 2	Setting a monitor code to monitor in RWwn2 and turning on RYn8 store data in RWrn2 and RWrn3. At this time, RXn8 turns on. Refer to the following for monitor codes for status display. ☞ Page 33 Monitor code	☞ Page 33 Monitor code
RWwn4	Instruction code - Lower 16 bits	Set an instruction code No. used to read or write a parameter or point table data or to refer to an alarm. Setting an instruction code No. in RWwn4 and turning on RYn9 execute the instruction. RXn9 turns on after executing the instruction is completed. Refer to the following for the instruction code No. ☞ Page 35 Instruction code	☞ Page 35 Instruction code
RWwn5	Instruction code - Upper 16 bits	When a value other than "0000h" is set in this device, the instruction code is not executed even if RYn9 is turned on and "1 _" is set in respond code.	0000h
RWwn6	Point table No. selection	Set a point table No. to execute in the automatic operation mode. To select the home position return mode, set "0" in RWwn6. Even if a value out of the setting range is set, an alarm or warning does not occur. However, the set value is invalid and the previous setting value is used.	0 to 255
RWwn8	Point table No./Position command data - Lower 16 bits	<p>This function can be used while RY (n + 2) A (Position/speed specifying method selection) is on (the remote register-based position/speed specifying method is selected).</p> <p>■For the point table No. setting</p> <ul style="list-style-type: none"> <li>Setting a point table No. in RWwn8 and turning on RY (n + 2) 0 set the point table No. in the servo amplifier. After the setting is completed, RX (n + 2) 0 turns on.</li> </ul> <p>■For the position command data setting/point table No. (speed command) setting or for the position command data setting/speed command data setting</p> <ul style="list-style-type: none"> <li>Setting the lower 16 bits in RWwn8 and upper 16 bits in RWwn9 and turning on RY (n + 2) 0 write both the upper and lower 16 bits of the position command data. After the writing is completed, RX (n + 2) 0 turns on.</li> <li>The unit can be changed to <math>10^{\text{STM}}</math> [<math>\mu\text{m}</math>], <math>10^{\text{(STM-4)}}</math> [inch], <math>10^{-3}</math> [degree], or [pulse] with the setting of [Pr. PT01].</li> <li>Use [Pr. PT62] to select whether to set a point table No. or position command data.</li> <li>Refer to the following for details of the point table No. or position command data.</li> </ul> <p>☞ Page 47 Remote register-based position/speed setting</p>	Point table No.: 1 to 255 Absolute value command: Position command data -999999 to 999999 Incremental value command: Position command data 0 to 999999
RWwn9	Position command data - Upper 16 bits		



Device No.	Device	Description	Setting range
RWwnA	Point table No./Speed command data - Lower 16 bits	<p>This function can be used while RY (n + 2) A (Position/speed specifying method selection) is on (the remote register-based position/speed specifying method is selected).</p> <p>■For the point table No. setting or for the position command data setting/point table No. (speed command) setting</p> <ul style="list-style-type: none"> <li>Setting a point table No. in RWwnA and turning on RY (n + 2) 1 set the point table No. in the servo amplifier. After the setting is completed, RX (n + 2) 1 turns on.</li> </ul> <p>■For the position command data setting/speed command data setting</p> <ul style="list-style-type: none"> <li>Setting the lower 16 bits in RWwnA and upper 16 bits in RWwnB and turning on RY (n + 2) 1 write both the upper and lower 16 bits of the speed command data. After the writing is completed, RX (n + 2) 1 turns on. The unit is [0.01 r/min] or [0.01 mm/s].</li> <li>Use [Pr. PT62] to select whether to set a point table No. or speed command data.</li> <li>Refer to the following for details of the point table No. or speed command data.</li> </ul> <p>☞ Page 47 Remote register-based position/speed setting</p> <ul style="list-style-type: none"> <li>When setting a servo motor speed in this remote register, always set an acceleration time constant and deceleration time constant in the point table No. 1.</li> </ul>	Point table No.: 1 to 255 Speed command data: 0 to permissible speed
RWwnB	Speed command data - Upper 16 bits		
RWwnC	Writing data - Lower 16 bits	Set writing data used to write a parameter or point table data or to clear the alarm history. Setting writing data in RWwnC and RWwnD and turning on RYn9 write the data to the servo amplifier. When the writing is completed, RXn9 turns on. Refer to the following for writing data. ☞ Page 40 Writing instruction code	☞ Page 40 Writing instruction code
RWwnD	Writing data - Upper 16 bits		
RWwnE	Cam No. setting	Select cam No. This is enabled when [Cam control data No. 49 - Cam No.] is set to "0". Set the cam control data on the cam setting window of MR Configurator2.	0 to 8
RWwnF	Analog override	Set the override value. Set the override value in % unit in the range of 0 to 200 %.	0 to 200

## RWrn profile

Device No.	Device	Description	Setting range
RWrn0	Monitor 1 data - Lower 16 bits	The lower 16 bits of the data corresponding to the monitor code set in RWwn0 is stored.	—
RWrn1	Monitor 1 data - Upper 16 bits	The upper 16 bits of the data corresponding to the monitor code set in RWwn0 is stored. A sign is set if no data is set in the upper 16 bits.	—
RWrn2	Monitor 2 data - Lower 16 bits	The lower 16 bits of the data corresponding to the monitor code set in RWwn2 is stored.	—
RWrn3	Monitor 2 data - Upper 16 bits	The upper 16 bits of the data corresponding to the monitor code set in RWwn2 is stored. A sign is set if no data is set in the upper 16 bits.	—
RWrn4	Respond code	When the codes set in RWwn0 to RWwnD have been executed normally, "0000" is set.	—
RWrn6	Point table No. output	<p>The point table No. is set when RXnC (Travel completion) turns on.</p> <p>In the following conditions, "0" is set in RWrn6.</p> <ul style="list-style-type: none"> <li>• Power on</li> <li>• Servo-off</li> <li>• During home position return</li> <li>• Home position return completion</li> </ul> <p>RWrn6 will keep a previous condition in the following conditions.</p> <ul style="list-style-type: none"> <li>• At operation mode change</li> <li>• When an operation mode was switched by turning RYn6 (Automatic/manual selection) off to on or on to off.</li> <li>• During manual operation</li> <li>• Automatic positioning to home position is in progress.</li> </ul>	—
RWrnC	Reading data - Lower 16 bits	Data corresponding to the reading code set in RWwn4 is set.	—
RWrnD	Reading data - Upper 16 bits		—
RWrnE	Cam No. during control	<p>When cam control is being executed, the cam No. currently being executed is set.</p> <p>When cam control is not being executed, the previously executed cam No. is set.</p>	—

# Code

## Monitor code

Use any of the instruction codes 0100h to 011Fh to read the decimal point position (multiplying factor) of the status display. Setting any code No. that is not given in this section will set an error code ( \_ \_ \_ 1) in respond code (RWrn4). At this time, "0000" is set in RWrn0 to RWrn3.

Code No.	Monitored item	Response data (Servo amplifier → Master station)	
		Data length	Unit
0000h	—	—	—
0001h	Current position * <sup>5</sup>	32 bits	10 <sup>STM</sup> [μm]/10 <sup>(STM-4)</sup> [inch]/10 <sup>-3</sup> [degree]/[pulse] * <sup>1</sup>
0002h	—	—	—
0003h	Command position * <sup>5</sup>	32 bits	10 <sup>STM</sup> [μm]/10 <sup>(STM-4)</sup> [inch]/10 <sup>-3</sup> [degree]/[pulse] * <sup>1</sup>
0004h	—	—	—
0005h	Command remaining distance	32 bits	10 <sup>STM</sup> [μm]/10 <sup>(STM-4)</sup> [inch]/10 <sup>-3</sup> [degree]/[pulse] * <sup>1</sup>
0006h	—	—	—
0007h	Override level * <sup>4</sup>	16 bits	[%]
0008h	Point table No.	16 bits	—
0009h	—	—	—
000Ah	Cumulative feedback pulses	32 bits	[pulse]
000Bh	—	—	—
000Ch			
000Dh			
000Eh	Droop pulses	32 bits	[pulse]
000Fh	—	—	—
0010h			
0011h	Regenerative load ratio	16 bits	[%]
0012h	Effective load ratio	16 bits	[%]
0013h	Peak load ratio	16 bits	[%]
0014h	Instantaneous torque	16 bits	[%]
0015h	ABS counter	16 bits	[rev]
0016h	Servo motor speed	32 bits	0.01 [r/min]/0.01 [mm/s]
0017h	—	—	—
0018h	Bus voltage	16 bits	[V]
0019h	ABS position - Lower 32 bits	32 bits	[μm]/10 <sup>-4</sup> [inch]/10 <sup>-3</sup> [degree]/[pulse] * <sup>3</sup>
001Ah	—	—	—
001Bh	ABS position - Upper 32 bits	32 bits	[μm]/10 <sup>-4</sup> [inch]/10 <sup>-3</sup> [degree]/[pulse] * <sup>3</sup>
001Ch	Position within one-revolution	32 bits	[pulse]
001Dh	—	—	—
001Eh			
001Fh			
0020h	Cam axis one cycle current value	32 bits	10 <sup>STM</sup> [μm]/10 <sup>(STM-4)</sup> [inch]/10 <sup>-3</sup> [degree]/[pulse] * <sup>1</sup> * <sup>2</sup>
0021h	Cam standard position	32 bits	10 <sup>STM</sup> [μm]/10 <sup>(STM-4)</sup> [inch]/10 <sup>-3</sup> [degree]/[pulse] * <sup>1</sup> * <sup>2</sup>
0022h	Cam axis feed current value	32 bits	10 <sup>STM</sup> [μm]/10 <sup>(STM-4)</sup> [inch]/10 <sup>-3</sup> [degree]/[pulse] * <sup>1</sup> * <sup>2</sup>
0024h	Cam stroke amount in execution	32 bits	10 <sup>STM</sup> [μm]/10 <sup>(STM-4)</sup> [inch]/10 <sup>-3</sup> [degree]/[pulse] * <sup>1</sup> * <sup>2</sup>
0025h	Main axis current value	32 bits	10 <sup>STM</sup> [μm]/10 <sup>(STM-4)</sup> [inch]/10 <sup>-3</sup> [degree]/[pulse] * <sup>1</sup> * <sup>2</sup>
0026h	Main axis one cycle current value	32 bits	10 <sup>STM</sup> [μm]/10 <sup>(STM-4)</sup> [inch]/10 <sup>-3</sup> [degree]/[pulse] * <sup>1</sup> * <sup>2</sup>

- \*1 The unit can be changed to  $10^{\text{STM}}$  [ $\mu\text{m}$ ],  $10^{\text{STM-4}}$  [inch],  $10^{-3}$  [degree], or [pulse] with the setting of [Pr. PT01].
- \*2 Depending on the setting of [Cam control data No. 30 Main shaft input axis selection], the parameters used to set the unit and feed length multiplication will change as follows. For details of each parameter, refer to the following.
  - ☞ Page 145 Positioning control parameters ([Pr. PT\_ \_])
  - ☞ Page 268 List of cam control data

Setting of [Cam control data No. 30]	Parameter for the unit setting	Parameter for the feed length multiplication setting
"0" or "1"	[Pr. PT01]	[Pr. PT03]
"2"	[Cam control data No. 14]	[Cam control data No. 14]

- \*3 The unit can be changed to 10 [ $\mu\text{m}$ ],  $10^{-4}$  [inch],  $10^{-3}$  [degree], or [pulse] with the setting of [Pr. PT01].
- \*4 This is available with servo amplifiers with software version A6 or later.
- \*5 The positions will be displayed by roll feed when "Current position/Command position display selection" of [Pr. PT26] is set to "1".
  - ☞ Page 104 Roll feed display function

## Instruction code

Refer to the following for the timing charts of the instruction codes.

☞ Page 45 Instruction code

### ■Reading instruction code

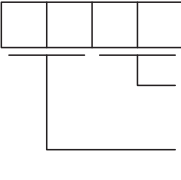
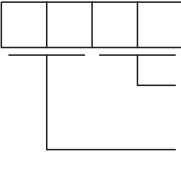

The data requested to be read with the instruction codes 0000h to 0AFFh is stored in reading data (RWrnC and RWrnD). Set the instruction code No. corresponding to the item in RWwn4 and RWwn5. The instruction code No. and response data are all hexadecimal.

Setting any instruction code No. that is not given in this section will store an error code ( \_ \_ 1 \_ ) in respond code (RWrn4). If any unusable parameter or point table is read, an error code ( \_ \_ 2 \_ ) is stored. At this time, "0000" is stored in reading data (RWrnC and RWrnD).

Code No.		Item/function	Reading data content (Servo amplifier → Master station)	
RWwn5	RWwn4		RWrnC	RWrnD
0000h	0000h	Operation mode Reads the current operation mode.	0000: CC-Link IE operation mode 0001: Test operation mode	Always 0
0000h	0002h	Travel distance multiplying factor Reads the multiplying factor of the position data in the point table set with [Pr. PT03].	0000: × 1 0100: × 10 0200: × 100 0300: × 1000	Always 0
0000h	0010h	Current alarm (warning) reading Reads the alarm No. or warning No. that is currently occurring.		Always 0
0000h	0020h	Alarm number in alarm history (latest alarm)		Always 0
0000h	0021h	Alarm number in alarm history (one alarm ago)		
0000h	0022h	Alarm number in alarm history (two alarms ago)		
0000h	0023h	Alarm number in alarm history (three alarms ago)		
0000h	0024h	Alarm number in alarm history (four alarms ago)		
0000h	0025h	Alarm number in alarm history (five alarms ago)		
0000h	0026h	Alarm number in alarm history (six alarms ago)		
0000h	0027h	Alarm number in alarm history (seven alarms ago)		
0000h	0028h	Alarm number in alarm history (eight alarms ago)		
0000h	0029h	Alarm number in alarm history (nine alarms ago)		
0000h	002Ah	Alarm number in alarm history (ten alarms ago)		
0000h	002Bh	Alarm number in alarm history (eleven alarms ago)		
0000h	002Ch	Alarm number in alarm history (twelve alarms ago)		
0000h	002Dh	Alarm number in alarm history (thirteen alarms ago)		
0000h	002Eh	Alarm number in alarm history (fourteen alarms ago)		
0000h	002Fh	Alarm number in alarm history (fifteen alarms ago)		

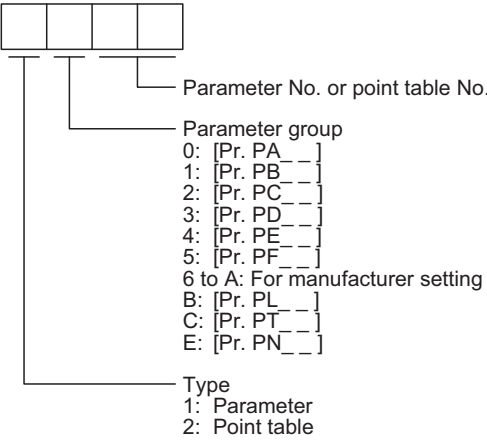
Code No.		Item/function	Reading data content (Servo amplifier → Master station)	
RWwn5	RWwn4		RWrnC	RWrnD
0000h	0030h	Alarm occurrence time in alarm history (latest alarm)	Returns the occurrence time of the alarm that occurred before.	Always 0
0000h	0031h	Alarm occurrence time in alarm history (one alarm ago)		
0000h	0032h	Alarm occurrence time in alarm history (two alarms ago)		
0000h	0033h	Alarm occurrence time in alarm history (three alarms ago)		
0000h	0034h	Alarm occurrence time in alarm history (four alarms ago)		
0000h	0035h	Alarm occurrence time in alarm history (five alarms ago)		
0000h	0036h	Alarm occurrence time in alarm history (six alarms ago)		
0000h	0037h	Alarm occurrence time in alarm history (seven alarms ago)		
0000h	0038h	Alarm occurrence time in alarm history (eight alarms ago)		
0000h	0039h	Alarm occurrence time in alarm history (nine alarms ago)		
0000h	003Ah	Alarm occurrence time in alarm history (ten alarms ago)		
0000h	003Bh	Alarm occurrence time in alarm history (eleven alarms ago)		
0000h	003Ch	Alarm occurrence time in alarm history (twelve alarms ago)		
0000h	003Dh	Alarm occurrence time in alarm history (thirteen alarms ago)		
0000h	003Eh	Alarm occurrence time in alarm history (fourteen alarms ago)		
0000h	003Fh	Alarm occurrence time in alarm history (fifteen alarms ago)		
0000h	0040h	Input device status 0 Reads the status (OFF/ON) of input devices.	Bit 0 to bit F indicate the OFF/ON status of the corresponding input devices. 0: Servo-on 1: Forward rotation start 2: Reverse rotation start 3: Proximity dog 4, 5: For manufacturer setting 6: Automatic/manual selection 7: Temporary stop/restart 8: Monitor output execution demand 9: Instruction code execution demand A to E: For manufacturer setting F: Clear	Always 0
0000h	0041h	Input device status 1 Reads the status (OFF/ON) of input devices.	Bit 0 to bit F indicate the OFF/ON status of the corresponding input devices. 0: Upper stroke limit <sup>*1</sup> 1: Lower stroke limit <sup>*1</sup> 2: Operation alarm reset 3: Cam control command 4: For manufacturer setting 5: Clutch command 6 to F: For manufacturer setting	Always 0

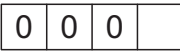
Code No.		Item/function	Reading data content (Servo amplifier → Master station)	
RWwn5	RWwn4		RWrnC	RWrnD
0000h	0042h	Input device status 2 Reads the status (OFF/ON) of input devices.	Bit 0 to bit F indicate the OFF/ON status of the corresponding input devices. 0: Position command execution demand 1: Speed command execution demand 2 to 5: For manufacturer setting 6: Internal torque limit selection 7: Proportional control (PID control) 8: Gain switching 9: For manufacturer setting A: Position/speed specifying method selection B: Absolute value/incremental value selection C to F: For manufacturer setting	Always 0
0000h	0043h	Input device status 3 Reads the status (OFF/ON) of input devices.	Bit 0 to bit F indicate the OFF/ON status of the corresponding input devices. 0 to 9: For manufacturer setting A: Reset B to F: For manufacturer setting	Always 0
0000h	0081h	Energization time Reads the energization time since shipment.	Returns the energization time [h].	Always 0
0000h	0082h	Power on frequency Reads the number of power-on times since shipment.	Returns the number of power-on times.	Always 0
0000h	00A0h	Load to motor inertia ratio Reads the estimated load to motor inertia ratio on the servo motor shaft.	Return unit [0.01 times] Returns the estimated load to motor inertia ratio.	Always 0
0000h	00B0h	Home position within one-revolution (CYC0) Reads the cycle counter value of an absolute home position.	Return unit [pulse] Stores the lower 16 bits of the cycle counter value of the absolute home position (32-bit data).	Stores the upper 16 bits of the cycle counter value of the absolute home position.
0000h	00B2h	Home position multi-revolution data (ABS0) Reads the multi-revolution counter value of an absolute home position.	Return unit [rev] Returns the multi-revolution counter value.	Always 0
0000h	00C0h	Error parameter No./Point data No. reading Reads the parameter No. and point table No. that have an error.	 <p>Parameter No. or point table No.</p> <p>Parameter group</p> <ul style="list-style-type: none"> <li>0: [Pr. PA _ _]</li> <li>1: [Pr. PB _ _]</li> <li>2: [Pr. PC _ _]</li> <li>3: [Pr. PD _ _]</li> <li>4: [Pr. PE _ _]</li> <li>5: [Pr. PF _ _]</li> <li>6 to A: For manufacturer setting</li> <li>B: [Pr. PL _ _]</li> <li>C: [Pr. PT _ _]</li> <li>E: [Pr. PN _ _]</li> </ul> <p>Type</p> <ul style="list-style-type: none"> <li>1: Parameter</li> <li>2: Point table</li> </ul>	Always 0
0000h	0100h to 011Fh	Monitor multiplying factor Reads the multiplying factor of data to be read with a monitor code. The instruction codes 0100h to 011Fh correspond to each of the monitor codes 0000h to 001Fh. To the instruction code that has no corresponding monitor code, "0000h" is applied.	0000: × 1 0001: × 10 0002: × 100 0003: × 1000	Always 0

Code No.		Item/function	Reading data content (Servo amplifier → Master station)	
RWwn5	RWwn4		RWrnC	RWrnD
0000h	0200h	Parameter group reading Reads the parameter group written with the code No. 8200h.	 <p>Parameter group  0: [Pr. PA ___]  1: [Pr. PB ___]  2: [Pr. PC ___]  3: [Pr. PD ___]  4: [Pr. PE ___]  5: [Pr. PF ___]  6 to A: For manufacturer setting  B: [Pr. PL ___]  C: [Pr. PT ___]  E: [Pr. PN ___]</p>	Always 0
0000h	0201h to 02FFh	Parameter data reading Reads the setting values of the parameters in the group read with the code No. 0200h. The lower two digits of the code No. which are converted to decimal correspond to the parameter No.	Stores the lower 16 bits of the setting value of the requested parameter No.	Stores the upper 16 bits of the setting value of the requested parameter No.
0000h	0301h to 03FFh	Data form of parameter Reads the data form of the parameter numbers in the group read with the code No. 0200h. The lower two digits of the code No. which are converted to decimal correspond to the parameter No.	Stores the data form of the requested parameter No.	Always 0
			 <p>Decimal point position  0: No decimal point  1: First least significant digit (no decimal point)  2: Second least significant digit  3: Third least significant digit  4: Fourth least significant digit</p> <p>Data form  0: Data is used unchanged in hexadecimal.  1: Data must be converted into decimal.</p> <p>Parameter writing type  0: Enabled after writing  1: Enabled when power is cycled after writing  2: Enabled when the controller is reset</p>	
0000h	0401h to 04FFh	Position data of point table No. 1 to 255 Reads the position data of point table No. 1 to 255.	Stores the lower 16 bits of the position data of the requested point table No.	Stores the upper 16 bits of the position data of the requested point table No.
0000h	0601h to 06FFh	Servo motor speed of point table No. 1 to 255 The lower two digits of the code No. which are converted to decimal correspond to the point table No.	Stores the lower 16 bits of the servo motor speed of the requested point table No.	Stores the upper 16 bits of the servo motor speed of the requested point table No.
0000h	0701h to 07FFh	Acceleration time constant of point table No. 1 to 255 The lower two digits of the code No. which are converted to decimal correspond to the point table No.	Stores the acceleration time constant of the requested point table No.	Always 0
0000h	0801h to 08FFh	Deceleration time constant of point table No. 1 to 255 The lower two digits of the code No. which are converted to decimal correspond to the point table No.	Stores the deceleration time constant of the requested point table No.	Always 0
0000h	0901h to 09FFh	Dwell of point table No. 1 to 255 The lower two digits of the code No. which are converted to decimal correspond to the point table No.	Stores the dwell of the requested point table No.	Always 0
0000h	0A01h to 0AFFh	Auxiliary function of point table No. 1 to 255 The lower two digits of the code No. which are converted to decimal correspond to the point table No.	Stores the sub functions of the requested point table No.	Always 0



Code No.		Item/function	Reading data content (Servo amplifier → Master station)	
RWwn5	RWwn4		RWrnC	RWrnD
102Dh	8400h	Reading of the cam axis length per cycle setting	Stores the lower 16 bits of the cam axis length per cycle setting.	Stores the upper 16 bits of the cam axis length per cycle setting.
102Dh	8500h	Reading of the cam stroke amount setting	Stores the lower 16 bits of the cam stroke amount setting.	Stores the upper 16 bits of the cam stroke amount setting.

\*1 Servo amplifiers with software version A2 or earlier indicate the state of input (RY (n + 1) 0/RY (n + 1) 1) from the controller regardless of the setting value for the [Pr. PD41 Sensor input method selection].

By setting [Pr. PD41], servo amplifiers with software version A3 or later can switch between indicating the state of input (LSP/LSN) from the servo amplifier and input (RY (n + 1) 0/RY (n + 1) 1) from the controller. When [Pr. PD41] is the initial value, the state of input to the servo amplifier is indicated. When it is set to input to the servo amplifier, bit 0 and bit 1 of setting value [Pr. PA14 Rotation direction selection/travel direction selection] are interchanged.

## ■Writing instruction code

Data requested to be written with the instruction codes 8000h to 91FFh is written to the servo amplifier.

Set the instruction code No. corresponding to the item in instruction code (RWwn4 and RWwn5) and the data to be written in writing data (RWwnC and RWwnD). The instruction code No. and response data are all hexadecimal.

Setting any instruction code No. that is not given in this section will store an error code ( \_ \_ 1 \_ ) in respond code (RWrn4).

Code No.		Item/function	Writing data content (Servo amplifier → Master station)	
RWwn5	RWwn4		RWwnC	RWwnD
0000h	8010h	Alarm reset command Clears the alarm that is currently occurring.	1EA5h	Set to "0000h".
0000h	8101h	Feedback pulse value display data clear command Resets the display data of the status display "Cumulative feedback pulses" to "0".	1EA5h	Set to "0000h".
0000h	8200h	Writing command of parameter group Writes the group of the parameter to write with code No. 8201h to 82FFh and 8301h to 83FFh. Writes the group of the parameter to read with code No. 0201h to 02FFh and 0301h to 03FFh.	<div style="border: 1px solid black; display: inline-block; padding: 2px;">0 0 0 □</div> Parameter group 0: [Pr. PA_ _] 1: [Pr. PB_ _] 2: [Pr. PC_ _] 3: [Pr. PD_ _] 4: [Pr. PE_ _] 5: [Pr. PF_ _] 6 to A: For manufacturer setting B: [Pr. PL_ _] C: [Pr. PT_ _] E: [Pr. PN_ _]	Set to "0000h".
0000h	8201h to 82FFh	Data RAM command of parameter Writes the setting values of the parameters in the group written with code No. 8200h to the RAM. This setting value is cleared when the power supply is shut off. The lower two digits of the code No. which are converted to decimal correspond to the parameter No. An error code is returned if a value outside the range of a parameter is written.	Set the lower 16 bits of the parameter setting value.	Set the upper 16 bits of the parameter setting value. Set the 16-bit parameter to "0000h" if it has a positive sign. Set it to "FFFFh" if it has a negative sign. Set the 16-bit parameter to "0000h" if it has no sign.
0000h	8301h to 83FFh	Data EEPROM command of parameter Writes the setting values of the parameters in the group written with code No. 8200h to the EEPROM. The setting value written in the EEPROM is held even when the power supply is shut off. The lower two digits of the code No. which are converted to decimal correspond to the parameter No. An error code is returned if a value outside the range of a parameter is written.	Set the lower 16 bits of the parameter setting value.	Set the upper 16 bits of the parameter setting value. Set the 16-bit parameter to "0000h" if it has a positive sign. Set it to "FFFFh" if it has a negative sign. Set the 16-bit parameter to "0000h" if it has no sign.
0000h	8401h to 84FFh	Position data RAM command of point table Writes the position data of point table No. 1 to 255 to the RAM. This setting value is cleared when the power supply is shut off. The lower two digits of the code No. which are converted to decimal correspond to the point table No.	Set the lower 16 bits of the position data.	Set the upper 16 bits of the position data.

Code No.		Item/function	Writing data content (Servo amplifier → Master station)	
RWwn5	RWwn4		RWwnC	RWwnD
0000h	8601h to 86FFh	Servo motor speed data RAM command of point table Writes the servo motor speed of point table No. 1 to 255 to the RAM. This setting value is cleared when the power supply is shut off. The lower two digits of the code No. which are converted to decimal correspond to the point table No.	Set the lower 16 bits of the servo motor speed.	Set the upper 16 bits of the servo motor speed.
0000h	8701h to 87FFh	Acceleration time constant data RAM command of point table Writes the acceleration time constant of point table No. 1 to 255 to the RAM. This setting value is cleared when the power supply is shut off. The lower two digits of the code No. which are converted to decimal correspond to the point table No.	Set the acceleration time constant.	Set to "0000h".
0000h	8801h to 88FFh	Deceleration time constant data RAM command of point table Writes the deceleration time constant of point table No. 1 to 255 to the RAM. This setting value is cleared when the power supply is shut off. The lower two digits of the code No. which are converted to decimal correspond to the point table No.	Set the deceleration time constant.	Set to "0000h".
0000h	8901h to 89FFh	Dwell data RAM command of point table Writes the dwell of point table No. 1 to 255 to the RAM. This setting value is cleared when the power supply is shut off. The lower two digits of the code No. which are converted to decimal correspond to the point table No.	Set the dwell.	Set to "0000h".
0000h	8A01h to 8AFFh	Auxiliary function data RAM command of point table Writes the auxiliary functions of point table No. 1 to 255 to the RAM. This setting value is cleared when the power supply is shut off. The lower two digits of the code No. which are converted to decimal correspond to the point table No.	Set the auxiliary function.	Set to "0000h".
0000h	8B01h to 8BFFh	Position data EEPROM-ROM command of point table Writes the position data of point table No. 1 to 255 to the EEPROM-ROM. The setting value written in the EEPROM-ROM is held even when the power supply is shut off. The lower two digits of the code No. which are converted to decimal correspond to the point table No.	Set the lower 16 bits of the position data.	Set the upper 16 bits of the position data.
0000h	8D01h to 8DFFh	Servo motor speed data EEPROM-ROM command of point table Writes the servo motor speed of point table No. 1 to 255 to the EEPROM-ROM. The setting value written in the EEPROM-ROM is held even when the power supply is shut off. The lower two digits of the code No. which are converted to decimal correspond to the point table No.	Set the lower 16 bits of the servo motor speed.	Set the upper 16 bits of the servo motor speed.

Code No.		Item/function	Writing data content (Servo amplifier → Master station)	
RWwn5	RWwn4		RWwnC	RWwnD
0000h	8E01h to 8EFFh	Acceleration time constant data EEPROM command of point table Writes the acceleration time constant of point table No. 1 to 255 to the EEPROM. The setting value written in the EEPROM is held even when the power supply is shut off. The lower two digits of the code No. which are converted to decimal correspond to the point table No.	Set the acceleration time constant.	Set to "0000h".
0000h	8F01h to 8FFFh	Deceleration time constant data EEPROM command of point table Writes the deceleration time constants of point table No. 1 to 255 to the EEPROM. The setting value written in the EEPROM is held even when the power supply is shut off. The lower two digits of the code No. which are converted to decimal correspond to the point table No.	Set the deceleration time constant.	Set to "0000h".
0000h	9001h to 90FFh	Dwell data EEPROM command of point table Writes the dwell of point table No. 1 to 255 to the EEPROM. The setting value written in the EEPROM is held even when the power supply is shut off. The lower two digits of the code No. which are converted to decimal correspond to the point table No.	Set the dwell.	Set to "0000h".
0000h	9101h to 91FFh	Auxiliary function data EEPROM command of point table Writes the auxiliary functions of point table No. 1 to 255 to the EEPROM. The setting value written in the EEPROM is held even when the power supply is shut off. The lower two digits of the code No. which are converted to decimal correspond to the point table No.	Set the auxiliary function.	Set to "0000h".
A02Dh	8400h	Cam axis one cycle length setting RAM writing	Set the lower-order 16 bits for the cam axis one cycle length.	Set the upper-order 16 bits for the cam axis one cycle length.
A02Dh	8500h	Cam stroke amount setting RAM writing	Set the lower-order 16 bits for the cam stroke amount.	Set the upper-order 16 bits for the cam stroke amount.

## Respond code (RWrn4)

If any of monitor codes, instruction codes, point table No. selection, point table No./position command data, and point table No./speed command data set in remote registers is outside the setting range, the corresponding error code is set in respond code (RWrn4). If the setting is within the setting range, "0000" is set.

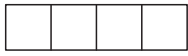

Error of the monitor code

Code No.	Error detail	Details
0	Normal result	The code has been completed normally.
1	Code error	An incorrect code No. is specified.
2		
3		

Error of the reading instruction code and writing instruction code

Code No.	Error detail	Details
0	Normal result	The instruction has been completed normally.
1	Code error	An incorrect code No. is specified.
2	Parameter selection error	A parameter No. that cannot be referred to is specified.
3	Writing data out of range	A value out of the range is set.

Error of the point table No./position command data

Code No.	Error detail	Details
0	Normal result	The instruction has been completed normally.
1		
2		
3	Writing data out of range	A value out of the range is set.

Error of the point table No./speed command data

Code No.	Error detail	Details
0	Normal result	The instruction has been completed normally.
1		
2		
3	Writing data out of range	A value out of the range is set.

# Data communication timing chart

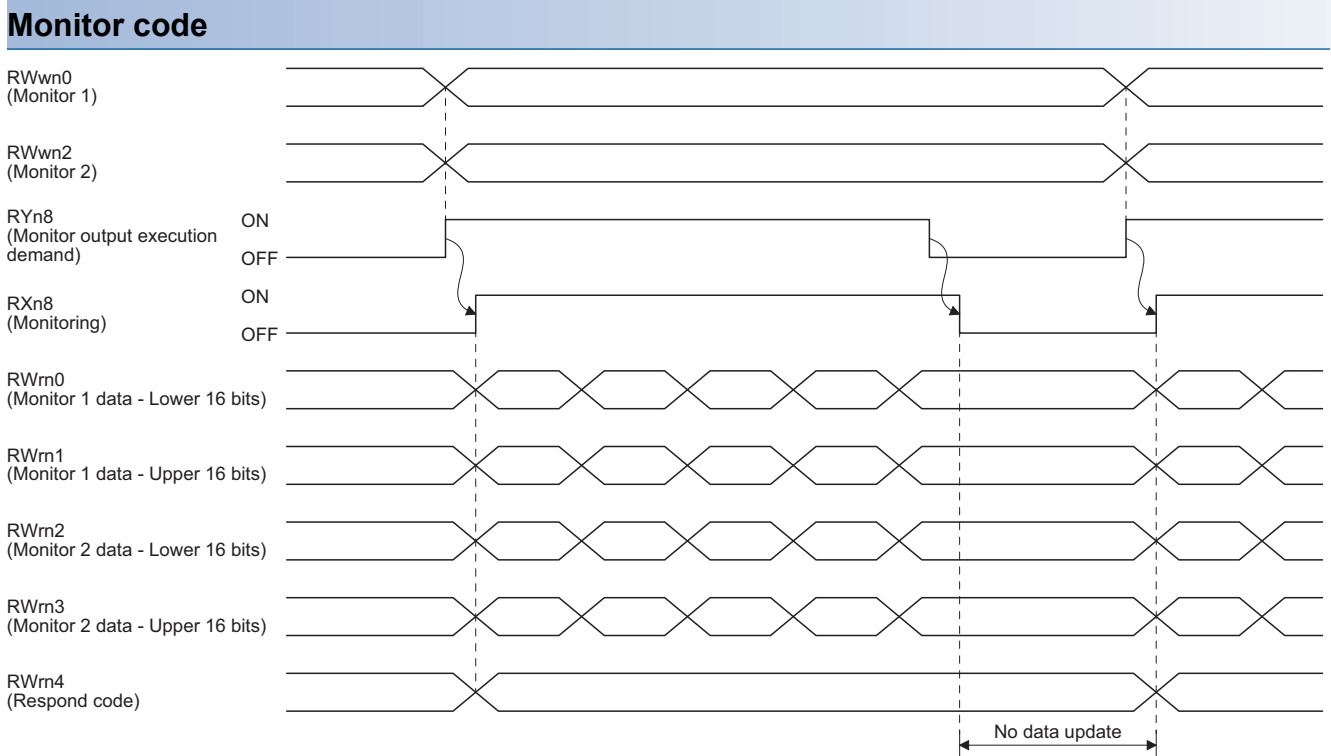

Set a monitor code ( [Page 33 Monitor code](#)) in RWwn0 (Monitor 1) and RWwn2 (Monitor 2) and turn on RYn8 (Monitor output execution demand). Turning on RYn8 (Monitor output execution demand) sets the following data. All 32-bit data is set in remote registers after divided into the upper 16 bits and lower 16 bits. Data is all hexadecimal. At this time, RXn8 (Monitoring) turns on.

- RWrn0 (Monitor 1 data - Lower 16 bits): Lower 16 bits of data requested with RWwn0 (Monitor 1)
- RWrn1 (Monitor 1 data - Upper 16 bits): Upper 16 bits of data requested with RWwn0 (Monitor 1)
- RWrn2 (Monitor 2 data - Lower 16 bits): Lower 16 bits of data requested with RWwn2 (Monitor 2)
- RWrn3 (Monitor 2 data - Upper 16 bits): Upper 16 bits of data requested with RWwn2 (Monitor 2)

A sign is set if no data is set in RWrn1 or RWrn3. For "+", "0000" is set, and "FFFF" is set for "-".

Monitor data RWrn0 to RWrn3 set in remote registers are constantly updated while RXn8 (Monitoring) is ON.

When RXn8 (Monitoring) turns off, the update of the monitor data RWrn0 to RWrn3 stops, and does not restart until RXn8 (Monitoring) turns on again. If a monitor code out of the specifications is set in either RWwn0 (Monitor 1) or RWwn2 (Monitor 2), the corresponding error code (\_\_\_ 1) is stored in RWrn4 (Respond code). At this time, "0000" is stored in the monitor data RWrn0 to RWrn3. Refer to the following for details of respond code.

[Page 43 Respond code \(RWrn4\)](#)

Until RXn8 turns on after RYn8 is turned on, do not change the setting values of RWwn0 and RWwn2.

## Instruction code

### ■ Reading instruction code (0000h to 0AFFh)

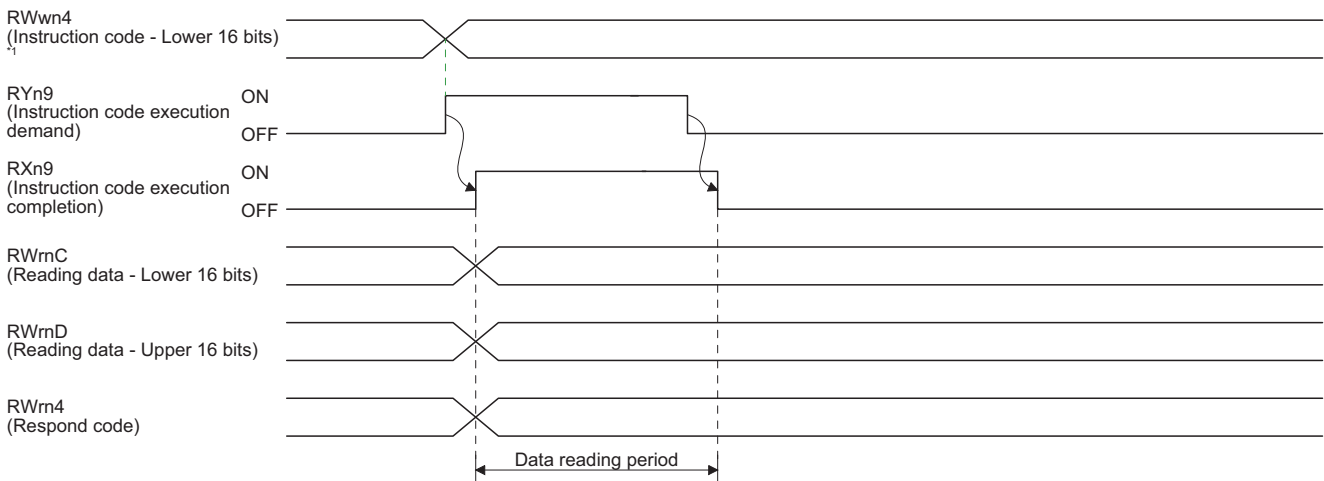

\*1 The value of RWwn5 (Instruction code - Upper 16 bits) is fixed to "0".

Set a reading instruction code (☞ Page 35 Reading instruction code) in RWwn4 (Instruction code - Lower 16 bits) and turn on RYn9 (Instruction code execution demand). Turning on RYn9 (Instruction code execution demand) sets the data corresponding to the reading code in RWrnC (Reading data - Lower 16 bits) and RWrnD (Reading data - Upper 16 bits). Data is all hexadecimal. At this time, RXn9 (Instruction code execution completion) also turns on. Read the reading data to be set in RWrnC (Reading data - Lower 16 bits) and RWrnD (Reading data - Upper 16 bits) while RYn9 (Instruction code execution demand) is on. The data set in RWrnC (Reading data - Lower 16 bits) and RWrnD (Reading data - Upper 16 bits) is held until RYn9 (Instruction code execution demand) is turned on with the next reading instruction code set.

If the instruction code out of the specifications is set in RWwn4 (Instruction code - Lower 16 bits), an error code ( \_ \_ 1 \_ ) is set in respond code. If any unusable parameter or point table is read, an error code ( \_ \_ 2 \_ ) is set. Turn off RYn9 (Instruction code execution demand) after the data reading is completed.

Until RXn9 turns on after RYn9 is turned on, do not change the setting value of RWwn4. Turn off RYn9 after the data reading is completed.

## ■ Writing instruction code (8000h to 91FFh)

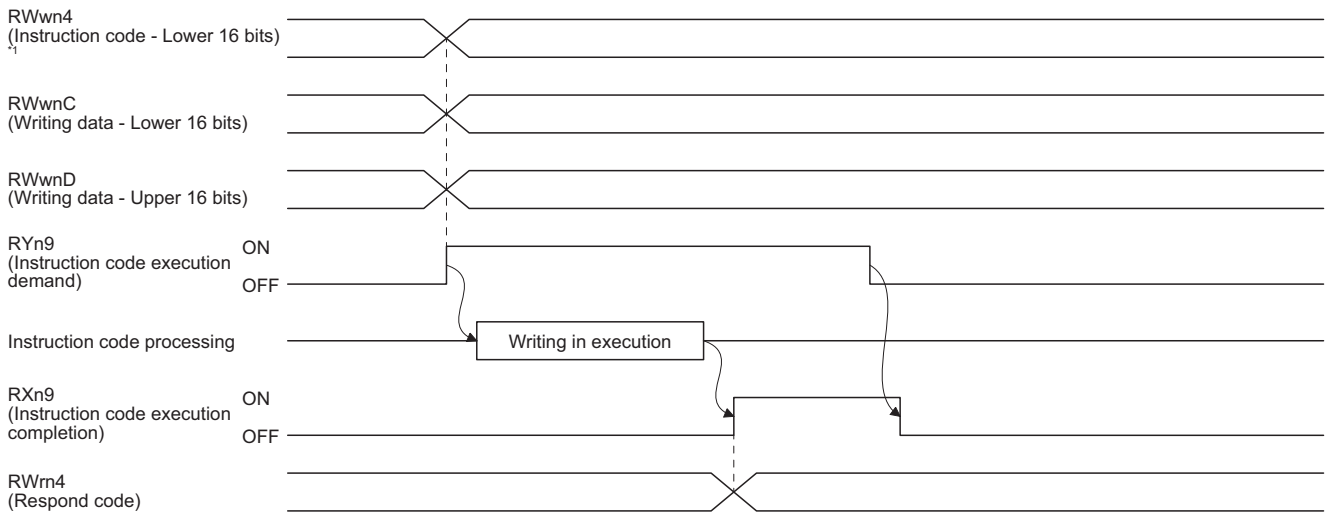

\*1 The value of RWwn5 (Instruction code - Upper 16 bits) is fixed to "0".

Set a writing instruction code (☞ Page 40 Writing instruction code) in RWwn4 (Instruction code - Lower 16 bits) and the data to write (data to execute) in RWwnC (Writing data - Lower 16 bits) and RWwnD (Writing data - Upper 16 bits) in hexadecimal, and turn on RYn9 (Instruction code execution demand).

Turning on RYn9 (Instruction code execution demand) writes the data set with RWwnC (Writing data - Lower 16 bits) and RWwnD (Writing data - Upper 16 bits) to the item corresponding to the writing instruction code. After the writing is completed, RXn9 (Instruction code execution completion) turns on.

If the instruction code out of the specifications is set in RWwn4 (Instruction code - Lower 16 bits), an error code ( \_ \_ 1 \_ ) is set in respond code.

Turn off RYn9 (Instruction code execution demand) after RXn9 (Instruction code execution completion) has turned on.

Until RXn9 turns on after RYn9 is turned on, do not change the setting values of RWwn4, RWwnC, and RWwnD. Turn off RYn9 while RXn9 is on.



## Remote register-based position/speed setting

The functions in this section can be used while RY (n + 2) A (Position/speed specifying method selection) is on (the remote register-based position/speed specifying method is selected).

Turn off RY (n + 2) A to perform home position return.

The position command and speed command necessary for positioning can be selected with [Pr. PT62] as follows.

Setting value	Position command	Speed command
0	Specify a point table No. in RWwn8.	
1	Set a position data in RWwn8 and RWwn9.	Specify a point table No. in RWwnA.
2		Set the servo motor speed in RWwnA and RWwnB.

### For the point table No. setting

Specify the point table No. stored in the servo amplifier and execute positioning.

Before executing positioning, set "\_\_\_0" (initial value) in [Pr. PT62] to enable the operation that follows the setting of the point table No.

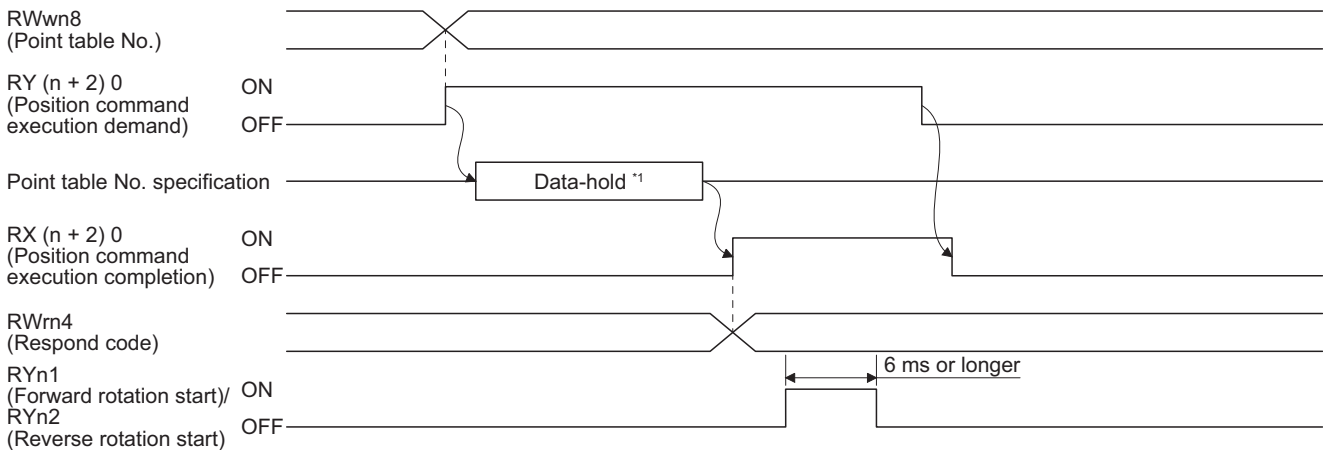

\*1 This data is stored in the RAM of the servo amplifier. Thus, the data is cleared when the power supply is shut off.

Set the point table No. in RWwn8 (Point table No.) and turn on RY (n + 2) 0 (Position command execution demand). Turning on RY (n + 2) 0 stores the point table No. into the RAM of the servo amplifier.

When the data is stored, RX (n + 2) 0 (Position command execution completion) turns on.

If data outside the setting range is set in RWwn8 (Point table No.), an error code (Page 43 Respond code (RWrn4)) is set in respond code.

Turn on RYn1 (Forward rotation start) or RYn2 (Reverse rotation start) after RX (n + 2) 0 (Position command execution completion) has turned on.

## For the position command data setting and point table No. (speed command) setting

Specify a position address with a remote register, and specify speed command data with a point table No. Then, execute positioning using the servo motor speed, acceleration time constant, and deceleration time constant.

Before executing positioning, set "\_\_\_ 1" in [Pr. PT62] to enable the operation that follows the settings of the position command data and point table No. (speed command).

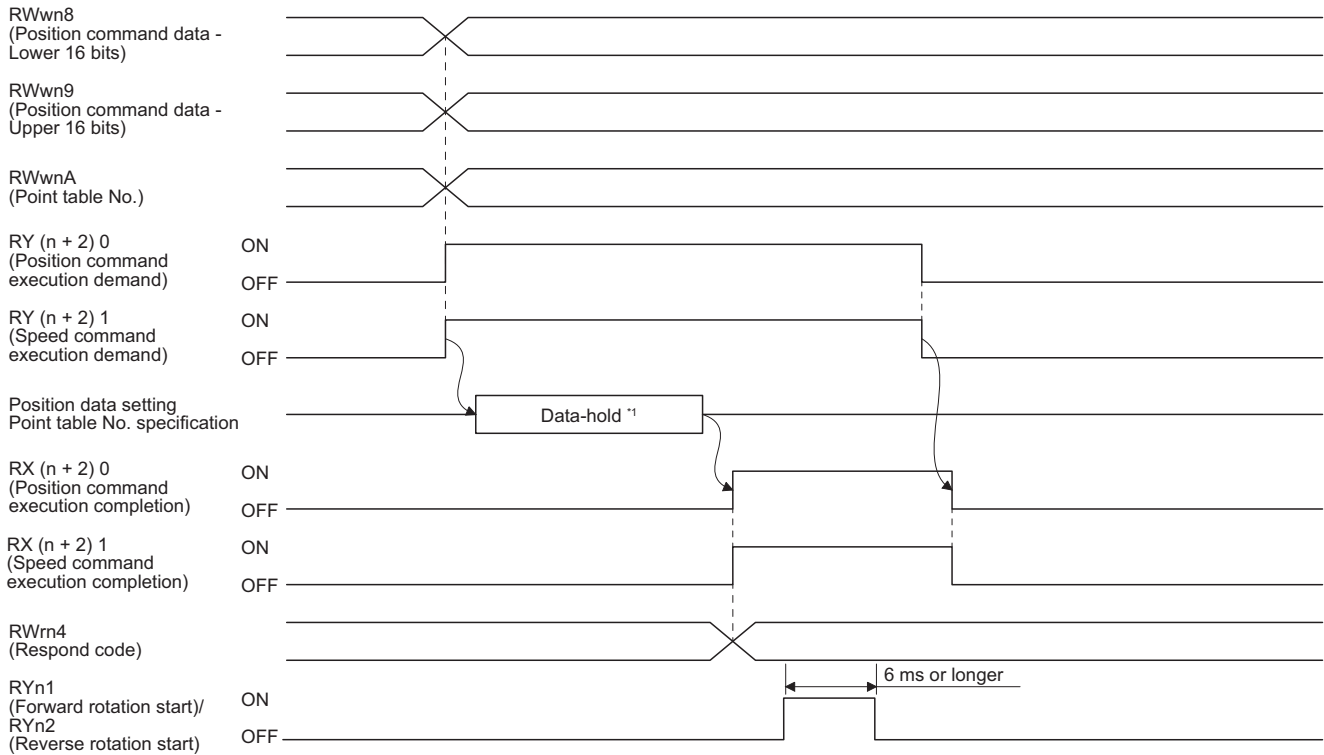

\*1 This data is stored in the RAM of the servo amplifier. Thus, the data is cleared when the power supply is shut off.

Set the lower 16 bits of the position command data in RWwn8 (Position command data - Lower 16 bits), the upper 16 bits of the position command data in RWwn9 (Position command data - Upper 16 bits). Set the point table No. for the speed command in RWwnA (Point table No.), and then turn on RY (n + 2) 0 (Position command execution demand) and RY (n + 2) 1 (Speed command execution demand).

Turning on RY (n + 2) 0 and RY (n + 2) 1 stores the position command data and point table No. into the RAM of the servo amplifier.

When the data is stored, RX (n + 2) 0 (Position command execution completion) and RX (n + 2) 1 (Speed command execution completion) turn on.

Until RX (n + 2) 0 and RX (n + 2) 1 turn on after RY (n + 2) 0 and RY (n + 2) 1 are turned on, do not change the settings of the position data and point table No.

If data outside the setting range is set in RWwn8 (Position command data - Lower 16 bits), RWwn9 (Position command data - Upper 16 bits), or RWwnA (Point table No.), an error code (👉 Page 43 Respond code (RWrn4)) is set in respond code.

Turn on RYn1 (Forward rotation start) or RYn2 (Reverse rotation start) after RX (n + 2) 0 (Position command execution completion) and RX (n + 2) 1 (Speed command execution completion) have turned on.

## For the position command data setting and speed command data setting

Specify a position address and servo motor speed with remote registers, and execute positioning. At this time, the acceleration time constant and deceleration time constant set in point table No. 1 are used.

Before executing positioning, set "\_\_\_2" in [Pr. PT62] to enable the operation that follows the settings of the position command data and speed command data.

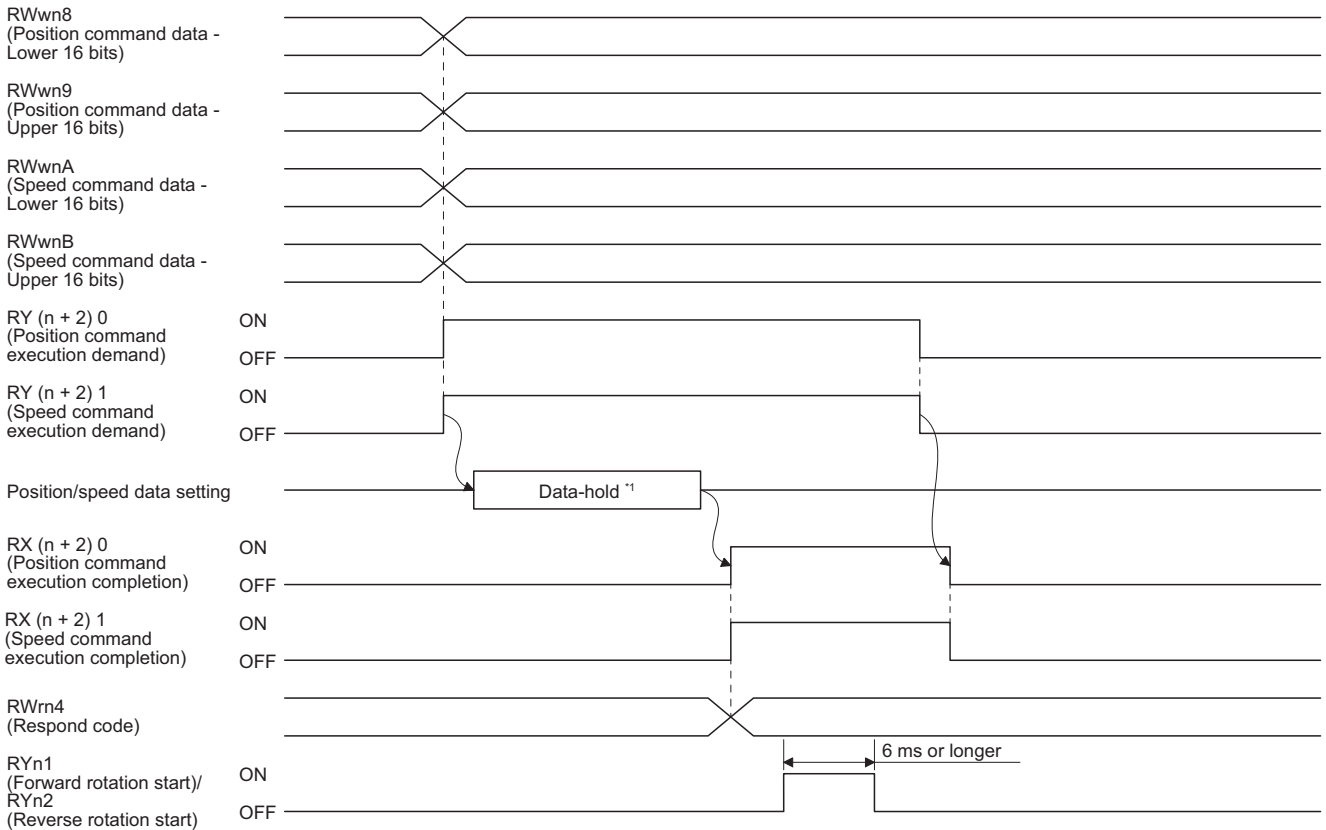

\*1 This data is stored in the RAM of the servo amplifier. Thus, the data is cleared when the power supply is shut off.

Set the lower 16 bits of the position command data in RWwn8 (Position command data - Lower 16 bits), the upper 16 bits of the position command data in RWwn9 (Position command data - Upper 16 bits), the lower 16 bits of the speed command in RWwnA (Speed command data - Lower 16 bits), and the upper 16 bits of the speed command in RWwnB (Speed command data - Upper 16 bits). Then, turn on RY (n + 2) 0 (Position command execution demand) and RY (n + 2) 1 (Speed command execution demand).

Turning on RY (n + 2) 0 and RY (n + 2) 1 stores the position command data and speed command data into the RAM of the servo amplifier.

When the data is stored, RX (n + 2) 0 (Position command execution completion) and RX (n + 2) 1 (Speed command execution completion) turn on.

If data outside the setting range is set in RWwn8 (Position command data - Lower 16 bits), RWwn9 (Position command data - Upper 16 bits), RWwnA (Speed command data - Lower 16 bits), or RWwnB (Speed command data - Upper 16 bits), an error code (Page 43 Respond code (RWrn4)) is set in respond code.

Turn on RYn1 (Forward rotation start) or RYn2 (Reverse rotation start) after RX (n + 2) 0 (Position command execution completion) and RX (n + 2) 1 (Speed command execution completion) have turned on.

## 2.2 Switching power on for the first time

### Point

To use the servo amplifier in the I/O mode, set [Pr. PN03] to "\_\_\_1". In addition, the GX Works setting is required. For the GX Works setting, refer to section 4.1 of "MR-J4-\_GF\_(-RJ) Servo Amplifier Instruction Manual (Motion Mode)".

When switching the power on for the first time, follow this section to make a startup.

#### 1. Wiring check

Check whether the servo amplifier and servo motor are wired correctly by visual inspection, the DO forced output function (section 4.5 of "MR-J4-\_GF\_(-RJ) Servo Amplifier Instruction Manual (Motion Mode)"), etc. (Refer to section 4.1 of "MR-J4-\_GF\_(-RJ) Servo Amplifier Instruction Manual (Motion Mode)".)

#### 2. Surrounding environment check

Check the surrounding environment of the servo amplifier and servo motor. (Refer to section 4.1 of "MR-J4-\_GF\_(-RJ) Servo Amplifier Instruction Manual (Motion Mode)".)

#### 3. Station No. setting

Set the station number with the station number setting rotary switch (SW2/SW3). (Refer to section 4.3 of "MR-J4-\_GF\_(-RJ) Servo Amplifier Instruction Manual (Motion Mode)".)

#### 4. Parameter setting

Set the parameters as necessary, such as the used operation mode and regenerative option selection. (Page 125 PARAMETERS)

Perform setting of [Pr. PN02 Communication error detection time] in accordance with the network topology and the link scan time of the master station.

Set [Pr. PD41] to "\_0\_" (Stroke limit always enabled).

To input a stroke limit by using the link device, set [Pr. PD41] to "1\_\_\_" (input from controller).

Hereafter, instructions are provided in a case where the input from the controller is selected. When [Pr. PD41] is set to "0\_\_\_" (input from servo amplifier), read the words "upper stroke limit" and "lower stroke limit" as "LSP" and "LSN", respectively.

#### 5. Test operation of the servo motor alone in JOG operation of test operation mode

With the servo motor disconnected from the machine, perform test operation mode at the slowest speed to check whether the servo motor rotates correctly. For the test operation mode, refer to section 4.5 of "MR-J4-\_GF\_(-RJ) Servo Amplifier Instruction Manual (Motion Mode)".

#### 6. Test operation of the servo motor alone in manual operation mode

Make sure that the servo motor rotates in the following procedure.

① Switch on EM2 (Forced stop 2) and RYn0 (Servo-on). When the servo amplifier is in a servo-on status, RXn0 (Ready) switches on.

② Switch on RY (n + 1) 0 (Upper stroke limit) and RY (n + 1) 1 (Lower stroke limit).

③ When RYn6 (Automatic/manual selection) is switched off from the controller and RYn1 (Forward rotation start) or RYn2 (Reverse rotation start) is switched on in the manual operation mode, the servo motor starts rotating. Set a low speed in [Pr. PT65 Jog speed command] first, make the servo motor operate, and check the rotation direction of the motor, etc. If the servo motor does not operate in the intended direction, check the input signal.

## 7. Test operation with the servo motor and machine connected

Make sure that the servo motor rotates in the following procedure.

- ❶ Switch on EM2 (Forced stop 2) and RYn0 (Servo-on). When the servo amplifier is in a servo-on status, RXn0 (Ready) switches on.
- ❷ Switch on RY (n + 1) 0 (Upper stroke limit) and RY (n + 1) 1 (Lower stroke limit).
- ❸ When RYn6 (Automatic/manual selection) is switched off from the controller and RYn1 (Forward rotation start) or RYn2 (Reverse rotation start) is switched on in the manual operation mode, the servo motor starts rotating. Set a low speed in [Pr. PT65 Jog speed command] first, make the servo motor operate, and check the operation direction of the machine, etc. If the servo motor does not operate in the intended direction, check the input signal. In the status display, check for any problems of the servo motor speed, load ratio, etc.

## 8. Automatic operation by the point table

Check automatic operation from the controller.

## 9. Gain adjustment

Make gain adjustment to optimize the machine motions. (Refer to chapter 6 of "MR-J4- \_GF\_(-RJ) Servo Amplifier Instruction Manual (Motion Mode)".)

## 10. Actual operation

## 11. Stop

Stop giving commands and stop operation.

## 2.3 Automatic operation mode

### Command method

Set point tables in advance, and select any point table by using CC-Link IE Field Network communication. Start the operation using RYn1 (Forward rotation start) or RYn2 (Reverse rotation start). Absolute value command method and incremental value command method are provided in automatic operation mode.

#### Absolute value command method

As position data, set the target address to be reached.

##### ■mm, inch, and pulse units

Setting range: -999999 to 999999 [ $\times 10^{\text{STM}}$   $\mu\text{m}$ ] (STM = Feed length multiplication [Pr. PT03])  
-999999 to 999999 [ $\times 10^{(\text{STM}-4)}$  inch] (STM = Feed length multiplication [Pr. PT03])  
-999999 to 999999 [pulse]

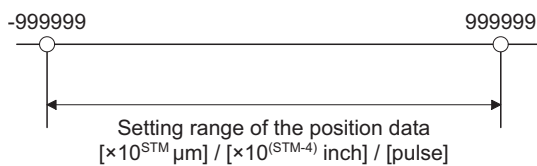

##### ■Degree unit

Set the target position using the positive value as the CCW direction and the negative value as the CW direction.

When specifying the direction with the absolute value, you can use "+" or "-" to specify the rotation direction.

The following shows an example of setting.

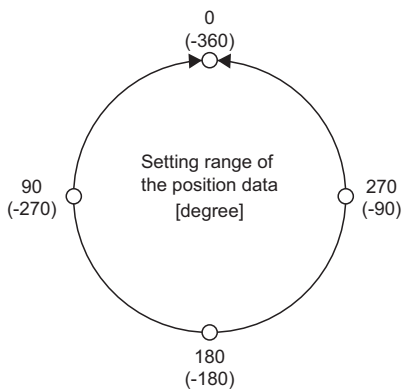

- The coordinate system in degree unit

The coordinate is determined based on the position of 0 degree.

Positive direction: 0 → 90 → 180 → 270 → 0

Negative direction: 0 → -90 → -180 → -270 → -360

270 degrees and -90 degrees are the same position.

0 degree, 360 degrees, and -360 degrees are the same position.

The travel direction toward the target position is the direction set in [Pr. PT03].

[Pr. PT03] setting	Servo motor rotation direction
_ 0 _ _	Rotates to the target position in the direction specified with the sign of the position data.
_ 1 _ _	Rotates in the direction with the shorter distance from the current position to the target position. If the distance from the current position to the target position is the same in the CCW and CW directions, the servo motor rotates in the CCW direction.
_ 2 _ _	Rotates in the address decreasing direction regardless of the sign of the position data.
_ 3 _ _	Rotates in the address increasing direction regardless of the sign of the position data.

- When using the servo motor with the rotation direction specified ([Pr. PT03] = \_ 0 \_ \_)

When the position data 270.000 degrees (target position) is specified, the servo motor rotates in the CCW direction.

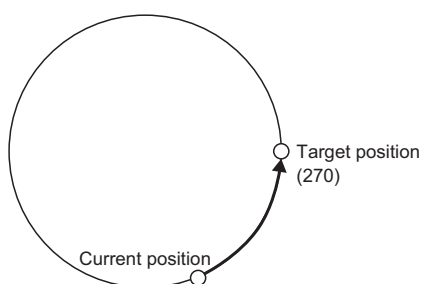

When the position data -90.000 degrees (target position) is specified, the servo motor rotates in the CW direction.

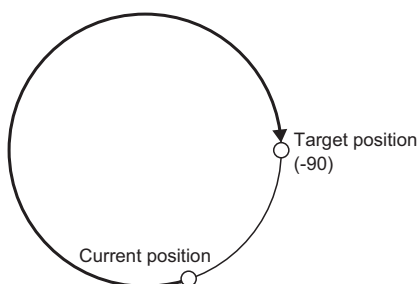

When the position data -360.000 degrees (target position) is specified, the servo motor rotates in the CW direction. (A)

When the position data 360.000 degrees or 0 degree is specified, the servo motor rotates in the CCW direction. (B)

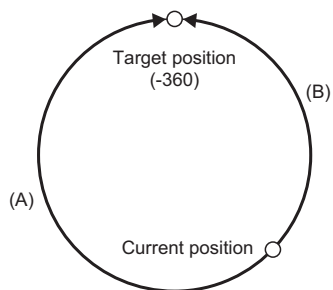

- When using the servo motor with the shortest rotation specified ([Pr. PT03] = \_ 1 \_ \_)

When the position data 270.000 degrees (target position) is specified, the servo motor rotates in the CCW direction.

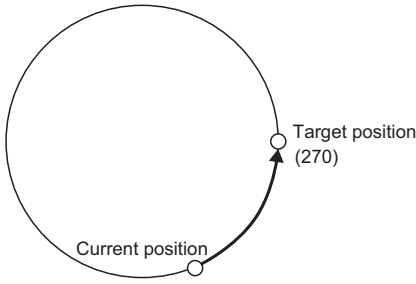

When the position data -90.000 degrees (target position) is specified, the servo motor rotates in the CCW direction.

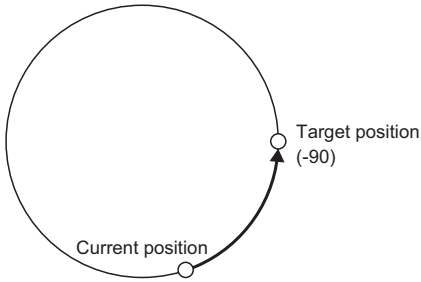

If the position data 270.000 degrees (target position) is specified while the current position is at 90, the servo motor rotates in the CCW direction since the distance is the same in the CCW and CW directions.

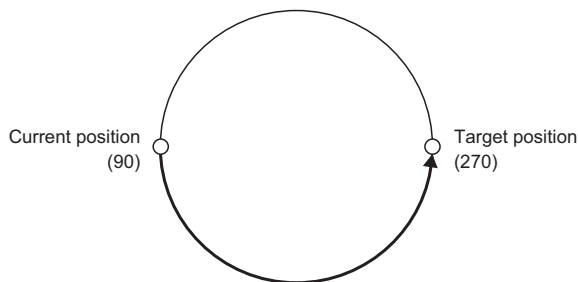

- When using the servo motor with the address decreasing direction specified ([Pr. PT03] = \_ 2 \_ \_)

When the position data 270.000 degrees (target position) is specified, the servo motor rotates in the CCW direction.

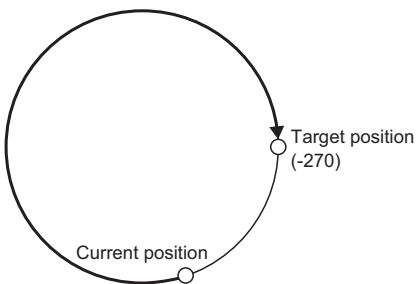

When the position data -270.000 degrees (target position) is specified, the servo motor rotates in the CW direction.

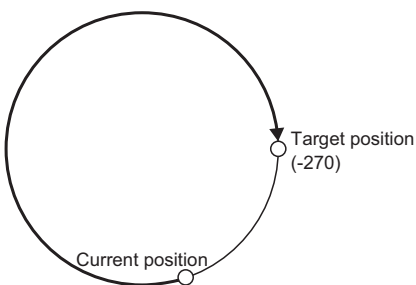



- When using the servo motor with the address increasing direction specified ([Pr. PT03] = \_ 3 \_ \_)

When the position data 270.000 degrees (target position) is specified, the servo motor rotates in the CCW direction.

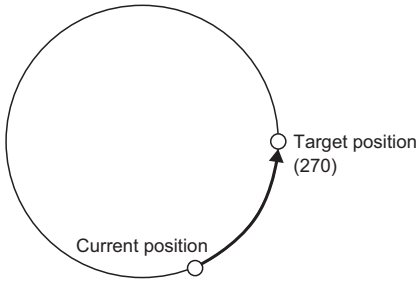

When the position data -270.000 degrees (target position) is specified, the servo motor rotates in the CCW direction.

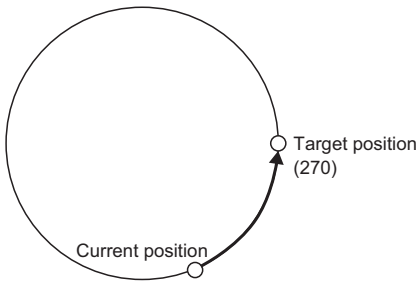

### Incremental value command method

As position data, set the travel distance from the current address to the target address.

#### ■mm, inch, and pulse units

- Setting range: 0 to 999999 [ $\times 10^{STM}$   $\mu\text{m}$ ] (STM = Feed length multiplication [Pr. PT03])
- 0 to 999999 [ $\times 10^{(STM-4)}$  inch] (STM = Feed length multiplication [Pr. PT03])
- 0 to 999999 [pulse]

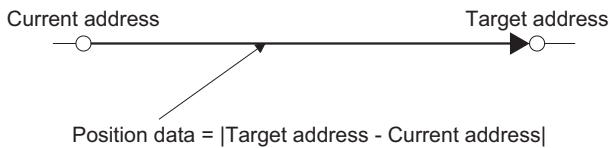

#### ■Degree unit

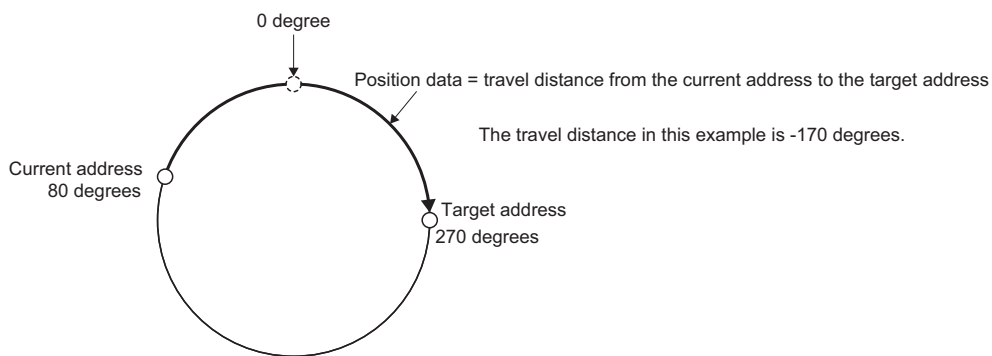

# Automatic operation using point table

## Absolute value command method

By the auxiliary function of the point table, you can set a point table used under the absolute value command method or the incremental value command method.

### Point table

Set the point table values using MR Configurator2 or link devices.

Set the position data, servo motor speed, acceleration time constant, deceleration time constant, dwell and auxiliary function to the point table.

To use the point table under the absolute value command method, set "0", "1", "8", or "9" to the auxiliary function. To use the point table under the incremental value command method, set "2", "3", "10", or "11" to the auxiliary function.

When you set a value outside this range to the point table, the set value will be clamped with the maximum or minimum value.

When changing the command unit or the connected motor results in the set value outside this range, [AL. 37] will occur.

Item	Setting range	Unit	Description
Position data	-999999 to 999999 *1	$\times 10^{\text{STM}} \mu\text{m}$ $\times 10^{(\text{STM}-4)} \text{inch}$ $\times 10^{-3} \text{degree}$ pulse	<ul style="list-style-type: none"> <li>When using this point table under the absolute value command method Set the target address (absolute value).</li> <li>When using this point table under the incremental value command method Set the travel distance. A "-" sign indicates a reverse rotation command.</li> </ul>
Servo motor speed	0 to permissible speed	0.01 r/min 0.01 mm/s *2	Set the command speed of the servo motor for execution of positioning. The setting value must be within the permissible instantaneous speed of the servo motor used. The setting value will be rounded down to the nearest integer.
Acceleration time constant	0 to 20000	ms	Set a time until the servo motor rotates at the rated speed.
Deceleration time constant	0 to 20000	ms	Set a time from when the servo motor rotates at the rated speed until when the motor stops.
Dwell	0 to 20000	ms	Set the dwell. To disable the dwell, set "0" or "2" to the auxiliary function. To perform continuous operation, set "1", "3", "8", "9", "10" or "11" to the auxiliary function and 0 to the dwell. When the dwell is set, the position command of the selected point table is completed, and after the set dwell has elapsed, the position command of the next point table is started.
Auxiliary function	0 to 3, 8 to 11	—	Set the auxiliary function. ■When using this point table under the absolute value command method 0: Automatic operation is performed in accordance with a single point table selected. 1: Automatic continuous operation is performed to the next point table without a stop. 8: Automatic continuous operation is performed without a stop to the point table selected at start-up. 9: Automatic continuous operation is performed without stopping a point table No. 1. ■When using this point table under the incremental value command method 2: Automatic operation is performed in accordance with a single point table selected. 3: Automatic continuous operation is performed to the next point table without a stop. 10: Automatic continuous operation is performed to the point table selected at start-up. 11: Automatic continuous operation is performed without stopping a point table No. 1. When a different rotation direction is set, smoothing zero (command output) is confirmed and then the rotation direction is reversed. Setting "1" or "3" to point table No. 255 results in an error. ☞ Page 62 Automatic continuous positioning operation

\*1 When " $\mu\text{m}$ " or "inch" is set, the positions of the decimal points will be changed by the STM setting. When "degree" is set, the setting range is -360.000 to 360.000.

\*2 In the linear servo motor control mode, the unit is mm/s.

## Parameter setting

Set the following parameters to perform automatic operation.

- Command method selection ([Pr. PT01])

Select the absolute value command method as shown below.

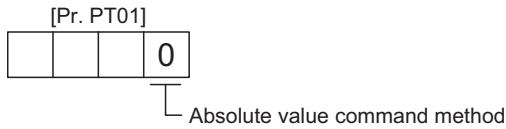

- Rotation direction selection ([Pr. PA14])

Select the servo motor rotation direction when RYn1 (Forward rotation start) is switched on.

[Pr. PA14] setting	Servo motor rotation direction when RYn1 (Forward rotation start) is switched on
0	CCW rotation with - position data CW rotation with + position data
1	CW rotation with + position data CCW rotation with - position data

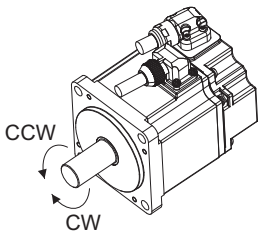

- Position data unit ([Pr. PT01])

Set the unit of the position data.

[Pr. PT01] setting	Position data unit
_ 0 _ _	mm
_ 1 _ _	inch
_ 2 _ _	degree
_ 3 _ _	pulse

- Feed length multiplication ([Pr. PT03])

Set the feed length multiplication (STM) of the position data.

[Pr. PT03] setting	Position data input range *2			
	[mm]	[inch]	[degree] *1	[pulse] *1
___ 0	- 999.999 to + 999.999	- 99.9999 to + 99.9999	-360.000 to 360.000	- 999999 to + 999999
___ 1	- 9999.99 to + 9999.99	- 999.999 to + 999.999		
___ 2	- 99999.9 to + 99999.9	- 9999.99 to + 9999.99		
___ 3	- 999999 to + 999999	- 99999.9 to + 99999.9		

\*1 The feed length multiplication setting ([Pr. PT03]) is not applied to the unit multiplication factor.

Adjust the unit multiplication factor in the electronic gear setting ([Pr. PA06] and [Pr. PA07]).

\*2 The "-" sign has different meanings under the absolute value command method and the incremental value command method.

☞ Page 52 Command method

## Operation

Selecting RWwn6 for the point table and switching on RYn1 starts positioning to the position data at the set speed, acceleration time constant and deceleration time constant. At this time, RYn2 (Reverse rotation start) is invalid.

Item	Used device	Setting
Automatic operation mode selection	RYn6 (Automatic/manual selection)	Switch on RYn6.
Point table selection	RWwn6 (Point table No. selection)	Set the point table No. to use.
Start	RYn1 (Forward rotation start)	Switch on RYn1 to start.

## Incremental value command method

### Point

The incremental value command method ([Pr. PT01] = \_\_\_ 1) is not available in the absolute position detection system. When using the absolute position detection system, select the absolute value command method ([Pr. PT01] = \_\_\_ 0).

Making the servo-off state in the incremental value command method ([Pr. PT01] = \_\_\_ 1) will erase the home position. Execute home position return again.

### Point table

Set the point table values using MR Configurator2 or link devices.

Set the position data, servo motor speed, acceleration time constant, deceleration time constant, dwell and auxiliary function to the point table.

When you set a value outside this range to the point table, the set value will be clamped with the maximum or minimum value.

When changing the command unit or the connected motor results in the set value outside the setting range, [AL. 37] will occur.

Item	Setting range	Unit	Description
Position data	0 to 999999 *1	$\times 10^{\text{STM}}$ $\mu\text{m}$ $\times 10^{(\text{STM}-4)}$ inch $\times 10^{-3}$ degree pulse	Set the travel distance. The unit can be changed by [Pr. PT03] (Feed length multiplication).
Servo motor speed	0 to permissible speed	0.01 r/min 0.01 mm/s *2	Set the command speed of the servo motor for execution of positioning. The setting value must be within the permissible instantaneous speed of the servo motor used. The fractional portion will be rounded down.
Acceleration time constant	0 to 20000	ms	Set a time until the servo motor rotates at the rated speed.
Deceleration time constant	0 to 20000	ms	Set a time from when the servo motor rotates at the rated speed until when the motor stops.
Dwell	0 to 20000	ms	Set the dwell. To disable the dwell, set "0" to the auxiliary function. To perform continuous operation, set "1", "8" or "9" to the auxiliary function and 0 to the dwell. When the dwell is set, the position command of the selected point table is completed, and after the set dwell has elapsed, the position command of the next point table is started.
Auxiliary function	0, 1, 8, or 9	—	Set the auxiliary function. 0: Automatic operation is performed in accordance with a single point table selected. 1: Automatic continuous operation is performed to the next point table without a stop. 8: Automatic continuous operation is performed without a stop to the point table selected at start-up. 9: Automatic continuous operation is performed without stopping a point table No. 1. Setting "1" to point table No. 255 results in an error.  Page 62 Automatic continuous positioning operation

\*1 When " $\mu\text{m}$ " or "inch" is set, the positions of the decimal points will be changed by the STM setting. When "degree" is set, the setting range is -360.000 to 360.000.

\*2 In the linear servo motor control mode, the unit is mm/s.

## Parameter setting

Set the following parameters to perform automatic operation.

- Command method selection ([Pr. PT01])

Select the incremental value command method as shown below.

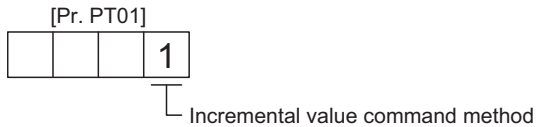

- Rotation direction selection ([Pr. PA14])

Select the servo motor rotation direction when RYn1 (Forward rotation start) or RYn2 (Reverse rotation start) is switched on.

[Pr. PA14] setting	Servo motor rotation direction	
	RYn1 (Forward rotation start)	RYn2 (Reverse rotation start)
0	CCW rotation (address increase)	CW rotation (address decrease)
1	CW rotation (address increase)	CCW rotation (address decrease)

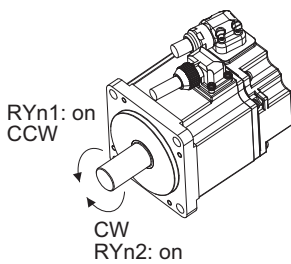

[Pr. PA14]: 0

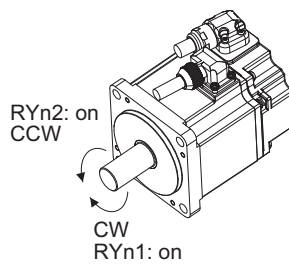

[Pr. PA14]: 1

- Position data unit ([Pr. PT01])

Set the unit of the position data.

[Pr. PT01] setting	Position data unit
_ 0 _ _	mm
_ 1 _ _	inch
_ 2 _ _	degree
_ 3 _ _	pulse

- Feed length multiplication ([Pr. PT03])

Set the feed length multiplication (STM) of the position data.

[Pr. PT03] setting	Position data input range			
	[mm]	[inch]	[degree] *1	[pulse] *1
_ _ _ 0	0 to + 999.999	0 to + 99.9999	0 to + 999.999	0 to + 999999
_ _ _ 1	0 to + 9999.99	0 to + 999.9999		
_ _ _ 2	0 to + 99999.9	0 to + 9999.99		
_ _ _ 3	0 to + 999999	0 to + 99999.9		

\*1 The feed length multiplication setting ([Pr. PT03]) is not applied to the unit multiplication factor. Adjust the unit multiplication factor in the electronic gear setting ([Pr. PA06] and [Pr. PA07]).

## ■ Operation

Selecting RWwn6 for the point table and switching on RYn1 starts a forward rotation of the motor over the travel distance of the position data at the set speed, acceleration time constant and deceleration time constant.

Switching on RYn2 starts a reverse rotation of the motor in accordance with the values set to the selected point table.

When the positioning operation is performed consecutively under the incremental value command method, the servo motor rotates in the same direction only.

To change the travel direction during continuous operation, perform the operation under the absolute value command method.

Item	Used device	Setting
Automatic operation mode selection	RYn6 (Automatic/manual selection)	Switch on RYn6.
Point table selection	RWwn6 (Point table No. selection)	Set the point table No. to use.
Start	RYn1 (Forward rotation start) RYn2 (Reverse rotation start)	Switch on RYn1 to start. Switch on RYn2 to start.

## Automatic operation timing chart

### ■ Automatic individual positioning operation

- Absolute value command method ([Pr. PT01] = \_\_\_ 0)

While the servo motor is stopped under servo-on state, switching on RYn1 (Forward rotation start) starts the automatic positioning operation.

The following shows a timing chart.

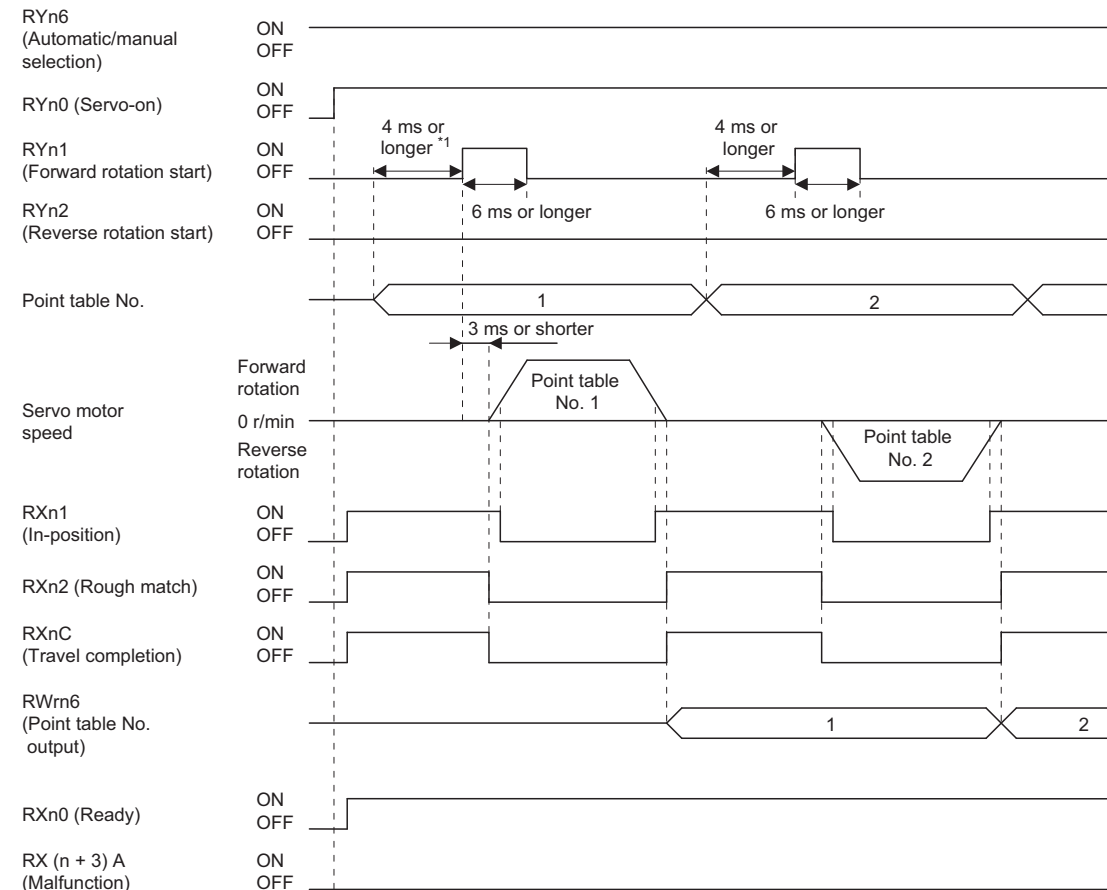

\*1 The detection of external input signals is delayed by the set time in the input filter setting of [Pr. PD11].

Considering the output signal sequence from the controller and signal variations due to hardware, configure a sequence that changes the point table selection earlier.

- Incremental value command method ([Pr. PT01] = \_\_\_ 1)

While the servo motor is stopped under servo-on state, switching on RYn1 (Forward rotation start) or RYn2 (Reverse rotation start) starts the automatic positioning operation.

The following shows a timing chart.

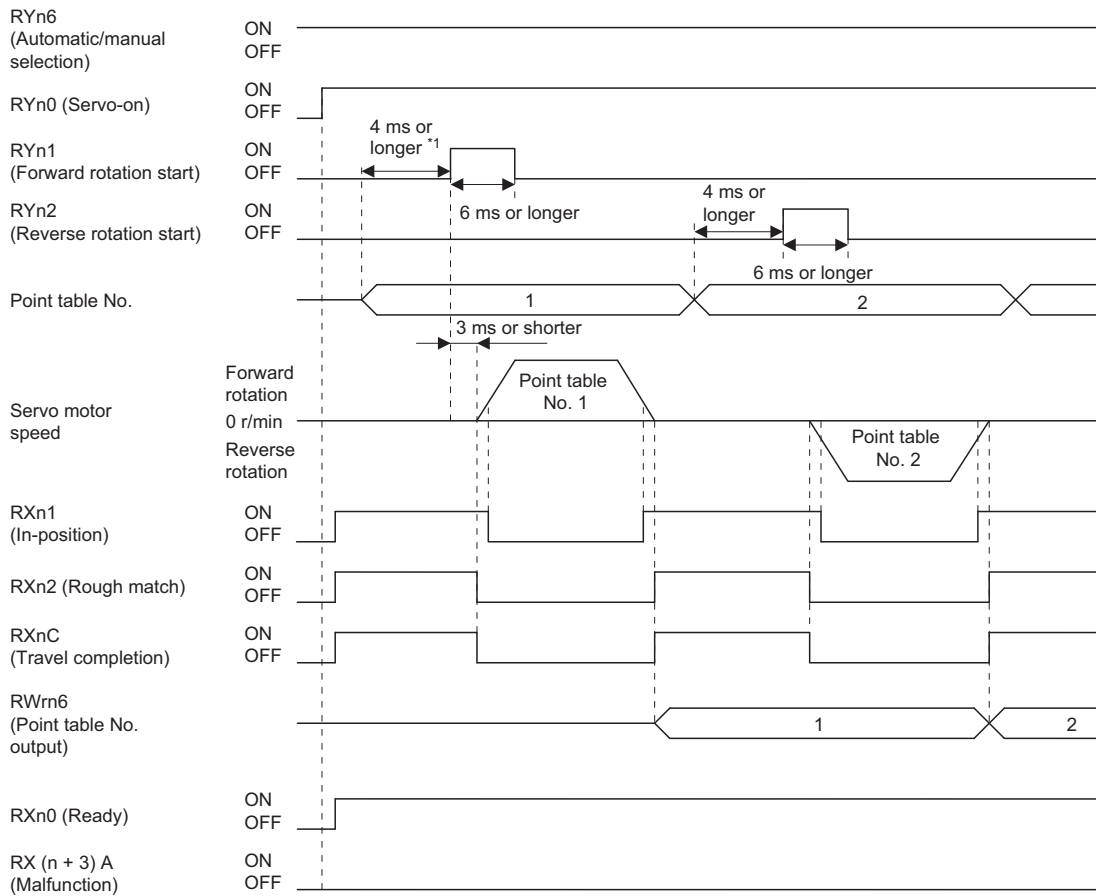

\*1 The detection of external input signals is delayed by the set time in the input filter setting of [Pr. PD11].  
Considering the output signal sequence from the controller and signal variations due to hardware, configure a sequence that changes the point table selection earlier.

## ■Automatic continuous positioning operation

By merely selecting a point table and switching on RYn1 (Forward rotation start) or RYn2 (Reverse rotation start), the operation can be performed in accordance with the point tables having consecutive numbers.

Absolute value command method ([Pr. PT01] = 0)

By specifying the absolute value command or the incremental value command in the auxiliary function of the point table, the automatic continuous operation can be performed.

The following shows how to set.

Point table setting		
Dwell	Auxiliary function	
	When position data is absolute value	When position data is incremental value
1 or more	1	3



• Positioning in a single direction

The following shows an operation example with the set values listed in the table below.

In this example, point table No. 1 and point table No. 3 are under the absolute value command method, and point table No. 2 is under the incremental value command method.

Point table No.	Position data [10 <sup>STM</sup> μm]	Servo motor speed [r/min]	Acceleration time constant [ms]	Deceleration time constant [ms]	Dwell [ms]	Auxiliary function
1	5.00	3000.00	100	150	100	1
2	5.00	2000.00	150	200	200	3
3	15.00	1000.00	300	100	Disabled	0 <sup>*1</sup>

\*1 Always set "0" or "2" to the auxiliary function of the last point table among the consecutive point tables.  
 0: When using the point table under the absolute value command method  
 2: When using the point table under the incremental value command method

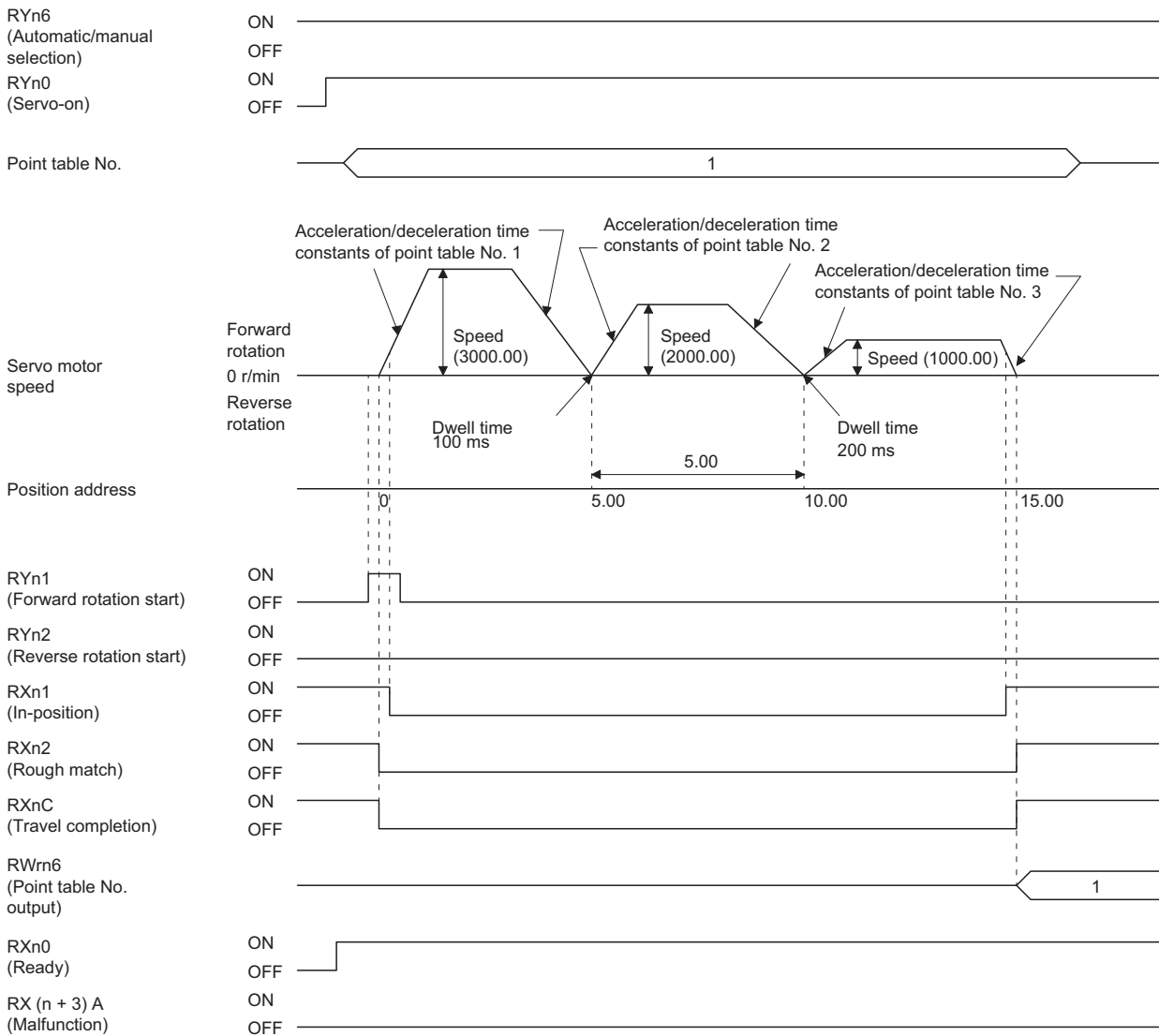

- Positioning in the reverse direction midway

The following shows an operation example with the set values listed in the table below.

In this example, point table No. 1 and point table No. 3 are under the absolute value command method, and point table No. 2 is under the incremental value command method.

Point table No.	Position data [10 <sup>STM</sup> μm]	Servo motor speed [r/min]	Acceleration time constant [ms]	Deceleration time constant [ms]	Dwell [ms]	Auxiliary function
1	5.00	3000.00	100	150	100	1
2	7.00	2000.00	150	200	200	3
3	8.00	1000.00	300	100	Disabled	0 <sup>*1</sup>

\*1 Always set "0" or "2" to the auxiliary function of the last point table among the consecutive point tables.

- 0: When using the point table under the absolute value command method
- 2: When using the point table under the incremental value command method

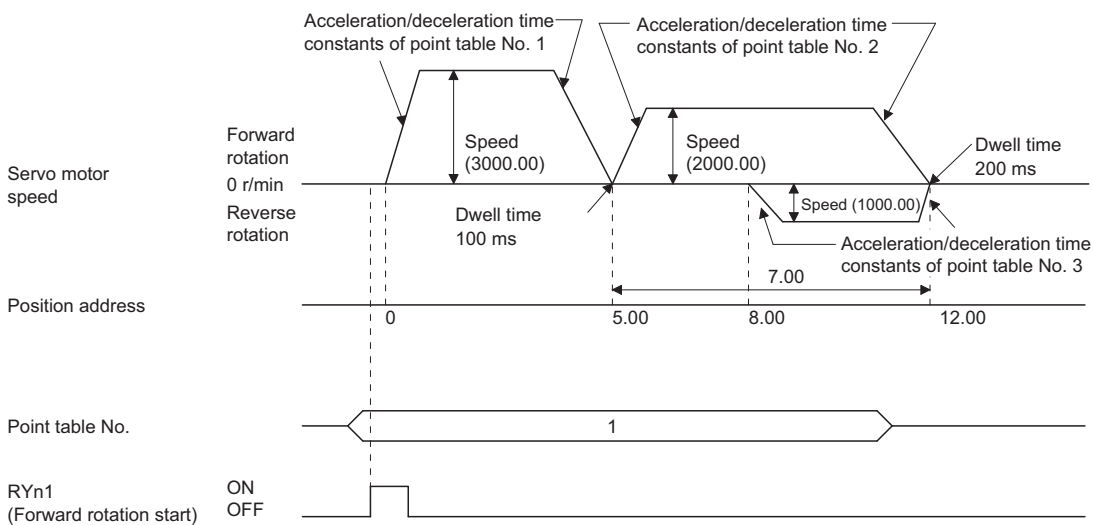

RYn1 (In-position), RYn2 (Rough match), and RYnC (Travel completion) turn on when the point table No. 3 finishes. RWm6 (Point table No. output 1) is also set when the point table No. 3 finishes.

For details of the operation timing for the signals, refer to "Positioning in a single direction".

- When the position data is in degree unit

The following shows an operation example with the set values listed in the table below.

In this example, point table No. 1, No. 2, and No. 4 are under the absolute value command method, and point table No. 3 is under the incremental value command method.

Point table No.	Position data [degree]	Servo motor speed [r/min]	Acceleration time constant [ms]	Deceleration time constant [ms]	Dwell [ms]	Auxiliary function
1	120.000	1000.00	100	150	100	1
2	-320.000	500.00	150	100	200	1
3	-230.000	3000.00	200	300	150	3
4	70.000	1500.00	300	100	Disabled	0 <sup>*1</sup>

\*1 Always set "0" or "2" to the auxiliary function of the last point table among the consecutive point tables.

- 0: When using the point table under the absolute value command method
- 2: When using the point table under the incremental value command method

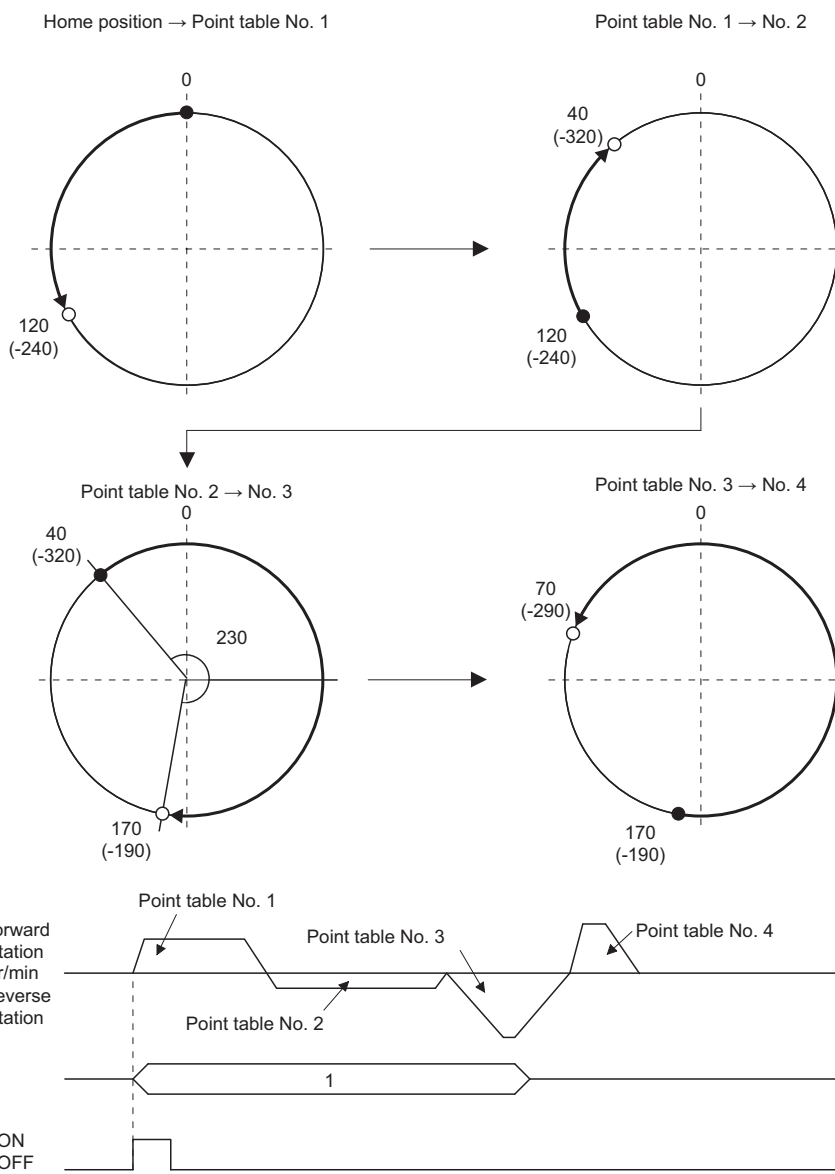

RYn1 (In-position), RYn2 (Rough match), and RYnC (Travel completion) turn on when the point table No. 3 finishes. RWrn6 (Point table No. output 1) is also set when the point table No. 3 finishes.

For details of the operation timing for the signals, refer to "Positioning in a single direction".

Incremental value command method ([Pr. PT01] = 1)

The position data of the incremental value command method is the sum of the position data of consecutive point tables. The following shows how to set.

Point table setting	
Dwell	Auxiliary function
1 or more	1

• Positioning in a single direction

The following shows an operation example with the set values listed in the table below.

Point table No.	Position data [10 <sup>STM</sup> μm]	Servo motor speed [r/min]	Acceleration time constant [ms]	Deceleration time constant [ms]	Dwell [ms]	Auxiliary function
1	5.00	3000.00	100	150	100	1
2	6.00	2000.00	150	200	200	1
3	3.00	1000.00	300	100	Disabled	0*1

\*1 Always set "0" to the auxiliary function of the last point table among the consecutive point tables.

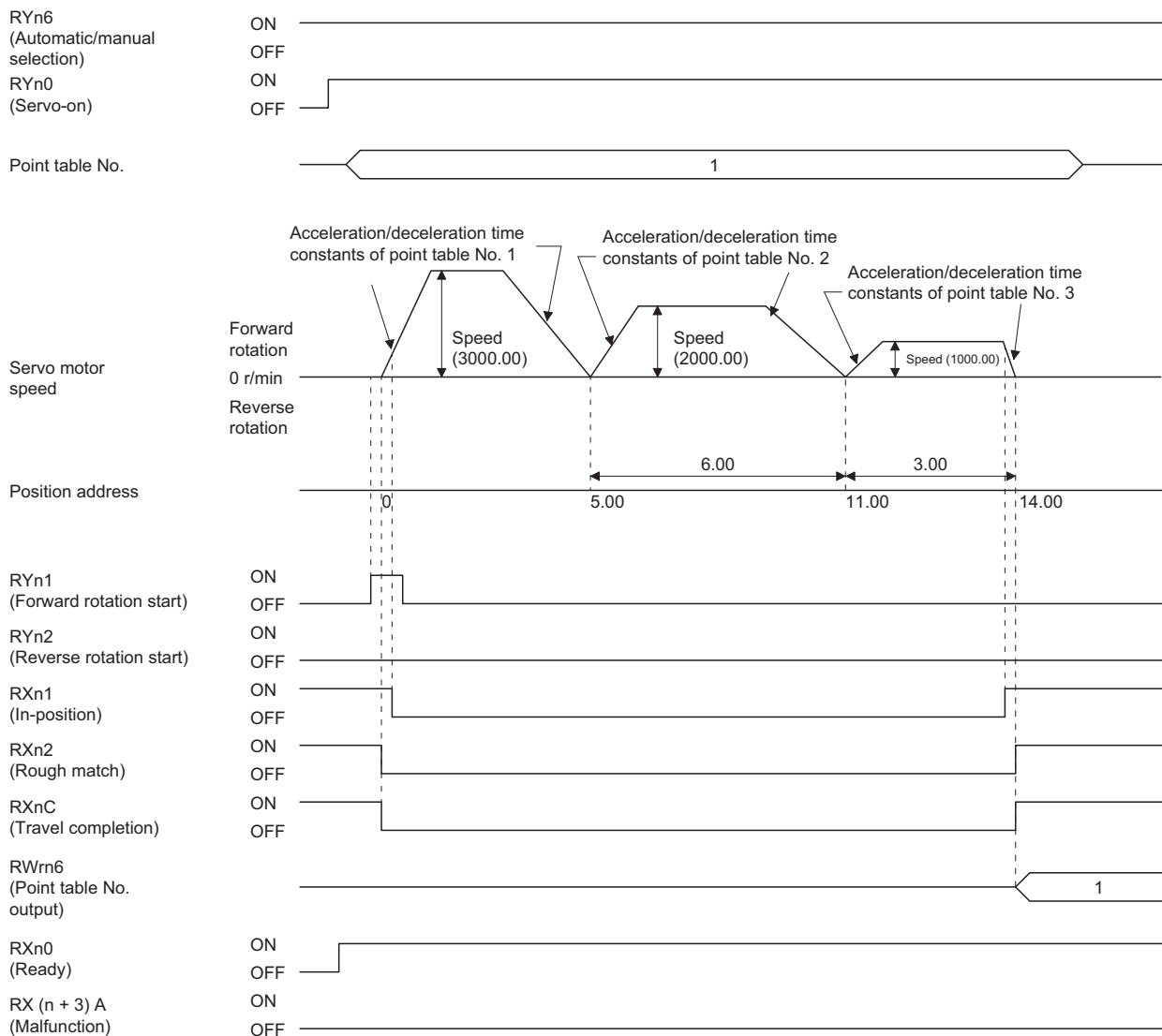

\*1 Switching on RYn2 (Reverse rotation start) starts positioning in the reverse rotation direction.

- When the position data is in degree unit

The following shows an operation example with the set values listed in the table below.

Point table No.	Position data [degree]	Servo motor speed [r/min]	Acceleration time constant [ms]	Deceleration time constant [ms]	Dwell [ms]	Auxiliary function
1	120.000	3000.00	100	150	0	1
2	60.000	1500.00	150	100	0	1
3	90.000	1000.00	300	100	Disabled	0 <sup>*1</sup>

- \*1 Always set "0" or "2" to the auxiliary function of the last point table among the consecutive point tables.  
 0: When using the point table under the absolute value command method  
 2: When using the point table under the incremental value command method

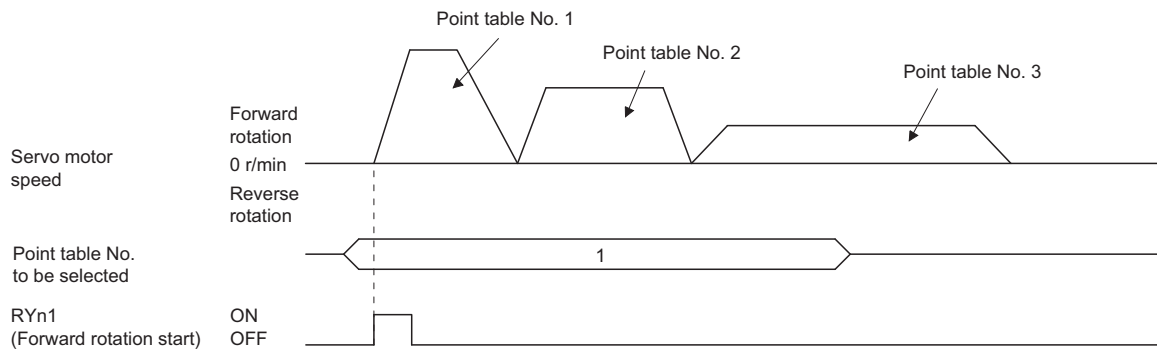
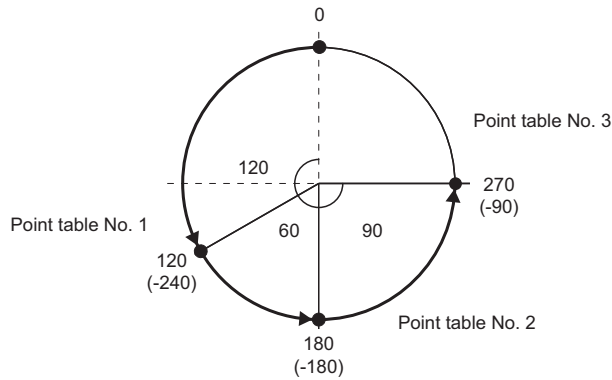

RYn1 (In-position), RYn2 (Rough match), and RYnC (Travel completion) turn on when the point table No. 3 finishes. RWm6 (Point table No. output 1) is also set when the point table No. 3 finishes.

For details of the operation timing for the signals, refer to "Positioning in a single direction".

## ■ Varying-speed operation

By setting the auxiliary function of the point table, the servo motor speed during positioning can be changed. Point tables are used by the number of the set speed.

Absolute value command method ([Pr. PT01] = 0)

Set "1" or "3" to the auxiliary function to execute the positioning at the speed set in the following point table.

At this time, the position data selected at start is valid, and the acceleration/deceleration time constant set in the next and subsequent point tables is invalid.

By setting "1" or "3" to sub functions until point table No. 254, the operation can be performed at maximum 255 speeds.

Always set "0" or "2" to the auxiliary function of the last point table.

To perform varying-speed operation, always set "0" to the dwell.

Setting "1" or more will enable the automatic continuous positioning operation.

The following table shows an example of setting.

Point table No.	Dwell [ms] <sup>*1</sup>	Auxiliary function	Varying-speed operation
1	0	1	Consecutive point table data
2	0	3	
3	Disabled	0 <sup>*2</sup>	
4	0	3	Consecutive point table data
5	0	1	
6	Disabled	2 <sup>*2</sup>	

\*1 Always set "0".

\*2 Always set "0" or "2" to the auxiliary function of the last point table among the consecutive point tables.

- Positioning in a single direction

The following shows an operation example with the set values listed in the table below.

In this example, point table No. 1 and point table No. 3 are under the absolute value command method, and point table No. 2 is under the incremental value command method.

Point table No.	Position data [10 <sup>STM</sup> μm]	Servo motor speed [r/min]	Acceleration time constant [ms]	Deceleration time constant [ms]	Dwell [ms] *1	Auxiliary function
1	5.00	3000.00	100	150	0	1
2	3.00	2000.00	Disabled	Disabled	0	3
3	10.00	1000.00	Disabled	Disabled	0	1
4	6.00	500.00	Disabled	Disabled	Disabled	2 *2

\*1 Always set "0".

\*2 Always set "0" or "2" to the auxiliary function of the last point table among the consecutive point tables.

0: When using the point table under the absolute value command method

2: When using the point table under the incremental value command method

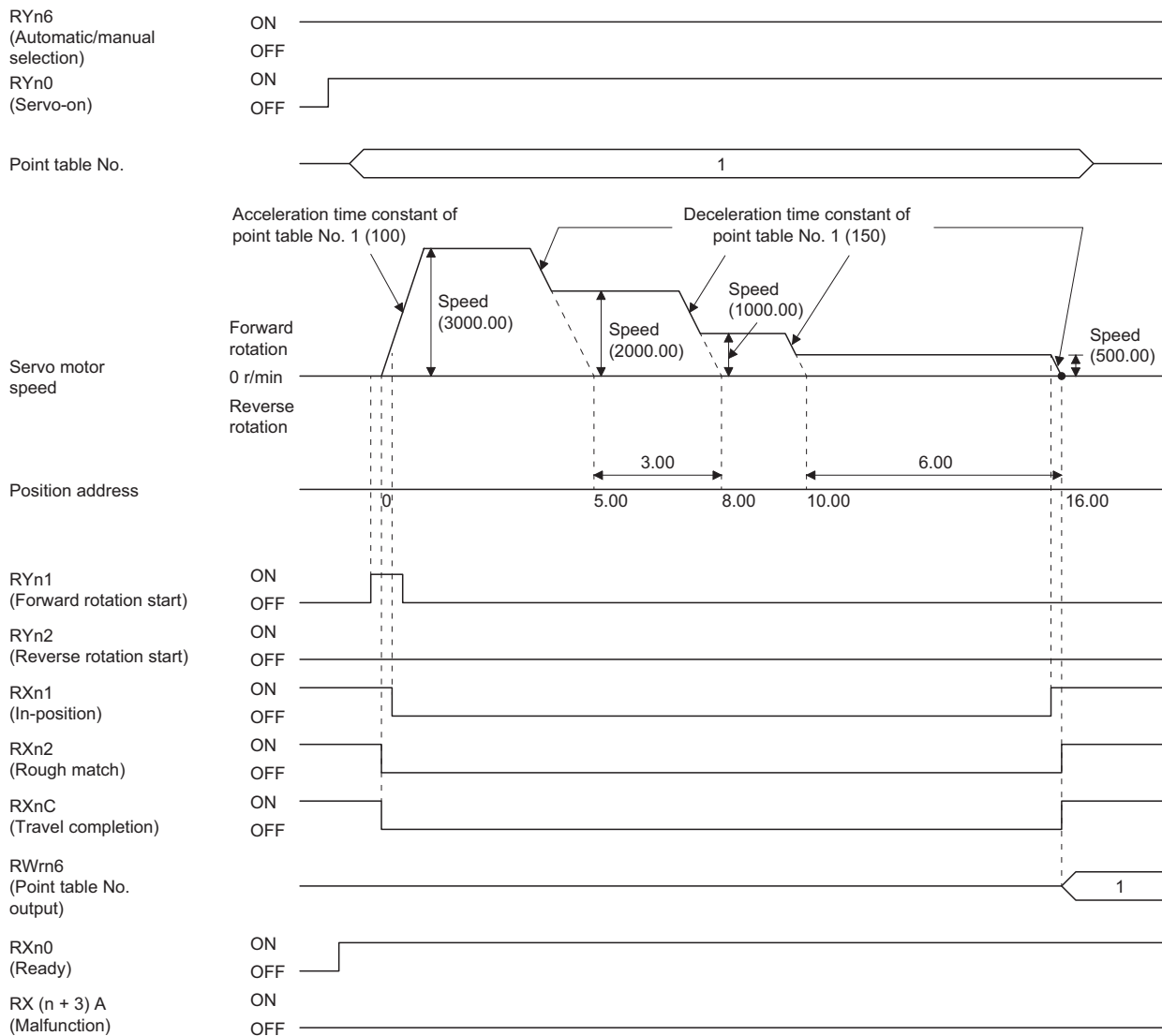

- Positioning in the reverse direction midway

The following shows an operation example with the set values listed in the table below.

In this example, point table No. 1 and point table No. 3 are under the absolute value command method, and point table No. 2 is under the incremental value command method.

Point table No.	Position data [10 <sup>STM</sup> μm]	Servo motor speed [r/min]	Acceleration time constant [ms]	Deceleration time constant [ms]	Dwell [ms] *1	Auxiliary function
1	5.00	3000.00	100	150	0	1
2	7.00	2000.00	Disabled	Disabled	0	3
3	8.00	1000.00	Disabled	Disabled	Disabled	0 *2

\*1 Always set "0".

\*2 Always set "0" or "2" to the auxiliary function of the last point table among the consecutive point tables.

0: When using the point table under the absolute value command method

2: When using the point table under the incremental value command method

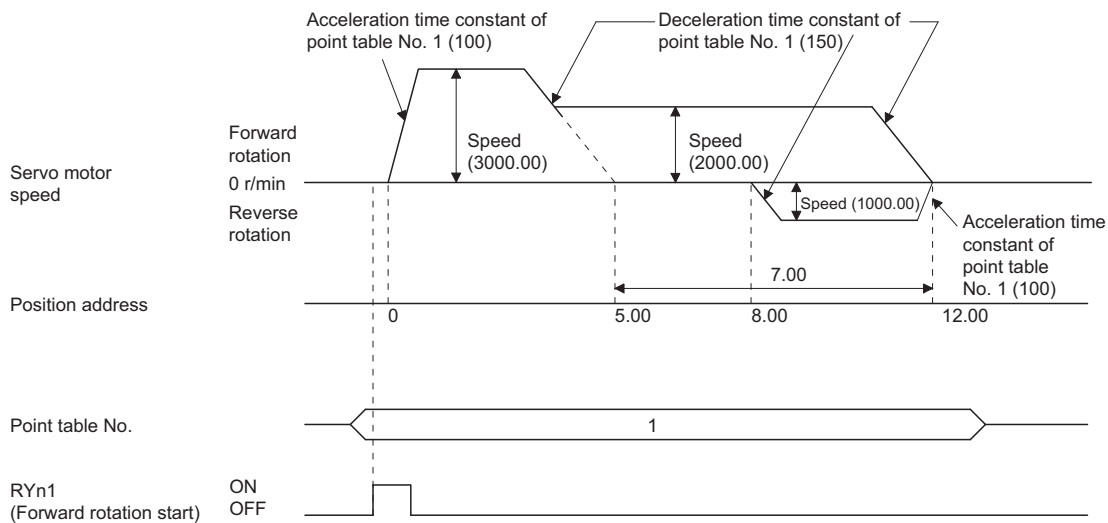

RYn1 (In-position), RYn2 (Rough match), and RYnC (Travel completion) turn on when the point table No. 3 finishes. RWrn6 (Point table No. output 1) is also set when the point table No. 3 finishes.

For details of the operation timing for the signals, refer to "Positioning in a single direction".



Incremental value command method ([Pr. PT01] = 1)

Setting "1" to the auxiliary function executes positioning at the speed set in the following point table.

At this time, the position data selected at start is valid, and the acceleration/deceleration time constant set in the next and subsequent point tables is invalid.

By setting "1" to sub functions until point table No. 254, the operation can be performed at maximum 255 speeds.

Always set "0" to the auxiliary function of the last point table.

To perform varying-speed operation, always set "0" to the dwell.

Setting "1" or more will enable the automatic continuous positioning operation.

The following table shows an example of setting.

Point table No.	Dwell [ms] <sup>*1</sup>	Auxiliary function	Varying-speed operation
1	0	1	Consecutive point table data
2	0	1	
3	Disabled	0 <sup>*2</sup>	
4	0	1	Consecutive point table data
5	0	1	
6	Disabled	0 <sup>*2</sup>	

\*1 Always set "0".

\*2 Always set "0" to the auxiliary function of the last point table among the consecutive point tables.

The following shows an operation example with the set values listed in the table below.

Point table No.	Position data [10 <sup>STM</sup> μm]	Servo motor speed [r/min]	Acceleration time constant [ms]	Deceleration time constant [ms]	Dwell [ms] *1	Auxiliary function
1	5.00	3000.00	100	150	0	1
2	3.00	2000.00	Disabled	Disabled	0	1
3	2.00	1000.00	Disabled	Disabled	0	1
4	6.00	500.00	Disabled	Disabled	Disabled	0 *2

\*1 Always set "0".

\*2 Always set "0" to the auxiliary function of the last point table among the consecutive point tables.

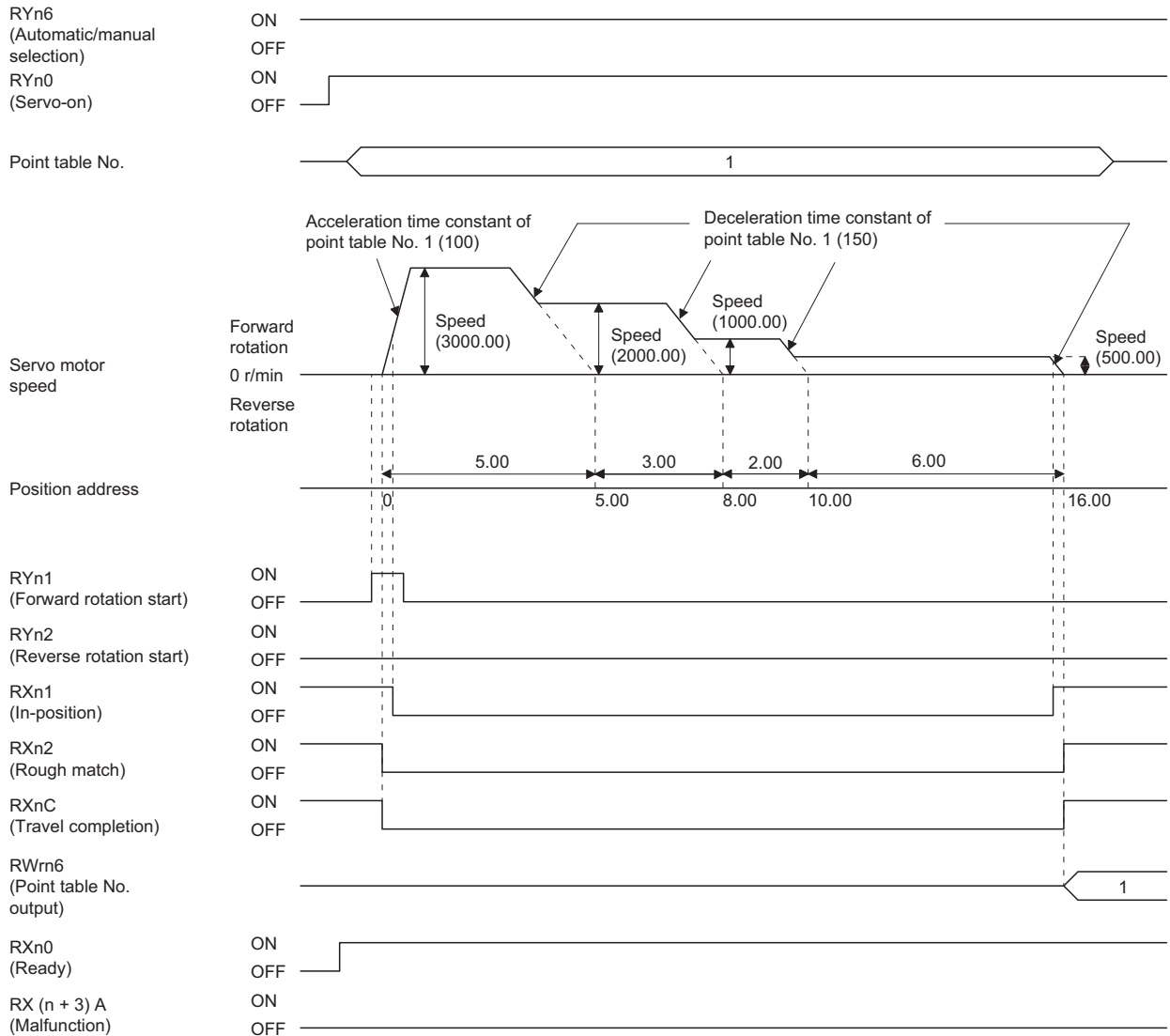

### ■Automatic repeat positioning operation

By setting the auxiliary function of the point table, the operation pattern of the set point table No. can be returned to, and the positioning operation can be performed repeatedly.

Absolute value command method ([Pr. PT01] = 0)

Setting "8" or "10" to the auxiliary function performs automatic continuous operation or varying-speed operation until that point table, and after the completion of positioning, performs the operation again from the operation pattern of the point table No. used at start-up.

Setting "9" or "11" to the auxiliary function performs automatic continuous operation or varying-speed operation until that point table, and after the completion of positioning, performs the operation again from the operation pattern of point table No. 1.

- Automatic repeat positioning operation by absolute value command method

Example 1. Operations when "8" is set to the auxiliary function of point table No. 4

Point table No.	Position data [10 <sup>STM</sup> μm]	Servo motor speed [r/min]	Acceleration time constant [ms]	Deceleration time constant [ms]	Dwell [ms]	Auxiliary function
1	4.00	1500.00	200	100	150	1
2	5.00	3000.00	100	150	100	1
3	5.00	2000.00	150	200	200	3
4	15.00	1000.00	300	100	150	8

Operation sequence

1. Starting with point table No. 2
2. Executing point table No. 3
3. Executing point table No. 4
4. Executing again point table No. 2 used at start-up when "8" is set to the auxiliary function of point table No. 4
5. Repeating the above execution in the sequence of 2. to 3. to 4. to 2. to 3. to 4.

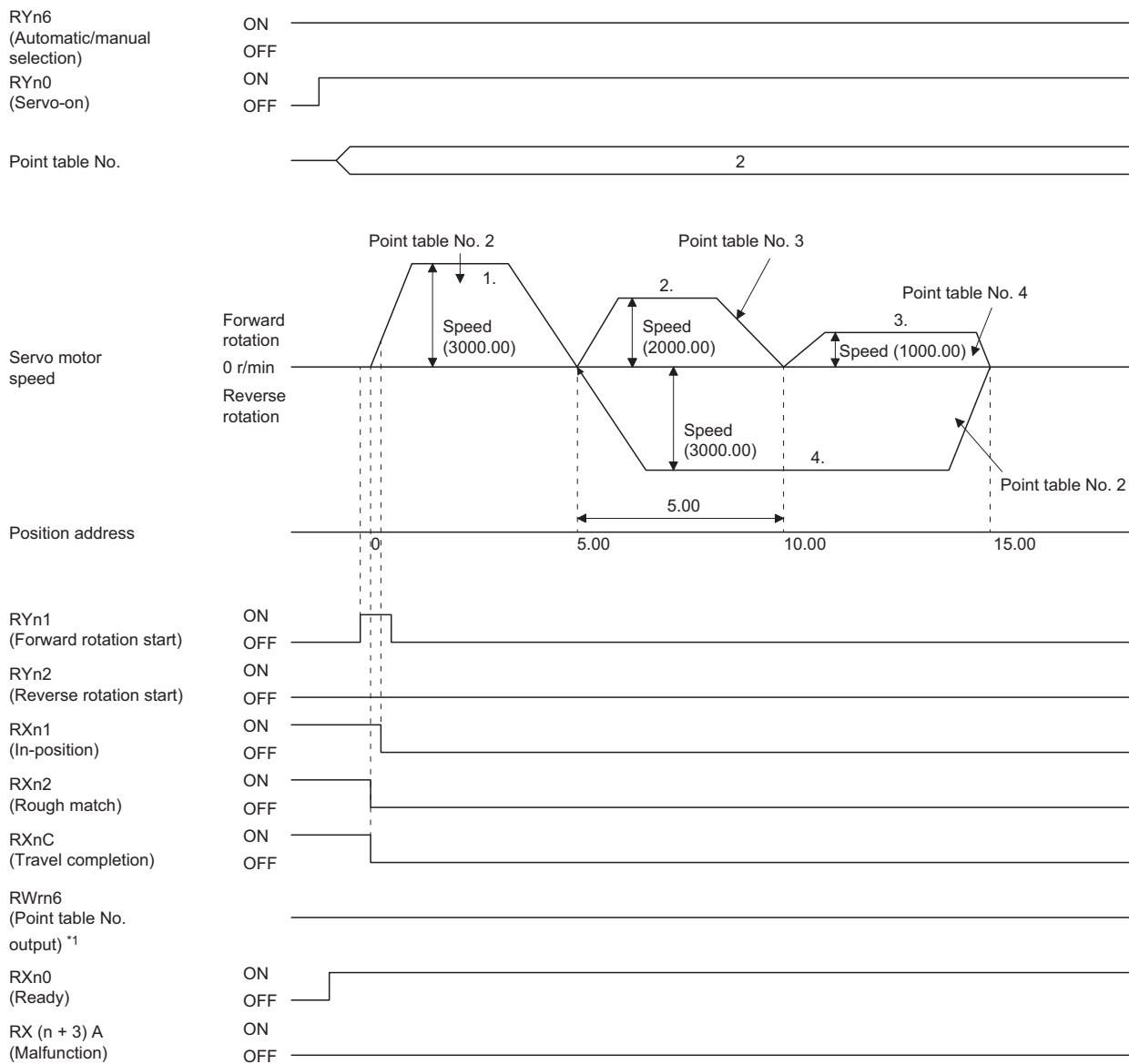

\*1 RWrn6 is not outputted in automatic continuous operation.

Example 2. Operations when "9" is set to the auxiliary function of point table No. 3

Point table No.	Position data [10 <sup>STM</sup> μm]	Servo motor speed [r/min]	Acceleration time constant [ms]	Deceleration time constant [ms]	Dwell [ms]	Auxiliary function
1	0.00	3000.00	100	150	100	1
2	5.00	2000.00	150	200	200	1
3	15.00	1000.00	300	100	150	9

Operation sequence

1. Starting with point table No. 2
2. Executing point table No. 3
3. Executing point table No. 1 when "9" is set to the auxiliary function of point table No. 3
4. Repeating the above execution in the sequence of 1. to 2. to 3. to 1. to 2. to 3.

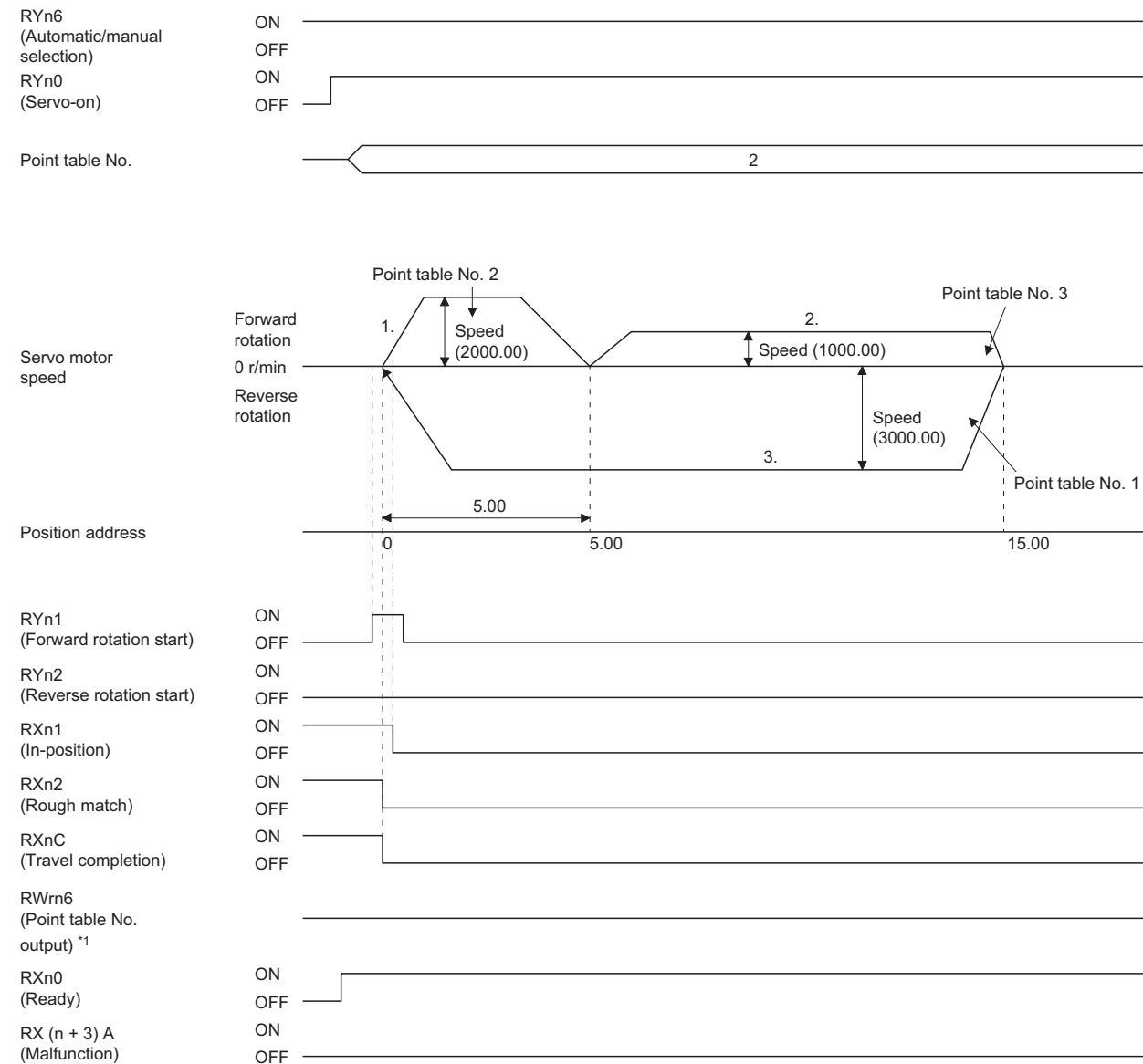

\*1 RWn6 is not outputted in automatic continuous operation.

- Automatic repeat positioning operation by incremental value command method

Example 1. Operations when "10" is set to the auxiliary function of point table No. 4

Point table No.	Position data [10 <sup>STM</sup> μm]	Servo motor speed [r/min]	Acceleration time constant [ms]	Deceleration time constant [ms]	Dwell [ms]	Auxiliary function
1	4.00	1500.00	200	100	150	1
2	5.00	3000.00	100	150	100	3
3	10.00	2000.00	150	200	200	1
4	5.00	1000.00	300	100	150	10

Operation sequence

1. Starting with point table No. 2
2. Executing point table No. 3
3. Executing point table No. 4
4. Executing again point table No. 2 used at start-up when "10" is set to the auxiliary function of point table No. 4
5. Repeating the above execution in the sequence of 1. to 2. to 3. to 4. to 2. to 3. to 4.

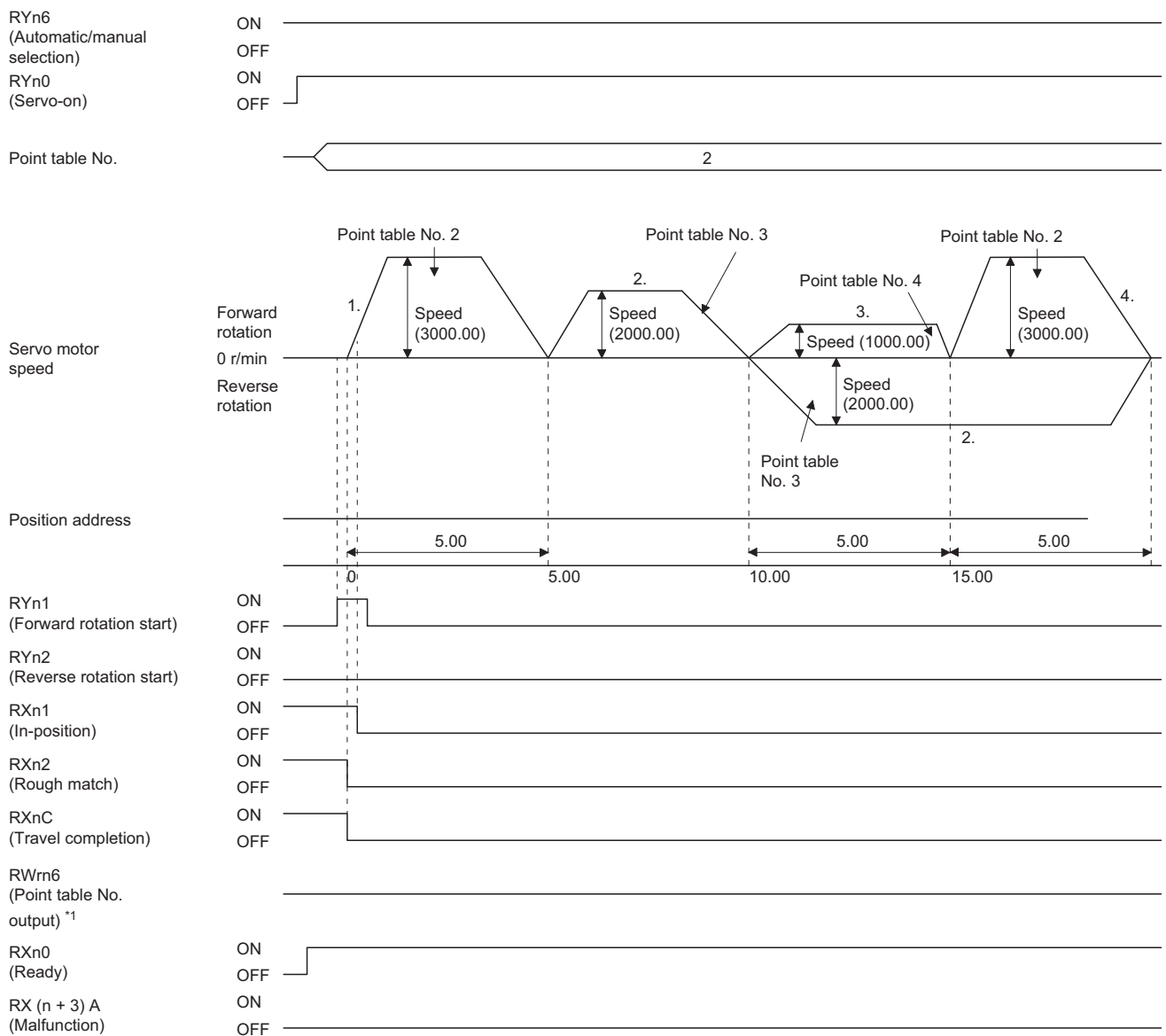

\*1 RWrn6 is not outputted in automatic continuous operation.

Example 2. Operations when "11" is set to the auxiliary function of point table No. 3

Point table No.	Position data [10 <sup>STM</sup> μm]	Servo motor speed [r/min]	Acceleration time constant [ms]	Deceleration time constant [ms]	Dwell [ms]	Auxiliary function
1	5.00	3000.00	100	150	100	3
2	10.00	2000.00	150	200	200	1
3	5.00	1000.00	300	100	150	11

Operation sequence

1. Starting with point table No. 2
2. Executing point table No. 3
3. Executing point table No. 1 when "11" is set to the auxiliary function of point table No. 3
4. Repeating the above execution in the sequence of 1. to 2. to 3. to 1. to 2. to 3.

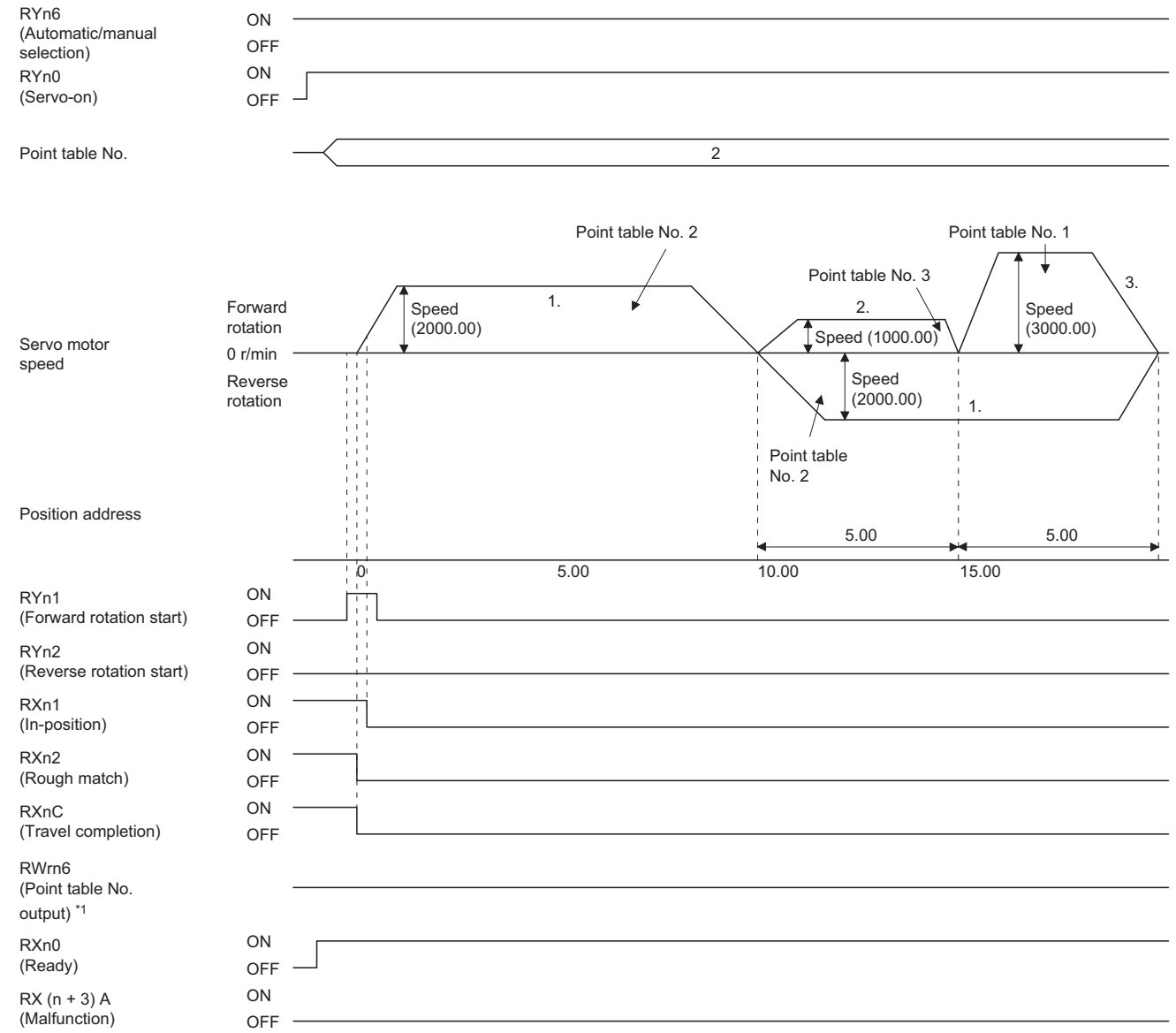

\*1 RWn6 is not outputted in automatic continuous operation.

**Ex.**

Varying-speed operation by absolute value command method

Example. Operations when "8" is set to the auxiliary function of point table No. 3

Point table No.	Position data [10 <sup>STM</sup> μm]	Servo motor speed [r/min]	Acceleration time constant [ms]	Deceleration time constant [ms]	Dwell [ms]	Auxiliary function
1	5.00	3000.00	100	150	0	1
2	5.00	2000.00	Disabled	Disabled	0	3
3	15.00	1000.00	Disabled	Disabled	0	8

Operation sequence

1. Starting with point table No. 1
2. Varying the speed and executing point table No. 2
3. Varying the speed and executing point table No. 3
4. Executing point table No. 1 used at start-up in CW direction when "8" is set to the auxiliary function of point table No. 3
5. Repeating the above execution in the sequence of 1. to 2. to 3. to 4. to 2. to 3. to 4.

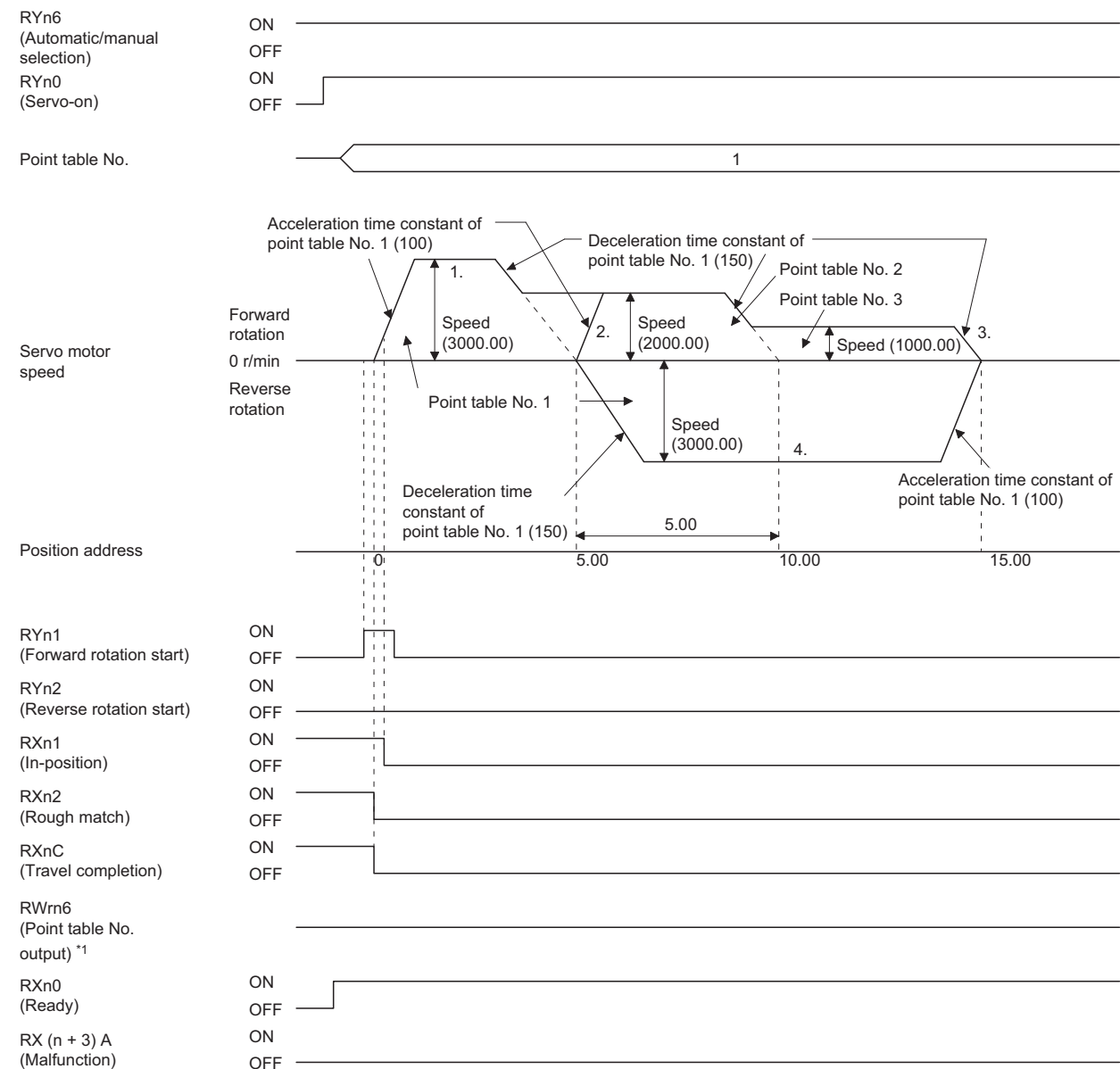

\*1 RWrn6 is not outputted in automatic continuous operation.



**Ex.**

Varying-speed operation by incremental value command method

Example. Operations when "10" is set to the auxiliary function of point table No. 3

Point table No.	Position data [10 <sup>STM</sup> μm]	Servo motor speed [r/min]	Acceleration time constant [ms]	Deceleration time constant [ms]	Dwell [ms]	Auxiliary function
1	5.00	3000.00	100	150	0	3
2	10.00	2000.00	150	200	0	1
3	5.00	1000.00	300	100	0	10

Operation sequence

1. Starting with point table No. 1
2. Varying the speed and executing point table No. 2
3. Varying the speed and executing point table No. 3
4. Varying the speed, and executing point table No. 1 when "10" is set to the auxiliary function of point table No. 3
5. Repeating the above execution in the sequence of 1. to 2. to 3. to 4. to 2. to 3. to 4.

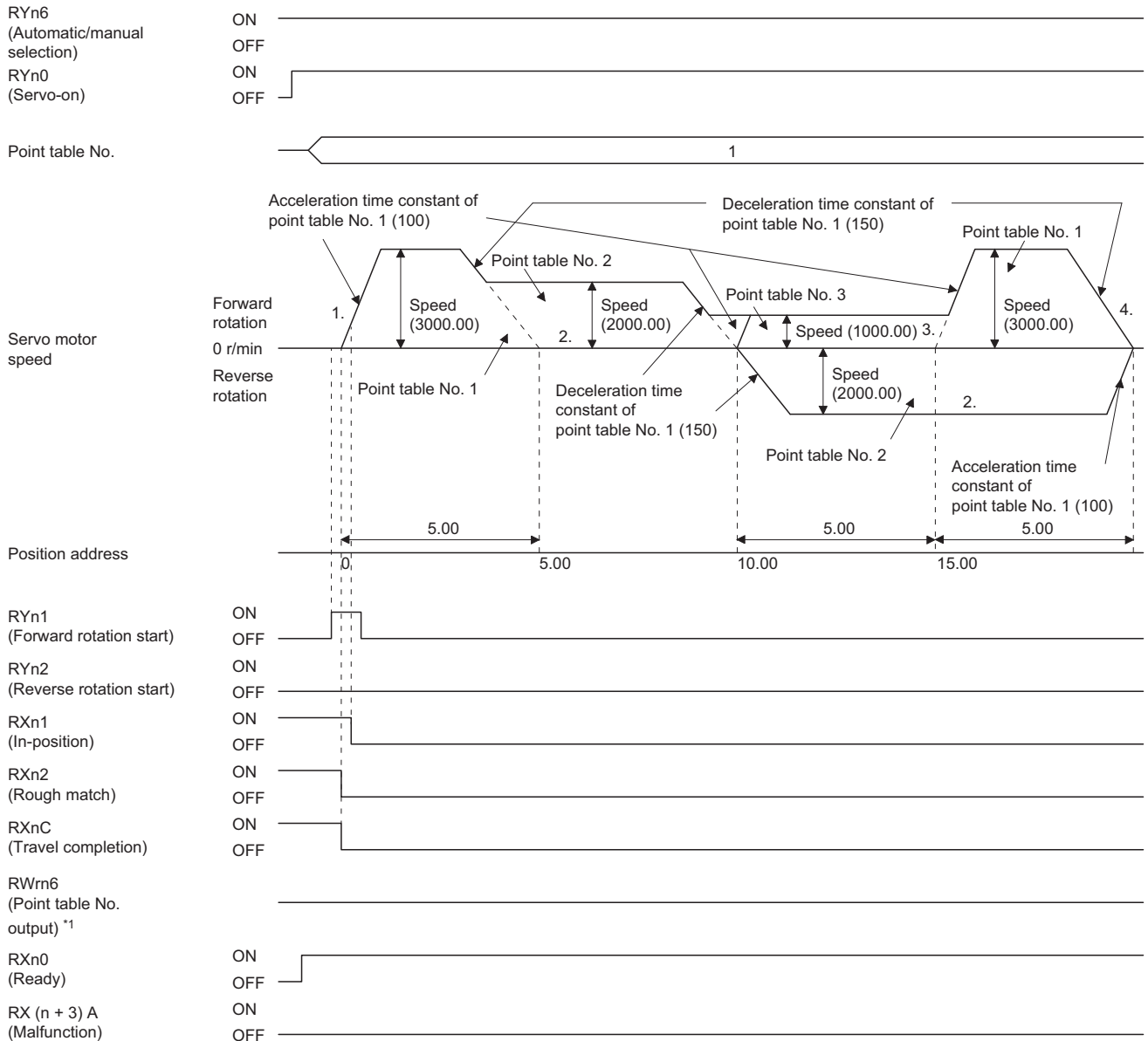

\*1 RWrn6 is not outputted in automatic continuous operation.

- Incremental value command method ([Pr. PT01] = \_\_\_ 1)

Setting "8" to the auxiliary function performs automatic continuous operation or varying-speed operation until that point table, and after the completion of positioning, performs the operation again from the operation pattern of the set point table.

Setting "9" to the auxiliary function performs automatic continuous operation or varying-speed operation until that point table, and after the completion of positioning, performs the operation again from the operation pattern of point table No. 1.

**Ex.**

Automatic repeat positioning operation by incremental value command method

Example 1. Operations when "8" is set to the auxiliary function of point table No. 3

Point table No.	Position data [10 <sup>STM</sup> μm]	Servo motor speed [r/min]	Acceleration time constant [ms]	Deceleration time constant [ms]	Dwell [ms]	Auxiliary function
1	4.00	1500.00	200	100	150	1
2	5.00	3000.00	100	150	100	1
3	6.00	2000.00	150	200	200	8

Operation sequence

1. Starting with point table No. 2
2. Executing point table No. 3
3. Executing again point table No. 2 used at start-up when "8" is set to the auxiliary function of point table No. 3
4. Repeating the above execution in the sequence of 1. to 2. to 3. to 2. to 3.

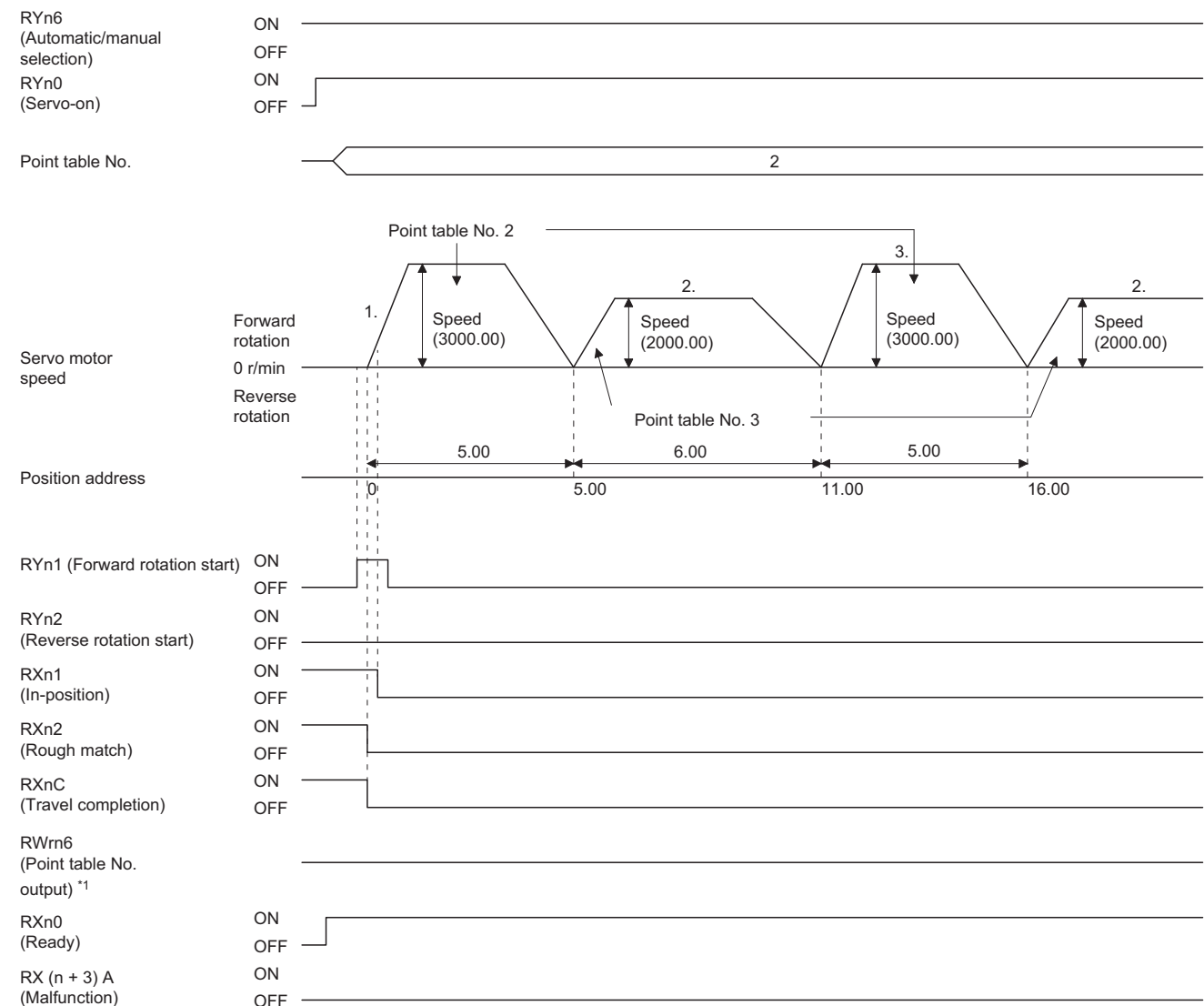

\*1 RWrn6 is not outputted in automatic continuous operation.

Example 2. Operations when "9" is set to the auxiliary function of point table No. 2

Point table No.	Position data [10 <sup>STM</sup> μm]	Servo motor speed [r/min]	Acceleration time constant [ms]	Deceleration time constant [ms]	Dwell [ms]	Auxiliary function
1	5.00	3000.00	100	150	100	1
2	6.00	2000.00	150	200	200	9

Operation sequence

1. Starting with point table No. 2
2. Executing point table No. 1 when "9" is set to the auxiliary function of point table No. 2
3. Repeating the above execution in the sequence of 1. to 2. to 1. to 2.

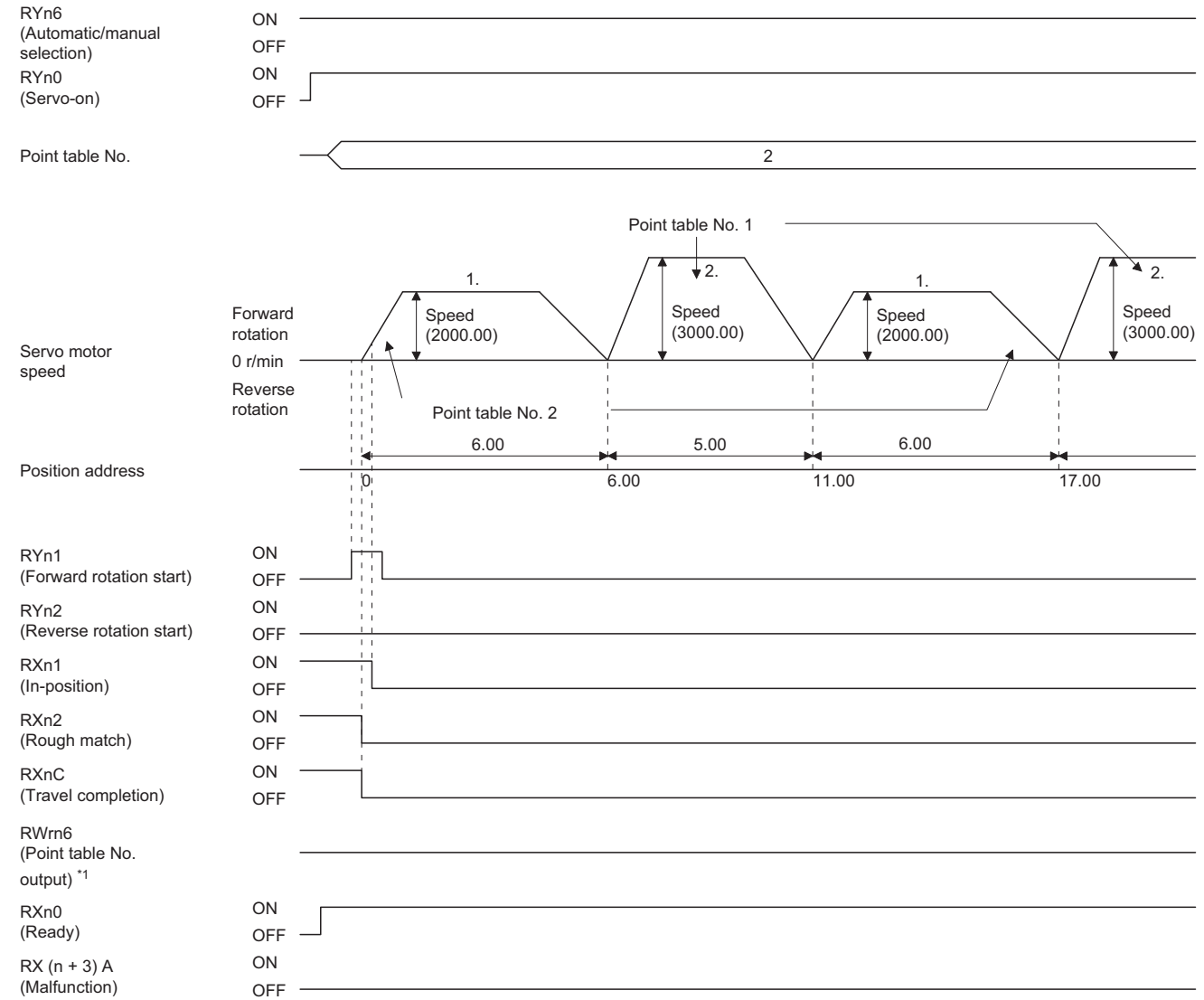

\*1 RWn6 is not outputted in automatic continuous operation.

**Ex.**

Varying-speed operation by incremental value command method

Example. Operations when "8" is set to the auxiliary function of point table No. 2

Point table No.	Position data [10 <sup>STM</sup> μm]	Servo motor speed [r/min]	Acceleration time constant [ms]	Deceleration time constant [ms]	Dwell [ms]	Auxiliary function
1	5.00	3000.00	100	150	0	1
2	6.00	2000.00	Disabled	Disabled	0	8

Operation sequence

1. Starting with point table No. 1
2. Varying the speed and executing point table No. 2
3. Executing again point table No. 1 used at start-up when "8" is set to the auxiliary function of point table No. 2
4. Repeating the above execution in the sequence of 1. to 2. to 3. to 2. to 3.

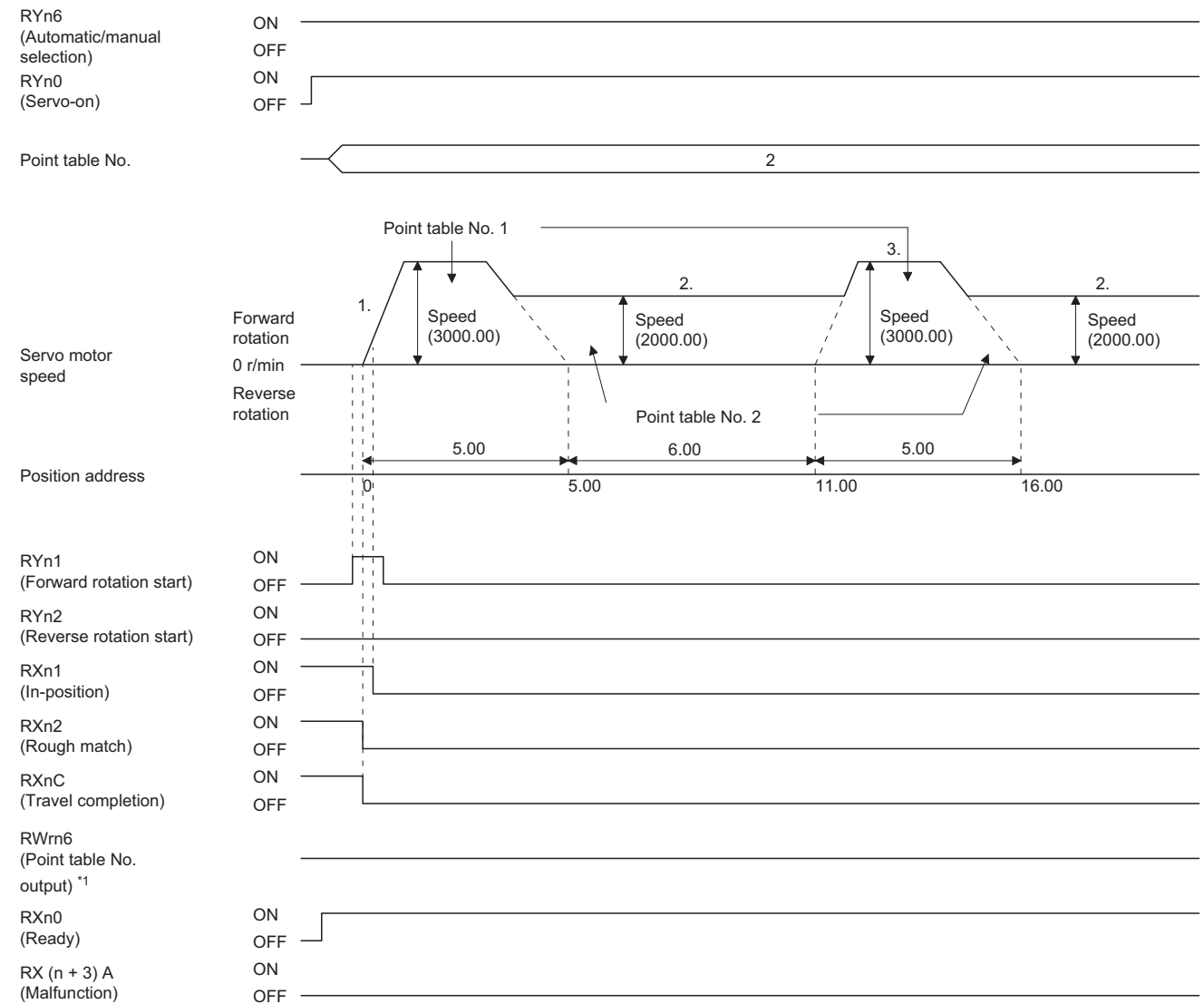

\*1 RWrn6 is not outputted in automatic continuous operation.

## ■ Temporary stop/restart

When RYn7 (Temporary stop/restart) is switched on during automatic operation, the servo motor decelerates with the deceleration time constant of the point table being executed, and then stops temporarily. Switching on RYn7 (Temporary stop/restart) again restarts the servo motor rotation for the remaining distance.

During a temporary stop, RYn1 (Forward rotation start) or RYn2 (Reverse rotation start) does not function even if it is switched on.

When any of the following conditions is satisfied during a temporary stop, the remaining travel distance is cleared and the temporary stop is reset.

- The operation mode is switched from the automatic mode to the manual mode.
- The servo motor enters the servo-off status.
- The clear signal was input.
- The stroke limit or software limit is detected.
- The controller is reset.

The temporary stop/restart input functions in the following states.

Operation status	Automatic operation	Manual operation	Home position return
During a stop	—	Temporary stop	Temporary stop
During acceleration	Temporary stop	Temporary stop	Temporary stop
At a constant speed	Temporary stop	Temporary stop	Temporary stop
During deceleration	—	Temporary stop	Temporary stop
During a temporary stop	Restart	Restart	Stop

### When the servo motor is rotating

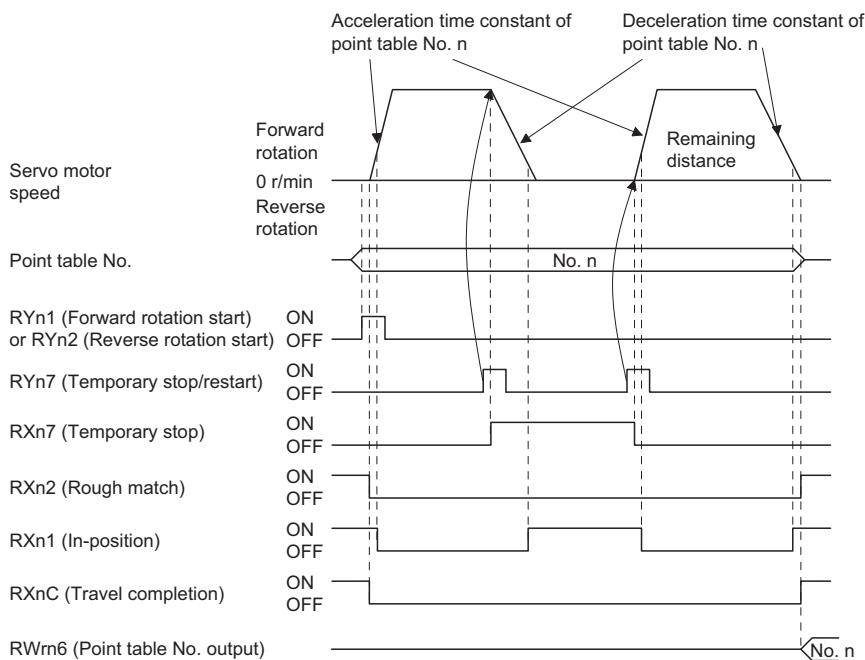

## During dwell

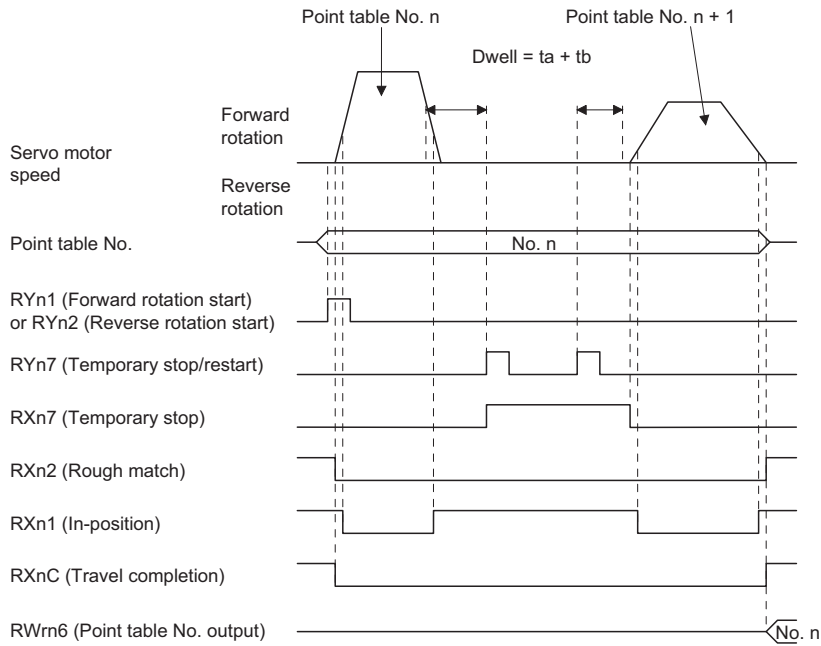

## ■Suspension of automatic operation

To stop the automatic operation, stop the servo motor with RYn7 (Temporary stop/restart), switch off RYn6 (Automatic/manual selection), and then set to the manual mode. The travel remaining distance is cleared.

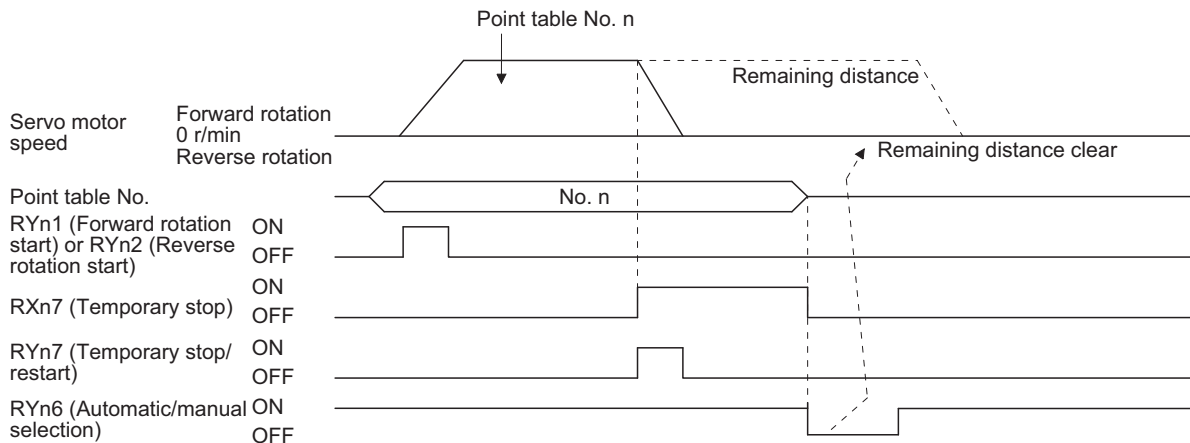

## ■Using the control unit "degree"

- Addresses of the current position and the command position

Addresses of the current position and the command position are ring addresses.

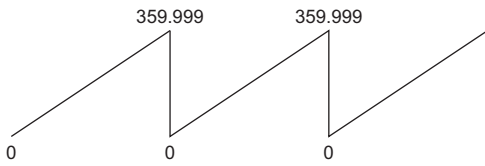

- Setting the software limit to enabled/disabled

### Point

- When changing "+" or "-" of the shaft whose software limit has been enabled, execute home position return after the change.
- When the software limit is enabled in the incremental system, execute home position return after cycling the power.

When the unit is "degree", the setting range of the software limit is 0 to 359.999 degrees.

If [Pr. PT15] to [Pr. PT18] are set to values other than 0 to 359.999 degrees, the values will be converted as follows: (The values will be clamped to the range of 0 to 359.999 degrees.)

Software limit value	After conversion
360.000 to 999.999 degrees	The remainder from the setting value divided by 360
-0.001 to -359.999 degrees	The value obtained by adding 360 to the setting value
-360.000 to -999.999 degrees	The value obtained by adding 360 to the setting value after dividing the setting value by 360

To enable the software limit, set the software limit - ([Pr. PT17] and [Pr. PT18]) as the starting point and the software limit + ([Pr. PT15] and [Pr. PT16]) as the ending point.

The movable range is the section where the servo motor moves from "-" to "+" in the CCW direction.

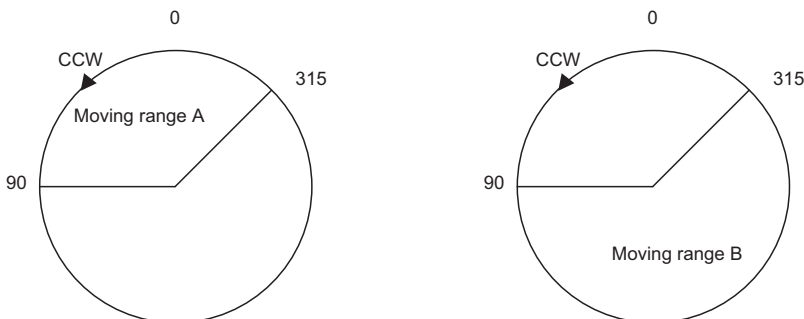

Set the travel range of the section A as follows:

Software limit - ... 315.000 degrees

Software limit + ... 90.000 degrees

Set the travel range of the section B as follows:

Software limit - ... 90.000 degrees

Software limit + ... 315.000 degrees

To disable the software limit, set the software limit - ([Pr. PT17] and [Pr. PT18]) and the software limit + ([Pr. PT15] and [Pr. PT16]) to the same value.

Controls can be performed regardless of the software limit settings.

- Setting the position range output to enabled/disabled

When the unit is "degree", the setting range of the position range output is 0 to 359.999 degrees.

If [Pr. PT19] to [Pr. PT22] are set to values other than 0 to 359.999 degrees, the values will be converted as follows: (The values will be clamped to the range of 0 to 359.999 degrees.)

Position range output address value	After conversion
360.000 to 999.999 degrees	The remainder from the setting value divided by 360
-0.001 to -359.999 degrees	The value obtained by adding 360 to the setting value
-360.000 to -999.999 degrees	The value obtained by adding 360 to the setting value after dividing the setting value by 360

Set the position range output address - ([Pr. PT21] and [Pr. PT22]) as the starting point and the position range output address + ([Pr. PT19] and [Pr. PT20]) as the ending point.

The movable range is the section where the servo motor moves from "-" to "+" in the CCW direction.

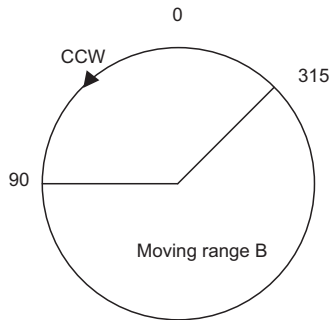
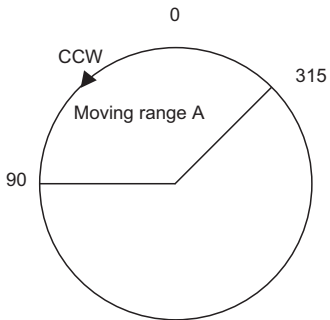

Set the travel range of the section A as follows:

Position range output address - ... 315.000 degrees

Position range output address + ... 90.000 degrees

Set the travel range of the section B as follows:

Position range output address - ... 90.000 degrees

Position range output address + ... 315.000 degrees



## ■ Changing the operation mode

When the operation mode is changed, wait for 6 ms or more after the change, and then turn on RYn1 (Forward rotation start) or RYn2 (Reverse rotation start).

Changing the operation mode during operation will stop the operation in execution and decelerate the servo motor to a stop. Before turning on RYn1 (Forward rotation start) or RYn2 (Reverse rotation start), make sure that RXnC (Travel completion) is turned on.

- When you change the operation mode while the operation is being stopped

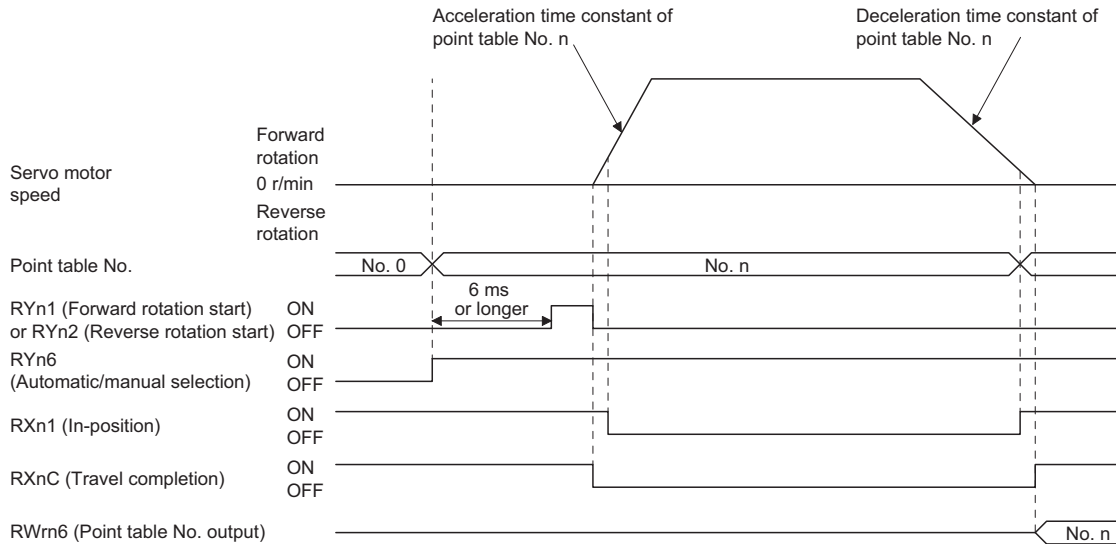

- When you change the operation mode during operation (from the point table operation to JOG operation)

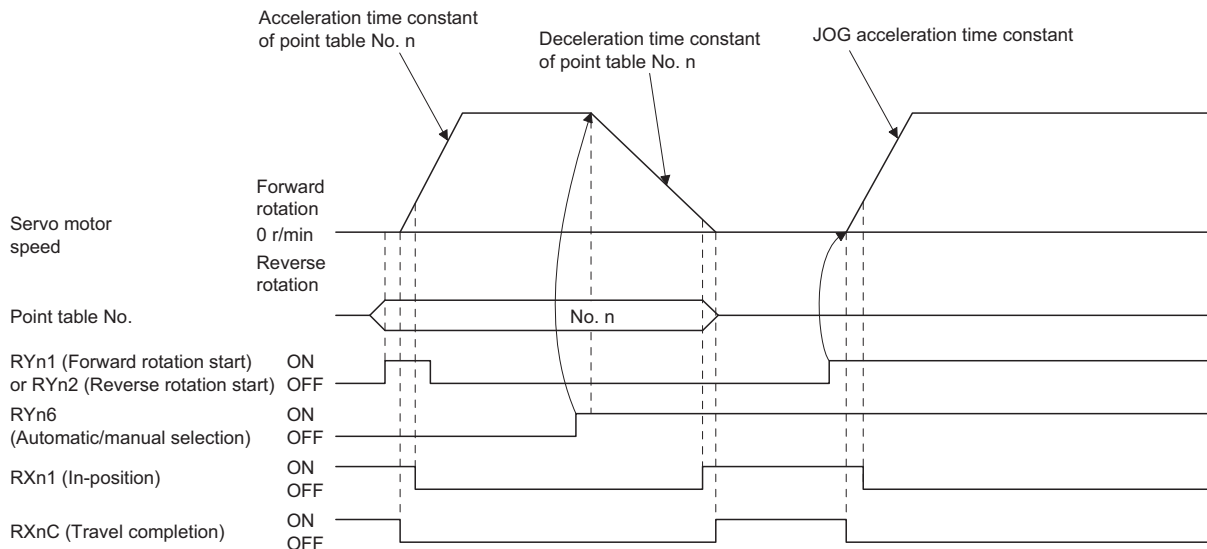

- When you change the operation mode during operation (from the point table operation to home position return)

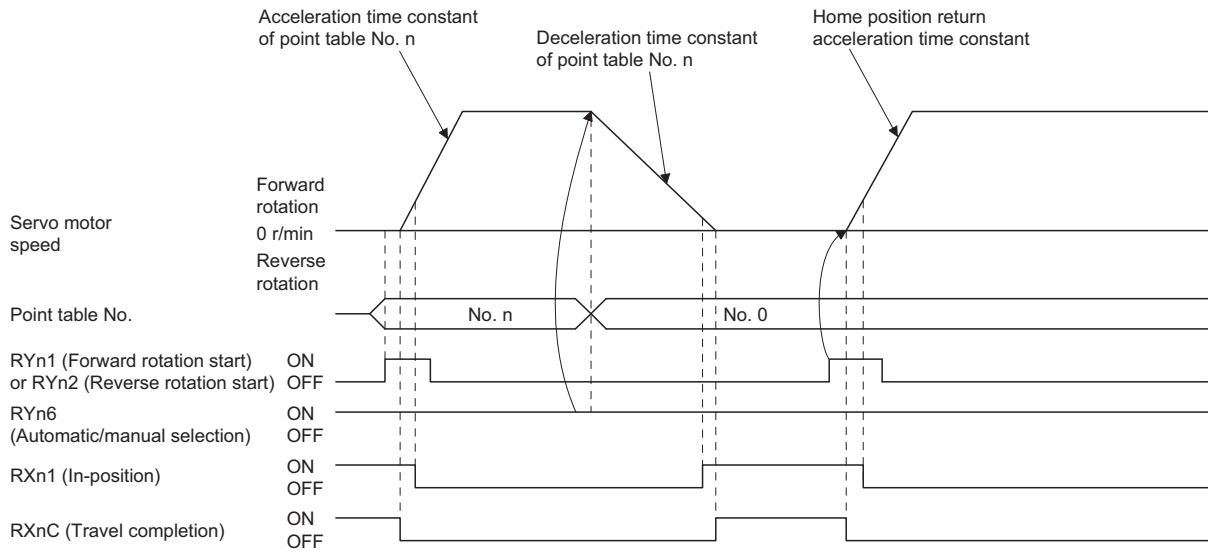

## 2.4 Manual operation mode

For the machine adjustment, home position adjustment, and others, positioning to any point is possible using the JOG operation.

### JOG operation

#### Setting

According to the purpose of use, set input devices and parameters as shown below. In this case, RWwn6 (Point table No. selection) is disabled.

Item	Used device/parameter	Setting
Manual operation mode selection	RYn6 (Automatic/manual selection)	Switch off RYn6.
Servo motor rotation direction	[Pr. PA14]	☞ Page 89 Servo motor rotation direction
JOG speed	[Pr. PT65]	Set the servo motor speed.
Acceleration/deceleration time constant	Acceleration time constant: [Pr. PT49] Deceleration time constant: [Pr. PT50]	Set an acceleration time constant and deceleration time constant.

#### Servo motor rotation direction

[Pr. PA14] setting	Servo motor rotation direction	
	RYn1 (Forward rotation start) on	RYn2 (Reverse rotation start) on
0	CCW rotation	CW rotation
1	CW rotation	CCW rotation

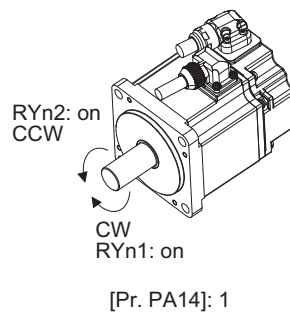
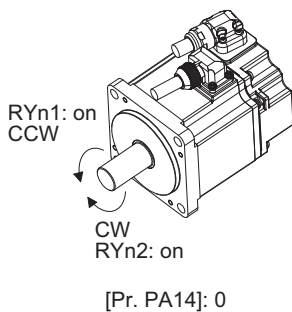

#### Operation

Turning on RYn1 (Forward rotation start) performs the operation according to the JOG speed, acceleration time constant, and deceleration time constant set with parameters. For the rotation direction, refer to the following. Switching on RYn2 (Reverse rotation start) starts the rotation in the reverse direction of RYn1 (Forward rotation start).

☞ Page 89 Servo motor rotation direction

Simultaneously switching on or off RYn1 (Forward rotation start) and RYn2 (Reverse rotation start) stops the operation.

## Timing chart

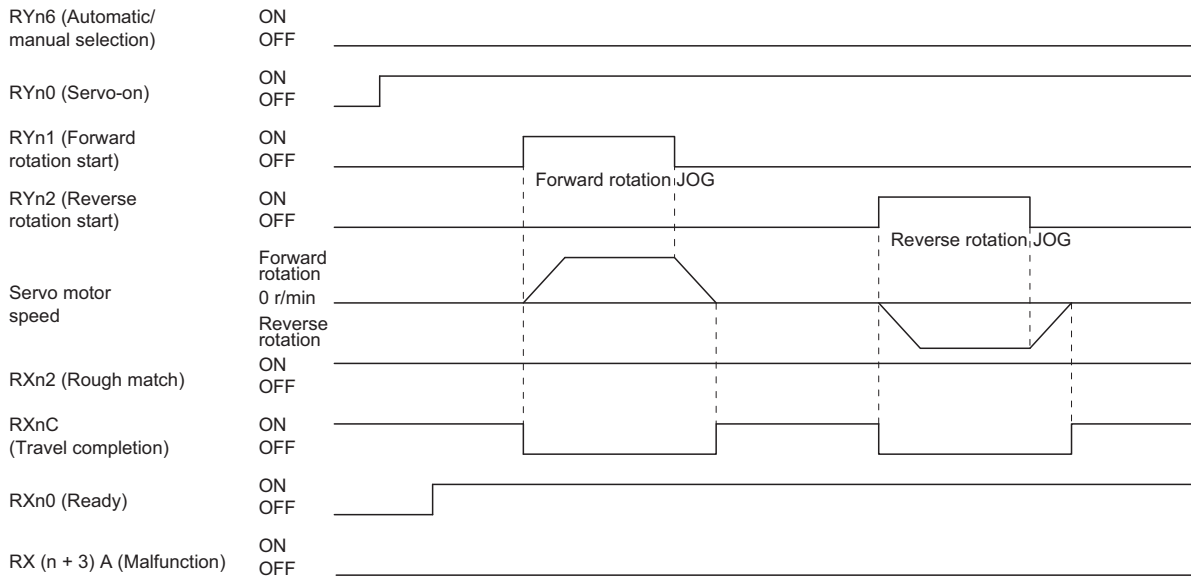

## Temporary stop/restart

When RYn7 (Temporary stop/restart) is switched on during JOG operation, the servo motor decelerates with the deceleration time constant being executed ([Pr. PT50]), and then stops temporarily. Turning on RYn7 (Temporary stop/restart) again restarts the JOG operation. However, if both RYn1 (Forward rotation start) and RYn2 (Reverse rotation start) are on or off, the operation does not restart.

During a temporary stop, RYn1 (Forward rotation start) or RYn2 (Reverse rotation start) does not function even if it is switched on.

When any of the following conditions is satisfied during a temporary stop, the temporary stop is reset.

- The manual operation mode is switched to the automatic operation mode.
- The servo motor enters the servo-off status.
- The stroke limit or software limit is detected.
- The controller is reset.

The temporary stop/restart input functions in the following states.

Operation status	Automatic operation	Manual operation	Home position return
During a stop	—	Pause	Pause
During acceleration	Pause	Pause	Pause
At a constant speed	Pause	Pause	Pause
Deceleration	—	Pause	Pause
During a temporary stop	Restart	Restart	Stop

■When the servo motor is rotating

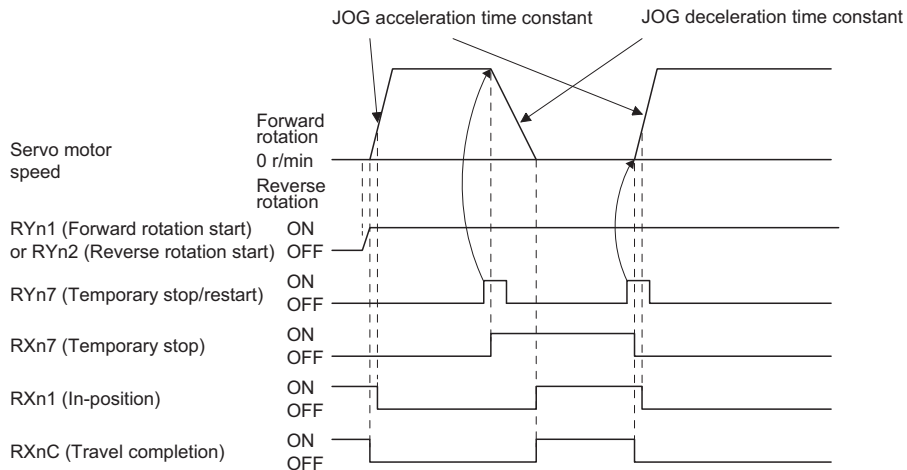

■When the servo motor has been restarted during a temporary stop

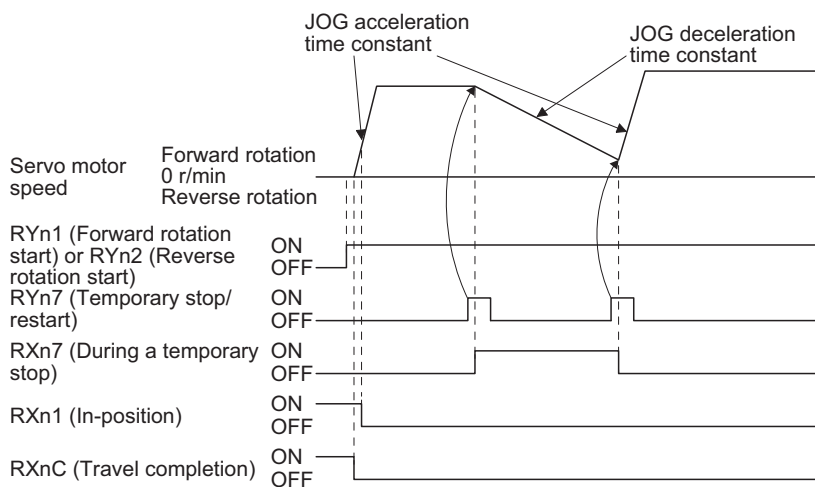

## 2.5 Home position return mode

---

### Point

Before performing the home position return, make sure that the limit switch operates.

Check the home position return direction. An incorrect setting will cause a reverse running.

Check the input polarity of the proximity dog. Otherwise, it may cause an unexpected operation.

For the home position return when the servo motor is used in the linear servo motor control mode, refer to section 14.3 of "MR-J4-\_GF\_(-RJ) Servo Amplifier Instruction Manual (Motion Mode)".

For the home position return when the servo motor is used in the direct drive motor control mode and the fully closed control mode, refer to "MR-J4-\_GF\_(-RJ) Servo Amplifier Instruction Manual (Motion Mode)".

For the home position return when the servo motor is used in the fully closed control mode, refer to section 16.3 of "MR-J4-\_GF\_(-RJ) Servo Amplifier Instruction Manual (Motion Mode)".

To execute a home position return securely, start a home position return after moving the linear servo motor to the opposite stroke end.

---

## Outline of home position return

---

A home position return is performed to match the command coordinates with the machine coordinates. Under the incremental method, each power-on of the input power supply requires the home position return. Contrastingly, in the absolute position detection system, once you have performed the home position return at machine installation, the current position will be retained even if the power supply is shut off. Therefore, the home position return is unnecessary when the power supply is switched on again.

This section shows the home position return types of the servo amplifier. Select the optimum method according to the configuration and uses of the machine.

## Home position return types

---

### Point

For the home position return types for which "Motion mode" is described in the detailed explanation field, refer to section 4.6 of "MR-J4-\_GF\_(-RJ) Servo Amplifier Instruction Manual (Motion Mode)". In addition, replace the following left signals to the right signals.

- Statusword bit 10 Target reached → RXnC (Travel completion)
- Statusword bit 12 Homing attained → RX (n + 1) 0 (Home position return completion 2)
- Controlword bit 4 Homing operation start → RYn1 (Forward rotation start)
- DOG (Proximity dog) → RYn3 (Proximity dog)
- TLC (Limiting torque) → RXn4 (Limiting torque)

When the servo motor is used in the I/O mode, the following signals have conditions to be met.

- Point table No.

Configure a sequence in which the point table No. is changed 4 ms before RYn1 turns on.

- RYn6 (Automatic/manual selection)

Configure a sequence in which RYn6 turns on before home position return starts.

---

Select the optimum home position return type according to the machine type or others.

Method No.	Home position return type	Home position return direction	Description	Detailed explanation
-1	Dog type (Rear end detection, Z-phase reference)	Forward rotation (CCW) or positive direction	Deceleration starts at the front end of the proximity dog. After the rear end is passed, the position specified by the first Z-phase signal, or the position of the first Z-phase signal shifted by the specified home position shift distance is used as the home position.	Motion mode
-33		Reverse rotation (CW) or negative direction		
-4	Stopper type (Stopper position reference)	Forward rotation (CCW) or positive direction	A workpiece is pressed against a mechanical stopper, and the position where it is stopped is set as the home position.	
-36		Reverse rotation (CW) or negative direction		
-2	Count type (Front end detection, Z-phase reference)	Forward rotation (CCW) or positive direction	At the front end of the proximity dog, deceleration starts. After the front end is passed, the position specified by the first Z-phase signal after the set distance or the position of the Z-phase signal shifted by the set home position shift distance is set as a home position.	
-34		Reverse rotation (CW) or negative direction		
-5	Home position ignorance (Servo-on position as home position)	—	Servo-on position is set as the home position.	☞ Page 98 Method -5 (Home position ignorance (Servo-on position as home position))
-6	Dog type (Rear end detection, rear end reference)	Forward rotation (CCW) or positive direction	Deceleration starts from the front end of the proximity dog. After the rear end is passed, the position is shifted by the travel distance after proximity dog and the home position shift distance. The position after the shifts is set as the home position.	Motion mode
-38		Reverse rotation (CW) or negative direction		
-7	Count type (Front end detection, front end reference)	Forward rotation (CCW) or positive direction	Deceleration starts from the front end of the proximity dog. The position is shifted by the travel distance after proximity dog and the home position shift distance. The position after the shifts is set as the home position.	
-39		Reverse rotation (CW) or negative direction		
-8	Dog cradle type	Forward rotation (CCW) or positive direction	A position, which is specified by the first Z-phase signal after the front end of the proximity dog is detected, is set as the home position.	
-40		Reverse rotation (CW) or negative direction		
-9	Dog type last Z-phase reference	Forward rotation (CCW) or positive direction	After the front end of the proximity dog is detected, the position is shifted away from the proximity dog in the reverse direction. Then, the position specified by the first Z-phase signal or the position of the first Z-phase signal shifted by the home position shift distance is used as the home position.	
-41		Reverse rotation (CW) or negative direction		
-10	Dog type front end reference	Forward rotation (CCW) or positive direction	Starting from the front end of the proximity dog, the position is shifted by the travel distance after proximity dog and the home position shift distance. The position after the shifts is set as the home position.	
-42		Reverse rotation (CW) or negative direction		
-11	Dogless Z-phase reference	Forward rotation (CCW) or positive direction	The position specified by the first Z-phase signal, or the position of the first Z-phase signal shifted by the home position shift distance is used as the home position.	
-43		Reverse rotation (CW) or negative direction		
3	Homing on positive home switch and index pulse	Forward rotation (CCW) or positive direction	Same as the dog type last Z-phase reference home position return. Note that if the stroke end is detected during home position return, [AL. 90 Home position return incomplete warning] occurs.	
4	Homing on positive home switch and index pulse	Forward rotation (CCW) or positive direction	Same as the dog cradle type home position return. Note that if the stroke end is detected during home position return, [AL. 90 Home position return incomplete warning] occurs.	
5	Homing on negative home switch and index pulse	Reverse rotation (CW) or negative direction	Same as the dog type last Z-phase reference home position return. Note that if the stroke end is detected during home position return, [AL. 90 Home position return incomplete warning] occurs.	

Method No.	Home position return type	Home position return direction	Description	Detailed explanation
6	Homing on negative home switch and index pulse	Reverse rotation (CW) or negative direction	Same as the dog cradle type home position return. Note that if the stroke end is detected during home position return, [AL. 90 Home position return incomplete warning] occurs.	Motion mode
7	Homing on home switch and index pulse	Forward rotation (CCW) or positive direction	Same as the dog type last Z-phase reference home position return.	
8	Homing on home switch and index pulse	Forward rotation (CCW) or positive direction	Same as the dog cradle type home position return.	
11	Homing on home switch and index pulse	Reverse rotation (CW) or negative direction	Same as the dog type last Z-phase reference home position return.	
12	Homing on home switch and index pulse	Reverse rotation (CW) or negative direction	Same as the dog cradle type home position return.	
19	Homing without index pulse	Forward rotation (CCW) or positive direction	Same as the dog type front end reference home position return. Note that if the stroke end is detected during home position return, [AL. 90 Home position return incomplete warning] occurs.	
20	Homing without index pulse	Forward rotation (CCW) or positive direction	Although this type is the same as the dog cradle type home position return, the stop position is not on the Z-phase. Starting from the front end of the dog, the position is shifted by the travel distance after proximity dog and the home position shift distance. The position after the shifts is set as the home position. If the stroke end is detected during home position return, [AL. 90 Home position return incomplete warning] occurs.	
21	Homing without index pulse	Reverse rotation (CW) or negative direction	Same as the dog type front end reference home position return. Note that if the stroke end is detected during home position return, [AL. 90 Home position return incomplete warning] occurs.	
22	Homing without index pulse	Reverse rotation (CW) or negative direction	Although this type is the same as the dog cradle type home position return, the stop position is not on the Z-phase. Starting from the front end of the dog, the position is shifted by the travel distance after proximity dog and the home position shift distance. The position after the shifts is set as the home position. If the stroke end is detected during home position return, [AL. 90 Home position return incomplete warning] occurs.	
23	Homing without index pulse	Forward rotation (CCW) or positive direction	Same as the dog type front end reference home position return.	
24	Homing without index pulse	Forward rotation (CCW) or positive direction	Although this type is the same as the dog cradle type home position return, the stop position is not on the Z-phase. Starting from the front end of the dog, the position is shifted by the travel distance after proximity dog and the home position shift distance. The position after the shifts is set as the home position.	
27	Homing without index pulse	Reverse rotation (CW) or negative direction	Same as the dog type front end reference home position return.	
28	Homing without index pulse	Reverse rotation (CW) or negative direction	Although this type is the same as the dog cradle type home position return, the stop position is not on the Z-phase. Starting from the front end of the dog, the position is shifted by the travel distance after proximity dog and the home position shift distance. The position after the shifts is set as the home position.	
33	Homing on index pulse	Reverse rotation (CW) or negative direction	Although this type is the same as the dogless Z-phase reference home position return, the creep speed is applied as the movement start speed.	
34	Homing on index pulse	Forward rotation (CCW) or positive direction	Although this type is the same as the dogless Z-phase reference home position return, the creep speed is applied as the movement start speed.	
35	Homing on current position	—	The current position is set as the home position. This type can be executed not in the Operational enabled state.	
37	Homing on current position	—	The current position is set as the home position. This type can be executed not in the Operational enabled state.	



## Parameters for home position return

To perform the home position return, set each parameter as follows.

### ■[Pr. PT45 Home position return type]

Select the home position return type and home position return direction.

Setting value	Home position return direction	Home position return type
-1	Address increasing direction	Dog type (rear end detection, Z-phase reference)
-2		Count type (front end detection, Z-phase reference)
-4		Stopper type (stopper position reference)
-5		Home position ignorance (Servo-on position as home position)
-6		Dog type (rear end detection, rear end reference)
-7		Count type (front end detection, front end reference)
-8		Dog cradle type
-9		Dog type last Z-phase reference
-10		Dog type front end reference
-11		Dogless Z-phase reference
-33		Address decreasing direction
-34	Count type (front end detection, Z-phase reference)	
-36	Stopper type (stopper position reference)	
-38	Dog type (rear end detection, rear end reference)	
-39	Count type (front end detection, front end reference)	
-40	Dog cradle type	
-41	Dog type last Z-phase reference	
-42	Dog type front end reference	
-43	Dogless Z-phase reference	

Setting value	Home position return direction	Home position return type
3	Address increasing direction	Method 3
4		Method 4
5	Address decreasing direction	Method 5
6		Method 6
7	Address increasing direction	Method 7
8		Method 8
11	Address decreasing direction	Method 11
12		Method 12
19	Address increasing direction	Method 19
20		Method 20
21	Address decreasing direction	Method 21
22		Method 22
23	Address increasing direction	Method 23
24		Method 24
27	Address decreasing direction	Method 27
28		Method 28
33		Method 33
34	Address increasing direction	Method 34
35	—	Method 35
37	—	Method 37 (Data set type)

### ■[Pr. PT29 Function selection T-3]

Select the polarity where the proximity dog is detected with the DOG (Proximity dog) polarity selection.

Setting "0" detects a proximity dog when RYn3 (Proximity dog) is switched off. Setting "1" detects a proximity dog when RYn3 (Proximity dog) is switched on.

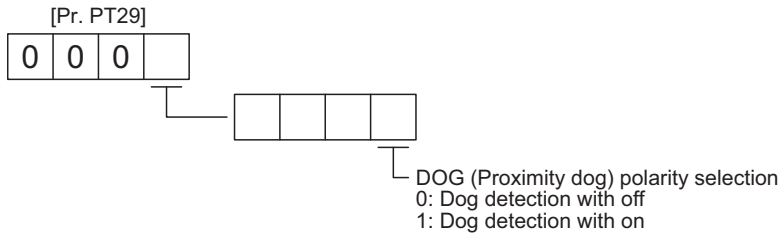

## Temporary stop/restart

When RYn7 (Temporary stop/restart) is switched on during home position return, the servo motor decelerates with the home position return deceleration time constant being executed ([Pr. PT56] or [Pr. PT57]), and then stops temporarily. Turning on RYn7 (Temporary stop/restart) again resets the temporary stop, but the operation does not restart. Turning on RYn1 (Forward rotation start) after the temporary stop is reset restarts the home position return.

During a temporary stop, RYn1 (Forward rotation start) or RYn2 (Reverse rotation start) does not function even if it is switched on.

When any of the following conditions is satisfied during a temporary stop, the temporary stop is reset.

- The home position return mode is switched to the automatic operation mode or manual operation mode.
- The servo motor enters the servo-off status.
- The stroke limit or software limit is detected.
- The controller is reset.

The temporary stop/restart input functions in the following states.

Operation status	Automatic operation	Manual operation	Home position return
During a stop	—	Pause	Pause
During acceleration	Pause	Pause	Pause
At a constant speed	Pause	Pause	Pause
Deceleration	—	Pause	Pause
During a temporary stop	Restart	Restart	Stop

When the home position return is being executed

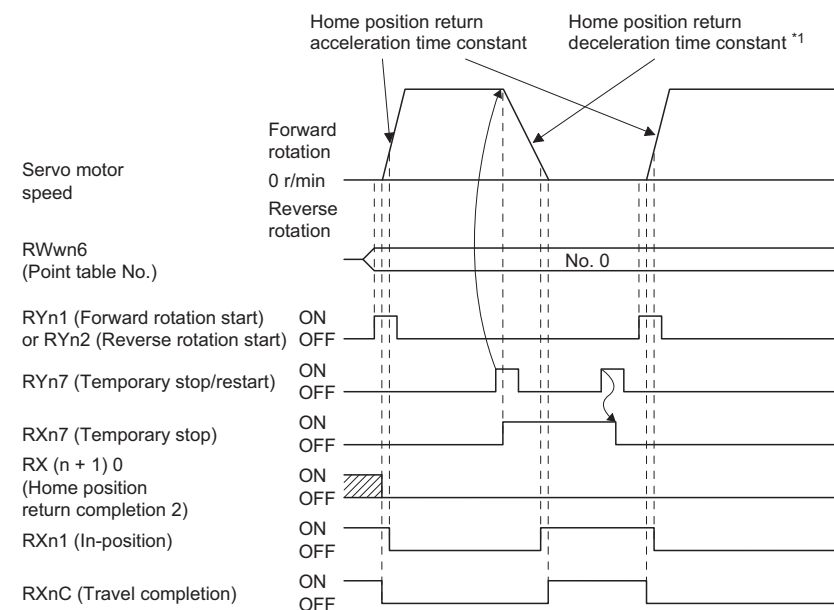

\*1 Select the deceleration time constant from [Pr. PT56] and [Pr. PT57] using the setting value of [Pr. PT55].

## Precautions for when using the proximity dog

### ■ Proximity dog length

The proximity dog must be the length in accordance with the numerical expression below so that the servo motor speed changes from the home position return speed to the creep speed during proximity dog detection.

$$L_1 \geq \frac{V}{60} \cdot \frac{td}{2}$$

$L_1$ : Proximity dog length [mm]

$V$ : Home position return speed [mm/min]

$td$ : Time taken from the home position return speed to the creep speed [s]

### ■ Proximity dog position adjustment

The proximity dog must be detected almost in the middle between a Z-phase signal and its next Z-phase signal to prevent the variations of the home position return completion positions.

You can use "Position within one-revolution" in the status display of MR Configurator2 to check the positions where Z-phase signals are to be generated.

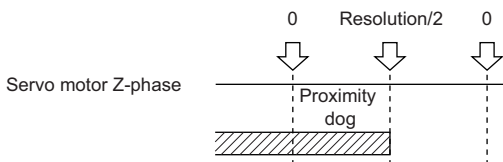

## Method -5 (Home position ignorance (Servo-on position as home position))

### Point

When you perform this home position return, it is unnecessary to switch to the home position return mode.

The position at servo-on is used as the home position.

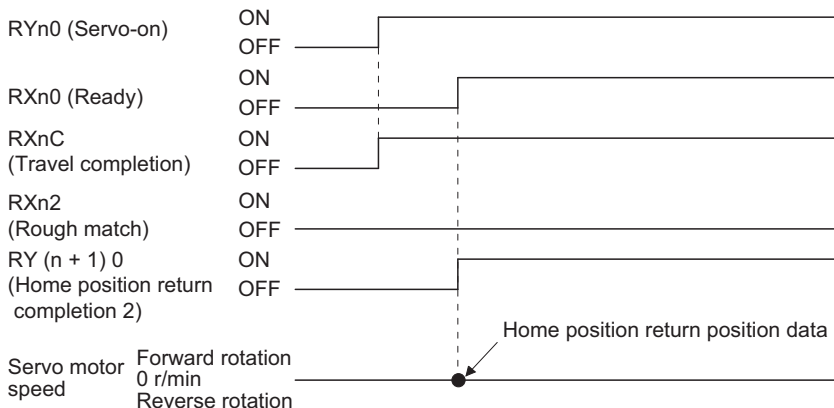

The home position return position data can be changed with [Pr. PT08] and [Pr. PT47]. The value of the home position return position data is the current position at home position return completion.

## Automatic positioning to home position function

### Point

The automatic positioning to the home position cannot be performed from outside the setting range of position data. In this case, perform the home position return again using the home position return.

After power-on, if the home position return is performed again after the home position return is performed to define the home position, this function enables automatic positioning to the home position rapidly. For the absolute position detection system, the home position return is unnecessary after the power-on.

When the automatic positioning to the home position is performed at home position return incompleteness, [AL. 90.1] will occur. After the power-on, perform the home position return in advance.

Set link devices and parameters as follows:

Item	Used device/parameter	Setting
Home position return mode selection	RYn6 (Automatic/manual selection)	Switch on RYn6.
	RWwn6 (Point table No. selection)	Set "0" in RWwn6.
Home position return speed	[Pr. PT05]	Set the servo motor speed to travel to the home position.
Home position return acceleration/ deceleration time constant	Acceleration time constant: [Pr. PT56] Deceleration time constant: [Pr. PT56] (for when [Pr. PT55] is set to "___0") [Pr. PT57] (for when [Pr. PT55] is set to "___1")	Set an acceleration time constant and deceleration time constant.

Set the home position return speed of the automatic positioning to home position function with [Pr. PT05]. Set the acceleration time constant with [Pr. PT56]. Select the deceleration time constant from [Pr. PT56] and [Pr. PT57] using the setting value of [Pr. PT55]. Turning on RYn2 (Reverse rotation start) executes the automatic return function to the home position.

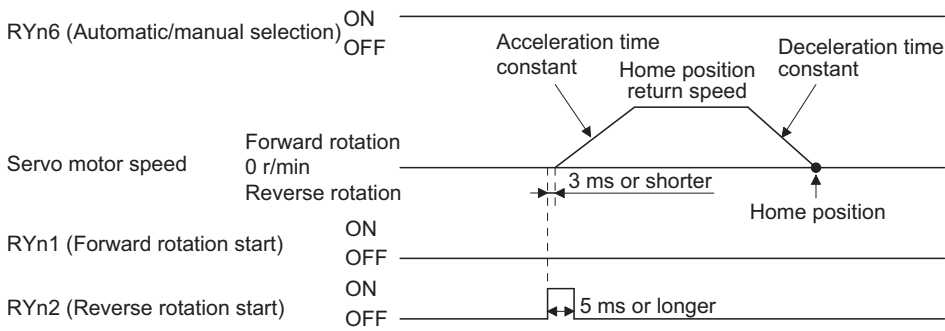

## 2.6 Point table setting method

The following shows the setting method of point tables using MR Configurator2.

### Setting procedure

Click "Positioning-data" in the menu bar, and click "Point Table" in the menu.

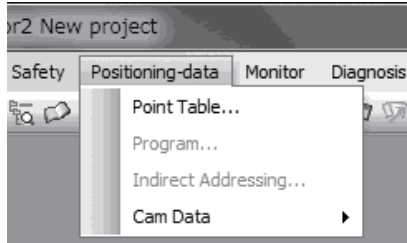

The following window will be displayed by clicking.

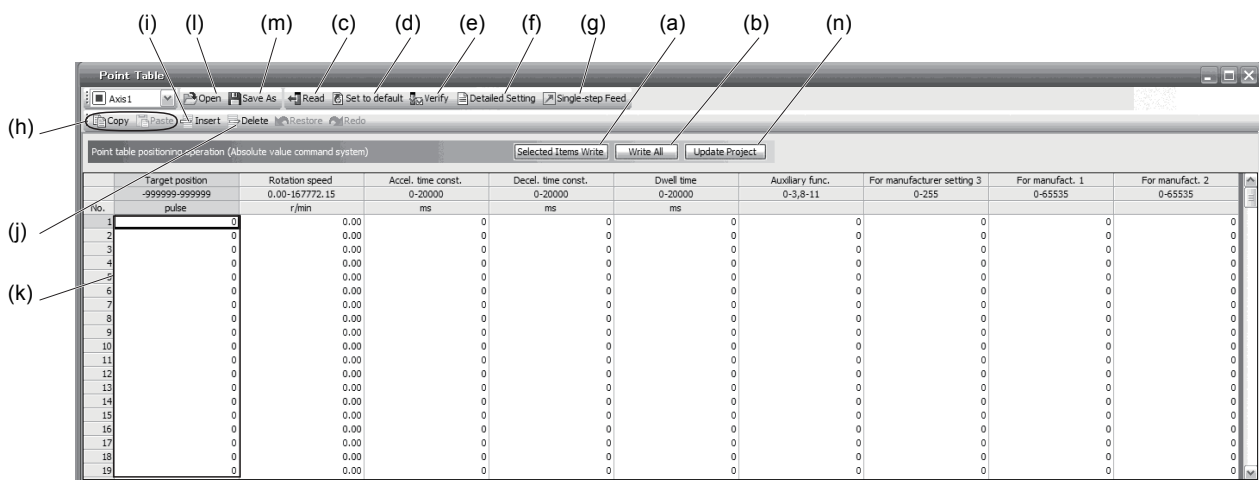

#### Writing point table data (a)

Select changed point table data and click "Selected Items Write" to write the changed point table data to the servo amplifier.

#### Writing all point table data (b)

Click "Write All" to write all the point table data to the servo amplifier.

#### Reading all point table data (c)

Click "Read" to read and display all the point table data from the servo amplifier.

#### Initial setting of point table data (d)

Click "Set to default" to initialize all the data of point table No. 1 to 255. This function also initializes data currently being edited.

#### Verifying point table data (e)

Click "Verify" to verify all the data displayed and data of the servo amplifier.

### Detailed setting of point table data (f)

Click "Detailed Setting" to change position data range and unit in the point table window.

☞ Page 102 Detailed setting window

### Single-step feed (g)

Click "Single-step Feed" to perform the single-step feed test operation.

☞ Page 140 Network setting parameters ([Pr. PN\_ \_])

☞ Page 103 Single-step feed

### Copy and paste of point table data (h)

Click "Copy" to copy the selected point table data. Click "Paste" to paste the copied point table data.

### Inserting point table data (i)

Click "Insert" to insert a block to the previous row from the selected point table No. The selected point table No. and lower rows will be shifted down one by one.

### Deleting point table data (j)

Click "Delete" to delete all the data of the point table No. selected. The lower rows of the selected point table No. will be shifted up one by one.

### Changing point table data (k)

After selecting the data to be changed, enter a new value, and click "Enter". You can change the displayed range and unit with the following.

☞ Page 101 Detailed setting of point table data (f)

### Reading point table data (l)

Click "Open" to read the point table data.

### Saving point table data (m)

Click "Save As" to save the point table data.

### Updating project (n)

Click "Update Project" to update the point table data to a project.

## Detailed setting window

You can change position data range and unit with the detailed setting for the point table window. For the position data range and unit of [Pr. PT01] setting, refer to the following. To reflect the setting for the corresponding parameter, click "Update Project" in the point table window.

☞ Page 56 Automatic operation using point table

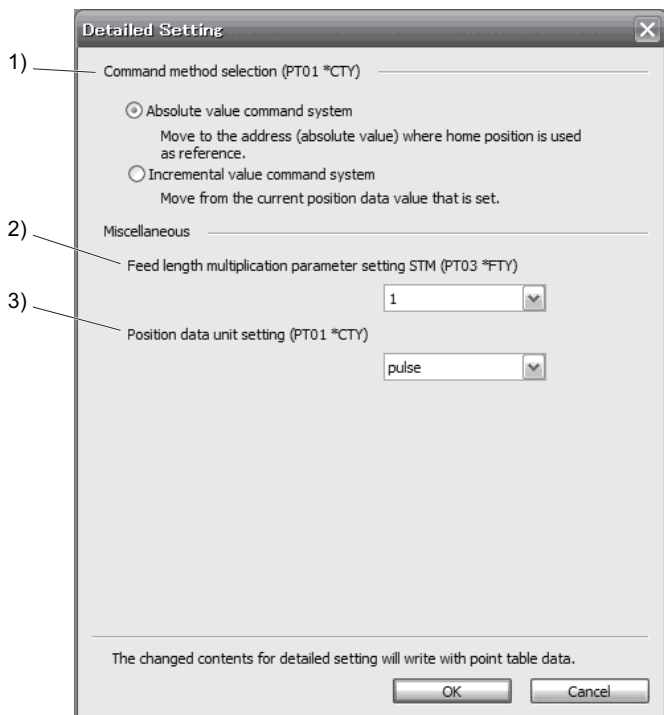

### Command method selection (PT01 \*CTY): 1)

Select a positioning command method from the absolute position command method and incremental value command method.

### Miscellaneous

#### ■ Feed length multiplication parameter setting STM (PT03 \*FTY): 2)

Select any feed length multiplication from 1/10/100/1000.

#### ■ Position data unit setting (PT01 \*CTY): 3)

Select any unit of position data from mm/inch/degree/pulse. While degree or pulse is selected, setting of feed length multiplication will be disabled.



# Single-step feed

## CAUTION

- The test operation mode is designed for checking servo operation. Do not use it for actual operation.
- If the servo motor operates unexpectedly, use EM2 (Forced stop 2) to stop it.

2

### Point

- MR Configurator2 is required to perform single-step feed.
- Test operation cannot be performed unless RYn0 (Servo-on) is not turned off.

The positioning operation can be performed in accordance with the point table No. set by MR Configurator2. Select the test operation/single-step feed by the menu of MR Configurator2. When the single-step feed window is displayed, input the following items and operate.

## Point table operation

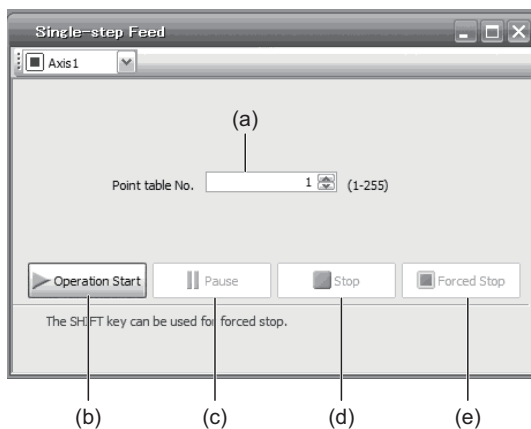

### ■ Point table No. setting

Input a point table No. into the input box (a) "Point table No."

### ■ Forward/reverse the servo motor

Click "Operation Start" (b) to rotate the servo motor.

### ■ Pause the servo motor

Click "Pause" (c) to temporarily stop the servo motor.

While the servo motor is temporarily stopped, click "Operation Start" (b) to restart the rotation by the travel remaining distance.

While the servo motor is temporarily stopped, click "Stop" (d) to clear the travel remaining distance.

### ■ Stop the servo motor

Click "Stop" (d) to stop the servo motor. At this time, the travel remaining distance is cleared. Click "Operation Start" (b) to restart the rotation.

### ■ Forced stop of the servo motor software

Click "Forced Stop" (e) to make an instantaneous stop. When "Forced Stop" is enabled, "Operation Start" cannot be used. Click the "Forced Stop" again to enable the "Operation Start".

### ■ Switch to the normal operation mode

Before switching from the test operation mode to the normal operation mode, turn off the servo amplifier.

## 2.7 Application of the point table function

### Infinite feed function (setting degree)



This function is supported by the absolute position detection system.

The infinite feed function (setting degree) is available with servo amplifiers with software version A6 or later.

The infinite feed function (setting degree) can be used with the point table method.

If the position data unit for the automatic or manual operation in the point table method is set to degree, [AL. E3.1 Multi-revolution counter travel distance excess warning] will not occur even if the servo motor is rotated 32768 rev or more in one direction, making the home position remain. Therefore, the current position will be restored after the power is cycled. If the other command unit is set, rotating the servo motor 32768 rev or more in one direction will trigger [AL. E3.1 Multi-revolution counter travel distance excess warning] erasing the home position.

The following shows the difference depending on the position data unit when the servo motor is rotated 32768 rev or more.

Parameter	Name	Digit to be set	Setting value	Unit	[AL. E3.1]	Whether the home position is to be erased or not
[Pr. PT01]	Position data unit	_ x _ _	0	[mm]	Occurs	Erased
			1	[inch]	Occurs	Erased
			2	[degree]	Does not occur	Not erased
			3	[pulse]	Occurs	Erased

### Roll feed display function

The roll feed display function changes how the current position and the command position are to be displayed on the status monitor. The function can be used on the incremental system while in the automatic individual positioning operation.

The display starts the current position and the command position from 0 every time the position moves towards the target position of the point table that has been set. The target position can also be checked with the command position before start.



The roll feed display function is available for servo amplifiers with software version A7 or later.

The roll feed display function can be used only with the positioning mode (point table method).

#### Parameter setting

Parameter	Name	Digit to be set	Setting item	Setting value	Setting
PA03	Absolute position detection system	___ x	Absolute position detection system	___ 0 (initial value)	Be sure to set the incremental system. The absolute position detection system cannot be used.
PT26	Current position/ command position display selection	__ x _	Current position/ command position display selection	__ 1 _	Select the roll feed display.
PT26	Electric gear fraction clear selection	___ x	Electric gear fraction clear selection	___ 1	Clears the electric gear fraction of the previous command at the start of automatic operation. Be sure to set "Electronic gear clear" to "___ 1" (enabled).

## Roll feed display function

### ■In normal use

When the roll feed display function is used, the status display of the current position and command position at a start becomes 0. When the point table is selected, the function displays the target position of the point table set in the command position.

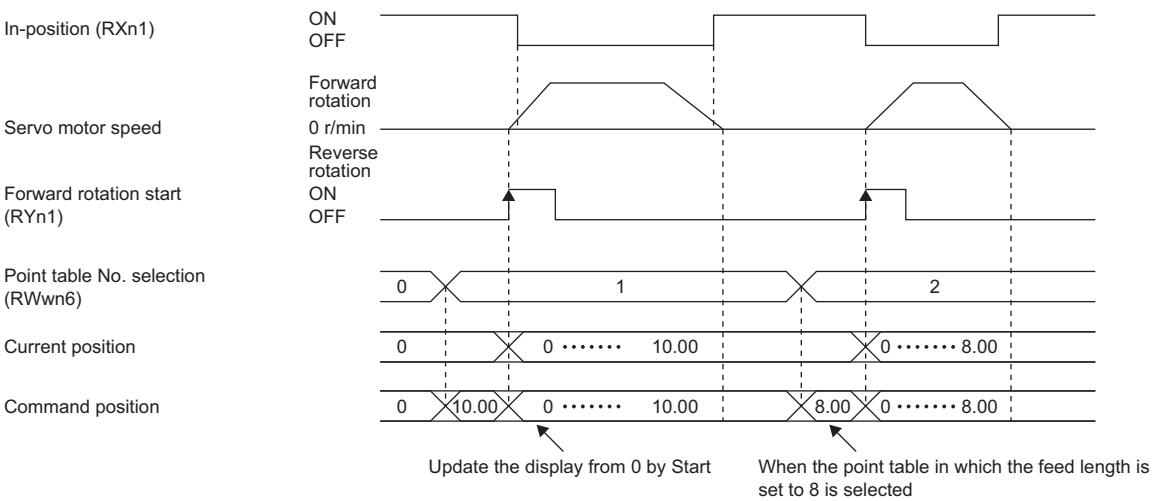

### ■At temporary stop

The motor stop position for both the current position and command position will be displayed at temporary stop. Once the servo motor restarts after the temporary stop is released, the current position and the command position will be updated from the positions where they had stopped.

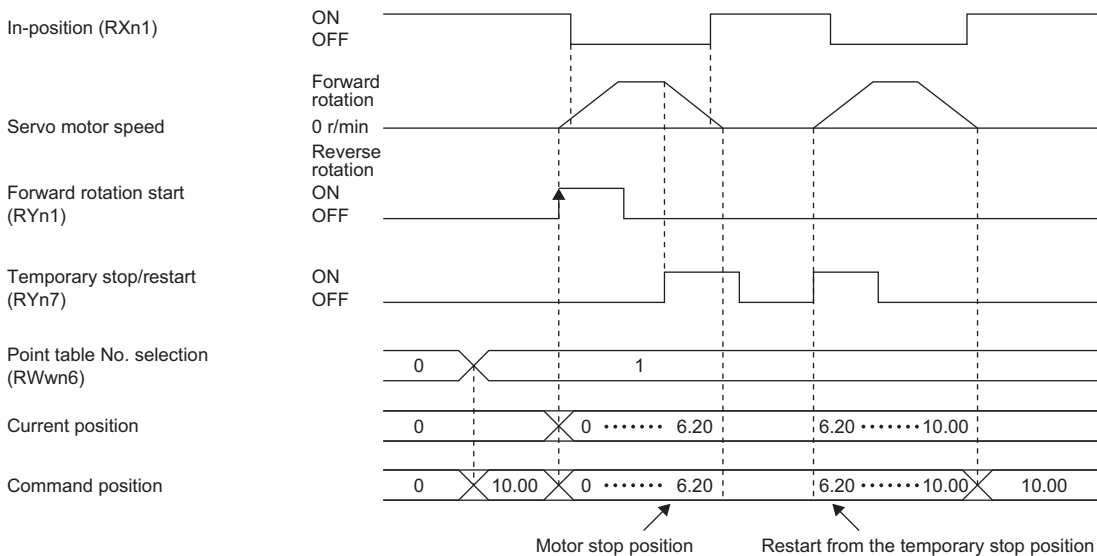

## ■At "Clear" input

When "Clear" (RYnF) is input, the remaining travel distance will be cleared and the target position of the point table will be displayed again in the command position.

The current position and the command position will start from 0 when the motor restarts.

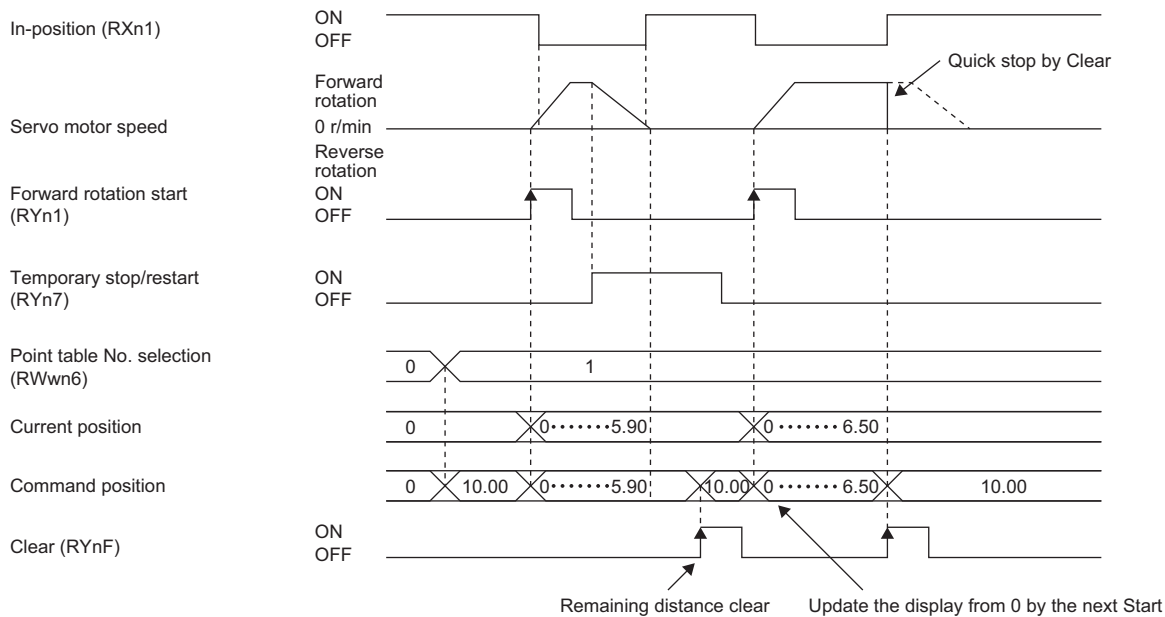

## Position data unit

The displayed unit is the unit set in [Pr. PT01], and the feed length multiplication is displayed in the unit set in [Pr. PT03].

The setting for degree unit is disabled in the roll feed display function.

Refer to section 14.5.1 for details.

## Backlash compensation

Setting [Pr. PT14 Backlash compensation] stops the servo motor at a position compensated by the setting value of this parameter when a command direction in automatic operation is reversed.

### Point

Backlash compensation is available with servo amplifiers with software version A8 or later.

Before using this function, press a workpiece against the machine side so that the clearance between parts such as gear teeth on the machine side and the motor side or between feed screws will be generated only on one side.

The timing charts are for when the backlash compensation is set to 10 and the target position is set as shown in the following table.

Point table No.	Target position [pulse]
1	1000
2	2000

## For home position return types where the servo motor operates at home position return

The backlash compensation direction will be determined by the home position return direction just before the completion of home position return.

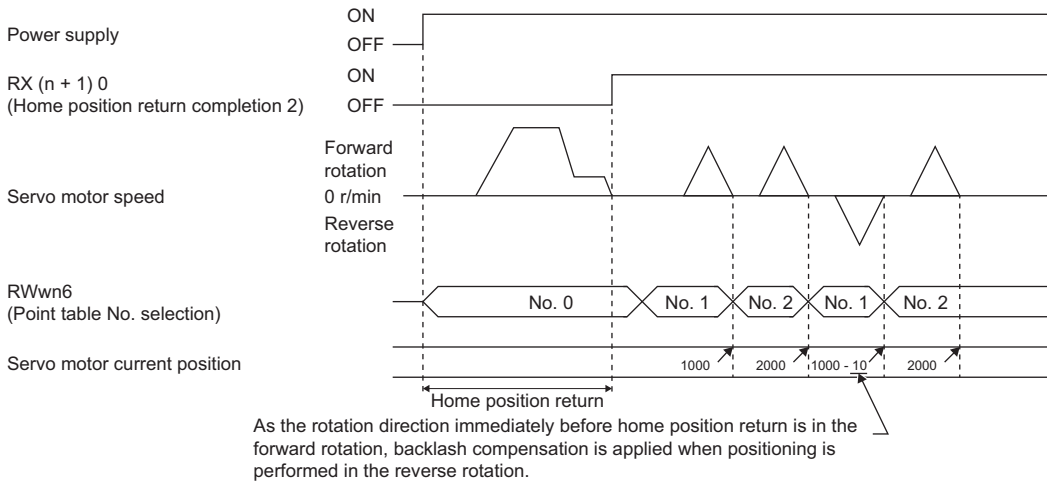

## For home position return types where the servo motor does not operate at home position return

The backlash compensation direction will be determined by "Backlash compensation direction selection at data set type home position return" in [Pr. PT38] as follows:

### ■When [Pr. PT38] is set to "0 \_ \_ \_" (automatic setting)

Be sure to perform JOG operation before home position return, then press gears or feed screws on the motor side against the machine side.

The backlash compensation direction will be determined by the motor rotation direction just before the completion of home position return.

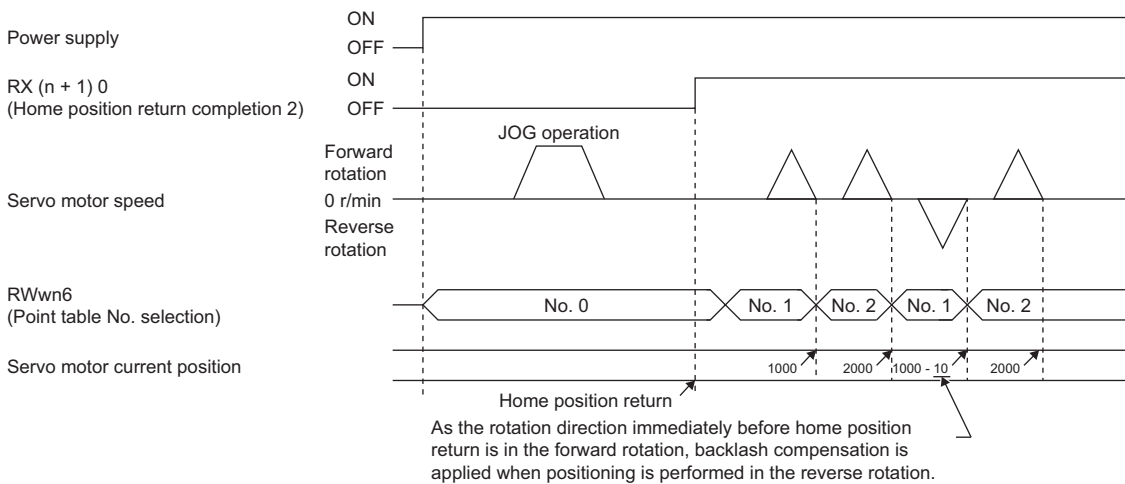

■When [Pr. PT38] is set to "1 \_ \_ \_" (CCW direction or positive direction) or "2 \_ \_ \_" (CW or negative direction)

The compensation will apply to the set direction.

Before home position return, be sure to press gears or feed screws on the motor side against the machine side in the opposite direction of the compensation direction set in [Pr. PT38].

The following timing chart is for when [Pr. PT38] is set to "1 \_ \_ \_" (CCW direction or positive direction).

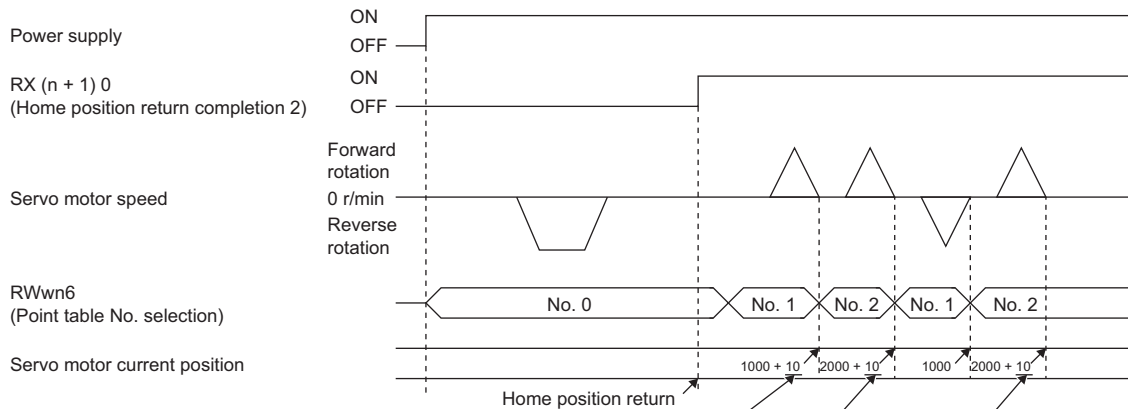

The compensation will be applied to the compensation direction set in [Pr. PT38].

## 2.8 Programming example by function

This section explains specific programming examples for operating or monitoring the servo and for reading or writing parameters based on the device configuration shown in the following section.

☞ Page 109 System configuration example

### System configuration example

As shown below, a CC-Link IE Field Network master/local module is mounted to operate two servo amplifiers.

#### System configuration

Programmable controller

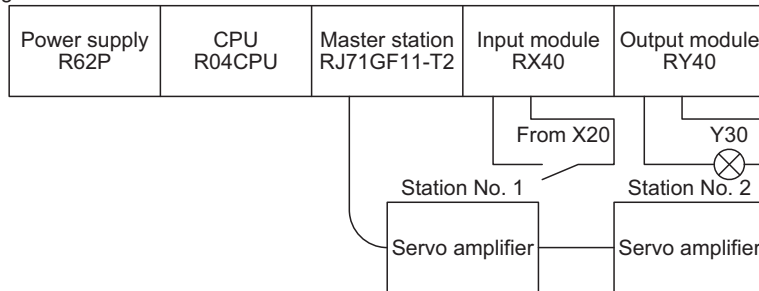

#### Network parameter setting in the master station

In the programming examples, the network parameters are set as follows:

Item	Setting condition	
Start I/O No.	0000	
Operation setting	Data link error station setting	Clear
	Setting at CPU STOP	Held
Type	Master station	
Mode setting	Standard	
Total No. of connected units	2	
Remote input (RX) Refresh device	X1000	
Remote output (RY) Refresh device	Y1000	
Remote register (RWr) Refresh device	W0	
Remote register (RWw) Refresh device	W100	
Special relay (SB) Refresh device	SB0	
Special register (SW) Refresh device	SW0	
CPU down specification	Clear	
Scan mode specification	Asynchronous sequence scan	

## Assignment of remote inputs/outputs (RX, RY)

The following shows the assignment of remote inputs/outputs (RX, RY) of the station to the devices of the programmable controller CPU.

The devices actually used are shaded.

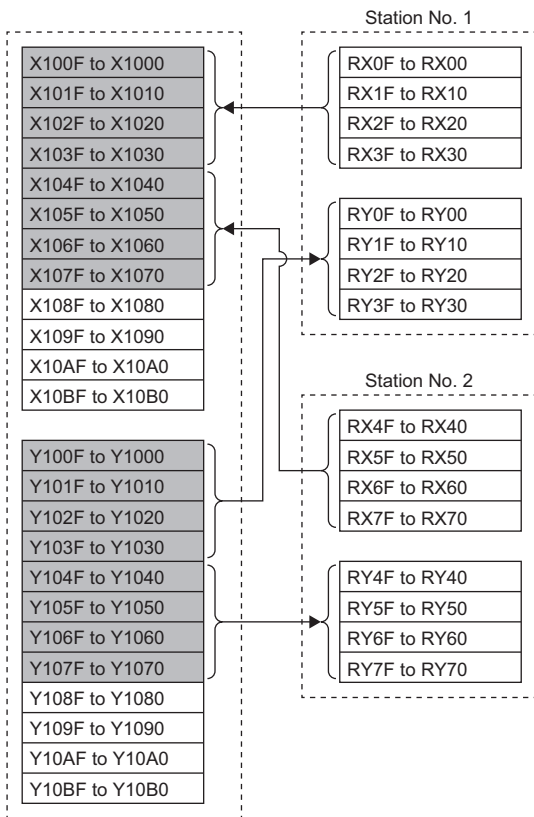



## Assignment of remote registers (RWw, RWr)

The following shows the assignment of remote registers (RWw, RWr) of the station to the devices of the programmable controller CPU.

The devices actually used are shaded.

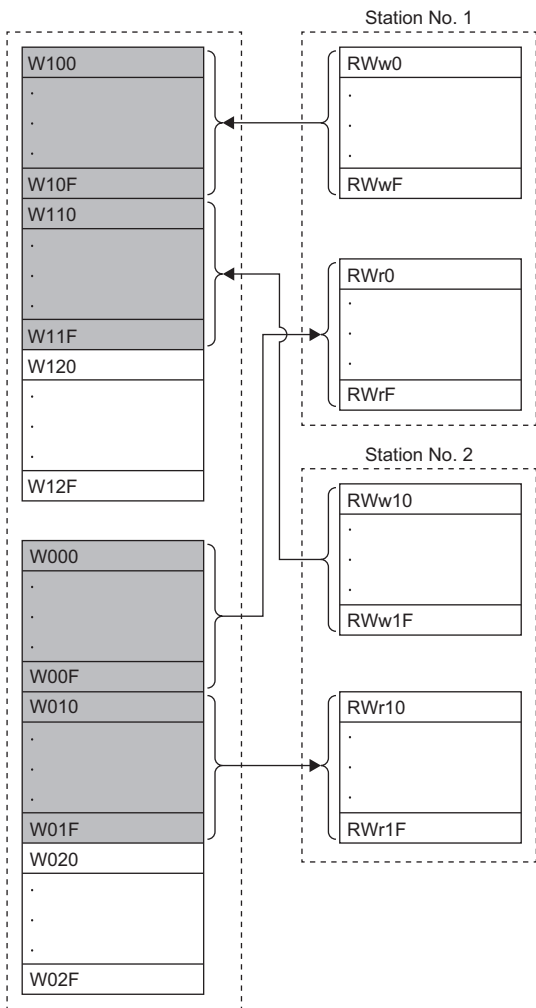

# Reading the servo amplifier status

When the servo amplifier with station No. 1 enters remote station communication ready, the output module Y30 turns on. This program turns on Y30 when the CC-Link IE Field Network communication is normally established.

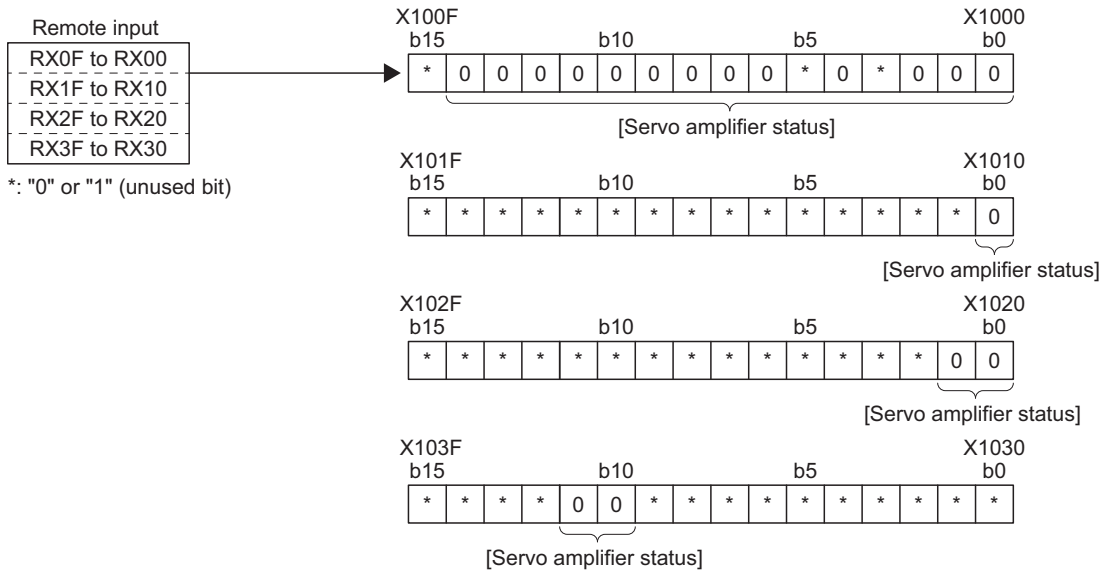
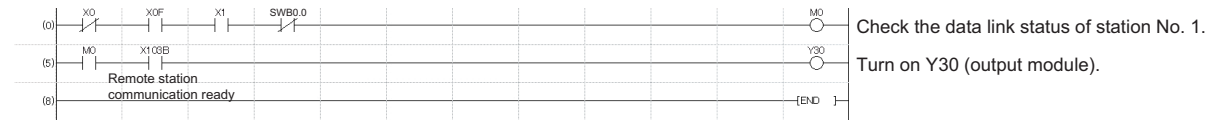

## Servo amplifier status

X1000: RD (Ready)	X1016: ---	X102C: ---
X1001: INP (In-position)	X1017: ---	X102D: ---
X1002: CPO (Rough match)	X1018: ---	X102E: ---
X1003: ---	X1019: ---	X102F: ---
X1004: TLC (Limiting torque)	X101A: ---	X1030: ---
X1005: ---	X101B: ---	X1031: ---
X1006: MBR (Electromagnetic brake interlock)	X101C: ---	X1032: ---
X1007: PUS (Temporary stop)	X101D: ---	X1033: ---
X1008: MOF (Monitoring)	X101E: ---	X1034: ---
X1009: COF (Instruction code execution completion)	X101F: ---	X1035: ---
X100A: WNG (Warning)	X1020: PSF (Position command execution completion)	X1036: ---
X100B: BWNG (Battery warning)	X1021: SPF (Speed command execution completion)	X1037: ---
X100C: MEND (Travel completion)	X1022: ---	X1038: ---
X100D: DB (Dynamic brake interlock)	X1023: ---	X1039: ---
X100E: POT (Position range)	X1024: ---	X103A: ALM (Malfunction)
X100F: ---	X1025: ---	X103B: CRD (Remote station communication ready)
X1010: ZP2 (Home position return completion 2)	X1026: ---	X103C: ---
X1011: ---	X1027: ---	X103D: ---
X1012: ---	X1028: ---	X103E: ---
X1013: ---	X1029: ---	X103F: ---
X1014: ---	X102A: ---	
X1015: ---	X102B: ---	

# Writing an operation command

The servo amplifier with station No. 1 performs positioning operation according to point table No. 2.  
Turning on X20 starts the operation.

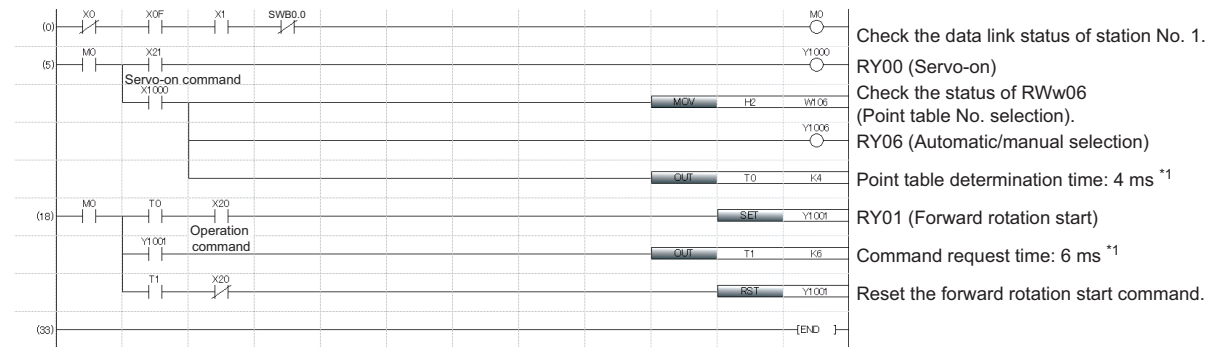

\*1 This time is for when the set time of the high-speed timer is 1 ms.  
Set the doubled link scan time or command processing time, whichever is the larger, as the set time of the timer. If the set time is short, commands may not be accepted normally.

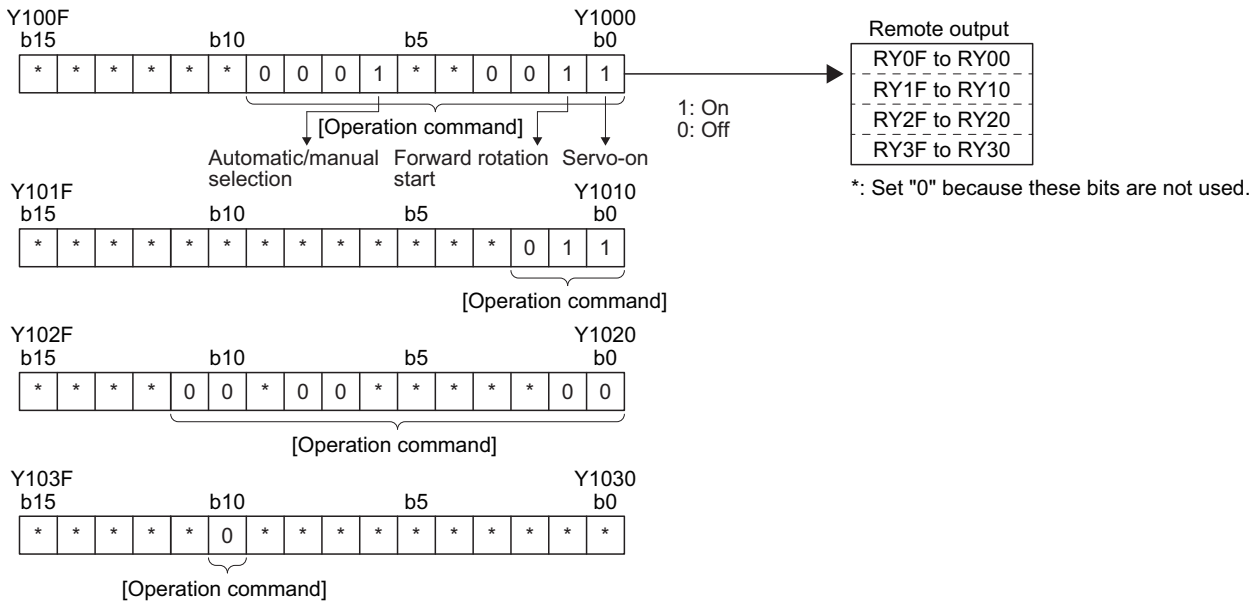

## Operation command

Y1000: SON (Servo-on)	Y1016: ---	Y102C: ---
Y1001: ST1 (Forward rotation start)	Y1017: ---	Y102D: ---
Y1002: ST2 (Reverse rotation start)	Y1018: ---	Y102E: ---
Y1003: DOG (Proximity dog)	Y1019: ---	Y102F: ---
Y1004: ---	Y101A: ---	Y1030: ---
Y1005: ---	Y101B: ---	Y1031: ---
Y1006: MD0 (Automatic/manual selection)	Y101C: ---	Y1032: ---
Y1007: TSTP (Temporary stop/restart)	Y101D: ---	Y1033: ---
Y1008: MOR (Monitor output execution demand)	Y101E: ---	Y1034: ---
Y1009: COR (Instruction code execution demand)	Y101F: ---	Y1035: ---
Y100A: ---	Y1020: PSR (Position command execution demand)	Y1036: ---
Y100B: ---	Y1021: SPR (Speed command execution demand)	Y1037: ---
Y100C: ---	Y1022: ---	Y1038: ---
Y100D: ---	Y1023: ---	Y1039: ---
Y100E: ---	Y1024: ---	Y103A: RES (Reset)
Y100F: ---	Y1025: ---	Y103B: ---
Y1010: FLS (Upper stroke limit)	Y1026: ---	Y103C: ---
Y1011: RLS (Lower stroke limit)	Y1027: PC (Proportional control)	Y103D: ---
Y1012: ORST (Operation alarm reset)	Y1028: CDP (Gain switching)	Y103E: ---
Y1013: ---	Y1029: ---	Y103F: ---
Y1014: ---	Y102A: CSL (Position/speed specifying method selection)	
Y1015: ---	Y102B: CAOR (Absolute value/incremental value selection)	

# Reading data

Data of the servo amplifier is read.

## Reading monitor

The cumulative feedback pulses of the servo amplifier with station No. 2 are read to D10.

Code No.	Description
H000A	Cumulative feedback pulse data (hexadecimal)

Turning on X20 reads the monitor of the cumulative feedback pulses.

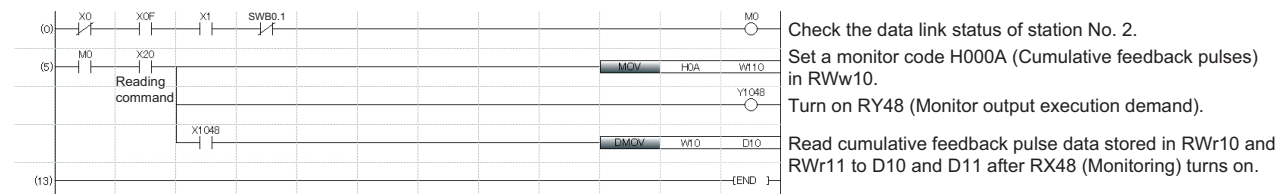

## Reading parameters

[Pr. PA04 Function selection A-1] of the servo amplifier with station No. 2 is read to D1.

Code No.	Description
H8200	Select the parameter group.
H0204	Setting value in [Pr. PA04] (hexadecimal)

Turning on X20 reads [Pr. PA04].

A respond code at the execution of the instruction code is set in D3.

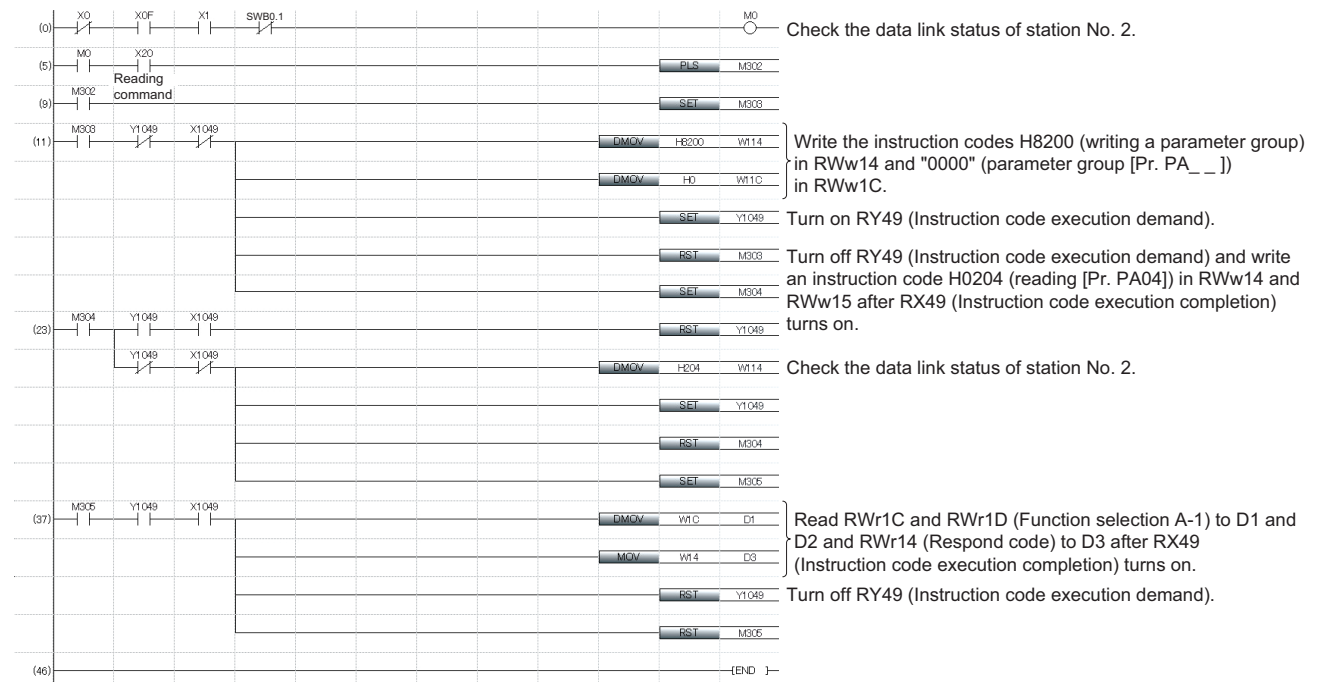

## Reading an error

An error of the servo amplifier with station No. 2 is read to D1.

Code No.	Description
H0010	Alarm or warning that is currently occurring (hexadecimal)

Turning on X20 reads the current alarm.

A respond code at the execution of the instruction code is set in D3.

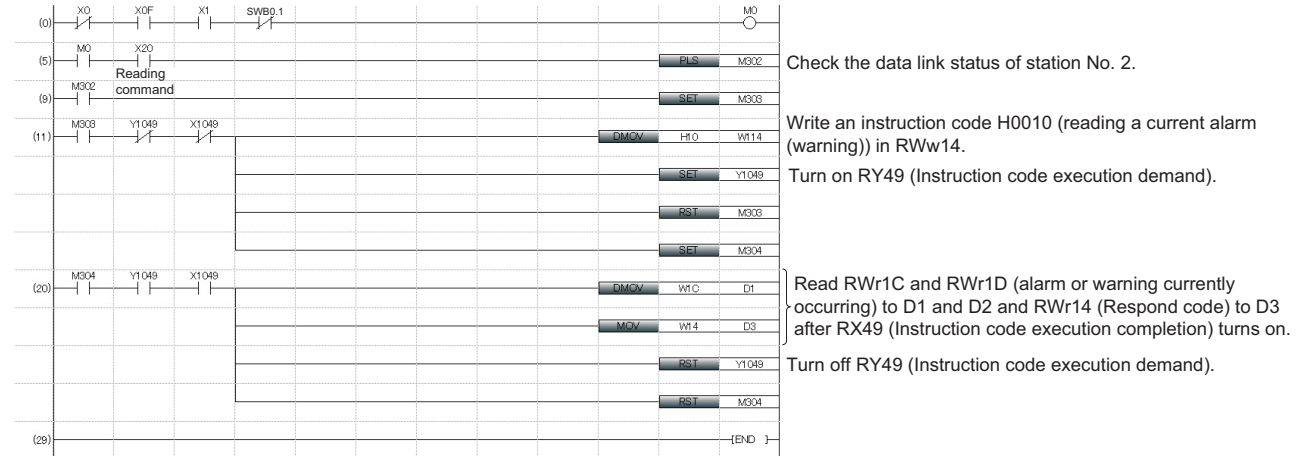

# Writing data

This section explains programs for writing data to the servo amplifiers.

## Writing servo motor speed data of a point table

The servo motor speed data of point table No. 1 of station No. 2 is changed to "100".

Code No.	Description
H8D01	Write the servo motor speed data of point table No. 1 (hexadecimal).

Setting data	Description
K100	Servo motor speed data of point table No. 1 (decimal)

Turning on X20 writes the servo motor speed data of point table No. 1.  
 A respond code at the execution of the instruction code is set in D3.

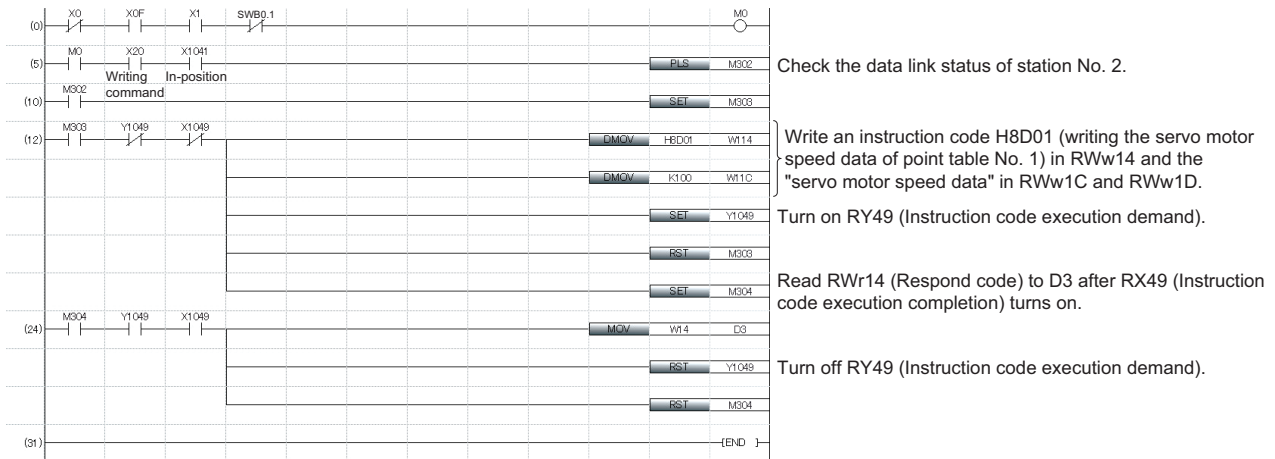

## Writing parameters

The parameter [Pr. PT65 JOG speed] of the servo amplifier with station No. 2 is changed to "100".

Specify the parameter group PT as follows:

Code No.	Description
H8200	Selecting the parameter group

Setting data	Description
H000C	Setting data (hexadecimal)

The parameter [Pr. PT65] is changed to "100" as follows:

Code No.	Description
H8241	Write [Pr. PT65] (hexadecimal).

Setting data	Description
K100	Setting data (decimal)

Turning on X20 writes [Pr. PT65].

A respond code at the execution of the instruction code is set in D3.

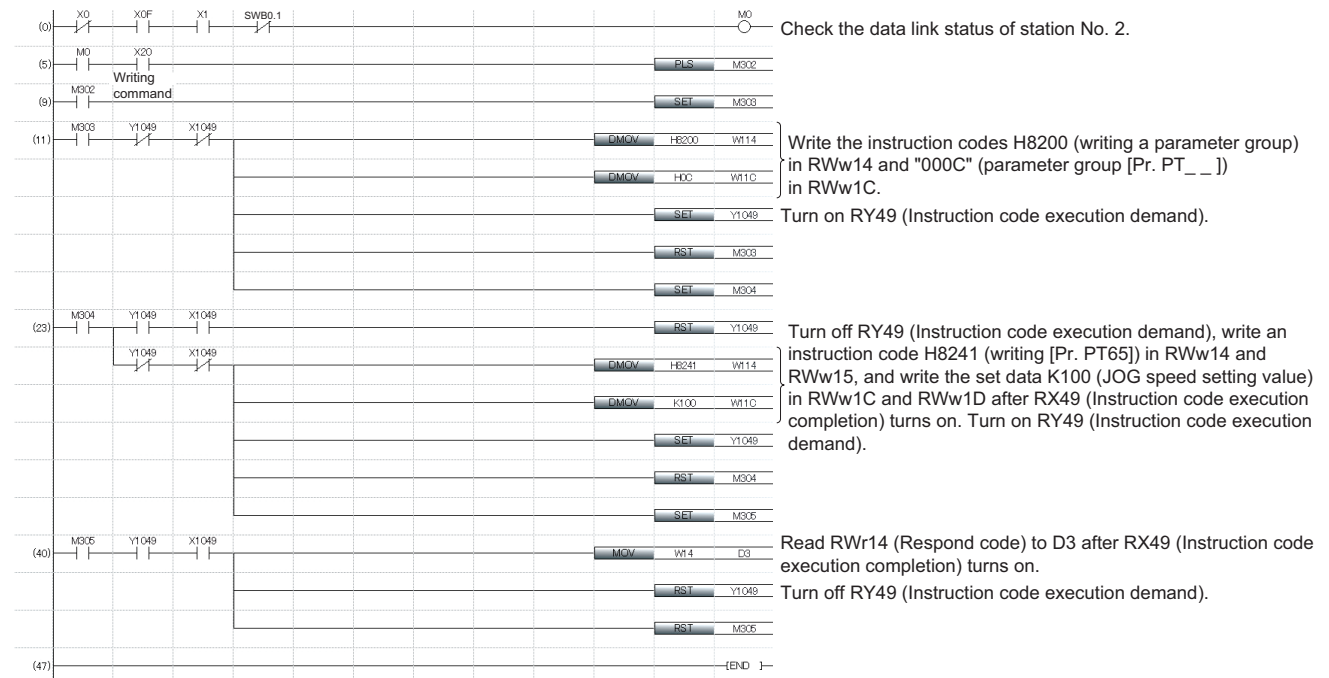



## Program example for resetting an alarm of the servo amplifier

A command from the programmable controller clears an alarm occurring in the servo amplifier with station No. 2.

Turning on X20 clears an alarm occurring in the servo amplifier.

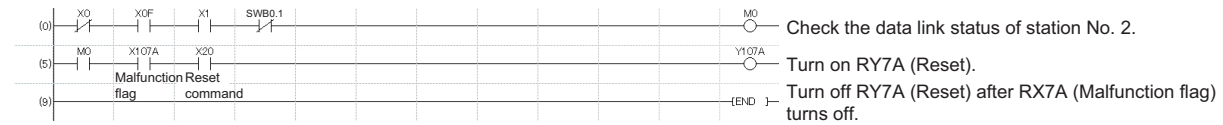

An instruction code clears an alarm in the servo amplifier with station No. 2.

Code No.	Description
H8010	Alarm reset command (hexadecimal)

Setting data	Description
1EA5	Execution data (hexadecimal)

Turning on X20 resets the servo amplifier.

A respond code at the execution of the instruction code is set in D3.

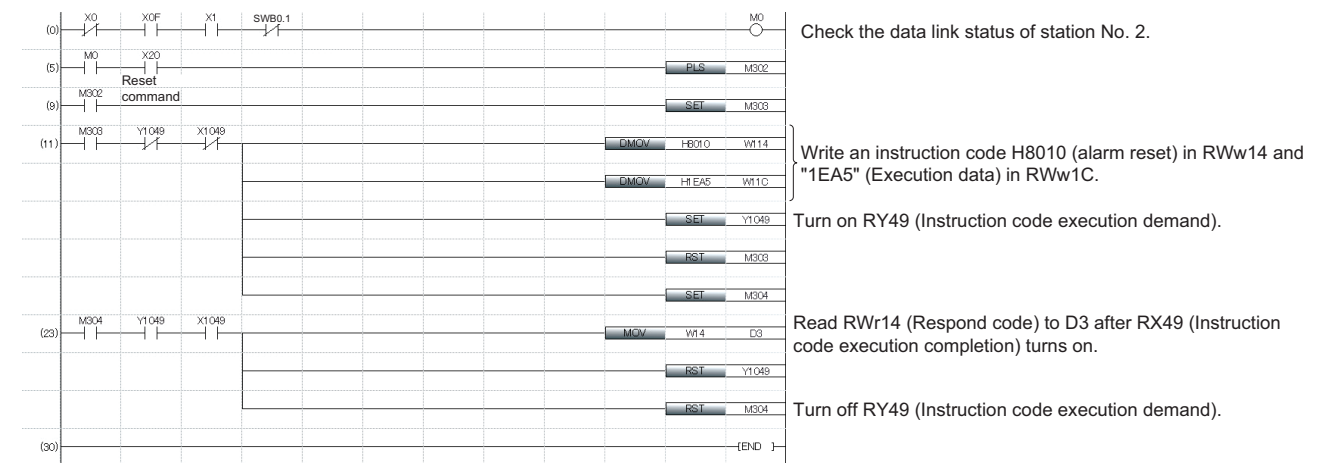

# Operation

This section explains programs for operating the servo amplifiers.

## JOG operation

The servo amplifier with station No. 1 performs JOG operation and reads the "current position".

Code No.	Description
H0001	Current position data (hexadecimal)

Turning on X22 starts forward rotation JOG operation.

Turning on X23 starts reverse rotation JOG operation.

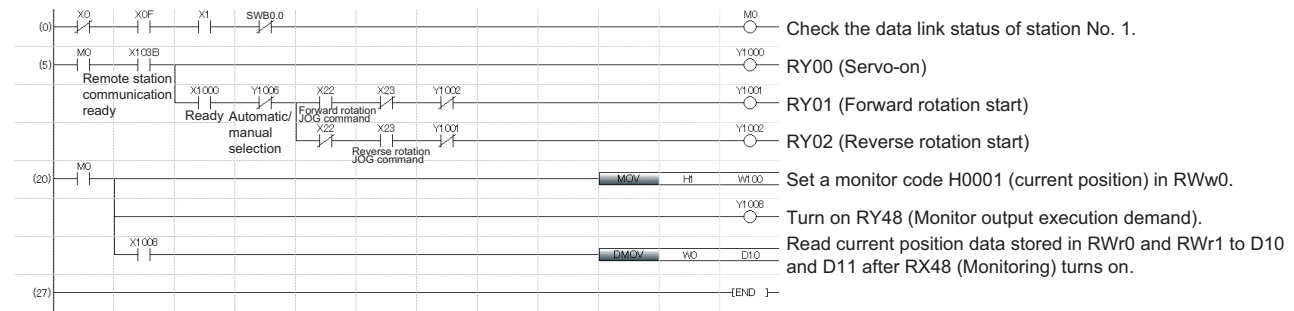

## Setting position data and speed data with remote registers

The servo amplifier with station No. 2 is operated with position data of "100000" and speed data of "1000" specified with the direct specification mode.

Set [Pr. PT62] to "\_ \_ \_ 2" in advance.

Setting data	Description
K100000	Position command data (decimal)
K1000	Speed command data (decimal)

Turning on X20 starts positioning operation according to the position and speed settings specified with the remote registers.

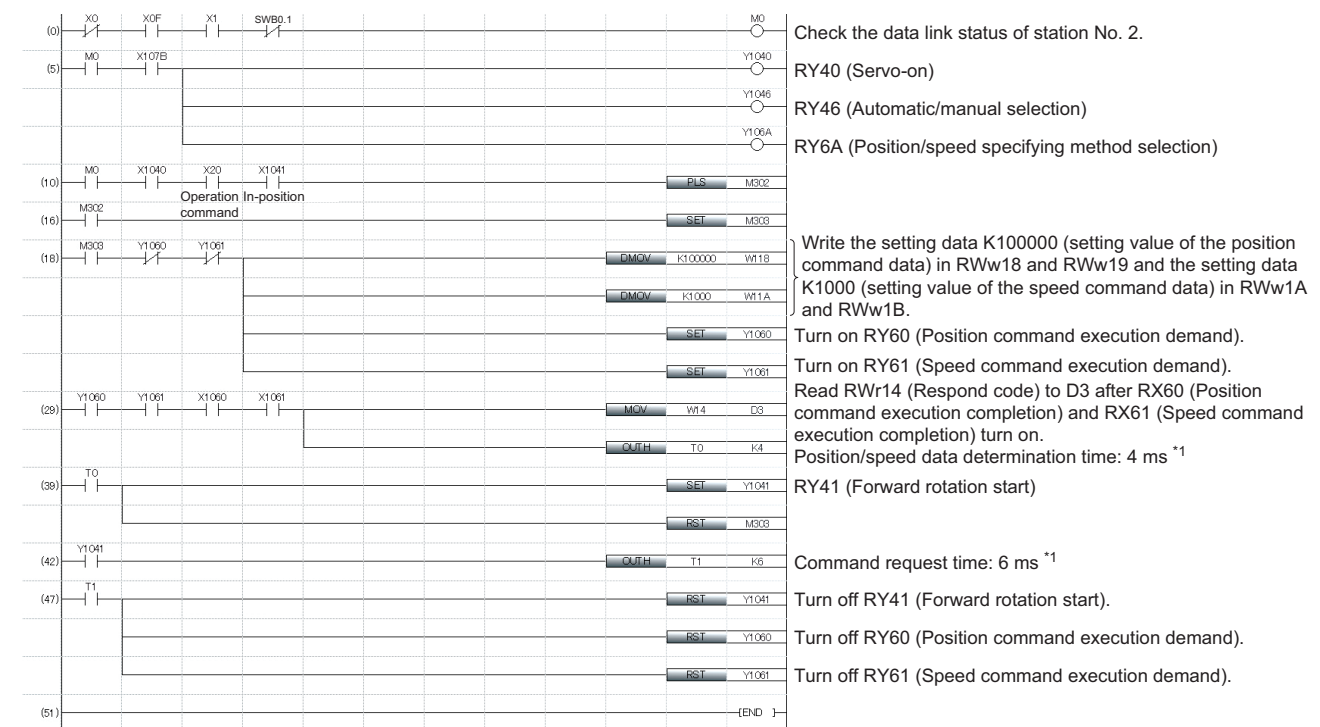

\*1 This time is for when the set time of the high-speed timer is 1 ms.  
Set the doubled link scan time or command processing time, whichever is the larger, as the set time of the timer. If the set time is short, commands may not be accepted normally.

## Setting the point table No. with remote registers (incremental value command method)

The servo amplifier with station No. 2 is operated with the incremental value and point table No. 5 specified in the direct specification mode.

Set [Pr. PT62] to "\_\_\_0" in advance.

Setting data	Description
K5	Point table No. (decimal)

Turning on X20 starts positioning operation according to point table No. 5.

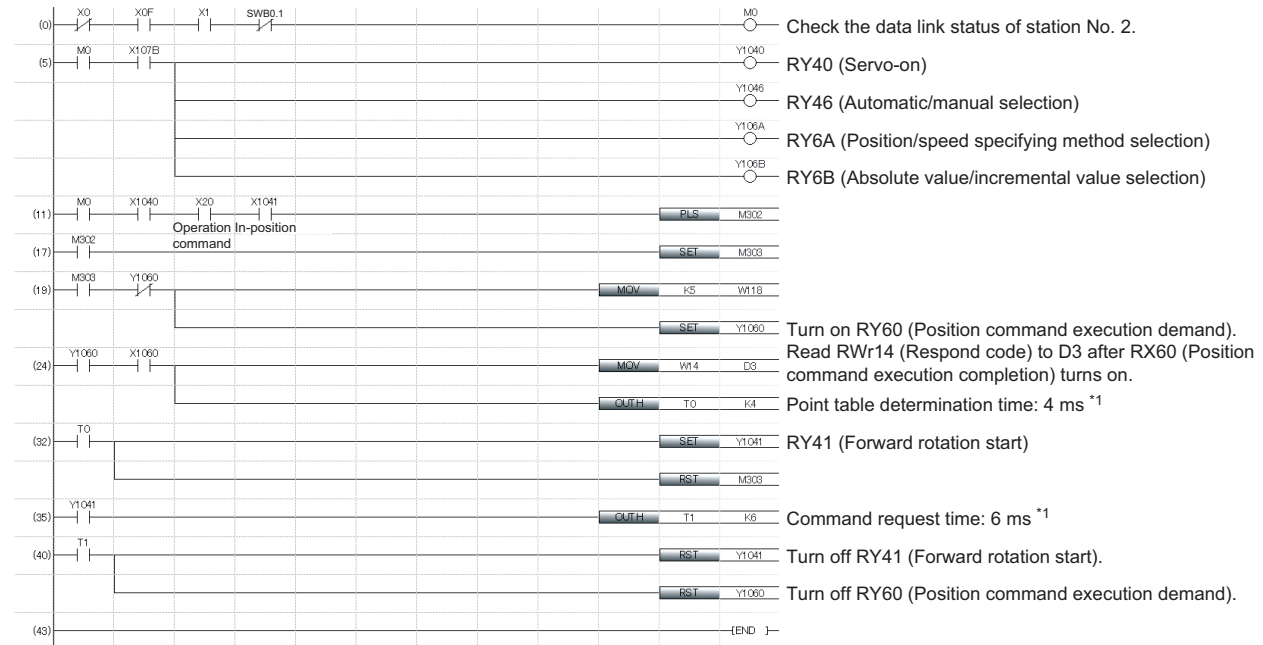

\*1 This time is for when the set time of the high-speed timer is 1 ms.

Set the doubled link scan time or command processing time, whichever is the larger, as the set time of the timer. If the set time is short, commands may not be accepted normally.

## 2.9 Program example for continuous operation

This section shows program examples including operations from servo start-up to a series of CC-Link IE communication. The examples use the following device configuration.

As shown below, a CC-Link system master/local module is mounted to operate one servo amplifier.

Programmable controller

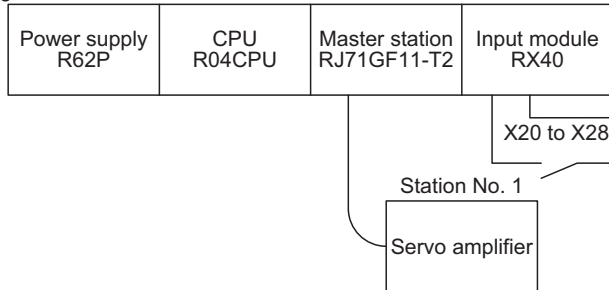

Input signal assignment

Input signal	Signal name	Operation at input ON
X20	Reset command	The servo amplifier is reset when an alarm has occurred.
X21	Servo-on command	The servo-on is activated.
X22	Forward rotation JOG command	When the manual operation mode is set, forward rotation JOG operation is performed.
X23	Reverse rotation JOG command	When the manual operation mode is set, reverse rotation JOG operation is performed.
X24	Automatic/manual selection	Off: Manual operation mode On: Automatic operation mode
X25	Home position return command	When the automatic operation mode is set and home position return has not been completed, the dog type home position return is performed.
X26	Proximity dog command	Off: Proximity dog ON <sup>*1</sup> On: Proximity dog OFF
X27	Position start command	When the automatic operation mode is set and home position return has been completed, positioning operation is performed according to the position and speed settings specified with the remote registers.
X28	Position/speed specifying method switching command	This signal enables the remote register-based position/speed specifying method.

\*1 This setting is for when [Pr. PT29] is set to "\_\_\_0" (Dog detection with off).

The servo amplifier with station No. 1 performs positioning operation and reads the servo motor speed data.

Set [Pr. PT62] to "\_\_\_2" in advance.

Operation: Alarm reset, dog type home position return, JOG operation, automatic operation with position command data and speed command data

Code No.	Description
H0016	32-bit motor speed data (hexadecimal)

Setting data	Description
K50000	Position command data (decimal)
K100	Speed command data (decimal)



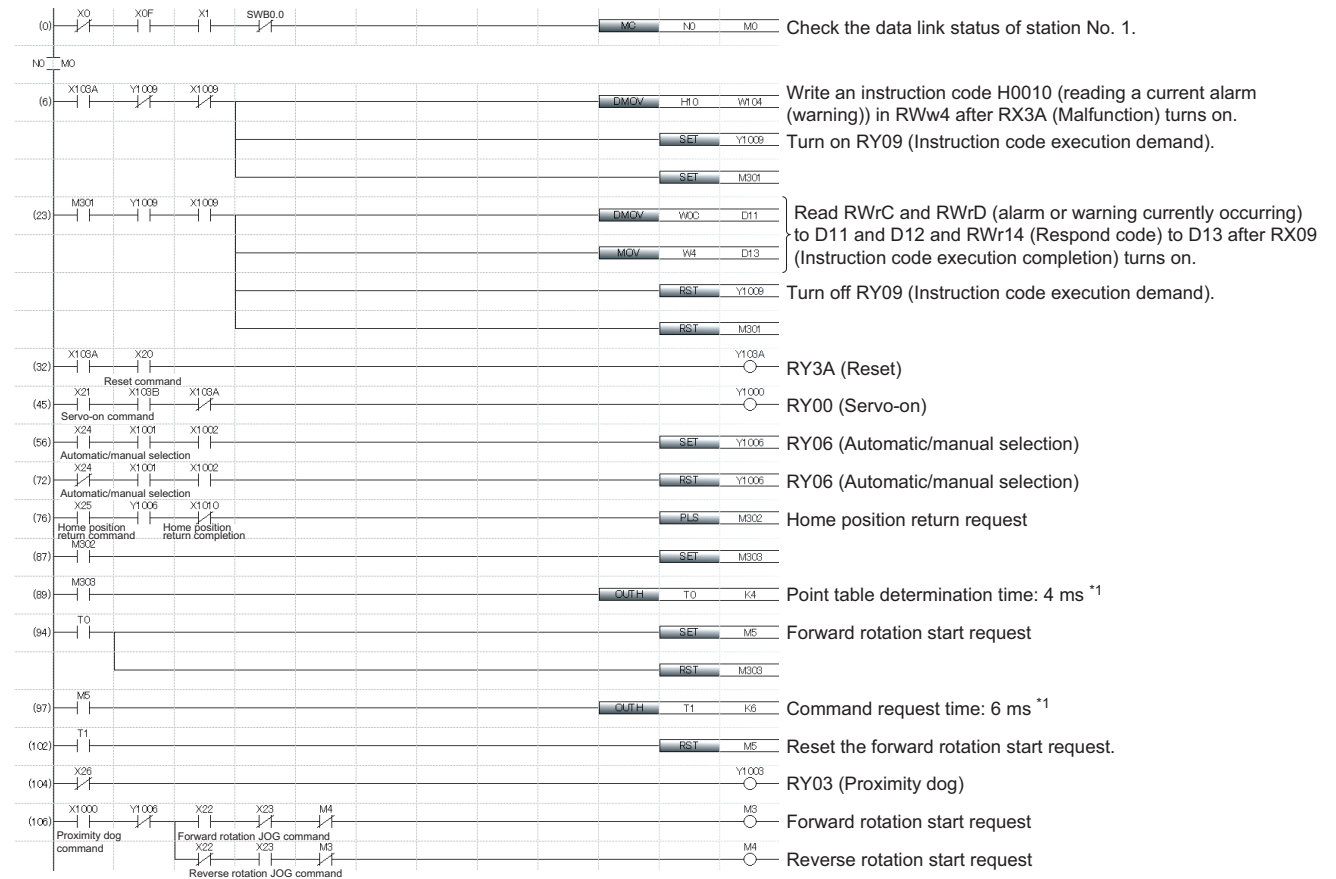

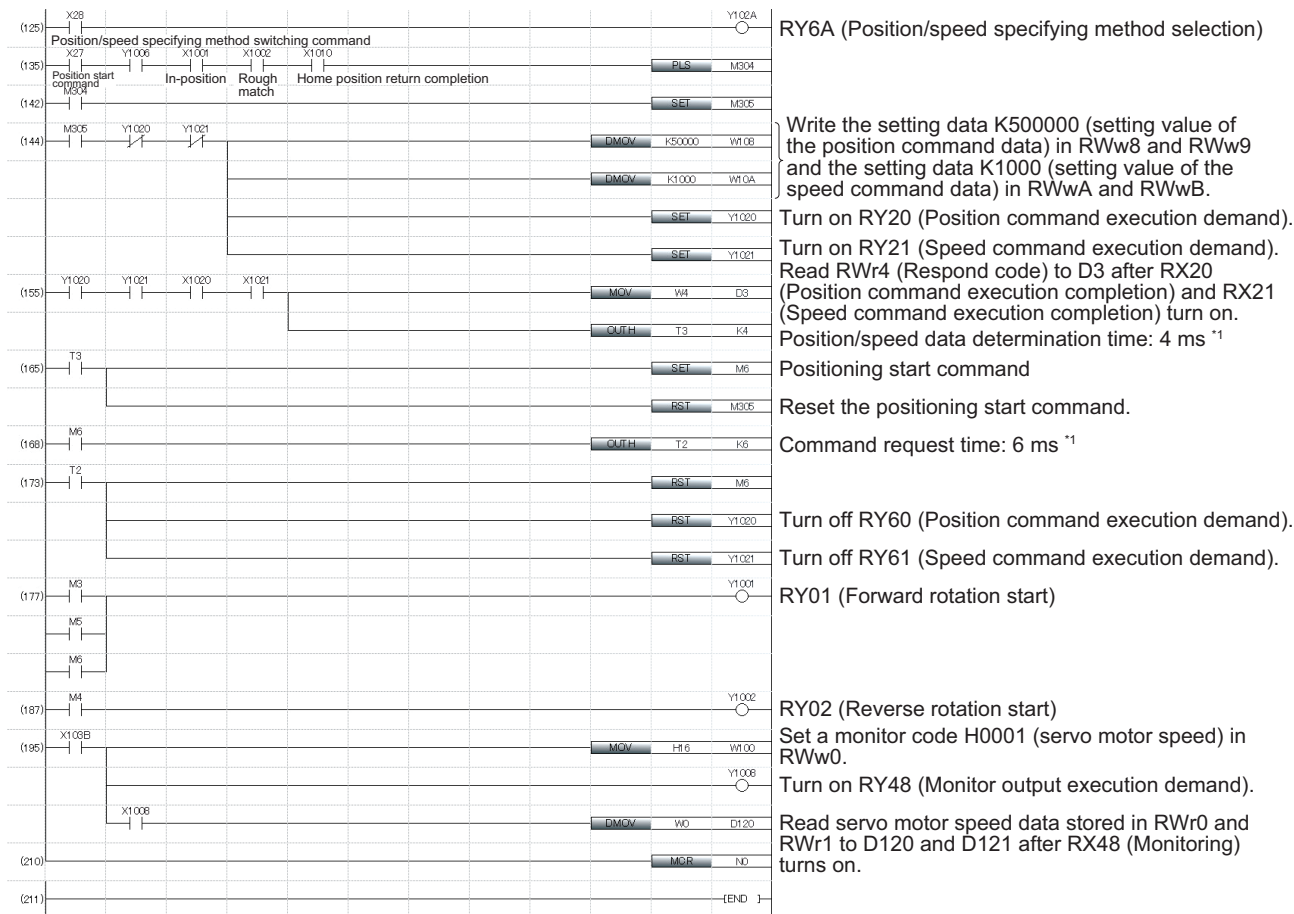
\*1 This time is for when the set time of the high-speed timer is 1 ms.  
Set the doubled link scan time or command processing time, whichever is the larger, as the set time of the timer. If the set time is short, commands may not be accepted normally.

# 3 PARAMETERS

## CAUTION

- Never make a drastic adjustment or change to the parameter values as doing so will make the operation unstable.
- Do not change the parameter settings as described below. Doing so may cause an unexpected condition, such as failing to start up the servo amplifier.
  - Changing the values of the parameters for manufacturer setting
  - Setting a value out of the range
  - Changing the fixed values in the digits of a parameter
- When you write parameters with the controller, make sure that the station No. of the servo amplifier is set correctly. Otherwise, the parameter settings of another station may be written, possibly causing the servo amplifier to be an unexpected condition.

## 3.1 Parameter list

### Point

The parameter whose symbol is preceded by \* is enabled with the following conditions:

- \*: After setting the parameter, cycle the power or reset the controller.
- \*\*: After setting the parameter, cycle the power.

Abbreviations of operation modes indicate the following.

- Standard: Standard (semi closed loop system) use of the rotary servo motor
- Full.: Fully closed loop system use of the rotary servo motor
- Lin.: Linear servo motor use
- DD: Direct drive (DD) motor use

Refer to chapter 5 in "MR-J4-\_GF\_(-RJ) Servo Amplifier Instruction Manual (Motion Mode)" for the parameters with "Motion mode" in the detailed explanation field.

## Basic setting parameters ([Pr. PA\_ \_ ])

No.	Symbol	Name	Initial value	Unit	Operation mode				Detailed explanation	
					Standard	Full.	Lin.	DD		
PA01	**STY	Operation mode	1000h	—	<input type="radio"/>	<input type="radio"/>	<input type="radio"/>	<input type="radio"/>	Motion mode	
PA02	**REG	Regenerative option	0000h	—	<input type="radio"/>	<input type="radio"/>	<input type="radio"/>	<input type="radio"/>		
PA03	*ABS	Absolute position detection system	0000h	—	<input type="radio"/>	<input type="radio"/>	<input type="radio"/>	<input type="radio"/>		
PA04	*AOP1	Function selection A-1	2000h	—	<input type="radio"/>	<input type="radio"/>	<input type="radio"/>	<input type="radio"/>		
PA05	—	For manufacturer setting	10000	—	—	—	—	—		
PA06	*CMX	Electronic gear numerator	1	—	<input type="radio"/>	<input type="radio"/>	<input type="radio"/>	<input type="radio"/>	Page 141 Basic setting parameters ([Pr. PA_ _ ])	
		Number of gear teeth on machine side	1	—	<input type="radio"/>	—	—	<input type="radio"/>		
PA07	*CDV	Electronic gear denominator	1	—	<input type="radio"/>	<input type="radio"/>	<input type="radio"/>	<input type="radio"/>		
		Number of gear teeth on servo motor side	1	—	<input type="radio"/>	—	—	<input type="radio"/>		
PA08	ATU	Auto tuning mode	0001h	—	<input type="radio"/>	<input type="radio"/>	<input type="radio"/>	<input type="radio"/>		Motion mode
PA09	RSP	Auto tuning response	16	—	<input type="radio"/>	<input type="radio"/>	<input type="radio"/>	<input type="radio"/>		
PA10	INP	In-position range	1600	[ $\mu\text{m}$ ]/ $10^{-4}$ [inch]/ $10^{-3}$ [degree]/ [pulse]	<input type="radio"/>	<input type="radio"/>	<input type="radio"/>	<input type="radio"/>		Page 141 Basic setting parameters ([Pr. PA_ _ ])
PA11	TLP	Forward rotation torque limit/positive direction thrust limit	1000.0	[%]	<input type="radio"/>	<input type="radio"/>	<input type="radio"/>	<input type="radio"/>	Motion mode	
PA12	TLN	Reverse rotation torque limit/negative direction thrust limit	1000.0	[%]	<input type="radio"/>	<input type="radio"/>	<input type="radio"/>	<input type="radio"/>		
PA13	—	For manufacturer setting	0000h	—	—	—	—	—		
PA14	*POL	Rotation direction selection/travel direction selection	0	—	<input type="radio"/>	<input type="radio"/>	<input type="radio"/>	—	Page 141 Basic setting parameters ([Pr. PA_ _ ])	
		Station No. direction selection	0	—	<input type="radio"/>	—	—	<input type="radio"/>		
PA15	*ENR	Encoder output pulses	4000	[pulse/rev]	<input type="radio"/>	<input type="radio"/>	<input type="radio"/>	<input type="radio"/>	Motion mode	
PA16	*ENR2	Encoder output pulses 2	1	—	<input type="radio"/>	<input type="radio"/>	<input type="radio"/>	<input type="radio"/>		
PA17	**MSR	Servo motor series setting	0000h	—	—	—	<input type="radio"/>	—		
PA18	**MTY	Servo motor type setting	0000h	—	—	—	<input type="radio"/>	—		
PA19	*BLK	Parameter writing inhibit	00ABh	—	<input type="radio"/>	<input type="radio"/>	<input type="radio"/>	<input type="radio"/>		
PA20	*TDS	Tough drive setting	0000h	—	<input type="radio"/>	<input type="radio"/>	<input type="radio"/>	<input type="radio"/>		
PA21	*AOP3	Function selection A-3	0001h	—	<input type="radio"/>	<input type="radio"/>	<input type="radio"/>	<input type="radio"/>		
PA22	**PCS	Position control composition selection	0000h	—	<input type="radio"/>	<input type="radio"/>	<input type="radio"/>	<input type="radio"/>		
PA23	DRAT	Drive recorder arbitrary alarm trigger setting	0000h	—	<input type="radio"/>	<input type="radio"/>	<input type="radio"/>	<input type="radio"/>		
PA24	AOP4	Function selection A-4	0000h	—	<input type="radio"/>	<input type="radio"/>	<input type="radio"/>	<input type="radio"/>		
PA25	OTHOV	One-touch tuning - Overshoot permissible level	0	[%]	<input type="radio"/>	<input type="radio"/>	<input type="radio"/>	<input type="radio"/>		
PA26	*AOP5	Function selection A-5	0000h	—	<input type="radio"/>	<input type="radio"/>	<input type="radio"/>	<input type="radio"/>		
PA27	—	For manufacturer setting	0000h	—	—	—	—	—		
PA28			0000h							
PA29			0000h							
PA30			0000h							
PA31			0000h							
PA32			0000h							



## Gain/filter setting parameters ([Pr. PB\_ \_])

No.	Symbol	Name	Initial value	Unit	Operation mode				Detailed explanation
					Standard	Full.	Lin.	DD	
PB01	FILT	Adaptive tuning mode (adaptive filter II)	0000h	—	<input type="radio"/>	<input type="radio"/>	<input type="radio"/>	<input type="radio"/>	Motion mode
PB02	VRFT	Vibration suppression control tuning mode (advanced vibration suppression control II)	0000h	—	<input type="radio"/>	<input type="radio"/>	<input type="radio"/>	<input type="radio"/>	
PB03	—	For manufacturer setting	18000	—	—	—	—	—	
PB04	FFC	Feed forward gain	0	[%]	<input type="radio"/>	<input type="radio"/>	<input type="radio"/>	<input type="radio"/>	
PB05	—	For manufacturer setting	500	—	—	—	—	—	
PB06	GD2	Load to motor inertia ratio/load to motor mass ratio	7.00	[Multiplier]	<input type="radio"/>	<input type="radio"/>	<input type="radio"/>	<input type="radio"/>	
PB07	PG1	Model loop gain	15.0	[rad/s]	<input type="radio"/>	<input type="radio"/>	<input type="radio"/>	<input type="radio"/>	
PB08	PG2	Position loop gain	37.0	[rad/s]	<input type="radio"/>	<input type="radio"/>	<input type="radio"/>	<input type="radio"/>	
PB09	VG2	Speed loop gain	823	[rad/s]	<input type="radio"/>	<input type="radio"/>	<input type="radio"/>	<input type="radio"/>	
PB10	VIC	Speed integral compensation	33.7	[ms]	<input type="radio"/>	<input type="radio"/>	<input type="radio"/>	<input type="radio"/>	
PB11	VDC	Speed differential compensation	980	—	<input type="radio"/>	<input type="radio"/>	<input type="radio"/>	<input type="radio"/>	
PB12	OVA	Overshoot amount compensation	0	[%]	<input type="radio"/>	<input type="radio"/>	<input type="radio"/>	<input type="radio"/>	
PB13	NH1	Machine resonance suppression filter 1	4500	[Hz]	<input type="radio"/>	<input type="radio"/>	<input type="radio"/>	<input type="radio"/>	
PB14	NHQ1	Notch shape selection 1	0000h	—	<input type="radio"/>	<input type="radio"/>	<input type="radio"/>	<input type="radio"/>	
PB15	NH2	Machine resonance suppression filter 2	4500	[Hz]	<input type="radio"/>	<input type="radio"/>	<input type="radio"/>	<input type="radio"/>	
PB16	NHQ2	Notch shape selection 2	0000h	—	<input type="radio"/>	<input type="radio"/>	<input type="radio"/>	<input type="radio"/>	
PB17	NHF	Shaft resonance suppression filter	0000h	—	<input type="radio"/>	<input type="radio"/>	<input type="radio"/>	<input type="radio"/>	
PB18	LPF	Low-pass filter setting	3141	[rad/s]	<input type="radio"/>	<input type="radio"/>	<input type="radio"/>	<input type="radio"/>	
PB19	VRF11	Vibration suppression control 1 - Vibration frequency	100.0	[Hz]	<input type="radio"/>	<input type="radio"/>	<input type="radio"/>	<input type="radio"/>	
PB20	VRF12	Vibration suppression control 1 - Resonance frequency	100.0	[Hz]	<input type="radio"/>	<input type="radio"/>	<input type="radio"/>	<input type="radio"/>	
PB21	VRF13	Vibration suppression control 1 - Vibration frequency damping	0.00	—	<input type="radio"/>	<input type="radio"/>	<input type="radio"/>	<input type="radio"/>	
PB22	VRF14	Vibration suppression control 1 - Resonance frequency damping	0.00	—	<input type="radio"/>	<input type="radio"/>	<input type="radio"/>	<input type="radio"/>	
PB23	VFBF	Low-pass filter selection	0000h	—	<input type="radio"/>	<input type="radio"/>	<input type="radio"/>	<input type="radio"/>	
PB24	*MVS	Slight vibration suppression control	0000h	—	<input type="radio"/>	<input type="radio"/>	<input type="radio"/>	<input type="radio"/>	
PB25	*BOP1	Function selection B-1	0000h	—	<input type="radio"/>	<input type="radio"/>	<input type="radio"/>	<input type="radio"/>	
PB26	*CDP	Gain switching function	0000h	—	<input type="radio"/>	<input type="radio"/>	<input type="radio"/>	<input type="radio"/>	
PB27	CDL	Gain switching condition	10	[kpulse/s]/ [pulse]/ [r/min]	<input type="radio"/>	<input type="radio"/>	<input type="radio"/>	<input type="radio"/>	
PB28	CDT	Gain switching time constant	1	[ms]	<input type="radio"/>	<input type="radio"/>	<input type="radio"/>	<input type="radio"/>	
PB29	GD2B	Load to motor inertia ratio/load to motor mass ratio after gain switching	7.00	[Multiplier]	<input type="radio"/>	<input type="radio"/>	<input type="radio"/>	<input type="radio"/>	
PB30	PG2B	Position loop gain after gain switching	0.0	[rad/s]	<input type="radio"/>	<input type="radio"/>	<input type="radio"/>	<input type="radio"/>	
PB31	VG2B	Speed loop gain after gain switching	0	[rad/s]	<input type="radio"/>	<input type="radio"/>	<input type="radio"/>	<input type="radio"/>	
PB32	VICB	Speed integral compensation after gain switching	0.0	[ms]	<input type="radio"/>	<input type="radio"/>	<input type="radio"/>	<input type="radio"/>	
PB33	VRF11B	Vibration suppression control 1 - Vibration frequency after gain switching	0.0	[Hz]	<input type="radio"/>	<input type="radio"/>	<input type="radio"/>	<input type="radio"/>	
PB34	VRF12B	Vibration suppression control 1 - Resonance frequency after gain switching	0.0	[Hz]	<input type="radio"/>	<input type="radio"/>	<input type="radio"/>	<input type="radio"/>	
PB35	VRF13B	Vibration suppression control 1 - Vibration frequency damping after gain switching	0.00	—	<input type="radio"/>	<input type="radio"/>	<input type="radio"/>	<input type="radio"/>	
PB36	VRF14B	Vibration suppression control 1 - Resonance frequency damping after gain switching	0.00	—	<input type="radio"/>	<input type="radio"/>	<input type="radio"/>	<input type="radio"/>	

No.	Symbol	Name	Initial value	Unit	Operation mode				Detailed explanation
					Standard	Full.	Lin.	DD	
PB37	—	For manufacturer setting	1600	—	—	—	—	—	Motion mode
PB38			0.00						
PB39			0.00						
PB40			0.00						
PB41			0000h						
PB42			0000h						
PB43			0000h						
PB44			0.00						
PB45	CNHF	Command notch filter	0000h	—	○	○	○	○	
PB46	NH3	Machine resonance suppression filter 3	4500	[Hz]	○	○	○	○	
PB47	NHQ3	Notch shape selection 3	0000h	—	○	○	○	○	
PB48	NH4	Machine resonance suppression filter 4	4500	[Hz]	○	○	○	○	
PB49	NHQ4	Notch shape selection 4	0000h	—	○	○	○	○	
PB50	NH5	Machine resonance suppression filter 5	4500	[Hz]	○	○	○	○	
PB51	NHQ5	Notch shape selection 5	0000h	—	○	○	○	○	
PB52	VRF21	Vibration suppression control 2 - Vibration frequency	100.0	[Hz]	○	○	○	○	
PB53	VRF22	Vibration suppression control 2 - Resonance frequency	100.0	[Hz]	○	○	○	○	
PB54	VRF23	Vibration suppression control 2 - Vibration frequency damping	0.00	—	○	○	○	○	
PB55	VRF24	Vibration suppression control 2 - Resonance frequency damping	0.00	—	○	○	○	○	
PB56	VRF21B	Vibration suppression control 2 - Vibration frequency after gain switching	0.0	[Hz]	○	○	○	○	
PB57	VRF22B	Vibration suppression control 2 - Resonance frequency after gain switching	0.0	[Hz]	○	○	○	○	
PB58	VRF23B	Vibration suppression control 2 - Vibration frequency damping after gain switching	0.00	—	○	○	○	○	
PB59	VRF24B	Vibration suppression control 2 - Resonance frequency damping after gain switching	0.00	—	○	○	○	○	
PB60	PG1B	Model loop gain after gain switching	0.0	[rad/s]	○	○	○	○	
PB61	—	For manufacturer setting	0.0	—	—	—	—	—	
PB62			0000h						
PB63			0000h						
PB64			0000h						

## Extension setting parameters ([Pr. PC\_ \_])

No.	Symbol	Name	Initial value	Unit	Operation mode				Detailed explanation
					Standard	Full.	Lin.	DD	
PC01	ERZ	Error excessive alarm level	0	[rev]/ [mm]	<input type="radio"/>	<input type="radio"/>	<input type="radio"/>	<input type="radio"/>	Motion mode
PC02	MBR	Electromagnetic brake sequence output	0	[ms]	<input type="radio"/>	<input type="radio"/>	<input type="radio"/>	<input type="radio"/>	
PC03	*ENRS	Encoder output pulse selection	0000h	—	<input type="radio"/>	<input type="radio"/>	<input type="radio"/>	<input type="radio"/>	
PC04	**COP1	Function selection C-1	0000h	—	<input type="radio"/>	<input type="radio"/>	<input type="radio"/>	<input type="radio"/>	
PC05	**COP2	Function selection C-2	0000h	—	<input type="radio"/>	<input type="radio"/>	<input type="radio"/>	<input type="radio"/>	
PC06	*COP3	Function selection C-3	0000h	—	<input type="radio"/>	<input type="radio"/>	<input type="radio"/>	<input type="radio"/>	
PC07	ZSP	Zero speed	50	[r/min]/ [mm/s]	<input type="radio"/>	<input type="radio"/>	<input type="radio"/>	<input type="radio"/>	
PC08	OSL	Overspeed alarm detection level	0	[r/min]/ [mm/s]	<input type="radio"/>	<input type="radio"/>	<input type="radio"/>	<input type="radio"/>	
PC09	MOD1	Analog monitor 1 output	0000h	—	<input type="radio"/>	<input type="radio"/>	<input type="radio"/>	<input type="radio"/>	
PC10	MOD2	Analog monitor 2 output	0001h	—	<input type="radio"/>	<input type="radio"/>	<input type="radio"/>	<input type="radio"/>	
PC11	MO1	Analog monitor 1 offset	0	[mV]	<input type="radio"/>	<input type="radio"/>	<input type="radio"/>	<input type="radio"/>	
PC12	MO2	Analog monitor 2 offset	0	[mV]	<input type="radio"/>	<input type="radio"/>	<input type="radio"/>	<input type="radio"/>	
PC13	—	For manufacturer setting	0	—	—	—	—	—	
PC14	—		0						
PC15	—		0						
PC16	—		0000h						
PC17	**COP4	Function selection C-4	0000h	—	<input type="radio"/>	<input type="radio"/>	<input type="radio"/>	<input type="radio"/>	
PC18	*COP5	Function selection C-5	0010h	—	<input type="radio"/>	<input type="radio"/>	<input type="radio"/>	<input type="radio"/>	
PC19	*COP6	Function selection C-6	0000h	—	<input type="radio"/>	<input type="radio"/>	<input type="radio"/>	<input type="radio"/>	
PC20	*COP7	Function selection C-7	0000h	—	<input type="radio"/>	<input type="radio"/>	<input type="radio"/>	<input type="radio"/>	
PC21	*BPS	Alarm history clear	0000h	—	<input type="radio"/>	<input type="radio"/>	<input type="radio"/>	<input type="radio"/>	
PC22	—	For manufacturer setting	0	—	—	—	—	—	
PC23	—		0000h						
PC24	RSBR	Forced stop deceleration time constant	100	[ms]	<input type="radio"/>	<input type="radio"/>	<input type="radio"/>	<input type="radio"/>	
PC25	—	For manufacturer setting	0	—	—	—	—	—	
PC26	**COP8	Function selection C-8	0000h	—	<input type="radio"/> *1	<input type="radio"/>	<input type="radio"/>	<input type="radio"/>	
PC27	**COP9	Function selection C-9	0000h	—	<input type="radio"/> *1	<input type="radio"/>	<input type="radio"/>	<input type="radio"/>	
PC28	—	For manufacturer setting	0000h	—	—	—	—	—	
PC29	*COPB	Function selection C-B	1000h	—	<input type="radio"/>	<input type="radio"/>	<input type="radio"/>	<input type="radio"/>	
PC30	—	For manufacturer setting	0	—	—	—	—	—	
PC31	RSUP1	Vertical axis freefall prevention compensation amount	0	[0.0001 rev]/ [0.01 mm]	<input type="radio"/>	<input type="radio"/>	<input type="radio"/>	<input type="radio"/>	
PC32	—	For manufacturer setting	0000h	—	—	—	—	—	
PC33	—		0						
PC34	—		100						
PC35	—		0000h						
PC36	—		0000h						
PC37	—		0000h						
PC38	ERW	Error excessive warning level	0	[rev]/[mm]	<input type="radio"/>	<input type="radio"/>	<input type="radio"/>	<input type="radio"/>	

No.	Symbol	Name	Initial value	Unit	Operation mode				Detailed explanation
					Standard	Full.	Lin.	DD	
PC39	—	For manufacturer setting	0000h	—	—	—	—	—	Motion mode
PC40									
PC41									
PC42									
PC43									
PC44									
PC45									
PC46									
PC47									
PC48									
PC49									
PC50									
PC51									
PC52									
PC53									
PC54									
PC55									
PC56									
PC57									
PC58									
PC59									
PC60									
PC61									
PC62									
PC63									
PC64									
PC65									
PC66									
PC67	FEWL	Following error output level	0000h	[pulse]	○	○	○	○	
PC68	FEWH		00C0h						
PC69	FEWF	Following error output filtering time	10	[ms]	○	○	○	○	
PC70	—	For manufacturer setting	100	—	—	—	—	—	
PC71									
PC72									
PC73									
PC74									
PC75									
PC76	*COPE	Function selection C-E	0001h	—	○	○	○	○	
PC77	TL2	Internal torque limit 2	0.0	[%]	○	—	—	○	☞ Page 142 Extension setting parameters ([Pr. PC_ _])
PC78	—	For manufacturer setting	0000h	—	—	—	—	—	Motion mode
PC79									
PC80									

\*1 It is available when the scale measurement function is enabled ([Pr. PA22] is "1 \_ \_ \_" or "2 \_ \_ \_").

## I/O setting parameters ([Pr. PD\_ \_])

No.	Symbol	Name	Initial value	Unit	Operation mode				Detailed explanation
					Standard	Full.	Lin.	DD	
PD01	*DIA1	Input signal automatic on selection 1	0000h	—	○	○	○	○	Motion mode
PD02	—	For manufacturer setting	0000h	—	—	—	—	—	
PD03	*DI1	Input device selection 1	000Ah	—	○	○	○	○	☞ Page 143 I/O setting parameters ([Pr. PD_ _])
PD04	*DI2	Input device selection 2	000Bh	—	○	○	○	○	Motion mode
PD05	*DI3	Input device selection 3	0022h	—	○	○	○	○	
PD06	—	For manufacturer setting	0000h	—	—	—	—	—	
PD07	*DO1	Output device selection 1	0005h	—	○	○	○	○	
PD08	*DO2	Output device selection 2	0004h	—	○	○	○	○	
PD09	*DO3	Output device selection 3	0003h	—	○	○	○	○	
PD10	—	For manufacturer setting	0000h	—	—	—	—	—	
PD11	*DIF	Input filter setting	0004h	—	○	○	○	○	☞ Page 143
PD12	*DOP1	Function selection D-1	0101h	—	○	○	○	○	I/O setting parameters ([Pr. PD_ _])
PD13	*DOP2	Function selection D-2	0000h	—	○	○	○	○	Motion mode
PD14	*DOP3	Function selection D-3	0000h	—	○	○	○	○	
PD15	—	For manufacturer setting	0000h	—	—	—	—	—	
PD16			0000h						
PD17			0000h						
PD18			0000h						
PD19			0000h						
PD20			0						
PD21			0						
PD22			0						
PD23			0						
PD24			0000h						
PD25			0000h						
PD26			0000h						
PD27	0000h								
PD28	0000h								
PD29	0000h								
PD30	0								
PD31	0								
PD32	0								
PD33	0000h								
PD34	0000h								
PD35	0000h								
PD36	0000h								
PD37	*TPOP	Touch probe function selection	0000h	—	○	○	○	○	
PD38	—	For manufacturer setting	002Ch	—	—	—	—	—	
PD39			002Dh						
PD40			0						
PD41	*DOP4	Function selection D-4	0000h	—	○	○	○	○	
PD42	*DOP5	Function selection D-5	0000h	—	○	○	○	○	☞ Page 143 I/O setting parameters ([Pr. PD_ _])

No.	Symbol	Name	Initial value	Unit	Operation mode				Detailed explanation
					Standard	Full.	Lin.	DD	
PD43	—	For manufacturer setting	0000h	—	—	—	—	—	Motion mode
PD44			0000h						
PD45			0000h						
PD46			0000h						
PD47			0000h						
PD48			0000h						

## Extension setting 2 parameters ([Pr. PE\_ \_ ])

No.	Symbol	Name	Initial value	Unit	Operation mode				Detailed explanation
					Standard	Full.	Lin.	DD	
PE01	**FCT1	Fully closed loop function selection 1	0000h	—	—	○	—	—	Motion mode
PE02	—	For manufacturer setting	0000h	—	—	—	—	—	
PE03	*FCT2	Fully closed loop function selection 2	0003h	—	—	○	—	—	
PE04	**FBN	Fully closed loop control - Feedback pulse electronic gear 1 - Numerator	1	—	—	○	—	—	
PE05	**FBD	Fully closed loop control - Feedback pulse electronic gear 1 - Denominator	1	—	—	○	—	—	
PE06	BC1	Fully closed loop control - Speed deviation error detection level	400	[r/min]	—	○	—	—	
PE07	BC2	Fully closed loop control - Position deviation error detection level	100	[kpulse]	—	○	—	—	
PE08	DUF	Fully closed loop dual feedback filter	10	[rad/s]	—	○	—	—	
PE09	—	For manufacturer setting	0000h	—	—	—	—	—	
PE10	FCT3	Fully closed loop function selection 3	0000h	—	—	○	—	—	
PE11	—	For manufacturer setting	0000h	—	—	—	—	—	
PE12			0000h						
PE13			0000h						
PE14			0111h						
PE15			20						
PE16			0000h						
PE17			0000h						
PE18			0000h						
PE19			0000h						
PE20			0000h						
PE21			0000h						
PE22			0000h						
PE23			0000h						
PE24			0000h						
PE25			0000h						
PE26			0000h						
PE27			0000h						
PE28			0000h						
PE29			0000h						
PE30			0000h						
PE31			0000h						
PE32			0000h						
PE33			0000h						
PE34	**FBN2	Fully closed loop control - Feedback pulse electronic gear 2 - Numerator	1	—	—	○	—	—	
PE35	**FBD2	Fully closed loop control - Feedback pulse electronic gear 2 - Denominator	1	—	—	○	—	—	

No.	Symbol	Name	Initial value	Unit	Operation mode				Detailed explanation
					Standard	Full.	Lin.	DD	
PE36	—	For manufacturer setting	0.0	—	—	—	—	—	Motion mode
PE37			0.00						
PE38			0.00						
PE39			20						
PE40			0000h						
PE41	EOP3	Function selection E-3	0000h	—	○	○	○	○	
PE42	—	For manufacturer setting	0	—	—	—	—	—	
PE43			0.0						
PE44	LMCP	Lost motion compensation positive-side compensation value selection	0	[0.01 %]	○	○	○	○	
PE45	LMCN	Lost motion compensation negative-side compensation value selection	0	[0.01 %]	○	○	○	○	
PE46	LMFLT	Lost motion filter setting	0	[0.1 ms]	○	○	○	○	
PE47	TOF	Torque offset	0	[0.01 %]	○	○	—	—	
PE48	*LMOP	Lost motion compensation function selection	0000h	—	○	○	○	○	
PE49	LMCD	Lost motion compensation timing	0	[0.1 ms]	○	○	○	○	
PE50	LMCT	Lost motion compensation non-sensitive band	0	[pulse]/ [kpulse]	○	○	○	○	
PE51	—	For manufacturer setting	0000h	—	—	—	—	—	
PE52			0000h						
PE53			0000h						
PE54			0000h						
PE55			0000h						
PE56			0000h						
PE57			0000h						
PE58			0000h						
PE59			0000h						
PE60			0000h						
PE61			0.00						
PE62			0.00						
PE63			0.00						
PE64			0.00						

## Extension setting 3 parameters ([Pr. PF\_ \_ ])

No.	Symbol	Name	Initial value	Unit	Operation mode				Detailed explanation
					Standard	Full.	Lin.	DD	
PF01	—	For manufacturer setting	0000h	—	—	—	—	—	Motion mode
PF02			0000h						
PF03			0000h						
PF04			0						
PF05			0000h						
PF06	*FOP5	Function selection F-5	0000h	—	○	○	—	—	
PF07	—	For manufacturer setting	0000h	—	—	—	—	—	
PF08			0000h						
PF09			0						
PF10			0						
PF11			0						
PF12	DBT	Electronic dynamic brake operating time	2000	[ms]	○	○	—	—	
PF13	—	For manufacturer setting	0000h	—	—	—	—	—	
PF14			10						
PF15			0000h						
PF16			0000h						
PF17			0000h						
PF18	**STOD		STO diagnosis error detection time						
PF19	TSL	Friction failure prediction - Compensation coefficient 1	0	[0.001 %/°C]	○	○	○	○	
PF20	TIC	Friction failure prediction - Compensation coefficient 2	0	[0.1 %]	○	○	○	○	
PF21	DRT	Drive recorder switching time setting	0	[s]	○	○	○	○	
PF22	—	For manufacturer setting	200	—	—	—	—	—	
PF23	OSCL1	Vibration tough drive - Oscillation detection level	50	[%]	○	○	○	○	
PF24	*OSCL2	Vibration tough drive function selection	0000h	—	○	○	○	○	
PF25	CVAT	SEMI-F47 function - Instantaneous power failure detection time	200	[ms]	○	○	○	○	
PF26	—	For manufacturer setting	0	—	—	—	—	—	
PF27			0						
PF28			0						
PF29			0000h						
PF30			0						
PF31	FRIC		Machine diagnosis function - Friction judgment speed						
PF32	—	For manufacturer setting	50	—	—	—	—	—	
PF33			0000h						
PF34	*MFP	Machine diagnosis function selection	0000h	—	○	○	○	○	
PF35	—	For manufacturer setting	0000h	—	—	—	—	—	
PF36			0000h						
PF37			0000h						
PF38			0000h						
PF39			0000h						
PF40	MFPP		Machine failure prediction parameter						
PF41	FPMT	Failure prediction - Servo motor travel distance	0	[rev]/[m]	○	○	○	○	
PF42	PAV	Friction failure prediction - Average characteristic	0	[0.1 %]	○	○	○	○	
PF43	PSD	Friction failure prediction - Standard deviation	0	[0.1 %]	○	○	○	○	
PF44	—	For manufacturer setting	0	—	—	—	—	—	
PF45	VAV	Vibration failure prediction - Average characteristic	0	[0.1 %]	○	○	○	○	
PF46	VSD	Vibration failure prediction - Standard deviation	0	[0.1 %]	○	○	○	○	



No.	Symbol	Name	Initial value	Unit	Operation mode				Detailed explanation
					Standard	Full.	Lin.	DD	
PF47	—	For manufacturer setting	0000h	—	—	—	—	—	Motion mode
PF48			0000h						
PF49			100						
PF50			100						
PF51			0000h						
PF52			0000h						
PF53			0						
PF54			0						
PF55			0						
PF56			0						
PF57			0000h						
PF58			0000h						
PF59			0000h						
PF60			0000h						
PF61			0000h						
PF62			0000h						
PF63			0000h						
PF64		0000h							

## Linear servo motor/DD motor setting parameters ([Pr. PL\_ \_])

No.	Symbol	Name	Initial value	Unit	Operation mode				Detailed explanation
					Standard	Full.	Lin.	DD	
PL01	**LIT1	Linear servo motor/DD motor function selection 1	0301h	—	—	—	○	○	Motion mode
PL02	**LIM	Linear encoder resolution - Numerator	1000	[μm]	—	—	○	—	
PL03	**LID	Linear encoder resolution - Denominator	1000	[μm]	—	—	○	—	
PL04	*LIT2	Linear servo motor/DD motor function selection 2	0003h	—	—	—	○	○	
PL05	LB1	Position deviation error detection level	0	[mm]/[0.01 rev]	—	—	○	○	
PL06	LB2	Speed deviation error detection level	0	[mm/s]/[r/min]	—	—	○	○	
PL07	LB3	Torque/thrust deviation error detection level	100	[%]	—	—	○	○	
PL08	*LIT3	Linear servo motor/DD motor function selection 3	0010h	—	—	—	○	○	
PL09	LPWM	Magnetic pole detection voltage level	30	[%]	—	—	○	○	
PL10	—	For manufacturer setting	5	—	—	—	—	—	
PL11			100						
PL12			500						
PL13			0000h						
PL14			0000h						
PL15			20						
PL16			0						
PL17	LTSTS	Magnetic pole detection - Minute position detection method - Function selection	0000h	—	—	—	○	○	
PL18	IDLV	Magnetic pole detection - Minute position detection method - Identification signal amplitude	0	[%]	—	—	○	○	

No.	Symbol	Name	Initial value	Unit	Operation mode				Detailed explanation
					Standard	Full.	Lin.	DD	
PL19	—	For manufacturer setting	0	—	—	—	—	—	Motion mode
PL20			0						
PL21			0						
PL22			0						
PL23			0000h						
PL24			0						
PL25			0000h						
PL26			0000h						
PL27			0000h						
PL28			0000h						
PL29			0000h						
PL30			0000h						
PL31			0000h						
PL32			0000h						
PL33			0000h						
PL34			0000h						
PL35			0000h						
PL36			0000h						
PL37			0000h						
PL38			0000h						
PL39			0000h						
PL40			0000h						
PL41			0000h						
PL42			0000h						
PL43			0000h						
PL44			0000h						
PL45			0000h						
PL46			0000h						
PL47			0000h						
PL48			0000h						

## Positioning control parameters ([Pr. PT\_ \_ ])

No.	Symbol	Name	Initial value	Unit	Operation mode				Detailed explanation
					Standard	Full.	Lin.	DD	
PT01	**CTY	Command mode selection	0300h	—	<input type="radio"/>	<input type="radio"/>	<input type="radio"/>	<input type="radio"/>	Page 145 Positioning control parameters ([Pr. PT_ _ ])
PT02	—	For manufacturer setting	0001h	—	<input type="radio"/>	<input type="radio"/>	<input type="radio"/>	<input type="radio"/>	
PT03	*FTY	Feeding function selection	0000h	—	<input type="radio"/>	<input type="radio"/>	<input type="radio"/>	<input type="radio"/>	
PT04	—	For manufacturer setting	0000h	—	<input type="radio"/>	<input type="radio"/>	<input type="radio"/>	<input type="radio"/>	Motion mode
PT05	ZRF	Home position return speed	100.00	[r/min]/[mm/s]	<input type="radio"/>	<input type="radio"/>	<input type="radio"/>	<input type="radio"/>	
PT06	CRF	Creep speed	10.00	[r/min]/ [mm/s]	<input type="radio"/>	<input type="radio"/>	<input type="radio"/>	<input type="radio"/>	
PT07	ZST	Home position shift distance	0	[ $\mu$ m]/ $10^{-4}$ [inch]/ $10^{-3}$ [degree]/ [pulse]	<input type="radio"/>	<input type="radio"/>	<input type="radio"/>	<input type="radio"/>	
PT08	*ZPS	Home position return position data	0	$10^{\text{STM}}$ [ $\mu$ m]/ $10^{\text{STM-4}}$ [inch]/ $10^{-3}$ [degree]/ [pulse]	<input type="radio"/>	<input type="radio"/>	<input type="radio"/>	<input type="radio"/>	Page 145 Positioning control parameters ([Pr. PT_ _ ])
PT09	DCT	Travel distance after proximity dog	0	$10^{\text{STM}}$ [ $\mu$ m]/ $10^{\text{STM-4}}$ [inch]/ $10^{-3}$ [degree]/ [pulse]	<input type="radio"/>	<input type="radio"/>	<input type="radio"/>	<input type="radio"/>	
PT10	ZTM	Stopper type home position return stopper time	100	[ms]	<input type="radio"/>	<input type="radio"/>	<input type="radio"/>	<input type="radio"/>	
PT11	ZTT	Stopper type home position return torque limit value	15.0	[%]	<input type="radio"/>	<input type="radio"/>	<input type="radio"/>	<input type="radio"/>	Motion mode

No.	Symbol	Name	Initial value	Unit	Operation mode				Detailed explanation
					Standard	Full.	Lin.	DD	
PT12	CRP	Rough match output range	0	10 <sup>STM</sup> [μm]/ 10 <sup>(STM-4)</sup> [inch]/10 <sup>-3</sup> [degree]/ [pulse]	○	○	○	○	Page 145 Positioning control parameters ([Pr. PT_ _])
PT13	—	For manufacturer setting	100	—	—	—	—	—	
PT14	—		0	—	—	—	—	—	
PT15	LMPL	Software limit +	0000h	10 <sup>STM</sup> [μm]/ 10 <sup>(STM-4)</sup> [inch]/10 <sup>-3</sup> [degree]/ [pulse]	○	○	○	○	
PT16	LMPH		0000h						
PT17	LMNL	Software limit -	0000h	10 <sup>STM</sup> [μm]/ 10 <sup>(STM-4)</sup> [inch]/10 <sup>-3</sup> [degree]/ [pulse]	○	○	○	○	
PT18	LMNH		0000h						
PT19	*LPPL	Position range output address +	0000h	10 <sup>STM</sup> [μm]/ 10 <sup>(STM-4)</sup> [inch]/10 <sup>-3</sup> [degree]/ [pulse]	○	○	○	○	
PT20	*LPPH		0000h						
PT21	*LNPL	Position range output address -	0000h	10 <sup>STM</sup> [μm]/ 10 <sup>(STM-4)</sup> [inch]/10 <sup>-3</sup> [degree]/ [pulse]	○	○	○	○	
PT22	*LNPH		0000h						
PT23	—	For manufacturer setting	0	—	—	—	—	—	
PT24	—		0	—	—	—	—	—	
PT25	—		0	—	—	—	—	—	
PT26	*TOP2		Function selection T-2	0000h	—	○	○	○	
PT27	*ODM	Indexer method - Operation mode selection	0000h	—	○	—	—	○	
PT28	*STN	Number of stations per rotation	8	[stations]	○	—	—	○	
PT29	*TOP3	Function selection T-3	0000h	—	○	○	○	○	
PT30	—	For manufacturer setting	0000h	—	—	—	—	—	
PT31	—		0000h	—	—	—	—	—	
PT32	—		0000h	—	—	—	—	—	
PT33	—		0000h	—	—	—	—	—	
PT34	*PDEF	Point table default	0000h	—	○	○	○	○	
PT35	*TOP5	Function selection T-5	0000h	—	○	○	○	○	
PT36	—	For manufacturer setting	0000h	—	—	—	—	—	
PT37	—		10	—	—	—	—	—	
PT38	**TOP7	Function selection T-7	0000h	—	○	—	—	○	
PT39	INT	Torque limit delay time	100	[ms]	○	—	—	○	
PT40	*SZS	Station home position shift distance	0	[pulse]	○	—	—	○	
PT41	ORP	Home position return inhibit function selection	0000h	—	○	○	○	○	Motion mode
PT42	*OVM	Digital override minimum multiplication	0	[%]	○	—	—	○	Page 145 Positioning control parameters ([Pr. PT_ _])
PT43	*OVS	Digital override pitch width	0	[%]	○	—	—	○	
PT44	—	For manufacturer setting	0000h	—	—	—	—	—	Motion mode
PT45	HMM	Home position return type	37	—	○	○	○	○	Page 145 Positioning control parameters ([Pr. PT_ _])
PT46	—	For manufacturer setting	0000h	—	—	—	—	—	Motion mode

No.	Symbol	Name	Initial value	Unit	Operation mode				Detailed explanation
					Standard	Full.	Lin.	DD	
PT47	*ZPSH	Home position return position data (extension parameter)	0000h	$10^{STM} \mu\text{m}/10^{(STM-4)}$ [inch]/ $10^{-3}$ [degree]/ [pulse]	○	○	○	○	Page 145 Positioning control parameters ([Pr. PT_ _])
PT48	TOP7A	Function selection T-7A	0000h	—	○	—	—	○	
PT49	STA	Acceleration time constant	0	[ms]	○	○	○	○	
PT50	STB	Deceleration time constant	0	[ms]	○	○	○	○	
PT51	STC	S-pattern acceleration/deceleration time constant	0	[ms]	○	○	○	○	
PT52	—	For manufacturer setting	0	—	—	—	—	—	Motion mode
PT53	0.0								
PT54	0								
PT55	*TOP8	Function selection T-8	0000h	—	○	○	○	○	
PT56	HMA	Home position return acceleration time constant	0	[ms]	○	○	○	○	
PT57	HMB	Home position return deceleration time constant	0	[ms]	○	○	○	○	
PT58	—	For manufacturer setting	100.00	—	—	—	—	—	Page 145 Positioning control parameters ([Pr. PT_ _])
PT59	500.00								
PT60	1000.00								
PT61	200.00								
PT62	*DSS	Remote register-based position/speed specifying method selection	0000h	—	○	○	○	○	
PT63	—	For manufacturer setting	0000h	—	—	—	—	—	Motion mode
PT64	0000h								
PT65	PVC	Jog speed command	100.00	[r/min]/[mm/s]	○	○	○	○	Page 145 Positioning control parameters ([Pr. PT_ _])
PT66	—	For manufacturer setting	20000.0 0	—	—	—	—	—	Motion mode
PT67	VLMT	Speed limit	500.00	[r/min]/ [mm/s]	○	○	○	○	
PT68	—	For manufacturer setting	0102h	—	—	—	—	—	
PT69	ZSTH	Home position shift distance (extension parameter)	0	$[\mu\text{m}]/10^{-4}$ [inch]/ $10^{-3}$ [degree]/ [pulse]	○	○	○	○	
PT70	—	For manufacturer setting	0000h	—	—	—	—	—	Motion mode
PT71	DCTH	Travel distance after proximity dog (extension parameter)	0	$10^{STM} \mu\text{m}/10^{(STM-4)}$ [inch]/ $10^{-3}$ [degree]/ [pulse]	○	○	○	○	Page 145 Positioning control parameters ([Pr. PT_ _])
PT72	—	For manufacturer setting	0000h	—	—	—	—	—	Motion mode
PT73	0000h								
PT74	0000h								
PT75	0000h								
PT76	0000h								
PT77	0000h								
PT78	0000h								
PT79	0000h								
PT80	0000h								

## Network setting parameters ([Pr. PN\_ \_])

No.	Symbol	Name	Initial value	Unit	Operation mode				Detailed explanation
					Standard	Full.	Lin.	DD	
PN01	—	For manufacturer setting	0	—	—	—	—	—	Motion mode
PN02	CERT	Communication error detection time	0	[ms]	○	○	○	○	
PN03	**NWMD	Communication mode setting for CC-Link IE communication	0000h	—	○	○	○	○	☞ Page 156 Network setting parameters ([Pr. PN_ _])
PN04	**NWNO	CC-Link IE communication network number	0	—	○	○	○	○	Motion mode
PN05	CERI	Communication error detection frequency setting	0	[%]	○	○	○	○	
PN06	NOP1	Function selection N-1	0000h	—	○	○	○	○	☞ Page 156 Network setting parameters ([Pr. PN_ _])
PN07	—	For manufacturer setting	0000h	—	—	—	—	—	Motion mode
PN08									
PN09									
PN10									
PN11									
PN12									
PN13									
PN14									
PN15									
PN16									
PN17									
PN18									
PN19									
PN20									
PN21									
PN22									
PN23									
PN24									
PN25									
PN26									
PN27									
PN28									
PN29									
PN30									
PN31									
PN32									

## 3.2 Detailed list of parameters

### Point

- For parameters which are not described in this section, refer to chapter 5 of "MR-J4- \_GF\_(-RJ) Servo Amplifier Instruction Manual (Motion Mode)".
- Set a value to each "x" in the "Setting digit" columns.

### Basic setting parameters ([Pr. PA\_ \_ ])

3

No./symbol/ name	Setting digit	Function	Initial value [unit]	Control mode		
				CP	PS	SP
PA01 **STY Operation mode	___x	Control mode selection Select a control mode. 0: Positioning mode (point table method) 8: Positioning mode (indexer method) B: Speed control mode (point table method) When [Pr. PN03] is "___1", the above setting is enabled. When [Pr. PN03] is "___0", refer to "MR-J4- _GF_(-RJ) Servo Amplifier Instruction Manual (Motion Mode)". This digit is available with servo amplifier with software version A3 or later. The setting value "B" is available with servo amplifiers with software version A6 or later.	0h	<input type="radio"/>	<input type="radio"/>	<input type="radio"/>
	__x_	Operation mode selection 0: Standard control mode 1: Fully closed loop control mode 4: Linear servo motor control mode 6: DD motor control mode The following settings will trigger [AL. 37 Parameter error]. • A value other than "0", "1", "4", and "6" is set to this digit. • When set to Positioning mode (indexer method), a value other than "0" and "6" is set to this digit.	0h	<input type="radio"/>	<input type="radio"/>	<input type="radio"/>
	_x__	For manufacturer setting	0h	—	—	—
	x___		1h	—	—	—
PA06 *CMX Electronic gear numerator	—	Set an electronic gear numerator. (☞ Page 158 Electronic gear settings in the point table method) Set the electronic gear within the following range. Setting out of the range will trigger [AL. 37 Parameter error]. 1/865 < CMX/CDV < 271471 Setting range: 1 to 16777215	1	<input type="radio"/>	—	—
PA06 *CMX Number of gear teeth on machine side	—	Set the number of gear teeth on machine side. (☞ Page 159 Electronic gear setting in the indexer method) Set the electronic gear within the following range. Setting out of the range will trigger [AL. 37 Parameter error]. This parameter setting is used with servo amplifier with software version A3 or later.  • $1 \leq \text{CMX} \leq 16384$ , $1 \leq \text{CDV} \leq 16384$ • $\frac{1}{9999} \leq \frac{\text{CMX}}{\text{CDV}} \leq 9999$  • $\text{CDV} \times \text{STN} \leq 32767$ (STN: Number of stations per rotation [Pr. PT28])  • $\text{CMX} \times \text{CDV} \leq 100000$  When a small value is set to the electronic gear ratio with the manual operation mode, the servo motor may not drive at the set servo motor speed.  $\text{Travel distance of 1 station} = \text{Pt (servo motor resolution)} \times \frac{1}{\text{STN}} \times \frac{\text{CMX}}{\text{CDV}}$ Setting range: 1 to 16777215	1	—	<input type="radio"/>	—
PA07 *CDV Electronic gear denominator	—	Set the electronic gear denominator. (☞ Page 158 Electronic gear settings in the point table method) Set the electronic gear within the range of [Pr. PA06]. Setting out of the range will trigger [AL. 37 Parameter error]. Setting range: 1 to 16777215	1	<input type="radio"/>	—	—

No./symbol/ name	Setting digit	Function	Initial value [unit]	Control mode														
				CP	PS	SP												
PA07 *CDV Number of gear teeth on servo motor side	—	Set the number of gear teeth on servo motor side. (☞ Page 159 Electronic gear setting in the indexer method) Set the electronic gear within the range of [Pr. PA06]. Setting out of the range will trigger [AL. 37 Parameter error]. This parameter setting is used with servo amplifier with software version A3 or later. Setting range: 1 to 16777215	1	—	○	—												
PA10 INP In-position range	—	Set an in-position range per command pulse. To change it to the servo motor encoder pulse unit, set [Pr. PC06]. In the I/O mode, the in-position range is the range where RXnC (Travel completion) and RXn1 (In-position) are outputted. The unit will be as follows depending on the positioning mode. • Point table method When [Pr. PC06] is set to "___0", the unit can be changed to [μm], 10 <sup>-4</sup> [inch], 10 <sup>-3</sup> [degree], or [pulse] with the setting of [Pr. PT01]. When [Pr. PC06] is set to "___1", the unit is fixed to [pulse]. • Indexer method It will be command unit [pulse]. (a load-side rotation expressed by the number of servo motor resolution pulses) For example, when making an in-position range "±1 degree" for the rotation angle on the load side, set 4194304 × (1/360) = 11650 pulses. The indexer method can be used with servo amplifiers with software version A3 or later. Setting range: 0 to 65535	1600 Refer to Function column for unit.	○	○	—												
PA14 *POL Rotation direction selection/travel direction selection	—	Select a rotation direction or travel direction. The torque polarity can be changed with the combination of this parameter and [Pr. PC29 Torque POL reflection selection]. <table border="1" data-bbox="400 913 1192 1144"> <thead> <tr> <th>Setting value</th> <th colspan="2">Servo motor rotation direction/linear servo motor travel direction</th> </tr> </thead> <tbody> <tr> <td></td> <td>Position mode Positioning address increase/ Velocity mode Speed command: positive</td> <td>Position mode Positioning address decrease/ Velocity mode Speed command: negative</td> </tr> <tr> <td>0</td> <td>CCW or positive direction</td> <td>CW or negative direction</td> </tr> <tr> <td>1</td> <td>CW or negative direction</td> <td>CCW or positive direction</td> </tr> </tbody> </table>	Setting value	Servo motor rotation direction/linear servo motor travel direction			Position mode Positioning address increase/ Velocity mode Speed command: positive	Position mode Positioning address decrease/ Velocity mode Speed command: negative	0	CCW or positive direction	CW or negative direction	1	CW or negative direction	CCW or positive direction	0	○	—	○
Setting value	Servo motor rotation direction/linear servo motor travel direction																	
	Position mode Positioning address increase/ Velocity mode Speed command: positive	Position mode Positioning address decrease/ Velocity mode Speed command: negative																
0	CCW or positive direction	CW or negative direction																
1	CW or negative direction	CCW or positive direction																
PA14 *POL Station No. direction selection	—	Select an assignment direction of station No. This parameter setting is used with servo amplifier with software version A3 or later. <table border="1" data-bbox="400 1227 1192 1335"> <thead> <tr> <th>Setting value</th> <th>Assignment direction of station No.</th> </tr> </thead> <tbody> <tr> <td>0</td> <td>Station numbers will be assigned in CW direction in order of 1, 2, 3...</td> </tr> <tr> <td>1</td> <td>Station numbers will be assigned in CCW direction in order of 1, 2, 3...</td> </tr> </tbody> </table>	Setting value	Assignment direction of station No.	0	Station numbers will be assigned in CW direction in order of 1, 2, 3...	1	Station numbers will be assigned in CCW direction in order of 1, 2, 3...	0	—	○	—						
Setting value	Assignment direction of station No.																	
0	Station numbers will be assigned in CW direction in order of 1, 2, 3...																	
1	Station numbers will be assigned in CCW direction in order of 1, 2, 3...																	

## Extension setting parameters ([Pr. PC\_\_])

No./symbol/ name	Setting digit	Function	Initial value [unit]	Control mode		
				CP	PS	SP
PC77 TL2 Internal torque limit 2	—	The parameter is set for limiting the torque of the servo motor. Set rated torque to 100.0%. No torque is generated when this parameter is set to "0.0". In the positioning mode (indexer method), this parameter is enabled while automatic operation, manual operation, and home position return operation are stopped. During operation, the setting value of [Pr. PA11] and [Pr. PA12] is enabled. This parameter can be used only in the positioning mode (indexer method) with servo amplifiers with software versions A3 to A6. This parameter can be used in the positioning mode (point table method), positioning mode (indexer method), and speed control mode (point table method) with servo amplifiers with software version A7 or later. This parameter can also be switched between enabled/disabled with the internal torque limit selection function. Refer to the following for details. ☞ Page 296 Internal torque limit selection Setting range: 0.0 to 1000.0	0.0 [%]	○	○	○



# I/O setting parameters ([Pr. PD\_ \_])

No./symbol/ name	Setting digit	Function	Initial value [unit]	Control mode																																														
				CP	PS	SP																																												
PD03 *DI1 Input device selection 1	Any input device can be assigned to the CN3-2 pin.																																																	
	__ x x	Device selection Refer to the following table for settings.	0Ah	<input type="radio"/>	<input type="radio"/>	<input type="radio"/>																																												
	_ x __	For manufacturer setting	0h	—	—	—																																												
	x ___		0h	—	—	—																																												
	<table border="1"> <thead> <tr> <th>Setting value</th> <th>Input device</th> </tr> </thead> <tbody> <tr><td>__ 0 0</td><td>-</td></tr> <tr><td>__ 0 3</td><td>RES (Reset) *2</td></tr> <tr><td>__ 0 4</td><td>PC (Proportional control)</td></tr> <tr><td>__ 0 6</td><td>CR (Clear) *2</td></tr> <tr><td>__ 0 9</td><td>CTL (Internal torque limit selection) *2</td></tr> <tr><td>__ 0 A</td><td>LSP (Forward rotation stroke end)</td></tr> <tr><td>__ 0 B</td><td>LSN (Reverse rotation stroke end)</td></tr> <tr><td>__ 0 D</td><td>CDP (Gain switching)</td></tr> <tr><td>__ 0 E</td><td>CLD (Fully closed loop selection) *1</td></tr> <tr><td>__ 2 2</td><td>DOG (Proximity dog)</td></tr> </tbody> </table>		Setting value	Input device	__ 0 0	-	__ 0 3	RES (Reset) *2	__ 0 4	PC (Proportional control)	__ 0 6	CR (Clear) *2	__ 0 9	CTL (Internal torque limit selection) *2	__ 0 A	LSP (Forward rotation stroke end)	__ 0 B	LSN (Reverse rotation stroke end)	__ 0 D	CDP (Gain switching)	__ 0 E	CLD (Fully closed loop selection) *1	__ 2 2	DOG (Proximity dog)																										
	Setting value	Input device																																																
	__ 0 0	-																																																
	__ 0 3	RES (Reset) *2																																																
	__ 0 4	PC (Proportional control)																																																
	__ 0 6	CR (Clear) *2																																																
	__ 0 9	CTL (Internal torque limit selection) *2																																																
	__ 0 A	LSP (Forward rotation stroke end)																																																
	__ 0 B	LSN (Reverse rotation stroke end)																																																
	__ 0 D	CDP (Gain switching)																																																
__ 0 E	CLD (Fully closed loop selection) *1																																																	
__ 2 2	DOG (Proximity dog)																																																	
*1 This is available with servo amplifiers with software version A1 or later.																																																		
*2 This is available with servo amplifiers with software version A7 or later.																																																		
PD07 *DO1 Output device selection 1	Device selection Any output device can be assigned to the CN3-13 pin. As the initial value, MBR (Electromagnetic brake interlock) is assigned to the pin. Refer to the following table for settings.		05h	<input type="radio"/>	<input type="radio"/>	<input type="radio"/>																																												
	_ x __	For manufacturer setting	0h	—	—	—																																												
	x ___		0h	—	—	—																																												
	<table border="1"> <thead> <tr> <th>Setting value</th> <th>Output device</th> </tr> </thead> <tbody> <tr><td>__ 0 0</td><td>Always off</td></tr> <tr><td>__ 0 2</td><td>RD (Ready)</td></tr> <tr><td>__ 0 3</td><td>ALM (Malfunction)</td></tr> <tr><td>__ 0 4</td><td>INP (In-position)</td></tr> <tr><td>__ 0 5</td><td>MBR (Electromagnetic brake interlock)</td></tr> <tr><td>__ 0 6</td><td>DB (Dynamic brake interlock)</td></tr> <tr><td>__ 0 7</td><td>TLC (Limiting torque)</td></tr> <tr><td>__ 0 8</td><td>WNG (Warning)</td></tr> <tr><td>__ 0 9</td><td>BWNG (Battery warning)</td></tr> <tr><td>__ 0 A</td><td>SA (Speed reached)</td></tr> <tr><td>__ 0 B</td><td>VLC (Limiting speed)</td></tr> <tr><td>__ 0 C</td><td>ZSP (Zero speed detection)</td></tr> <tr><td>__ 0 E</td><td>PRMWR (Wait for enabling parameters) *2</td></tr> <tr><td>__ 0 F</td><td>CDPS (Variable gain selection)</td></tr> <tr><td>__ 1 0</td><td>CLDS (During fully closed loop control) *1</td></tr> <tr><td>__ 1 1</td><td>ABSV (Absolute position undetermined)</td></tr> <tr><td>__ 1 7</td><td>MTTR (During tough drive)</td></tr> <tr><td>__ 2 5</td><td>POT (Position range) *3</td></tr> <tr><td>__ 2 6</td><td>PUS (Temporary stop) *3</td></tr> <tr><td>__ 2 7</td><td>MEND (Travel completion) *3</td></tr> <tr><td>__ 2 8</td><td>CPO (Rough match) *3</td></tr> </tbody> </table>		Setting value	Output device	__ 0 0	Always off	__ 0 2	RD (Ready)	__ 0 3	ALM (Malfunction)	__ 0 4	INP (In-position)	__ 0 5	MBR (Electromagnetic brake interlock)	__ 0 6	DB (Dynamic brake interlock)	__ 0 7	TLC (Limiting torque)	__ 0 8	WNG (Warning)	__ 0 9	BWNG (Battery warning)	__ 0 A	SA (Speed reached)	__ 0 B	VLC (Limiting speed)	__ 0 C	ZSP (Zero speed detection)	__ 0 E	PRMWR (Wait for enabling parameters) *2	__ 0 F	CDPS (Variable gain selection)	__ 1 0	CLDS (During fully closed loop control) *1	__ 1 1	ABSV (Absolute position undetermined)	__ 1 7	MTTR (During tough drive)	__ 2 5	POT (Position range) *3	__ 2 6	PUS (Temporary stop) *3	__ 2 7	MEND (Travel completion) *3	__ 2 8	CPO (Rough match) *3				
	Setting value	Output device																																																
	__ 0 0	Always off																																																
	__ 0 2	RD (Ready)																																																
	__ 0 3	ALM (Malfunction)																																																
	__ 0 4	INP (In-position)																																																
	__ 0 5	MBR (Electromagnetic brake interlock)																																																
	__ 0 6	DB (Dynamic brake interlock)																																																
	__ 0 7	TLC (Limiting torque)																																																
	__ 0 8	WNG (Warning)																																																
	__ 0 9	BWNG (Battery warning)																																																
__ 0 A	SA (Speed reached)																																																	
__ 0 B	VLC (Limiting speed)																																																	
__ 0 C	ZSP (Zero speed detection)																																																	
__ 0 E	PRMWR (Wait for enabling parameters) *2																																																	
__ 0 F	CDPS (Variable gain selection)																																																	
__ 1 0	CLDS (During fully closed loop control) *1																																																	
__ 1 1	ABSV (Absolute position undetermined)																																																	
__ 1 7	MTTR (During tough drive)																																																	
__ 2 5	POT (Position range) *3																																																	
__ 2 6	PUS (Temporary stop) *3																																																	
__ 2 7	MEND (Travel completion) *3																																																	
__ 2 8	CPO (Rough match) *3																																																	
*1 This is available with servo amplifiers with software version A1 or later.																																																		
*2 This is available with servo amplifiers with software version A6 or later.																																																		
*3 This is available with servo amplifiers with software version A8 or later.																																																		

No./symbol/ name	Setting digit	Function	Initial value [unit]	Control mode																									
				CP	PS	SP																							
PD11 *DIF Input filter setting	___x	Input signal filter selection If external input signal causes chattering due to noise, etc., input filter is used to suppress it. 0: None 1: 0.888 [ms] 2: 1.777 [ms] 3: 2.666 [ms] 4: 3.555 [ms] 5: 4.444 [ms] <sup>*1</sup> 6: 5.333 [ms] <sup>*1</sup> <sup>*1</sup> This is available with servo amplifiers with software version A7 or later.	4h	○	○	○																							
	__x_	RES (Reset) dedicated filter selection 0: Disabled 1: Enabled (50 [ms]) This digit is available with servo amplifier with software version A7 or later.	0h	○	○	○																							
	_x__	CR (Clear) dedicated filter selection 0: Disabled 1: Enabled (50 [ms]) This digit is available with servo amplifier with software version A7 or later.	0h	○	○	—																							
	x___	For manufacturer setting	0h	—	—	—																							
PD12 *DOP1 Function selection D-1	___x	Stop method selection at stroke limit detection Select a stop method for RY (n + 1) 0 (Upper stroke limit) off or RY (n + 1) 1 (Lower stroke limit) off. (☞ Page 161 Stop method at stroke limit detection)	1h	○	○	○																							
		<table border="1"> <thead> <tr> <th rowspan="2">Setting value</th> <th colspan="3">Control mode</th> </tr> <tr> <th>CP</th> <th>PS</th> <th>SP</th> </tr> </thead> <tbody> <tr> <td>0</td> <td>Quick stop</td> <td>Quick stop</td> <td>Quick stop (stop by clearing the speed command to 0)</td> </tr> <tr> <td>1</td> <td colspan="2">Slow stop</td> <td>Slow stop (deceleration to a stop by deceleration time constant)</td> </tr> <tr> <td>2</td> <td>Slow stop (deceleration to a stop by deceleration time constant)</td> <td>Slow stop</td> <td>-</td> </tr> <tr> <td>3</td> <td>Quick stop (stop by clearing remaining distance)</td> <td>Quick stop</td> <td>-</td> </tr> </tbody> </table>					Setting value	Control mode			CP	PS	SP	0	Quick stop	Quick stop	Quick stop (stop by clearing the speed command to 0)	1	Slow stop		Slow stop (deceleration to a stop by deceleration time constant)	2	Slow stop (deceleration to a stop by deceleration time constant)	Slow stop	-	3	Quick stop (stop by clearing remaining distance)	Quick stop	-
	Setting value	Control mode																											
		CP					PS	SP																					
0	Quick stop	Quick stop					Quick stop (stop by clearing the speed command to 0)																						
1	Slow stop		Slow stop (deceleration to a stop by deceleration time constant)																										
2	Slow stop (deceleration to a stop by deceleration time constant)	Slow stop	-																										
3	Quick stop (stop by clearing remaining distance)	Quick stop	-																										
	Setting a value other than the value listed in the setting value field will trigger [AL. 37].																												
__x_	For manufacturer setting	0h	—	—	—																								
_x__	Stop method selection at software limit detection Select a stop method selection at software limit detection. (☞ Page 163 Stop method at software limit detection) 1: Slow stop 2: Slow stop (deceleration to a stop by deceleration time constant) 3: Quick stop (stop by clearing remaining distance) Setting "0" will trigger [AL. 37].	1h	○	—	—																								
x___	Servo motor thermistor enabled/disabled selection 0: Enabled 1: Disabled This digit is available with servo motors with a thermistor. For servo motors without thermistor, the setting will be disabled.	0h	○	○	○																								
PD42 *DOP5 Function selection D-5	___x	CR (Clear) selection 0: Delete droop pulses by turning on the device 1: Always delete droop pulses during the device on 2: Disabled This digit is available with servo amplifier with software version A7 or later.	0h	○	○	—																							
	__x_	For manufacturer setting	0h	—	—	—																							
	_x__		0h	—	—	—																							
	x___		0h	—	—	—																							

# Positioning control parameters ([Pr. PT\_ \_ ])

No./symbol/ name	Setting digit	Function	Initial value [unit]	Control mode		
				CP	PS	SP
PT01 **CTY Command mode selection	___x	Positioning command method selection 0: Absolute value command method 1: Incremental value command method	0h	○	—	—
	__x_	For manufacturer setting	0h	—	—	—
	_x__	Position data unit 0: mm 1: inch 2: degree 3: pulse The setting value "2" is available with servo amplifiers with software version A6 or later. For servo amplifiers with software version A6 or earlier, setting "2" triggers [AL. 37.1].	3h	○	—	—
	x___	For manufacturer setting	0h	—	—	—
PT03 *FTY Feeding function selection	___x	Feed length multiplication (STM) 0: 1 1: 10 2: 100 3: 1000 This digit will be disabled when [degree] or [pulse] of "Position data unit" is set in [Pr. PT01].	0h	○	—	—
	__x_	For manufacturer setting	0h	—	—	—
	_x__	Shortest rotation selection per degree 0: Rotation direction specifying 1: Shortest rotation 2: Operation in the address decreasing direction rotation 3: Operation in the address increasing direction rotation The settings for this digit will be enabled immediately after the change. This settings for this digit is disabled in the incremental value command method.	0h	○	—	—
	x___	For manufacturer setting	0h	—	—	—
PT07 ZST Home position shift distance	—	Set a shift distance from the Z-phase pulse detection position in the encoder or from the position set in "Travel distance after proximity dog". Up to $2^{31-1}$ can be set with [Pr. PT69]. Refer to section 4.6 of "MR-J4- _GF_(-RJ) Servo Amplifier Instruction Manual (Motion Mode)" for the home position shift direction. The unit will be as follows depending on the positioning mode. • Point table method It will be changed to [ $\mu\text{m}$ ], $10^{-4}$ [inch], $10^{-3}$ [degree], or [pulse] with [Pr. PT01]. The unit [degree] is available with servo amplifiers with software version A6 or later. • Indexer method It will be command unit [pulse]. (a load-side rotation expressed by the number of servo motor resolution pulses) Refer to the Function column of [Pr. PA10] for the command unit. The indexer method can be used with servo amplifiers with software version A3 or later. Setting range: 0 to 65535	0 Refer to Function column for unit.	○	○	—
PT08 *ZPS Home position return position data	—	The value calculated from the setting values of [Pr. PT08 Home position return position data] and [Pr. PT47 Home position return position data (extension parameter)] is the current position at home position return completion. The equation is as follows. Home position return position data = [Pr. PT08] + ([Pr. PT47] $\times$ 65536) The unit can be changed to $10^{\text{STM}}$ [ $\mu\text{m}$ ], $10^{(\text{STM}-4)}$ [inch], $10^{-3}$ [degree], or [pulse] with the setting of [Pr. PT01]. If the setting value in this digit is changed, the home position will be erased. Setting range: 0 to 65535	0 Refer to Function column for unit.	○	—	—

No./symbol/ name	Setting digit	Function	Initial value [unit]	Control mode		
				CP	PS	SP
PT09 DCT Travel distance after proximity dog	—	Set a travel distance after proximity dog for the count type home position return (front end detection, Z-phase reference) (Homing method -2, -34) and the following dog reference home position returns. Up to 2 <sup>31</sup> can be set with [Pr. PT71]. The following shows the home position return of the dog reference. • Dog type rear end reference home position return (Homing method -6, -38) • Count type home position return (Front end reference) (Homing method -7, -39) • Dog type front end reference home position return (Homing method -10, -42) • Homing without index pulse (Homing method 19, 20, 21, 22, 23, 24, 27, 28) The unit can be changed to 10 <sup>STM</sup> [μm], 10 <sup>(STM-4)</sup> [inch], 10 <sup>-3</sup> [degree], or [pulse] with the setting of [Pr. PT01]. The unit [degree] is available with servo amplifiers with software version A6 or later. Setting range: 0 to 65535	0 Refer to Function column for unit.	○	—	—
PT12 CRP Rough match output range	—	Set a range of the command remaining distance which outputs rough match. The unit will be as follows depending on the positioning mode. • Point table method It will be changed to 10 <sup>STM</sup> [μm], 10 <sup>(STM-4)</sup> [inch], 10 <sup>-3</sup> [degree], or [pulse] with [Pr. PT01]. The unit [degree] is available with servo amplifiers with software version A6 or later. • Indexer method It will be command unit [pulse]. (a load-side rotation expressed by the number of servo motor resolution pulses) Refer to the Function column of [Pr. PA10] for the command unit. The indexer method can be used with servo amplifiers with software version A3 or later. Setting range: 0 to 65535	0 Refer to Function column for unit.	○	○	—
PT14 *BKC Backlash compensation	—	Set the backlash compensation. If a value other than "0" is set in the cyclic synchronous mode, [AL. 37] occurs. Setting range: 0 to 65535	0 [pulse]	○	○	—
PT15 LMPL Software limit + (lower four digits)	—	Set an address increasing side of the software stroke limit. Upper and lower are a set. Set the setting address in hexadecimal.  Setting address:  μIf "Software limit -" is set to a value equal to or more than "Software limit +" while the unit is m, inch, or pulse, the software limit will be disabled. If the value same as the "Software limit -" is set while the unit is degree, the software limit will be disabled. When changing the parameter setting with MR Configurator2, change it during servo-off or in the home position return mode. The unit can be changed to 10 <sup>STM</sup> [μm], 10 <sup>(STM-4)</sup> [inch], 10 <sup>-3</sup> [degree], or [pulse] with the setting of [Pr. PT01]. Setting range: 8000 0000h to 7FFF FFFFh (-2147483648 to 2147483647)	0000h Refer to Function column for unit.	○	—	—
PT16 LMPH Software limit + (upper four digits)			0000h Refer to Function column for unit.			
PT17 LMNL Software limit - (lower four digits)	—	Set an address decreasing side of the software stroke limit. Upper and lower are a set. Set the setting address in hexadecimal.  Setting address:  μIf "Software limit -" is set to a value equal to or more than "Software limit +" while the unit is m, inch, or pulse, the software limit will be disabled. If the value same as the "Software limit +" is set while the unit is degree, the software limit will be disabled. When changing the parameter setting with MR Configurator2, change it during servo-off or in the home position return mode. The unit can be changed to 10 <sup>STM</sup> [μm], 10 <sup>(STM-4)</sup> [inch], 10 <sup>-3</sup> [degree], or [pulse] with the setting of [Pr. PT01]. Setting range: 8000 0000h to 7FFF FFFFh (-2147483648 to 2147483647)	0000h Refer to Function column for unit.	○	—	—
PT18 LMNH Software limit - (upper four digits)			0000h Refer to Function column for unit.			

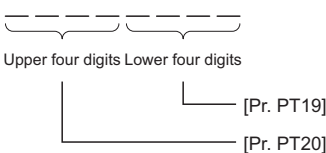
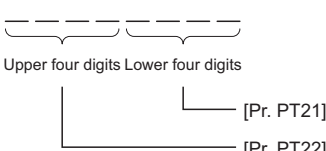
No./symbol/ name	Setting digit	Function	Initial value [unit]	Control mode		
				CP	PS	SP
PT19 *LPPL Position range output address + (lower four digits)	—	Set an address increasing side of the position range output address. Upper and lower are a set. Set a range which RXnE (Position range) turns on with [Pr. PT19] to [Pr. PT22].  Setting address: 	0000h Refer to Function column for unit.	○	—	—
PT20 *LPPH Position range output address + (upper four digits)			0000h Refer to Function column for unit.			
PT21 *LNPL Position range output address - (lower four digits)	—	Set an address decreasing side of the position range output address. Upper and lower are a set. Set a range which RXnE (Position range) turns on with [Pr. PT19] to [Pr. PT22].  Setting address: 	0000h Refer to Function column for unit.	○	—	—
PT22 *LNPH Position range output address - (upper four digits)			0000h Refer to Function column for unit.			

No./symbol/ name	Setting digit	Function	Initial value [unit]	Control mode																															
				CP	PS	SP																													
PT26 *TOP2 Function selection T-2	___x	Electric gear fraction clear selection 0: Disabled 1: Enabled Selecting "Enabled" clears the electric gear fraction of the previous command at the start of automatic operation. If an attempt to set this digit to "2" or more is made, this digit will be "Disabled". This digit is available with servo amplifier with software version A7 or later.	0h	○	—	—																													
	__x_	Current position/command position display selection Select how to display the current position and the command position. 0: Positioning display 1: Roll feed display  <table border="1"> <thead> <tr> <th rowspan="2">Setting value</th> <th rowspan="2">Display method</th> <th colspan="2">Operation mode</th> <th colspan="2">Status display content</th> </tr> <tr> <th></th> <th></th> <th>Current position</th> <th>Command position</th> </tr> </thead> <tbody> <tr> <td>__0_</td> <td>Positioning display</td> <td colspan="2">Automatic/manual</td> <td>Displays the actual current position with the machine home position being set as 0.</td> <td>Displays the command current position with the machine home position being set as 0.</td> </tr> <tr> <td rowspan="3">__1_</td> <td rowspan="3">Roll feed display</td> <td rowspan="2">Automatic</td> <td>Automatic continuous positioning operation</td> <td>Unavailable</td> <td>Unavailable</td> </tr> <tr> <td>Automatic individual positioning operation</td> <td>Displays the actual current position with the automatic operation start position being set as 0.</td> <td>Starts counting from 0 when the start signal is turned on and displays the command current position to the target position. Displays the command position (the target position of the point table) during a stop.</td> </tr> <tr> <td colspan="2">Manual</td> <td>Displays the actual current position with the machine home position being set as 0.</td> <td>Always displays 0.</td> </tr> </tbody> </table> This digit will be disabled when "Position data unit" in [Pr. PT01] is set to [degree]. This digit is available with servo amplifier with software version A7 or later.	Setting value	Display method	Operation mode		Status display content				Current position	Command position	__0_	Positioning display	Automatic/manual		Displays the actual current position with the machine home position being set as 0.	Displays the command current position with the machine home position being set as 0.	__1_	Roll feed display	Automatic	Automatic continuous positioning operation	Unavailable	Unavailable	Automatic individual positioning operation	Displays the actual current position with the automatic operation start position being set as 0.	Starts counting from 0 when the start signal is turned on and displays the command current position to the target position. Displays the command position (the target position of the point table) during a stop.	Manual		Displays the actual current position with the machine home position being set as 0.	Always displays 0.	0h	○	—	—
	Setting value	Display method			Operation mode		Status display content																												
					Current position	Command position																													
__0_	Positioning display	Automatic/manual		Displays the actual current position with the machine home position being set as 0.	Displays the command current position with the machine home position being set as 0.																														
__1_	Roll feed display	Automatic	Automatic continuous positioning operation	Unavailable	Unavailable																														
			Automatic individual positioning operation	Displays the actual current position with the automatic operation start position being set as 0.	Starts counting from 0 when the start signal is turned on and displays the command current position to the target position. Displays the command position (the target position of the point table) during a stop.																														
		Manual		Displays the actual current position with the machine home position being set as 0.	Always displays 0.																														
_x__	For manufacturer setting		0h	—	—	—																													
x___			0h	—	—	—																													
PT27 *ODM Indexer method - Operation mode selection	___x	For manufacturer setting	0h	—	—	—																													
	__x_	Manual operation method selection 0: Station JOG operation 1: JOG operation This digit is available with servo amplifier with software version A3 or later.	0h	—	○	—																													
	_x__	For manufacturer setting	0h	—	—	—																													
	x___		0h	—	—	—																													
PT28 *STN Number of stations per rotation	—	Set the number of stations per rotation (number of indexer stations). Setting "0" or "1" to this setting will set it to "2". This parameter is available with servo amplifiers with software version A3 or later. Setting range: 0 to 255	8 [stations ]	—	○	—																													

No./symbol/ name	Setting digit	Function	Initial value [unit]	Control mode															
				CP	PS	SP													
PT29 *TOP3 Function selection T-3	Set the DOG polarity.																		
	___x (HEX)	___x (BIN): DOG (Proximity dog) polarity selection 0: Dog detection with off 1: Detection with on This setting is applied to both the input by a servo amplifier and by a controller.	0h	○	—	—													
		__x_ (BIN): For manufacturer setting																	
		_x__ (BIN): For manufacturer setting																	
		x___ (BIN): For manufacturer setting																	
	__x_	For manufacturer setting	0h	—	—	—													
	_x__		0h	—	—	—													
	x___		0h	—	—	—													
	Convert the setting value into hexadecimal as follows.																		
	<table border="1" style="margin-left: auto; margin-right: auto;"> <thead> <tr> <th rowspan="2">Setting details</th> <th colspan="2">Initial value</th> </tr> <tr> <th>BIN</th> <th>HEX</th> </tr> </thead> <tbody> <tr> <td>DOG (Proximity dog) polarity selection</td> <td>0</td> <td rowspan="4">0</td> </tr> <tr> <td>—</td> <td>0</td> </tr> <tr> <td>—</td> <td>0</td> </tr> <tr> <td>—</td> <td>0</td> </tr> </tbody> </table>						Setting details	Initial value		BIN	HEX	DOG (Proximity dog) polarity selection	0	0	—	0	—	0	—
Setting details	Initial value																		
	BIN	HEX																	
DOG (Proximity dog) polarity selection	0	0																	
—	0																		
—	0																		
—	0																		
PT29 *TOP3 Function selection T-3	Set the DOG polarity.																		
	___x (HEX)	___x (BIN): DOG (Proximity dog) polarity selection 0: Detection with on 1: Dog detection with off This setting is applied to both the input by a servo amplifier and by a controller.	0h	—	○	—													
		__x_ (BIN): For manufacturer setting																	
		_x__ (BIN): For manufacturer setting																	
		x___ (BIN): For manufacturer setting																	
	__x_	For manufacturer setting	0h	—	—	—													
	_x__		0h	—	—	—													
	x___		0h	—	—	—													
	Convert the setting value into hexadecimal as follows.																		
	<table border="1" style="margin-left: auto; margin-right: auto;"> <thead> <tr> <th rowspan="2">Setting details</th> <th colspan="2">Initial value</th> </tr> <tr> <th>BIN</th> <th>HEX</th> </tr> </thead> <tbody> <tr> <td>DOG (Proximity dog) polarity selection</td> <td>0</td> <td rowspan="4">0</td> </tr> <tr> <td>—</td> <td>0</td> </tr> <tr> <td>—</td> <td>0</td> </tr> <tr> <td>—</td> <td>0</td> </tr> </tbody> </table>						Setting details	Initial value		BIN	HEX	DOG (Proximity dog) polarity selection	0	0	—	0	—	0	—
Setting details	Initial value																		
	BIN	HEX																	
DOG (Proximity dog) polarity selection	0	0																	
—	0																		
—	0																		
—	0																		

No./symbol/ name	Setting digit	Function	Initial value [unit]	Control mode		
				CP	PS	SP
PT34 **PDEF Point table default	—	<p>Use this parameter when initializing point tables and cam data. The point tables and the cam data will be the following status by being initialized. Point table: All "0" Cam data: Erased</p> <p>Initialize the point tables with the following procedures:  <ol style="list-style-type: none"> <li>1 Set "5001h" to this parameter.</li> <li>2 Cycle the power of the servo amplifier.</li> </ol> After the servo amplifier power is on, the initialization completes in about 20 s. "dF" will be displayed on the display (five-digit, seven-segment LED) during the initialization. After the initialization, the setting of this parameter will be "0000h" automatically.</p> <p>Initialize the cam data with the following procedures:  <ol style="list-style-type: none"> <li>1 Set "5010h" to this parameter.</li> <li>2 Cycle the power of the servo amplifier.</li> </ol> After the initialization, the setting of this parameter will be "0000h" automatically.</p> <p>Initialize the point tables and the cam data with the following procedures:  <ol style="list-style-type: none"> <li>1 Set "5011h" to this parameter.</li> <li>2 Cycle the power of the servo amplifier.</li> </ol> After the servo amplifier power is on, the initialization completes in about 20 s. "dF" will be displayed on the display (five-digit, seven-segment LED) during the initialization. After the initialization, the setting of this parameter will be "0000h" automatically.  Initializing cam data is possible with servo amplifiers with software version A3 or later.</p>	0000h	○	○	○
PT35 *TOP5 Function selection T-5	___ x	For manufacturer setting	0h	—	—	—
	__ x _		0h	—	—	—
	_ x _ _	<p>Simple cam function selection</p> <p>0: Disabled 1: Enabled (cam position compensation disabled) 2: Enabled (cam position compensation enabled by touch probe 1 (TPR1)) 3: Enabled (cam position compensation enabled by touch probe 2 (TPR2))</p> <p>Simple cam function is enabled when the control mode is in the point table method. Enabling this digit in other control modes will trigger [AL. 37 Parameter error]. Setting a value other than "0" to this digit when MR-D30 is connected will trigger [AL. 37]. This digit is available with servo amplifier with software version A3 or later.</p>	0h	○	—	—
PT38 **TOP7 Function selection T-7	x _ _ _	For manufacturer setting	0h	—	—	—
	___ x	For manufacturer setting	0h	—	—	—
	__ x _	<p>Override selection</p> <p>0: The override function is disabled 1: The digital override function is enabled 2: The analog override function is enabled</p> <p>This parameter is available with servo amplifiers with software version A6 or later.</p>	0h	○	○	—
	_ x _ _	For manufacturer setting	0h	—	—	—
PT39 INT Torque limit delay time	—	Backlash compensation direction selection at data set type home position return Select the backlash compensation direction at data set type home position return and at home position ignorance. When changing this parameter, perform home position return. This parameter is available with servo amplifiers with software version A8 or later. 0: Automatic setting 1: CCW direction or positive direction 2: CW direction or negative direction	0h	○	○	—
		<p>Set delay time from outputting RXnC (Travel completion) to enabling [Pr. PC77 Internal torque limit 2]. This parameter is available with servo amplifiers with software version A3 or later. Setting range: 0 to 1000</p>	100 [ms]	—	○	—
PT40 *SZS Station home position shift distance	—	<p>Set a shift distance of the station home position with encoder pulse unit at home position return. Setting this parameter enables to shift the station home position (station No. 0) to the position for home position return. The following shows cautions for the setting.</p> <ul style="list-style-type: none"> <li>• The setting of the station home position shift distance is disabled at home position return. Cycling the power will enable the setting.</li> <li>• When the home position shift distance is longer than the in-position range, RXn1 (In-position) will not be on regardless of cycle of the power after returning to home position.</li> </ul> <p>This parameter is available with servo amplifiers with software version A3 or later. Setting range: -32000 to 32000</p>	0 [pulse]	—	○	—



No./symbol/ name	Setting digit	Function	Initial value [unit]	Control mode																																																																																					
				CP	PS	SP																																																																																			
PT42 *OVM Digital override minimum multiplication	—	<p>Set the minimum speed for when the digital override function is enabled.</p> <p>When the digital override function is used, the multiplication can be set with [Pr. PT42] and [Pr. PT43]. Set this at the same time with [Pr. PT43].</p> <p>Refer to the following table for how to calculate the multiplication.</p> <p>If an attempt to set "0" is made, the value will be recognized as "1".</p> <p>This parameter is available with servo amplifiers with software version A6 or later.</p> <p>Setting range: 0 to 100</p>	0 [%]	○	○	—																																																																																			
		<table border="1"> <thead> <tr> <th colspan="4">Input device *1</th> <th rowspan="2">Multiplication [%]</th> </tr> <tr> <th>OV3</th> <th>OV2</th> <th>OV1</th> <th>OV0</th> </tr> </thead> <tbody> <tr> <td>0</td> <td>0</td> <td>0</td> <td>0</td> <td>Fixed to 100</td> </tr> <tr> <td>0</td> <td>0</td> <td>0</td> <td>1</td> <td>[Pr. PT42]</td> </tr> <tr> <td>0</td> <td>0</td> <td>1</td> <td>0</td> <td>[Pr. PT42] + [Pr. PT43] × 1</td> </tr> <tr> <td>0</td> <td>0</td> <td>1</td> <td>1</td> <td>[Pr. PT42] + [Pr. PT43] × 2</td> </tr> <tr> <td>0</td> <td>1</td> <td>0</td> <td>0</td> <td>[Pr. PT42] + [Pr. PT43] × 3</td> </tr> <tr> <td>0</td> <td>1</td> <td>0</td> <td>1</td> <td>[Pr. PT42] + [Pr. PT43] × 4</td> </tr> <tr> <td>0</td> <td>1</td> <td>1</td> <td>0</td> <td>[Pr. PT42] + [Pr. PT43] × 5</td> </tr> <tr> <td>0</td> <td>1</td> <td>1</td> <td>1</td> <td>[Pr. PT42] + [Pr. PT43] × 6</td> </tr> <tr> <td>1</td> <td>0</td> <td>0</td> <td>0</td> <td>[Pr. PT42] + [Pr. PT43] × 7</td> </tr> <tr> <td>1</td> <td>0</td> <td>0</td> <td>1</td> <td>[Pr. PT42] + [Pr. PT43] × 8</td> </tr> <tr> <td>1</td> <td>0</td> <td>1</td> <td>0</td> <td>[Pr. PT42] + [Pr. PT43] × 9</td> </tr> <tr> <td>1</td> <td>0</td> <td>1</td> <td>1</td> <td>[Pr. PT42] + [Pr. PT43] × 10</td> </tr> <tr> <td>1</td> <td>1</td> <td>0</td> <td>0</td> <td>[Pr. PT42] + [Pr. PT43] × 11</td> </tr> <tr> <td>1</td> <td>1</td> <td>0</td> <td>1</td> <td>[Pr. PT42] + [Pr. PT43] × 12</td> </tr> <tr> <td>1</td> <td>1</td> <td>1</td> <td>0</td> <td>[Pr. PT42] + [Pr. PT43] × 13</td> </tr> <tr> <td>1</td> <td>1</td> <td>1</td> <td>1</td> <td>Fixed to 0</td> </tr> </tbody> </table> <p>*1 0: off 1: on</p>					Input device *1				Multiplication [%]	OV3	OV2	OV1	OV0	0	0	0	0	Fixed to 100	0	0	0	1	[Pr. PT42]	0	0	1	0	[Pr. PT42] + [Pr. PT43] × 1	0	0	1	1	[Pr. PT42] + [Pr. PT43] × 2	0	1	0	0	[Pr. PT42] + [Pr. PT43] × 3	0	1	0	1	[Pr. PT42] + [Pr. PT43] × 4	0	1	1	0	[Pr. PT42] + [Pr. PT43] × 5	0	1	1	1	[Pr. PT42] + [Pr. PT43] × 6	1	0	0	0	[Pr. PT42] + [Pr. PT43] × 7	1	0	0	1	[Pr. PT42] + [Pr. PT43] × 8	1	0	1	0	[Pr. PT42] + [Pr. PT43] × 9	1	0	1	1	[Pr. PT42] + [Pr. PT43] × 10	1	1	0	0	[Pr. PT42] + [Pr. PT43] × 11	1	1	0	1	[Pr. PT42] + [Pr. PT43] × 12	1	1	1	0
Input device *1				Multiplication [%]																																																																																					
OV3	OV2	OV1	OV0																																																																																						
0	0	0	0	Fixed to 100																																																																																					
0	0	0	1	[Pr. PT42]																																																																																					
0	0	1	0	[Pr. PT42] + [Pr. PT43] × 1																																																																																					
0	0	1	1	[Pr. PT42] + [Pr. PT43] × 2																																																																																					
0	1	0	0	[Pr. PT42] + [Pr. PT43] × 3																																																																																					
0	1	0	1	[Pr. PT42] + [Pr. PT43] × 4																																																																																					
0	1	1	0	[Pr. PT42] + [Pr. PT43] × 5																																																																																					
0	1	1	1	[Pr. PT42] + [Pr. PT43] × 6																																																																																					
1	0	0	0	[Pr. PT42] + [Pr. PT43] × 7																																																																																					
1	0	0	1	[Pr. PT42] + [Pr. PT43] × 8																																																																																					
1	0	1	0	[Pr. PT42] + [Pr. PT43] × 9																																																																																					
1	0	1	1	[Pr. PT42] + [Pr. PT43] × 10																																																																																					
1	1	0	0	[Pr. PT42] + [Pr. PT43] × 11																																																																																					
1	1	0	1	[Pr. PT42] + [Pr. PT43] × 12																																																																																					
1	1	1	0	[Pr. PT42] + [Pr. PT43] × 13																																																																																					
1	1	1	1	Fixed to 0																																																																																					
PT43 *OVS Digital override pitch width	—	<p>Set the override pitch width for when the digital override function is enabled.</p> <p>When the digital override function is used, the multiplication can be set with [Pr. PT42] and [Pr. PT43]. Set this at the same time with [Pr. PT42].</p> <p>Refer to the table in [Pr. PT42] for settings.</p> <p>If an attempt to set "0" is made, the value will be recognized as "1".</p> <p>This parameter is available with servo amplifiers with software version A6 or later.</p> <p>Setting range: 0 to 20</p>	0 [%]	○	○	—																																																																																			

No./symbol/ name	Setting digit	Function	Initial value [unit]	Control mode		
				CP	PS	SP
PT45 HMM Home position return type	—	Set the home position return method. Refer to the following table for details. Setting a value other than setting values (" -1", "-3", "-33", "35" and "37" regarding the indexer method) in the following tables will trigger [AL. F4]. At this time, home position return cannot be executed.	37	○	○	—

Setting value	Home position return direction	Home position return type	Setting value	Home position return direction	Home position return type
-1	Forward rotation (CCW) or positive direction	Dog type (Rear end detection, Z-phase reference)/Torque limit changing dog type (rear end detection, Z-phase reference) *1*3	-33	Reverse rotation (CW) or negative direction	Dog type (Rear end detection, Z-phase reference)/Torque limit changing dog type (rear end detection, Z-phase reference) *1*3
-2		Count type (front end detection, Z-phase reference)	-34		Count type (front end detection, Z-phase reference)
-3	-	Torque limit changing data set type *1	-36	-	Stopper type (stopper position reference)
-4	Forward rotation (CCW) or positive direction	Stopper type (stopper position reference)	-38	-	Dog type (rear end detection, rear end reference)
-5	-	Home position ignorance (Servo-on position as home position) *2	-39	-	Count type (front end detection, front end reference)
-6	Forward rotation (CCW) or positive direction	Dog type (rear end detection, rear end reference)	-40	-	Dog cradle type
-7			Count type (front end detection, front end reference)		-41
-8		Dog cradle type	-42		Dog type front end reference
-9		Dog type last Z-phase reference	-43		Dogless Z-phase reference
-10		Dog type front end reference			
-11		Dogless Z-phase reference			

\*1 The torque limit changing dog type and torque limit changing data set type can be used only in the indexer method. The indexer method can be used with servo amplifiers with software version A3 or later.

\*2 The setting value is available with servo amplifiers with software version A1 or later.

\*3 Front end detection or rear end detection of the proximity dog can be selected with "torque limit changing dog type home position return" in [Pr. PT70].

Setting value	Home position return direction	Home position return type	Setting value	Home position return direction	Home position return type
3	Forward rotation (CCW) or positive direction	Method 3	21	Reverse rotation (CW) or negative direction	Method 21
4	Forward rotation (CCW) or positive direction	Method 4	22	Reverse rotation (CW) or negative direction	Method 22
5	Reverse rotation (CW) or negative direction	Method 5	23	Forward rotation (CCW) or positive direction	Method 23
6	Reverse rotation (CW) or negative direction	Method 6	24	Forward rotation (CCW) or positive direction	Method 24
7	Forward rotation (CCW) or positive direction	Method 7	27	Reverse rotation (CW) or negative direction	Method 27
8	Forward rotation (CCW) or positive direction	Method 8	28	Reverse rotation (CW) or negative direction	Method 28
11	Reverse rotation (CW) or negative direction	Method 11	33	Reverse rotation (CW) or negative direction	Method 33
12	Reverse rotation (CW) or negative direction	Method 12	34	Forward rotation (CCW) or positive direction	Method 34
19	Forward rotation (CCW) or positive direction	Method 19	35	-	Method 35
20	Forward rotation (CCW) or positive direction	Method 20	37	-	Method 37 (Data set type)

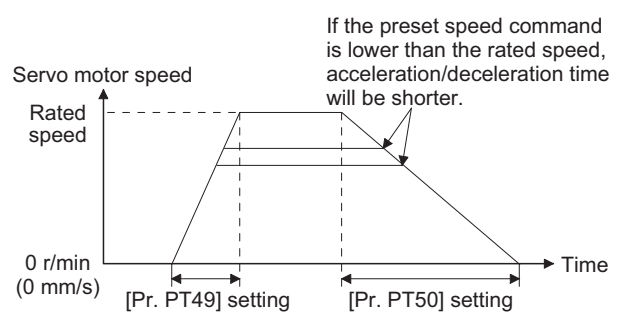
No./symbol/ name	Setting digit	Function	Initial value [unit]	Control mode																					
				CP	PS	SP																			
PT47 *ZPSH Home position return position data (extension parameter)	—	The value calculated from the setting values of [Pr. PT08 Home position return position data] and [Pr. PT47 Home position return position data (extension parameter)] is the current position at home position return completion. The equation is as follows. Home position return position data = [Pr. PT08] + ([Pr. PT47] × 65536) The unit can be changed to 10 <sup>STM</sup> [μm], 10 <sup>(STM-4)</sup> [inch], 10 <sup>-3</sup> [degree], or [pulse] with the setting of [Pr. PT01]. If the setting value in this digit is changed, the home position will be erased. Setting range: -32768 to 32767	0 Refer to Function column for unit.	○	—	—																			
PT48 TOP7A Function selection T-7A	___ x	Torque limit selection at stop 0: Disabled 1: Enabled When this digit is set to "1" (Enabled), the torque limit value at stop in the indexer method will be as shown in the table below.  <table border="1" style="margin-left: auto; margin-right: auto;"> <thead> <tr> <th colspan="2">Setting value</th> <th colspan="2">Torque limit value</th> </tr> <tr> <th>[Pr. PT48]</th> <th>Torque limit value status</th> <th>Forward rotation torque limit</th> <th>Reverse rotation torque limit</th> </tr> </thead> <tbody> <tr> <td>0: Disabled</td> <td>-</td> <td>[Pr. PC77]</td> <td>[Pr. PC77]</td> </tr> <tr> <td rowspan="2">1: Enabled</td> <td>[Pr. PC77] &gt; [Pr. PA11] [Pr. PA12]</td> <td>[Pr. PA11]</td> <td>[Pr. PA12]</td> </tr> <tr> <td>[Pr. PC77] &lt; [Pr. PA11] [Pr. PA12]</td> <td>[Pr. PC77]</td> <td>[Pr. PC77]</td> </tr> </tbody> </table>	Setting value		Torque limit value		[Pr. PT48]	Torque limit value status	Forward rotation torque limit	Reverse rotation torque limit	0: Disabled	-	[Pr. PC77]	[Pr. PC77]	1: Enabled	[Pr. PC77] > [Pr. PA11] [Pr. PA12]	[Pr. PA11]	[Pr. PA12]	[Pr. PC77] < [Pr. PA11] [Pr. PA12]	[Pr. PC77]	[Pr. PC77]	0h	—	○	—
	Setting value		Torque limit value																						
	[Pr. PT48]	Torque limit value status	Forward rotation torque limit	Reverse rotation torque limit																					
	0: Disabled	-	[Pr. PC77]	[Pr. PC77]																					
1: Enabled	[Pr. PC77] > [Pr. PA11] [Pr. PA12]	[Pr. PA11]	[Pr. PA12]																						
	[Pr. PC77] < [Pr. PA11] [Pr. PA12]	[Pr. PC77]	[Pr. PC77]																						
_ _ x _	For manufacturer setting	0h	—	—	—																				
_ x _ _		0h	—	—	—																				
x _ _ _		0h	—	—	—																				
PT49 STA Acceleration time constant	—	Set an acceleration time from 0 r/min or 0 mm/s to the rated speed for the command. If the servo motor is started when a value exceeding 20000 ms is set, [AL. F4] will occur, and the servo motor will not operate.   For example for the servo motor of 3000 r/min rated speed, set 3000 (3 s) to increase speed from 0 r/min to 1000 r/min in 1 s. Setting range: 0 to 50000	0 [ms]	○	○	—																			
PT50 STB Deceleration time constant	—	Set a deceleration time from the rated speed to 0 r/min or 0 mm/s for the command. If the servo motor is started when a value exceeding 20000 ms is set, [AL. F4] will occur, and the servo motor will not operate. In the indexer method, if the servo motor is started when a value exceeding 20000 ms is set, the deceleration time constant is clamped to 20000 ms. Setting range: 0 to 50000	0 [ms]	○	○	—																			

No./symbol/ name	Setting digit	Function	Initial value [unit]	Control mode		
				CP	PS	SP
PT51 STC S-pattern acceleration/ deceleration time constant	—	<p>This enables to start/stop the servo motor or linear servo motor smoothly. Set the time of the arc part for S-pattern acceleration/deceleration. Setting "0" will make it linear acceleration/deceleration.</p> <p>Long setting of STA (acceleration time constant) or STB (deceleration time constant) may produce deviation in the set time of the arc part for the S-pattern acceleration/deceleration time constant. The setting will be disabled at home position return. When 1000 ms or more value is set, it will be clamped to 1000 ms.</p> <p>The upper limit value of the actual arc part time is limited by  <math>\frac{2000000}{STA}</math> for acceleration or by <math>\frac{2000000}{STB}</math> for deceleration.          (Example) At the setting of STA = 20000, STB = 5000 and STC = 200, the actual times for the arc part are as follows:          During acceleration: 100 ms  <math>\frac{2000000}{20000} = 100 \text{ [ms]} &lt; 200 \text{ [ms]}</math>          Therefore, it will be limited to 100 [ms].          During deceleration: 200 ms  <math>\frac{2000000}{50000} = 400 \text{ [ms]} &gt; 200 \text{ [ms]}</math>          Therefore, it will be 200 [ms] as you set.          Setting range: 0 to 5000</p>	0 [ms]	<input type="radio"/>	—	<input type="radio"/>

No./symbol/ name	Setting digit	Function	Initial value [unit]	Control mode														
				CP	PS	SP												
PT62 *DSS Remote register-based position/speed specifying method selection	___ x	Point table method position/speed specifying method selection  <table border="1"> <thead> <tr> <th>Setting value</th> <th>Position command</th> <th>Speed command</th> </tr> </thead> <tbody> <tr> <td>0</td> <td>Point table No.</td> <td>Point table No.</td> </tr> <tr> <td>1</td> <td>Position data</td> <td>Point table No.</td> </tr> <tr> <td>2</td> <td></td> <td>Servo motor speed *1</td> </tr> </tbody> </table> *1 Be sure to set an acceleration/deceleration time constant to point table No. 1.	Setting value	Position command	Speed command	0	Point table No.	Point table No.	1	Position data	Point table No.	2		Servo motor speed *1	0h	○	—	—
	Setting value	Position command	Speed command															
	0	Point table No.	Point table No.															
	1	Position data	Point table No.															
2		Servo motor speed *1																
__ x _	Position/speed specifying method selection of indexer method This digit is available with servo amplifier with software version A3 or later.  <table border="1"> <thead> <tr> <th>Setting value</th> <th>Position command</th> <th>Speed command</th> </tr> </thead> <tbody> <tr> <td>0</td> <td>Next station No.</td> <td>Point table No.</td> </tr> <tr> <td>1</td> <td></td> <td>Servo motor speed *1</td> </tr> </tbody> </table> *1 Be sure to set the acceleration/deceleration time constants in the point table No 1.	Setting value	Position command	Speed command	0	Next station No.	Point table No.	1		Servo motor speed *1	0h	—	○	—				
Setting value	Position command	Speed command																
0	Next station No.	Point table No.																
1		Servo motor speed *1																
_ x _ _	Speed specifying method selection in the speed control mode (point table) 0: Specify the speed selection No. 1: Specify the servo motor speed command (no sign). When this digit is set to "1", set the point table No. 1 or No. 2 to the acceleration/deceleration time constants. The servo motor speed is limited by the number of permissible servo motor rotations.	0h	—	—	○													
x _ _ _	Reflection timing selection for the speed specifying data in the speed control mode (point table) 0: Reflect the data at the edge of when "Speed command execution demand" is turned on. 1: Always reflect the data while "Speed command execution demand" is being turned on.	0h	—	—	○													
PT65 PVC Jog speed command	—	Set a Jog speed command. The fractional portion of the parameter will be rounded down. Setting range: 0.00 to permissible instantaneous speed	100.00 [r/min]/ [mm/s]	○	○	—												
PT69 ZSTH Home position shift distance (extension parameter)	—	Set the extension parameter of [Pr. PT07]. When [Pr. PT69] is used, the home position shift distance can be calculated as follows. Home position shift distance = [Pr. PT07] + ([Pr. PT69] × 65536) Refer to section 4.6 of "MR-J4- _GF_(-RJ) Servo Amplifier Instruction Manual (Motion Mode)" for the home position shift direction. The unit will be as follows depending on the positioning mode. • Point table method It will be changed to [μm], 10 <sup>-4</sup> [inch], 10 <sup>-3</sup> [degree], or [pulse] with [Pr. PT01]. The unit [degree] is available with servo amplifiers with software version A6 or later. • Indexer method It will be command unit [pulse]. (a load-side rotation expressed by the number of servo motor resolution pulses) Refer to the Function column of [Pr. PA10] for the command unit. Additionally, when a value of "1001" or more is set, it will be clamped to "1000". The indexer method can be used with servo amplifiers with software version A3 or later. Setting range: 0 to 32767	0 Refer to Function column for unit.	○	○	—												

No./symbol/ name	Setting digit	Function	Initial value [unit]	Control mode																	
				CP	PS	SP															
PT70 TOP10 Function selection T-10	___x	Function selection for torque limit changing dog type home position return Refer to the following for torque limit changing dog type home position return. ☞ Page 220 Home position return mode	0h	—	○	—															
		<table border="1"> <thead> <tr> <th>Setting value</th> <th>Proximity dog detection end</th> <th>Automatic retract function for home position return</th> </tr> </thead> <tbody> <tr> <td>0</td> <td>Front end detection Stops with reference to the first Z-phase after moving past the front end of the proximity dog.</td> <td>Disabled</td> </tr> <tr> <td>1</td> <td>Rear end detection Stops with reference to the first Z-phase after moving past the rear end of the proximity dog.</td> <td>Disabled</td> </tr> <tr> <td>2</td> <td>Front end detection Stops with reference to the first Z-phase after moving past the front end of the proximity dog.</td> <td>Enabled</td> </tr> <tr> <td>3</td> <td>Rear end detection Stops with reference to the first Z-phase after moving past the rear end of the proximity dog.</td> <td>Enabled</td> </tr> </tbody> </table>		Setting value	Proximity dog detection end	Automatic retract function for home position return	0	Front end detection Stops with reference to the first Z-phase after moving past the front end of the proximity dog.	Disabled	1	Rear end detection Stops with reference to the first Z-phase after moving past the rear end of the proximity dog.	Disabled	2	Front end detection Stops with reference to the first Z-phase after moving past the front end of the proximity dog.	Enabled	3	Rear end detection Stops with reference to the first Z-phase after moving past the rear end of the proximity dog.	Enabled			
	Setting value	Proximity dog detection end		Automatic retract function for home position return																	
	0	Front end detection Stops with reference to the first Z-phase after moving past the front end of the proximity dog.		Disabled																	
1	Rear end detection Stops with reference to the first Z-phase after moving past the rear end of the proximity dog.	Disabled																			
2	Front end detection Stops with reference to the first Z-phase after moving past the front end of the proximity dog.	Enabled																			
3	Rear end detection Stops with reference to the first Z-phase after moving past the rear end of the proximity dog.	Enabled																			
__x_	For manufacturer setting	0h	—	—	—																
_x__		0h	—	—	—																
x___		0h	—	—	—																
PT71 DCTH Travel distance after proximity dog (extension parameter)	—	Set the extension parameter of [Pr. PT09]. When [Pr. PT71] is used, the travel distance after proximity dog can be calculated as follows. Travel distance after proximity dog = [Pr. PT09] + ([Pr. PT71] × 65536) The unit can be changed to 10 <sup>STM</sup> [μm], 10 <sup>(STM-4)</sup> [inch], or [pulse] with the setting of [Pr. PT01]. Setting range: 0 to 32767	0 Refer to Function column for unit.	○	—	—															

## Network setting parameters ([Pr. PN\_ \_])

No./symbol/ name	Setting digit	Function	Initial value [unit]	Control mode		
				CP	PS	SP
PN03 **NWMD Communication mode setting for CC-Link IE communication	___x	Station-specific mode setting Select the motion mode for connection with a simple motion module or the I/O mode for connection with a master/local module. 0: Motion mode 1: I/O mode	0h	○	○	○
	__x_	For manufacturer setting		—	—	—
	_x__			—	—	—
	x___			—	—	—

No./symbol/ name	Setting digit	Function	Initial value [unit]	Control mode		
				CP	PS	SP
PN06 NOP1 Function selection N-1	___x	<p>Communication error alarm history writing selection</p> <p>Select whether [AL. 8D.1 CC-Link IE communication error 1] and [AL. 8D.2 CC-Link IE communication error 2] are recorded in the alarm history at their occurrence.</p> <p>0: Disabled 1: Enabled</p> <p>When the parameter is set to "1", follow the correct procedure for turning off the power to prevent the occurrence of [AL. 8D.1] or [AL. 8D.2] at power supply shut-off (network disconnection). For details, refer to [Pr. PN06 Communication error detection method selection].</p>	0h	<input type="radio"/>	<input type="radio"/>	<input type="radio"/>
	__x_	<p>Communication error detection method selection</p> <p>Select the condition for detecting the occurrences of [AL. 8D.1 CC-Link IE communication error 1] and [AL. 8D.2 CC-Link IE communication error 2].</p> <p>0: Detected only at servo-on. 1: Continuously detected.</p> <p>When the parameter is set to "0", if link device RYn0 (servo-on) is set to "1" in the I/O mode, [AL. 8D.1] and [AL. 8D.2] are detected. When turning off the power in the I/O mode, set link device RYn0 to "0" first.</p> <p>When the parameter is set to "1", [AL. 8D.1] and [AL. 8D.2] are continuously detected while data is being linked. When turning off the power, turn off the servo amplifier first and then the controller.</p>	0h	<input type="radio"/>	<input type="radio"/>	<input type="radio"/>
	_x__	For manufacturer setting	0h	—	—	—
	x___		0h	—	—	—

# 3.3 How to set the electronic gear

## Electronic gear settings in the point table method

Adjust [Pr. PA06] and [Pr. PA07] so that the servo motor setting matches with the travel distance of the machine.

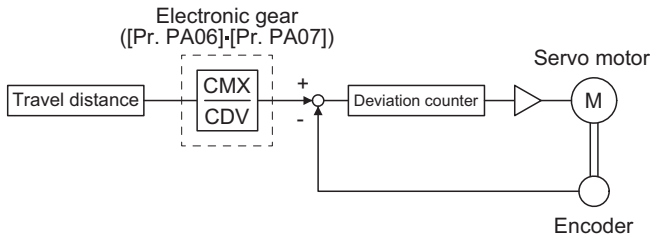

$P_t$ : Servo motor encoder resolution: 4194304 [pulse/rev]

$\Delta S$ : Travel distance per servo motor revolution [mm/rev]/[inch/rev]/[pulse/rev]

$CMX/CDV = P_t/\Delta S$

The following setting example explains how to calculate the electronic gear.

### Point

To calculate the electronic gear, the following specification symbols are required.

$P_b$ : Ball screw lead [mm]

$1/n$ : Reduction ratio

$P_t$ : Servo motor encoder resolution [pulse/rev]

$\Delta S$ : Travel distance per servo motor revolution [mm/rev]

### Setting example of a ball screw

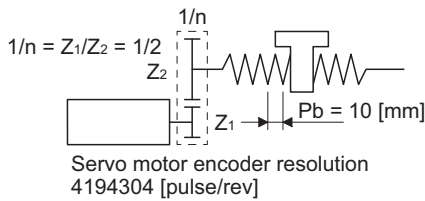

#### • Machine specifications

Ball screw lead  $P_b = 10$  [mm]

Reduction ratio:  $1/n = Z_1/Z_2 = 1/2$

$Z_1$ : Number of gear teeth on servo motor side

$Z_2$ : Number of gear teeth on load gear

Servo motor encoder resolution:  $P_t = 4194304$  [pulse/rev]

$$\frac{CMX}{CDV} = \frac{P_t}{\Delta S} = \frac{P_t}{1/n \cdot P_b \cdot \alpha^{*1}} = \frac{4194304}{1/2 \cdot 10 \cdot 1000} = \frac{4194304}{5000} = \frac{524288}{625}$$

\*1 Because the command unit is "mm",  $\alpha = 1000$  is set. When the unit is "inch", convert the setting into  $\alpha = 10000$ . When the unit is "pulse", convert the setting into  $\alpha = 1$ .

Therefore, set  $CMX = 524288$  and  $CDV = 625$ .



## Setting example of a conveyor

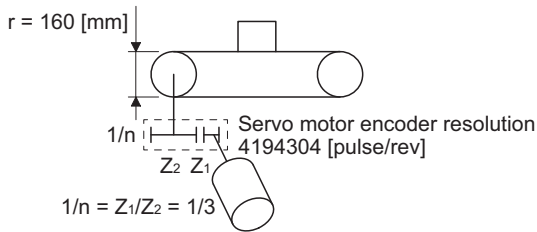

### • Machine specifications

Pulley diameter:  $r = 160 \text{ [mm]}$

Reduction ratio:  $1/n = Z_1/Z_2 = 1/3$

$Z_1$ : Number of gear teeth on servo motor side

$Z_2$ : Number of gear teeth on load gear

Servo motor encoder resolution:  $P_t = 4194304 \text{ [pulse/rev]}$

$$\frac{\text{CMX}}{\text{CDV}} = \frac{P_t}{\Delta S} = \frac{P_t}{1/n \cdot r \cdot \pi \cdot \alpha^{*1}} = \frac{4194304}{1/3 \cdot 160 \cdot \pi \cdot 1000} = \frac{4194304}{167551.61} \approx \frac{524288}{20944}$$

\*1 Because the command unit is "mm",  $\alpha = 1000$  is set. When the unit is "inch", convert the setting into  $\alpha = 10000$ . When the unit is "pulse", convert the setting into  $\alpha = 1$ .

Reduce CMX and CDV to within the setting range or lower and round off each value to the closest whole number.

Therefore, set CMX = 524288 and CDV = 20944.

## Electronic gear setting in the indexer method

Adjust [Pr. PA06] and [Pr. PA07] to align the rotation amount "m" of the servo motor shaft necessary to rotate the load side for "n" times. The following shows a setting example of the electronic gear.

### Number of pulley teeth on machine side: 50, number of pulley teeth on servo motor side: 20

Set [Pr. PA06] = 50 and [Pr. PA07] = 20.

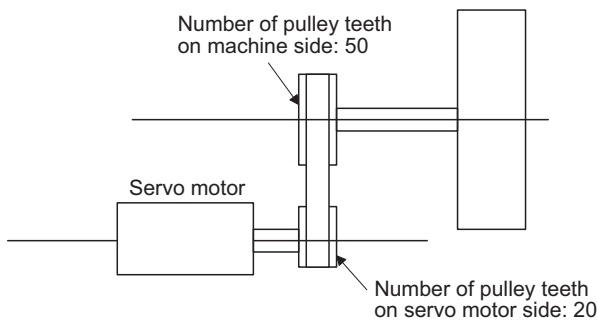

**Number of pulley teeth on machine side: 50, number of pulley teeth on servo motor side: 20, with geared servo motor of 1/9**

Set [Pr. PA06] = 450 and [Pr. PA07] = 20.

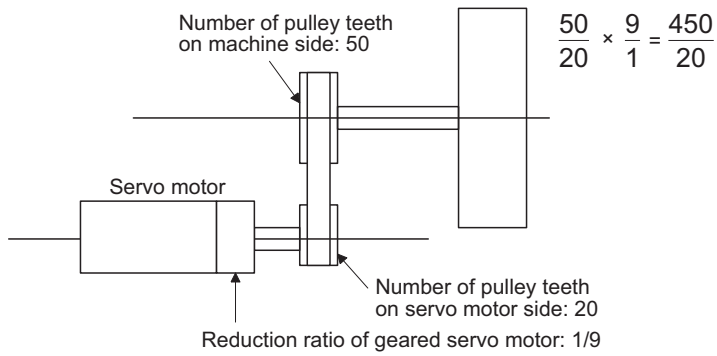

# 3.4 Stop method at stroke limit detection

Select a stop method of the servo motor for when a stroke limit is detected with the setting of the first digit in [Pr. PD12].

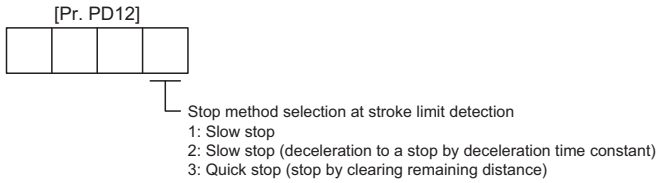

The limit switches are used as follows depending on the setting in "Sensor input type selection" of [Pr. PD41].

[Pr. PD41] = "0 \_\_\_": The stroke ends (LSP and LSN) of the servo amplifier input are used.

[Pr. PD41] = "1 \_\_\_": The stroke limits (RY (n + 1) 0/RY (n + 1) 1) of the controller input are used.

[Pr. PD12] setting	Operation status		Remark
	During rotation at constant speed	During deceleration to a stop	
--- 0	<p>— No S-pattern acceleration/deceleration                      - - - With S-pattern acceleration/deceleration</p> <p>Servo motor speed</p> <p>0 r/min (0 mm/s)</p> <p>RY (n + 1) 0 or RY (n + 1) 1</p> <p>ON OFF</p>	<p>— No S-pattern acceleration/deceleration                      - - - With S-pattern acceleration/deceleration</p> <p>Servo motor speed</p> <p>0 r/min (0 mm/s)</p> <p>RY (n + 1) 0 or RY (n + 1) 1</p> <p>ON OFF</p>	<p>Clears the droop pulses, then stops the servo motor.                      Erases the home position.                      A difference will be generated between the command position and the current position.                      Perform a home position return again.</p>
--- 1 (initial value)	<p>— No S-pattern acceleration/deceleration                      - - - With S-pattern acceleration/deceleration</p> <p>Servo motor speed</p> <p>0 r/min (0 mm/s)</p> <p>RY (n + 1) 0 or RY (n + 1) 1</p> <p>ON OFF</p>	<p>— No S-pattern acceleration/deceleration                      - - - With S-pattern acceleration/deceleration</p> <p>Servo motor speed</p> <p>0 r/min (0 mm/s)</p> <p>RY (n + 1) 0 or RY (n + 1) 1</p> <p>ON OFF</p>	<p>Travels for the droop pulse portion and stops the servo motor.                      Maintains the home position. However, a difference will be generated between the command position and the current position.                      Perform a home position return again.</p>
--- 2	<p>— No S-pattern acceleration/deceleration                      - - - With S-pattern acceleration/deceleration</p> <p>Servo motor speed</p> <p>0 r/min (0 mm/s)</p> <p>RY (n + 1) 0 or RY (n + 1) 1</p> <p>ON OFF</p>	<p>— No S-pattern acceleration/deceleration                      - - - With S-pattern acceleration/deceleration</p> <p>Servo motor speed</p> <p>0 r/min (0 mm/s)</p> <p>RY (n + 1) 0 or RY (n + 1) 1</p> <p>ON OFF</p>	<p>Decelerates to a stop with the deceleration time constant currently selected with the point table.                      Continues operation for a delay portion of the S-pattern acceleration/deceleration time constants. Maintains the home position.                      A difference will not be generated between the command position and the current position.</p>
--- 3	<p>— No S-pattern acceleration/deceleration                      - - - With S-pattern acceleration/deceleration</p> <p>Servo motor speed</p> <p>0 r/min (0 mm/s)</p> <p>RY (n + 1) 0 or RY (n + 1) 1</p> <p>ON OFF</p>	<p>— No S-pattern acceleration/deceleration                      - - - With S-pattern acceleration/deceleration</p> <p>Servo motor speed</p> <p>0 r/min (0 mm/s)</p> <p>RY (n + 1) 0 or RY (n + 1) 1</p> <p>ON OFF</p>	<p>Travels for the droop pulse portion and stops the servo motor.                      Continues operation for a delay portion of the S-pattern acceleration/deceleration time constants. Maintains the home position.                      A difference will not be generated between the command position and the current position.</p>

If "RY (n + 1) 0/RY (n + 1) 1" is turned off during forced stop deceleration, the servo motor stops with the setting of [Pr. PD12].

[Pr. PD12]	Stop method
___ 0	Shifts to quick stop.
___ 1	Continues forced stop deceleration.
___ 2	
___ 3	

When the stroke limit is detected, perform returning as follows.

Mode	Return method
Point table mode	<p>Perform operation in the opposite direction of the limit in the JOG operation.</p> <p>Once the position reaches the range of the limit, perform home position return. If the home position has been determined after home position return completed, positioning operation will be enabled by making a servo-off state once then making a servo-on state again.</p> <p>When "Stop method selection at stroke limit detection" of [Pr. PD12] is set to "2" or "3", home position return is not required to be executed again. Use the automatic positioning to home position function after the servo motor stops at the limit, then perform positioning operation after the servo motor moves to the home position.</p> <p>Positioning operation in the opposite direction of the limit can also be performed after the servo motor stops at the limit.</p>
Speed control mode (point table method)	Perform operation in the opposite direction of the limit.
Indexer mode	Returning method is the same in the point table mode. The setting values "0", "2", and "3" in "Stop method selection at software limit detection" of [Pr. PD12] are available with servo amplifiers with software version A8 or later.

# 3.5 Stop method at software limit detection

Select a stop method of the servo motor for when a software limit ([Pr. PT15] to [Pr. PT18]) is detected with the setting of the third digit in [Pr. PD12]. The software limit limits a command position controlled in the servo amplifier. Therefore, actual stop position will not reach the set position of the software limit.

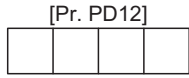

- Stop method selection at software limit detection
- 1: Slow stop
  - 2: Slow stop (deceleration to a stop by deceleration time constant)
  - 3: Quick stop (stop by clearing remaining distance)

[Pr. PD12] setting	Operation status		Remark
	During rotation at constant speed	During deceleration to a stop	
_ 1 _ _ (initial value)	——— No S-pattern acceleration/ deceleration - - - With S-pattern acceleration/ deceleration  Servo motor speed 	——— No S-pattern acceleration/ deceleration - - - With S-pattern acceleration/ deceleration  Servo motor speed 	Travels for the droop pulse portion and stops the servo motor. Maintains the home position. However, a difference will be generated between the command position and the current position. Perform a home position return again.
_ 2 _ _	——— No S-pattern acceleration/ deceleration - - - With S-pattern acceleration/ deceleration  Servo motor speed 	——— No S-pattern acceleration/ deceleration - - - With S-pattern acceleration/ deceleration  Servo motor speed 	Decelerates to a stop with the deceleration time constant currently selected with the point table. Continues operation for a delay portion of the S-pattern acceleration/ deceleration time constants. Maintains the home position. A difference will not be generated between the command position and the current position.
_ 3 _ _	——— No S-pattern acceleration/ deceleration - - - With S-pattern acceleration/ deceleration  Servo motor speed 	——— No S-pattern acceleration/ deceleration - - - With S-pattern acceleration/ deceleration  Servo motor speed 	Travels for the droop pulse portion and stops the servo motor. Continues operation for a delay portion of the S-pattern acceleration/ deceleration time constants. Maintains the home position. A difference will not be generated between the command position and the current position.

# 4 TROUBLESHOOTING

## Point

- Refer to "MELSERVO-J4 Servo Amplifier Instruction Manual (Troubleshooting)" for details of alarms and warnings.
- As soon as an alarm occurs, make the Servo-off status and interrupt the main circuit power.
- [AL. 37 Parameter error] and warnings (except [AL. F0 Tough drive warning]) are not recorded in the alarm history.
- In the initial setting, [AL. 8D.1 CC-Link IE communication error 1] and [AL. 8D.2 CC-Link IE communication error 2] are not recorded in the alarm history. The alarms are recorded by setting [Pr. PN06] to "\_\_\_ 1".

When an error occurs during operation, the corresponding alarm and warning are displayed. When an alarm or warning is displayed, refer to "MELSERVO-J4 Servo Amplifier Instruction Manual (Troubleshooting)" to remove the failure. When an alarm occurs, ALM (Malfunction) will turn off.

## 4.1 Explanation for the lists

### No./Name/Detail No./Detail name

Indicates each No./Name/Detail No./Detail name of alarms or warnings.

### Stop method

For the alarms and warnings in which "SD" is written in the stop method column, the servo motor stops with the dynamic brake after forced stop deceleration. For the alarms and warnings in which "DB" or "EDB" is written in the stop method column, the servo motor stops with the dynamic brake without forced stop deceleration.

### Alarm deactivation

After its cause has been removed, the alarm can be deactivated in any of the methods marked ○ in the alarm deactivation column. Warnings are automatically canceled after the cause of occurrence is removed. Alarms are deactivated with alarm reset, CPU reset, or cycling the power.

Alarm deactivation	Explanation
Alarm reset	<ul style="list-style-type: none"><li>• Error reset command from the controller</li><li>• Click "Occurring Alarm Reset" in the "Alarm Display" window of MR Configurator2</li><li>• Turn on RES (Reset) with an input device *1</li></ul>
CPU reset	Resetting the controller itself
Cycling the power	Turning off the power and on again

\*1 This is available with servo amplifiers with software version A7 or later.

## 4.2 Alarm list

No.	Name	Detail No.	Detail name	Stop method *2*3	Alarm deactivation		
					Alarm reset	CPU reset	Cycling the power
10	Undervoltage	10.1	Voltage drop in the control circuit power	EDB	○	○	○
		10.2	Voltage drop in the main circuit power	SD	○	○	○
11	Switch setting error	11.1	Axis number setting error/Station number setting error	DB	—	—	○
		11.2	Disabling control axis setting error	DB	—	—	○
12	Memory error 1 (RAM)	12.1	RAM error 1	DB	—	—	○
		12.2	RAM error 2	DB	—	—	○
		12.3	RAM error 3	DB	—	—	○
		12.4	RAM error 4	DB	—	—	○
		12.5	RAM error 5	DB	—	—	○
		12.6	RAM error 6	DB	—	—	○
13	Clock error	13.1	Clock error 1	DB	—	—	○
		13.2	Clock error 2	DB	—	—	○
14	Control process error	14.1	Control process error 1	DB	—	—	○
		14.2	Control process error 2	DB	—	—	○
		14.3	Control process error 3	DB	—	—	○
		14.4	Control process error 4	DB	—	—	○
		14.5	Control process error 5	DB	—	—	○
		14.6	Control process error 6	DB	—	—	○
		14.7	Control process error 7	DB	—	—	○
		14.8	Control process error 8	DB	—	—	○
		14.9	Control process error 9	DB	—	—	○
		14.A	Control process error 10	DB	—	—	○
		14.B	Control process error 11	DB	—	—	○
15	Memory error 2 (EEP-ROM)	15.1	EEP-ROM error at power on	DB	—	—	○
		15.2	EEP-ROM error during operation	DB	—	—	○
		15.4	Home position information read error	DB	—	—	○
16	Encoder initial communication error 1	16.1	Encoder initial communication - Receive data error 1	DB	—	—	○
		16.2	Encoder initial communication - Receive data error 2	DB	—	—	○
		16.3	Encoder initial communication - Receive data error 3	DB	—	—	○
		16.5	Encoder initial communication - Transmission data error 1	DB	—	—	○
		16.6	Encoder initial communication - Transmission data error 2	DB	—	—	○
		16.7	Encoder initial communication - Transmission data error 3	DB	—	—	○
		16.A	Encoder initial communication - Process error 1	DB	—	—	○
		16.B	Encoder initial communication - Process error 2	DB	—	—	○
		16.C	Encoder initial communication - Process error 3	DB	—	—	○
		16.D	Encoder initial communication - Process error 4	DB	—	—	○
		16.E	Encoder initial communication - Process error 5	DB	—	—	○
16.F	Encoder initial communication - Process error 6	DB	—	—	○		

No.	Name	Detail No.	Detail name	Stop method *2*3	Alarm deactivation		
					Alarm reset	CPU reset	Cycling the power
17	Board error	17.1	Board error 1	DB	—	—	○
		17.3	Board error 2	DB	—	—	○
		17.4	Board error 3	DB	—	—	○
		17.5	Board error 4	DB	—	—	○
		17.6	Board error 5	DB	—	—	○
		17.7	Board error 7	DB	—	—	○
		17.8	Board error 6*6	EDB	—	—	○
		17.9	Board error 8	DB	—	—	○
19	Memory error 3 (Flash-ROM)	19.1	Flash-ROM error 1	DB	—	—	○
		19.2	Flash-ROM error 2	DB	—	—	○
		19.3	Flash-ROM error 3	DB	—	—	○
1A	Servo motor combination error	1A.1	Servo motor combination error 1	DB	—	—	○
		1A.2	Servo motor control mode combination error	DB	—	—	○
		1A.4	Servo motor combination error 2	DB	—	—	○
1B	Converter error	1B.1	Converter unit error	DB	—	—	○
1E	Encoder initial communication error 2	1E.1	Encoder malfunction	DB	—	—	○
		1E.2	Load-side encoder malfunction	DB	—	—	○
1F	Encoder initial communication error 3	1F.1	Incompatible encoder	DB	—	—	○
		1F.2	Incompatible load-side encoder	DB	—	—	○
20	Encoder normal communication error 1	20.1	Encoder normal communication - Receive data error 1	EDB	—	—	○
		20.2	Encoder normal communication - Receive data error 2	EDB	—	—	○
		20.3	Encoder normal communication - Receive data error 3	EDB	—	—	○
		20.5	Encoder normal communication - Transmission data error 1	EDB	—	—	○
		20.6	Encoder normal communication - Transmission data error 2	EDB	—	—	○
		20.7	Encoder normal communication - Transmission data error 3	EDB	—	—	○
		20.9	Encoder normal communication - Receive data error 4	EDB	—	—	○
		20.A	Encoder normal communication - Receive data error 5	EDB	—	—	○
21	Encoder normal communication error 2	21.1	Encoder data error 1	EDB	—	—	○
		21.2	Encoder data update error	EDB	—	—	○
		21.3	Encoder data waveform error	EDB	—	—	○
		21.4	Encoder non-signal error	EDB	—	—	○
		21.5	Encoder hardware error 1	EDB	—	—	○
		21.6	Encoder hardware error 2	EDB	—	—	○
		21.9	Encoder data error 2	EDB	—	—	○
24	Main circuit error	24.1	Ground fault detected by hardware detection circuit	DB	—	—	○
		24.2	Ground fault detected by software detection function	DB	○	○	○
25	Absolute position erased	25.1	Servo motor encoder - Absolute position erased	DB	—	—	○
		25.2	Scale measurement encoder - Absolute position erased	DB	—	—	○



No.	Name	Detail No.	Detail name	Stop method *2*3	Alarm deactivation		
					Alarm reset	CPU reset	Cycling the power
27	Initial magnetic pole detection error	27.1	Initial magnetic pole detection - Abnormal termination	DB	○	—	○
		27.2	Initial magnetic pole detection - Time out error	DB	○	—	○
		27.3	Initial magnetic pole detection - Limit switch error	DB	○	—	○
		27.4	Initial magnetic pole detection - Estimated error	DB	○	—	○
		27.5	Initial magnetic pole detection - Speed deviation error	DB	○	—	○
		27.6	Initial magnetic pole detection - Position deviation error	DB	○	—	○
		27.7	Initial magnetic pole detection - Current error	DB	○	—	○
28	Linear encoder error 2	28.1	Linear encoder - Environment error	EDB	—	—	○
2A	Linear encoder error 1	2A.1	Linear encoder error 1-1	EDB	—	—	○
		2A.2	Linear encoder error 1-2	EDB	—	—	○
		2A.3	Linear encoder error 1-3	EDB	—	—	○
		2A.4	Linear encoder error 1-4	EDB	—	—	○
		2A.5	Linear encoder error 1-5	EDB	—	—	○
		2A.6	Linear encoder error 1-6	EDB	—	—	○
		2A.7	Linear encoder error 1-7	EDB	—	—	○
		2A.8	Linear encoder error 1-8	EDB	—	—	○
2B	Encoder counter error	2B.1	Encoder counter error 1	EDB	—	—	○
		2B.2	Encoder counter error 2	EDB	—	—	○
30	Regenerative error	30.1	Regeneration heat error	DB	○ <sup>*1</sup>	○ <sup>*1</sup>	○ <sup>*1</sup>
		30.2	Regeneration signal error	DB	○ <sup>*1</sup>	○ <sup>*1</sup>	○ <sup>*1</sup>
		30.3	Regeneration feedback signal error	DB	○ <sup>*1</sup>	○ <sup>*1</sup>	○ <sup>*1</sup>
31	Overspeed	31.1	Abnormal motor speed	SD	○	○	○
32	Overcurrent	32.1	Overcurrent detected at hardware detection circuit (during operation)	DB	—	—	○
		32.2	Overcurrent detected at software detection function (during operation)	DB	○	○	○
		32.3	Overcurrent detected at hardware detection circuit (during a stop)	DB	—	—	○
		32.4	Overcurrent detected at software detection function (during a stop)	DB	○	○	○
33	Overvoltage	33.1	Main circuit voltage error	EDB	○	○	○
34	SSCNET receive error 1	34.1	SSCNET receive data error	SD	○	○ <sup>*5</sup>	○
		34.2	SSCNET connector connection error	SD	○	○	○
		34.3	SSCNET communication data error	SD	○	○	○
		34.4	Hardware error signal detection	SD	○	○	○
		34.5	SSCNET receive data error (safety observation function)	SD	○	○	○
		34.6	SSCNET communication data error (safety observation function)	SD	○	○	○
35	Command frequency error	35.1	Command frequency error	SD	○	○	○
36	SSCNET receive error 2	36.1	Continuous communication data error	SD	○	○	○
		36.2	Continuous communication data error (safety observation function)	SD	○	○	○
37	Parameter error	37.1	Parameter setting range error	DB	—	○	○
		37.2	Parameter combination error	DB	—	○	○
		37.3	Point table setting error	DB	—	—	○
39	Program error	39.1	Program error	DB	—	—	○
		39.2	Instruction argument external error	DB	—	—	○
		39.3	Register No. error	DB	—	—	○
		39.4	Non-correspondence instruction error	DB	—	—	○

No.	Name	Detail No.	Detail name	Stop method *2*3	Alarm deactivation		
					Alarm reset	CPU reset	Cycling the power
3A	Inrush current suppression circuit error	3A.1	Inrush current suppression circuit error	EDB	—	—	○
3D	Parameter setting error for driver communication	3D.1	Parameter combination error for driver communication on slave	DB	—	—	○
		3D.2	Parameter combination error for driver communication on master	DB	—	—	○
3E	Operation mode error	3E.1	Operation mode error	DB	—	○	○
		3E.6	Operation mode switch error	DB	—	—	○
42	Servo control error (for linear servo motor and direct drive motor)	42.1	Servo control error by position deviation	EDB	*4	*4	○
		42.2	Servo control error by speed deviation	EDB	*4	*4	○
		42.3	Servo control error by torque/thrust deviation	EDB	*4	*4	○
	Fully closed loop control error (for fully closed loop control)	42.8	Fully closed loop control error by position deviation	EDB	*4	*4	○
		42.9	Fully closed loop control error by speed deviation	EDB	*4	*4	○
		42.A	Fully closed loop control error by position deviation during command stop	EDB	*4	*4	○
45	Main circuit device overheat	45.1	Main circuit device overheat error 1	SD	○ *1	○ *1	○ *1
		45.2	Main circuit device overheat error 2	SD	○ *1	○ *1	○ *1
46	Servo motor overheat	46.1	Abnormal temperature of servo motor 1	SD	○ *1	○ *1	○ *1
		46.2	Abnormal temperature of servo motor 2	SD	○ *1	○ *1	○ *1
		46.3	Thermistor disconnected error	SD	○ *1	○ *1	○ *1
		46.4	Thermistor circuit error	SD	○ *1	○ *1	○ *1
		46.5	Abnormal temperature of servo motor 3	DB	○ *1	○ *1	○ *1
		46.6	Abnormal temperature of servo motor 4	DB	○ *1	○ *1	○ *1
47	Cooling fan error	47.1	Cooling fan stop error	SD	—	—	○
		47.2	Cooling fan speed reduction error	SD	—	—	○
50	Overload 1	50.1	Thermal overload error 1 during operation	SD	○ *1	○ *1	○ *1
		50.2	Thermal overload error 2 during operation	SD	○ *1	○ *1	○ *1
		50.3	Thermal overload error 4 during operation	SD	○ *1	○ *1	○ *1
		50.4	Thermal overload error 1 during a stop	SD	○ *1	○ *1	○ *1
		50.5	Thermal overload error 2 during a stop	SD	○ *1	○ *1	○ *1
		50.6	Thermal overload error 4 during a stop	SD	○ *1	○ *1	○ *1
51	Overload 2	51.1	Thermal overload error 3 during operation	DB	○ *1	○ *1	○ *1
		51.2	Thermal overload error 3 during a stop	DB	○ *1	○ *1	○ *1
52	Error excessive	52.1	Excess droop pulse 1	SD	○	○	○
		52.3	Excess droop pulse 2	SD	○	○	○
		52.4	Error excessive during 0 torque limit	SD	○	○	○
		52.5	Excess droop pulse 3	EDB	○	○	○
		52.6	Excess droop pulse during servo-off	SD	○	○	○
54	Oscillation detection	54.1	Oscillation detection error	EDB	○	○	○
56	Forced stop error	56.2	Over speed during forced stop	EDB	○	○	○
		56.3	Estimated distance over during forced stop	EDB	○	○	○
61	Operation error	61.1	Point table setting range error	DB	○	—	○
63	STO timing error	63.1	STO1 off	DB	○	○	○
		63.2	STO2 off	DB	○	○	○
		63.5	STO by functional safety unit	DB	○	○	○
64	Functional safety unit setting error	64.1	STO input error	DB	—	—	○
		64.2	Compatibility mode setting error	DB	—	—	○
		64.3	Operation mode setting error	DB	—	—	○

No.	Name	Detail No.	Detail name	Stop method *2*3	Alarm deactivation		
					Alarm reset	CPU reset	Cycling the power
65	Functional safety unit connection error	65.1	Functional safety unit communication error 1	SD	—	—	○
		65.2	Functional safety unit communication error 2	SD	—	—	○
		65.3	Functional safety unit communication error 3	SD	—	—	○
		65.4	Functional safety unit communication error 4	SD	—	—	○
		65.5	Functional safety unit communication error 5	SD	—	—	○
		65.6	Functional safety unit communication error 6	SD	—	—	○
		65.7	Functional safety unit communication error 7	SD	—	—	○
		65.8	Functional safety unit shut-off signal error 1	DB	—	—	○
		65.9	Functional safety unit shut-off signal error 2	DB	—	—	○
66	Encoder initial communication error (safety observation function)	66.1	Encoder initial communication - Receive data error 1 (safety observation function)	DB	—	—	○
		66.2	Encoder initial communication - Receive data error 2 (safety observation function)	DB	—	—	○
		66.3	Encoder initial communication - Receive data error 3 (safety observation function)	DB	—	—	○
		66.7	Encoder initial communication - Transmission data error 1 (safety observation function)	DB	—	—	○
		66.9	Encoder initial communication - Process error 1 (safety observation function)	DB	—	—	○
67	Encoder normal communication error 1 (safety observation function)	67.1	Encoder normal communication - Receive data error 1 (safety observation function)	DB	—	—	○
		67.2	Encoder normal communication - Receive data error 2 (safety observation function)	DB	—	—	○
		67.3	Encoder normal communication - Receive data error 3 (safety observation function)	DB	—	—	○
		67.4	Encoder normal communication - Receive data error 4 (safety observation function)	DB	—	—	○
		67.7	Encoder normal communication - Transmission data error 1 (safety observation function)	DB	—	—	○
68	STO diagnosis error	68.1	Mismatched STO signal error	DB	—	—	○
69	Command error	69.1	Forward rotation-side software limit detection - Command excess error	SD	○	○	○
		69.2	Reverse rotation-side software limit detection - Command excess error	SD	○	○	○
		69.3	Forward rotation stroke end detection - Command excess error	SD	○	○	○
		69.4	Reverse rotation stroke end detection - Command excess error	SD	○	○	○
		69.5	Upper stroke limit detection - Command excess error	SD	○	○	○
		69.6	Lower stroke limit detection - Command excess error	SD	○	○	○

No.	Name	Detail No.	Detail name	Stop method *2*3	Alarm deactivation		
					Alarm reset	CPU reset	Cycling the power
70	Load-side encoder initial communication error 1	70.1	Load-side encoder initial communication - Receive data error 1	DB	—	—	○
		70.2	Load-side encoder initial communication - Receive data error 2	DB	—	—	○
		70.3	Load-side encoder initial communication - Receive data error 3	DB	—	—	○
		70.5	Load-side encoder initial communication - Transmission data error 1	DB	—	—	○
		70.6	Load-side encoder initial communication - Transmission data error 2	DB	—	—	○
		70.7	Load-side encoder initial communication - Transmission data error 3	DB	—	—	○
		70.A	Load-side encoder initial communication - Process error 1	DB	—	—	○
		70.B	Load-side encoder initial communication - Process error 2	DB	—	—	○
		70.C	Load-side encoder initial communication - Process error 3	DB	—	—	○
		70.D	Load-side encoder initial communication - Process error 4	DB	—	—	○
		70.E	Load-side encoder initial communication - Process error 5	DB	—	—	○
		70.F	Load-side encoder initial communication - Process error 6	DB	—	—	○
		71	Load-side encoder normal communication error 1	71.1	Load-side encoder normal communication - Receive data error 1	EDB	—
71.2	Load-side encoder normal communication - Receive data error 2			EDB	—	—	○
71.3	Load-side encoder normal communication - Receive data error 3			EDB	—	—	○
71.5	Load-side encoder normal communication - Transmission data error 1			EDB	—	—	○
71.6	Load-side encoder normal communication - Transmission data error 2			EDB	—	—	○
71.7	Load-side encoder normal communication - Transmission data error 3			EDB	—	—	○
71.9	Load-side encoder normal communication - Receive data error 4			EDB	—	—	○
71.A	Load-side encoder normal communication - Receive data error 5			EDB	—	—	○
72	Load-side encoder normal communication error 2	72.1	Load-side encoder data error 1	EDB	—	—	○
		72.2	Load-side encoder data update error	EDB	—	—	○
		72.3	Load-side encoder data waveform error	EDB	—	—	○
		72.4	Load-side encoder non-signal error	EDB	—	—	○
		72.5	Load-side encoder hardware error 1	EDB	—	—	○
		72.6	Load-side encoder hardware error 2	EDB	—	—	○
		72.9	Load-side encoder data error 2	EDB	—	—	○
74	Option card error 1	74.1	Option card error 1	DB	—	—	○
		74.2	Option card error 2	DB	—	—	○
		74.3	Option card error 3	DB	—	—	○
		74.4	Option card error 4	DB	—	—	○
		74.5	Option card error 5	DB	—	—	○
75	Option card error 2	75.3	Option card connection error	EDB	—	—	○
		75.4	Option card disconnected	DB	—	—	○

No.	Name	Detail No.	Detail name	Stop method *2*3	Alarm deactivation		
					Alarm reset	CPU reset	Cycling the power
79	Functional safety unit diagnosis error	79.1	Functional safety unit power voltage error	DB	○ <sup>*7</sup>	—	○
		79.2	Functional safety unit internal error	DB	—	—	○
		79.3	Abnormal temperature of functional safety unit	SD	○ <sup>*7</sup>	—	○
		79.4	Servo amplifier error	SD	—	—	○
		79.5	Input device error	SD	—	—	○
		79.6	Output device error	SD	—	—	○
		79.7	Mismatched input signal error	SD	—	—	○
		79.8	Position feedback fixing error	DB	—	—	○
7A	Parameter setting error (safety observation function)	7A.1	Parameter verification error (safety observation function)	DB	—	—	○
		7A.2	Parameter setting range error (safety observation function)	DB	—	—	○
		7A.3	Parameter combination error (safety observation function)	DB	—	—	○
		7A.4	Functional safety unit combination error (safety observation function)	DB	—	—	○
7B	Encoder diagnosis error (safety observation function)	7B.1	Encoder diagnosis error 1 (safety observation function)	DB	—	—	○
		7B.2	Encoder diagnosis error 2 (safety observation function)	DB	—	—	○
		7B.3	Encoder diagnosis error 3 (safety observation function)	DB	—	—	○
		7B.4	Encoder diagnosis error 4 (safety observation function)	DB	—	—	○
7C	Functional safety unit communication diagnosis error (safety observation function)	7C.1	Functional safety unit communication setting error (safety observation function)	SD	○ <sup>*7</sup>	○	○
		7C.2	Functional safety unit communication data error (safety observation function)	SD	○ <sup>*7</sup>	○	○
7D	Safety observation error	7D.1	Stop observation error	DB	○ <sup>*3</sup>	—	○
		7D.2	Speed observation error	DB	○ <sup>*7</sup>	—	○
82	Master-slave operation error 1	82.1	Master-slave operation error 1	EDB	○	○	○
84	Network module initialization error	84.1	Network module undetected error	DB	—	—	○
		84.2	Network module initialization error 1	DB	—	—	○
		84.3	Network module initialization error 2	DB	—	—	○
85	Network module error	85.1	Network module error 1	SD	—	—	○
		85.2	Network module error 2	SD	—	—	○
		85.3	Network module error 3	SD	—	—	○
86	Network communication error	86.1	Network communication error 1	SD	○	—	○
		86.2	Network communication error 2	SD	○	—	○
		86.3	Network communication error 3	SD	○	—	○
8A	USB communication time-out error/serial communication time-out error/Modbus RTU communication time-out error	8A.1	USB communication time-out error/serial communication time-out error	SD	○	○	○
		8A.2	Modbus RTU communication time-out error	SD	○	○	○
8D	CC-Link IE communication error	8D.1	CC-Link IE communication error 1	SD	○	—	○
		8D.2	CC-Link IE communication error 2	SD	○	—	○
		8D.3	Master station setting error 1	DB	○	—	○
		8D.5	Master station setting error 2	DB	—	—	○
		8D.6	CC-Link IE communication error 3	SD	○	—	○
		8D.7	CC-Link IE communication error 4	SD	○	—	○
		8D.8	CC-Link IE communication error 5	SD	○	—	○
		8D.9	Synchronization error 1	SD	—	—	○
		8D.A	Synchronization error 2	SD	—	—	○

No.	Name	Detail No.	Detail name	Stop method *2*3	Alarm deactivation		
					Alarm reset	CPU reset	Cycling the power
8E	USB communication error/ serial communication error/ Modbus RTU communication error	8E.1	USB communication receive error/serial communication receive error	SD	○	○	○
		8E.2	USB communication checksum error/serial communication checksum error	SD	○	○	○
		8E.3	USB communication character error/serial communication character error	SD	○	○	○
		8E.4	USB communication command error/serial communication command error	SD	○	○	○
		8E.5	USB communication data number error/serial communication data number error	SD	○	○	○
		8E.6	Modbus RTU communication receive error	SD	○	○	○
		8E.7	Modbus RTU communication message frame error	SD	○	○	○
		8E.8	Modbus RTU communication CRC error	SD	○	○	○
88888	Watchdog	8888_	Watchdog	DB	—	—	○

\*1 Leave for about 30 minutes of cooling time after removing the cause of occurrence.

\*2 The following shows three stop methods of DB, EDB, and SD.

DB: Stops with dynamic brake. (Coasts for the servo amplifier without dynamic brake.)

Coasts for MR-J4-03A6(-RJ) and MR-J4W2-0303B6. Note that EDB is applied when an alarm below occurs; [AL. 30.1], [AL. 32.2], [AL. 32.4], [AL. 51.1], [AL. 51.2], [AL. 888]

EDB: Electronic dynamic brake stop (available with specified servo motors)

Refer to the following table for the specified servo motors. The stop method for other than the specified servo motors will be DB.

Series	Servo motor
HG-KR	HG-KR053/HG-KR13/HG-KR23/HG-KR43
HG-MR	HG-MR053/HG-MR13/HG-MR23/HG-MR43
HG-SR	HG-SR51/HG-SR52
HG-AK	HG-AK0136/HG-AK0236/HG-AK0336

SD: Forced stop deceleration

\*3 This is applicable when [Pr. PA04] is set to the initial value. The stop system of SD can be changed to DB using [Pr. PA04].

\*4 The alarm can be canceled by setting as follows:

For the fully closed loop control: set [Pr. PE03] to "1 \_\_\_".

When a linear servo motor or direct drive motor is used: set [Pr. PL04] to "1 \_\_\_".

\*5 In some controller communication status, the alarm factor may not be removed.

\*6 This alarm will occur only in the J3 compatibility mode.

\*7 Reset this while all the safety observation functions are stopped.

## 4.3 Warning list

No.	Name	Detail No.	Detail name	Stop method *2*3
90	Home position return incomplete warning	90.1	Home position return incomplete	—
		90.2	Home position return abnormal termination	—
		90.5	Z-phase unpassed	—
91	Servo amplifier overheat warning *1	91.1	Main circuit device overheat warning	—
92	Battery cable disconnection warning	92.1	Encoder battery cable disconnection warning	—
		92.3	Battery degradation	—
93	ABS data transfer warning	93.1	Magnetic pole detection incomplete warning at ABS data transfer request	—
95	STO warning	95.1	STO1 off detection	DB
		95.2	STO2 off detection	DB
		95.3	STO warning 1 (safety observation function)	DB
		95.4	STO warning 2 (safety observation function)	DB
		95.5	STO warning 3 (safety observation function)	DB
96	Home position setting warning	96.1	In-position warning at home positioning	—
		96.2	Command input warning at home positioning	—
		96.3	Servo off warning at home positioning	—
		96.4	Magnetic pole detection incomplete warning at home positioning	—
97	Positioning specification warning	97.1	Program operation disabled warning	—
		97.2	Next station position warning	—
98	Software limit warning	98.1	Forward rotation-side software stroke limit reached	—
		98.2	Reverse rotation-side software stroke limit reached	—
99	Stroke limit warning	99.1	Forward rotation stroke end off	*4*5
		99.2	Reverse rotation stroke end off	*4*5
		99.4	Upper stroke limit off	*5
		99.5	Lower stroke limit off	*5
9A	Optional unit input data error warning	9A.1	Optional unit input data sign error	—
		9A.2	Optional unit BCD input data error	—
9B	Error excessive warning	9B.1	Excess droop pulse 1 warning	—
		9B.3	Excess droop pulse 2 warning	—
		9B.4	Error excessive warning during 0 torque limit	—
9C	Converter error	9C.1	Converter unit error	—
9D	CC-Link IE warning 1	9D.1	Station number switch change warning	—
		9D.2	Master station setting warning	—
		9D.3	Overlapping station number warning	—
		9D.4	Mismatched station number warning	—
9E	CC-Link IE warning 2	9E.1	CC-Link IE communication warning	—
9F	Battery warning	9F.1	Low battery	—
		9F.2	Battery degradation warning	—
E0	Excessive regeneration warning	E0.1	Excessive regeneration warning	—
E1	Overload warning 1	E1.1	Thermal overload warning 1 during operation	—
		E1.2	Thermal overload warning 2 during operation	—
		E1.3	Thermal overload warning 3 during operation	—
		E1.4	Thermal overload warning 4 during operation	—
		E1.5	Thermal overload error 1 during a stop	—
		E1.6	Thermal overload error 2 during a stop	—
		E1.7	Thermal overload error 3 during a stop	—
		E1.8	Thermal overload error 4 during a stop	—
E2	Servo motor overheat warning	E2.1	Servo motor temperature warning	—

No.	Name	Detail No.	Detail name	Stop method *2*3
E3	Absolute position counter warning	E3.1	Multi-revolution counter travel distance excess warning	—
		E3.2	Absolute position counter warning	—
		E3.4	Absolute positioning counter EEPROM writing frequency warning	—
		E3.5	Encoder absolute positioning counter warning	—
E4	Parameter warning	E4.1	Parameter setting range error warning	—
E5	ABS time-out warning	E5.1	Time-out during ABS data transfer	—
		E5.2	ABSM off during ABS data transfer	—
		E5.3	SON off during ABS data transfer	—
E6	Servo forced stop warning	E6.1	Forced stop warning	SD
		E6.2	SS1 forced stop warning 1 (safety observation function)	SD
		E6.3	SS1 forced stop warning 2 (safety observation function)	SD
E7	Controller forced stop warning	E7.1	Controller forced stop input warning	SD
E8	Cooling fan speed reduction warning	E8.1	Decreased cooling fan speed warning	—
		E8.2	Cooling fan stop	—
E9	Main circuit off warning	E9.1	Servo-on signal on during main circuit off	DB
		E9.2	Bus voltage drop during low speed operation	DB
		E9.3	Ready-on signal on during main circuit off	DB
		E9.4	Converter unit forced stop	DB
EA	ABS servo-on warning	EA.1	ABS servo-on warning	—
EB	The other axis error warning	EB.1	The other axis error warning	DB
EC	Overload warning 2	EC.1	Overload warning 2	—
ED	Output watt excess warning	ED.1	Output watt excess warning	—
F0	Tough drive warning	F0.1	Instantaneous power failure tough drive warning	—
		F0.3	Vibration tough drive warning	—
F2	Drive recorder - Miswriting warning	F2.1	Drive recorder - Area writing time-out warning	—
		F2.2	Drive recorder - Data miswriting warning	—
F3	Oscillation detection warning	F3.1	Oscillation detection warning	—
F4	Positioning warning	F4.4	Target position setting range error warning	—
		F4.6	Acceleration time constant setting range error warning	—
		F4.7	Deceleration time constant setting range error warning	—
		F4.9	Home position return type error warning	—
F5	Simple cam function - Cam data miswriting warning	F5.1	Cam data - Area writing time-out warning	—
		F5.2	Cam data - Area miswriting warning	—
		F5.3	Cam data checksum error	—
F6	Simple cam function - Cam control warning	F6.1	Cam axis one cycle current value restoration failed	—
		F6.2	Cam axis feed current value restoration failed	—
		F6.3	Cam unregistered error	—
		F6.4	Cam control data setting range error	—
		F6.5	Cam No. external error	—
		F6.6	Cam control inactive	—
F7	Machine diagnosis warning	F7.1	Vibration failure prediction warning	—
		F7.2	Friction failure prediction warning	—
		F7.3	Total travel distance failure prediction warning	—

\*1 Leave for about 30 minutes of cooling time after removing the cause of occurrence.

\*2 The following shows two stop methods of DB and SD.

DB: Stops with dynamic brake. (Coasts for the servo amplifier without dynamic brake.)

Coasts for MR-J4-03A6(-RJ) and MR-J4W2-0303B6.

SD: Forced stop deceleration

\*3 This is applicable when [Pr. PA04] is set to the initial value. The stop system of SD can be changed to DB using [Pr. PA04].

\*4 For MR-J4-\_A\_ servo amplifier, quick stop or slow stop can be selected using [Pr. PD30].

\*5 For MR-J4-\_GF\_ servo amplifier, quick stop or slow stop can be selected using [Pr. PD12]. (I/O mode only)



## 4.4 Troubleshooting at power on

When an error occurs at the power supply of the controller or servo amplifier, improper boot of the servo amplifier might be the cause. Check the display of the servo amplifier, and take actions according to this section.

Display	Description	Cause	Checkpoint	Action
AA	The power of the controller was turned off.	The power of the controller was turned off.	Check the power of the controller.	Switch on the power of the controller.
		An Ethernet cable was disconnected.	"AA" is displayed in the corresponding station and following stations.	Replace the Ethernet cable of the corresponding station.
			Check if the connectors (CN1A, CN1B) are unplugged.	Connect it correctly.
Ab	Initialization communication with the controller has not completed.	An Ethernet cable was disconnected.	"Ab" is displayed in the corresponding station and following stations.	Replace the Ethernet cable of the corresponding station.
		The power of the servo amplifier was switched on when the power of the controller was off.	Check the power of the controller.	Switch on the power of the controller.
		The servo amplifier is malfunctioning.	"Ab" is displayed in the corresponding station and following stations.	Replace the servo amplifier.
		The controller is malfunctioning.	Replace the controller, and then check the repeatability.	Replace the controller.
AC	The synchronous communications by specified cycle could not be made.	The setting of the station No. is incorrect.	Check that a device is not assigned to the same station No.	Set it correctly.
		Station No. does not match with the station No. set to the controller.	Check the controller setting and station No.	Set it correctly.
		The communication cycle does not match.	Check the communication cycle at the controller side.	Set it correctly.
		The servo amplifier parameter setting is incorrect.	Check the following parameter settings. [Pr. PN03] [Pr. PD41]	Set it correctly.
		Data link was established again.	Network configuration was changed.	After checking the network configuration, cycle the power of the servo amplifier.
		The controller setting is incorrect.	Check the controller setting.	Set it correctly.
		The servo amplifier is malfunctioning.	"AC" is displayed in the corresponding station and following stations.	Replace the servo amplifier.
		The controller is malfunctioning.	Replace the controller, and then check the repeatability.	Replace the controller.
b##. *1 C##. *1 d##. *1	The system has been in the test operation mode.	Test operation mode has been enabled.	Test operation select switch (SW1-1) is turned on.	Turn off the test operation select switch (SW1-1).
off	Operation mode for manufacturer setting is set.	Operation mode for manufacturer setting is enabled.	Check that the test operation select switch (SW1-1) and manufacturer setting switch (SW1-2) are not on.	Set the auxiliary station number setting switch (SW1) correctly.

\*1 ## indicates station No.

# 5 INDEXER OPERATION

The items shown in the following table are the same as those for the motion mode. For details, refer to each section indicated in the detailed explanation field. "MR-J4-\_GF\_" means "MR-J4-\_GF\_(-RJ) Servo Amplifier Instruction Manual (Motion Mode)".

Item	Detailed explanation
Startup	MR-J4-_GF_ section 4.2
Switch setting and display of the servo amplifier	MR-J4-_GF_ section 4.3
Test operation	MR-J4-_GF_ section 4.4
Test operation mode	MR-J4-_GF_ section 4.5

## Point

The indexer operation can be used with servo amplifiers with software version A3 or later.

In the absolute position detection system, rotating the shaft one revolution or more during power-off may erase a home position. Therefore, do not rotate the shaft one revolution or more during power-off. At operation start-up after a home position is erased, [AL. 90 Home position return incomplete warning] will occur. In that case, execute the home position return again.

There are the following restrictions on [Pr. PA06 Number of gear teeth on machine side] and the servo motor speed (N).

- When [Pr. PA06]  $\leq 2000$ ,  $N < 3076.7$  r/min
- When [Pr. PA06]  $> 2000$ ,  $N < (3276.7 - CMX)/10$  r/min

When the servo motor is operated continuously at a servo motor speed higher than the limit value, [AL. E3 Absolute position counter warning] will occur.

The setting of [Pr. PC77 Internal torque limit 2] will be enabled automatically depending on the operation status. Since the initial value of [Pr. PC77] is 0.0 %, change the value to use the indexer operation. If the value is unchanged, the servo motor coasts during a stop.

## 5.1 Link device

### Profile

Some input devices can be assigned to the pins of the CN3 connector with [Pr. PD03] to [Pr. PD05]. When using the CC-Link IE Field Network communication and CN3 connector's input signal, assigned devices other than upper stroke limit, lower stroke limit and proximity dog can be used simultaneously.

Some output devices can be assigned to the pins of the CN3 connector with [Pr. PD07] to [Pr. PD09]. The assigned devices can be used together when using the CC-Link IE Field Network communication and CN3 connector's output signal.

When turning off input/output signals, turn off both CC-Link IE Field Network communication and external I/O signals of the CN3 connector. The following shows the profile of link devices communicated with the master station in cyclic communication.

## RYn profile

Master station → Servo amplifier (RYn)			
Device No. *1	Device	Symbol	CN3 connector pin No.
RYn0	Servo-on	SON	—
RYn1	Start	ST1	—
RYn2	Rotation direction specifying	SIG	—
RYn3	Proximity dog	DOG	19
RYn4	Unavailable	—	—
RYn5			
RYn6	Operation mode selection 1	MD0	—
RYn7	Operation mode selection 2	MD1	—
RYn8	Monitor output execution demand	MOR	—
RYn9	Instruction code execution demand	COR	—
RYnA to RYnE	Unavailable	—	—
RYnF	Clear *3	CR	—
RY (n + 1) 0	Upper stroke limit	FLS	—
RY (n + 1) 1	Lower stroke limit	RLS	—
RY (n + 1) 2	Operation alarm reset	ORST	—
RY (n + 1) 3 to RY (n + 1) A	Unavailable	—	—
RY (n + 1) B	Analog override selection *2	OVR	—
RY (n + 1) C	Digital override selection 1 *2	OV0	—
RY (n + 1) D	Digital override selection 2 *2	OV1	—
RY (n + 1) E	Digital override selection 3 *2	OV2	—
RY (n + 1) F	Digital override selection 4 *2	OV3	—
RY (n + 2) 0	Position command execution demand	PSR	—
RY (n + 2) 1	Speed command execution demand	SPR	—
RY (n + 2) 2 to RY (n + 2) 5	Unavailable	—	—
RY (n + 2) 6	Internal torque limit selection *3	CTL	—
RY (n + 2) 7	Proportional control (PID control)	PC	—
RY (n + 2) 8	Gain switching	CDP	—
RY (n + 2) 9	Unavailable	—	—
RY (n + 2) A	Position/speed specifying method selection	CSL	—
RY (n + 2) B to RY (n + 2) F	Unavailable	—	—
RY (n + 3) 0 to RY (n + 3) 9			
RY (n + 3) A	Reset	RES	—
RY (n + 3) B to RY (n + 3) F	Unavailable	—	—

\*1 "n" depends on the station No. setting.

\*2 This is available with servo amplifiers with software version A6 or later.

\*3 This is available with servo amplifiers with software version A7 or later.

## RXn profile

Servo amplifier → Master station (RXn)			
Device No. *1	Device	Symbol	CN3 connector pin No.
RXn0	Ready	RD	—
RXn1	In-position	INP	9
RXn2	Rough match	CPO	—
RXn3	Unavailable	—	—
RXn4	Limiting torque	TLC	—
RXn5	Unavailable	—	—
RXn6	Electromagnetic brake interlock	MBR	13
RXn7	Unavailable	—	—
RXn8	Monitoring	MOF	—
RXn9	Instruction code execution completion	COF	—
RXnA	Warning	WNG	—
RXnB	Battery warning	BWNG	—
RXnC	Travel completion	MEND	—
RXnD	Dynamic brake interlock	DB	—
RXnE	Unavailable	—	—
RXnF			
RX (n + 1) 0	Home position return completion 2	ZP2	—
RX (n + 1) 1 to RX (n + 1) F	Unavailable	—	—
RX (n + 2) 0	Position command execution completion	PSF	—
RX (n + 2) 1	Speed command execution completion	SPF	—
RX (n + 2) 2 to RX (n + 2) F	Unavailable	—	—
RX (n + 3) 0 to RX (n + 3) 9			
RX (n + 3) A	Malfunction	ALM	15
RX (n + 3) B	Remote station communication ready	CRD	—
RX (n + 3) C to RX (n + 3) F	Unavailable	—	—

\*1 "n" depends on the station No. setting.

## RWwn profile

Master station → Servo amplifier (RWwn)	
Device No. <sup>*1</sup>	Device
RWwn0	Monitor 1
RWwn1	Unavailable
RWwn2	Monitor 2
RWwn3	Unavailable
RWwn4	Instruction code - Lower 16 bits
RWwn5	Instruction code - Upper 16 bits
RWwn6	Next station No. selection
RWwn7	Speed selection
RWwn8	Next station No. <sup>*2</sup>
RWwn9	Unavailable
RWwnA	Speed command data - Lower 16 bits/Point table No. <sup>*2</sup>
RWwnB	Speed command data - Upper 16 bits <sup>*2</sup>
RWwnC	Writing data - Lower 16 bits
RWwnD	Writing data - Upper 16 bits
RWwnE	Unavailable
RWwnF	Analog override <sup>*3</sup>

\*1 "n" depends on the station No. setting.

\*2 Use this device when the remote register-based position/speed specifying method is selected.

\*3 This is available with servo amplifiers with software version A6 or later.

## RWrn profile

Servo amplifier → Master station (RWrn)	
Device No. <sup>*1</sup>	Device
RWrn0	Monitor 1 data - Lower 16 bits
RWrn1	Monitor 1 data - Upper 16 bits
RWrn2	Monitor 2 data - Lower 16 bits
RWrn3	Monitor 2 data - Upper 16 bits
RWrn4	Respond code
RWrn5	Unavailable
RWrn6	Station No. output
RWrn7	Unavailable
RWrn8	
RWrn9	
RWrnA	
RWrnB	
RWrnC	Reading data - Lower 16 bits
RWrnD	Reading data - Upper 16 bits
RWrnE	Unavailable
RWrnF	

\*1 "n" depends on the station No. setting.

# Detailed explanation of the RYn/RXn profile

## RYn profile

Device No.	Device	Description															
RYn0	Servo-on	Turn on RYn0 to power on the base circuit, and make the servo amplifier ready to operate. (servo-on status) Turn it off to shut off the base circuit, and coast the servo motor.															
RYn1	Start	<ul style="list-style-type: none"> <li>Automatic operation mode</li> </ul> Turning on RYn1 will execute one positioning operation to the specified station No. <ul style="list-style-type: none"> <li>Manual operation mode</li> </ul> When the station JOG operation is set, turning on RYn1 will rotate the servo motor in the direction specified with RYn2 only while RYn1 is on. Turning off RYn1 will execute a positioning to a station position at which the servo motor can decelerate to a stop. When the JOG operation is set, turning on RYn1 will rotate the motor in the direction specified with RYn2 only while RYn1 is on. Turning off will decelerate the motor to a stop regardless of the station position. <ul style="list-style-type: none"> <li>Home position return mode</li> </ul> Turning on RYn1 will start home position return.															
RYn2	Rotation direction specifying	Specify the rotation direction at start by turning on/off RYn2. <ul style="list-style-type: none"> <li>Automatic operation mode</li> </ul> The rotation direction varies depending on the setting of [Pr. PA14]. RYn2 is only for the rotation direction specifying indexer. This is not used with the shortest rotating indexer operation. <table border="1" data-bbox="651 846 1445 1032"> <thead> <tr> <th>RYn2</th> <th>Pr. PA14</th> <th>Servo motor rotation direction</th> </tr> </thead> <tbody> <tr> <td rowspan="2">Off</td> <td>0</td> <td>CCW or positive direction</td> </tr> <tr> <td>1</td> <td>CW or negative direction</td> </tr> <tr> <td rowspan="2">On</td> <td>0</td> <td>CW or negative direction</td> </tr> <tr> <td>1</td> <td>CCW or positive direction</td> </tr> </tbody> </table> <ul style="list-style-type: none"> <li>Manual operation mode</li> </ul> The rotation direction varies depending on the setting of [Pr. PA14]. The relation between the parameter and rotation direction is the same as that for the automatic operation mode. <ul style="list-style-type: none"> <li>Home position return mode</li> </ul> RYn2 is disabled. Specify the rotation direction in the home position return mode with [Pr. PT45].	RYn2	Pr. PA14	Servo motor rotation direction	Off	0	CCW or positive direction	1	CW or negative direction	On	0	CW or negative direction	1	CCW or positive direction		
RYn2	Pr. PA14	Servo motor rotation direction															
Off	0	CCW or positive direction															
	1	CW or negative direction															
On	0	CW or negative direction															
	1	CCW or positive direction															
RYn3	Proximity dog	When RYn3 is turned on, a proximity dog will be detected. The polarity for dog can be changed with [Pr. PT29]. <table border="1" data-bbox="651 1249 1334 1361"> <thead> <tr> <th>[Pr. PT29]</th> <th>Polarity for proximity dog detection</th> </tr> </thead> <tbody> <tr> <td>___ 0 (initial value)</td> <td>Detection with on</td> </tr> <tr> <td>___ 1</td> <td>Detection with off</td> </tr> </tbody> </table>	[Pr. PT29]	Polarity for proximity dog detection	___ 0 (initial value)	Detection with on	___ 1	Detection with off									
[Pr. PT29]	Polarity for proximity dog detection																
___ 0 (initial value)	Detection with on																
___ 1	Detection with off																
RYn6	Operation mode selection 1	Select an operation mode with the settings of RYn6 and RYn7.															
RYn7	Operation mode selection 2	<table border="1" data-bbox="663 1429 1445 1653"> <thead> <tr> <th>RYn7</th> <th>RYn6</th> <th>Operation mode</th> </tr> </thead> <tbody> <tr> <td>Off</td> <td>Off</td> <td>Home position return mode</td> </tr> <tr> <td>Off</td> <td>On</td> <td>Manual operation mode</td> </tr> <tr> <td>On</td> <td>Off</td> <td>Automatic operation mode (rotation direction specifying indexer)</td> </tr> <tr> <td>On</td> <td>On</td> <td>Automatic operation mode (shortest rotating indexer)</td> </tr> </tbody> </table>	RYn7	RYn6	Operation mode	Off	Off	Home position return mode	Off	On	Manual operation mode	On	Off	Automatic operation mode (rotation direction specifying indexer)	On	On	Automatic operation mode (shortest rotating indexer)
RYn7	RYn6	Operation mode															
Off	Off	Home position return mode															
Off	On	Manual operation mode															
On	Off	Automatic operation mode (rotation direction specifying indexer)															
On	On	Automatic operation mode (shortest rotating indexer)															
RYn8	Monitor output execution demand	Turning on RYn8 sets the following data and turns on RXn8. While RYn8 is on, the monitor value is always updated. <ul style="list-style-type: none"> <li>RWm0: Lower 16 bits of data requested with RWwn0 (Monitor 1)</li> <li>RWm1: Upper 16 bits of data requested with RWwn0 (Monitor 1)</li> <li>RWm2: Lower 16 bits of data requested with RWwn2 (Monitor 2)</li> <li>RWm3: Upper 16 bits of data requested with RWwn2 (Monitor 2)</li> <li>RWm4: Respond code indicating a normal or error result</li> </ul>															
RYn9	Instruction code execution demand	Turning on RYn9 executes the processing corresponding to the instruction code set with RWwn4 and RWwn5. After the instruction code execution is completed, a respond code indicating a normal or error result is stored in RWrn4, and RXn9 turns on. Refer to the following for details of the instruction code. <p>☞ Page 35 Instruction code</p>															

Device No.	Device	Description
RYnF	Clear	Turning on RYnF clears the droop pulses and the command remaining distance in the position control counter at the rising edge. The pulse width should be 10 ms or more. If [Pr. PD42] is set to "___1", the droop pulses and the command remaining distance will always be cleared while RYnF is on.
RY (n + 1) 0	Upper stroke limit	To execute the operation, turn on RY (n + 1) 0 and RY (n + 1) 1. Turning off the device corresponding to the address increasing or decreasing direction will bring the servo motor to a slow stop and make it servo-locked. The stop method can be changed with [Pr. PD12].
RY (n + 1) 1	Lower stroke limit	
RY (n + 1) 2	Operation alarm reset	Turn on RY (n + 1) 2 from off to reset [AL. F4 Positioning warning].
RY (n + 1) B	Analog override selection	When using this device, set "Override selection" of [Pr. PT38] to "2" to enable the analog override function. Turning on RY (n + 1) B enables the setting value of the analog override (RWwnF).
RY (n + 1) C	Digital override selection 1	When using this device, set "Override selection" of [Pr. PT38] to "1" to enable the digital override function. The actual servo motor speed can be obtained by multiplying the command speed and a digital override value selected in the digital override selection 1 to 4.
RY (n + 1) D	Digital override selection 2	
RY (n + 1) E	Digital override selection 3	
RY (n + 1) F	Digital override selection 4	
RY (n + 2) 0	Position command execution demand	
RY (n + 2) 1	Speed command execution demand	Turning on RY (n + 2) 1 sets the point table No. or speed command data set in RWwnA and RWwnB. If a point table No. or speed command data is set to the servo amplifier, a respond code indicating a normal or error result is set in RWrn4 and RX (n + 2) 1 (Position command execution completion) turns on.  Page 193 Remote register-based position/speed setting
RY (n + 2) 6	Internal torque limit selection	If RY (n + 2) 6 is turned on, the setting value of [Pr. PA11 Forward rotation torque limit] or [Pr. PA12 Reverse rotation torque limit] is compared with [Pr. PC77 Internal torque limit] and the lower one will be enabled.
RY (n + 2) 7	Proportional control (PID control)	Turn on RY (n + 2) 7 to switch the speed amplifier from the proportional integral type to the proportional type. If the servo motor at a stop is rotated even one pulse due to any external factor, it generates torque to compensate for a position shift. When the servo motor shaft is to be locked mechanically after RXnC (Travel completion) is turned off, switching on RY (n + 2) 7 upon turning RXnC off will suppress the unnecessary torque generated to compensate for a position shift. When the shaft is to be locked for a long time, turn on RY (n + 2) 7 and make the torque less than the rated torque with the torque limit. This function will be enabled by selecting "PI control enabled (___0)" in "PI-PID switching control selection" of [Pr. PB24].
RY (n + 2) 8	Gain switching	Turn on RY (n + 2) 8 to use the values of [Pr. PB29] to [Pr. PB36] and [Pr. PB56] to [Pr. PB60] as the load to motor inertia ratio and gain values.
RY (n + 2) A	Position/speed specifying method selection	Select how to give a position command and speed command. Off: Specify a next station No. with RWwn6 to give a position command. Specify a point table No. with RWwn7 to give a speed command. On: When [Pr. PT62] is set to "___0_", specify a next station No. with RWwn8 to give a position command, and specify a point table No. with RWwnA to give a speed command. When [Pr. PT62] is set to "___1_", specify a next station No. with RWwn8 to give a position command, and specify speed command data with RWwnA and RWwnB to give a speed command.
RY (n + 3) A	Reset	Turn on RY (n + 3) A to reset alarms. However, some alarms cannot be cleared with RY (n + 3) A.

## RXn profile

Device No.	Device	Description
RXn0	Ready	When the servo-on is on and the servo amplifier is ready to operate, RXn0 turns on.
RXn1	In-position	When the number of droop pulses is in the preset in-position range, RXn1 turns on. The in-position range can be changed with [Pr. PA10]. When the in-position range is increased, RXn1 may be always on during low-speed rotation.
RXn2	Rough match	When a command remaining distance is lower than the rough match output range set with [Pr. PT12], RXn2 turns on. This is not outputted during base circuit shut-off.
RXn4	Limiting torque	RXn4 turns on when a generated torque reaches a value set with [Pr. PA11 Forward rotation torque limit] or [Pr. PA12 Reverse rotation torque limit].
RXn6	Electromagnetic brake interlock	When using the device, set operation delay time of the electromagnetic brake in [Pr. PC02]. When a servo-off status or alarm occurs, RXn6 turns off.
RXn8	Monitoring	Refer to RYn8 (Monitor output execution demand).
RXn9	Instruction code execution completion	Refer to RYn9 (Instruction code execution demand).
RXnA	Warning	When a warning occurs, RXnA turns on. When a warning is not occurring, turning on the power will turn off RXnA after 4 s to 5 s.
RXnB	Battery warning	RXnB turns on when [AL. 92 Battery cable disconnection warning] or [AL. 9F Battery warning] has occurred. When the battery warning is not occurring, turning on the power will turn off RXnB after 4 s to 5 s.
RXnC	Travel completion	When the number of droop pulses is within the in-position output range set with [Pr. PA10] and the command remaining distance is "0", RXnC turns on. In the servo-off status, when the number of droop pulses is within the in-position range of each next station position and the command remaining distance is "0", RXnC turns on as well.
RXnD	Dynamic brake interlock	RXnD turns off when the dynamic brake needs to operate.
RX (n + 1) 0	Home position return completion 2	1. When the incremental system is set When a home position return completes normally, RX (n + 1) 0 turns on. When a home position return starts or if [AL. 69 Command error] occurs, RX (n + 1) 0 turns off. In addition, while [Pr. PT01] is set for the incremental value command method in the positioning mode, RX (n + 1) 0 turns off if the following conditions are met: 1) In servo-off status (servo-off, EM1 or EM2 is turned off, an alarm has occurred, STO is turned off, or [AL. E9 Main circuit off warning] has occurred) 2) The stroke limit is turned off 3) During software limit detection  2. When the absolute position detection system is set When a home position return completes normally, RX (n + 1) 0 turns on. When a home position return starts or if [AL. 69 Command error] occurs, RX (n + 1) 0 turns off. In addition, ZP2 turns off if any of the following conditions are met: 1) [AL. 25 Absolute position erased] has occurred 2) [AL. E3 Absolute position counter warning] has occurred 3) [Pr. PA01], [Pr. PA06], [Pr. PA07], [Pr. PA14], [Pr. PT01 (_ x _)], [Pr. PT08], [Pr. PT28], or [Pr. PT47] has been modified When [Pr. PT01] is set for the incremental value command method in the positioning mode, the absolute position detection system cannot be configured. Review the parameter setting value.
RX (n + 2) 0	Position command execution completion	Refer to RY (n + 2) 0 (Position command execution demand).
RX (n + 2) 1	Speed command execution completion	Refer to RY (n + 2) 1 (Speed command execution demand).
RX (n + 3) A	Malfunction	When an alarm occurs, RX (n + 3) A will turn on. When an alarm is not occurring, turning on the power will turn off RX (n + 3) A after 4 s to 5 s.
RX (n + 3) B	Remote station communication ready	Turning on the power will turn on RX (n + 3) B. When an alarm occurs, RX (n + 3) B will turn off.



# Detailed explanation of the RWwn/RWrn profile

## RWwn profile

Device No.	Device	Description	Setting range
RWwn0	Monitor 1	Setting a monitor code to monitor in RWwn0 and turning on RYn8 store data in RWrn0 and RWrn1. At this time, RXn8 turns on. Refer to the following for monitor codes for status display. ☞ Page 33 Monitor code	☞ Page 33 Monitor code
RWwn2	Monitor 2	Setting a monitor code to monitor in RWwn2 and turning on RYn8 store data in RWrn2 and RWrn3. At this time, RXn8 turns on. Refer to the following for monitor codes for status display. ☞ Page 33 Monitor code	☞ Page 33 Monitor code
RWwn4	Instruction code - Lower 16 bits	Set an instruction code No. used to read or write a parameter or point table data or to refer to an alarm. Setting an instruction code No. in RWwn4 and turning on RYn9 execute the instruction. RXn9 turns on after the instruction execution is completed. Refer to the following for the instruction code No. ☞ Page 35 Instruction code	☞ Page 35 Instruction code
RWwn5	Instruction code - Upper 16 bits	When a value other than "0000h" is set in this device, the instruction code is not executed even if RYn9 is turned on and "_ _ 1 _" is set in respond code.	0000h
RWwn6	Next station No. selection	Set a target next station No. Even if a value out of the setting range is set, an alarm or warning does not occur. However, the set value is invalid and the previous setting value is used.	0 to 254
RWwn7	Speed selection	To execute the positioning operation, select a point table No. that stores speed command data.	Point table No.: 1 to 255
RWwn8	Next station No.	This function can be used while RY (n + 2) A (Position/speed specifying method selection) is on (the remote register-based position/speed specifying method is selected). Setting a target next station No. in RWwn8 and turning on RY (n + 2) 0 set the next station No. in the servo amplifier. After the setting is completed, RX (n + 2) 0 turns on. Refer to the following for details. ☞ Page 193 Remote register-based position/speed setting	0 to 254
RWwnA	Point table No./Speed command data - Lower 16 bits	This function can be used while RY (n + 2) A (Position/speed specifying method selection) is on (the remote register-based position/speed specifying method is selected).	Point table No.: 1 to 255
RWwnB	Speed command data - Upper 16 bits	• When using speed data of point tables Set [Pr. PT62] to "_ _ 0 _". Setting a point table No. in RWwnA and turning on RY (n + 2) 1 set the point table No. in the servo amplifier. After the setting is completed, RX (n + 2) 1 turns on. • When setting a servo motor speed directly Set [Pr. PT62] to "_ _ 1 _". Setting the lower 16 bits of the speed command data in RWwnA and the upper 16 bits of the speed command data in RWwnB and turning on RY (n + 2) 1 enable the settings. After the setting is completed, RX (n + 2) 1 turns on. The unit is [0.01 r/min]. Use [Pr. PT62] to select whether to set a point table No. or speed command data. Refer to the following for details of the point table No. or speed command data. ☞ Page 193 Remote register-based position/speed setting When setting a servo motor speed in this remote register, always set an acceleration time constant and deceleration time constant in point table No. 1.	Speed command data: 0 to permissible speed
RWwnC	Writing data - Lower 16 bits	Set writing data used to write a parameter or point table data or to clear the alarm history.	☞ Page 40 Writing instruction code
RWwnD	Writing data - Upper 16 bits	Setting writing data in RWwnC and RWwnD and turning on RYn9 write the data to the servo amplifier. When the writing is completed, RXn9 turns on. Refer to the following for writing data. ☞ Page 40 Writing instruction code	

## RWrn profile

Device No.	Device	Description	Setting range
RWrn0	Monitor 1 data - Lower 16 bits	The lower 16 bits of the data corresponding to the monitor code set in RWwn0 are stored.	—
RWrn1	Monitor 1 data - Upper 16 bits	The upper 16 bits of the data corresponding to the monitor code set in RWwn0 are stored. A sign is set if no data is set in the upper 16 bits.	—
RWrn2	Monitor 2 data - Lower 16 bits	The lower 16 bits of the data corresponding to the monitor code set in RWwn2 are stored.	—
RWrn3	Monitor 2 data - Upper 16 bits	The upper 16 bits of the data corresponding to the monitor code set in RWwn2 are stored. A sign is set if no data is set in the upper 16 bits.	—
RWrn4	Respond code	When the codes set in RWwn0 to RWwnD have been executed normally, "0000" is set.	—
RWrn6	Station No. output	The station No. is set when RXnC turns on. In the following conditions, "0" is set in RWrn6. <ul style="list-style-type: none"> <li>• The home position return is not completed.</li> <li>• The home position return is completed.</li> </ul> In the following conditions, RWrn6 holds the value used in the previous operation. <ul style="list-style-type: none"> <li>• The operation mode is changed.</li> <li>• During manual operation</li> </ul>	—
RWrnC	Reading data - Lower 16 bits	Data corresponding to the reading code set in RWwn4 is set.	—
RWrnD	Reading data - Upper 16 bits		—
RWwnF	Analog override	Set the override value. Set the override value in % unit in the range of 0 to 200 %.	0 to 200

# Code

## Monitor code

Use any of the instruction codes 0100h to 011Fh to read the decimal point position (multiplying factor) of the status display. Setting any code No. that is not given in this section will set an error code ( \_ \_ \_ 1) in respond code (RWrn4). At this time, "0000" is set in RWrn0 to RWrn3.

Code No.	Monitored item	Response data content (Servo amplifier → Master station)	
		Data length	Unit
0000h	—	—	—
0001h	—	—	—
0002h	—	—	—
0003h	—	—	—
0004h	—	—	—
0005h	—	—	—
0006h	—	—	—
0007h	Override level *1	16 bits	[%]
0008h	Station No.	16 bits	—
0009h	—	—	—
000Ah	Cumulative feedback pulses	32 bits	[pulse]
000Bh	—	—	—
000Ch	—	—	—
000Dh	—	—	—
000Eh	Droop pulses	32 bits	[pulse]
000Fh	—	—	—
0010h	—	—	—
0011h	Regenerative load ratio	16 bits	[%]
0012h	Effective load ratio	16 bits	[%]
0013h	Peak load ratio	16 bits	[%]
0014h	Instantaneous torque	16 bits	[%]
0015h	ABS counter	16 bits	[rev]
0016h	Servo motor speed	32 bits	0.01 [r/min]/0.01 [mm/s]
0017h	—	—	—
0018h	Bus voltage	16 bits	[V]
0019h	—	—	—
001Ah	—	—	—
001Bh	—	—	—
001Ch	Position within one-revolution	32 bits	[pulse]
001Dh	—	—	—
001Eh	—	—	—
001Fh	—	—	—

\*1 This is available with servo amplifiers with software version A6 or later.

## Instruction code

Refer to the following for the timing charts of the instruction codes.

☞ Page 45 Instruction code

### ■Reading instruction code

The data requested to be read with the instruction codes 0000h to 0AFFh is stored in reading data (RWrnC and RWrnD).

Set the instruction code No. corresponding to the item in RWwn4 and RWwn5. The instruction code No. and response data are all hexadecimal.

Setting any instruction code No. that is not given in this section will store an error code ( \_ \_ 1 \_ ) in respond code (RWrn4). If any unusable parameter or point table is read, an error code ( \_ \_ 2 \_ ) is stored. At this time, "0000" is stored in reading data (RWrnC and RWrnD).

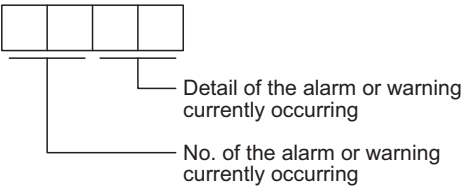
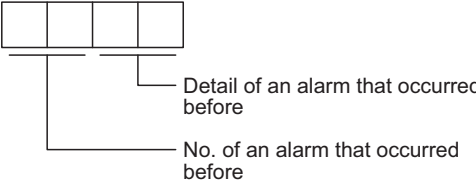
Code No.		Item/function	Reading data content (Servo amplifier → Master station)	
RWwn5	RWwn4		RWrnC	RWrnD
0000h	0000h	Operation mode Reads the current operation mode.	0000: CC-Link IE operation mode 0001: Test operation mode	Always 0
0000h	0002h	Travel distance multiplying factor Reads the multiplying factor of the position data in the point table set with [Pr. PT03].	0000: × 1 0100: × 10 0200: × 100 0300: × 1000	Always 0
0000h	0010h	Current alarm (warning) reading Reads the alarm No. or warning No. that is currently occurring.		Always 0
0000h	0020h	Alarm number in alarm history (latest alarm)		Always 0
0000h	0021h	Alarm number in alarm history (one alarm ago)		
0000h	0022h	Alarm number in alarm history (two alarms ago)		
0000h	0023h	Alarm number in alarm history (three alarms ago)		
0000h	0024h	Alarm number in alarm history (four alarms ago)		
0000h	0025h	Alarm number in alarm history (five alarms ago)		
0000h	0026h	Alarm number in alarm history (six alarms ago)		
0000h	0027h	Alarm number in alarm history (seven alarms ago)		
0000h	0028h	Alarm number in alarm history (eight alarms ago)		
0000h	0029h	Alarm number in alarm history (nine alarms ago)		
0000h	002Ah	Alarm number in alarm history (ten alarms ago)		
0000h	002Bh	Alarm number in alarm history (eleven alarms ago)		
0000h	002Ch	Alarm number in alarm history (twelve alarms ago)		
0000h	002Dh	Alarm number in alarm history (thirteen alarms ago)		
0000h	002Eh	Alarm number in alarm history (fourteen alarms ago)		
0000h	002Fh	Alarm number in alarm history (fifteen alarms ago)		

Code No.		Item/function	Reading data content (Servo amplifier → Master station)	
RWwn5	RWwn4		RWrnC	RWrnD
0000h	0030h	Alarm occurrence time in alarm history (latest alarm)	Returns the occurrence time of the alarm that occurred before.	Always 0
0000h	0031h	Alarm occurrence time in alarm history (one alarm ago)		
0000h	0032h	Alarm occurrence time in alarm history (two alarms ago)		
0000h	0033h	Alarm occurrence time in alarm history (three alarms ago)		
0000h	0034h	Alarm occurrence time in alarm history (four alarms ago)		
0000h	0035h	Alarm occurrence time in alarm history (five alarms ago)		
0000h	0036h	Alarm occurrence time in alarm history (six alarms ago)		
0000h	0037h	Alarm occurrence time in alarm history (seven alarms ago)		
0000h	0038h	Alarm occurrence time in alarm history (eight alarms ago)		
0000h	0039h	Alarm occurrence time in alarm history (nine alarms ago)		
0000h	003Ah	Alarm occurrence time in alarm history (ten alarms ago)		
0000h	003Bh	Alarm occurrence time in alarm history (eleven alarms ago)		
0000h	003Ch	Alarm occurrence time in alarm history (twelve alarms ago)		
0000h	003Dh	Alarm occurrence time in alarm history (thirteen alarms ago)		
0000h	003Eh	Alarm occurrence time in alarm history (fourteen alarms ago)		
0000h	003Fh	Alarm occurrence time in alarm history (fifteen alarms ago)		
0000h	0040h	Input device status 0 Reads the status (OFF/ON) of input devices.	Bit 0 to bit F indicate the OFF/ON status of the corresponding input devices. 0: Servo-on 1: Start 2: Rotation direction specifying 3: Proximity dog 4 to 5: For manufacturer setting 6: Operation mode selection 1 7: Operation mode selection 2 8: Monitor output execution demand 9: Instruction code execution demand A to E: For manufacturer setting F: Clear	Always 0
0000h	0041h	Input device status 1 Reads the status (OFF/ON) of input devices.	Bit 0 to bit F indicate the OFF/ON status of the corresponding input devices. 0: Upper stroke limit *1 1: Lower stroke limit *1 2: Operation alarm reset 3 to F: For manufacturer setting	Always 0
0000h	0042h	Input device status 2 Reads the status (OFF/ON) of input devices.	Bit 0 to bit F indicate the OFF/ON status of the corresponding input devices. 0: Position command execution demand 1: Speed command execution demand 2 to 5: For manufacturer setting 6: Internal torque limit selection 7: Proportional control (PID control) 8: Gain switching 9: For manufacturer setting A: Position/speed specifying method selection B to F: For manufacturer setting	Always 0

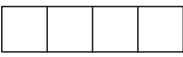
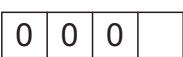
Code No.		Item/function	Reading data content (Servo amplifier → Master station)	
RWwn5	RWwn4		RWrnC	RWrnD
0000h	0043h	Input device status 3 Reads the status (OFF/ON) of input devices.	Bit 0 to bit F indicate the OFF/ON status of the corresponding input devices. 0 to 9 For manufacturer setting A: Reset B to F: For manufacturer setting	Always 0
0000h	0081h	Energization time Reads the energization time since shipment.	Returns the energization time [h].	Always 0
0000h	0082h	Power on frequency Reads the number of power-on times since shipment.	Returns the number of power-on times.	Always 0
0000h	00A0h	Load to motor inertia ratio Reads the estimated load to motor inertia ratio on the servo motor shaft.	Return unit [0.01 times] The load to motor inertia ratio is returned.	Always 0
0000h	00B0h	Home position within one-revolution (CYC0) Reads the cycle counter value of an absolute home position.	Return unit [pulse] Stores the lower 16 bits of the cycle counter value of the absolute home position (32-bit data).	Stores the upper 16 bits of the cycle counter value of the absolute home position.
0000h	00B2h	Home position multi-revolution data (ABS0) Reads the multi-revolution counter value of an absolute home position.	Return unit [rev] Returns the multi-revolution counter value.	Always 0
0000h	00C0h	Error parameter No./Point data No. reading Reads the parameter No. and point table No. that have an error.	 <p>Parameter No. or point table No.</p> <p>Parameter group  0: [Pr. PA__]  1: [Pr. PB__]  2: [Pr. PC__]  3: [Pr. PD__]  4: [Pr. PE__]  5: [Pr. PF__]  6 to A: For manufacturer setting  B: [Pr. PL__]  C: [Pr. PT__]  E: [Pr. PN__]</p> <p>Type  1: Parameter  2: Point table</p>	Always 0
0000h	0100h to 011Fh	Monitor multiplying factor Reads the multiplying factor of data to be read with a monitor code. The instruction codes 0100h to 011Fh correspond to each of the monitor codes 0000h to 001Fh. To the instruction code that has no corresponding monitor code, "0000h" is applied.	0000: × 1 0001: × 10 0002: × 100 0003: × 1000	Always 0
0000h	0200h	Parameter group reading Reads the parameter group written with the code No. 8200h.	 <p>Parameter group  0: [Pr. PA__]  1: [Pr. PB__]  2: [Pr. PC__]  3: [Pr. PD__]  4: [Pr. PE__]  5: [Pr. PF__]  6 to A: For manufacturer setting  B: [Pr. PL__]  C: [Pr. PT__]  E: [Pr. PN__]</p>	Always 0

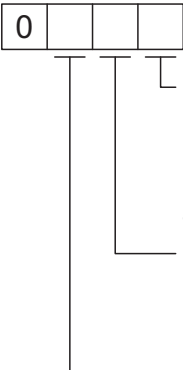
Code No.		Item/function	Reading data content (Servo amplifier → Master station)	
RWwn5	RWwn4		RWrnC	RWrnD
0000h	0201h to 02FFh	Parameter data reading Reads the setting values of the parameters in the group read with the code No. 0200h. The lower two digits of the code No. which are converted to decimal correspond to the parameter No.	Stores the lower 16 bits of the setting value of the requested parameter No.	Stores the upper 16 bits of the setting value of the requested parameter No.
0000h	0301h to 03FFh	Data form of parameter Reads the data form of the parameter numbers in the group read with the code No. 0200h. The lower two digits of the code No. which are converted to decimal correspond to the parameter No.	Stores the data form of the requested parameter No.   <ul style="list-style-type: none"> <li>Decimal point position           <ul style="list-style-type: none"> <li>0: No decimal point</li> <li>1: First least significant digit (no decimal point)</li> <li>2: Second least significant digit</li> <li>3: Third least significant digit</li> <li>4: Forth least significant digit</li> </ul> </li> <li>Data form           <ul style="list-style-type: none"> <li>0: Data is used unchanged in hexadecimal.</li> <li>1: Data must be converted into decimal.</li> </ul> </li> <li>Parameter writing type           <ul style="list-style-type: none"> <li>0: Enabled after writing</li> <li>1: Enabled when power is cycled after writing</li> <li>2: Enabled when the controller is reset</li> </ul> </li> </ul>	Always 0
0000h	0601h to 06FFh	Servo motor speed of point table No. 1 to 255 The lower two digits of the code No. which are converted to decimal correspond to the point table No.	Stores the lower 16 bits of the servo motor speed of the requested point table No.	Stores the upper 16 bits of the servo motor speed of the requested point table No.
0000h	0701h to 07FFh	Acceleration time constant of point table No. 1 to 255 The lower two digits of the code No. which are converted to decimal correspond to the point table No.	Stores the acceleration time constant of the requested point table No.	Always 0
0000h	0801h to 08FFh	Deceleration time constant of point table No. 1 to 255 The lower two digits of the code No. which are converted to decimal correspond to the point table No.	Stores the deceleration time constant of the requested point table No.	Always 0

\*1 The setting of [Pr. PD41 Sensor input type selection] enables switching between indicating the state of input (LSP/LSN) from the servo amplifier and the state of input (RY (n + 1) 0/RY (n + 1) 1) from the controller. When [Pr. PD41] is the initial value, the state of input to the servo amplifier is indicated. When it is set to input to the servo amplifier, bit 0 and bit 1 of setting value [Pr. PA14 Rotation direction selection/travel direction selection] are interchanged.

## ■Writing instruction code

Data requested to be written with the instruction codes 8000h to 91FFh is written to the servo amplifier.

Set the instruction code No. corresponding to the item in instruction code (RWwn4 and RWwn5) and the data to be written in writing data (RWwnC and RWwnD). The instruction code No. and response data are all hexadecimal.

Setting any instruction code No. that is not given in this section will store an error code ( \_ \_ 1 \_ ) in respond code (RWrn4).

Code No.		Item	Writing data content (Master station → Servo amplifier)	
RWwn5	RWwn4		RWwnC	RWwnD
0000h	8010h	Alarm reset command Clears the alarm that is currently occurring.	1EA5h	Set to "0000h".
0000h	8101h	Feedback pulse value display data clear command Resets the display data of the status display "Cumulative feedback pulses" to "0".	1EA5h	Set to "0000h".
0000h	8200h	Writing command of parameter group Writes the group of the parameter to write with code No. 8201h to 82FFh and 8301h to 83FFh. Writes the group of the parameter to read with code No. 0201h to 02FFh and 0301h to 03FFh.	<div style="border: 1px solid black; display: inline-block; padding: 2px;">0 0 0</div> Parameter group 0: [Pr. PA _ _ ] 1: [Pr. PB _ _ ] 2: [Pr. PC _ _ ] 3: [Pr. PD _ _ ] 4: [Pr. PE _ _ ] 5: [Pr. PF _ _ ] 6 to A: For manufacturer setting B: [Pr. PL _ _ ] C: [Pr. PT _ _ ] E: [Pr. PN _ _ ]	Set to "0000h".
0000h	8201h to 82FFh	Data RAM command of parameter Writes the setting values of the parameters in the group written with code No. 8200h to the RAM. This setting value is cleared when the power supply is shut off. The lower two digits of the code No. which are converted to decimal correspond to the parameter No. An error code is returned if a value outside the range of a parameter is written.	Set the lower 16 bits of the parameter setting value.	Set the upper 16 bits of the parameter setting value. Set the 16-bit parameter to "0000h" if it has a positive sign. Set it to "FFFFh" if it has a negative sign. Set the 16-bit parameter to "0000h" if it has no sign.
0000h	8301h to 83FFh	Data EEPROM command of parameter Writes the setting values of the parameters in the group written with code No. 8200h to the EEPROM. The setting value written in the EEPROM is held even when the power supply is shut off. The lower two digits of the code No. which are converted to decimal correspond to the parameter No. An error code is returned if a value outside the range of a parameter is written.	Set the lower 16 bits of the parameter setting value.	Set the upper 16 bits of the parameter setting value. Set the 16-bit parameter to "0000h" if it has a positive sign. Set it to "FFFFh" if it has a negative sign. Set the 16-bit parameter to "0000h" if it has no sign.
0000h	8601h to 86FFh	Servo motor speed data RAM command of point table Writes the servo motor speed of point table No. 1 to 255 to the RAM. This setting value is cleared when the power supply is shut off. The lower two digits of the code No. which are converted to decimal correspond to the point table No.	Set the lower 16 bits of the servo motor speed.	Set the upper 16 bits of the servo motor speed.



Code No.		Item	Writing data content (Master station → Servo amplifier)	
RWwn5	RWwn4		RWwnC	RWwnD
0000h	8701h to 87FFh	Acceleration time constant data RAM command of point table Writes the acceleration time constant of point table No. 1 to 255 to the RAM. This setting value is cleared when the power supply is shut off. The lower two digits of the code No. which are converted to decimal correspond to the point table No.	Set the acceleration time constant.	Set to "0000h".
0000h	8801h to 88FFh	Deceleration time constant data RAM command of point table Writes the deceleration time constant of point table No. 1 to 255 to the RAM. This setting value is cleared when the power supply is shut off. The lower two digits of the code No. which are converted to decimal correspond to the point table No.	Set the deceleration time constant.	Set to "0000h".
0000h	8D01h to 8DFFh	Servo motor speed data EEP-ROM command of point table Writes the servo motor speed of point table No. 1 to 255 to the EEP-ROM. The setting value written in the EEP-ROM is held even when the power supply is shut off. The lower two digits of the code No. which are converted to decimal correspond to the point table No.	Set the lower 16 bits of the servo motor speed.	Set the upper 16 bits of the servo motor speed.
0000h	8E01h to 8EFFh	Acceleration time constant data EEP-ROM command of point table Writes the acceleration time constant of point table No. 1 to 255 to the EEP-ROM. The setting value written in the EEP-ROM is held even when the power supply is shut off. The lower two digits of the code No. which are converted to decimal correspond to the point table No.	Set the acceleration time constant.	Set to "0000h".
0000h	8F01h to 8FFFh	Deceleration time constant data EEP-ROM command of point table Writes the deceleration time constants of point table No. 1 to 255 to the EEP-ROM. The setting value written in the EEP-ROM is held even when the power supply is shut off. The lower two digits of the code No. which are converted to decimal correspond to the point table No.	Set the deceleration time constant.	Set to "0000h".

## Respond code (RWrn4)

If any of monitor codes, instruction codes, point table No. selection, point table No./position command data, and point table No./speed command data set in remote registers is outside the setting range, the corresponding error code is set in respond code (RWrn4). If the setting is within the setting range, "0000" is set.

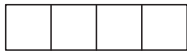

Error of the monitor code

Code No.	Error detail	Details
0	Normal result	The code has been completed normally.
1	Code error	An incorrect code No. is specified.
2		
3		

Error of the reading instruction code and writing instruction code

Code No.	Error detail	Details
0	Normal result	The instruction has been completed normally.
1	Code error	An incorrect code No. is specified.
2	Parameter selection error	A parameter No. that cannot be referred to is specified.
3	Writing data out of range	A value out of the range is set.

Error of the point table No./position command data/next station

Code No.	Error detail	Details
0	Normal result	The instruction has been completed normally.
1		
2		
3	Writing data out of range	A value out of the range is set.

Error of the point table No./speed command data

Code No.	Error detail	Details
0	Normal result	The instruction has been completed normally.
1		
2		
3	Writing data out of range	A value out of the range is set.

## Data communication timing chart

Data communication timing charts for the indexer operation are the same as those for the point table operation. Refer to the following.

☞ Page 44 Data communication timing chart

# Remote register-based position/speed setting

The functions in this section can be used while RY (n + 2) A (Position/speed specifying method selection) is on (the remote register-based position/speed specifying method is selected).

Turn off RY (n + 2) A to perform home position return.

The position command and speed command necessary for positioning can be selected with [Pr. PT62] as follows.

□ □ □ □	Setting value	Position command	Speed command
	0	Specify a next station No. in RWwn8.	Specify a point table No. in RWwnA.
	1		Set the servo motor speed in RWwnA and RWwnB.

## For the next station No. setting and point table No. (speed command) setting

Specify position command data with a next station No., and specify speed command data with a point table No. Then, execute positioning using the servo motor speed, acceleration time constant, and deceleration time constant.

Before executing positioning, set [Pr. PT62] to " \_\_ 0 \_ " to enable the operation that follows the settings of the next station No. and point table No. (speed command).

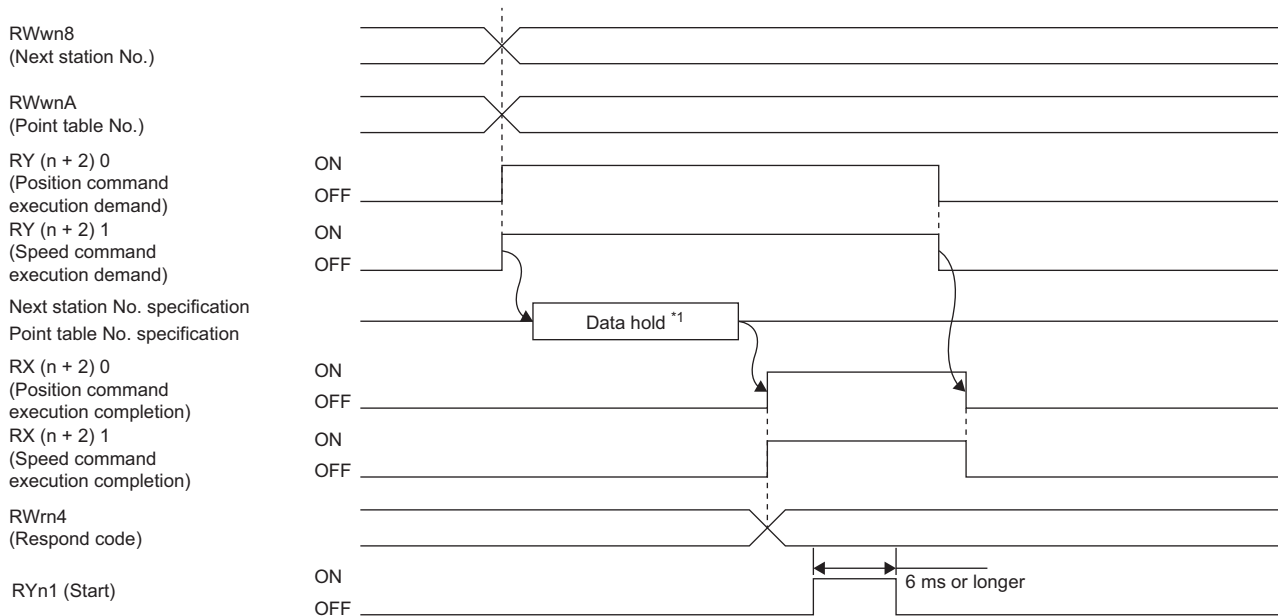

\*1 This data is stored in the RAM of the servo amplifier. Thus, the data is cleared when the power supply is shut off.

Set the next station No. to RWwn8 (Next station No.) and set the point table No. for the speed command to RWwnA (Point table No.), then turn on RY (n + 2) 0 (Position command execution demand) and RY (n + 2) 1 (Speed command execution demand).

Turning on RY (n + 2) 0 and RY (n + 2) 1 stores the next station No. and point table No. into the RAM of the servo amplifier. Once the data is stored, RX (n + 2) 0 (Position command execution completion) and RX (n + 2) 1 (Speed command execution completion) turn on.

Do not change the setting of the next station No. and the specified point table No. until RX (n + 2) 0 and RX (n + 2) 1 turn on after RY (n + 2) 0 and RY (n + 2) 1 turn on.

If data outside the setting range is set in RWwn8 (Next station No.) and RWwnA (Point table No.), an error code is set in respond code.

Turn on RYn1 (Forward rotation start) after RX (n + 2) 0 (Position command execution completion) and RX (n + 2) 1 (Speed command execution completion) have turned on.

## For the next station No. setting and speed command data setting

Specify a next station No. and servo motor speed with remote registers, then execute positioning. At this time, the acceleration time constant and deceleration time constant set in point table No. 1 are used.

Before executing positioning, set [Pr. PT62] to " \_\_ 1 \_ " to enable the operation that follows the settings of the next station No. and speed command data.

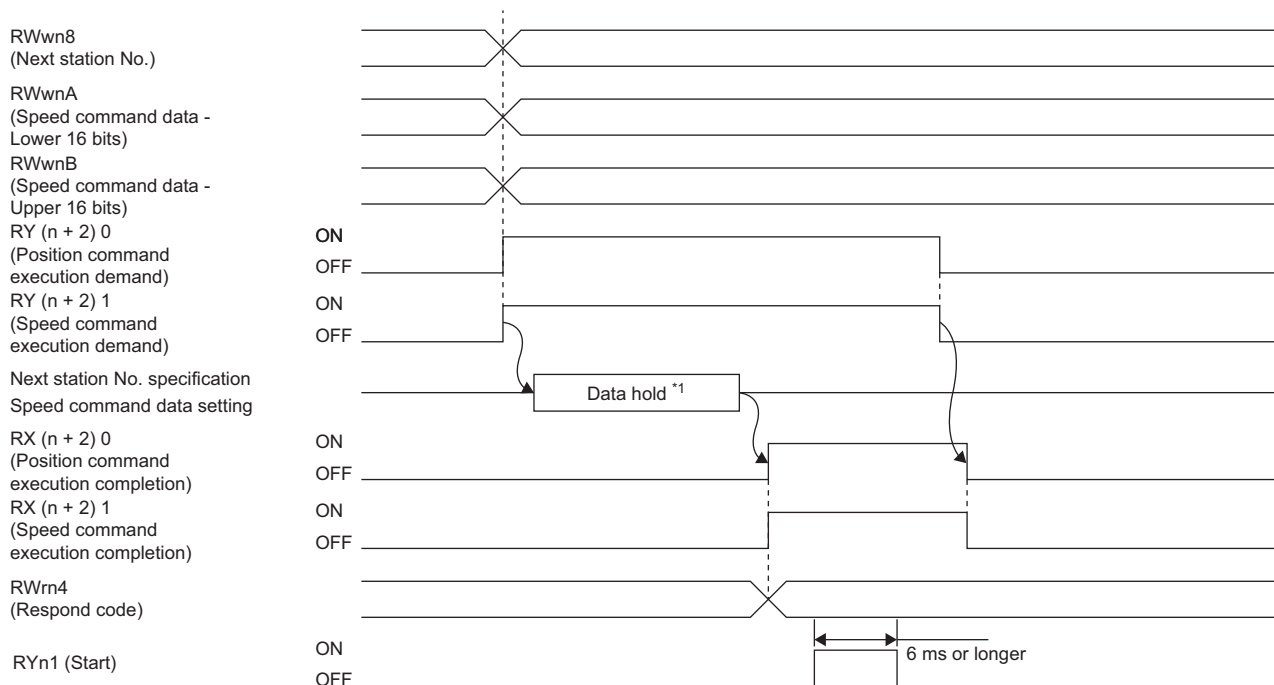

\*1 This data is stored in the RAM of the servo amplifier. Thus, the data is cleared when the power supply is shut off.

Set the next station No. to RWwn8 (Next station No.), the lower 16 bits of the speed command data to RWwnA (Speed command data lower 16 bits), and the upper 16 bits of the speed command data to RWwnB (Speed command data upper 16 bits). Then, turn on RY(n+2)0 (Position command execution demand) and RY(n+2)1 (Speed command execution demand).

Turning on RY(n+2)0 and RY(n+2)1 stores the next station No. and speed command data into the RAM of the servo amplifier.

Once the data is stored, RX(n+2)0 (Position command execution completion) and RX(n+2)1 (Speed command execution completion) turn on.

Do not change the settings of the next station No. and the speed command data until RX(n+2)0 and RX(n+2)1 turn on after RY(n+2)0 and RY(n+2)1 turn on.

If data outside the setting range is set in RWwn8, RWwnA, and RWwnB, an error code is set in respond code.

Turn on RYn1 (Forward rotation start) after RX(n+2)0 (Position command execution completion) and RX(n+2)1 (Speed command execution completion) have turned on.

## 5.2 Switching power on for the first time

### Point

To use the servo amplifier in the I/O mode, set [Pr. PN03] to "\_\_\_1". In addition, the GX Works setting is required. For the GX Works setting, refer to section 4.1 of "MR-J4-\_GF\_(-RJ) Servo Amplifier Instruction Manual (Motion Mode)".

When switching the power on for the first time, follow this section to make a startup.

### Startup procedure

#### 1. Wiring check

Check whether the servo amplifier and servo motor are wired correctly by visual inspection, the DO forced output function (section 4.5 of "MR-J4-\_GF\_(-RJ) Servo Amplifier Instruction Manual (Motion Mode)"), etc. (Refer to section 4.1 of "MR-J4-\_GF\_(-RJ) Servo Amplifier Instruction Manual (Motion Mode)".)

#### 2. Surrounding environment check

Check the surrounding environment of the servo amplifier and servo motor. (Refer to section 4.1 of "MR-J4-\_GF\_(-RJ) Servo Amplifier Instruction Manual (Motion Mode)".)

#### 3. Station No. setting

Set the station number with the station number setting rotary switch (SW2/SW3). (Refer to section 4.3 of "MR-J4-\_GF\_(-RJ) Servo Amplifier Instruction Manual (Motion Mode)".)

#### 4. Parameter setting

Set the parameters as necessary, such as the used operation mode and regenerative option selection. (Page 125 PARAMETERS)

Perform setting of [Pr. PN02 Communication error detection time] in accordance with the network topology and the link scan time of the master station.

Set [Pr. PD41] to "0\_\_" (Stroke limit always enabled).

To input a stroke limit by using the link device, set [Pr. PD41] to "1\_\_" (input from controller).

Hereafter, instructions are provided in a case where the input from the controller is selected. When [Pr. PD41] is set to "0\_\_" (input from servo amplifier), read the words "upper stroke limit" and "lower stroke limit" as "LSP" and "LSN", respectively.

#### 5. Test operation of the servo motor alone in JOG operation of test operation mode

With the servo motor disconnected from the machine, perform test operation mode at the slowest speed to check whether the servo motor rotates correctly. For the test operation mode, refer to section 4.5 of "MR-J4-\_GF\_(-RJ) Servo Amplifier Instruction Manual (Motion Mode)".

#### 6. Test operation of the servo motor alone in manual operation mode

Make sure that the servo motor rotates in the following procedure.

① Switch on EM2 (Forced stop 2) and RYn0 (Servo-on). When the servo amplifier is in a servo-on status, RXn0 (Ready) switches on.

② Switch on RY (n + 1) 0 (Upper stroke limit) and RY (n + 1) 1 (Lower stroke limit).

③ When RYn6 (Operation mode selection 1) is switched on, and RYn7 (Operation mode selection 2) is switched off from the controller, switching on RYn1 (Start) in the manual operation mode (JOG operation) rotates the servo motor. (Page 219 JOG operation)

Set a low speed in [Pr. PT65 Jog speed command] first, make the servo motor operate, and check the rotation direction of the motor, etc. If the servo motor does not operate in the intended direction, check the input signal.

## **7.** Test operation with the servo motor and machine connected

Make sure that the servo motor rotates in the following procedure.

**①** Switch on EM2 (Forced stop 2) and RYn0 (Servo-on). When the servo amplifier is in a servo-on status, RXn0 (Ready) switches on.

**②** Switch on RY (n + 1) 0 (Upper stroke limit) and RY (n + 1) 1 (Lower stroke limit).

**③** When RYn6 (Operation mode selection 1) is switched on, and RYn7 (Operation mode selection 2) is switched off from the controller, switching on RYn1 (Start) in the manual operation mode (JOG operation) rotates the servo motor. (☞ Page 219 JOG operation)

Set a low speed in [Pr. PT65 Jog speed command] first, make the servo motor operate, and check the operation direction of the machine, etc. If the servo motor does not operate in the intended direction, check the input signal. In the status display, check for any problems of the servo motor speed, load ratio, etc.

## **8.** Automatic operation by indexer

Check automatic operation from the controller.

## **9.** Gain adjustment

Make gain adjustment to optimize the machine motions. (Refer to chapter 6 of "MR-J4- \_GF\_ (-RJ) Servo Amplifier Instruction Manual (Motion Mode)".)

## **10.** Actual operation

## **11.** Stop

Stop giving commands and stop operation.

## 5.3 Automatic operation mode

### Point

There are the following restrictions on [Pr. PA06 Number of gear teeth on machine side] and the servo motor speed (N) in the absolute position detection system.

- When [Pr. PA06]  $\leq 2000$ ,  $N < 3076.7$  r/min
- When [Pr. PA06]  $> 2000$ ,  $N < 3276.7 - \text{CMX}$  r/min

When the servo motor is operated continuously at a servo motor speed higher than the limit value, [AL. E3 Absolute position counter warning] will occur.

When the same next station No. is specified as station No. of the current position and a positioning operation is executed, the motor does not start because the travel distance is judged as "0".

## Automatic operation mode

5

### Logic of indexer

A circumference of the load side (360 degrees) is divided into up to 255 stations. The positioning is executed by selecting a station with RWwn6 (Next station No. selection) or RWwn8 (Next station No.). The following diagram is an example for when [Pr. PA14] is set to "0".

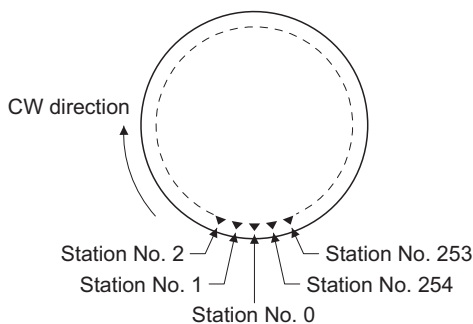

The station No. 0 is set as a home position. Set the number of stations with [Pr. PT28].

### Rotation direction

There are two operation methods: Rotation direction specifying indexer, which always rotates in a fixed direction and executes positioning to a station; Shortest rotating indexer, which automatically changes a rotation direction to the shortest distance and executes positioning to a station.

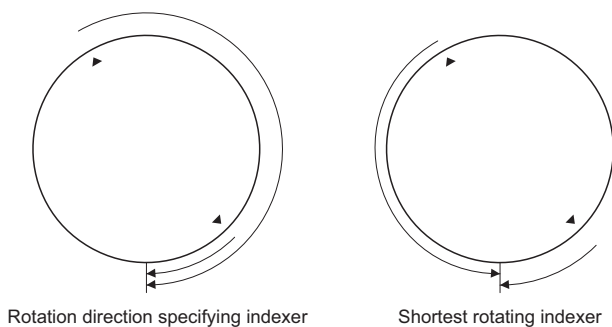

## Rotation direction specifying indexer

In this operation mode, the servo motor rotates in a fixed direction to execute positioning to a station.

### When not using the position/speed specifying method

The positioning is executed by selecting a station No. with RWwn6 (Next station No. selection). Use the value set in the point table as the servo motor speed, acceleration or deceleration time constant during operation.

#### ■Device/parameter

Set input devices and parameters as follows:

Item	Device/parameter to be used	Setting
Indexer method selection	Control mode selection of [Pr. PA01]	Select "___8" (positioning mode (indexer method)).
Position/speed specifying method	RY (n + 2) A (Position/speed specifying method selection)	Turn off RY (n + 2) A.
Next station position	RWwn6 (Next station No. selection)	Set any next station No.
Selection of rotation direction specifying indexer	RYn6 (Operation mode selection 1)	Turn off RYn6.
	RYn7 (Operation mode selection 2)	Turn on RYn7.
Rotation direction selection	RYn2 (Rotation direction specifying)	The rotation direction to a station No. will be as follows. Off: Station No. decreasing direction On: Station No. increasing direction
Servo motor speed	Point table	Set a servo motor speed.
Acceleration time constant/ deceleration time constant	Point table	Set an acceleration time constant and deceleration time constant.
Speed command data selection	RWwn7 (Speed selection)	Set a point table No. that stores speed command data.
Torque limit *1	[Pr. PA11] [Pr. PA12]	Set a torque limit value for during operation.
	[Pr. PC77]	Set a torque limit value for during stop.
	[Pr. PT39]	Set time to switch the torque limit value from during operation until during stop.

\*1 The torque limit will change from [Pr. PC77 Internal torque limit 2] to the setting value of [Pr. PA11 Forward rotation torque limit] or [Pr. PA12 Reverse rotation torque limit] when RYn1 (Start) is inputted. After RXnC (Travel completion) is turned on, the time set with [Pr. PT39] has passed, the torque limit will change from [Pr. PA11 Forward rotation torque limit] or [Pr. PA12 Reverse rotation torque limit] to the setting value of [Pr. PC77 Internal torque limit 2].

#### ■Point table

Set the point table values using MR Configurator2 or link devices.

Set the servo motor speed, acceleration time constant, and deceleration time constant in the point table.

When you set a value outside this range to the point table, the set value will be clamped with the maximum or minimum value.

When changing the command unit or the connected motor results in the set value outside the setting range, [AL. 37] will occur.

Item	Setting range	Unit	Description
Servo motor speed	0 to permissible speed	0.01 r/min	Set the command speed of the servo motor for execution of positioning. The setting value must be the permissible instantaneous speed or less of the servo motor used. The fractional portion will be rounded down.
Acceleration time constant	0 to 20000	ms	Set a time until the servo motor rotates at the rated speed.
Deceleration time constant	0 to 20000	ms	Set a time from when the servo motor rotates at the rated speed until when the motor stops.



## Other parameter settings

- Setting an assignment direction of station No.

Select an assignment direction of station No. with [Pr. PA14].

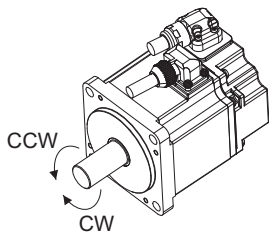

[Pr. PA14] setting	Servo motor rotation direction RYn1 (Start) is on
0 (initial value)	Next station No. will be assigned in CW direction in order of 1, 2, 3...
1	Next station No. will be assigned in CCW direction in order of 1, 2, 3...

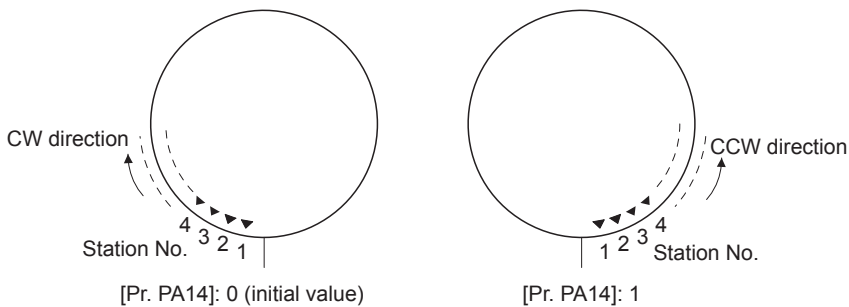

- Setting the number of stations

Set the number of stations with [Pr. PT28].

	[Pr. PT28] setting				
Number of stations	2	3	4	...	255
Station No.				...	

## Operation

When a station No. is selected with RWwn6, a point table in which speed command data is stored is selected with RWwn7, and RYn1 is switched on, positioning to the selected station will start at the set speed and acceleration/deceleration time constant.

## ■Timing chart

### Point

Always perform a home position return. Executing positioning operation without home position return will trigger [AL. 90 Home position return incomplete warning] and RYn1 (Start) will be disabled.

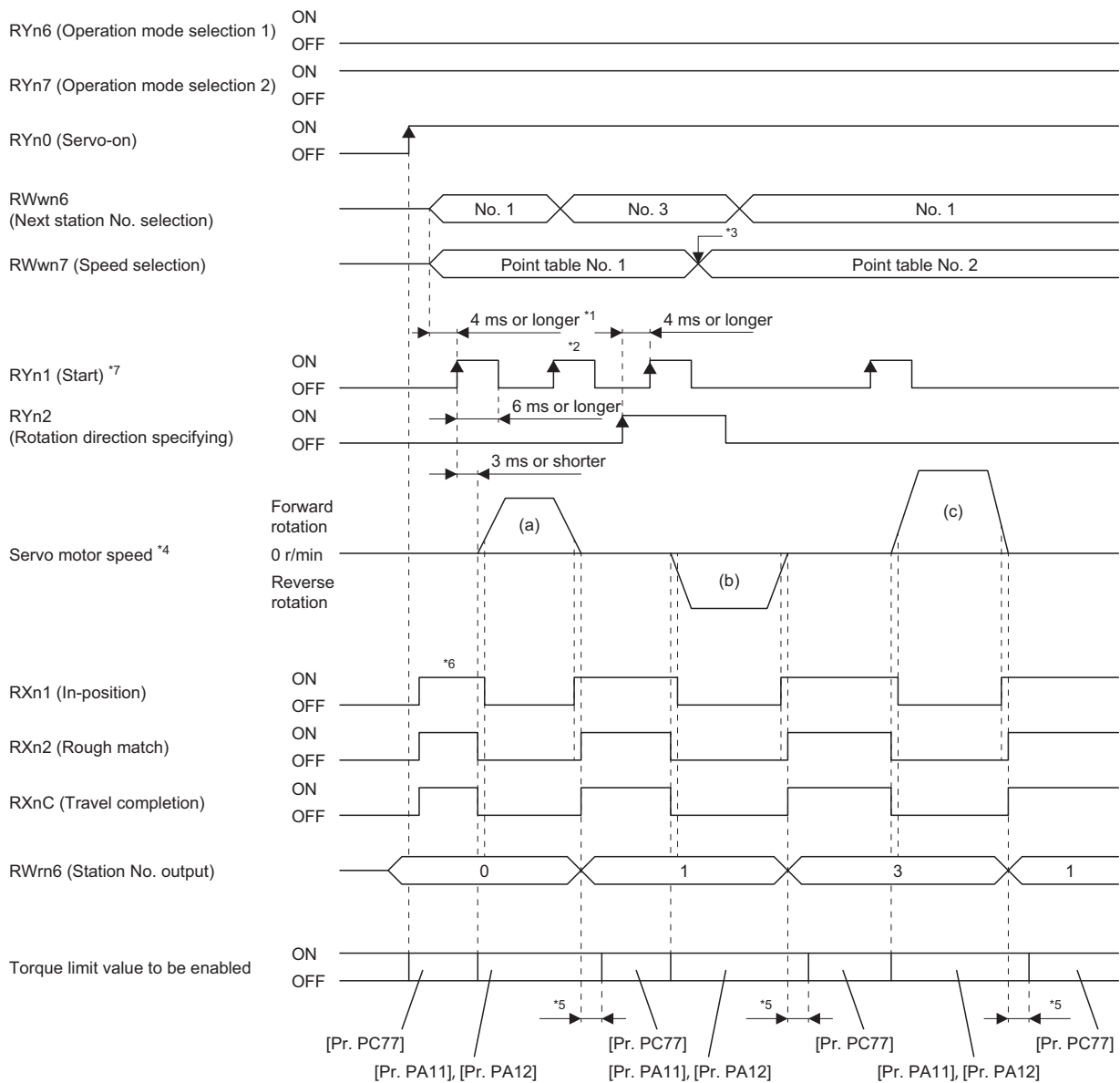

- \*1 Configure a sequence in which RWwn6 and RWwn7 is changed earlier taking into consideration the communication delay time.
- \*2 RYn1 is disabled even if it is turned on during operation. To perform the next operation, make sure that RXnC turns on, and then turn on RYn1.
- \*3 When RYn1 turns on, the servo motor speed and acceleration/deceleration time constants are switched with RWwn7. They are not switched with RWwn7 (Speed selection) while the servo motor is rotating.
- \*4 Operation is performed as follows.

Operation	(a)	(b)	(c)
Next station No.	No. 1	No. 3	No. 1
Servo motor speed Acceleration time constant Deceleration time constant	Point table No. 1	Point table No. 1	Point table No. 2
Positioning			

- \*5 [Pr. PT39] can be used to set the delay time from when RXnC turns on until when the torque limit value changes to the value of [Pr. PC77].
- \*6 After power-on, the device turns on if the number of droop pulses is within the in-position range of each station position.
- \*7 Configure a sequence as follows: After an operation mode is selected, RYn1 (Start) turns on upon the lapse of the switching hold time ("8 ms + communication delay time").

## When using the position/speed specifying method (with speed data of point tables)

The positioning is executed by selecting a station No. with RWwn8 (Next station No.). Use the value set in the point table as the servo motor speed, acceleration or deceleration time constant during operation.

### ■Device/parameter

Set input devices and parameters as follows:

Item	Device/parameter to be used	Setting
Indexer method selection	Control mode selection of [Pr. PA01]	___8: Select "___8" (positioning mode (indexer method)).
Position/speed specifying method	RY (n + 2) A (Position/speed specifying method selection)	Turn on RY (n + 2) A.
	[Pr. PT62]	Set [Pr. PT62] to "___0_".
Next station position	RWwn8 (Next station No.)	Set any next station No.
Selection of rotation direction specifying indexer	RYn6 (Operation mode selection 1)	Turn off RYn6.
	RYn7 (Operation mode selection 2)	Turn on RYn7.
Rotation direction selection	RYn2 (Rotation direction specifying)	The rotation direction to a station No. will be as follows. Off: Station No. decreasing direction On: Station No. increasing direction
Servo motor speed	Point table	Set a servo motor speed.
Acceleration time constant/ deceleration time constant	Point table	Set an acceleration time constant and deceleration time constant.
Speed command data selection	RWwnA (Point table No./speed command data - Lower 16 bits)	Set a point table No. that stores speed command data.
Torque limit *1	[Pr. PA11] [Pr. PA12]	Set a torque limit value for during operation.
	[Pr. PC77]	Set a torque limit value for during stop.
	[Pr. PT39]	Set time to switch the torque limit value from during operation until during stop.

\*1 The torque limit will change from [Pr. PC77 Internal torque limit 2] to the setting value of [Pr. PA11 Forward rotation torque limit] or [Pr. PA12 Reverse rotation torque limit] when RYn1 (Start) is inputted. After RXnC (Travel completion) is turned on, the time set with [Pr. PT39] has passed, the torque limit will change from [Pr. PA11 Forward rotation torque limit] or [Pr. PA12 Reverse rotation torque limit] to the setting value of [Pr. PC77 Internal torque limit 2].

### ■Point table

Refer to the following.

☞ Page 198 Point table

### ■Other parameter settings

Refer to the following.

☞ Page 199 Other parameter settings

### ■Operation

Selecting a station No. with RWwn8 and a point table in which speed command data is stored with RWwnA and switching on RYn1 start positioning to the selected station at the set speed, acceleration time constant and deceleration time constant.

## Timing chart



Always perform a home position return. Executing positioning operation without home position return will trigger [AL. 90 Home position return incomplete warning] and RYn1 (Start) will be disabled.

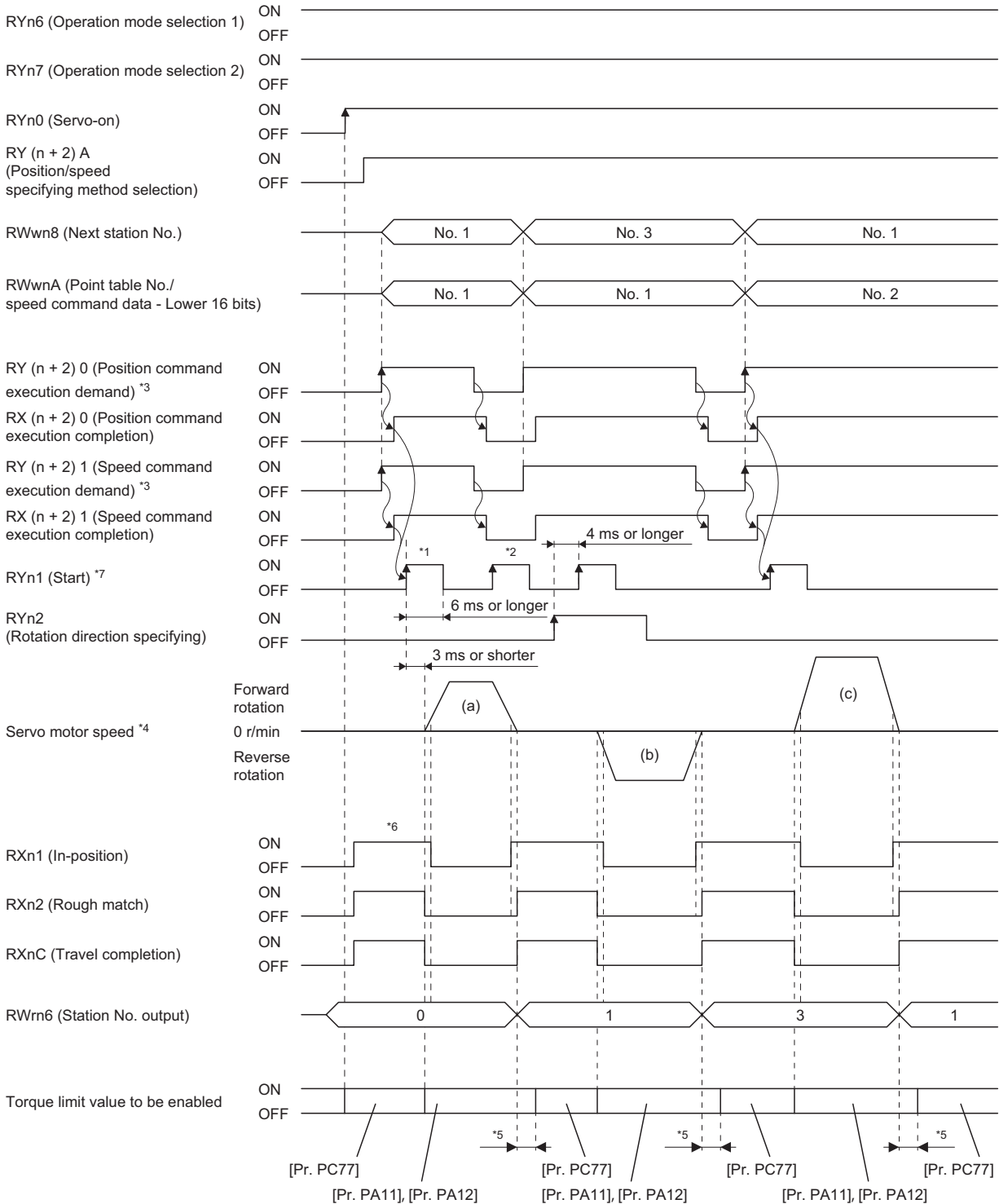

- \*1 Configure a sequence in which RWwn8 and RWwnA is changed earlier taking into consideration the communication delay time.
- \*2 RYn1 is disabled even if it is turned on during operation. To perform the next operation, make sure that RXnC turns on, and then turn on RYn1.
- \*3 For details of the operation timing for RY (n + 2) 0 and RY (n + 2) 1, refer to the following.  
 Page 193 For the next station No. setting and point table No. (speed command) setting
- \*4 Operation is performed as follows.

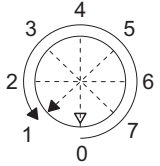
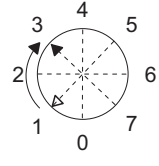
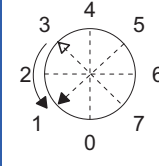
Operation	(a)	(b)	(c)
Next station No.	No. 1	No. 3	No. 1
Servo motor speed Acceleration time constant Deceleration time constant	Point table No. 1	Point table No. 1	Point table No. 2
Positioning			

- \*5 [Pr. PT39] can be used to set the delay time from when RXnC turns on until when the torque limit value changes to the value of [Pr. PC77].
- \*6 After power-on, the device turns on if the number of droop pulses is within the in-position range of each station position.
- \*7 Configure a sequence as follows: After an operation mode is selected, RYn1 (Start) turns on upon the lapse of the switching hold time ("8 ms + communication delay time").

## When using the position/speed specifying method (by setting a servo motor speed directly)

The positioning is executed by selecting a station No. with RWwn8 (Next station No.). Use the value set in the link device as the servo motor speed during operation. Use the value set in point table No. 1 as the acceleration or deceleration time constant during operation.

### ■Device/parameter

Set input devices and parameters as follows:

Item	Device/parameter to be used	Setting
Indexer method selection	Control mode selection of [Pr. PA01]	___8: Select "___8" (positioning mode (indexer method)).
Position/speed specifying method	RY (n + 2) A (Position/speed specifying method selection)	Turn on RY (n + 2) A.
	[Pr. PT62]	Set [Pr. PT62] to "___1_".
Next station position	RWwn8 (Next station No.)	Set any next station No.
Selection of rotation direction specifying indexer	RYn6 (Operation mode selection 1)	Turn off RYn6.
	RYn7 (Operation mode selection 2)	Turn on RYn7.
Rotation direction selection	RYn2 (Rotation direction specifying)	The rotation direction to a station No. will be as follows. Off: Station No. decreasing direction On: Station No. increasing direction
Servo motor speed	RWwnA (Speed command data - Lower 16 bits) RWwnB (Speed command data - Upper 16 bits)	Set a servo motor speed.
Acceleration time constant/ deceleration time constant	Point table No. 1	Set an acceleration time constant and deceleration time constant.
Torque limit *1	[Pr. PA11] [Pr. PA12]	Set a torque limit value for during operation.
	[Pr. PC77]	Set a torque limit value for during stop.
	[Pr. PT39]	Set time to switch the torque limit value from during operation until during stop.

\*1 The torque limit will change from [Pr. PC77 Internal torque limit 2] to the setting value of [Pr. PA11 Forward rotation torque limit] or [Pr. PA12 Reverse rotation torque limit] when RYn1 (Start) is inputted. After RXnC (Travel completion) is turned on, the time set with [Pr. PT39] has passed, the torque limit will change from [Pr. PA11 Forward rotation torque limit] or [Pr. PA12 Reverse rotation torque limit] to the setting value of [Pr. PC77 Internal torque limit 2].

### ■Other parameter settings

Refer to the following.

 Page 199 Other parameter settings

### ■Operation

Selecting a station No. with RWwn8 and a servo motor speed with RWwnA and RWwnB and switching on RYn1 start positioning to the selected station at the set speed, acceleration time constant and deceleration time constant of point table No. 1.

## ■Timing chart



Always perform a home position return. Executing positioning operation without home position return will trigger [AL. 90 Home position return incomplete warning] and RYn1 (Start) will be disabled.

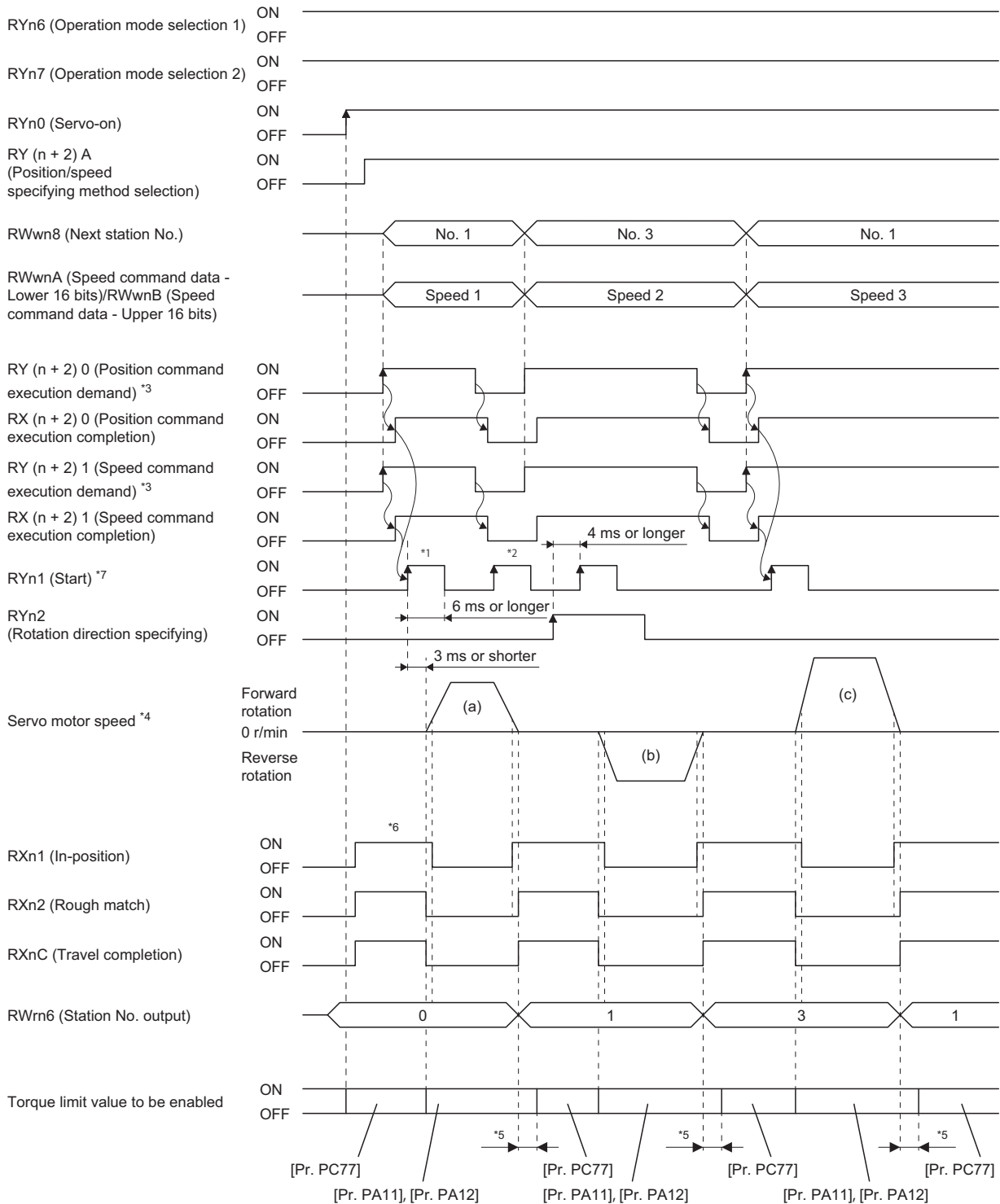

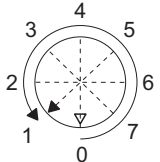
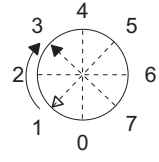
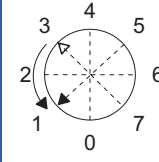

- \*1 Configure a sequence in which RWwn8, RWwnA, and RWwnB is changed earlier taking into consideration the communication delay time.
- \*2 RYn1 is disabled even if it is turned on during operation. To perform the next operation, make sure that RXnC turns on, and then turn on RYn1.
- \*3 For details of the operation timing for RY (n + 2) 0 and RY (n + 2) 1, refer to the following.  
 Page 194 For the next station No. setting and speed command data setting
- \*4 Operation is performed as follows.

Operation	(a)	(b)	(c)
Next station No.	No. 1	No. 3	No. 1
Servo motor speed	Speed 1	Speed 2	Speed 3
Acceleration time constant Deceleration time constant	Point table No. 1	Point table No. 1	Point table No. 1
Positioning			

- \*5 [Pr. PT39] can be used to set the delay time from when RXnC turns on until when the torque limit value changes to the value of [Pr. PC77].
- \*6 After power-on, the device turns on if the number of droop pulses is within the in-position range of each station position.
- \*7 Configure a sequence as follows: After an operation mode is selected, RYn1 (Start) turns on upon the lapse of the switching hold time ("8 ms + communication delay time").

## Shortest rotating indexer operation

This operation mode automatically changes a rotation direction to the shortest distance to execute positioning to a station.

### When not using the position/speed specifying method

The positioning is executed by selecting a station No. with RWwn6 (Next station No. selection). Use the value set in the point table as the servo motor speed, acceleration or deceleration time constant during operation.

#### ■Device/parameter

Set input devices and parameters as follows:

Item	Device/parameter to be used	Setting
Indexer method selection	Control mode selection of [Pr. PA01]	___8: Select "___8" (positioning mode (indexer method)).
Position/speed specifying method	RY (n + 2) A (Position/speed specifying method selection)	Turn off RY (n + 2) A.
Next station position	RWwn6 (Next station No. selection)	Set any next station No.
Selection of shortest rotating indexer operation	RYn6 (Operation mode selection 1)	Turn on RYn6.
	RYn7 (Operation mode selection 2)	Turn on RYn7.
Servo motor speed	Point table	Set a servo motor speed.
Acceleration time constant/ deceleration time constant	Point table	Set an acceleration time constant and deceleration time constant.
Speed command data selection	RWwn7 (Speed selection)	Set a point table No. that stores speed command data.
Torque limit <sup>*1</sup>	[Pr. PA11] [Pr. PA12]	Set a torque limit value for during operation.
	[Pr. PC77]	Set a torque limit value for during stop.
	[Pr. PT39]	Set time to switch the torque limit value from during operation until during stop.

\*1 The torque limit will change from [Pr. PC77 Internal torque limit 2] to the setting value of [Pr. PA11 Forward rotation torque limit] or [Pr. PA12 Reverse rotation torque limit] when RYn1 (Start) is inputted. After RXnC (Travel completion) is turned on, the time set with [Pr. PT39] has passed, the torque limit will change from [Pr. PA11 Forward rotation torque limit] or [Pr. PA12 Reverse rotation torque limit] to the setting value of [Pr. PC77 Internal torque limit 2].

#### ■Point table

Refer to the following.

☞ Page 198 Point table

#### ■Other parameter settings (the number of stations)

Set the number of stations with [Pr. PT28]. The setting is the same as that of the rotation direction specifying indexer. Refer to the following.

☞ Page 199 Other parameter settings

[Pr. PA14 Rotation direction selection] is not used with the shortest rotating indexer operation.

#### ■Operation

When a station No. is selected with RWwn6, a point table in which speed command data is stored is selected with RWwn7, and RYn1 is switched on, positioning to the selected station will start at the set speed and acceleration/deceleration time constant.

## ■ Timing chart

### Point

- Always perform a home position return. Executing positioning operation without home position return will trigger [AL. 90 Home position return incomplete warning] and RYn1 (Start) will be disabled.
- When travel distances are the same to a target station position from CCW and from CW, the shaft will rotate to the station No. increasing direction.

The following shows a timing chart.

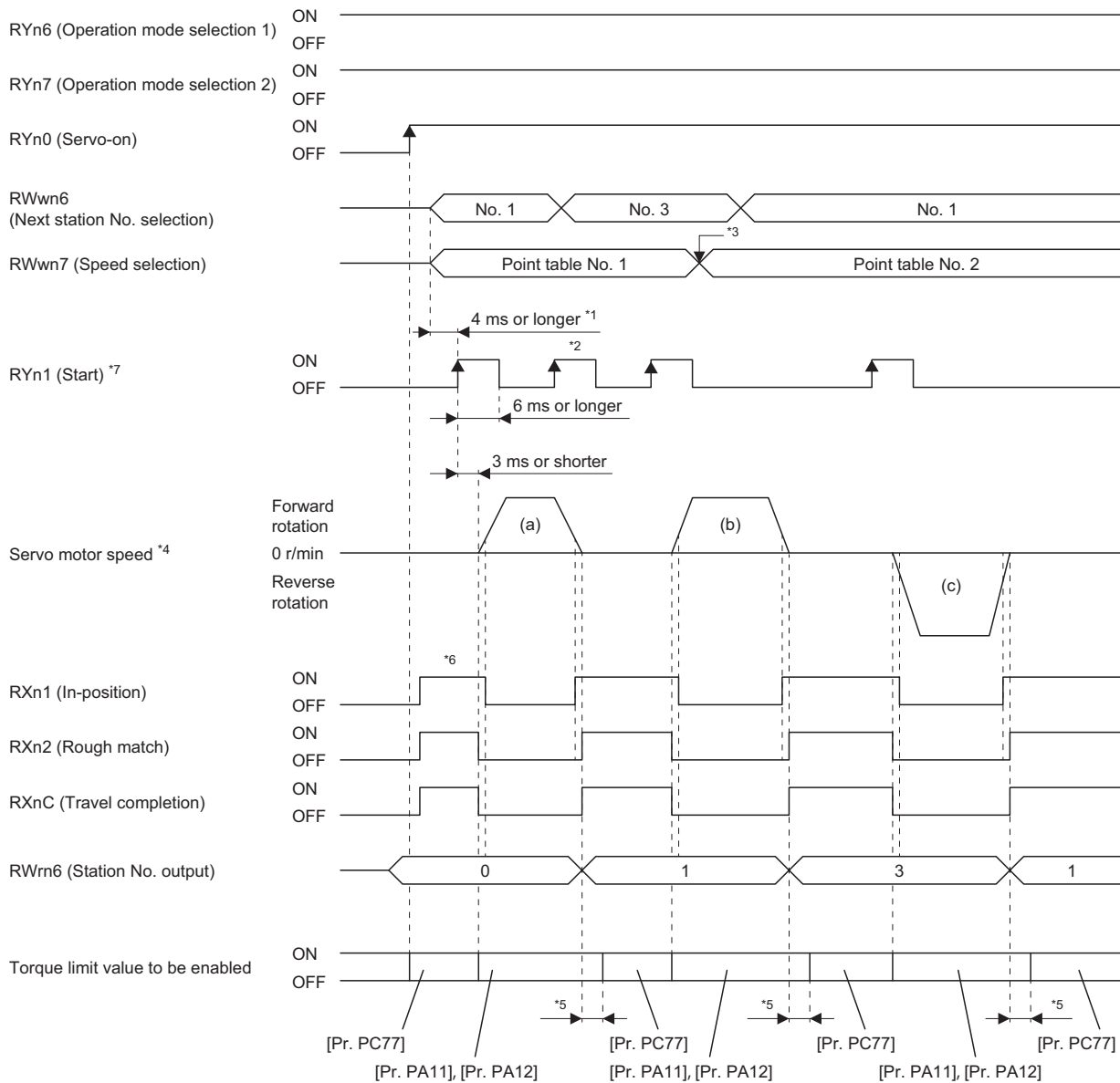

- \*1 Configure a sequence in which RWwn6 and RWwn7 is changed earlier taking into consideration the communication delay time.
- \*2 RYn1 is disabled even if it is turned on during operation. To perform the next operation, make sure that RXnC turns on, and then turn on RYn1.
- \*3 When RYn1 turns on, the servo motor speed and acceleration/deceleration time constants are switched with RWwn7. They are not switched with RWwn7 (Speed selection) while the servo motor is rotating.
- \*4 Operation is performed as follows.

Operation	(a)	(b)	(c)
Next station No.	No. 1	No. 3	No. 1
Servo motor speed Acceleration time constant Deceleration time constant	Point table No. 1	Point table No. 1	Point table No. 2
Positioning			

- \*5 [Pr. PT39] can be used to set the delay time from when RXnC turns on until when the torque limit value changes to the value of [Pr. PC77].
- \*6 After power-on, the device turns on if the number of droop pulses is within the in-position range of each station position.
- \*7 Configure a sequence as follows: After an operation mode is selected, RYn1 (Start) turns on upon the lapse of the switching hold time ("8 ms + communication delay time").

## When using the position/speed specifying method (with speed data of point tables)

The positioning is executed by selecting a station No. with RWwn8 (Next station No.). Use the value set in the point table as the servo motor speed, acceleration or deceleration time constant during operation.

### ■Device/parameter

Set input devices and parameters as follows:

Item	Device/parameter to be used	Setting
Indexer method selection	Control mode selection of [Pr. PA01]	___8: Select "___8" (positioning mode (indexer method)).
Position/speed specifying method	RY (n + 2) A (Position/speed specifying method selection)	Turn on RY (n + 2) A.
	[Pr. PT62]	Set [Pr. PT62] to "___0_".
Next station position	RWwn8 (Next station No.)	Set any next station No.
Selection of shortest rotating indexer operation	RYn6 (Operation mode selection 1)	Turn on RYn6.
	RYn7 (Operation mode selection 2)	Turn on RYn7.
Servo motor speed	Point table	Set a servo motor speed.
Acceleration time constant/ deceleration time constant	Point table	Set an acceleration time constant and deceleration time constant.
Speed command data selection	RWwnA (Point table No./speed command data - Lower 16 bits)	Set a point table No. that stores speed command data.
Torque limit <sup>*1</sup>	[Pr. PA11] [Pr. PA12]	Set a torque limit value for during operation.
	[Pr. PC77]	Set a torque limit value for during stop.
	[Pr. PT39]	Set time to switch the torque limit value from during operation until during stop.

\*1 The torque limit will change from [Pr. PC77 Internal torque limit 2] to the setting value of [Pr. PA11 Forward rotation torque limit] or [Pr. PA12 Reverse rotation torque limit] when RYn1 (Start) is inputted. After RXnC (Travel completion) is turned on, the time set with [Pr. PT39] has passed, the torque limit will change from [Pr. PA11 Forward rotation torque limit] or [Pr. PA12 Reverse rotation torque limit] to the setting value of [Pr. PC77 Internal torque limit 2].

### ■Point table

Refer to the following.

☞ Page 198 Point table

### ■Other parameter settings

Refer to the following.

☞ Page 208 Other parameter settings (the number of stations)

### ■Operation

Selecting a station No. with RWwn8 and a point table in which speed command data is stored with RWwnA and switching on RYn1 start positioning to the selected station at the set speed, acceleration time constant and deceleration time constant.

## ■ Timing chart



- Always perform a home position return. Executing positioning operation without home position return will trigger [AL. 90 Home position return incomplete warning] and RYn1 (Start) will be disabled.
- When travel distances are the same to a target station position from CCW and from CW, the shaft will rotate to the station No. increasing direction.

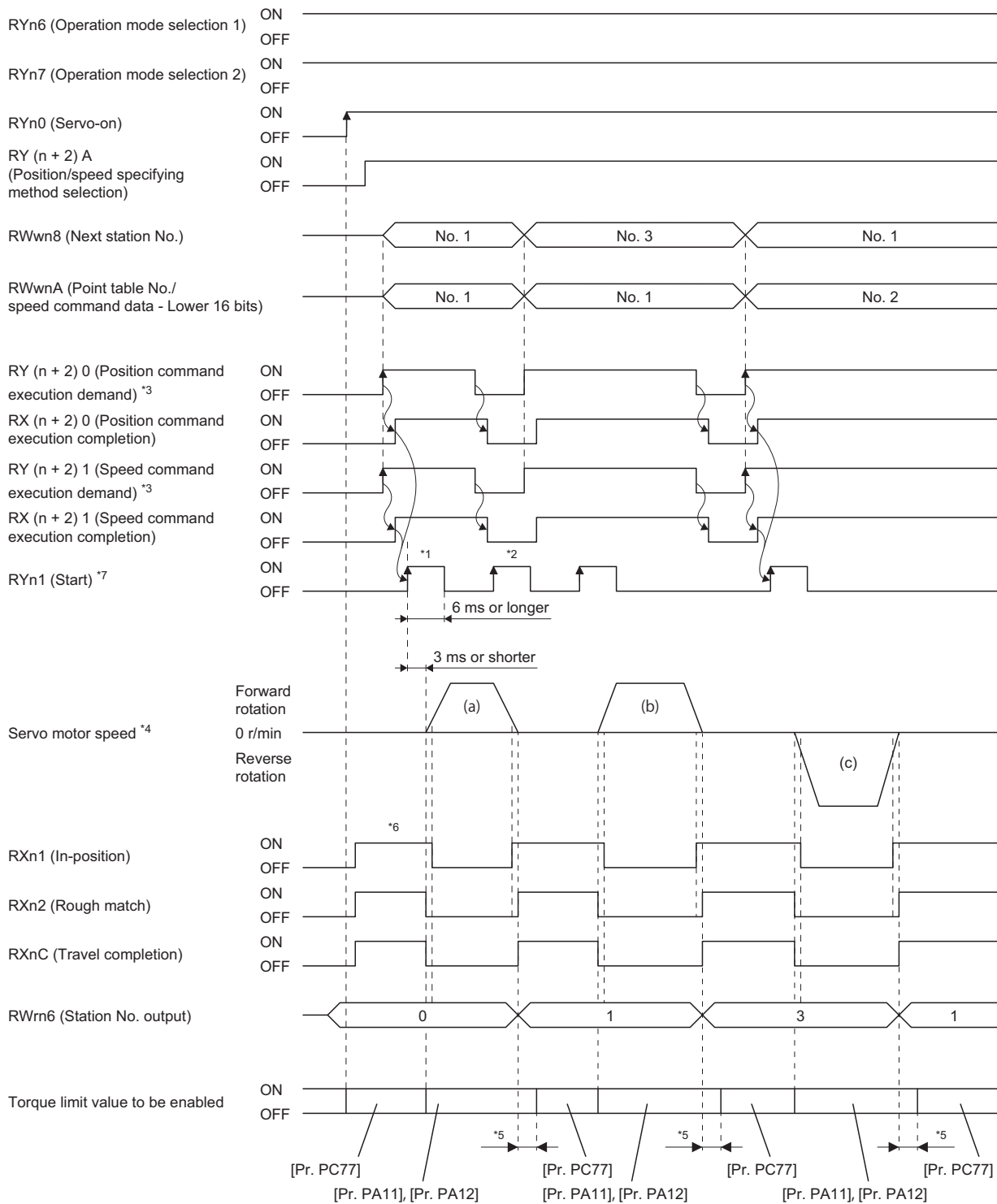

- \*1 Configure a sequence in which RWwn8 and RWwnA is changed earlier taking into consideration the communication delay time.
- \*2 RYn1 is disabled even if it is turned on during operation. To perform the next operation, make sure that RXnC turns on, and then turn on RYn1.
- \*3 For details of the operation timing for RY (n + 2) 0 and RY (n + 2) 1, refer to the following.  
 Page 48 For the position command data setting and point table No. (speed command) setting
- \*4 Operation is performed as follows.

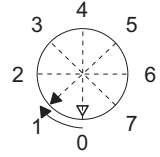
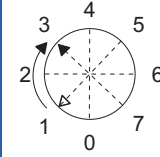
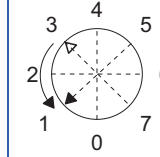
Operation	(a)	(b)	(c)
Next station No.	No. 1	No. 3	No. 1
Servo motor speed Acceleration time constant Deceleration time constant	Point table No. 1	Point table No. 1	Point table No. 2
Positioning			

- \*5 [Pr. PT39] can be used to set the delay time from when RXnC turns on until when the torque limit value changes to the value of [Pr. PC77].
- \*6 After power-on, the device turns on if the number of droop pulses is within the in-position range of each station position.
- \*7 Configure a sequence as follows: After an operation mode is selected, RYn1 (Start) turns on upon the lapse of the switching hold time ("8 ms + communication delay time").

## When using the position/speed specifying method (by setting a servo motor speed directly)

The positioning is executed by selecting a station No. with RWwn8 (Next station No.). Use the value set in the link device as the servo motor speed during operation. Use the value set in point table No. 1 as the acceleration or deceleration time constant during operation.

### ■Device/parameter

Set input devices and parameters as follows:

Item	Device/parameter to be used	Setting
Indexer method selection	Control mode selection of [Pr. PA01]	___8: Select "___8" (positioning mode (indexer method)).
Position/speed specifying method	RY (n + 2) A (Position/speed specifying method selection)	Turn on RY (n + 2) A.
	[Pr. PT62]	Set [Pr. PT62] to "___1_".
Next station position	RWwn8 (Next station No.)	Set any next station No.
Selection of shortest rotating indexer operation	RYn6 (Operation mode selection 1)	Turn on RYn6.
	RYn7 (Operation mode selection 2)	Turn on RYn7.
Servo motor speed	RWwnA (Speed command data - Lower 16 bits) RWwnB (Speed command data - Upper 16 bits)	Set a servo motor speed.
Acceleration time constant/ deceleration time constant	Point table No. 1	Set an acceleration time constant and deceleration time constant.
Torque limit*1	[Pr. PA11] [Pr. PA12]	Set a torque limit value for during operation.
	[Pr. PC77]	Set a torque limit value for during stop.
	[Pr. PT39]	Set time to switch the torque limit value from during operation until during stop.

\*1 The torque limit will change from [Pr. PC77 Internal torque limit 2] to the setting value of [Pr. PA11 Forward rotation torque limit] or [Pr. PA12 Reverse rotation torque limit] when RYn1 (Start) is inputted. After RXnC (Travel completion) is turned on, the time set with [Pr. PT39] has passed, the torque limit will change from [Pr. PA11 Forward rotation torque limit] or [Pr. PA12 Reverse rotation torque limit] to the setting value of [Pr. PC77 Internal torque limit 2].

### ■Other parameter settings

Refer to the following.

 Page 208 Other parameter settings (the number of stations)

### ■Operation

Selecting a station No. with RWwn8 and a servo motor speed with RWwnA and RWwnB and switching on RYn1 start positioning to the selected station at the set speed, acceleration time constant and deceleration time constant of point table No. 1.



## ■ Timing chart

### Point

- Always perform a home position return. Executing positioning operation without home position return will trigger [AL. 90 Home position return incomplete warning] and RYn1 (Start) will be disabled.
- When travel distances are the same to a target station position from CCW and from CW, the shaft will rotate to the station No. increasing direction.

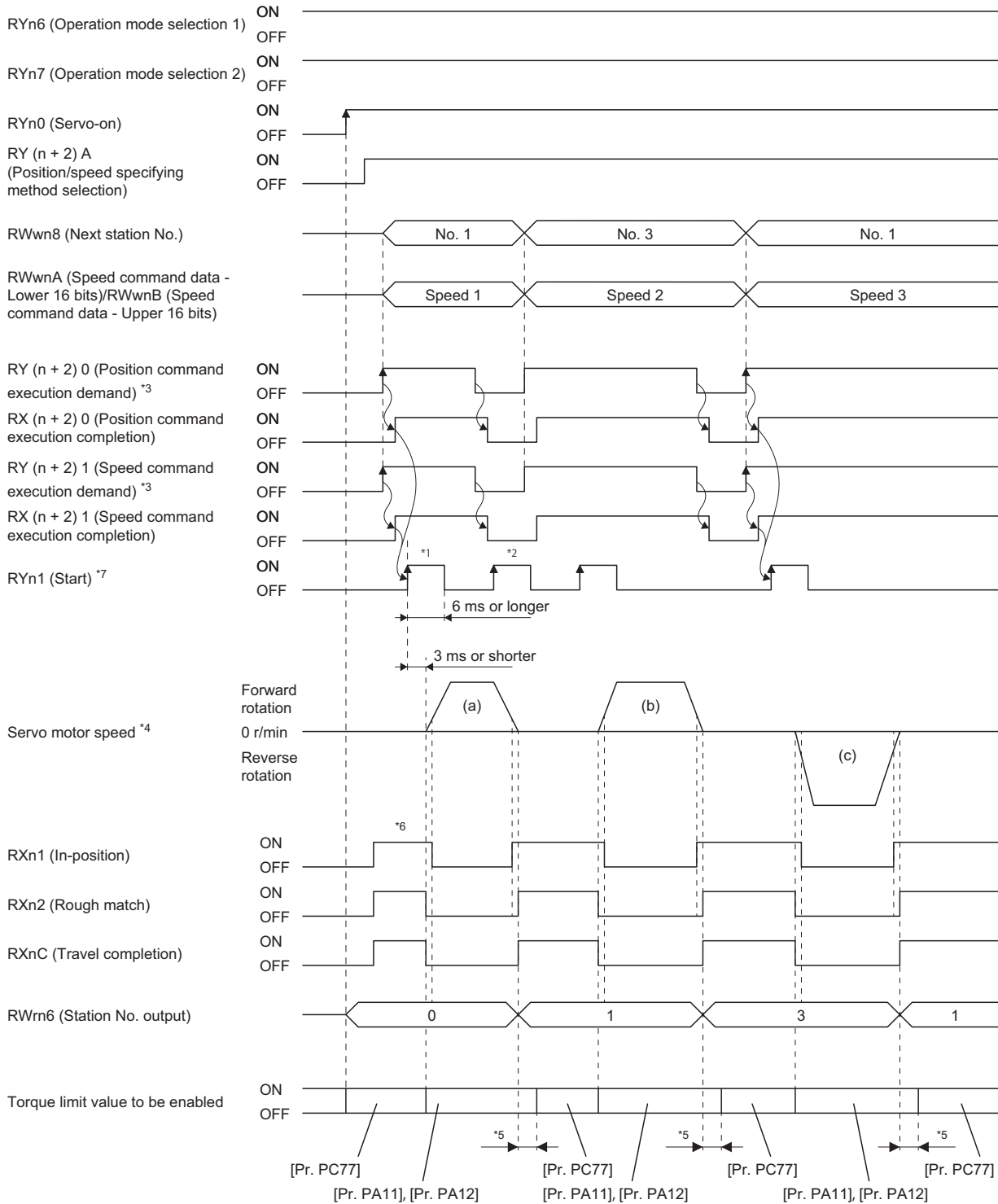

- \*1 Configure a sequence in which RWwn8, RWwnA, and RWwnB is changed earlier taking into consideration the communication delay time.
- \*2 RYn1 is disabled even if it is turned on during operation. To perform the next operation, make sure that RXnC turns on, and then turn on RYn1.
- \*3 For details of the operation timing for RY (n + 2) 0 and RY (n + 2) 1, refer to the following.  
 Page 48 For the position command data setting and point table No. (speed command) setting
- \*4 Operation is performed as follows.

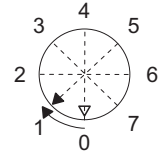
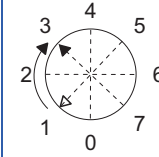
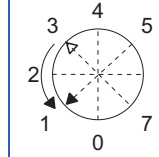
Operation	(a)	(b)	(c)
Next station No.	No. 1	No. 3	No. 1
Servo motor speed	Speed 1	Speed 2	Speed 3
Servo motor speed Acceleration time constant Deceleration time constant	Point table No. 1	Point table No. 1	Point table No. 1
Positioning			

- \*5 [Pr. PT39] can be used to set the delay time from when RXnC turns on until when the torque limit value changes to the value of [Pr. PC77].
- \*6 After power-on, the device turns on if the number of droop pulses is within the in-position range of each station position.
- \*7 Configure a sequence as follows: After an operation mode is selected, RYn1 (Start) turns on upon the lapse of the switching hold time ("8 ms + communication delay time").

# 5.4 Manual operation mode

**Point**

When the operation mode is changed during operation, inputting RYn1 (Start) is disabled until the operation stops. Switch on RYn1 (Start) after the operation stops.

For the machine adjustment, home position adjustment, and others, you can shift the position to any position with the station JOG operation or JOG operation.

## Station JOG operation

### Setting

Set devices and parameters as shown below to suit the purpose. With this operation, RWwn6 (Next station No. selection) and RWwn8 (Next station No.) are disabled.

Item	Device/parameter to be used	Setting
Indexer method selection	Control mode selection of [Pr. PA01]	Select " _ _ _ 8" (positioning mode (indexer method)).
Manual operation mode selection	RYn6 (Operation mode selection 1)	Turn on RYn6.
	RYn7 (Operation mode selection 2)	Turn off RYn7.
Station JOG operation selection	[Pr. PT27]	Select " _ _ 0 _" (Station JOG operation).
Rotation direction selection	RYn2 (Rotation direction specifying)	The rotation direction to a station No. will be as follows. Off: Station No. decreasing direction On: Station No. increasing direction
Selection of station No. assignment direction	[Pr. PA14]	☞ Page 217 Setting the rotation direction selection
Servo motor speed	[Pr. PT65]	Set a servo motor speed.
Acceleration time constant/ deceleration time constant	Acceleration time constant: [Pr. PT49] Deceleration time constant: [Pr. PT50]	Set an acceleration time constant and deceleration time constant.

### Setting the rotation direction selection

Select an assignment direction of station No. with [Pr. PA14].

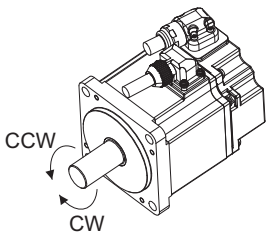

[Pr. PA14] setting	Servo motor rotation direction RYn1 (Start) is on
0 (initial value)	Next station No. will be assigned in CW direction in order of 1, 2, 3...
1	Next station No. will be assigned in CCW direction in order of 1, 2, 3...

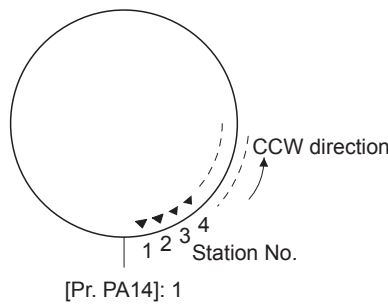
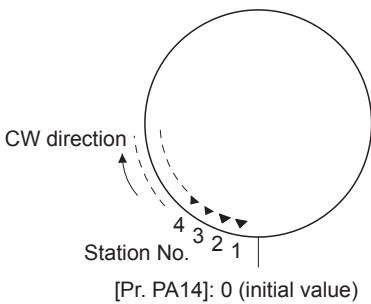

## Operation

Turning on RYn1 (Start) will start rotating the servo motor in the direction specified with the rotation direction decision, and turning off RYn1 will execute a positioning to the closest station position at which the servo motor can decelerate to a stop. However, the shaft stops based on a set time constant depending on the setting value of deceleration time constant. The speed may not reach the specified servo motor speed.

## Timing chart

The following shows a timing chart.

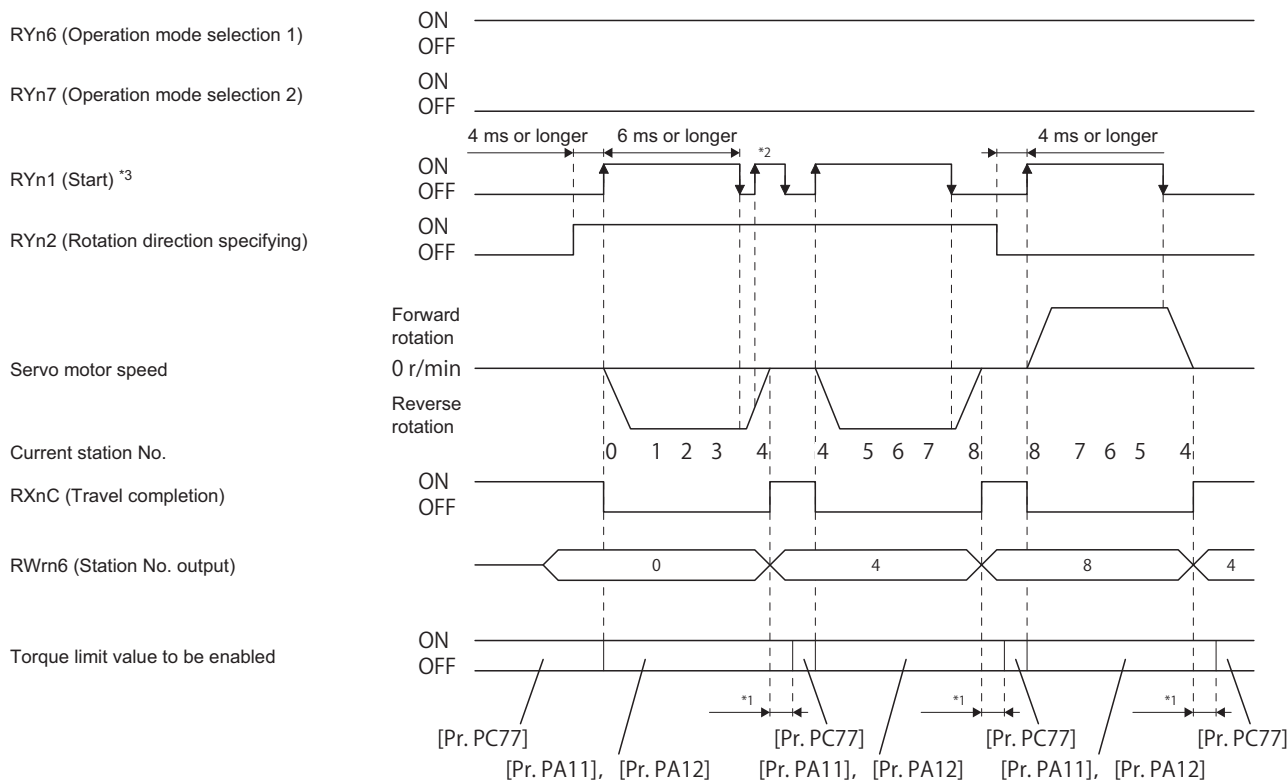

\*1 The torque limit delay time can be set with [Pr. PT39].

\*2 RYn1 is disabled even if it is turned on during operation. To perform the next operation, make sure that RXnC (Travel completion) turns on, and then turn on RYn1.

\*3 Configure a sequence as follows: After an operation mode is selected, RYn1 (Start) turns on upon the lapse of the switching hold time ("8 ms + communication delay time").

# JOG operation

## Setting

Set devices and parameters as shown below to suit the purpose. With this operation, RWwn6 (Next station No. selection) and RWwn8 (Next station No.) are disabled.

Item	Device/parameter to be used	Setting
Indexer method selection	Control mode selection of [Pr. PA01]	Select "___8" (positioning mode (indexer method)).
Manual operation mode selection	RYn6 (Operation mode selection 1)	Turn on RYn6.
	RYn7 (Operation mode selection 2)	Turn off RYn7.
JOG operation selection	[Pr. PT27]	Select "___1_" (JOG operation).
Rotation direction selection	RYn2 (Rotation direction specifying)	The rotation direction to a station No. will be as follows. Off: Station No. decreasing direction On: Station No. increasing direction
Selection of station No. assignment direction	[Pr. PA14]	☞ Page 217 Setting the rotation direction selection
Servo motor speed	[Pr. PT65]	Set a servo motor speed.
Acceleration time constant/ deceleration time constant	Acceleration time constant: [Pr. PT49] Deceleration time constant: [Pr. PT50]	Set an acceleration time constant and deceleration time constant.

## Operation

Turning on RYn1 (Start) will start rotating the servo motor in the direction specified with the rotation direction decision and turning off RYn1 will decelerate the servo motor to a stop regardless of the station position.

## Timing chart

The following shows a timing chart.

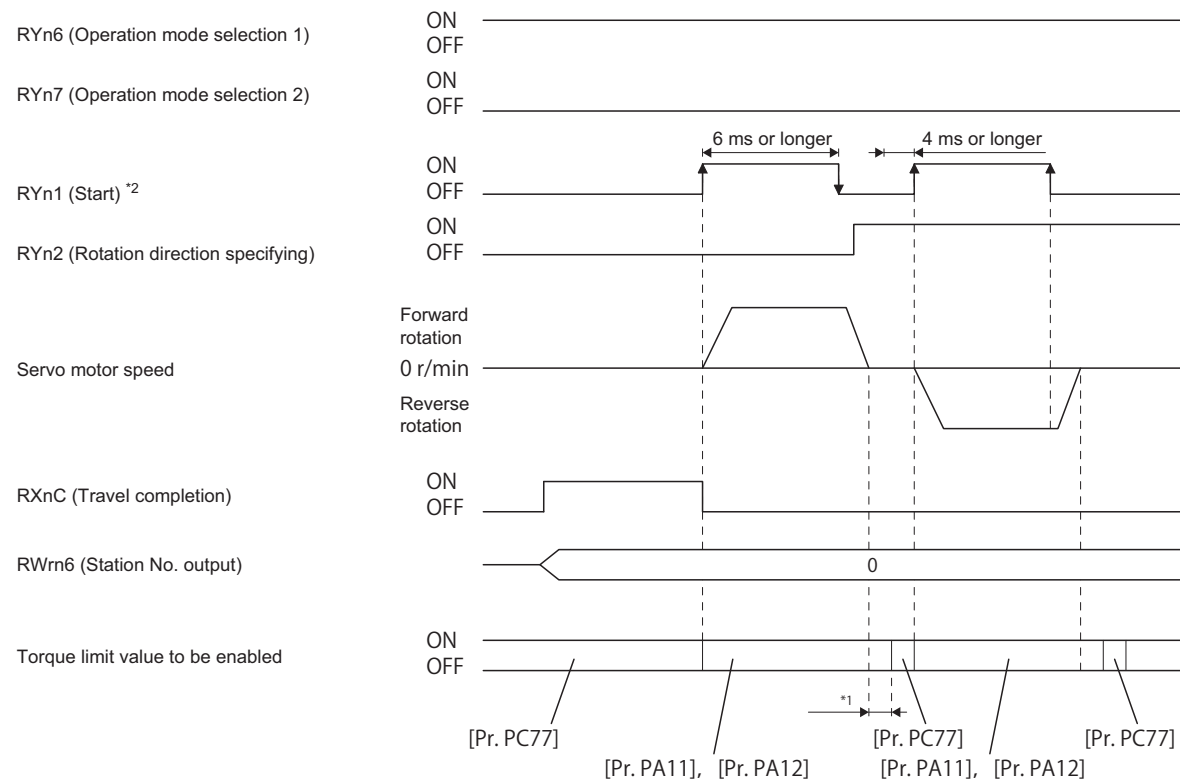

\*1 The torque limit delay time can be set with [Pr. PT39].

\*2 Configure a sequence as follows: After an operation mode is selected, RYn1 (Start) turns on upon the lapse of the switching hold time ("8 ms + communication delay time").

## 5.5 Home position return mode

### Point

Before performing the home position return, check that the limit switch operates and RYn2 turns on.

Check the home position return direction. An incorrect setting will cause a reverse running.

Check the input polarity of the external limit. Otherwise, it may cause an unexpected operation.

For the home position return when the servo motor is used in the direct drive motor control mode and the fully closed control mode, refer to "MR-J4-\_GF\_(-RJ) Servo Amplifier Instruction Manual (Motion Mode)".

### Outline of home position return

A home position return is performed to match the command coordinates with the machine coordinates. Under the incremental method, each power-on of the input power supply requires the home position return. Contrastingly, in the absolute position detection system, once you have performed the home position return at machine installation, the current position will be retained even if the power supply is shut off. Therefore, the home position return is unnecessary when the power supply is switched on again.

This section shows the home position return types of the servo amplifier. Select the optimum method according to the configuration and uses of the machine.

Type	Home position return type	Feature
Torque limit changing dog type (front end detection, Z-phase reference)	Deceleration starts from the front end of the proximity dog. A position of the first Z-phase signal with which the servo motor can decelerate to a stop or a position moved by the home position shift amount from the Z-phase is set as the home position.	<ul style="list-style-type: none"><li>• This is a typical home position return method using an external limit.</li><li>• The repeatability of the home position return is high.</li><li>• The machine is less loaded.</li><li>• Used when the width of the external limit can be set equal to or greater than the deceleration distance of the servo motor.</li></ul>
Torque limit changing dog type (rear end detection, Z-phase reference) *1	Deceleration starts at the front end of the proximity dog. After the rear end is passed, the position specified by the first Z-phase signal, or the position of the first Z-phase signal shifted by the home position shift distance is used as the home position.	
Torque limit changing data set type	The current position is set as the home position.	<ul style="list-style-type: none"><li>• An external limit is not required.</li></ul>
Homing method 35, 37 (Homing on current position)	The current position is set as the home position.	<ul style="list-style-type: none"><li>• The home position return can be performed in the servo-off status.</li></ul>

\*1 This is available with servo amplifiers with software version A7 or later.

## Torque limit changing dog type home position return (front end detection, Z-phase reference)

This is a home position return type using a proximity dog. Deceleration starts from the front end of the proximity dog. A position of the first Z-phase signal with which the servo motor can decelerate to a stop or a position moved by the home position shift amount from the Z-phase is set as the home position.

### Device/parameter

Set input devices and parameters as follows:

Item	Device/parameter to be used	Setting
Home position return mode selection	RYn6 (Operation mode selection 1)	Turn off RYn6.
	RYn7 (Operation mode selection 2)	Turn off RYn7.
Function selection for torque limit changing dog type home position return *3	[Pr. PT70]	Select "0" or "2". 0: Front end detection and automatic retract function for home position return are disabled 2: Front end detection and automatic retract function for home position return are enabled
Torque limit changing dog type home position return (front end detection, Z-phase reference)	[Pr. PT45]	Select "-1" or "-33". -1: Forward rotation (CCW) -33: Reverse rotation (CW)
Dog input polarity	[Pr. PT29]	Select a proximity dog input polarity.
Home position return speed	[Pr. PT05]	Set the rotation speed specified until an external limit is detected.
Creep speed	[Pr. PT06]	Set the rotation speed specified after an external limit is detected.
Home position shift distance	[Pr. PT07], [Pr. PT69]	Set this item to shift the home position, which is specified by the first Z-phase signal after the external limit is detected. Lower/upper settings are enabled.
Acceleration time constant/ deceleration time constant	Acceleration time constant: [Pr. PT56] Deceleration time constant: [Pr. PT56] or [Pr. PT57]	Set an acceleration time constant and deceleration time constant. For the deceleration time constant, when [Pr. PT55] is set to "___0", the value of [Pr. PT56] is used, and when [Pr. PT55] is set to "___1", the value of [Pr. PT57] is used.
Torque limit value for the execution of home position return	[Pr. PA11]	Set a torque limit value for home position return in the forward rotation direction.
	[Pr. PA12]	Set a torque limit value for home position return in the reverse rotation direction.
Torque limit value during stop	[Pr. PC77]	Set a torque limit value for during stop.

\*1 The setting of the station home position shift distance is disabled at home position return. Cycling the power will enable the setting.

\*2 [Pr. PT40 Station home position shift distance] is enabled as an offset to the position that the home position return is performed. If a larger value than the in-position range is set to [Pr. PT40], the completion output of positioning will not turn on (short circuit) at the first power on after home position return.

\*3 [Pr. PT70] is available with servo amplifiers with software version A7 or later.

## Timing chart

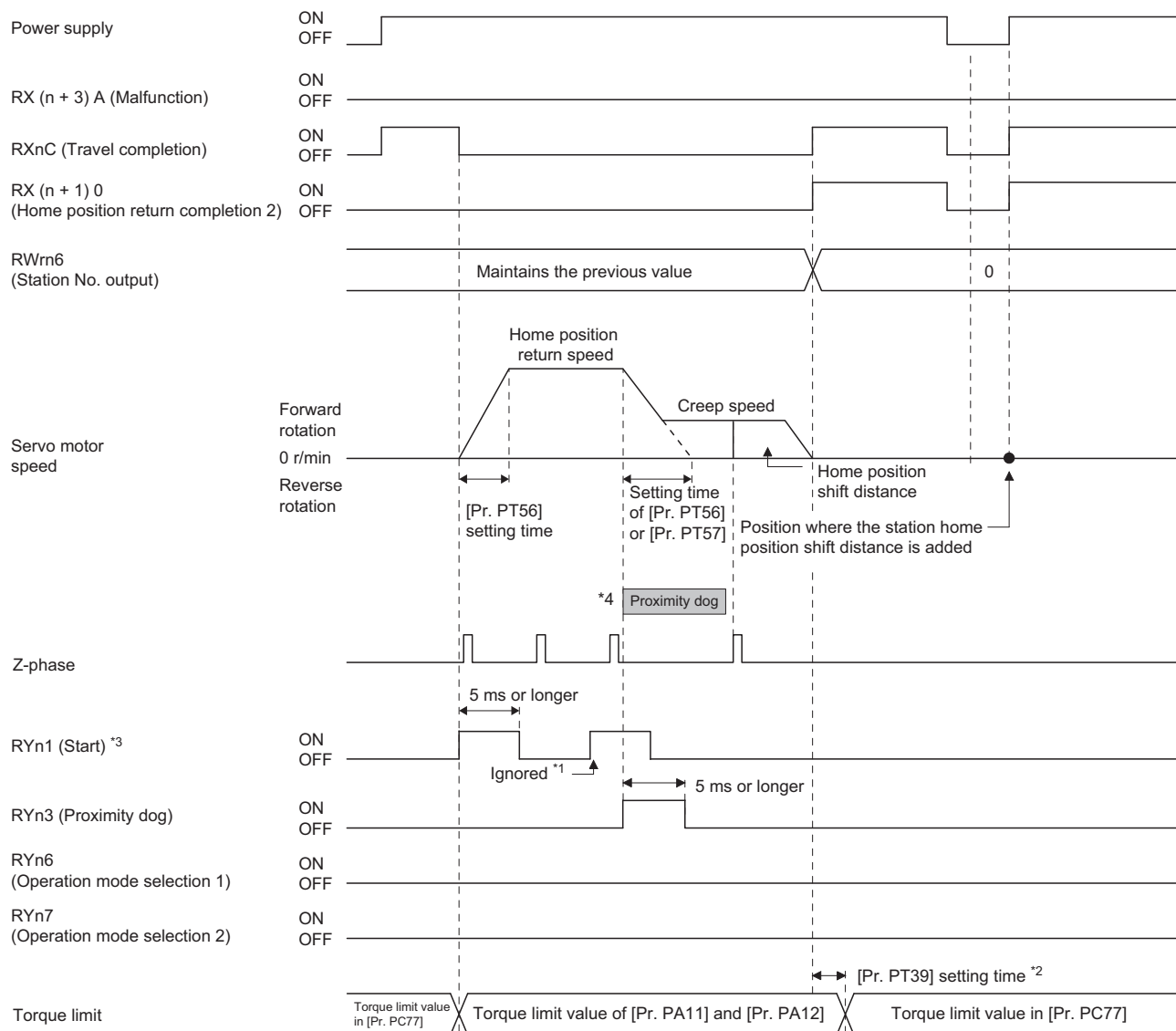

\*1 When the rest of command travel distance is other than "0", RYn1 (Start) is not enabled even if it is turned on.

\*2 Counting will start when the rest of command travel distance becomes "0".

\*3 Configure a sequence as follows: After an operation mode is selected, RYn1 (Start) turns on upon the lapse of the switching hold time ("8 ms + communication delay time").

\*4 After the front end of the proximity dog is detected, if the Z-phase is detected without reaching the creep speed, [AL. 90] occurs. Check the home position return speed and creep speed.



### ■When the automatic retract function for home position return is disabled

Set [Pr. PT70] to "\_\_\_0".

- When the stroke end is detected

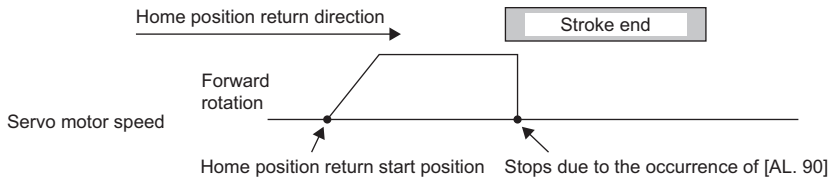

### ■When the automatic retract function for home position return is enabled

Set [Pr. PT70] to "\_\_\_2".

- When a home position return is started from the proximity dog

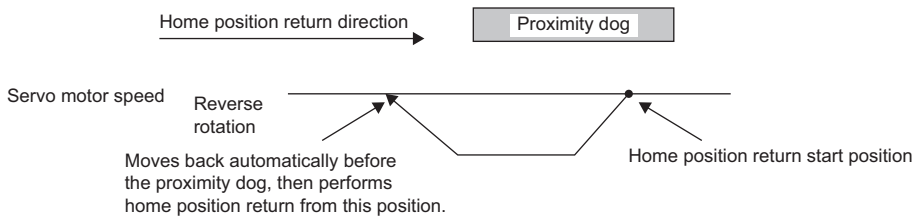

- When the movement is returned at the stroke end

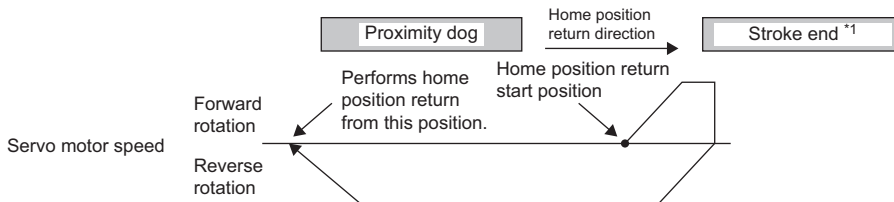

\*1 This is not available with the software limit.

## Torque limit changing dog type home position return (rear end detection, Z-phase reference)

This is a home position return type using a proximity dog. Deceleration starts at the front end of the proximity dog. After the rear end is passed, the position specified by the first Z-phase signal, or the position of the first Z-phase signal shifted by the home position shift distance is used as the home position.

### Device/parameter

Set input devices and parameters as follows:

Item	Device/parameter to be used	Setting
Home position return mode selection	RYn6 (Operation mode selection 1)	Turn off RYn6.
	RYn7 (Operation mode selection 2)	Turn off RYn7.
Function selection for torque limit changing dog type home position return *3	[Pr. PT70]	Select "1" or "3". 1: Rear end detection and automatic retract function for home position return are disabled 3: Rear end detection and automatic retract function for home position return are enabled
Torque limit changing dog type home position return (rear end detection, Z-phase reference)	[Pr. PT45]	Select "-1" or "-33". -1: Forward rotation (CCW) -33: Reverse rotation (CW)
Dog input polarity	[Pr. PT29]	Select a proximity dog input polarity.
Home position return speed	[Pr. PT05]	Set the rotation speed specified until an external limit is detected.
Creep speed	[Pr. PT06]	Set the rotation speed specified after an external limit is detected.
Home position shift distance	[Pr. PT07], [Pr. PT69]	Set this item to shift the home position, which is specified by the first Z-phase signal after the external limit is detected. Lower/upper settings are enabled.
Acceleration time constant/ deceleration time constant	Acceleration time constant: [Pr. PT56] Deceleration time constant: [Pr. PT56] or [Pr. PT57]	Set an acceleration time constant and deceleration time constant. For the deceleration time constant, when [Pr. PT55] is set to "___0", the value of [Pr. PT56] is used, and when [Pr. PT55] is set to "___1", the value of [Pr. PT57] is used.
Torque limit value for the execution of home position return	[Pr. PA11]	Set a torque limit value for home position return in the forward rotation direction.
	[Pr. PA12]	Set a torque limit value for home position return in the reverse rotation direction.
Torque limit value during stop	[Pr. PC77]	Set a torque limit value for during stop.

\*1 The setting of the station home position shift distance is disabled at home position return. Cycling the power will enable the setting.

\*2 [Pr. PT40 Station home position shift distance] is enabled as an offset to the position that the home position return is performed. If a larger value than the in-position range is set to [Pr. PT40], the completion output of positioning will not turn on (short circuit) at the first power on after home position return.

\*3 [Pr. PT70] is available with servo amplifiers with software version A7 or later.

## Timing chart

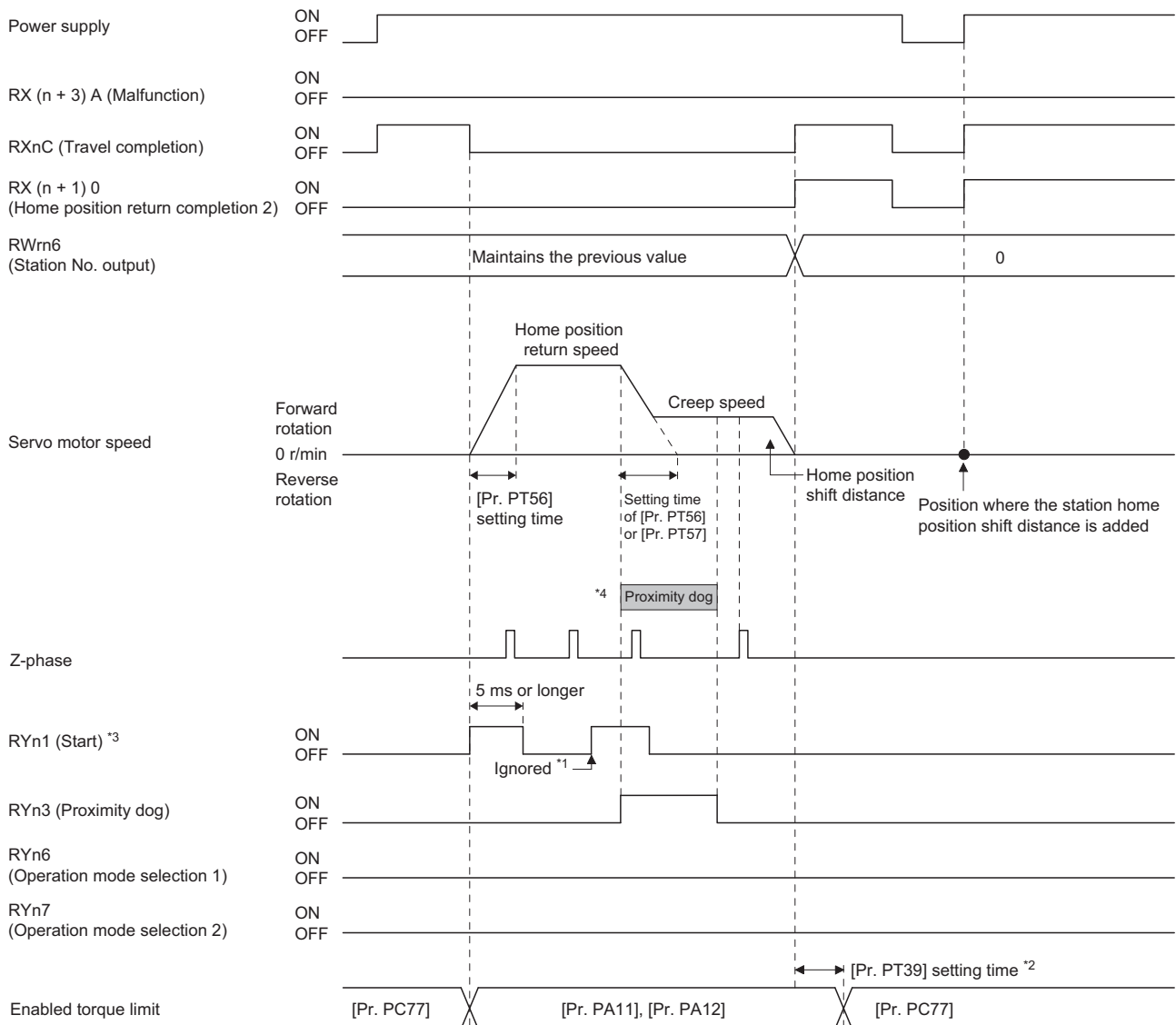

\*1 When the rest of command travel distance is other than "0", RYn1 (Start) is not enabled even if it is turned on.

\*2 Counting will start when the rest of command travel distance becomes "0".

\*3 Configure a sequence as follows: After an operation mode is selected, RYn1 (Start) turns on upon the lapse of the switching hold time ("8 ms + communication delay time").

\*4 After the front end of the proximity dog is detected, if the rear end of the proximity dog is detected without reaching the creep speed, [AL. 90] occurs. Check the length of the proximity dog or check the home position return speed and creep speed.

**■When the automatic retract function for home position return is disabled**

Set [Pr. PT70] to "\_\_\_ 1".

- When the stroke end is detected

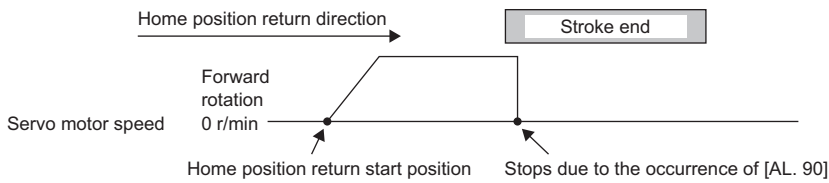

**■When the automatic retract function for home position return is enabled**

Set [Pr. PT70] to "\_\_\_ 3".

- When a home position return is started from the proximity dog

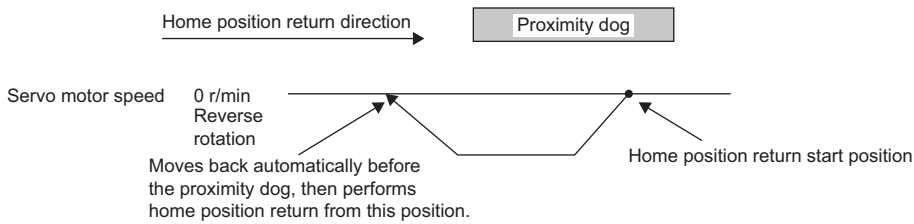

- When the movement is returned at the stroke end

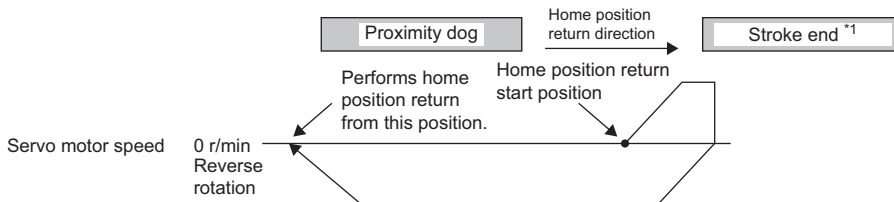

\*1 This is not available with the software limit.

# Torque limit changing data set type

## Point

When the data set type home position return is selected, [AL. 42] and [AL. 52] will not be detected.

If the servo motor is rotated in the home position return mode and the mode is changed to automatic mode without home position return, the following may occur.

- [AL. 42] or [AL. 52] can occur.
- Even though [AL. 42] or [AL. 52] does not occur, the motor will try to compensate a position gap to the command position at start signal input because the current position is out of position with the command position. Watch out for the servo motor rotation due to the compensation for the gap to zero between command position and current position.

When [AL. 90] is occurring, performing home position return will automatically cancel the alarm.

When [AL. 25] is occurring, cycling the power will cancel the alarm.

When setting any position as home, use the torque limit changing data set type home position return. The JOG operation, the manual pulse generator operation, and others can be used for the travel. With this home position return, torque will not be generated simultaneously at switching to the home position return mode. Any home position can be set by rotating the shaft with an external force.

Additionally, the proximity dog is not used. The proximity dog is disabled even if it is turned off.

## Device/parameter

Set input devices and parameters as follows:

Item	Device/parameter to be used	Setting
Home position return mode selection	RYn6 (Operation mode selection 1)	Turn off RYn6.
	RYn7 (Operation mode selection 2)	Turn off RYn7.
Torque limit changing data set type home position return	[Pr. PT45]	Select "-3" (data set type).
Torque limit value during stop	[Pr. PC77]	Set a torque limit value for during stop.

## Timing chart

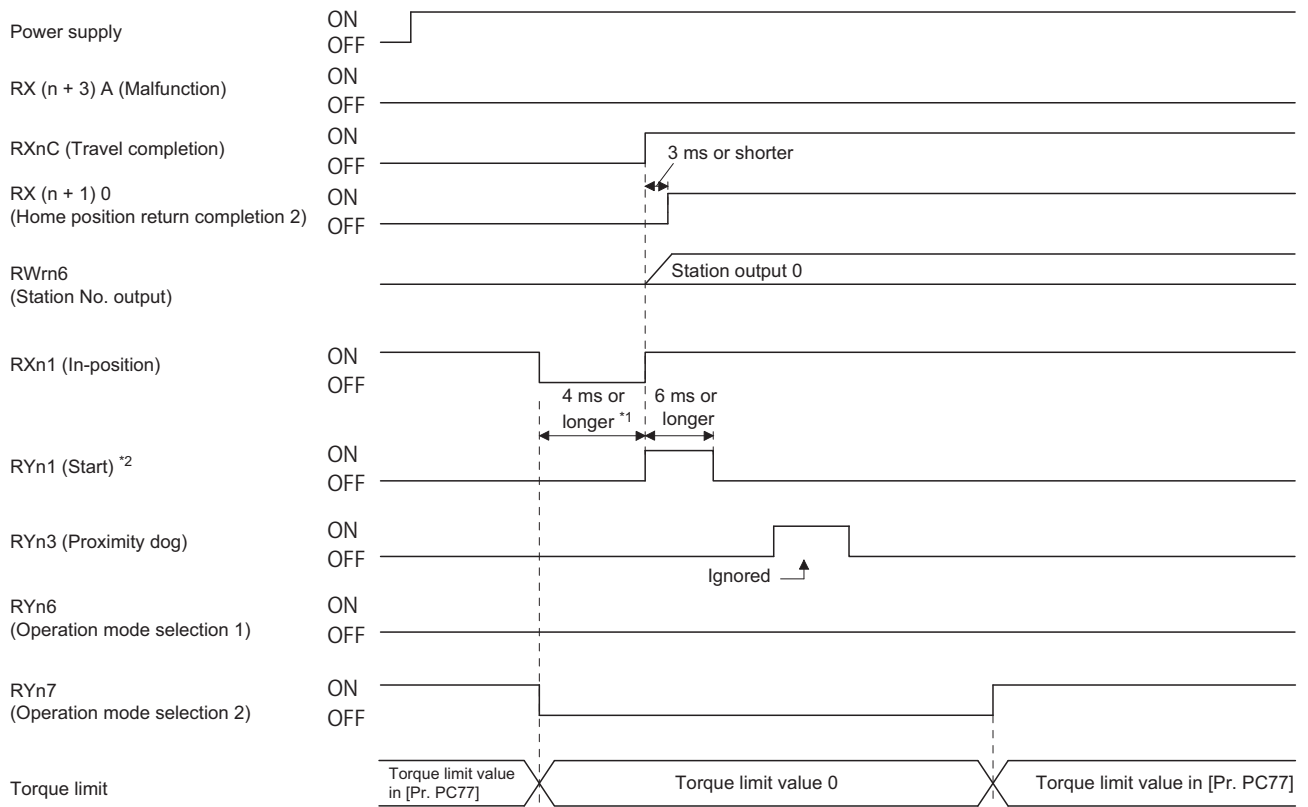

\*1 Configure a sequence that changes the operation mode earlier by the communication delay time.

\*2 Configure a sequence as follows: After an operation mode is selected, RYn1 (Start) turns on upon the lapse of the switching hold time ("8 ms + communication delay time").

# Homing method 35, 37 (Homing on current position)

In the servo-off status, any home position can be set by rotating the servo motor shaft with an external force. When using the servo motor with an electromagnetic brake, use the torque limit changing data set type because the brake operates in the servo-off status.

## Device/parameter

Set input devices and parameters as follows:

Item	Device/parameter to be used	Setting
Home position return mode selection	RYn6 (Operation mode selection 1)	Turn off RYn6.
	RYn7 (Operation mode selection 2)	Turn off RYn7.
Homing method 35, 37	[Pr. PT45]	Select "-5" or "37" (Homing on current position).

## Timing chart

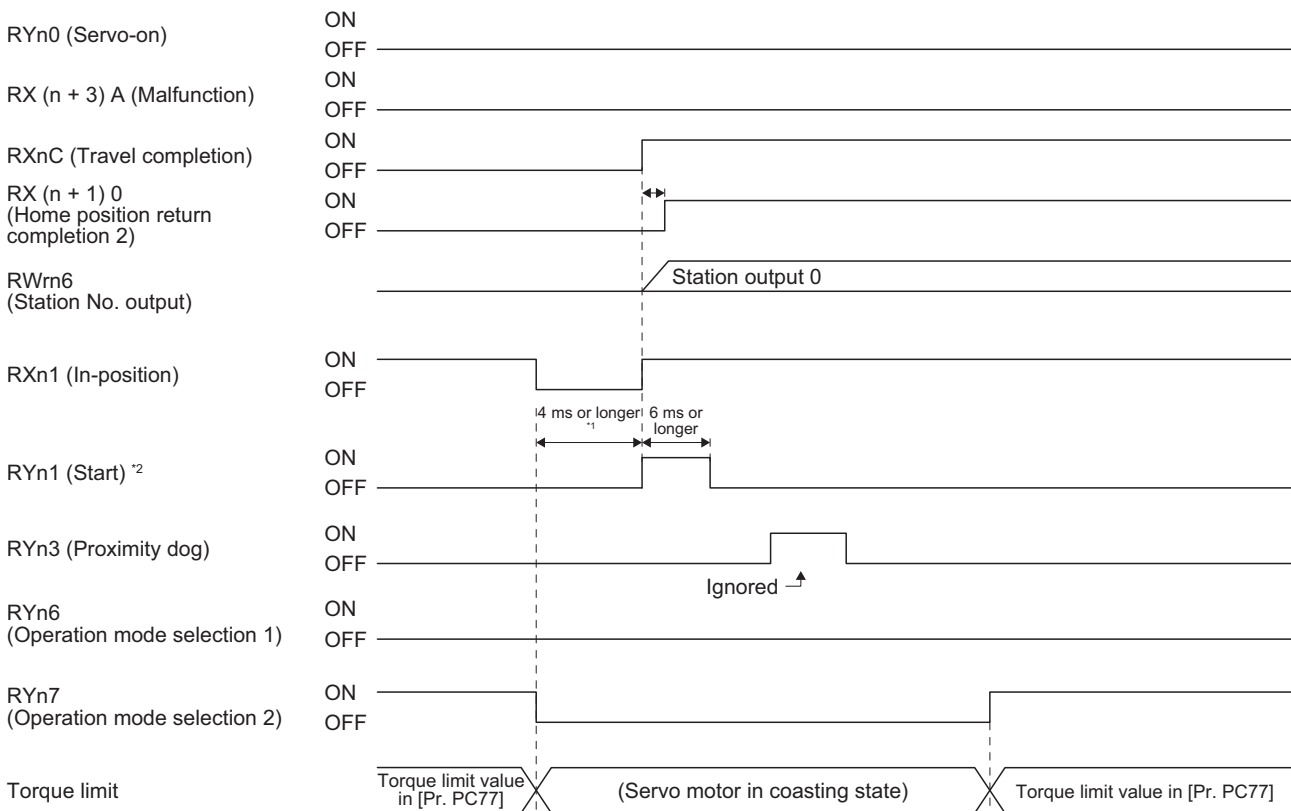

\*1 Configure a sequence that changes the operation mode earlier by the communication delay time.

\*2 Configure a sequence as follows: After an operation mode is selected, RYn1 (Start) turns on upon the lapse of the switching hold time ("8 ms + communication delay time").

# 5.6 Application of indexer function

## Backlash compensation

Setting [Pr. PT14 Backlash compensation] stops the servo motor at a position compensated by the setting value of this parameter when a command direction in automatic operation is reversed.

**Point**

Backlash compensation is available with servo amplifiers with software version A8 or later. Before using this function, press a workpiece against the machine side so that the clearance between parts such as gear teeth on the machine side and the motor side or between feed screws will be generated only on one side.

The timing charts are for when the travel distance between stations is set to 1000 and the backlash compensation is set to 10.

### For home position return types where the servo motor operates at home position return

The backlash compensation direction will be determined by the home position return direction just before the completion of home position return.

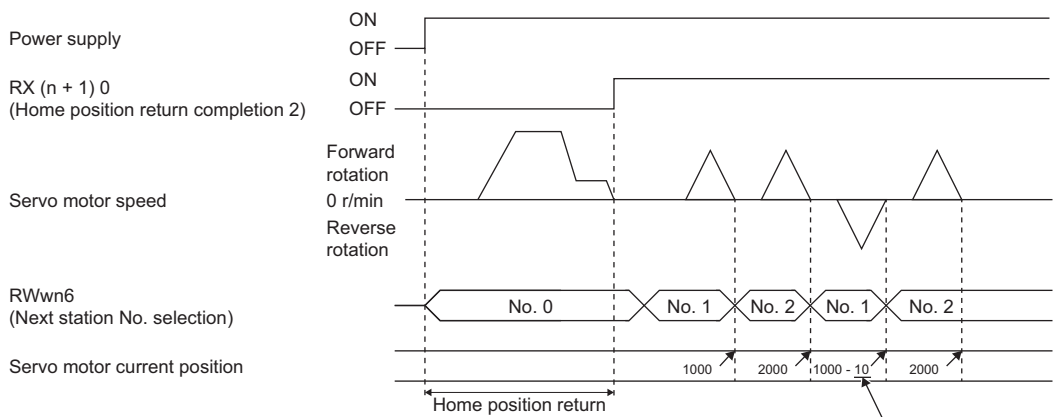

As the rotation direction immediately before home position return is in the forward rotation, backlash compensation is applied when positioning is performed in the reverse rotation.



## For home position return types where the servo motor does not operate at home position return

The backlash compensation direction will be determined by "Backlash compensation direction selection at data set type home position return" in [Pr. PT38] as follows:

### ■When [Pr. PT38] is set to "0 \_ \_ \_" (automatic setting)

Be sure to perform JOG operation before home position return, then press parts such as gears or feed screw tooth on the motor side against the machine side.

The backlash compensation direction will be determined by the motor rotation direction just before the completion of home position return.

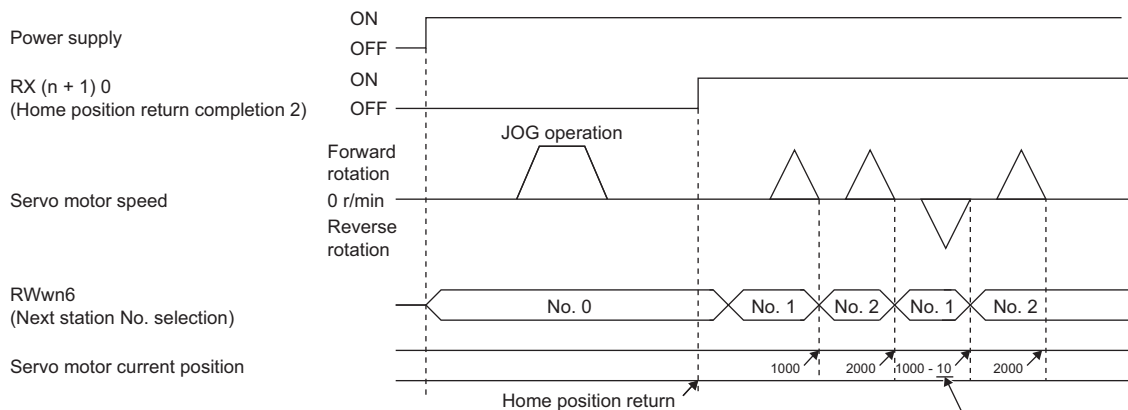

As the rotation direction immediately before home position return is in the forward rotation, backlash compensation is applied when positioning is performed in the reverse rotation.

### ■When [Pr. PT38] is set to "1 \_ \_ \_" (CCW direction or positive direction) or "2 \_ \_ \_" (CW or negative direction)

The compensation will apply to the set direction. Before home position return, be sure to press gears or feed screws on the motor side against the machine side in the opposite direction of the compensation direction set in [Pr. PT38].

The following timing chart is for when [Pr. PT38] is set to "1 \_ \_ \_" (CCW direction or positive direction).

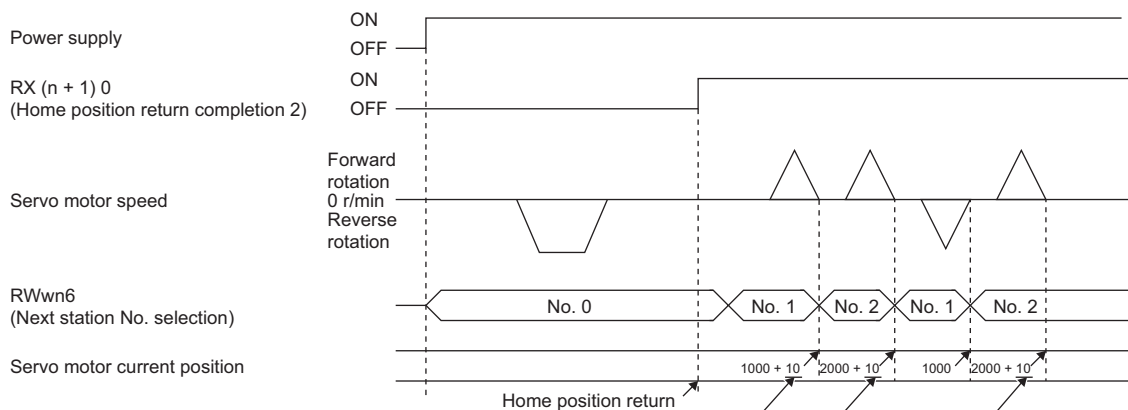

The compensation will be applied to the compensation direction set in [Pr. PT38].

# 6 SPEED CONTROL OPERATION

The items shown in the following table are the same as those for the motion mode. For details, refer to each section indicated in the detailed explanation field. "MR-J4-\_GF\_" means "MR-J4-\_GF\_(-RJ) Servo Amplifier Instruction Manual (Motion Mode)".

Item	Detailed explanation
Startup	MR-J4-_GF_ section 4.2
Switch setting and display of the servo amplifier	MR-J4-_GF_ section 4.3
Test operation	MR-J4-_GF_ section 4.4
Test operation mode	MR-J4-_GF_ section 4.5

## Point

The speed control operation is available with servo amplifiers with software version A6 or later.

When you use a linear servo motor, replace the following left words to the right words.

- Load to motor inertia ratio → Load to motor mass ratio
- Torque → Thrust

## 6.1 Link device

### Profile

Some input devices can be assigned to the CN3 pin using [Pr. PD03] to [Pr. PD05]. When using the CC-Link IE Field Network communication and CN3 connector's input signal, assigned devices other than upper stroke limit, lower stroke limit and proximity dog can be used simultaneously.

Some output devices can be assigned to the CN3 pin with [Pr. PD07] to [Pr. PD09]. The assigned devices can be used together when using the CC-Link IE Field Network communication and CN3 connector's output signal.

When turning off input/output signals, turn off both CC-Link IE Field Network communication and external I/O signals of the CN3 connector. The following shows the profile of link devices communicated with the master station in cyclic communication.

## RYn profile

Master station → Servo amplifier (RYn)			
Device No. *1	Device	Symbol	CN3 connector pin No.
RYn0	Servo-on	SON	—
RYn1	Forward rotation start	ST1	—
RYn2	Reverse rotation start	ST2	—
RYn3	Unavailable	—	—
RYn4			
RYn5			
RYn6			
RYn7			
RYn8	Monitor output execution demand	MOR	—
RYn9	Instruction code execution demand	COR	—
RYnA to RYnC	Unavailable	—	—
RYnD	Speed acceleration/deceleration selection	STAB	—
RYnE to RYnF	Unavailable	—	—
RY (n + 1) 0	Upper stroke limit	FLS	—
RY (n + 1) 1	Lower stroke limit	RLS	—
RY (n + 1) 2 to RY (n + 1) F	Unavailable	—	—
RY (n + 2) 0			
RY (n + 2) 1	Speed command execution demand	SPR	—
RY (n + 2) 2 to RY (n + 2) 5	Unavailable	—	—
RY (n + 2) 6	Internal torque limit selection *2	CTL	—
RY (n + 2) 7	Proportional control (PID control)	PC	—
RY (n + 2) 8	Gain switching	CDP	—
RY (n + 2) 9	Unavailable	—	—
RY (n + 2) A	Speed specifying method selection	CSL	—
RY (n + 2) B to RY (n + 2) F	Unavailable	—	—
RY (n + 3) 0 to RY (n + 3) 9			
RY (n + 3) A			
RY (n + 3) A	Reset	RES	—
RY (n + 3) B to RY (n + 3) F	Unavailable	—	—

\*1 "n" depends on the station No. setting.

\*2 This is available with servo amplifiers with software version A7 or later.

## RXn profile

Servo amplifier → Master station (RXn)			
Device No. *1	Device	Symbol	CN3 connector pin No.
RXn0	Ready	RD	—
RXn1 to RXn3	Unavailable	—	—
RXn4	Limiting torque	TLC	—
RXn5	Speed reached	SA	—
RXn6	Electromagnetic brake interlock	MBR	13
RXn7	Unavailable	—	—
RXn8	Monitoring	MOF	—
RXn9	Instruction code execution completion	COF	—
RXnA	Warning	WNG	—
RXnB	Unavailable	—	—
RXnC			
RXnD			
RXnE	Unavailable	—	—
RXnF	Zero speed detection	ZSP	—
RX (n + 1) 0 to RX (n + 1) F	Unavailable	—	—
RX (n + 2) 0			
RX (n + 2) 1	Speed command execution completion	SPF	—
RX (n + 2) 2 to RX (n + 2) F	Unavailable	—	—
RX (n + 3) 0 to RX (n + 3) 9			
RX (n + 3) A			
RX (n + 3) B	Remote station communication ready	CRD	—
RX (n + 3) C to RX (n + 3) F	Unavailable	—	—

\*1 "n" depends on the station No. setting.

## RWwn profile

Master station → Servo amplifier (RWwn)	
Device No. *1	Device
RWwn0	Monitor 1
RWwn1	Unavailable
RWwn2	Monitor 2
RWwn3	Unavailable
RWwn4	Instruction code - Lower 16 bits
RWwn5	Instruction code - Upper 16 bits
RWwn6	Unavailable
RWwn7	Speed selection
RWwn8	Unavailable
RWwn9	
RWwnA	Speed command data - Lower 16 bits/speed selection
RWwnB	Speed command data - Upper 16 bits
RWwnC	Writing data - Lower 16 bits
RWwnD	Writing data - Upper 16 bits
RWwnE	Unavailable
RWwnF	

\*1 "n" depends on the station No. setting.

## RWrn profile

Servo amplifier → Master station (RWrn)	
Device No. *1	Device
RWrn0	Monitor 1 data - Lower 16 bits
RWrn1	Monitor 1 data - Upper 16 bits
RWrn2	Monitor 2 data - Lower 16 bits
RWrn3	Monitor 2 data - Upper 16 bits
RWrn4	Respond code
RWrn5	Unavailable
RWrn6	
RWrn7	
RWrn8	
RWrn9	
RWrnA	
RWrnB	
RWrnC	Reading data - Lower 16 bits
RWrnD	Reading data - Upper 16 bits
RWrnE	Unavailable
RWrnF	

\*1 "n" depends on the station No. setting.

# Detailed explanation of the RYn/RXn profile

## RYn profile

Device No.	Device	Description																						
RYn0	Servo-on	Turn on RYn0 to power on the base circuit, and make the servo amplifier ready to operate. (servo-on status) Turn it off to shut off the base circuit, and coast the servo motor.																						
RYn1	Forward rotation start	This is used to start the servo motor.																						
RYn2	Reverse rotation start	The following shows the rotation directions. <table border="1" data-bbox="678 492 1356 705"> <thead> <tr> <th rowspan="2">RYn2</th> <th rowspan="2">RYn1</th> <th colspan="2">Servo motor starting direction</th> </tr> <tr> <th>[Pr. PA14] = 0</th> <th>[Pr. PA14] = 1</th> </tr> </thead> <tbody> <tr> <td>0</td> <td>0</td> <td colspan="2">Stop (stops with the speed command = 0)</td> </tr> <tr> <td>0</td> <td>1</td> <td>CCW direction</td> <td>CW direction</td> </tr> <tr> <td>1</td> <td>0</td> <td>CW direction</td> <td>CCW direction</td> </tr> <tr> <td>1</td> <td>1</td> <td colspan="2">Stop (stops with the speed command = 0)</td> </tr> </tbody> </table> <p>*1 0: off, 1: on</p> <p>If both RYn1 and RYn2 turn on or off during operation, the servo motor decelerates to a stop. The servo motor will not be servo-locked at a stop. The servo motor speed will turn 0 r/min by the control, and the stop position will not be maintained.</p>	RYn2	RYn1	Servo motor starting direction		[Pr. PA14] = 0	[Pr. PA14] = 1	0	0	Stop (stops with the speed command = 0)		0	1	CCW direction	CW direction	1	0	CW direction	CCW direction	1	1	Stop (stops with the speed command = 0)	
RYn2	RYn1	Servo motor starting direction																						
		[Pr. PA14] = 0	[Pr. PA14] = 1																					
0	0	Stop (stops with the speed command = 0)																						
0	1	CCW direction	CW direction																					
1	0	CW direction	CCW direction																					
1	1	Stop (stops with the speed command = 0)																						
RYn8	Monitor output execution demand	Turning on RYn8 sets the following data. At this time, RXn8 turns on. While RYn8 is on, the monitor value is always updated. RWm0: Lower 16 bits of data requested with RWwn0 (Monitor 1) RWm1: Upper 16 bits of data requested with RWwn0 (Monitor 1) RWm2: Lower 16 bits of data requested with RWwn2 (Monitor 2) RWm3: Upper 16 bits of data requested with RWwn2 (Monitor 2) RWm4: Respond code indicating a normal or error result																						
RYn9	Instruction code execution demand	Turning on RYn9 executes the processing corresponding to the instruction code set with RWwn4 and RWwn5. After the instruction code execution is completed, a respond code indicating a normal or error result is stored in RWm4, and RXn9 turns on. Refer to the following for details of the instruction code. ☞ Page 241 Instruction code																						
RYnD	Speed acceleration/deceleration selection	Enables selecting the acceleration/deceleration time constants while the servo motor rotates in the speed control mode (point table method). <table border="1" data-bbox="678 1265 1356 1377"> <thead> <tr> <th>RYnD *1</th> <th>Acceleration/deceleration time constants</th> </tr> </thead> <tbody> <tr> <td>0</td> <td>Acceleration/deceleration time constants of point table No. 1</td> </tr> <tr> <td>1</td> <td>Acceleration/deceleration time constants of point table No. 2</td> </tr> </tbody> </table> <p>*1 0: off, 1: on</p>	RYnD *1	Acceleration/deceleration time constants	0	Acceleration/deceleration time constants of point table No. 1	1	Acceleration/deceleration time constants of point table No. 2																
RYnD *1	Acceleration/deceleration time constants																							
0	Acceleration/deceleration time constants of point table No. 1																							
1	Acceleration/deceleration time constants of point table No. 2																							
RY (n + 1) 0	Upper stroke limit	To execute the operation, turn on RY (n + 1) 0 and RY (n + 1) 1. Turning off the device corresponding to the address increasing or decreasing direction will bring the servo motor to a slow stop and make it servo-locked.																						
RY (n + 1) 1	Lower stroke limit	The stop method can be changed with [Pr. PD12].																						
RY (n + 2) 1	Speed command execution demand	Turning on RY (n + 2) 1 sets the point table No. or speed command data set in RWwnA and RWwnB. If a point table No. or speed command data is set to the servo amplifier, a respond code indicating a normal or error result is set in RWm4 and RX (n + 2) 1 (Speed command execution completion) turns on. When [Pr. PT62] is set as follows, the reflecting timing of the speed command data can be switched. <ul style="list-style-type: none"> <li>When [Pr. PT62] is set to "0 ___", the point table No. and speed command data set in RWwnA and RWwnB will be reflected by turning on RY (n + 2) 1.</li> <li>When [Pr. PT62] is set to "1 ___", the point table No. and speed command data set in RWwnA and RWwnB will be reflected while RY (n + 2) 1 is being turned on.</li> </ul>																						
RY (n + 2) 6	Internal torque limit selection	If RY (n + 2) 6 is turned on, the setting value of [Pr. PA11 Forward rotation torque limit] or [Pr. PA12 Reverse rotation torque limit] is compared with [Pr. PC77 Internal torque limit] and the lower one will be enabled.																						

Device No.	Device	Description
RY (n + 2) 7	Proportional control (PID control)	Turn on RY (n + 2) 7 to switch the speed amplifier from the proportional integral type to the proportional type. If the servo motor at a stop is rotated even one pulse due to any external factor, it generates torque to compensate for a position shift. When the servo motor shaft is to be locked mechanically after RXnC (Travel completion) is turned off, switching on RY (n + 2) 7 (Proportional control) upon turning RXnC (Travel completion) off will suppress the unnecessary torque generated to compensate for a position shift. When the shaft is to be locked for a long time, turn on RY (n + 2) 7 and make the torque less than the rated torque with the torque limit. This function will be enabled by selecting "PI control enabled (___0)" in "PI-PID switching control selection" of [Pr. PB24].
RY (n + 2) 8	Gain switching	Turn on RY (n + 2) 8 to use the values of [Pr. PB29] to [Pr. PB36] and [Pr. PB56] to [Pr. PB60] as the load to motor inertia ratio and gain values.
RY (n + 2) A	Speed specifying method selection	Select how to give a speed command. Off: Specify a point table No. with RWwn7 (Speed selection) to give a speed command. On: • When [Pr. PT62] is set to "_ 0 _ _" Specify a point table No. in RWwnA to give a speed command. • When [Pr. PT62] is set to "_ 1 _ _" Set the speed command data in RWwnA and RWwnB to give a speed command.
RY (n + 3) A	Reset	Turn on RY (n + 3) A to reset alarms. However, some alarms cannot be cleared with RY (n + 3) A.

## RXn profile

Device No.	Device	Description
RXn0	Ready	When the servo-on is on and the servo amplifier is ready to operate, RXn0 turns on.
RXn4	Limiting torque	RXn4 turns on when a generated torque reaches a value set with [Pr. PA11 Forward rotation torque limit] or [Pr. PA12 Reverse rotation torque limit].
RXn5	Speed reached	RXn5 will turn off during servo-off. When the servo motor speed reaches the following range, RXn5 will turn on. Set speed $\pm ((\text{Set speed} \times 0.05) + 20)$ r/min When the set speed is 20 r/min or less, RXn5 is always on.
RXn6	Electromagnetic brake interlock	When using the device, set operation delay time of the electromagnetic brake in [Pr. PC02]. When a servo-off status or alarm occurs, RXn6 turns off.
RXn8	Monitoring	Refer to RYn8 (Monitor output execution demand).
RXn9	Instruction code execution completion	Refer to RYn9 (Instruction code execution demand).
RXnA	Warning	When a warning occurs, RXnA turns on. When a warning is not occurring, turning on the power will turn off RXnA after 4 s to 5 s.
RXnD	Dynamic brake interlock	RXnD turns off when the dynamic brake needs to operate.
RXnF	Zero speed detection	RXnF turns on when the servo motor speed is zero speed or less. Zero speed can be changed with [Pr. PC07].
RX (n + 2) 1	Speed command execution completion	Refer to RY (n + 2) 1 (Speed command execution demand).
RX (n + 3) A	Malfunction	When an alarm occurs, RX (n + 3) A will turn on. When an alarm is not occurring, turning on the power will turn off RX (n + 3) A after 4 s to 5 s.
RX (n + 3) B	Remote station communication ready	Turning on the power will turn on RX (n + 3) B. When an alarm occurs, RX (n + 3) B will turn off.

## Detailed explanation of the RWwn/RWrn profile

### RWwn profile

Device No.	Device	Description	Setting range
RWwn0	Monitor 1	Setting a monitor code to monitor in RWwn0 and turning on RYn8 store data in RWrn0 and RWrn1. At this time, RXn8 turns on. Refer to the following for monitor codes for status display. ☞ Page 240 Monitor code	☞ Page 240 Monitor code
RWwn2	Monitor 2	Setting a monitor code to monitor in RWwn2 and turning on RYn8 store data in RWrn2 and RWrn3. At this time, RXn8 turns on. Refer to the following for monitor codes for status display. ☞ Page 240 Monitor code	☞ Page 240 Monitor code
RWwn4	Instruction code - Lower 16 bits	Set an instruction code No. used to read or write a parameter or point table data or to refer to an alarm. Setting an instruction code No. in RWwn4 and turning on RYn9 execute the instruction. RXn9 turns on after the instruction execution is completed. Refer to the following for the instruction code No. ☞ Page 241 Instruction code	☞ Page 241 Instruction code
RWwn5	Instruction code - Upper 16 bits	When a value other than "0000h" is set in this device, the instruction code is not executed even if RYn9 is turned on and "1 _ _" is set in respond code.	0000h
RWwn7	Speed selection	Specify the point table No. that stores the speed command data being used. The speed command data must be the permissible instantaneous speed or less of the servo motor being used.	Point table No.: 1 to 255
RWwnA	Speed command data - Lower 16 bits/speed selection	This function can be used while RY (n + 2) A (Position/speed specifying method selection) is on (the remote register-based speed specifying method is selected). • For the point table No. setting When RY (n + 2) 1 is turned on after a point table No. is set in RWwnA while [Pr. PT62] is set to "0 _ _ _", the point table No. will be set in the servo amplifier. Once the setting is completed, RX (n + 2) 1 turns on. • For the speed command data setting When RY (n + 2) 1 is turned on after the lower 16 bits of the servo motor speed is set in RWwnA and the upper 16 bits of the servo motor speed is set in RWwnB while [Pr. PT62] is set to "1 _ _ _", the speed command data will be set in the servo amplifier. Once the setting is completed, RX (n + 2) 1 turns on. The servo motor speed unit is 0.01 r/min or 0.01 mm/s.	Point table No.: 1 to 255 Speed command data: 0 to permissible speed
RWwnB	Speed command data - Upper 16 bits		
RWwnC	Writing data - Lower 16 bits	Set writing data used to write a parameter or point table data or to clear the alarm history. Setting writing data in RWwnC and RWwnD and turning on RYn9 write the data to the servo amplifier. When the writing is completed, RXn9 turns on. Refer to the following for writing data. ☞ Page 244 Writing instruction code	☞ Page 244 Writing instruction code
RWwnD	Writing data - Upper 16 bits		



## RWrn profile

Device No.	Device	Description	Setting range
RWrn0	Monitor 1 data - Lower 16 bits	The lower 16 bits of the data corresponding to the monitor code set in RWwn0 are stored.	—
RWrn1	Monitor 1 data - Upper 16 bits	The upper 16 bits of the data corresponding to the monitor code set in RWwn0 are stored. A sign is set if no data is set in the upper 16 bits.	—
RWrn2	Monitor 2 data - Lower 16 bits	The lower 16 bits of the data corresponding to the monitor code set in RWwn2 are stored.	—
RWrn3	Monitor 2 data - Upper 16 bits	The upper 16 bits of the data corresponding to the monitor code set in RWwn2 are stored. A sign is set if no data is set in the upper 16 bits.	—
RWrn4	Respond code	When the codes set in RWwn0 to RWwnD have been executed normally, "0000" is set.	—
RWrnC	Reading data - Lower 16 bits	Data corresponding to the reading code set in RWwn4 is set.	—
RWrnD	Reading data - Upper 16 bits		—

# Code

## Monitor code

Use any of the instruction codes 0100h to 011Fh to read the decimal point position (multiplying factor) of the status display. Setting any code No. that is not given in this section will set an error code ( \_ \_ \_ 1) in respond code (RWrn4). At this time, "0000" is set in RWrn0 to RWrn3.

Code No.	Monitored item	Response data content (Servo amplifier → Master station)	
		Data length	Unit
0000h	—	—	—
0001h			
0002h			
0003h			
0004h			
0005h			
0006h			
0007h			
0008h			
0009h	Speed selection No.	16 bits	—
000Ah	Cumulative feedback pulses	32 bits	[pulse]
000Bh	—	—	—
000Ch			
000Dh			
000Eh	Droop pulses	32 bits	[pulse]
000Fh	—	—	—
0010h			
0011h	Regenerative load ratio	16 bits	[%]
0012h	Effective load ratio	16 bits	[%]
0013h	Peak load ratio	16 bits	[%]
0014h	Instantaneous torque	16 bits	[%]
0015h	ABS counter	16 bits	[rev]
0016h	Servo motor speed	32 bits	0.01 [r/min]/0.01 [mm/s]
0017h	—	—	—
0018h	Bus voltage	16 bits	[V]
0019h	—	—	—
001Ah			
001Bh			
001Ch	Position within one-revolution	32 bits	[pulse]
001Dh	—	—	—
001Eh			
001Fh			
0020h			
0021h			
0022h			
0024h			
0025h			
0026h			

## Instruction code

Refer to the following for the timing charts of the instruction codes.

☞ Page 45 Instruction code

### ■Reading instruction code

The data requested to be read with the instruction codes 0000h to 0AFFh is stored in reading data (RWrnC and RWrnD). Set the instruction code No. corresponding to the item in RWwn4 and RWwn5. The instruction code No. and response data are all hexadecimal.

Setting any instruction code No. that is not given in this section will store an error code ( \_ \_ 1 \_ ) in respond code (RWrn4). If any unusable parameter or point table is read, an error code ( \_ \_ 2 \_ ) is stored. At this time, "0000" is stored in reading data (RWrnC and RWrnD).

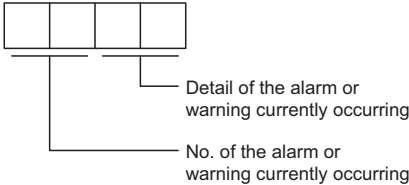
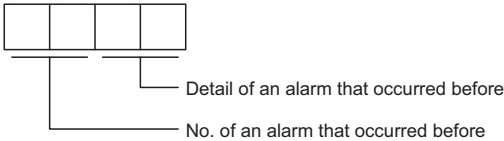
Code No.		Item/function	Reading data content (Servo amplifier → Master station)	
RWwn5	RWwn4		RWrnC	RWrnD
0000h	0000h	Operation mode Reads the current operation mode.	0000: CC-Link IE operation mode 0001: Test operation mode	Always 0
0000h	0002h	Travel distance multiplying factor Reads the multiplying factor of the position data in the point table set with [Pr. PT03].	0000: × 1 0100: × 10 0200: × 100 0300: × 1000	Always 0
0000h	0010h	Current alarm (warning) reading Reads the alarm No. or warning No. that is currently occurring.		Always 0
0000h	0020h	Alarm number in alarm history (latest alarm)		Always 0
0000h	0021h	Alarm number in alarm history (one alarm ago)		
0000h	0022h	Alarm number in alarm history (two alarms ago)		
0000h	0023h	Alarm number in alarm history (three alarms ago)		
0000h	0024h	Alarm number in alarm history (four alarms ago)		
0000h	0025h	Alarm number in alarm history (five alarms ago)		
0000h	0026h	Alarm number in alarm history (six alarms ago)		
0000h	0027h	Alarm number in alarm history (seven alarms ago)		
0000h	0028h	Alarm number in alarm history (eight alarms ago)		
0000h	0029h	Alarm number in alarm history (nine alarms ago)		
0000h	002Ah	Alarm number in alarm history (ten alarms ago)		
0000h	002Bh	Alarm number in alarm history (eleven alarms ago)		
0000h	002Ch	Alarm number in alarm history (twelve alarms ago)		
0000h	002Dh	Alarm number in alarm history (thirteen alarms ago)		
0000h	002Eh	Alarm number in alarm history (fourteen alarms ago)		
0000h	002Fh	Alarm number in alarm history (fifteen alarms ago)		

Code No.		Item/function	Reading data content (Servo amplifier → Master station)	
RWwn5	RWwn4		RWrnC	RWrnD
0000h	0030h	Alarm occurrence time in alarm history (latest alarm)	Returns the occurrence time of the alarm that occurred before.	Always 0
0000h	0031h	Alarm occurrence time in alarm history (one alarm ago)		
0000h	0032h	Alarm occurrence time in alarm history (two alarms ago)		
0000h	0033h	Alarm occurrence time in alarm history (three alarms ago)		
0000h	0034h	Alarm occurrence time in alarm history (four alarms ago)		
0000h	0035h	Alarm occurrence time in alarm history (five alarms ago)		
0000h	0036h	Alarm occurrence time in alarm history (six alarms ago)		
0000h	0037h	Alarm occurrence time in alarm history (seven alarms ago)		
0000h	0038h	Alarm occurrence time in alarm history (eight alarms ago)		
0000h	0039h	Alarm occurrence time in alarm history (nine alarms ago)		
0000h	003Ah	Alarm occurrence time in alarm history (ten alarms ago)		
0000h	003Bh	Alarm occurrence time in alarm history (eleven alarms ago)		
0000h	003Ch	Alarm occurrence time in alarm history (twelve alarms ago)		
0000h	003Dh	Alarm occurrence time in alarm history (thirteen alarms ago)		
0000h	003Eh	Alarm occurrence time in alarm history (fourteen alarms ago)		
0000h	003Fh	Alarm occurrence time in alarm history (fifteen alarms ago)		
0000h	0040h	Input device status 0 Reads the status (OFF/ON) of input devices.	Bit 0 to bit F indicate the OFF/ON status of the corresponding input devices. 0: Servo-on 1: Forward rotation start 2: Reverse rotation start 3 to 7: For manufacturer setting 8: Monitor output execution demand 9: Instruction code execution demand A to C: For manufacturer setting D: Speed acceleration/deceleration selection E to F: For manufacturer setting	Always 0
0000h	0041h	Input device status 1 Reads the status (OFF/ON) of input devices.	Bit 0 to bit F indicate the OFF/ON status of the corresponding input devices. 0: Upper stroke limit*1 1: Lower stroke limit*1 2 to F: For manufacturer setting	Always 0
0000h	0042h	Input device status 2 Reads the status (OFF/ON) of input devices.	Bit 0 to bit F indicate the OFF/ON status of the corresponding input devices. 0: For manufacturer setting 1: Speed command execution demand 2 to 5: For manufacturer setting 6: Internal torque limit selection 7: Proportional control (PID control) 8: Gain switching 9: For manufacturer setting A: Speed specifying method selection B to F: For manufacturer setting	Always 0

Code No.		Item/function	Reading data content (Servo amplifier → Master station)	
RWwn5	RWwn4		RWrnC	RWrnD
0000h	0043h	Input device status 3 Reads the status (OFF/ON) of input devices.	Bit 0 to bit F indicate the OFF/ON status of the corresponding input devices. 0 to 9: For manufacturer setting A: Reset B to F: For manufacturer setting	Always 0
0000h	0081h	Energization time Reads the energization time since shipment.	Returns the energization time [h].	Always 0
0000h	0082h	Power on frequency Reads the number of power-on times since shipment.	Returns the number of power-on times.	Always 0
0000h	00A0h	Load to motor inertia ratio Reads the estimated load to motor inertia ratio on the servo motor shaft.	Return unit [0.01 times] The load to motor inertia ratio is returned.	Always 0
0000h	00B0h	Home position within one-revolution (CYC0) Reads the cycle counter value of an absolute home position.	Return unit [pulse] Stores the lower 16 bits of the cycle counter value of the absolute home position (32-bit data).	Stores the upper 16 bits of the cycle counter value of the absolute home position.
0000h	00B2h	Home position multi-revolution data (ABS0) Reads the multi-revolution counter value of an absolute home position.	Return unit [rev] Returns the multi-revolution counter value.	Always 0
0000h	00C0h	Error parameter No./Point data No. reading Reads the parameter No. and point table No. that have an error.		Always 0
0000h	0100h to 011Fh	Monitor multiplying factor Reads the multiplying factor of data to be read with a monitor code. The instruction codes 0100h to 011Fh correspond to each of the monitor codes 0000h to 001Fh. To the instruction code that has no corresponding monitor code, "0000h" is applied.	0000: × 1 0001: × 10 0002: × 100 0003: × 1000	Always 0
0000h	0200h	Parameter group reading Reads the parameter group written with the code No. 8200h.		Always 0

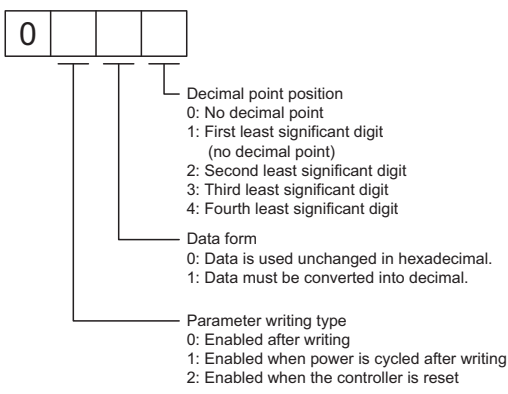
Code No.		Item/function	Reading data content (Servo amplifier → Master station)	
RWwn5	RWwn4		RWrnC	RWrnD
0000h	0201h to 02FFh	Parameter data reading Reads the setting values of the parameters in the group read with the code No. 0200h. The lower two digits of the code No. which are converted to decimal correspond to the parameter No.	Stores the lower 16 bits of the setting value of the requested parameter No.	Stores the upper 16 bits of the setting value of the requested parameter No.
0000h	0301h to 03FFh	Data form of parameter Reads the data form of the parameter numbers in the group read with the code No. 0200h. The lower two digits of the code No. which are converted to decimal correspond to the parameter No.	Stores the data form of the requested parameter No.  	Always 0
0000h	0601h to 06FFh	Servo motor speed of point table No. 1 to 255 The lower two digits of the code No. which are converted to decimal correspond to the point table No.	Stores the lower 16 bits of the servo motor speed of the requested point table No.	Stores the upper 16 bits of the servo motor speed of the requested point table No.
0000h	0701h to 07FFh	Acceleration time constant of point table No. 1 to 255 The lower two digits of the code No. which are converted to decimal correspond to the point table No.	Stores the acceleration time constant of the requested point table No.	Always 0
0000h	0801h to 08FFh	Deceleration time constant of point table No. 1 to 255 The lower two digits of the code No. which are converted to decimal correspond to the point table No.	Stores the deceleration time constant of the requested point table No.	Always 0

\*1 The setting of [Pr. PD41] enables switching between indicating the state of input (LSP/LSN) from the servo amplifier and the state of input (RY (n + 1) 0/RY (n + 1) 1) from the controller. When it is set to input to the servo amplifier, bit 0 and bit 1 of setting value [Pr. PA14 Rotation direction selection/travel direction selection] are interchanged.

## ■Writing instruction code

Data requested to be written with the instruction codes 8000h to 91FFh is written to the servo amplifier.

Set the instruction code No. corresponding to the item in instruction code (RWwn4 and RWwn5) and the data to be written in writing data (RWwnC and RWwnD). The instruction code No. and response data are all hexadecimal.

Setting any instruction code No. that is not given in this section will store an error code ( \_ \_ 1 \_ ) in respond code (RWrn4).

Code No.		Item/function	Writing data content (Servo amplifier → Master station)	
RWwn5	RWwn4		RWwnC	RWwnD
0000h	8010h	Alarm reset command Clears the alarm that is currently occurring.	1EA5h	Set to "0000h".
0000h	8101h	Feedback pulse value display data clear command Resets the display data of the status display "Cumulative feedback pulses" to "0".	1EA5h	Set to "0000h".

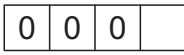
Code No.		Item/function	Writing data content (Servo amplifier → Master station)	
RWwn5	RWwn4		RWwnC	RWwnD
0000h	8200h	<p>Writing command of parameter group</p> <p>Writes the group of the parameter to write with code No. 8201h to 82FFh and 8301h to 83FFh.</p> <p>Writes the group of the parameter to read with code No. 0201h to 02FFh and 0301h to 03FFh.</p>	 <p>Parameter group</p> <ul style="list-style-type: none"> <li>0: [Pr. PA__]</li> <li>1: [Pr. PB__]</li> <li>2: [Pr. PC__]</li> <li>3: [Pr. PD__]</li> <li>4: [Pr. PE__]</li> <li>5: [Pr. PF__]</li> <li>6 to A: For manufacturer setting</li> <li>B: [Pr. PL__]</li> <li>C: [Pr. PT__]</li> <li>E: [Pr. PN__]</li> </ul>	Set to "0000h".
0000h	8201h to 82FFh	<p>Data RAM command of parameter</p> <p>Writes the setting values of the parameters in the group written with code No. 8200h to the RAM. This setting value is cleared when the power supply is shut off.</p> <p>The lower two digits of the code No. which are converted to decimal correspond to the parameter No.</p> <p>An error code is returned if a value outside the range of a parameter is written.</p>	Set the lower 16 bits of the parameter setting value.	<p>Set the upper 16 bits of the parameter setting value.</p> <p>Set the 16-bit parameter to "0000h" if it has a positive sign.</p> <p>Set it to "FFFFh" if it has a negative sign.</p> <p>Set the 16-bit parameter to "0000h" if it has no sign.</p>
0000h	8301h to 83FFh	<p>Data EEPROM command of parameter</p> <p>Writes the setting values of the parameters in the group written with code No. 8200h to the EEPROM. The setting value written in the EEPROM is held even when the power supply is shut off.</p> <p>The lower two digits of the code No. which are converted to decimal correspond to the parameter No.</p> <p>An error code is returned if a value outside the range of a parameter is written.</p>	Set the lower 16 bits of the parameter setting value.	<p>Set the upper 16 bits of the parameter setting value.</p> <p>Set the 16-bit parameter to "0000h" if it has a positive sign.</p> <p>Set it to "FFFFh" if it has a negative sign.</p> <p>Set the 16-bit parameter to "0000h" if it has no sign.</p>
0000h	8601h to 86FFh	<p>Servo motor speed data RAM command of point table</p> <p>Writes the servo motor speed of point table No. 1 to 255 to the RAM. This setting value is cleared when the power supply is shut off.</p> <p>The lower two digits of the code No. which are converted to decimal correspond to the point table No.</p>	Set the lower 16 bits of the servo motor speed.	Set the upper 16 bits of the servo motor speed.
0000h	8701h to 87FFh	<p>Acceleration time constant data RAM command of point table</p> <p>Writes the acceleration time constant of point table No. 1 to 255 to the RAM. This setting value is cleared when the power supply is shut off.</p> <p>The lower two digits of the code No. which are converted to decimal correspond to the point table No.</p>	Set the acceleration time constant.	Set to "0000h".

Code No.		Item/function	Writing data content (Servo amplifier → Master station)	
RWwn5	RWwn4		RWwnC	RWwnD
0000h	8801h to 88FFh	Deceleration time constant data RAM command of point table Writes the deceleration time constant of point table No. 1 to 255 to the RAM. This setting value is cleared when the power supply is shut off. The lower two digits of the code No. which are converted to decimal correspond to the point table No.	Set the deceleration time constant.	Set to "0000h".
0000h	8D01h to 8DFFh	Servo motor speed data EEPROM command of point table Writes the servo motor speed of point table No. 1 to 255 to the EEPROM. The setting value written in the EEPROM is held even when the power supply is shut off. The lower two digits of the code No. which are converted to decimal correspond to the point table No.	Set the lower 16 bits of the servo motor speed.	Set the upper 16 bits of the servo motor speed.
0000h	8E01h to 8EFFh	Acceleration time constant data EEPROM command of point table Writes the acceleration time constant of point table No. 1 to 255 to the EEPROM. The setting value written in the EEPROM is held even when the power supply is shut off. The lower two digits of the code No. which are converted to decimal correspond to the point table No.	Set the acceleration time constant.	Set to "0000h".
0000h	8F01h to 8FFFh	Deceleration time constant data EEPROM command of point table Writes the deceleration time constants of point table No. 1 to 255 to the EEPROM. The setting value written in the EEPROM is held even when the power supply is shut off. The lower two digits of the code No. which are converted to decimal correspond to the point table No.	Set the deceleration time constant.	Set to "0000h".

## Respond code (RWrn4)

The respond code is the same as the positioning mode (point table method).

 Page 43 Respond code (RWrn4)

## Data communication timing chart

The data communication timing charts for the speed control mode (point table method) are the same as those for the positioning mode (point table method).

 Page 44 Data communication timing chart



## 6.2 Switching power on for the first time

### Point

To use the servo amplifier in the I/O mode, set [Pr. PN03] to " \_ \_ \_ 1". In addition, the GX Works setting is required. For the GX Works setting, refer to section 4.1 of "MR-J4-\_GF\_(-RJ) Servo Amplifier Instruction Manual (Motion Mode)".

When switching the power on for the first time, follow this section to make a startup.

#### 1. Wiring check

Check whether the servo amplifier and servo motor are wired correctly by visual inspection, the DO forced output function (section 4.5 of "MR-J4-\_GF\_(-RJ) Servo Amplifier Instruction Manual (Motion Mode)"), etc. (Refer to section 4.1 of "MR-J4-\_GF\_(-RJ) Servo Amplifier Instruction Manual (Motion Mode)").

#### 2. Surrounding environment check

Check the surrounding environment of the servo amplifier and servo motor. (Refer to section 4.1 of "MR-J4-\_GF\_(-RJ) Servo Amplifier Instruction Manual (Motion Mode)").

#### 3. Station No. setting

Set the station number with the station number setting rotary switch (SW2/SW3). (Refer to section 4.3 of "MR-J4-\_GF\_(-RJ) Servo Amplifier Instruction Manual (Motion Mode)").

#### 4. Parameter setting

Set the parameters as necessary, such as the used operation mode and regenerative option selection. (Page 125 PARAMETERS)

Set [Pr. PD41] to " \_ 0 \_ \_" (Stroke limit always enabled).

To input a stroke limit by using the link device, set [Pr. PD41] to "1 \_ \_ \_" (input from controller).

Hereafter, instructions are provided in a case where the input from the controller is selected. When [Pr. PD41] is set to "0 \_ \_ \_" (input from servo amplifier), read the words "upper stroke limit" and "lower stroke limit" as "LSP" and "LSN", respectively.

#### 5. Test operation of the servo motor alone in JOG operation of test operation mode

With the servo motor disconnected from the machine, perform test operation mode at the slowest speed to check whether the servo motor rotates correctly. For the test operation mode, refer to section 4.5 of "MR-J4-\_GF\_(-RJ) Servo Amplifier Instruction Manual (Motion Mode)".

#### 6. Test operation of the servo motor alone by commands

Make sure that the servo motor rotates in the following procedure.

① Switch on EM2 (Forced stop 2) and RYn0 (Servo-on). When the servo amplifier is in a servo-on status, RXn0 (Ready) switches on.

② Switch on RY (n + 1) 0 (Upper stroke limit) and RY (n + 1) 1 (Lower stroke limit).

③ When a speed command is input from the controller and RYn1 (Forward rotation start) or RYn2 (Reverse rotation start) is switched on, the servo motor starts rotating. Operate the servo motor with a low speed command at first, then check the servo motor rotation direction. If the machine does not operate in the intended direction, check the input signal.

#### 7. Test operation with the servo motor and machine connected

Make sure that the servo motor rotates in the following procedure.

① Switch on EM2 (Forced stop 2) and RYn0 (Servo-on). When the servo amplifier is in a servo-on status, RXn0 (Ready) switches on.

② Switch on RY (n + 1) 0 (Upper stroke limit) and RY (n + 1) 1 (Lower stroke limit).

③ When a speed command is input from the controller and RYn1 (Forward rotation start) or RYn2 (Reverse rotation start) is switched on, the servo motor starts rotating. Operate the servo motor with a low speed command at first, then check the conditions such as the operation direction of the machine. If the machine does not operate in the intended direction, check the input signal. In the status display, check for any problems of the servo motor speed, load ratio, etc.

**8.** Gain adjustment

Make gain adjustment to optimize the machine motions. (Refer to chapter 6 of "MR-J4-\_GF\_(-RJ) Servo Amplifier Instruction Manual (Motion Mode)".)

**9.** Actual operation

**10.** Stop

Stop giving commands and stop operation.

## 6.3 Speed control mode (point table method)

This section explains how to operate the speed control mode (point table method) of the I/O mode.

The valid speed command data is shown in the table below.

Whether the speed command execution demand (RY (n + 2) 1) is used	Speed specifying method selection (RY (n + 2) A)	"Reflection timing selection for the speed specifying data in the speed control mode (point table method)" in [Pr. PT62]		"Speed specifying method selection in the speed control mode (point table method)" in [Pr. PT62]		Timing chart reference
		Setting value	Description	Setting value	Description	
Not used	Off	—	Always reflected regardless of the input status of the speed command execution demand (RY (n + 2) 1).	—	Specify a point table No. in "Speed selection" (RWwn7).	(1) Operating method which does not use the speed command execution demand
Used	On	0	Reflected when the speed command execution demand (RY (n + 2) 1) is turned on.	0	Specify a point table No. in "Speed command data/speed selection" (RWwnA).	(2) (a) Operating method which reflects the speed command data at the edge of when the speed command execution demand is turned on
				1	Specify a speed command data in "Speed command data/speed selection" (RWwnA and RWwnB).	
		1	Always reflected while the speed command execution demand (RY (n + 2) 1) is being turned on.	0	Specify a point table No. in "Speed command data/speed selection" (RWwnA).	(2) (b) Operating method which always reflects the speed command data while the speed command execution demand is being turned on
				1	Specify a speed command data in "Speed command data/speed selection" (RWwnA and RWwnB).	

# Operating method which does not use the speed command execution demand

Turn off RY (n + 2) A (Speed specifying method selection).

Specifying a point table No. in RWwn7 (Speed selection) operates the servo motor at the speed set in the point table.

Set the servo motor speed in the point table in advance.

## Operation sequence

- Forward rotation start and reverse rotation start input

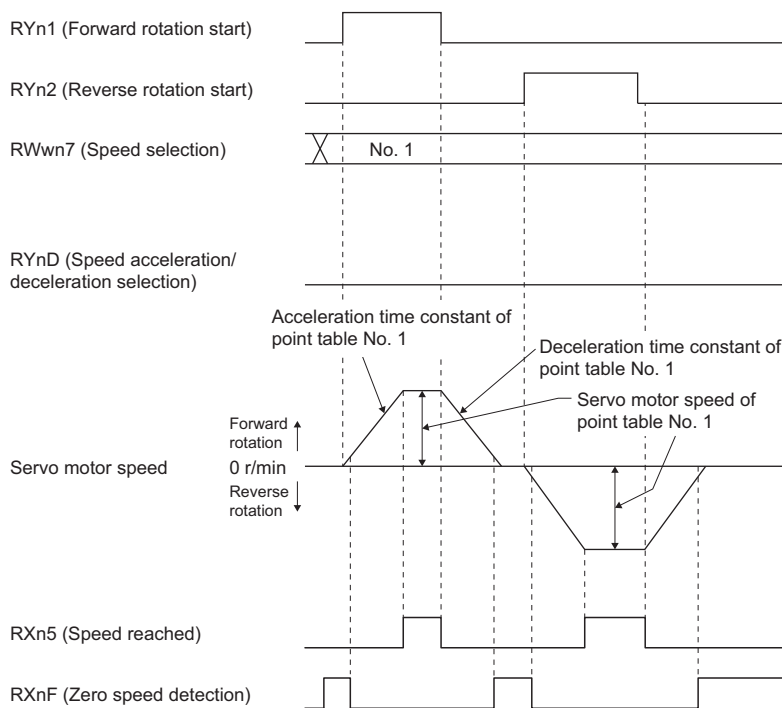

- Speed selection changed during the servo motor rotation

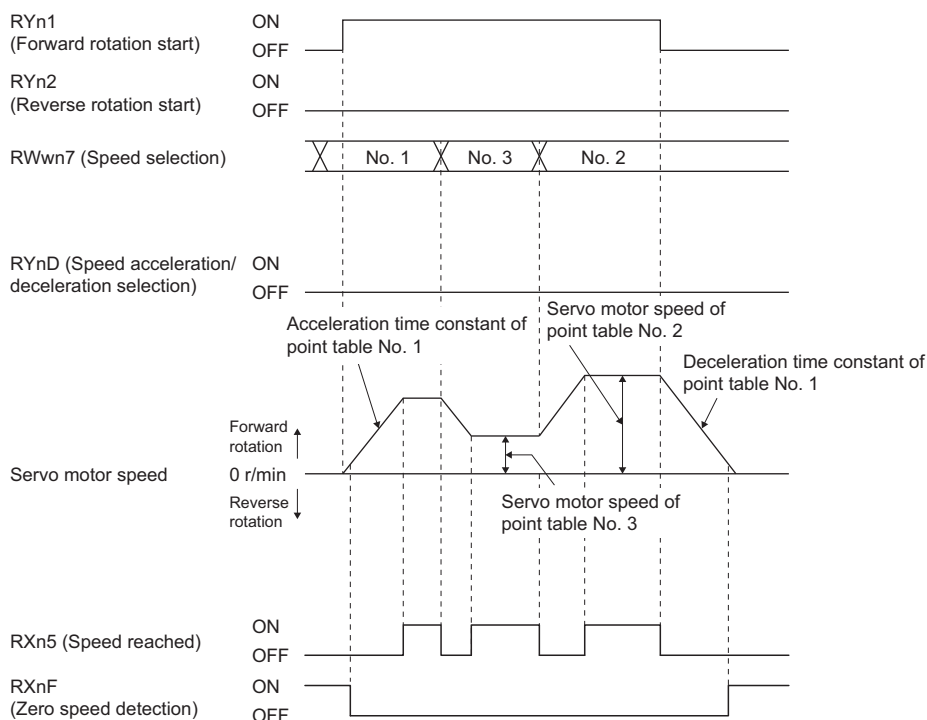

• Speed acceleration/deceleration selection switched

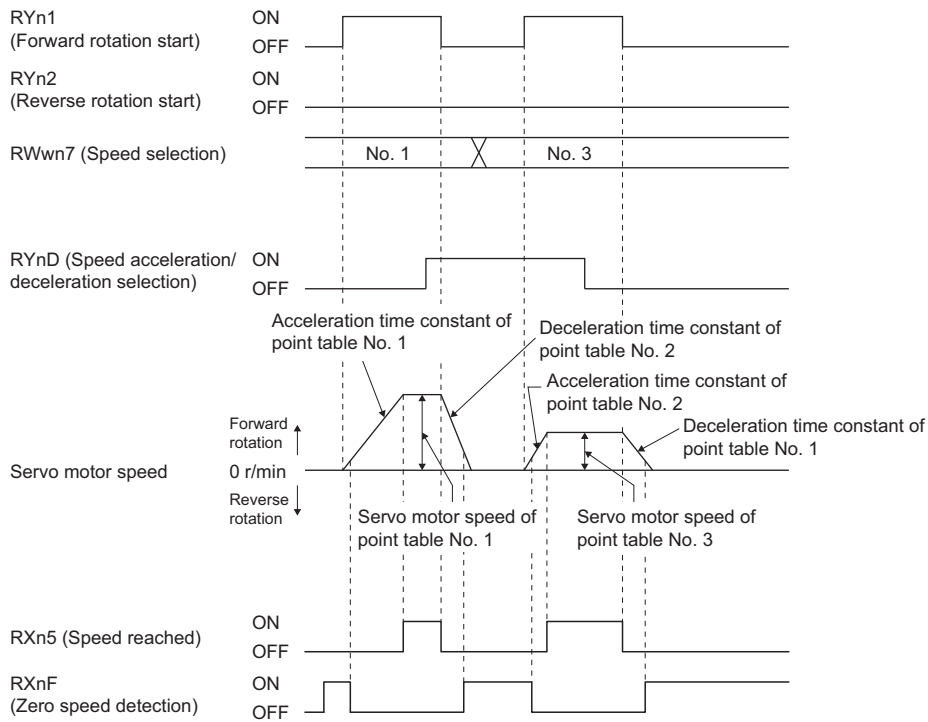

# Operating method which uses the speed command execution demand

Turn on RY (n + 2) A (Speed specifying method selection).

The speed specifying method can be selected with the setting of [Pr. PT62] "\_ x \_ \_".

- When using speed data of point tables ("\_ 0 \_ \_" in [Pr. PT62])

Specifying a point table No. in RWwnA (Point table No./speed specifying data lower 16 bits) operates the servo motor at the speed set in the point table.

Set the servo motor speed in the point table in advance.

- When setting a servo motor speed directly ("\_ 1 \_ \_" in [Pr. PT62])

Setting the servo motor speed in RWwnA (Point table No./speed specifying data lower 16 bits) and RWwnB (Speed specifying data upper 16 bits) operates the servo motor at the set speed.

The reflecting timing of the speed specifying data can be selected with the setting of [Pr. PT62] "x \_ \_ \_".

## Operation sequence

### ■ Operating method which reflects the speed command data at the edge of when the speed command execution demand is turned on ("0 \_ \_ \_" in [Pr. PT62])

- Forward rotation start and reverse rotation start input

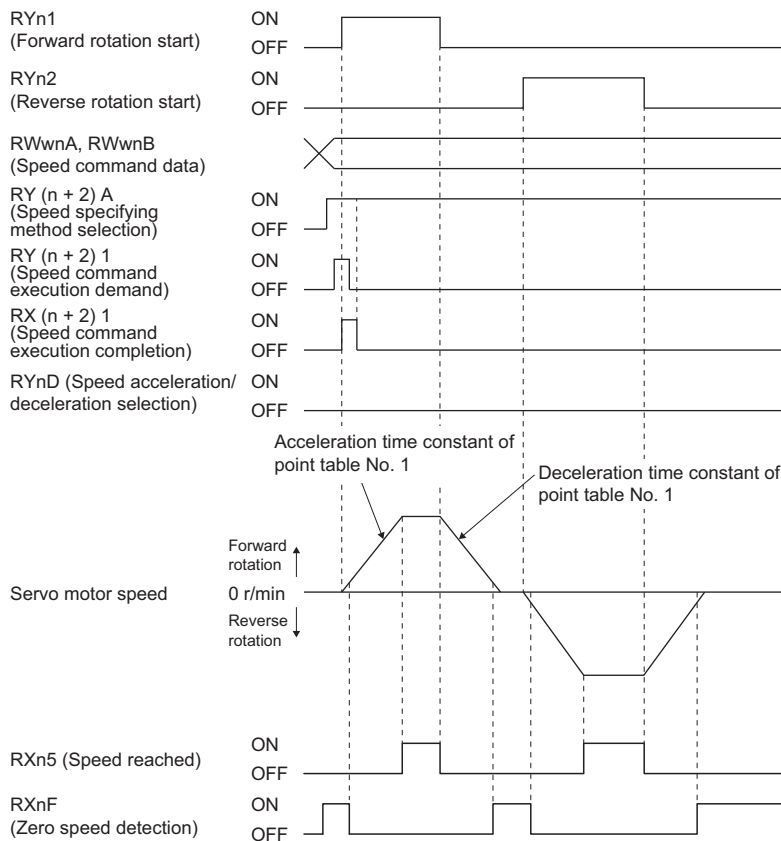

• Speed selection changed during the servo motor rotation

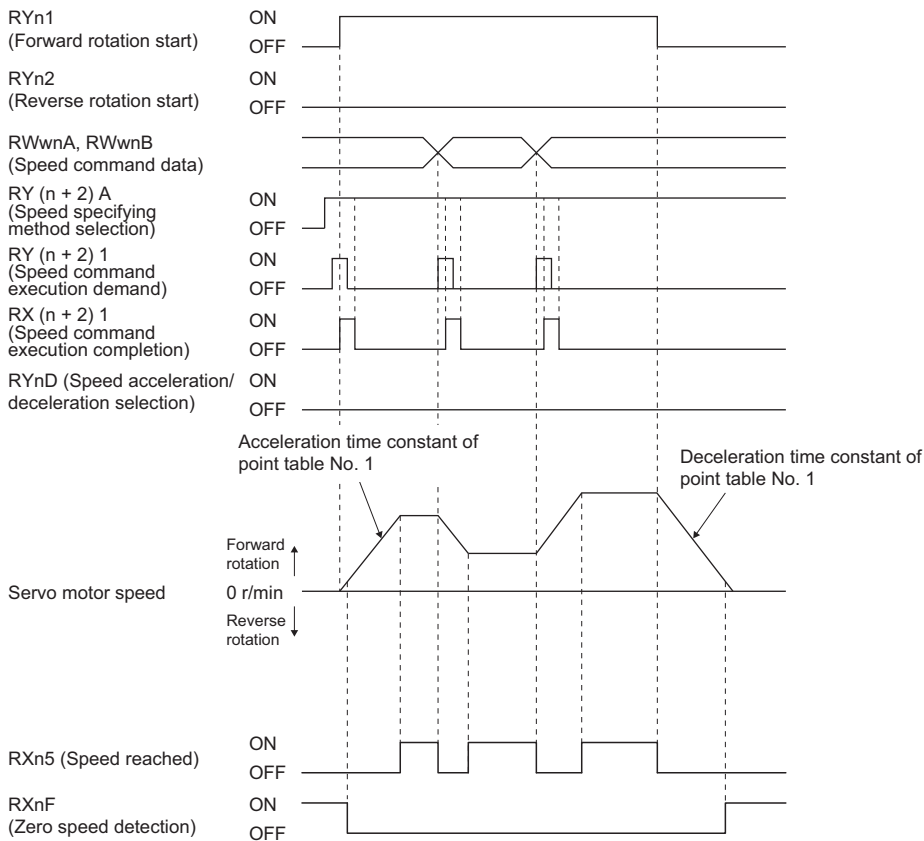

• Speed acceleration/deceleration selection switched

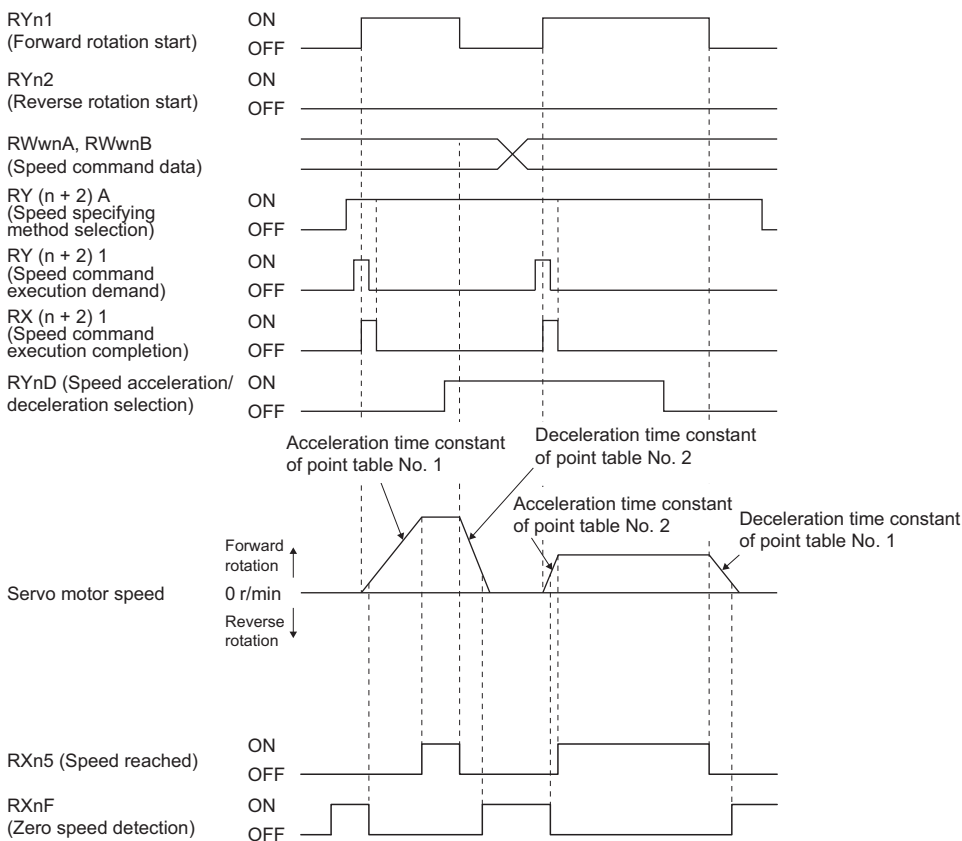

**■ Operating method which always reflects the speed command data while the speed command execution demand is being turned on ("1 \_ \_ \_" in [Pr. PT62])**

- Forward rotation start and reverse rotation start input

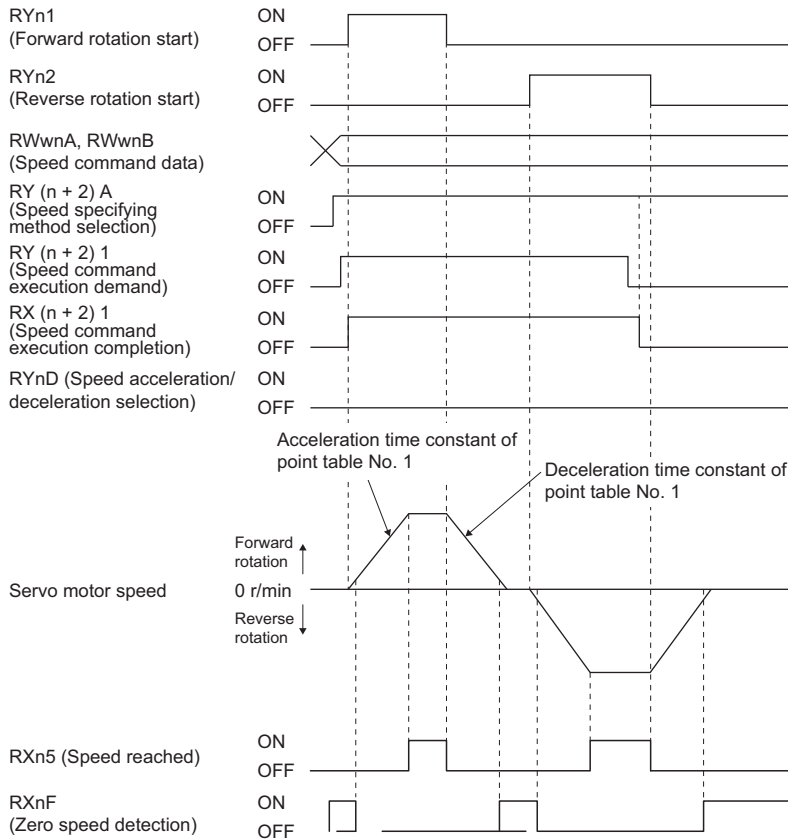

- Speed selection changed during the servo motor rotation

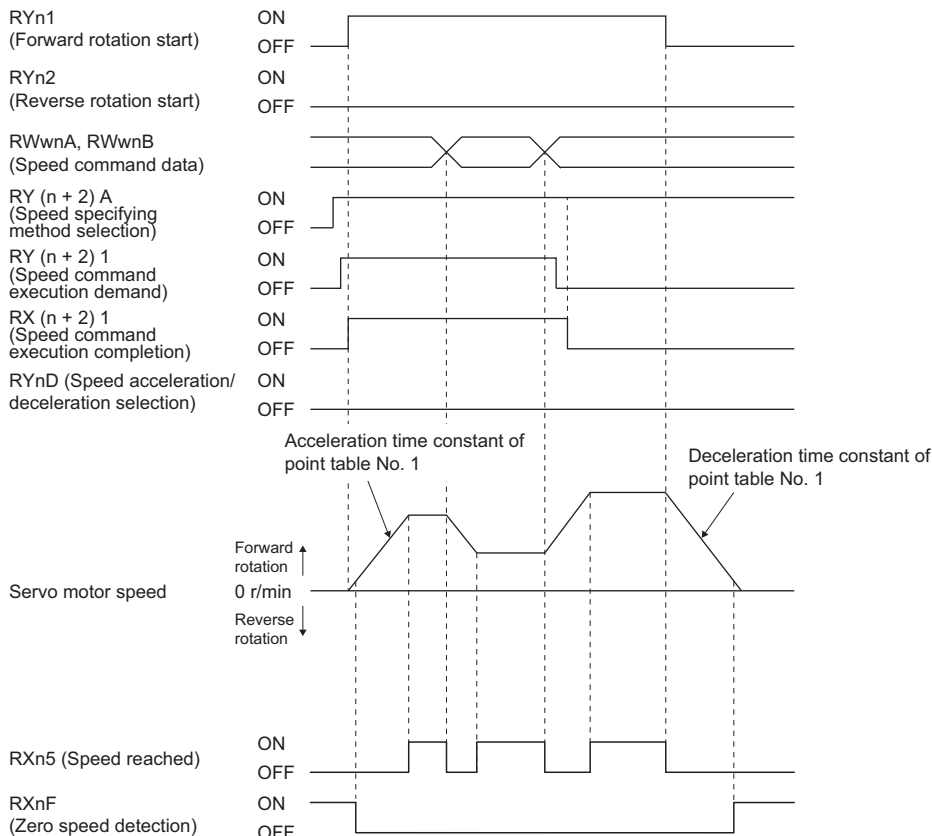



• Speed acceleration/deceleration selection switched

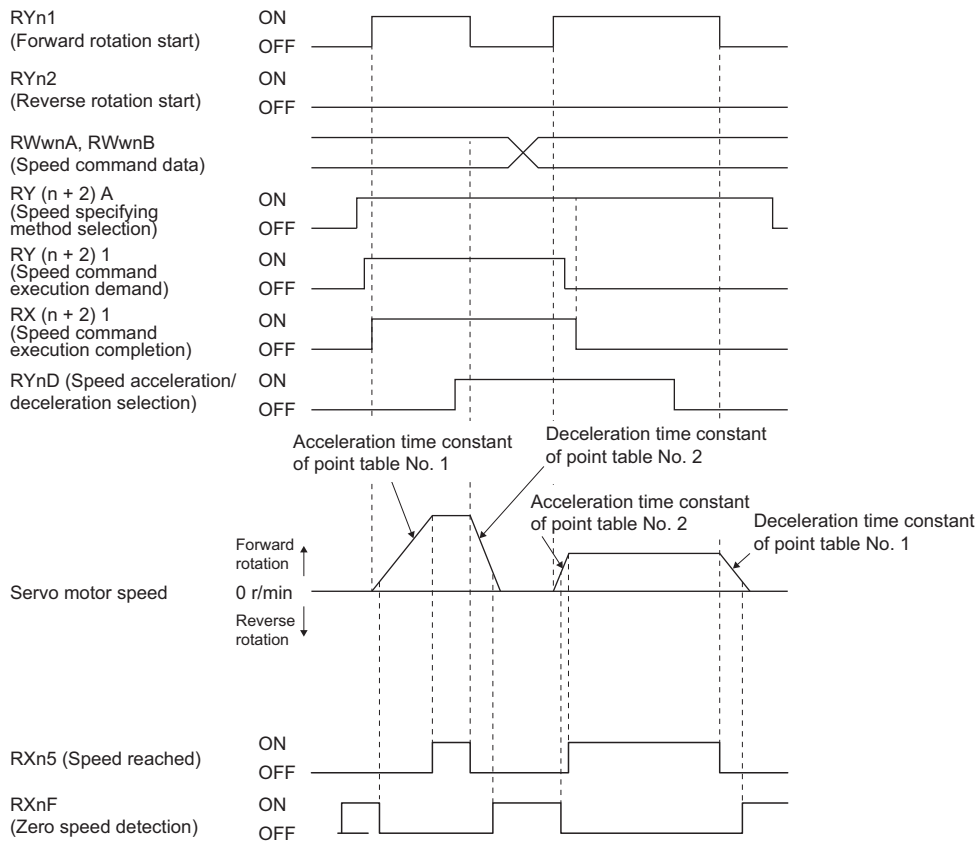

# 7 APPLICATION OF FUNCTIONS

This chapter explains application of using servo amplifier functions.

## 7.1 Simple cam function

### CAUTION

- Note that the number of write times to the Flash-ROM where the cam data is stored is limited to approximately 10000. If the total number of write times exceeds 10000, the servo amplifier may malfunction when the Flash-ROM reaches the end of its useful life.

#### Point

- The simple cam function is available with servo amplifiers with software version A3 or later.
- The simple cam function can be used with the point table method.
- This function is not available with the servo amplifier to which the MR-D30 unit has been connected.
- When writing cam data and cam control data, do so after switching to test operation mode or after network communication is established between the servo amplifier and controller.
- When [AL. F5.2 Cam data miswriting warning] occurs during cam data writing, set [Pr. PT34] to "5010" to initialize the cam data.
- When using simple cam function, execute operation so that the machine speed of the input axis is less than "[Cam control data No. 48 - Cam axis one cycle length] × 1/2 × 1000 [command unit/s]".
- When [Cam control data No. 30] is set to "1", the unit of the cam axis length per cycle will be changed to [mm], [inch], [degree], or [pulse] by the setting of [Pr. PT01]. When [Cam control data No. 30] is set to "2", the unit of the cam axis length per cycle will be changed to [mm], [inch], [degree], or [pulse] by the setting of [Cam control data No. 14].

### Outline of simple cam function

Simple cam function enables synchronous control by using software instead of controlling mechanically with cam. The following shows a movement trajectory when the cam below is used and the input axis is rotated once.

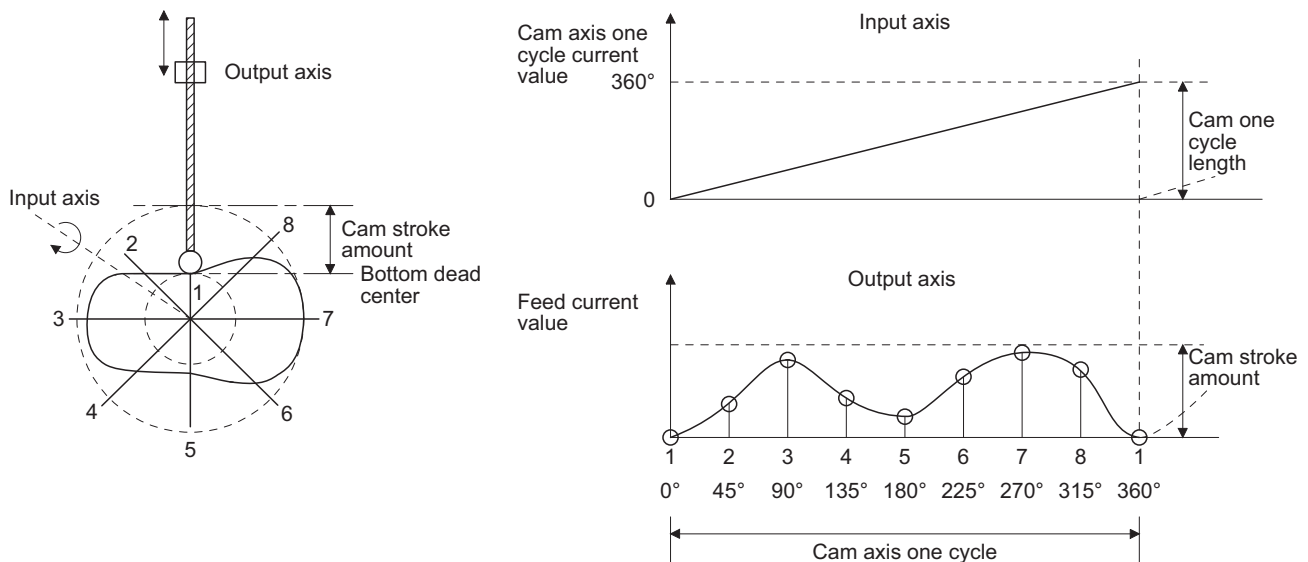

By setting cam data and cam control data, the simple cam function enables synchronous control with an input axis (synchronous encoder input or point table command) with a start of positioning.

# Simple cam function block

The function block diagram of the simple cam is shown below. Use MR Configurator2 to set the cam data and the cam control data.

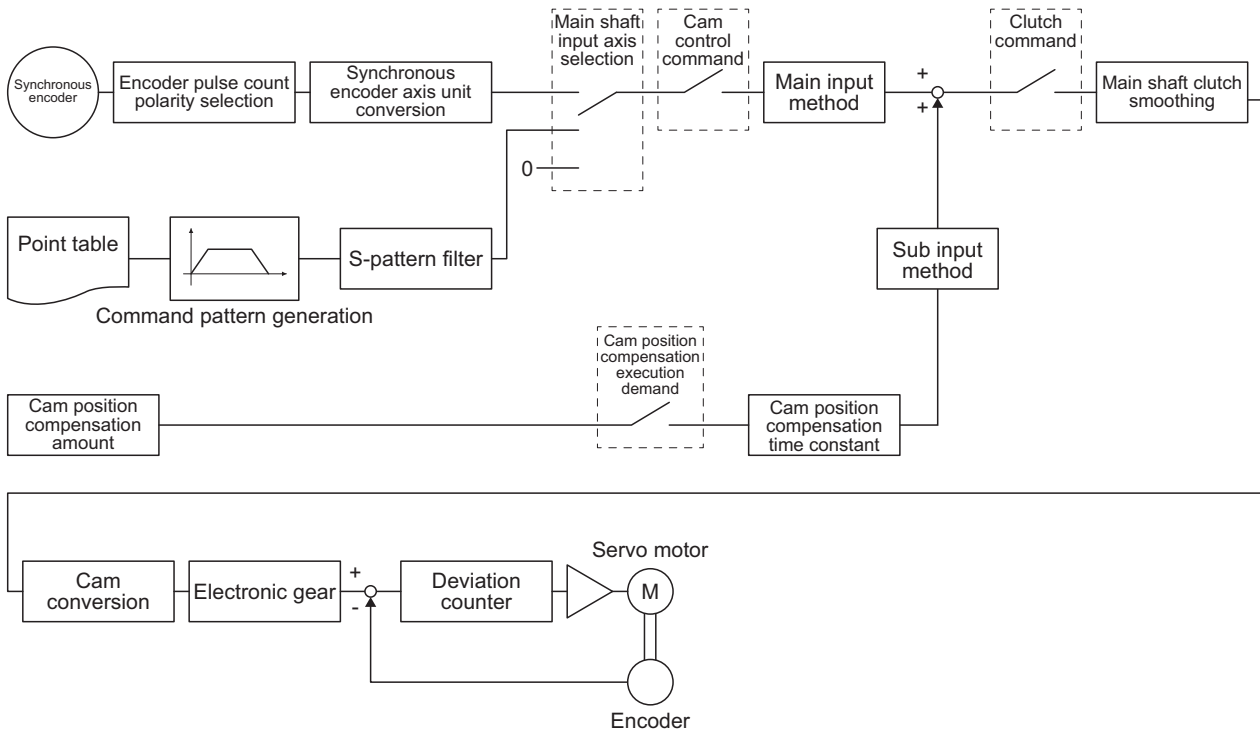

# Simple cam specification list

## Specification list

Item		MR-J4-_GF_-RJ	
Memory capacity <sup>*1</sup>	Storage area for cam data	8 Kbytes (Flash-ROM)	
	Working area for cam data	8 Kbytes (RAM)	
Number of registration		Max. 8	
Comment		Max. 32 single-byte characters for each cam data	
Cam data and cam control data	Stroke ratio data type	Cam resolution	256/512/1024/2048
		Stroke ratio [%]	-100.000 to 100.000
	Coordinate data type	Number of coordinate	2 to 1024
		Coordinate data	Input value: 0 to 999999 Output value: -999999 to 999999
Cam curve		12 types (constant speed/constant acceleration/5th curve/single hypotenuse/cycloid/distorted trapezoid/distorted sine/distorted constant speed/trapezoid/reverse trapezoid/double hypotenuse/reverse double hypotenuse)	

\*1 The memory capacity includes a use area (storage area for cam data) for storing in the servo amplifier and an actual operation area (working area for cam data).

## Cam resolution

### ■Stroke ratio data type

Cam resolution	Max. number of registration
256	8
512	4
1024	2
2048	1

### ■Coordinate data type

Number of coordinate	Max. number of registration
128	8
256	4
512	2
1024	1

# Control of simple cam function

The following three cam controls are available by setting the cam data and the cam control data with MR Configurator2.

Cam control method	Description	Actual movement
To-and-fro control	Reciprocates within a specified cam stroke.	<p>Cam data and cam control data</p> <p>The diagram shows a user-created cam profile (a sine wave) being processed into a trapezoidal 'Cam axis one cycle current value (Input)' and a corresponding 'Feed current value (Output)' that reciprocates within the cam's stroke.</p>
Feed control	Updates a cam standard position per cycle.	<p>Cam data and cam control data</p> <p>The diagram shows a user-created cam profile being processed into a trapezoidal 'Cam axis one cycle current value (Input)'. The 'Feed current value (Output)' is a sine wave that is vertically offset for each cycle. The offsets are labeled as 'Cam standard position (First cycle)', 'Cam standard position (Second cycle)', and 'Cam standard position (Third cycle)'.</p>
Linear control	Performs linear control to keep the one-cycle stroke ratio as 100 %.	<p>Cam data and cam control data</p> <p>The diagram shows a linear cam profile (a straight line) being processed into a trapezoidal 'Cam axis one cycle current value (Input)'. The 'Feed current value (Output)' is a sine wave that is vertically offset for each cycle. The offsets are labeled as 'Cam standard position (First cycle)', 'Cam standard position (Second cycle)', and 'Cam standard position (Third cycle)'. A note at the bottom right indicates 'Stroke amount × 100%'.</p>

# Operation in combination with the simple cam

## Encoder following function

The servo amplifier receives A/B-phase output signal from a synchronous encoder and starts the servo motor with the signal. Up to 4 Mpulses/s can be inputted from the synchronous encoder to use with the servo amplifier.

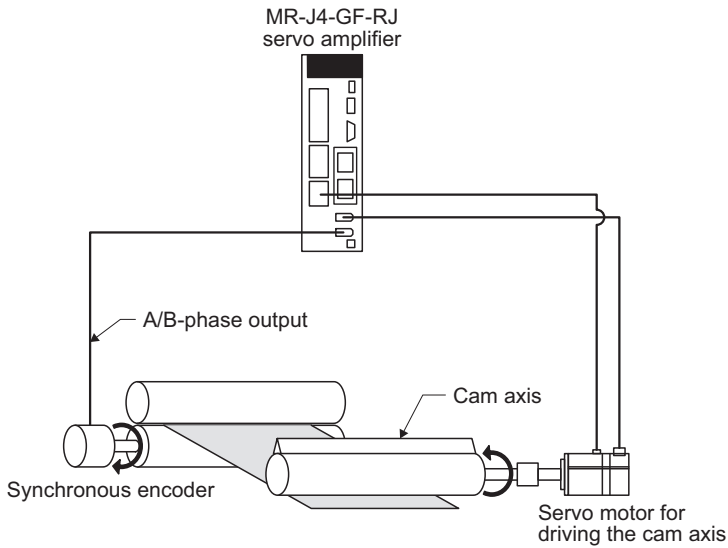

## Simple cam position compensation function

The servo amplifier receives input signals from the touch probe, calculates compensation, and compensates the position of the cam axis.

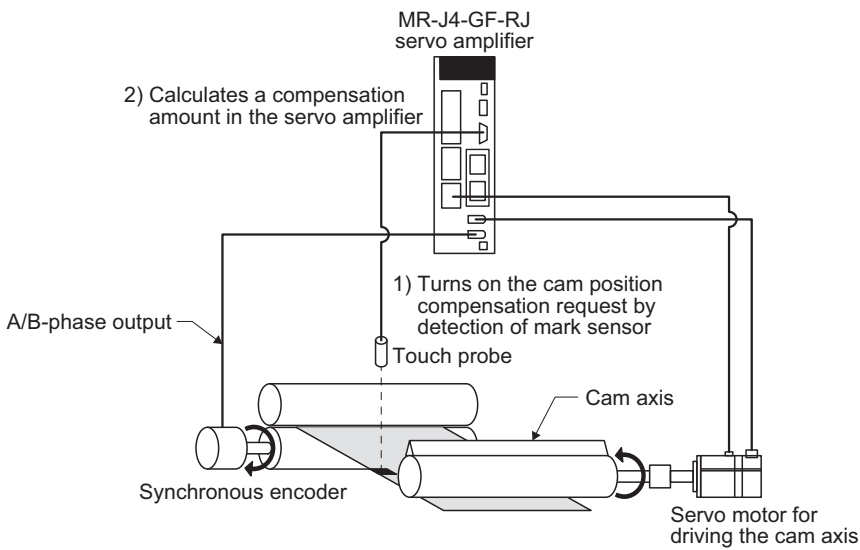

# Setting list

## List of items set with MR Configurator2

Set the following on the cam setting window of MR Configurator2.

Setting item		Setting
Cam control data	Main shaft input axis selection	Select a command input method for the cam axis. Select "synchronous encoder axis" or "servo input axis".
	Cam No. selection	Select the number to create the cam control data.
	Resolution setting	Set the cam resolution. Select from 256/512/1024/2048.
	Cam axis one cycle length	Set a travel distance of cam one cycle. Command unit is used as an input unit.
	Cam stroke amount	Set a cam stroke amount for the stroke ratio of 100 % when using the stroke ratio data type cam control.
Cam data		Create the cam data on the cam creating window of MR Configurator2. After the data is created, write the cam data to the servo amplifier.

## List of items set with parameters of the servo amplifier

Set the following with the parameters of the servo amplifier.

Setting item	Setting
Operation mode selection	Select "Positioning mode (point table method)" with [Pr. PA01 Operation mode].
Cam function setting	Enable the cam function with [Pr. PT35 Function selection T-5].
Cam data selection	Select the cam data to be executed with RWwnE (Cam No. setting). Selecting the cam data for execution is also possible with [Cam control data No. 49 - Cam No.].

# Data to be used with simple cam function

## CAUTION

- Note that the number of write times to the Flash-ROM where the cam control data and cam data are stored is limited to approximately 10000. If the total number of write times exceeds 10000, the servo amplifier may malfunction when the Flash-ROM reaches the end of its useful life. If data needs to be changed very frequently, use the temporal writing function and write the data to the RAM, not to the Flash-ROM.

## Memory configuration of cam control data and cam data

### Point

When [AL. F5.2 Cam data miswriting warning] occurs during cam data writing, set [Pr. PT34] to "5010" to initialize the cam data.

The cam control data and the cam data used for the simple cam are stored in Flash-ROM inside the servo amplifier. When the power is turned on, the cam data and the cam control data are copied from the Flash-ROM to the RAM inside the servo amplifier, and then cam control will be executed.

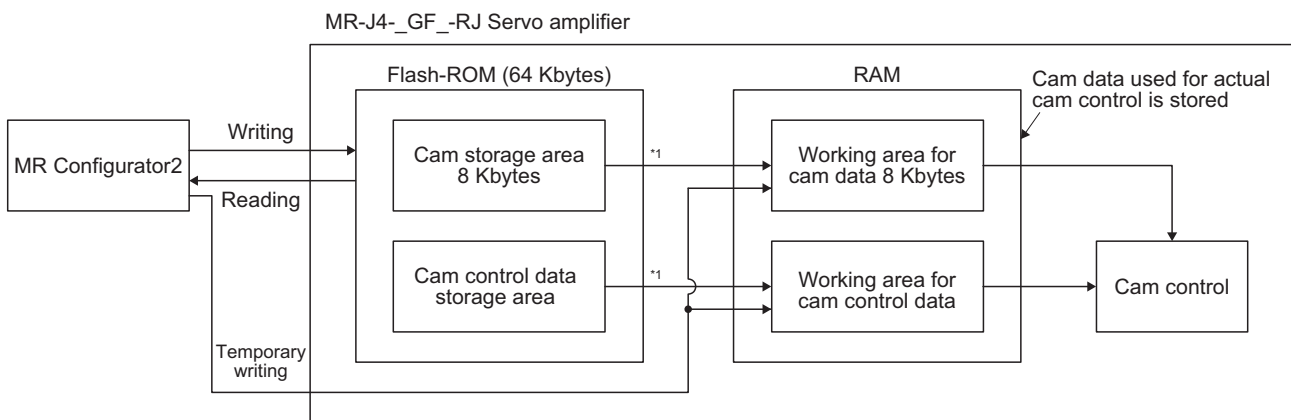

\*1 When the power is turned on, the cam data and the cam control data are copied from the Flash-ROM to the RAM.

Use MR Configurator2 to write the cam data and cam control data.  
Be sure to write the cam data and the cam control data in servo-off state.

Two writing methods are available.

Writing method	Description
Temporary writing	Write the cam control data and the cam data to the RAM of the servo amplifier. After writing, the cam control data and the cam data will be reflected. The written data will be disabled if the power is turned off. Use this when creating and adjusting the cam control data and the cam data.
Writing	Write the cam control data and the cam data to the Flash-ROM. The data will be enabled when the power is cycled after writing. After cycling the power, control is performed based on the written data. Conduct this after the cam control data and the cam data are finalized.



## Cam data

### Point

If the cam data is set incorrectly, the position command and speed command may increase and may cause machine interference or [AL. 31 Overspeed]. When you have created and changed cam data, make sure to perform test operations and make appropriate adjustments.

The following two types are available for the cam data.

Cam data type	Description
Stroke ratio data type	Cam curve of one cycle is divided equally by the number of cam resolution and defined. The cam curve will be created according to the stroke ratio data of the number of cam resolution.
Coordinate data type	Data in which cam curve of one cycle is defined with two or more points. The coordinate data is defined as (input value, output value). The input value will be the cam axis one cycle current value, and the output value will be the stroke value from the cam standard position.

### Stroke ratio data type

The following are set in the stroke ratio data type. Set the following items on the cam setting window of MR Configurator2. When "Cam No." is set to "0", straight-line control is performed so that the stroke ratio at the last point of the cam data becomes 100 %.

Setting item	Setting	Setting range
Cam No.	Set a Cam No.	0: Linear cam 1 to 8: User-created cam
Setting method	Set "1: Stroke ratio data type".	—
Cam resolution	Set the number of divisions for the cam curve of one cycle.	Select from 256/512/1024/2048.
Cam data start position	Set the positions of the cam data and cam control data to the position of when "Cam axis one cycle current value" is "0".	0 to "Cam resolution - 1"
Stroke ratio data	Set the stroke ratio from the first to the last point.	-100.000 to 100.000

The following is a setting example for "cam resolution = 512" in the stroke ratio data type.

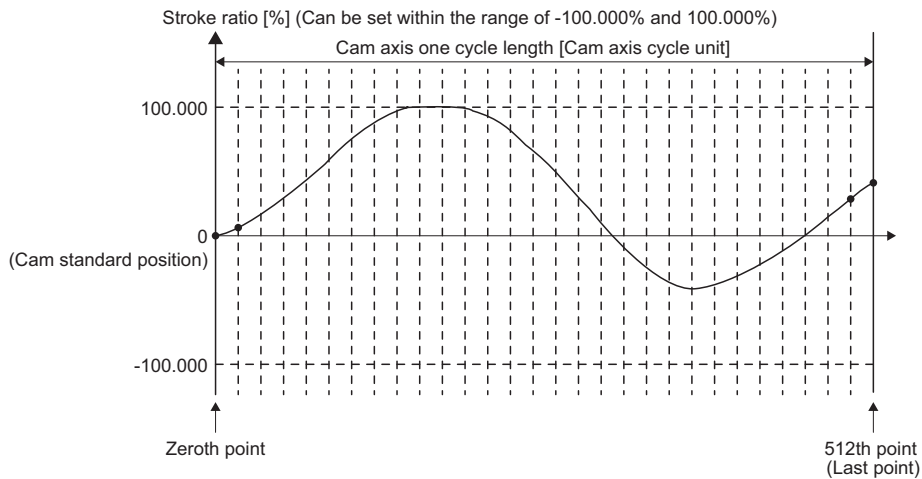

- Feed current value

The feed current value of the cam axis is calculated as follows:

$$\text{Feed current value} = \text{Cam standard position} + (\text{Cam stroke amount} \times \text{Stroke ratio to cam axis one cycle current value})$$

When the cam axis one cycle current value is in the middle of the specified stroke ratio data, the intermediate value is calculated using the cam data before and after the value.

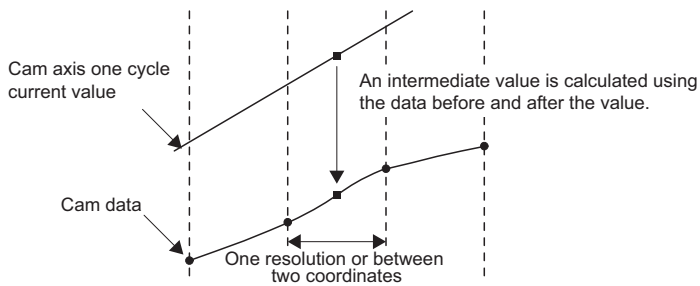

- Cam standard position

The cam standard position is calculated as follows:

$$\text{Cam standard position} = \text{The preceding cam standard position} + (\text{Cam stroke amount} \times \text{Stroke ratio at the last point})$$

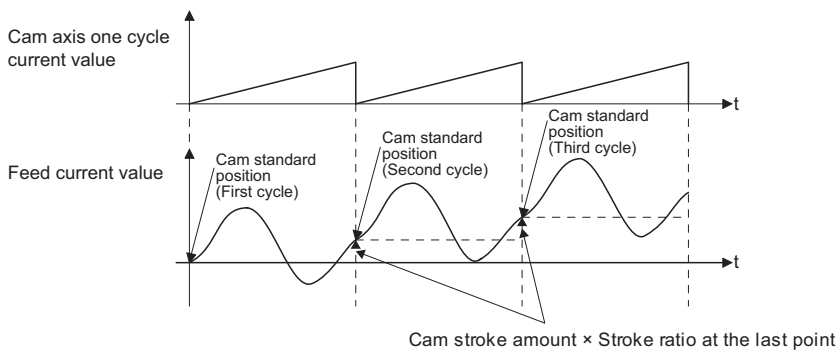

For to-and-fro control, create the cam data in which the stroke ratio at the last point is 0 %.

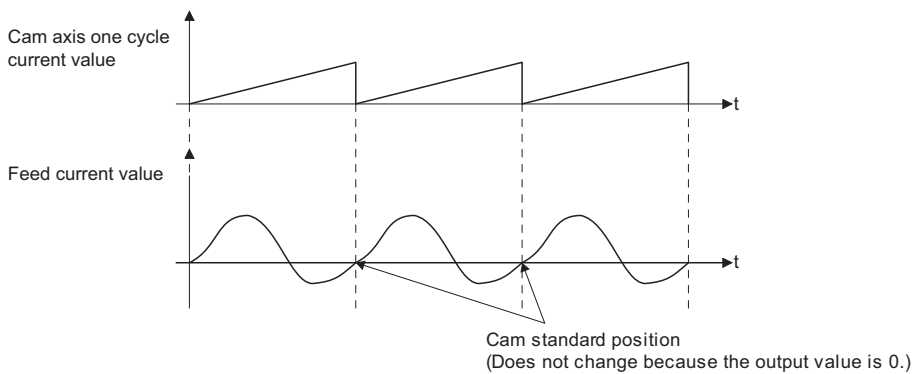

- Cam data start position

This setting is available only for the stroke ratio data type cam data.

The cam data position where the "cam axis one cycle current value" becomes "0" can be set as the cam data start position. The initial value of the cam data start position is "0". The cam axis is controlled with the cam data from the 0th point (stroke ratio = 0 %).

When a value other than "0" is set as the cam data start position, cam control is started from the point where the stroke ratio is not 0 %.

Set the cam data start position for each cam data within the setting range of "0 to (Cam resolution - 1)".

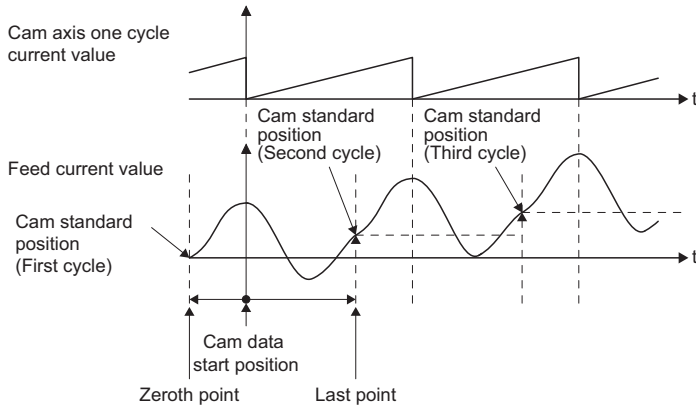

- Timing of applying cam control data

New values are applied to "Cam No." and "Cam stroke amount" when RY (n + 1) 3 (Cam control command) turns on.

"Cam standard position" is updated when "Cam axis one cycle current value" passes through the 0th point of the cam data.

## Coordinate data type

The following are set in the coordinate data type. Set the following items on the cam setting window of MR Configurator2. When "Cam No." is set to "0", straight-line control is performed so that the stroke ratio at the last point of the cam data becomes 100 %.

Setting item	Setting	Setting range
Cam No.	Set a Cam No.	0: Linear cam 1 to 8: User-created cam
Setting method	Set "2: Coordinate data type".	—
Number of coordinate	Set the number of coordinates for the cam curve of one cycle. The number of coordinates includes 0th point.	2 to 1024
Cam data start position	Setting is not necessary.	—
Coordinate data	Set the coordinate data (input value $X_n$ and output value $Y_n$ ) for the number of coordinates. Set from the 0th coordinate data ( $X_0$ and $Y_0$ ). Set an input value larger than that of the coordinate data.	-999.999 to 999.999

The following is a setting example for the coordinate data type.

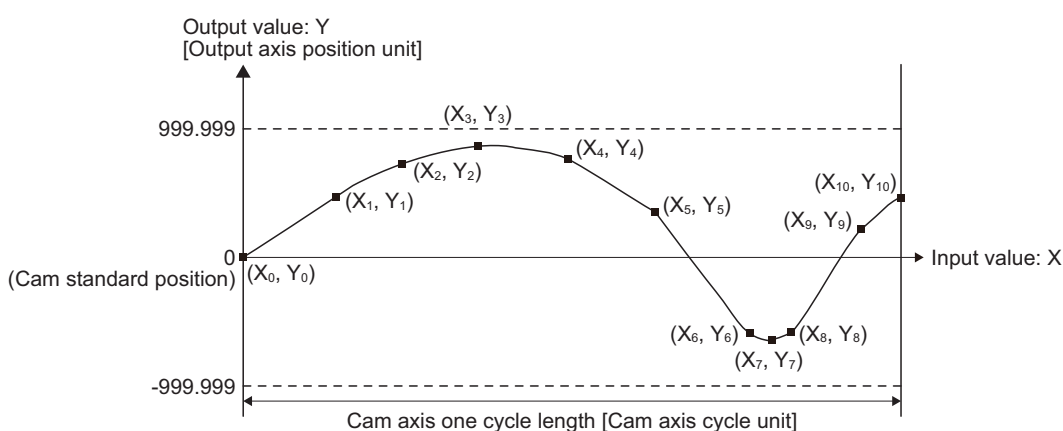

If "input value = 0" and "input value = cam axis one cycle length" are not set in the coordinate data, a control is executed by the line created from the closest two points.

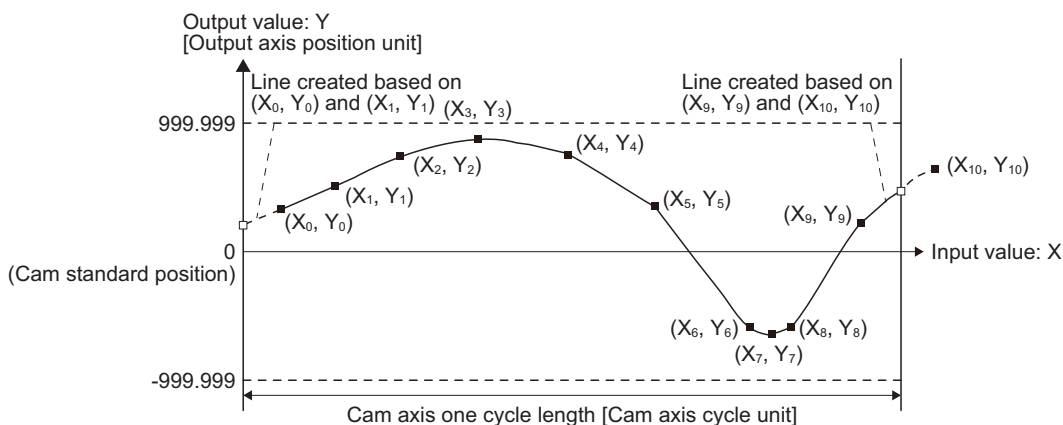

- Feed current value

The feed current value of the cam axis is calculated as follows:

Feed current value = Cam standard position + Output value to cam axis one cycle current value

When the cam axis one cycle current value is in the middle of the specified stroke ratio data, the intermediate value is calculated using the cam data before and after the value.

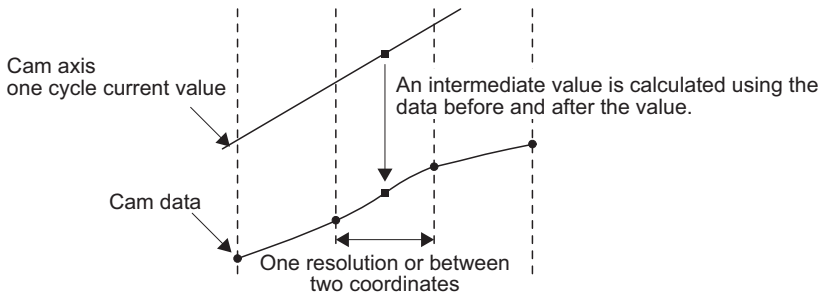

- Cam standard position

The cam standard position is calculated as follows:

The preceding cam standard position + Output value corresponding to "Input value = Cam axis one cycle length" - Output value corresponding to "Input value = 0"

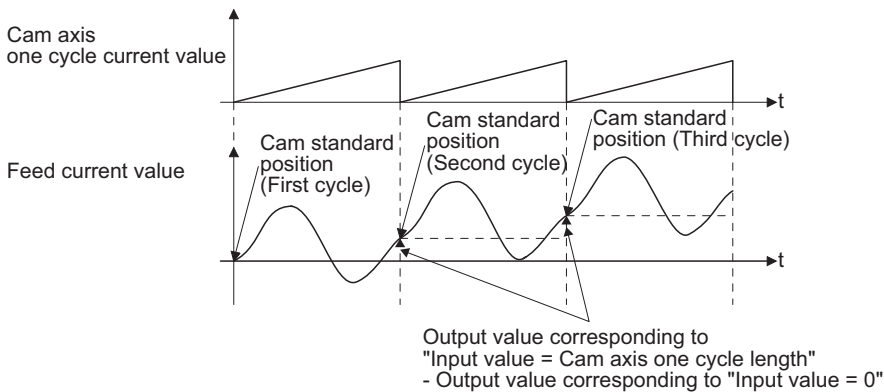

For to-and-fro control, use the output value corresponding to "Input value = Cam axis one cycle length" that is equal to output value corresponding to "Input value = 0".

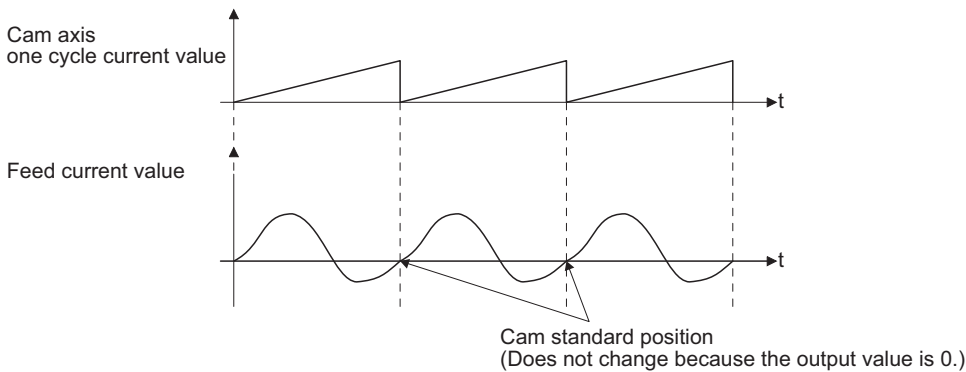

- Cam data start position

The cam data start position is not used in the coordinate data type.

- Timing of applying cam control data

A new value is applied to "Cam No." when RY (n + 1) 3 (Cam control command) turns on.

"Cam standard position" is updated when the cam axis one cycle current value passes through "0".

## List of cam control data

The following table lists the cam control data added for the simple cam function.

Set the cam control data on "[Cam Data Editing] screen" of MR Configurator2.



- Once the servo amplifier is powered off, the temporarily written data will be deleted. To store the temporarily written data, be sure to write it to the Flash-ROM before powering off the servo amplifier.
- To enable the cam control data whose symbol is preceded by \*, cycle the power after setting. The cam control data is not applied by the temporal writing of MR Configurator2.

No.	Symbol	Name	Initial value	Unit	Operation mode				Control mode	
					Standard	Full.	Lin.	DD	CP	PS
1	MCYSM <sup>*1</sup>	Main axis one cycle current value setting method	0	—	○	○	○	○	○	—
2	CPRO <sup>*1</sup>	Cam axis position restoration target	0	—	○	○	○	○	○	—
3	CBSSM <sup>*1</sup>	Cam standard position setting method	0	—	○	○	○	○	○	—
4	CCYSM <sup>*1</sup>	Cam axis one cycle current value setting method	0	—	○	○	○	○	○	—
5	MICYS <sup>*1</sup>	Main axis one cycle current value (initial setting value)	0	10 <sup>STM</sup> [μm]/ 10 <sup>(STM-4)</sup> [inch]/ 10 <sup>-3</sup> [degree]/ [pulse]	○	○	○	○	○	—
6	CIBSS <sup>*1</sup>	Cam standard position (initial setting value)	0	10 <sup>STM</sup> [μm]/ 10 <sup>(STM-4)</sup> [inch]/ 10 <sup>-3</sup> [degree]/ [pulse]	○	○	○	○	○	—
7	CICYS <sup>*1</sup>	Cam axis one cycle current value (initial setting value)	0	10 <sup>STM</sup> [μm]/ 10 <sup>(STM-4)</sup> [inch]/ 10 <sup>-3</sup> [degree]/ [pulse]	○	○	○	○	○	—
8	—	For manufacturer setting	0	—	—	—	—	—	—	—
9			0							
10			0							
11			0							
12			0							
13			0							
14	*ETYP	Synchronous encoder axis unit	0000h	—	○	—	—	—	○	—
15	*ECMX	Synchronous encoder axis unit conversion: Numerator	0	—	○	—	—	—	○	—
16	*ECDV	Synchronous encoder axis unit conversion: Denominator	0	—	○	—	—	—	○	—
17	—	For manufacturer setting	0	—	—	—	—	—	—	—
18			0							
19			0							
20			0							
21			0							
22			0							
23			0							
24			0							
25			0							
26			0							
27			0							
28			0							
29		0								
30	*MAX	Main shaft input axis selection	0	—	○	○	○	○	○	—
31	—	For manufacturer setting	0	—	—	—	—	—	—	—
32	MMIX	Main shaft input method	0000h	—	○	○	○	○	○	—

No.	Symbol	Name	Initial value	Unit	Operation mode				Control mode	
					Standard	Full.	Lin.	DD	CP	PS
33	—	For manufacturer setting	0	—	—	—	—	—	—	—
34			0							
35			0							
36	CLTMD	Main shaft clutch control setting	0000h	—	○	○	○	○	○	—
37	—	For manufacturer setting	0	—	—	—	—	—	—	—
38			0							
39			0							
40			0							
41			0							
42	CLTSMM <sup>*1</sup>	Main shaft clutch smoothing system	0	—	○	○	○	○	○	—
43	CLTSMT <sup>*1</sup>	Main shaft clutch smoothing time constant	0	[ms]	○	○	○	○	○	—
44	—	For manufacturer setting	0	—	—	—	—	—	—	—
45			0							
46			0000h							
47			0							
48	CCYL <sup>*1</sup>	Cam axis one cycle length	0	10 <sup>STM</sup> [μm]/ 10 <sup>(STM-4)</sup> [inch]/ 10 <sup>-3</sup> [degree]/ [pulse]	○	○	○	○	○	—
49	CNO <sup>*1</sup>	Cam No.	0	—	○	○	○	○	○	—
50	—	For manufacturer setting	0	—	—	—	—	—	—	—
51	CSTK <sup>*1</sup>	Cam stroke amount	0	10 <sup>STM</sup> [μm]/ 10 <sup>(STM-4)</sup> [inch]/ 10 <sup>-3</sup> [degree]/ [pulse]	○	○	○	○	○	—
52	—	For manufacturer setting	0	—	—	—	—	—	—	—
53			0							
54			0							
55			0							
56			0							
57			0							
58			0							
59			0							
60	CPHV	Cam position compensation target position	0	10 <sup>STM</sup> [μm]/ 10 <sup>(STM-4)</sup> [inch]/ 10 <sup>-3</sup> [degree]/ [pulse]	○	○	○	○	○	—
61	CPHT	Cam position compensation time constant	0	[ms]	○	○	○	○	○	—

\*1 The data is updated at cam control switching.

## Detailed list of cam control data

No./symbol/ name	Setting digit	Function	Initial value [unit]	Control mode	
				CP	PS
1 *MCYSM Main axis one cycle current value setting method	—	Select a setting method for the main axis one cycle current value. 0: Previous value 1: Main axis one cycle current value (initial setting value) 2: Calculated from input axis	0	○	—
2 *CPRO Cam axis position restoration target	—	Select a target whose cam axis position is restored. 0: Cam axis one cycle current value restoration 1: Cam standard position restoration 2: Cam axis feed current value restoration	0	○	—
3 *CBSSM Cam standard position setting method	—	Select a setting method for the cam standard position used to restore the cam axis one cycle current value. 0: Feed current value 1: Cam standard position (initial setting value) 2: Previous value The cam standard position of the last cam control is stored in the previous value. The feed current value is stored when the cam standard position of the last cam control has not been saved. Turning off the power clears the previous value.	0	○	—
4 *CCYSM Cam axis one cycle current value setting method	—	Select a setting method for the cam axis one cycle current value used for restoration when "Cam standard position" and "Cam axis feed current value" have been set as the cam axis position restoration targets. 0: Previous value 1: Cam axis one cycle current value (initial setting value) 2: Main axis one cycle current value The cam axis one cycle current value of the last cam control is stored in the previous value. Turning off the power clears the previous value.	0	○	—
5 *MICYS Main axis one cycle current value (initial setting value)	—	Set the initial value of the main axis one cycle current value. • When [Cam control data No. 30] is set to "1" The unit will be changed to $10^{STM}$ [μm], $10^{(STM-4)}$ [inch], $10^{-3}$ [degree], or [pulse] with the setting of [Pr. PT01]. The feed length multiplication (STM) can be changed with the setting of [Pr. PT03]. • When [Cam control data No. 30] is set to "2" The unit and the feed length multiplication (STM) will be changed to $10^{STM}$ [μm], $10^{(STM-4)}$ [inch], $10^{-3}$ [degree], or [pulse] with the setting of [Cam control data No. 14]. Setting range: 0 to [Cam control data No. 48] - 1	0 Refer to Function column for unit.	○	—
6 *CIBSS Cam standard position (initial setting value)	—	This is enabled when [Cam control data No. 3] is set to "1". Set the initial value of the cam standard position in the output axis position unit. The unit will be changed to $10^{STM}$ [μm], $10^{(STM-4)}$ [inch], $10^{-3}$ [degree], or [pulse] with the setting of [Pr. PT01]. The feed length multiplication (STM) can be changed with the setting of [Pr. PT03]. Setting range: -999999 to 999999	0 Refer to Function column for unit.	○	—
7 *CICYS Cam axis one cycle current value (initial setting value)	—	Set the position to start the search processing to restore the cam axis one cycle current value. Set this item when restoring the position of the return path with the to-and-fro control cam pattern. • When [Cam control data No. 30] is set to "1" The unit will be changed to $10^{STM}$ [μm], $10^{(STM-4)}$ [inch], $10^{-3}$ [degree], or [pulse] with the setting of [Pr. PT01]. The feed length multiplication (STM) can be changed with the setting of [Pr. PT03]. • When [Cam control data No. 30] is set to "2" The unit and the feed length multiplication (STM) will be changed to $10^{STM}$ [μm], $10^{(STM-4)}$ [inch], $10^{-3}$ [degree], or [pulse] with the setting of [Cam control data No. 14]. Setting range: 0 to [Cam control data No. 48] - 1	0 Refer to Function column for unit.	○	—



No./symbol/ name	Setting digit	Function	Initial value [unit]	Control mode	
				CP	PS
14 *ETYP Synchronous encoder axis unit	___x	Control unit 0: mm 1: inch 2: degree 3: pulse	0h	○	—
	__x_	Feed length multiplication (STM) 0: × 1 1: × 10 2: × 100 3: × 1000 This digit will be set to "× 1" when [Cam control data No. 14] is set to "___2" or "___3".	0h	○	—
	_x__	For manufacturer setting	0h	—	—
	x___		0h	—	—
15 *ECMX Synchronous encoder axis unit conversion: Numerator	—	Set a numerator used to convert encoder pulses of the synchronous encoder axis into the synchronous encoder axis unit. Set the numerator within the following range. $\frac{1}{16000} \leq \frac{ECMX}{ECDV} \leq 6000$ Setting a value out of the range will trigger [AL. F6 Simple cam function - Cam control warning]. When "0" is set, handle the numerator in the same way as when "1" is set. Setting range: 0 to 16777215	0	○	—
16 *ECDV Synchronous encoder axis unit conversion: Denominator	—	Set a denominator used to convert encoder pulses of the synchronous encoder axis into the synchronous encoder axis unit. Set the electronic gear within the range of [Cam control data No. 15]. Setting a value out of the range will trigger [AL. F6 Simple cam function - Cam control warning]. When "0" is set, handle the denominator in the same way as when "1" is set. Setting range: 0 to 16777215	0	○	—
30 *MAX Main shaft input axis selection	—	Select an input axis of the main shaft input. 0: Disabled 1: Servo input axis 2: Synchronous encoder axis Synchronous encoder axis is enabled only in standard control mode. [AL. 37] will occur when this parameter is set to "2" in the following state. • When scale measurement mode is disabled • When an encoder other than A/B-phase differential output encoder or A/B/Z-phase differential output encoder is connected	0	○	—
32 *MMIX Main shaft input method	___x	Main input method 0: Input + 1: Input - 2: No input	0h	○	—
	__x_	Sub input method Set how to total cam position compensation. 0: Input + (cam position compensations are totaled) 1: Input - (cam position compensations are totaled after their plus and minus signs are reversed) 2: No input (cam position compensations are totaled as 0)	0h	○	—
	_x__	For manufacturer setting	0h	—	—
	x___		0h	—	—
36 *CLTMD Main shaft clutch control setting	___x	ON control mode 0: No clutch 1: Clutch command ON/OFF	0h	○	—
	__x_	For manufacturer setting	0h	—	—
	_x__		0h	—	—
	x___		0h	—	—
42 *CLTSMM Main shaft clutch smoothing system	—	Select a clutch smoothing system. 0: Direct 1: Time constant method (index)	0	○	—

No./symbol/ name	Setting digit	Function	Initial value [unit]	Control mode	
				CP	PS
43 *CLTSM Main shaft clutch smoothing time constant	—	This is enabled when [Cam control data 42] is set to "1". Set the smoothing time constant. Setting range: 0 to 5000	0 [ms]	<input type="radio"/>	—
48 *CCYL Cam axis one cycle length	—	Set an input amount required for cam one cycle. • When [Cam control data No. 30] is set to "0" or "1" The unit will be changed to 10 <sup>STM</sup> [μm], 10 <sup>(STM-4)</sup> [inch], 10 <sup>-3</sup> [degree], or [pulse] with the setting of [Pr. PT01]. The feed length multiplication (STM) can be changed with the setting of [Pr. PT03]. • When [Cam control data No. 30] is set to "2" The unit and the feed length multiplication (STM) will be changed to 10 <sup>STM</sup> [μm], 10 <sup>(STM-4)</sup> [inch], 10 <sup>-3</sup> [degree], or [pulse] with the setting of [Cam control data No. 14]. Setting range: 0 to 999999	0 Refer to Function column for unit.	<input type="radio"/>	—
49 *CNO Cam No.	—	Set the cam No. of the cam to be executed. When "0" is set, the selections of remote register RWwnE will be prioritized. When a value other than "0" is set, the selections of remote register RWwnE will be disabled. Setting range: 0 to 8	0	<input type="radio"/>	—
51 *CSTK Cam stroke amount	—	Set a cam stroke amount for the stroke ratio of 100 % when using the stroke ratio data type cam. The unit will be changed to 10 <sup>STM</sup> [μm], 10 <sup>(STM-4)</sup> [inch], 10 <sup>-3</sup> [degree], or [pulse] with the setting of [Pr. PT01]. The feed length multiplication (STM) can be changed with the setting of [Pr. PT03]. Setting range: -999999 to 999999	0 Refer to Function column for unit.	<input type="radio"/>	—
60 *CPHV Cam position compensation target position	—	Set a compensation target position to the input axis of the cam axis. Set the position of the touch probe using the cam axis one cycle current value. • When [Cam control data No. 30] is set to "1" The unit will be changed to 10 <sup>STM</sup> [μm], 10 <sup>(STM-4)</sup> [inch], 10 <sup>-3</sup> [degree], or [pulse] with the setting of [Pr. PT01]. The feed length multiplication (STM) can be changed with the setting of [Pr. PT03]. • When [Cam control data No. 30] is set to "2" The unit and the feed length multiplication (STM) will be changed to 10 <sup>STM</sup> [μm], 10 <sup>(STM-4)</sup> [inch], 10 <sup>-3</sup> [degree], or [pulse] with the setting of [Cam control data No. 14]. Setting range: 0 to [Cam control data No. 48] - 1	0 Refer to Function column for unit.	<input type="radio"/>	—
61 *CPHT Cam position compensation time constant	—	Set the time to apply the position compensation for the input axis of the cam axis. Setting range: 0 to 65535	0 [ms]	<input type="radio"/>	—

## ■Relation among the main shaft input axis, position data unit, and feed length multiplication setting

The parameters used to set the position data unit and feed length multiplication differ depending on the setting of [Cam control data No. 30 Main shaft input axis selection].

Item	Main shaft input axis selection ([Cam control data No. 30])			
		0 (disabled)	1 (Servo input axis)	2 (Synchronous encoder axis)
Main axis one cycle current value setting method ([Cam control data No. 5])	Unit	[Pr. PT01]	[Pr. PT01]	[Cam control data No. 14]
	Multiplication	[Pr. PT03]	[Pr. PT03]	
Cam standard position (initial setting value) ([Cam control data No. 6])	Unit	[Pr. PT01]	[Pr. PT01]	[Pr. PT01]
	Multiplication	[Pr. PT03]	[Pr. PT03]	[Pr. PT03]
Cam axis one cycle current value (initial setting value) ([Cam control data No. 7])	Unit	[Pr. PT01]	[Pr. PT01]	[Cam control data No. 14]
	Multiplication	[Pr. PT03]	[Pr. PT03]	
Synchronous encoder axis unit conversion: Numerator ([Cam control data No. 15])	Unit	[Pr. PT01]	[Pr. PT01]	
	Multiplication	[Pr. PT03]	[Pr. PT03]	
Synchronous encoder axis unit conversion: Denominator ([Cam control data No. 16])	Unit	[Pr. PT01]	[Pr. PT01]	
	Multiplication	[Pr. PT03]	[Pr. PT03]	
Cam axis one cycle length ([Cam control data No. 48])	Unit	[Pr. PT01]	[Pr. PT01]	
	Multiplication	[Pr. PT03]	[Pr. PT03]	
Cam stroke amount ([Cam control data No. 51])	Unit	[Pr. PT01]	[Pr. PT01]	[Pr. PT01]
	Multiplication	[Pr. PT03]	[Pr. PT03]	[Pr. PT03]
Cam position compensation target position ([Cam control data No. 60])	Unit	[Pr. PT01]	[Pr. PT01]	[Cam control data No. 14]
	Multiplication	[Pr. PT03]	[Pr. PT03]	

## ■Synchronous encoder axis unit conversion gear setting

The input travel distance of the synchronous encoder is in encoder pulse units. You can convert the unit into a desired unit through unit conversion by setting [Cam control data No. 15 Synchronous encoder axis unit conversion: Numerator] and [Cam control data No. 16 Synchronous encoder axis unit conversion: Denominator].

Set [Cam control data No. 15] and [Cam control data No. 16] according to the control target machine.

$$\text{Synchronous encoder axis travel distance (after unit conversion)} = \frac{\text{Synchronous encoder input travel distance (encoder pulse unit)} \times [\text{Cam control data No. 15}]}{[\text{Cam control data No. 16}]}$$

The travel distance (number of pulses) set in [Cam control data No. 16] is set in [Cam control data No. 15] in synchronous encoder axis position units.

Set [Cam control data No. 16] in encoder pulse units of the synchronous encoder.

# Function block diagram for displaying state of simple cam control

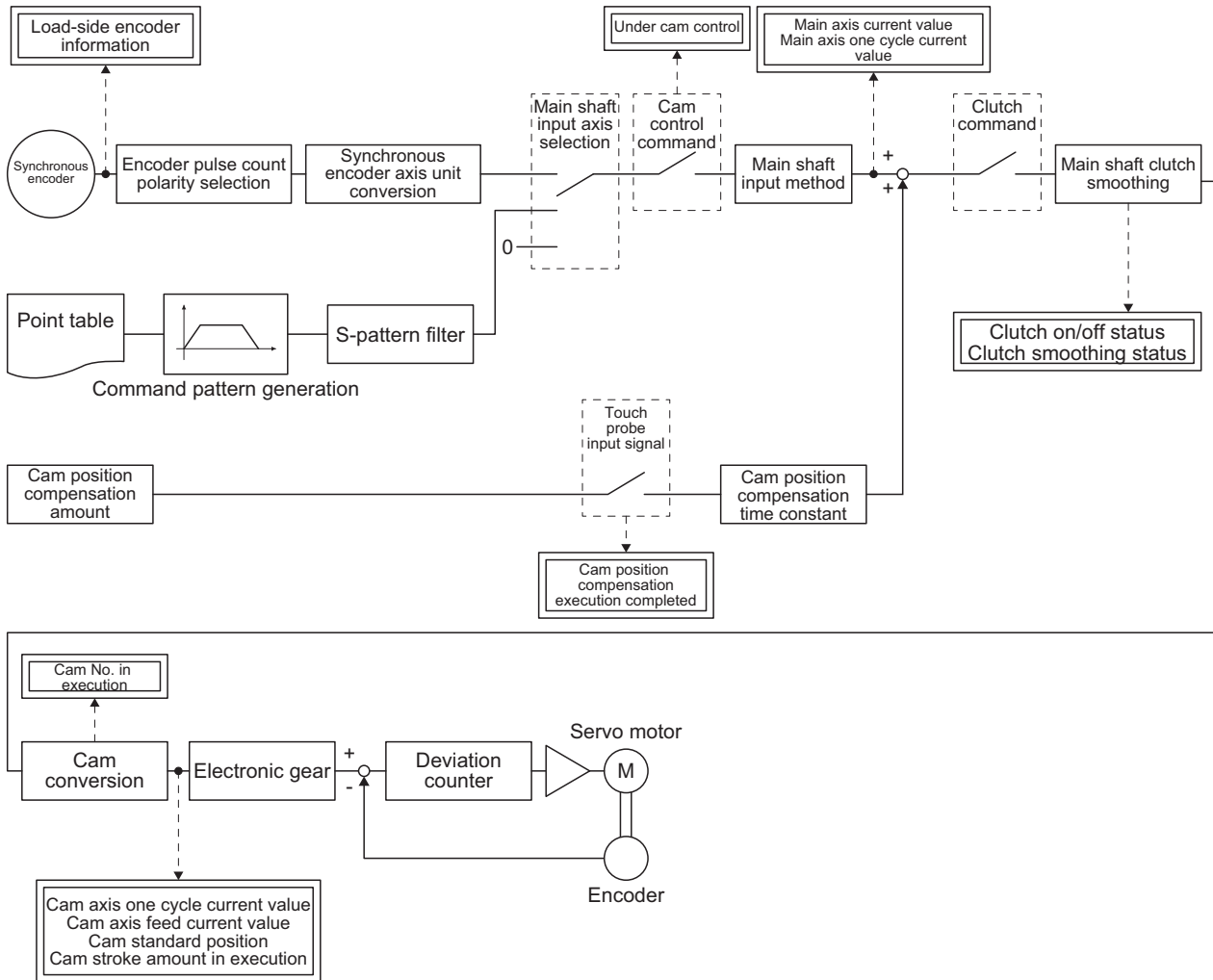

# Operation

## Point

Execute operation so that the machine speed of the input axis is less than "[Cam control data No. 48 - Cam axis one cycle length] × 1/2 × 1000 [command unit/s]". Failure to do so may cause the input axis and output axis to become out of synchronization.

This section explains the operation of the simple cam function using a rotary cutter system as an example.

## Configuration example

The rotary knife cuts the sheet conveyed by the conveyor at a constant speed into a desired length.

To prevent variations in the sheet length and a cutting position mismatch, this device reads registration marks that have been printed on the sheet, and compensates cutting positions.

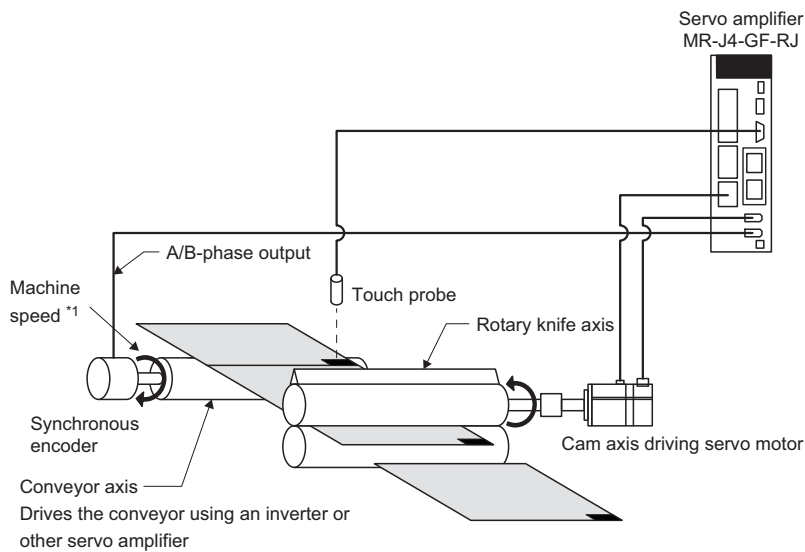

\*1 Set the machine speed of the input axis to a value that satisfies the following expression.

$$\text{Machine speed} \leq [\text{Cam control data No. 48 - Cam axis one cycle length}] \times 1/2 \times 1000 [\text{command unit/s}]$$

The machine speed can be checked by monitoring the waveform of the main axis current value with the Graph function of MR Configurator2.

The machine speed can be obtained from the following expression.

$$\text{Machine speed} = (L2 - L1)/(T2 - T1)$$

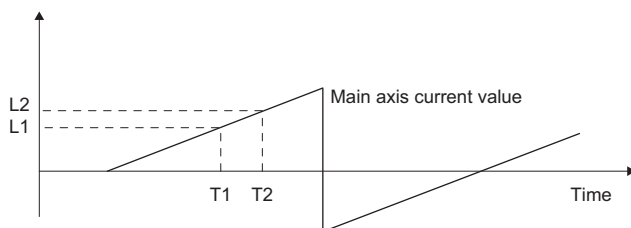

■ **Setting example: When the sheet length is 200.0 mm, the circumferential length of the rotary knife axis (synchronous axis length) is 600.0 mm, and the sheet synchronous width is 10.0 mm**

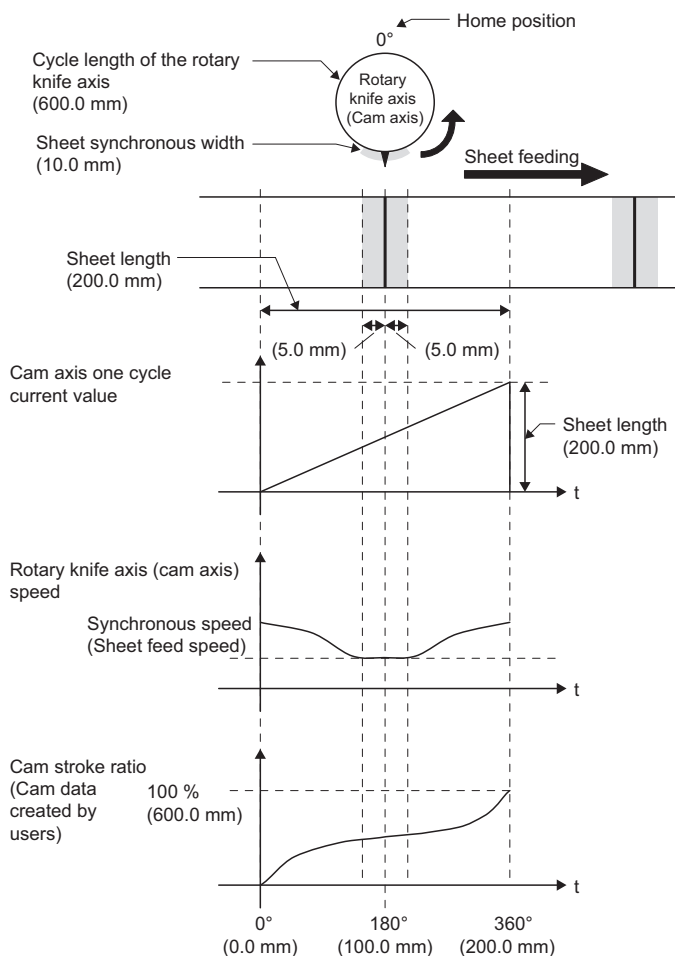

Basic settings require to use the simple cam function

Item	Setting	Setting value
Operation mode selection ([Pr. PA01])	Select "Point table method".	"1000"
Simple cam function setting ([Pr. PT35])	Enable the simple cam function.	"_ 1 _ _"

When the conveyor axis (main axis) feeds a sheet by the set length, the rotary knife makes one rotation (600 mm) to cut the sheet. Set the following items as follows.

Item	Setting	Setting value
Cam axis one cycle length ([Cam control data No. 48])	Set the sheet length.	200.000
Cam stroke amount ([Cam control data No. 51])	Set the rotation amount per rotation in "μm".	600000
Synchronous encoder axis unit ([Cam control data No. 14])	Set the unit of the sheet length.	0 (mm)
Unit of rotary knife axis ([Pr. PT01])	Set "mm" as the unit of position data.	"_ 0 _ _"
Cam data	Create the cam data with the operation pattern shown in the above figure.	—

Set the following items as follows to use the encoder following function.

Item	Setting	Setting value
Main shaft input axis selection ([Cam control data No. 30])	Select the synchronous encoder axis.	2
Synchronous encoder axis unit multiplication: Numerator ([Cam control data No. 15])	Refer to the following. ☞ Page 273 Synchronous encoder axis unit conversion gear setting	☞ Page 273 Synchronous encoder axis unit conversion gear setting
Synchronous encoder axis unit multiplication: Denominator ([Cam control data No. 16])		

## Operation

The following table shows an example of the procedure before operation.

Step	Setting and operation
1. Data setting	Refer to the setting example on the previous page and set the data.
2. Initial position adjustment	Adjust the synchronous positions of the conveyor axis and rotary knife axis. <ul style="list-style-type: none"> <li>When the position of the conveyor axis (main axis current value) is "0", set the position of the rotary knife axis (feed current value) to "0".</li> <li>Since the position at power-on is "0", the home position return of the conveyor axis is not required.</li> <li>Perform the home position return on the rotary knife axis at the point where the blade of the cutter become the top.</li> </ul> Adjust the conveyor axis and rotary knife axis so that the 0 position of both axes is located at the center of the sheet length.
3. Selecting cam data	Select the cam data to be executed with RWwnE (Cam No. setting). The user can use [Cam control data No. 49 - Cam No.] to select the cam data.
4. Servo-on	Switch on RYn0 (Servo-on).
5. Switching cam control	Switch on RY (n + 1) 3 (Cam control command) to switch the control to the cam control.
6. Starting the conveyor axis	Check that RX (n + 1) 3 (During cam control) is on and start the conveyor axis. The rotary knife axis is driven in synchronization with the conveyor axis.

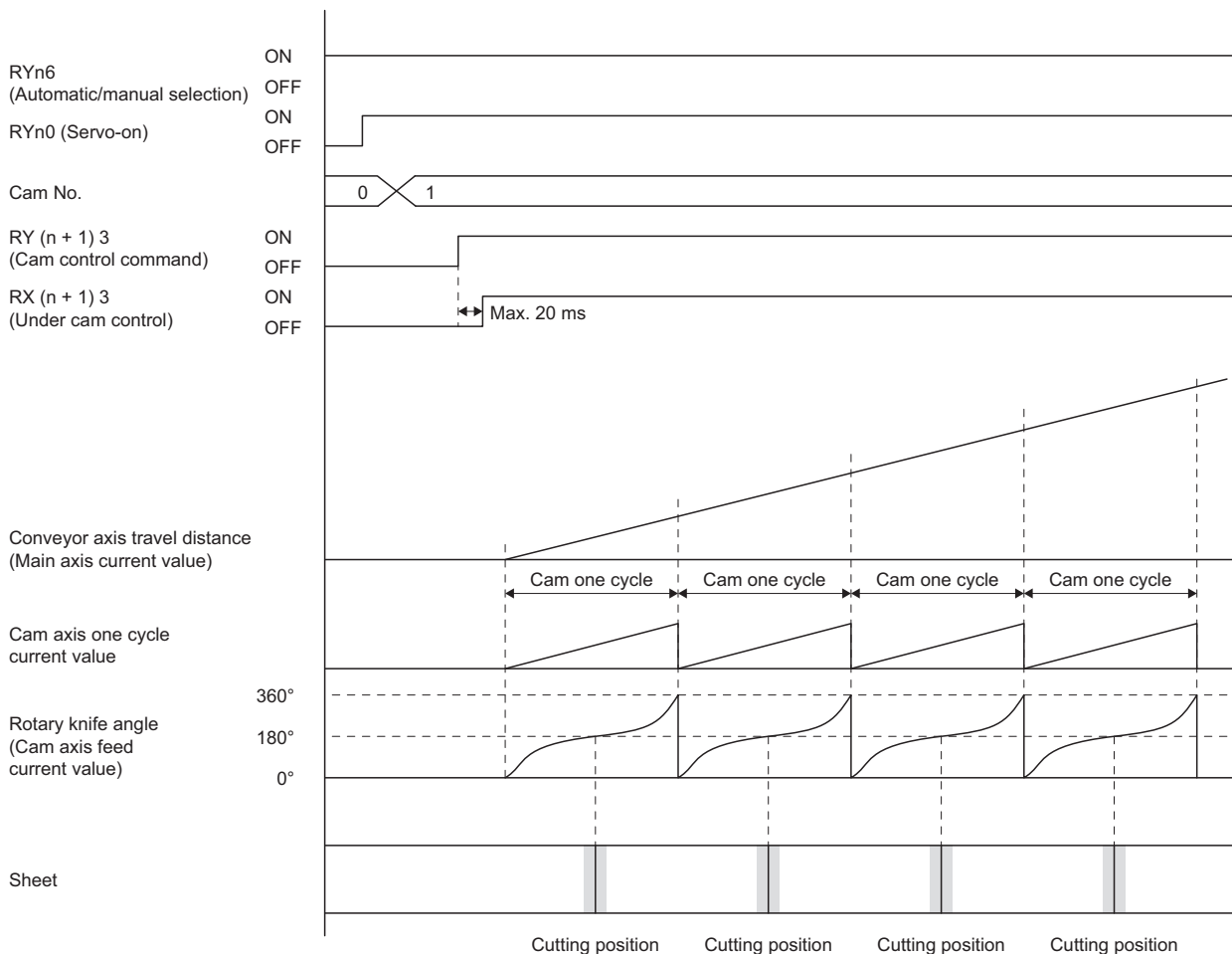

## Compensation by touch probe

This system detects registration marks that have been equally printed on the sheet, and compensates the difference between the actual cam axis one cycle current value and the ideal cam axis one cycle current value (set value of the cam position compensation target position) by shifting the synchronous phase of the rotary knife axis and the conveyor axis.

### ■Setting example: When the ideal registration mark position is 150 mm and the mark is not detected unless the conveyor feeds the sheet by 151 mm due to stretch

By executing compensation, the rotary knife cuts the sheet keeping the distance of 50 mm between the ideal position for detecting the registration mark and the position for cutting the sheet.

Item	Setting and operation
Cam position compensation target position ([Cam control data No. 60])	In this example, the ideal position for detecting the registration mark is 150 mm position from the cam axis one cycle current value. Set "150" for the cam position compensation target position.
Cam position compensation time constant ([Cam control data No. 61])	In this example, the position compensation is executed by one-shot. Set "0" for the cam position compensation time constant.

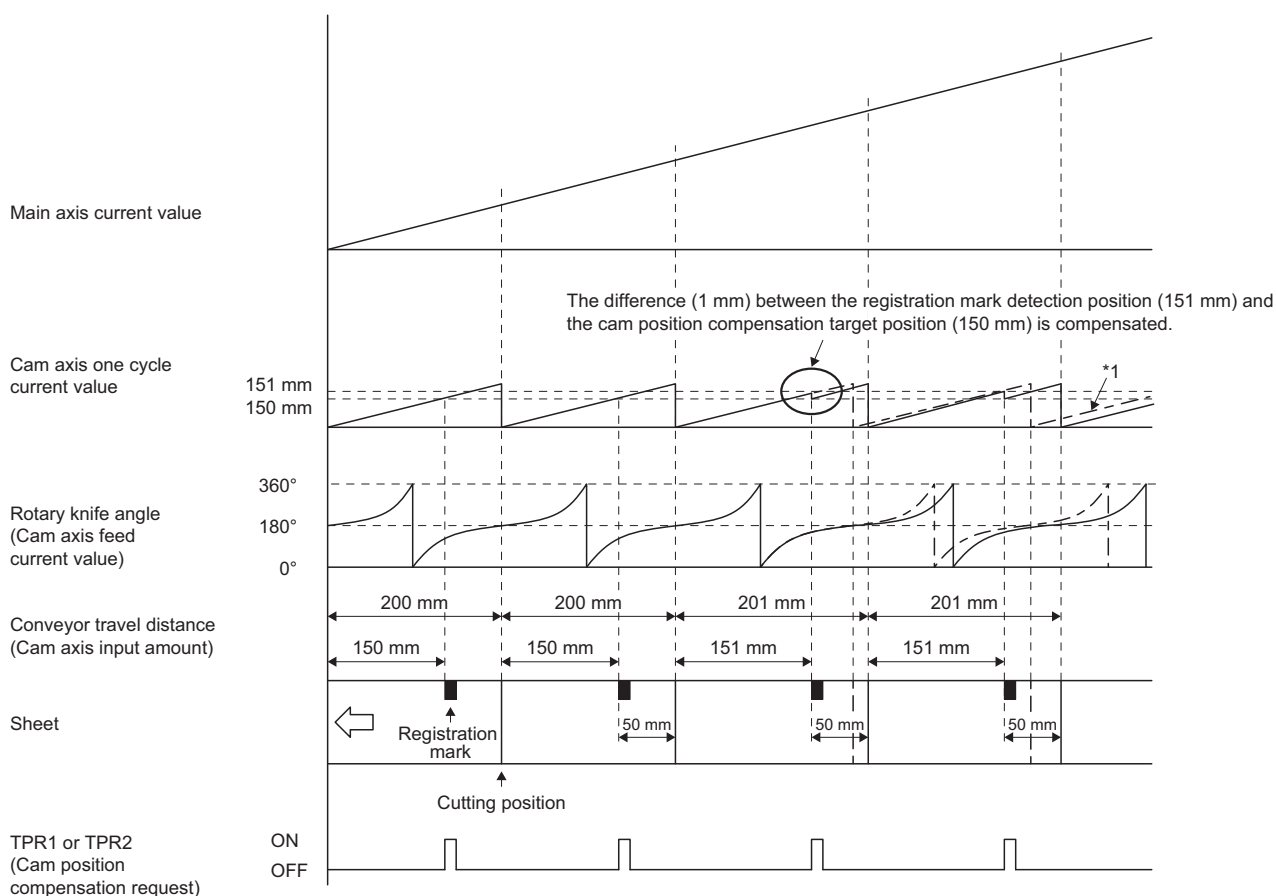

\*1 The dot-and-dash line in the above figure shows a waveform of when compensation is not executed.



## Details of cam position compensation

The cam position compensation processing compensates the difference between the target position for detecting the sensor and the actual position for detecting the sensor by shifting the cam axis one cycle current value.  $ccyl'$ , the cam axis one cycle length (sheet length) after compensation, is calculated as follows:

CCYL: Cam axis one cycle length ([Cam control data No. 48])

CPHV: Cam position compensation target position ([Cam control data No. 60])

$ccyl'$ : Cam axis one cycle length (after compensation)

$cpos$ : Cam axis one cycle current value at sensor detection

$CPHV - cpos$ : Distance between the target sensor detection position and actual sensor detection position

- When the sensor detection position is before the target position ( $CPHV \geq cpos$ ):  $ccyl' = CCYL - (CPHV - cpos)$

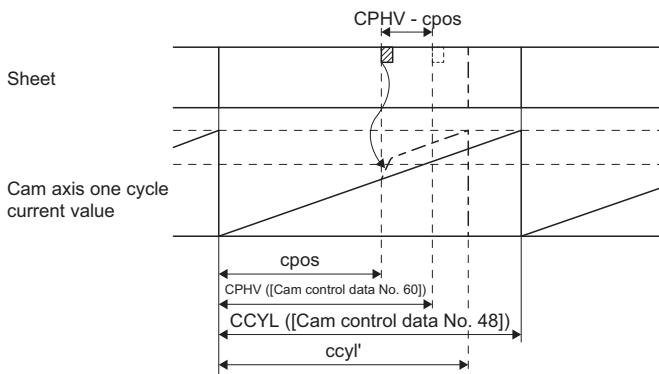

Increase the conveyor travel distance by adding the difference ( $CPHV - cpos$ ) to the cam axis one cycle current value. Adjust the filter time constant for acceleration/deceleration at compensation with [Cam control data No. 61 Cam position compensation time constant].

- When the sensor detection position is after the target position ( $CPHV < cpos$ ):  $ccyl' = CCYL + (cpo - CPHV)$

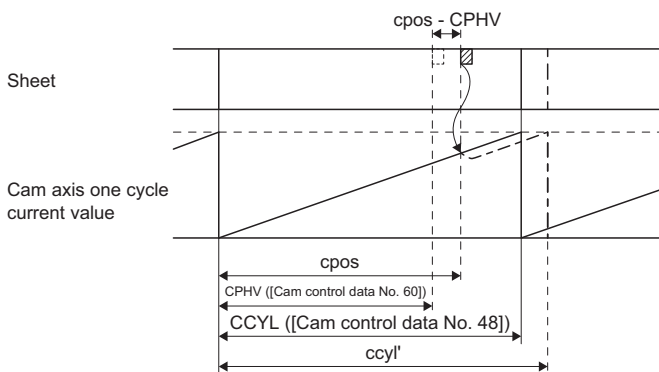

Decrease the conveyor travel distance by subtracting the difference ( $cpos - CPHV$ ) from the cam axis one cycle current value. Adjust the filter time constant for acceleration/deceleration at compensation with [Cam control data No. 61 Cam position compensation time constant].

## Cam No. setting method

### Point

When the cam No. is set to a value other than "0" to "8", [AL. F6.5 Cam No. external error] will occur. If the cam data of a specified cam No. does not exist, [AL. F6.3 Cam unregistered error] occurs. At this time, the cam control is not executed and the servo motor does not start. Turning off the cam control command clears [AL. F6.3] and [AL. F6.5].

The cam No. can be set and changed using the RWwnE (cam No. setting) in the same way as it is designated in [Cam control data No. 49], and selected in Point table No. selection.

The priority level of cam control parameter and RWwnE are as follows.

[Pr. PT35] setting	[Cam control data No. 49] setting	RWwnE	Setting
_ 0 _ _ (Simple cam function disabling setting)	×	×	The cam function will be disabled with the setting of [Pr. PT35].
_ 1 _ _ (Simple cam function enable setting)	"0" (initial value)	○	Cam No. is determined by the RWwnE setting.
	Other than "0"	×	The cam No. is set with the setting of [Cam control data No. 49]. Cam No. setting by the RWwnE is disabled.

○: Enable, ×: Disable

# Stop operation of cam control

If one of the following stop causes occurs on the output axis during cam control, the cam control stops after the output axis is stopped. (RX (n + 1) 3 (Under cam control) turns off.)

To restart the cam control, adjust the synchronous position of the output axis.

Stop cause	Command stop processing	Remark
Software stroke limit detection	Instantaneous stop	☞ Page 281 Instantaneous stop
Stroke limit detection	Instantaneous stop	☞ Page 281 Instantaneous stop
Stop due to forced stop 1 or 2, or alarm occurrence	Instantaneous stop or deceleration to a stop	Stop due to base circuit shut-off. ☞ Page 281 Instantaneous stop Stop by the forced stop deceleration function. ☞ Page 281 Deceleration stop
RY (n + 1) 3 (Cam control command) OFF	Instantaneous stop	☞ Page 281 Instantaneous stop
Servo-off	Instantaneous stop	Coasting state

## Instantaneous stop

The operation stops without deceleration. The servo amplifier immediately stops the command.

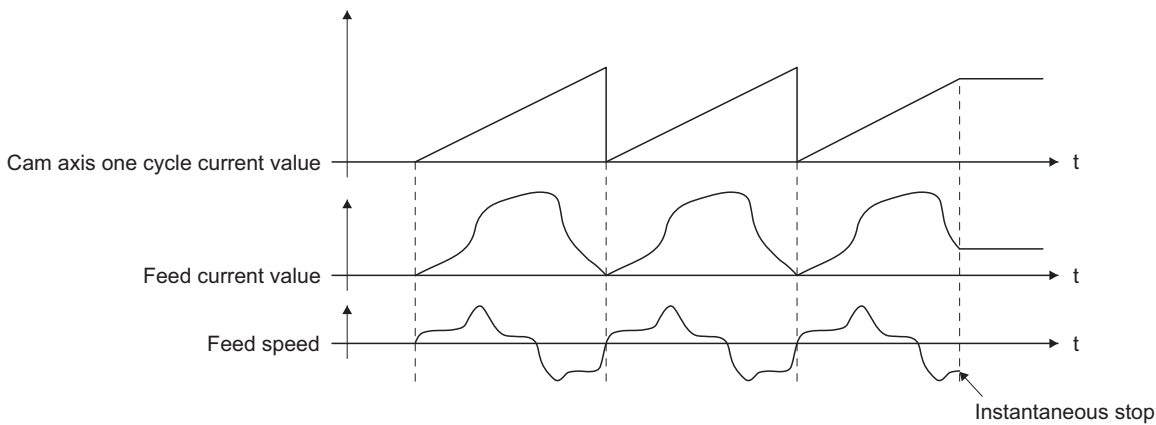

7

## Deceleration stop

The output axis decelerates to stop according to [Pr. PC51 Forced stop deceleration time constant]. After a deceleration stop starts, the cam axis one cycle current value and feed current value are not updated. The path of the feed current value is drawn, and the stop is made regardless of the cam control.

Decelerate the input axis to stop when decelerating the output axis to stop in synchronization with the input axis.

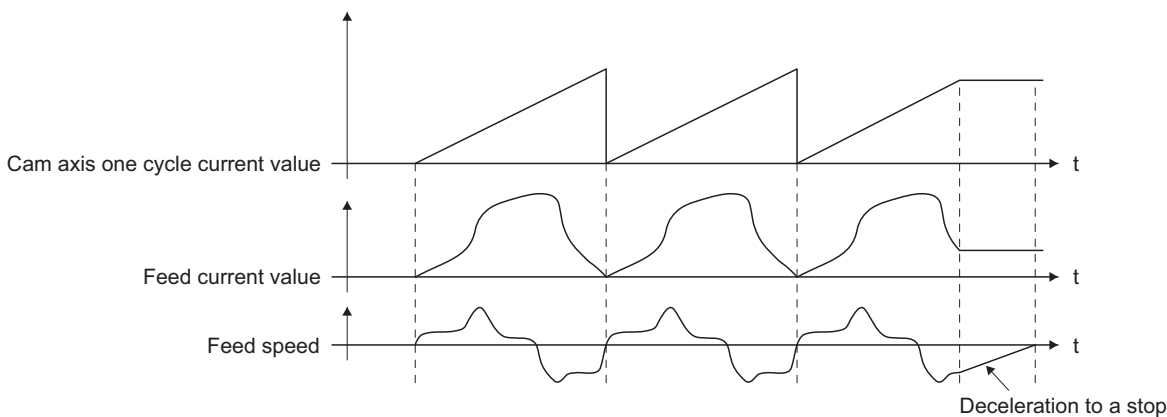

When using a positioning command (internal command) for the input axis, inputting a temporary stop or switching the operation mode decelerates the input axis to stop. Since the output axis stops in synchronization with the input axis, the synchronous relationship is kept and the cam control does not stop.

When the control mode is switched to the home position return mode, the cam control will stop.

# Restart operation of cam control

When the cam control is stopped during operation, a gap is generated in the synchronization between the main shaft and the driven shaft. To solve the gap, return the main shaft and the driven shaft to the synchronization starting point and then start the synchronous operation.

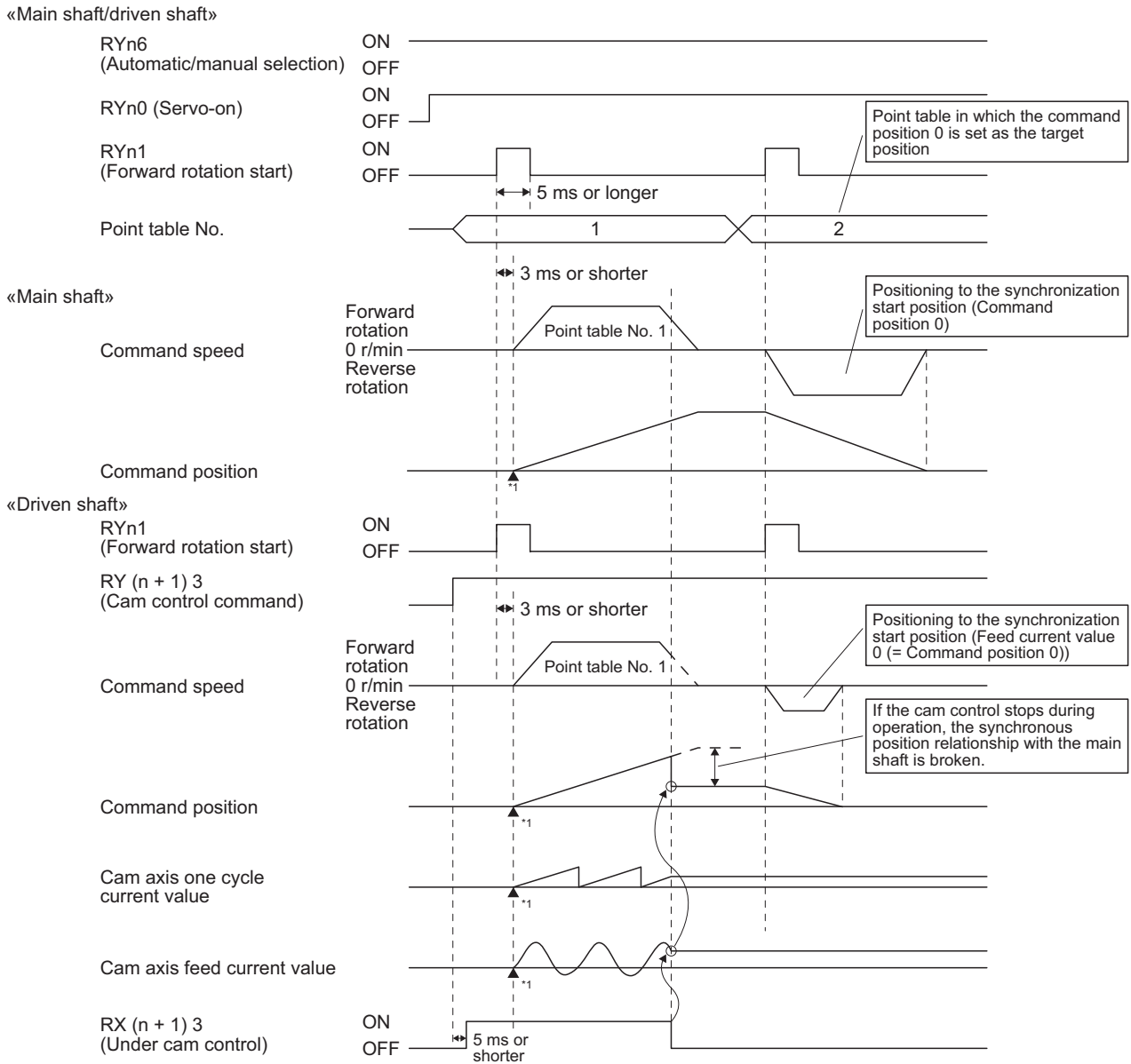

\*1 The above shows an example for when the synchronization starting point is the point where both command position and feed current value are "0".

## Cam axis position at cam control switching

The cam axis position is determined by the positional relationship of three values of "Cam axis one cycle current value", "Cam axis standard position" and "Cam axis feed current value". When the control has been switched to the cam control (RY (n + 1) 3 (Cam control command) is on), defining the positions of two of these values restores the position of the remaining one value.

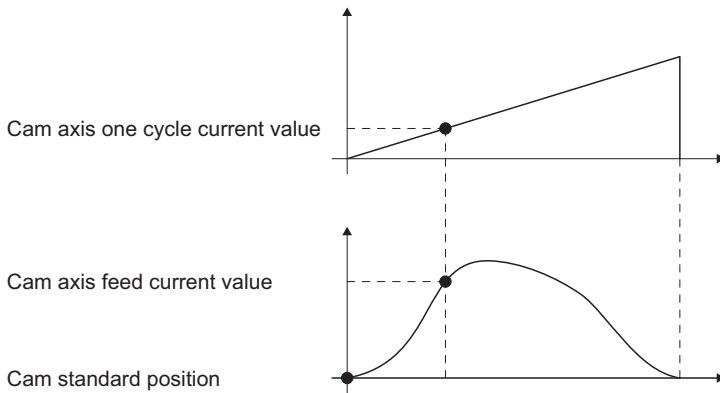

The following table lists the parameters required to be set for the cam axis position restoration. Refer to the following for the settings.

☞ Page 262 Data to be used with simple cam function

Cam axis position restoration target ([Cam control data No. 2])	Cam standard position setting method ([Cam control data No. 3])	Cam standard position (initial setting value) ([Cam control data No. 6])	Cam axis one cycle current value setting method ([Cam control data No. 4])	Cam axis one cycle current value (initial setting value) ([Cam control data No. 7])	Restoration processing details
0: Cam axis one cycle current value restoration	○	○ <sup>*1</sup>	—	○ (Used as the search starting point of cam pattern.)	"Cam axis one cycle current value" is restored based on "Cam standard position" and "Cam axis feed current value".
1: Cam standard position restoration	—	—	○	○ <sup>*1</sup>	"Cam standard position" is restored based on "Cam axis one cycle current value" and "Cam axis feed current value".
2: Cam axis feed current value restoration	○	○ <sup>*1</sup>	○	○ <sup>*1</sup>	"Cam axis feed current value" is restored based on "Cam axis one cycle current value" and "Cam standard position".

○: Required

\*1 Set this parameter when [Cam control data No. 3] is set to "1".

## Cam axis one cycle current value restoration

### Point

- For the cam pattern of to-and-fro control, if no corresponding cam axis one cycle current value is found, [AL. F6.1 Cam axis one cycle current value restoration failed] will occur and cam control cannot be executed.
- For the cam pattern of feed control, if no corresponding cam axis one cycle current value is found, the cam standard position will automatically change and the value will be searched again.
- If the cam resolution of the cam used is large, search processing at cam control switching may take a long time.

When RY (n + 1) 3 (Cam control command) turns on, "Cam axis one cycle current value" is restored based on "Cam standard position" and "Cam axis feed current value" and the control is switched to the cam control. Set the "cam standard position" used for the restoration with cam control data. The feed current value at cam control switching is used as "Cam axis feed current value".

The cam axis one cycle current value is restored by searching for a corresponding value from the beginning to the end of the cam pattern.

Set the starting point for searching the cam pattern with "[Cam control data No. 7 Cam axis one cycle current value (initial setting value)]". (It is also possible to search from the return path in the cam pattern of to-and-fro control.)

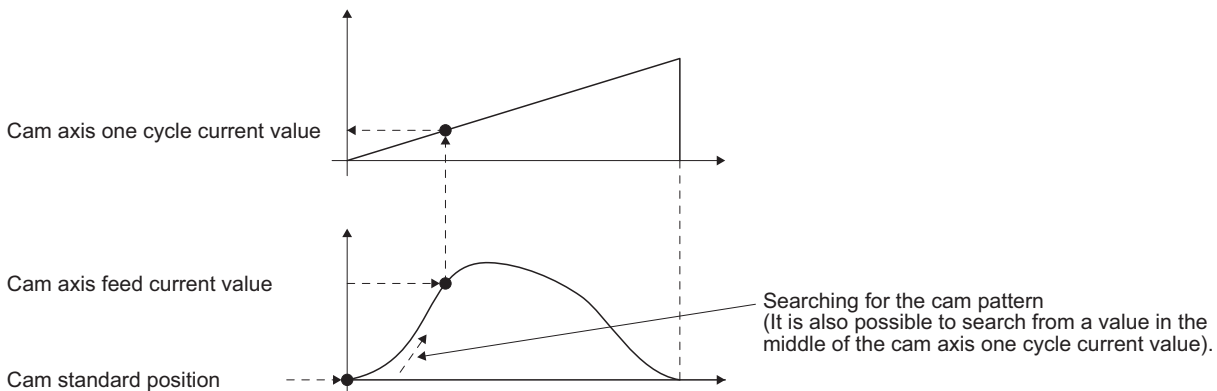

### ■Cam pattern of to-and-fro control

- Searching from "Cam axis one cycle current value = 0" (Cam data start position = 0)

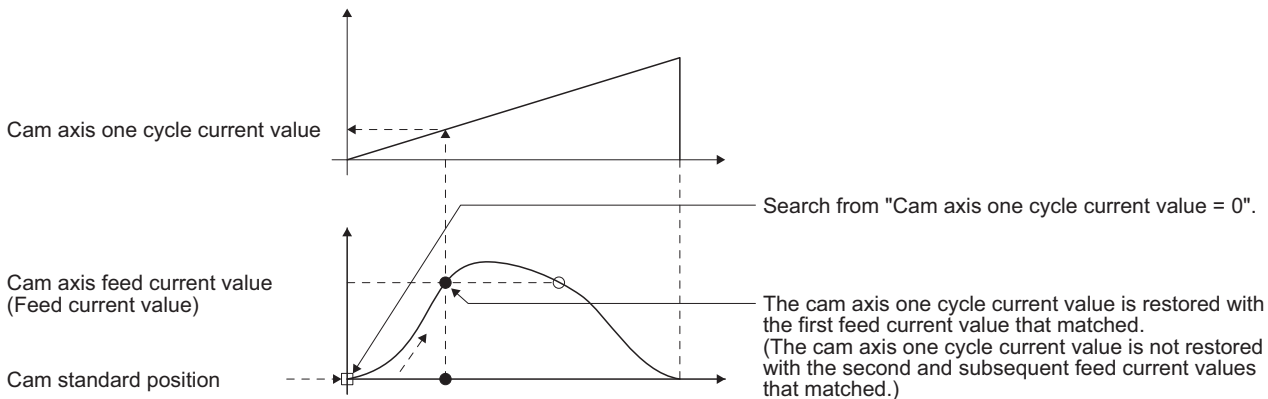

- Searching from a value in the middle of the cam axis one cycle current value (Cam data start position = 0)

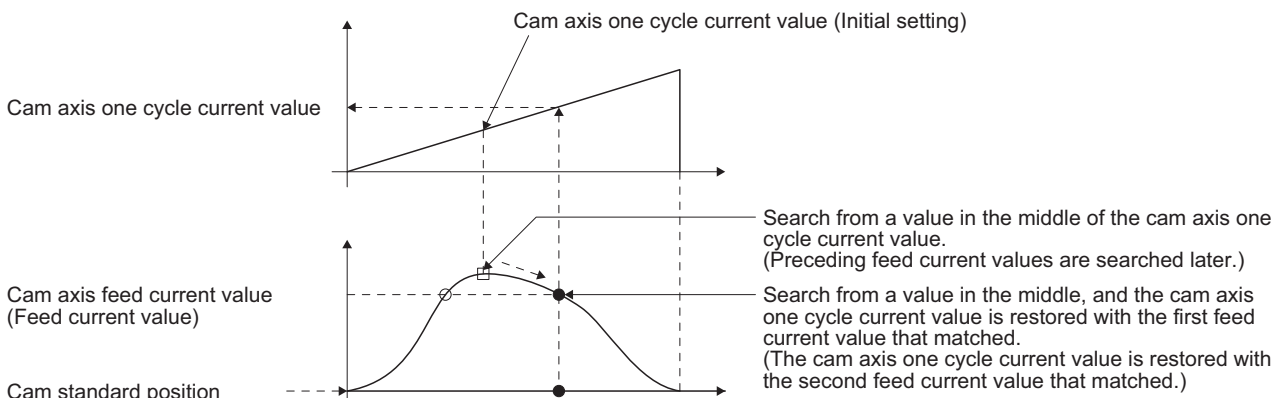

- Searching from a value in the middle of the cam axis one cycle current value (Cam data start position ≠ 0)

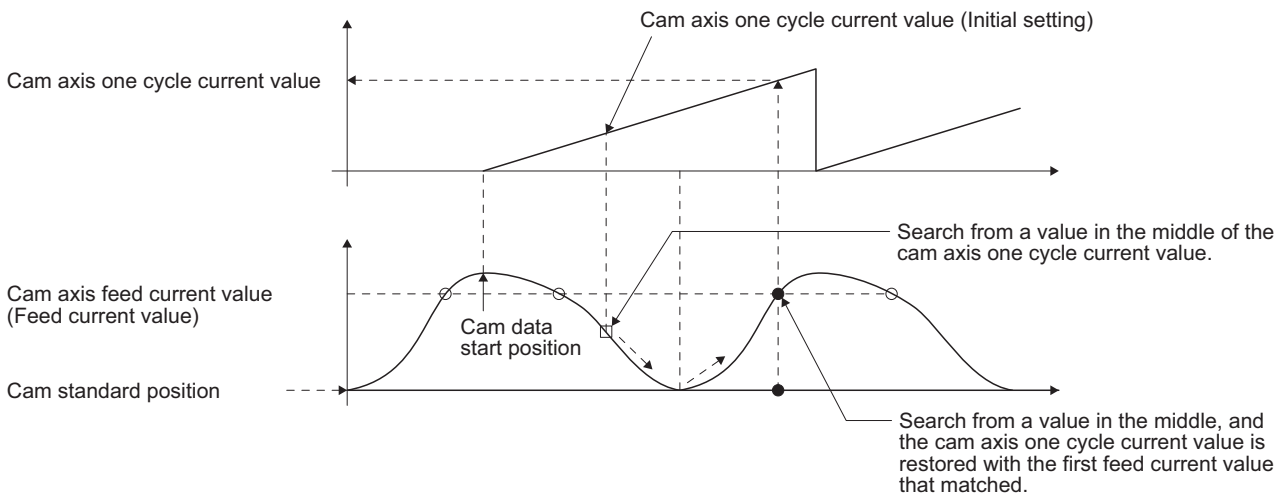

- Searching fails

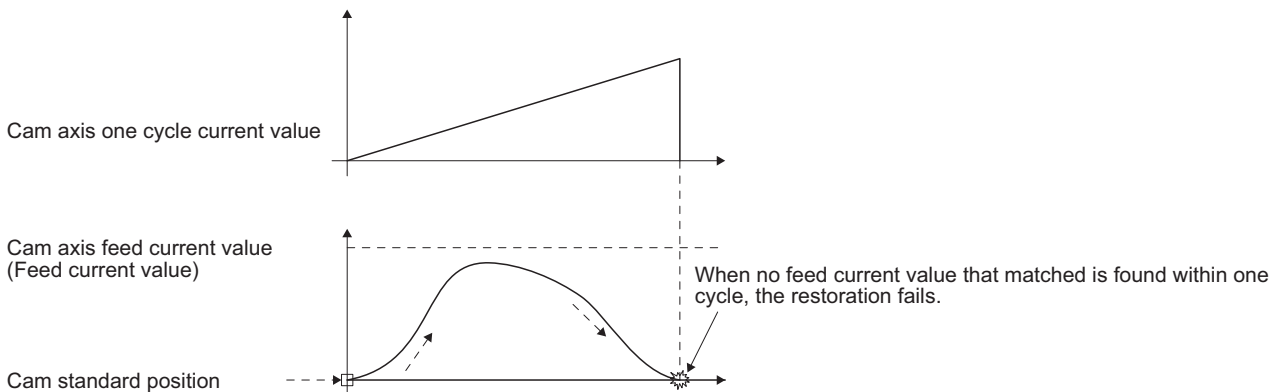

## ■ Cam pattern of feed control

- Searching from "Cam axis one cycle current value = 0" (Cam data start position = 0)

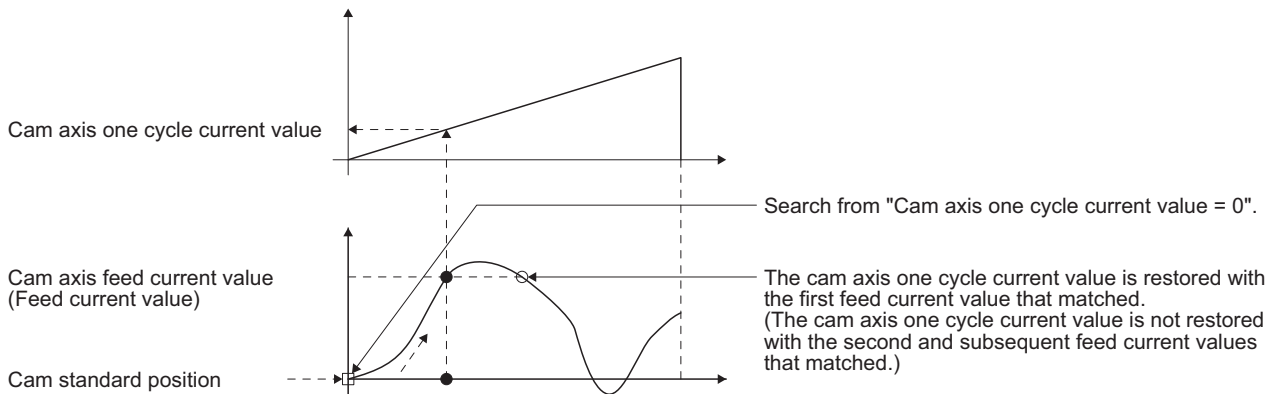

- Searching from a value in the middle of the cam axis one cycle current value (Cam data start position = 0)

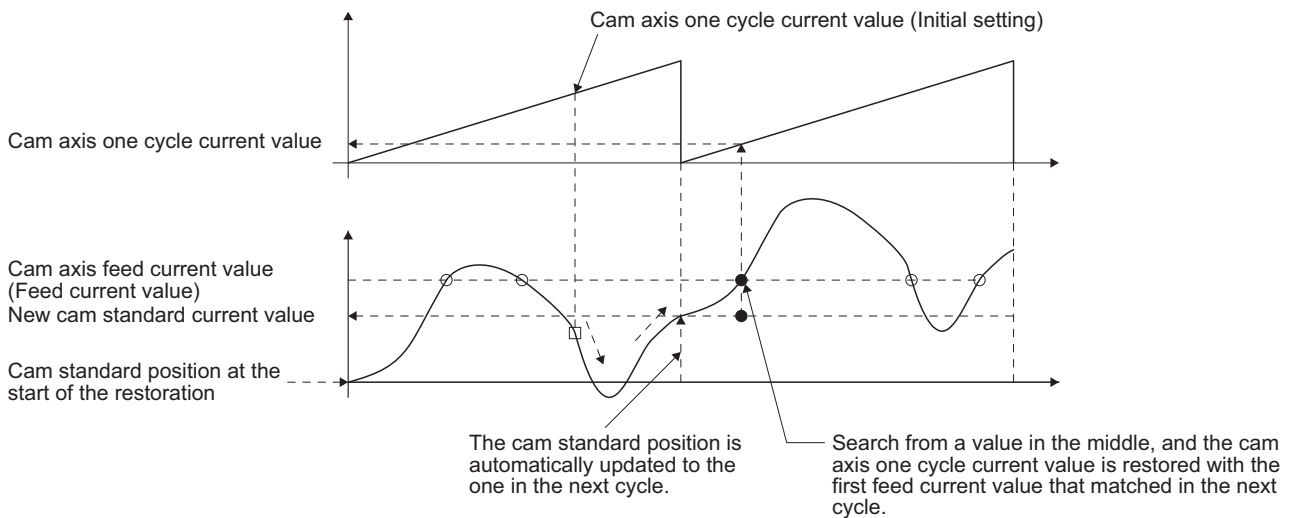

- Searching from a value in the middle of the cam axis one cycle current value (Cam data start position  $\neq 0$ )

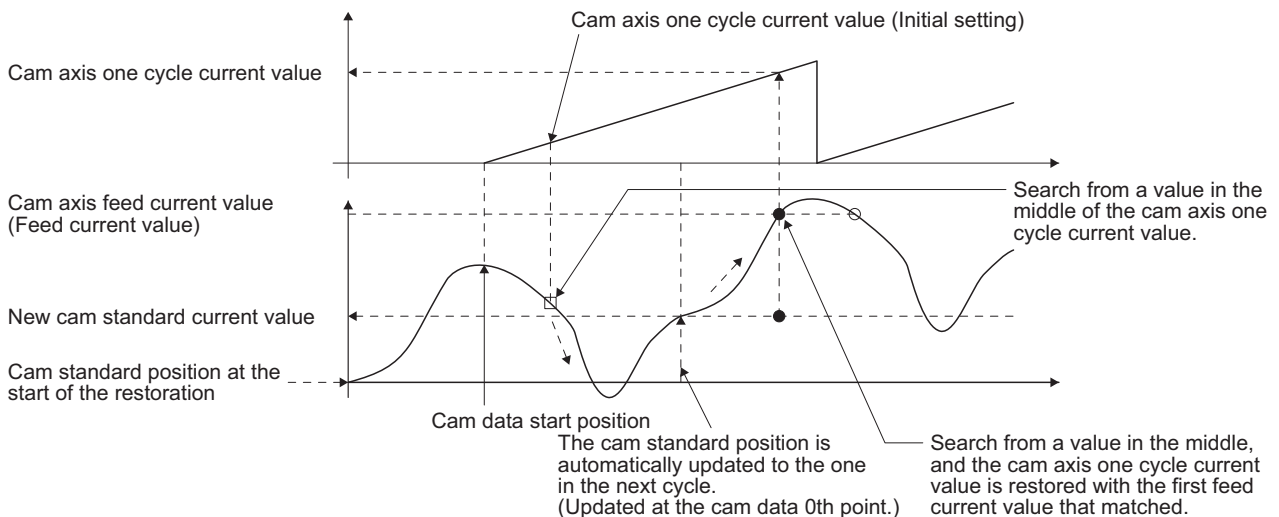



- The first searching has failed and the second searching starts

**Point** 

If the first searching has failed, the second searching may not be processed in the next cycle for a cam pattern with a feed stroke smaller than 100 %. By setting or positioning a cam standard position in advance, an intended cam axis one cycle current value can be found in the first searching.

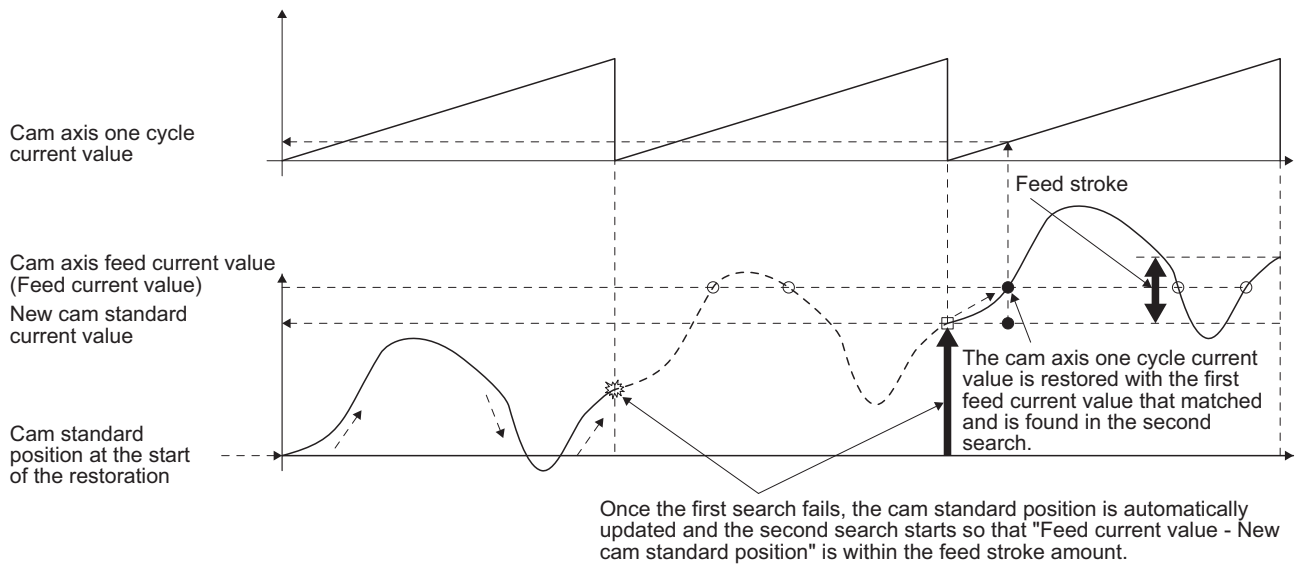

## Cam standard position restoration

If the cam axis position restoration target is set to "Cam standard position restoration" and RY (n + 1) 3 (Cam control command) turns on, the "cam standard position" will be restored based on "Cam axis one cycle current value" and "Cam axis feed current value" and the control is switched to the cam control.

Set the "cam axis one cycle current value" used for restoration with cam control data. The feed current value of when RY (n + 1) 3 (Cam control command) is on is used as the "cam axis feed current value".

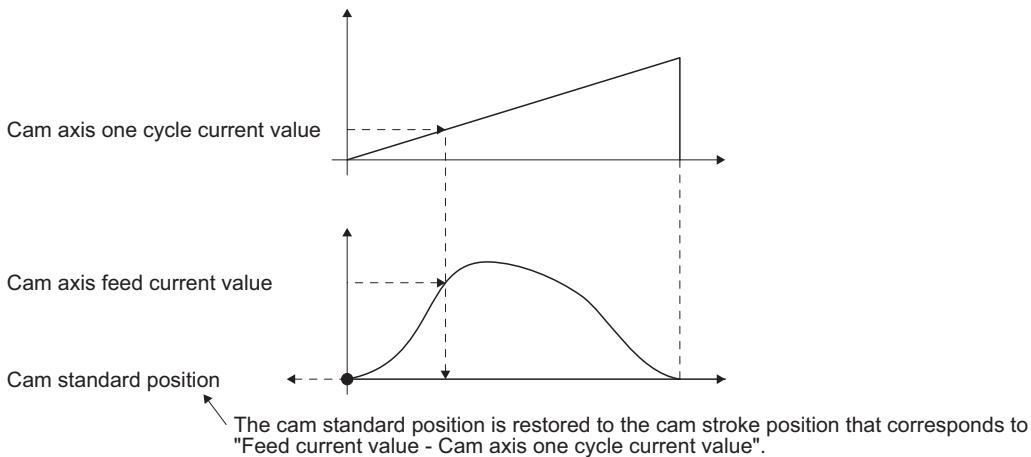

The following shows an example for restoring the cam standard position to start an operation from a point where both the feed current value and the cam axis one cycle current value are 0" in the cam whose cam data start position is not "0".

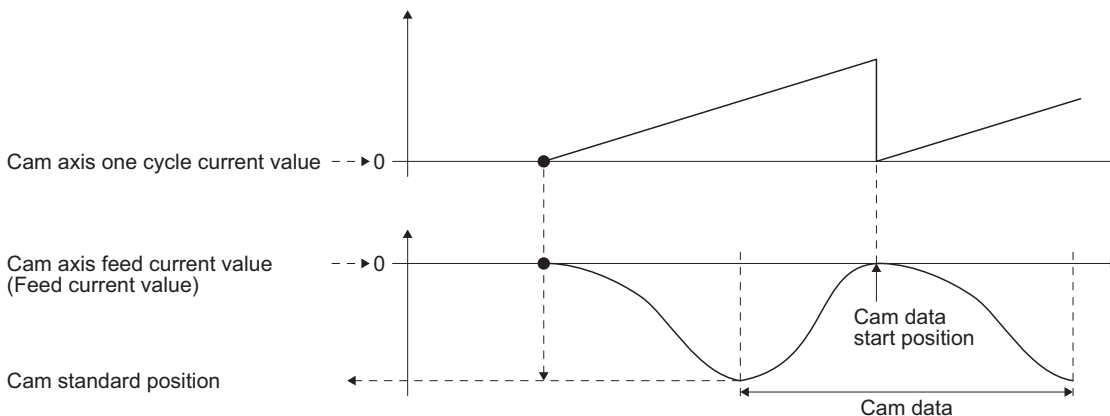

## Cam axis feed current value restoration

### Point

- When the restored cam axis feed current value differs from the feed current value at cam control switching, the cam axis feed current value moves to the value restored just after cam control switching.
- If the difference between the restored cam axis feed current value and the feed current value is larger than the value set in [Pr. PA10 In-position range], [AL. F6.2 Cam axis feed current value restoration failed] will occur and the control cannot be switched to the cam control. Note that, if increasing the value of the in-position range may lead to a rapid cam switching.

If the cam axis position restoration target is set to "Cam axis feed current value restoration" and RY (n + 1) 3 (Cam control command) turns on, "Cam axis feed current value" is restored based on "Cam axis one cycle current value" and "Cam standard position" and the control is switched to the cam control.

Set the "cam axis one cycle current value" and "cam standard position" used for the restoration with cam control data.

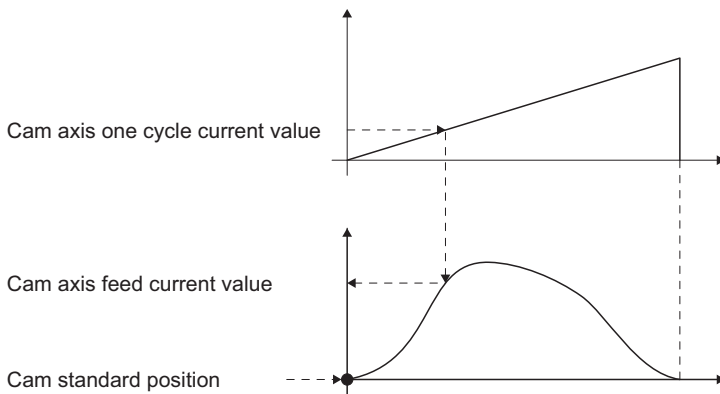

# Clutch

The clutch is used to transmit/disengage command pulses from the main shaft input side to the output axis module through turning the clutch ON/OFF, controlling start/stop of the servo motor operation.

Set whether or not to use the clutch control with [Cam control data No. 36 - Main shaft clutch control setting].

Although the clutch ON/OFF can be changed during cam control, the setting of [Cam control data No. 36] cannot be changed from "1 (Clutch command ON/OFF)" to "0 (No clutch)" during cam control.

## ON control mode

### ■"No clutch"

When [Cam control data No. 36 - Main shaft clutch control setting] is set to "0 (No clutch)", other clutch parameters are not used due to direct coupled operation.

### ■Clutch command ON/OFF

Turning on/off RY (n + 1) 5 (Clutch command) turns on/off the clutch.

(Settings in the OFF control mode are not used in the clutch command ON/OFF mode.)

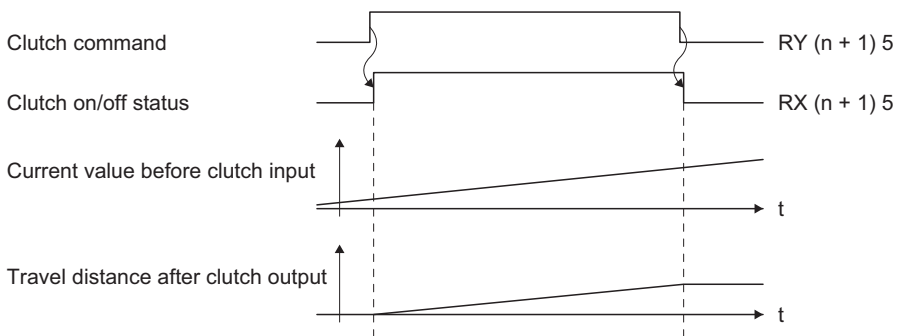

## Clutch smoothing method

Smoothing is processed with the time constant set in [Cam control data No. 43 Main shaft clutch smoothing time constant] at clutch ON/OFF. After clutch ON smoothing is completed, smoothing is processed with the set time constant when the speed of the input values changes.

The travel distance from turning on to off of the clutch does not change with smoothing.

Travel distance after clutch smoothing = Travel distance before clutch smoothing

Time constant method exponential curve smoothing

Set [Cam control data No. 42 - Main shaft clutch smoothing system] to "1 (Time constant method (index))".

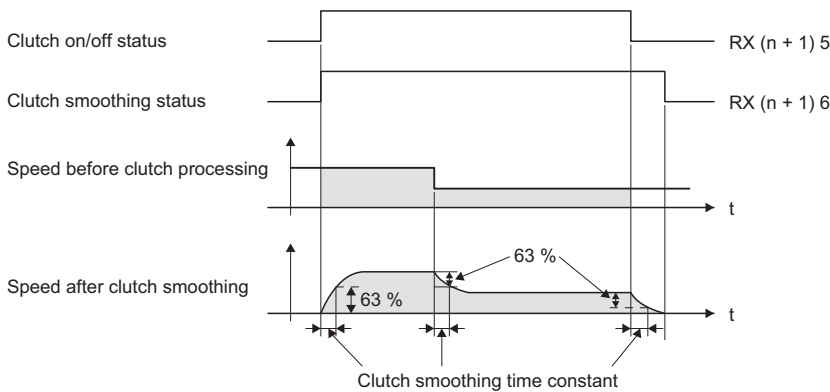

# Cam position compensation target position

Perform compensation to match the cam axis one cycle current value with the cam position compensation target position ([Cam control parameter No. 60]) by inputting a cam position compensation request.

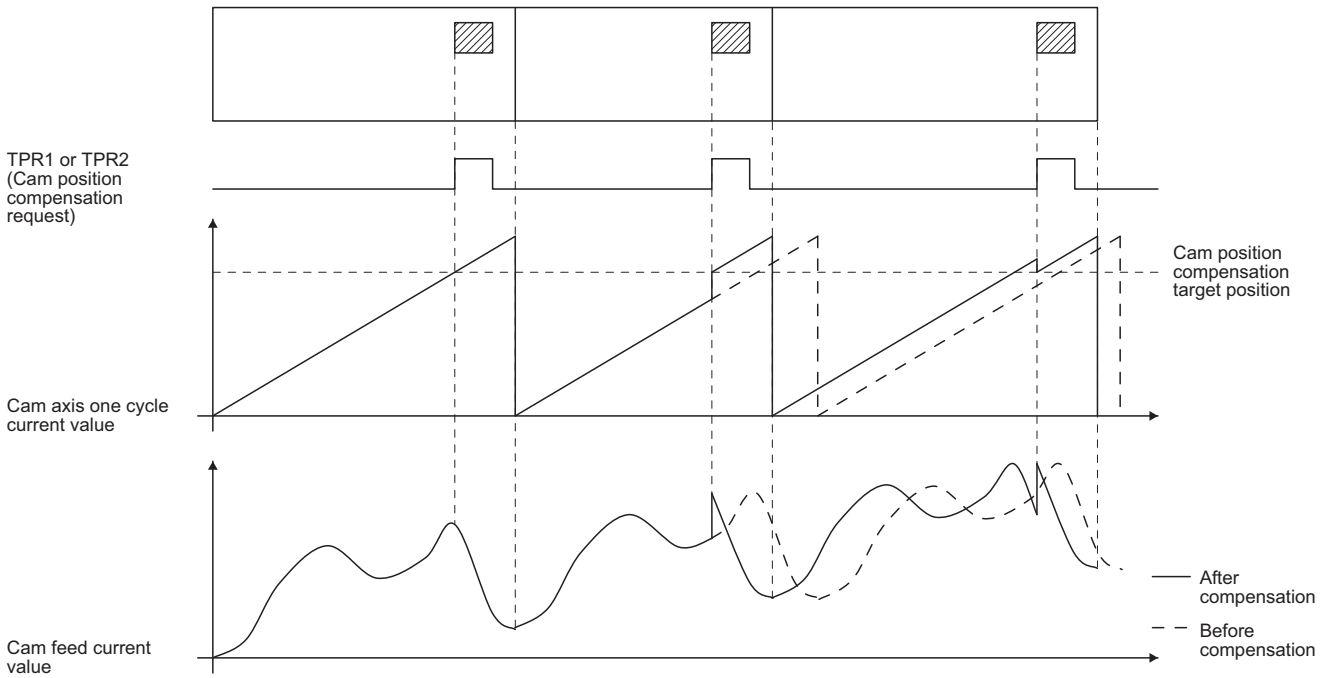

# Cam position compensation time constant

The compensation amount calculated when cam position compensation is requested is divided into the time set in [Cam control data No. 61 Cam position compensation time constant] and used for compensation.

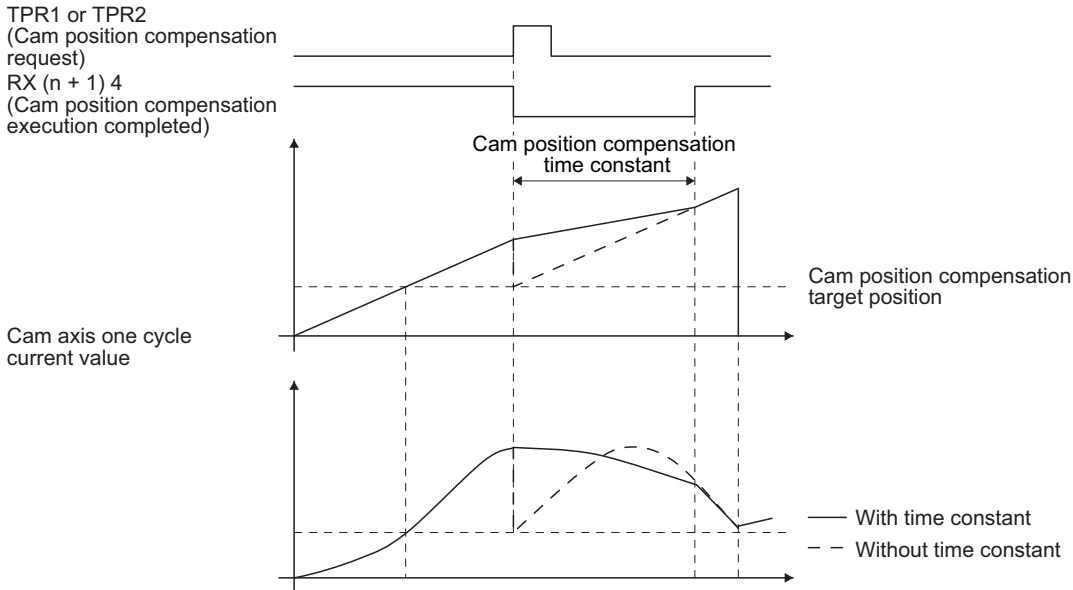

## Backup restore function

### Point

For details on the backup restore function, refer to section 17.3 in "MR-J4-<sub>GF</sub>(-RJ) Servo Amplifier Instruction Manual (Motion Mode)", and GOT User's Manual.

The backup/restoration function is a function for backing up and restoring all parameter data and point table data in MR-J4-<sub>GF</sub>(-RJ) to GOT by using SLMP. When executing cam backup and restore, the following restrictions apply.

- When the "Simple cam function selection" of [Pr. PT35] is disabled, cam data can be restored but backing it up is not possible. When backing up cam data, do so after enabling "Simple cam function selection" of [Pr. PT35].
- To prevent backup data inconsistencies, do not change the setting of [Pr. PT35] while backup is in progress.
- The cam data cannot be backed up while [AL. F5] is occurring. Execute backup after clearing [AL. F5].
- If the cam data is written with MR Configurator2 while backup is in progress, the data previously written will be used as the backup data.
- When restoring cam data, do so after network communication is established between the servo amplifier and controller.
- When restoring cam data for the second time, do so after cycling the power of the servo amplifier. Executing restoration without cycling the power will trigger [AL. F5.2 Cam data - Area miswriting warning].
- The cam data cannot be read or written with MR Configurator2 while restoration is in progress as doing so will trigger errors on MR Configurator2.
- The backup data including the cam data cannot be restored in servo amplifiers that do not support the simple cam function.

# 7.2 Override

## Analog override



Analog override can be used in the point table method and the indexer method.  
 When using the analog override function, set "Override selection" of [Pr. PT38] to "2".  
 When using analog override in the point table method or the indexer method, enable RY (n + 1) B (Analog override selection).

Analog override can be used in the following functions:

- Point table method/indexer method
- JOG operation
- Home position return mode in the point table method/indexer method

Analog override cannot be used in the following functions:

- Test operation mode (Positioning operation/JOG operation) with MR Configurator2

If the servo motor speed that has been changed with the analog override value exceeds the maximum speed of the servo motor, the servo motor speed will be limited to the maximum speed of the servo motor.

The servo motor speed can be changed by turning on RY (n + 1) B (Analog override selection) while RWwnF (Analog override) is set. The devices related to analog override are shown in the following table.

Item	Name	Remark
Device	RWwnF (Analog override)	The override value can be set. Set the override value in % unit in the range of 0 to 200 %.
	RY (n + 1) B (Analog override selection)	Turning on RY (n + 1) B enables the setting value of the analog override.

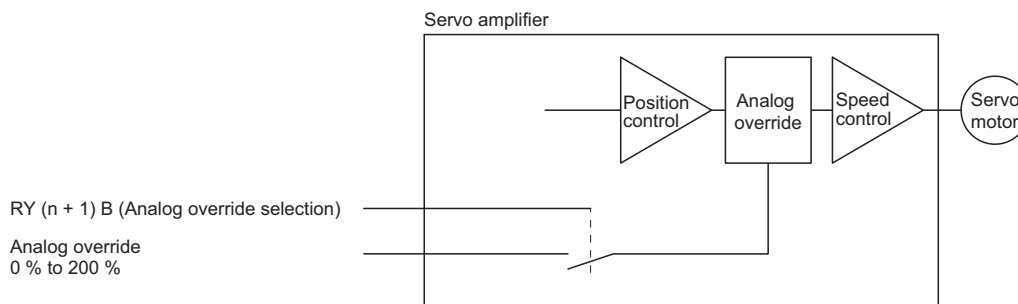

Use RY (n + 1) B (Analog override selection) to select the changing value as follows:

Servo parameter ([Pr. PT38])	RY (n + 1) B	Speed changing value
__2__	Off	No change will be made
	On	The setting value of RWwnF (Analog override) is enabled

# Digital override

The actual servo motor speed can be obtained by multiplying the command speed and the digital override value selected in RY (n + 1) C (Digital override selection 1) to RY (n + 1) F (Digital override selection 4).

**Ex.**

When [Pr. PT42] is set to 50 while [Pr. PT43] is set to 5

Servo parameter ([Pr. PT38])	Device *1				Description
	OV3	OV2	OV1	OV0	
-- 1 _	0	0	0	0	100 [%] of the speed set with the parameter
	0	0	0	1	50 [%] of the speed set with the parameter
	0	0	1	0	55 [%] of the speed set with the parameter
	0	0	1	1	60 [%] of the speed set with the parameter
	.	.	.	.	.
	.	.	.	.	.
	.	.	.	.	.
	1	1	0	1	110 [%] of the speed set with the parameter
	1	1	1	0	115 [%] of the speed set with the parameter
1	1	1	1	0 [%] of the speed set with the parameter	

\*1 0: Off  
1: On

- When [Pr. PT42] is set to 50 while [Pr. PT43] is set to 5 in the rotation direction specifying indexer

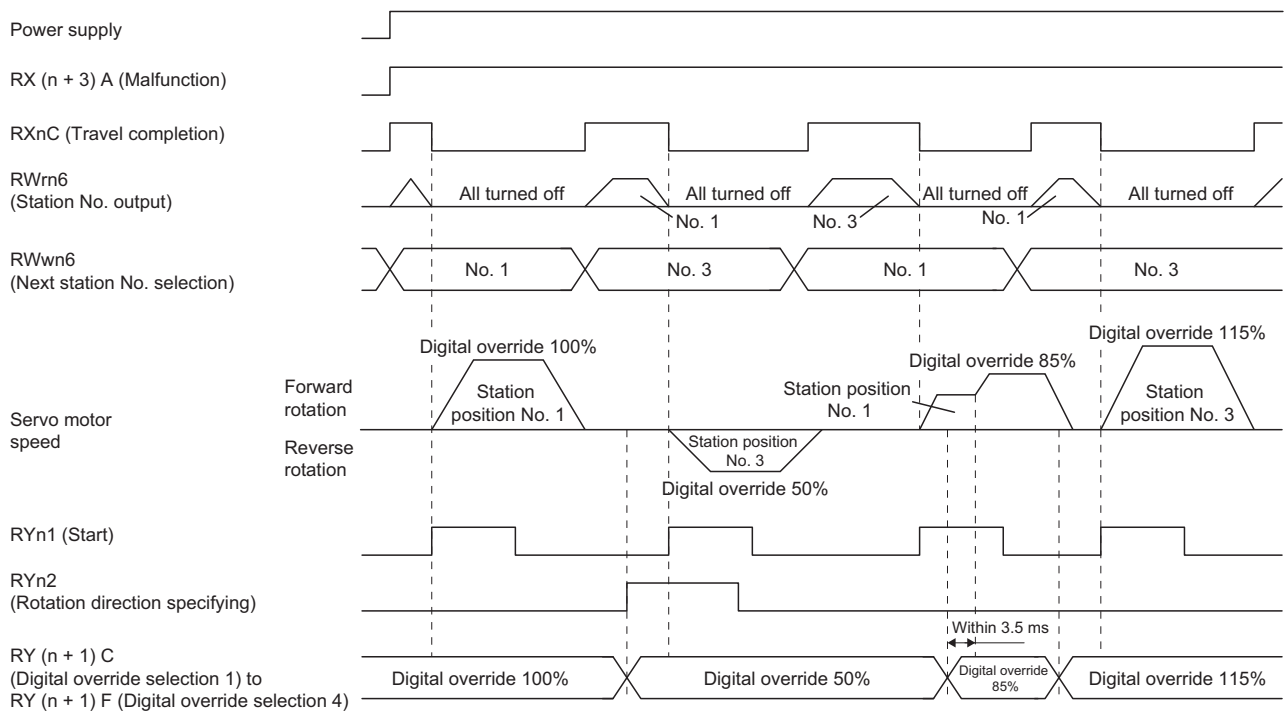



- When [Pr. PT42] is set to 50 while [Pr. PT43] is set to 5 in station JOG operation

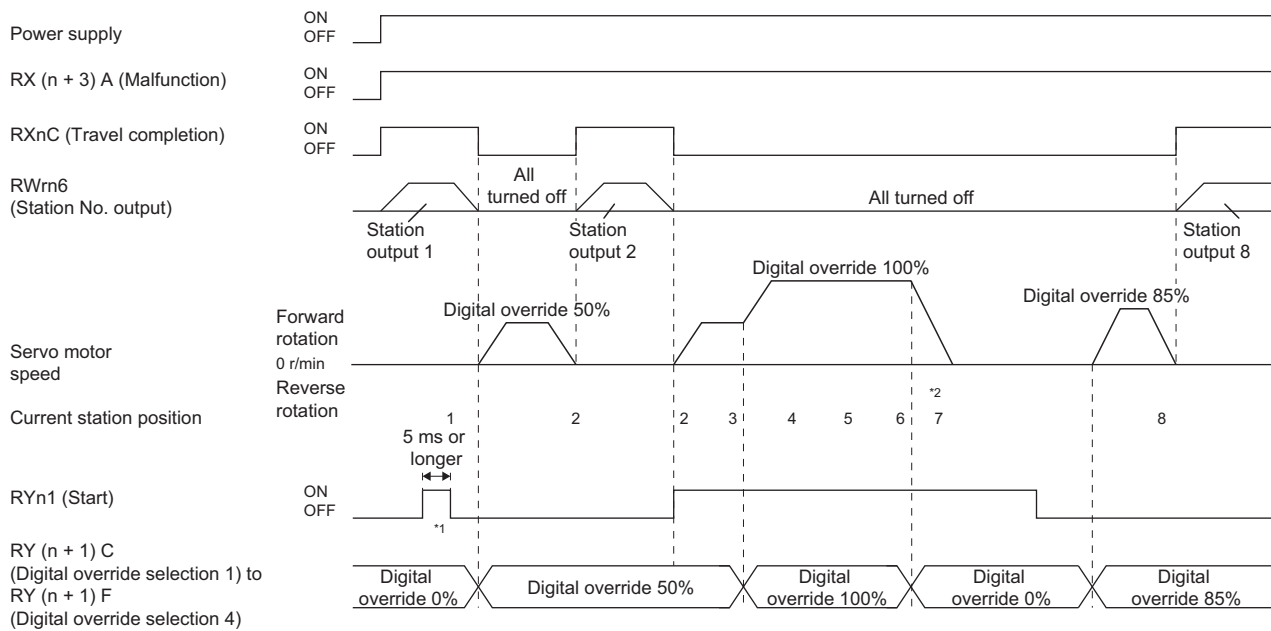

- \*1 In the manual operation mode, when RYn1 (Start) is turned on/off with the digital override 0 % then the digital override is set to other than 0 %, the servo motor stops at the closest station even when RYn1 is turned off.
- \*2 Setting the digital override to 0 % during operation decelerates the servo motor to a stop. After that, the JOG operation will resume if the digital override is set to other than 0 %. In that case, the servo motor stops at the closest station even when RYn1 is turned off.

## 7.3 Internal torque limit selection

### Device/parameter

The input devices and parameters are shown in the following.

- Input devices used for internal torque limit selection

Device name	Description
CTL	Internal torque limit selection of the input device
RY (n + 2) 6	Internal torque limit selection of the link device

- Parameters set with internal torque limit selection

Parameter	Symbol	Description
Pr. PA11	TLP	Forward rotation torque limit
Pr. PA12	TLN	Reverse rotation torque limit
Pr. PC77	TL2	Internal torque limit 2
Pr. PT11	ZTT	Stopper type home position return torque limit value
Pr. PT48 ( _ _ _ x)	TOP7A	Torque limit selection at stop

### Details of internal torque limit selection

#### For positioning mode (point table method) and speed control mode (point table method)

The torque limit values to be enabled are shown in the following table.

CTL and RY (n + 2) 6 (Internal torque limit selection)	Limit value status	Torque limit value to be enabled	
		CCW power running/CW regeneration	CW power running/CCW regeneration
Both are off	—	Pr. PA11	Pr. PA12
Either is on	Pr. PC77 > Pr. PA11 Pr. PA12	Pr. PA11	Pr. PA12
	Pr. PC77 < Pr. PA11 Pr. PA12	Pr. PC77	Pr. PC77

#### For stopper type home position return

The torque limit values to be enabled are shown in the following table.

CTL and RY (n + 2) 6 (Internal torque limit selection)	Limit value status	Torque limit value to be enabled	
		CCW power running/CW regeneration	CW power running/CCW regeneration
Both are off	—	Pr. PT11	Pr. PT11
Either is on	Pr. PC77 > Pr. PT11	Pr. PT11	Pr. PT11
	Pr. PC77 < Pr. PT11	Pr. PC77	Pr. PC77

## For the positioning mode (indexer method)

The torque limit values to be enabled are shown in the following table.

[Pr. PT48 (___x) Torque limit selection at stop]	CTL and RY (n + 2) 6 (Internal torque limit selection)	Operation status *1	Limit value status	Torque limit value to be enabled	
				CCW power running/CW regeneration	CW power running/CCW regeneration
0 (disabled)	Both are off	During a stop	—	Pr. PC77	Pr. PC77
		During operation	—	Pr. PA11	Pr. PA12
	Either is on	During a stop	—	Pr. PC77	Pr. PC77
		During operation	Pr. PC77 > Pr. PA11 Pr. PA12	Pr. PA11	Pr. PA12
			Pr. PC77 < Pr. PA11 Pr. PA12	Pr. PC77	Pr. PC77
		1 (enabled)	Both are off	During a stop	Pr. PC77 > Pr. PA11 Pr. PA12
Pr. PC77 < Pr. PA11 Pr. PA12	Pr. PC77				Pr. PC77
During operation	—			Pr. PA11	Pr. PA12
Either is on	During a stop		Pr. PC77 > Pr. PA11 Pr. PA12	Pr. PA11	Pr. PA12
			Pr. PC77 < Pr. PA11 Pr. PA12	Pr. PC77	Pr. PC77
	During operation		Pr. PC77 > Pr. PA11 Pr. PA12	Pr. PA11	Pr. PA12
		Pr. PC77 < Pr. PA11 Pr. PA12	Pr. PC77	Pr. PC77	

\*1 The status switches from "During a stop" to "During operation" while ST1 (Forward rotation start) is being turned on.  
The status switches from "During operation" to "During a stop" when the time set in [Pr. PT39] passes after MEND (Travel completion) is output.



# REVISIONS

\*The manual number is given on the bottom left of the back cover.

Revision Date	*Manual Number	Description
February 2016	SH(NA)-030221ENG-A	First edition
February 2017	SH(NA)-030221ENG-B	<p>Indexer positioning function and simple cam function are added.</p> <p>■4. Additional instructions (1) Transportation and installation The ambient humidity is changed.</p> <p>■4. Additional instructions (2) Wiring Partially added.</p> <p>■4. Additional instructions (5) Corrective actions Partially added.</p> <p>■4. Additional instructions (6) Maintenance, inspection and parts replacement Partially added and partially changed.</p> <p>■About the manual "MELSERVO MR-D30 Instruction Manual" is added.</p> <p>■Section 1.1 (1) Contents were partially added to the table.</p> <p>■Section 1.1 (2) Configuration change, (b) is newly added.</p> <p>■Section 1.2 "Indexer" is added.</p> <p>■Section 1.3 "Indexer" and "Simple cam function" are added.</p> <p>■Section 2.1.1 Partially changed and "Simple cam function" is added.</p> <p>■Section 2.1.2 "Simple cam function" is added.</p> <p>■Section 2.1.3 "Simple cam function" is added.</p> <p>■Section 2.1.4 Partially changed and "Simple cam function" is added.</p> <p>■Section 2.3.1 (1) (b) Partially changed.</p> <p>■Section 2.3.2 (3) Partially changed.</p> <p>■Section 2.4.1 (4) Partially changed.</p> <p>■Chapter 3 POINT is changed.</p> <p>■Section 3.1 "Indexer" and "Simple cam function" are added.</p> <p>■Section 3.2.1 [Pr. PA01], [Pr. PA06], and [Pr. PA07] are added. [Pr. PA10] is partially changed.</p> <p>■Section 3.2.2 Newly added.</p> <p>■Section 3.2.3 [Pr. PD12] is partially changed.</p> <p>■Section 3.2.4 [Pr. PT07], [Pr. PT12], [Pr. PT34], [Pr. PT62], and [Pr. PT69] are partially changed. [Pr. PT27], [Pr. PT35], [Pr. PT39], [Pr. PT40], and [Pr. PT45] are added.</p> <p>■Section 3.3.2 Newly added.</p> <p>■Chapter 5 Newly added.</p> <p>■Chapter 6 Newly added.</p>
February 2018	SH(NA)-030221ENG-C	Available on e-Manual. Partially changed.

Revision Date	*Manual Number	Description
December 2020	SH(NA)-030221ENG-D	<p>The speed control mode (point table method), the override function, and the infinite feed function are added. Degree unit is supported.</p> <p>■Section 1.1 Partially changed.</p> <p>■Section 1.2 Partially added and partially changed.</p> <p>■Section 1.3 Partially added.</p> <p>■Section 2.1 Partially added and partially changed.</p> <p>■Section 2.3 Partially added and partially changed.</p> <p>■Section 2.4 Partially changed.</p> <p>■Section 2.5 Partially changed.</p> <p>■Section 2.7 Newly added.</p> <p>■Section 3.1 Partially added and partially changed.</p> <p>■Section 3.2 Partially added and partially changed.</p> <p>■Section 3.4 Partially added and partially changed.</p> <p>■Section 4.2 Partially added and partially changed.</p> <p>■Section 5.1 Partially added and partially changed.</p> <p>■Section 5.3 Partially added and partially changed.</p> <p>■Section 5.4 Partially added and partially changed.</p> <p>■Section 5.5 Partially added and partially changed.</p> <p>■Section 5.6 Newly added.</p> <p>■Chapter 6 Newly added.</p> <p>■Section 7.1 Partially changed.</p> <p>■Section 7.2 Newly added.</p> <p>■Section 7.3 Newly added.</p>

Japanese manual number: SH-030220-D

This manual confers no industrial property rights of any other kind, nor does it confer any patent licenses. Mitsubishi Electric Corporation cannot be held responsible for any problems involving industrial property rights which may occur as a result of using the contents noted in this manual.

© 2016 MITSUBISHI ELECTRIC CORPORATION

# WARRANTY

---

## Warranty

### **1. Warranty period and coverage**

We will repair any failure or defect hereinafter referred to as "failure" in our FA equipment hereinafter referred to as the "Product" arisen during warranty period at no charge due to causes for which we are responsible through the distributor from which you purchased the Product or our service provider. However, we will charge the actual cost of dispatching our engineer for an on-site repair work on request by customer in Japan or overseas countries. We are not responsible for any on-site readjustment and/or trial run that may be required after a defective unit are repaired or replaced.

[Term]

For terms of warranty, please contact your original place of purchase.

[Limitations]

(1) You are requested to conduct an initial failure diagnosis by yourself, as a general rule.

It can also be carried out by us or our service company upon your request and the actual cost will be charged. However, it will not be charged if we are responsible for the cause of the failure.

(2) This limited warranty applies only when the condition, method, environment, etc. of use are in compliance with the terms and conditions and instructions that are set forth in the instruction manual and user manual for the Product and the caution label affixed to the Product.

(3) Even during the term of warranty, the repair cost will be charged on you in the following cases;

1. a failure caused by your improper storing or handling, carelessness or negligence, etc., and a failure caused by your hardware or software problem
2. a failure caused by any alteration, etc. to the Product made on your side without our approval
3. a failure which may be regarded as avoidable, if your equipment in which the Product is incorporated is equipped with a safety device required by applicable laws and has any function or structure considered to be indispensable according to a common sense in the industry
4. a failure which may be regarded as avoidable if consumable parts designated in the instruction manual, etc. are duly maintained and replaced
5. any replacement of consumable parts (battery, fan, smoothing capacitor, etc.)
6. a failure caused by external factors such as inevitable accidents, including without limitation fire and abnormal fluctuation of voltage, and acts of God, including without limitation earthquake, lightning and natural disasters
7. a failure generated by an unforeseeable cause with a scientific technology that was not available at the time of the shipment of the Product from our company
8. any other failures which we are not responsible for or which you acknowledge we are not responsible for

### **2. Term of warranty after the stop of production**

(1) We may accept the repair at charge for another seven (7) years after the production of the product is discontinued. The announcement of the stop of production for each model can be seen in our Sales and Service, etc.

(2) Please note that the Product (including its spare parts) cannot be ordered after its stop of production.

### **3. Service in overseas countries**

Our regional FA Center in overseas countries will accept the repair work of the Product. However, the terms and conditions of the repair work may differ depending on each FA Center. Please ask your local FA center for details.

### **4. Exclusion of loss in opportunity and secondary loss from warranty liability**

Regardless of the gratis warranty term, Mitsubishi shall not be liable for compensation to:

- (1) Damages caused by any cause found not to be the responsibility of Mitsubishi.
- (2) Loss in opportunity, lost profits incurred to the user by Failures of Mitsubishi products.
- (3) Special damages and secondary damages whether foreseeable or not, compensation for accidents, and compensation for damages to products other than Mitsubishi products.
- (4) Replacement by the user, maintenance of on-site equipment, start-up test run and other tasks.

### **5. Change of Product specifications**

Specifications listed in our catalogs, manuals or technical documents may be changed without notice.

### **6. Application and use of the Product**

- (1) For the use of our AC Servo, its applications should be those that may not result in a serious damage even if any failure or malfunction occurs in AC Servo, and a backup or fail-safe function should operate on an external system to AC Servo when any failure or malfunction occurs.
- (2) Our AC Servo is designed and manufactured as a general purpose product for use at general industries. Therefore, applications substantially influential on the public interest for such as atomic power plants and other power plants of electric power companies, and also which require a special quality assurance system, including applications for railway companies and government or public offices are not recommended, and we assume no responsibility for any failure caused by these applications when used.  
In addition, applications which may be substantially influential to human lives or properties for such as airlines, medical treatments, railway service, incineration and fuel systems, man-operated material handling equipment, entertainment machines, safety machines, etc. are not recommended, and we assume no responsibility for any failure caused by these applications when used. We will review the acceptability of the abovementioned applications, if you agree not to require a specific quality for a specific application. Please contact us for consultation.

# TRADEMARKS

---

MELSERVO and CC-Link IE are trademarks or registered trademarks of Mitsubishi Electric Corporation in Japan and/or other countries.

Ethernet is a registered trademark of Fuji Xerox Co., Ltd. in Japan.

All other product names and company names are trademarks or registered trademarks of their respective companies.





SH(NA)-030221ENG-D(2012)MEE

MODEL: MR-J4-GF-(RJ)INSTRUCTIONMANUAL(IO MODE)

MODEL CODE: 1CW863

## **MITSUBISHI ELECTRIC CORPORATION**

HEAD OFFICE : TOKYO BUILDING, 2-7-3 MARUNOUCHI, CHIYODA-KU, TOKYO 100-8310, JAPAN  
NAGOYA WORKS : 1-14 , YADA-MINAMI 5-CHOME , HIGASHI-KU, NAGOYA , JAPAN

When exported from Japan, this manual does not require application to the  
Ministry of Economy, Trade and Industry for service transaction permission.

Specifications subject to change without notice.