

MITSUBISHI

General Purpose AC SERVO

MELSERVO-J2-C-S100

- Specifications -

 **MITSUBISHI ELECTRIC CO.**
NAGOYA – WORKS

SH(NA)3197B

- Contents
- 1. Summary
- 2. Specification listing
- 3. Typical wiring example
- 4. Terminal blocks
- 5. Program language specifications
- 6. Automatic program-operation
- 7. Manual-operations
- 8. Zero point return operations
- 9. Display
- 10. Parameters
- 11. Set-up S/W
- 12. Serial communication (RS-232C / 485)
- 13. Trouble shooting

1. Summary

This installation guide describes installation of the 1 axis positioning controller amplifier

MR-J2-□□ C-S100 and how to program operation.

[The dimension of the amplifiers and applied servo motors are same as the standard MR-J2-C series spec]

(1) Functions

- 1) Simple language for program operation. (Maximum 60 steps programming with Windows based S/W)
- 2) RS-232C/485 Serial Communication (separate communication available)
- 3) Zero point return by : DOG method, Count method, Data set method, Stopper method and SON Point method.
- 4) Incremental and Absolute commands.
- 5) Absolute position detection system.
- 6) Manual pulse generator input.
- 7) Acceleration and Deceleration can be set with individual leaner carve.
- 8) S-pattern acceleration / deceleration time.
- 9) Maximum delay time of 3 ms (or less) from start signal input to motor movement.

<Model definition>

Servo amplifier

MR - J2 - □□ C - S100

└─ Amplifier Capacity

10 : 50/100W

20 : 200W

40 : 400W

60 : 600W

70 : 700W

100 : 1kW

200 : 2kW

350 : 3.5kW

<Program operation>



- Programming and monitoring by Windows™ based S/W

Program example.

| | |
|-----------|--|
| TIMES(3) | Program count command |
| STC(100) | Acceleration / Deceleration time 100[msec] |
| SPN(2000) | Motor speed 2000[r/min.] |
| MOV(5000) | Move command 5000[$\times 10^5 \mu\text{m}$] |
| SYNC(1) | Waiting for external signal to switch ON |
| : | : |
| STOP | Program stop |

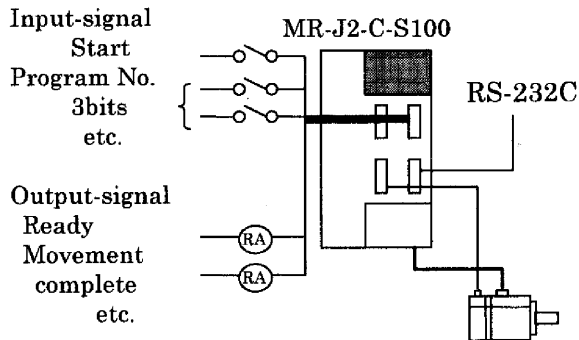

- The program will be transmitted to MR-J2-C-S100 via serial communication.
- Program number can select by external "PS" switches.
 - Program execution by "ST1" input or via serial communication
- Delay time is 3 ms(or less) after Start signal input to motor movement.

2. Specification listing

(1) Programming

| | |
|---------------------------|--|
| Operating | <ul style="list-style-type: none"> - Simple programming language (Programming with Setup S/W). - Programming capacity : Up to 8 programs , 60 steps Max. |
| Positioning command input | <ul style="list-style-type: none"> - Setting by Simple programming language. - Movement setting range at 1 point : $\pm 1 (\mu\text{m}) \sim \pm 999.999(\text{mm})$. |
| Speed command input | <ul style="list-style-type: none"> - Speed and Acc/Dec times setting by simple programming language. - S-pattern Acc/Dec time can set by parameter 14. |
| System | <ul style="list-style-type: none"> - Absolute / Incremental. |
| Automatic operation mode | <ul style="list-style-type: none"> - Setting by programming language. |

(2) Manual operation mode

| | |
|------------------------|---|
| JOG | External input switch or RS-232C / 485 communication |
| Manual pulse generator | <p>Manual operation by manual pulse generator.</p> <ul style="list-style-type: none"> - Input pulse : 90 degree differential phase pulse. (A / B) Open corrector type ----- times 4 - Max. Input pulse frequency : 200 kpps - Command pulse times : Times 1 , 10 or 100 (Parameter No.01) |

(3) Zero point return mode

| | |
|------------------|--|
| DOG method | <p>The Zero point is the first Z-phase point after the DOG turns OFF.</p> <ul style="list-style-type: none"> - Zero point address setting - Zero point shift value setting - Zero point return direction setting - Automatic back feed on DOG - Automatic back stroke function (for securing stroke) |
| Count method | <p>The Zero point is the Encoder pulse count after DOG turns ON.</p> <ul style="list-style-type: none"> - Zero point address setting. - Zero point shift value setting. - Zero point return direction setting. - Automatic back feed on DOG . - Automatic back stroke function (for securing stroke). |
| Data set method | <p>Zero point return without DOG switch.</p> <ul style="list-style-type: none"> - Setting any position by manual operation. - Zero point address setting. |
| Stopper method | <p>Zero point return at stopper position of stroke.</p> <ul style="list-style-type: none"> - Zero point address setting . |
| SON Point method | <p>The Zero point is set when SON signal turns ON.</p> <ul style="list-style-type: none"> - Zero point address setting. |

| | |
|------------------------------|---|
| Positioning control function | <ul style="list-style-type: none"> - Absolute position detection system. - S/W stroke limit. - Backlash compensation function. - Prevent the over-travel by external limit switch. - Override with external analog signal. |
|------------------------------|---|

(4) Servo amplifier

| Servo-amp model MR-J2- | | 10C-S100 | 20C-S100 | 40C-S100 | 60C-S100 | 70C-S100 |
|--------------------------|-----------------------------------|---|----------|----------|----------|----------|
| Power supply | Voltage/Frequency | 3-phase AC200V~230V, 50/60Hz or single-phase 230VAC, 50/60Hz | | | | |
| | Permissible voltage fluctuation. | 3-phase AC170V~253V, 50/60Hz or single-phase 207~253VAC, 50/60Hz | | | | |
| | Permissible frequency fluctuation | ± 5% max. | | | | |
| Control system | | Sinusoidal PWM control / Current control system | | | | |
| Dynamic brake | | Internally | | | | |
| Safety features | | Excess current shutdown, Regeneration excess voltage shutdown, Excess load shutdown (electronic thermal), Servo motor overheat protection, Encoder error protection, Regeneration error protection, Insufficient voltage/sudden power outage protection, Excess speed protection, Excess error protection | | | | |
| Speed frequency response | | 250Hz or more | | | | |
| Structure | | Open (IP00) | | | | |
| Environment | Ambient temperature | 0~+55°C (32 to 131°F)(avoid freezing), storage: -20~+65°C (-4 to 149°F) (avoid freezing) | | | | |
| | Ambient humidity | 90%RH max. (avoid freezing), storage: 90%RH max. (avoid freezing) | | | | |
| | Atmosphere | Inside control panel : no corrosive gas, flammable gas, Oil mist, or dust | | | | |
| | Elevation | 1000m or less above sea level | | | | |
| | Oscillation | 5.9m/s ² {0.6G} max. | | | | |
| Weight kg/(lb.) | | 0.7(1.7) | 0.7(1.7) | 1.1(2.4) | 1.1(2.4) | 1.7(3.8) |

| Servo-amp model MR-J2- | | 100C-S100 | 200C-S100 | 350C-S100 | | |
|--------------------------|-----------------------------------|---|-----------|-----------|--|--|
| Power supply | Voltage/Frequency | 3-phase AC200V ~230V, 50/60Hz | | | | |
| | Permissible voltage fluctuation. | 3-phase AC170V~253V, 50/60Hz | | | | |
| | Permissible frequency fluctuation | ±5% max. | | | | |
| Control system | | Sinusoidal PWM control / Current control system | | | | |
| Dynamic brake | | Internally | | | | |
| Safety features | | Excess current shutdown, Regeneration excess voltage shutdown, Excess load shutdown (electronic thermal), Servo motor overheat protection, Encoder error protection, Regeneration error protection, Insufficient voltage/sudden power outage protection, Excess speed protection, Excess error protection | | | | |
| Speed frequency response | | 250Hz or more | | | | |
| Structure | | Open (IP00) | | | | |
| Environment | Ambient temperature | 0~+55°C(32 to 131°F)(avoid freezing), storage: -20~+65°C (-4 to 149°F) (avoid freezing) | | | | |
| | Ambient humidity | 90%RH max. (avoid freezing), storage: 90%RH max. (avoid freezing) | | | | |
| | Atmosphere | Inside control panel : no corrosive gas, flammable gas, oil mist, or dust | | | | |
| | Elevation | 1000m or less above sea level | | | | |
| | Oscillation | 5.9m/s ² {0.6G} max. | | | | |
| Weight kg/(lb.) | | 1.7(3.8) | 2.0(4.4) | 2.0(4.4) | | |

3. Typical wiring example

-Some terminal function can be different by parameter setting-

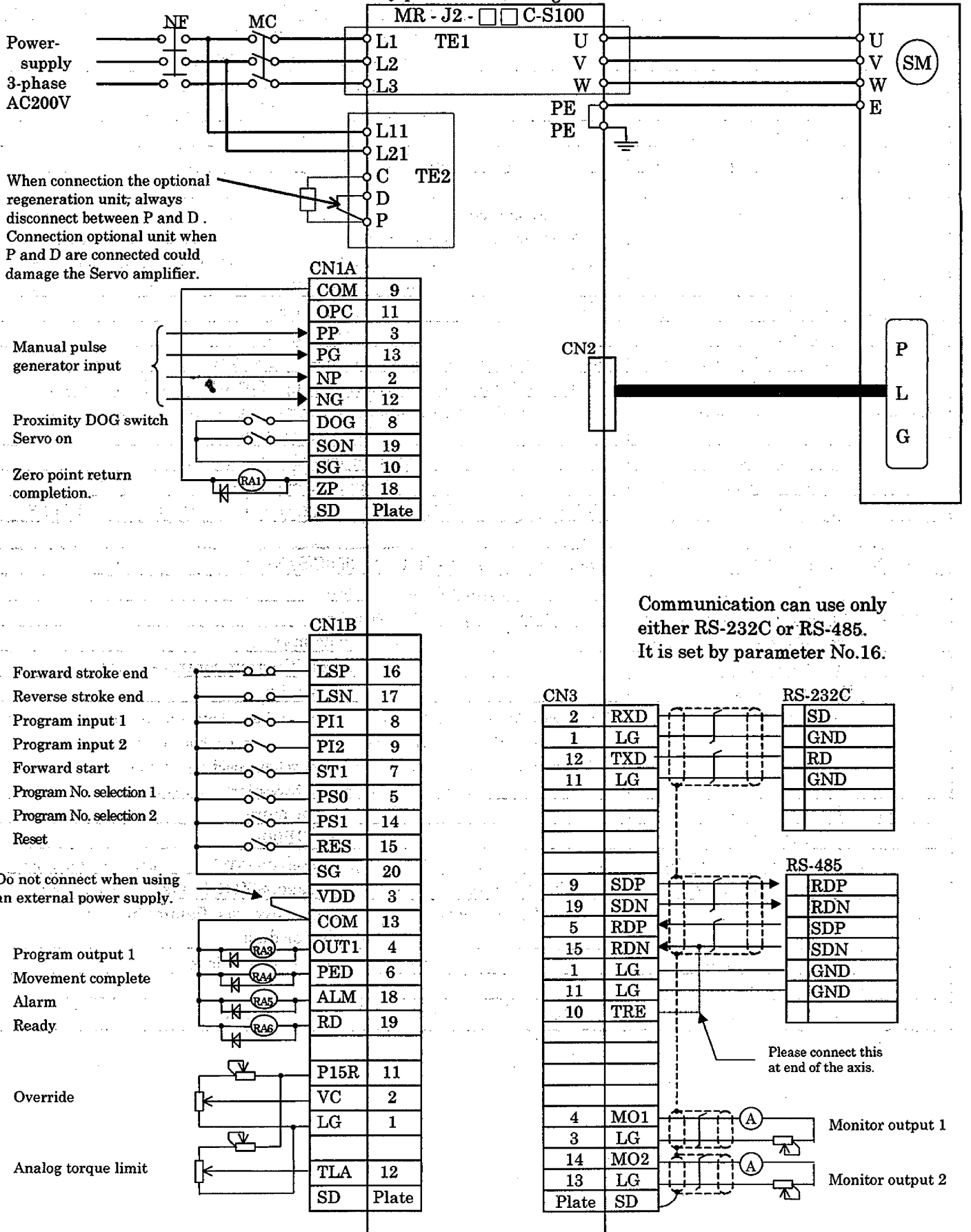

Note) Input / output function signals can be changed by the Setup-S/W.



Caution

1. Do not reverse the diode's direction. Connection it backwards could cause the amplifier to malfunction so that signals are not output and emergency stop and other safety circuit are inoperable.
2. The emergency stop switch must be installed.

Notice

3. When using the regenerative brake option, always disconnect between P and D.
4. CN1A, CN1B, CN2 and CN3 have the same sharp. Wrong connection of the connectors will lead to a fault. Connect them correctly.
5. Make sure that the sum of current flowing to external relays dose not exceed 80mA. If it exceed 80mA, supply interface power from an external source.

Memorandum

6. When starting operation, always connect the external emergency stop signal(EMG) and forward/reverse run stroke end signal(LSP/LSN)with SG .(b contact)
7. Signals with the same name are connected inside.
8. Malfunction (ALM) signals are turned ON during normal operation when no alarms have been triggered.
9. Connect the shield wire securely to the plate inside the connector(ground plate)

4. Terminal blocks

(1) Main circuit terminal block / Control circuit terminal block

| Signals | Symbols | Terminals | Descriptions |
|------------------------------|----------|---|--|
| Mail circuit power supply | L1,L2,L3 | TE1 | Main circuit power supply input terminals MR-J2-□□ C-S100 : Connect 3-phase AC 200 ~ 230V/50, 60Hz or Single-phase 230VAC,50/60Hz |
| Servo motor output | U,V,W | TE1 | Servo motor power output terminals Connect to the servo motor power supply terminals (U, V, W). |
| Control circuit power supply | L11,L21 | TE2 | Control circuit power supply input terminals L11 and L21 should be in phase with L1 and L2, respectively. MR-J2-□□ C-S100: Single-phase 200 ~ 230VAC, 50/60Hz |
| Regenerative brake option | P,C,D | TE2 | Regenerative brake option connection terminals P and D are factory-connected. When using the regenerative brake option, always remove wiring from across P-D and connect the regenerative brake option across P-C. |
| N | — | — | Not connect. |
| Protective earth | PE |  | Ground terminal Connect this terminal to the protective earth (PE) terminals of the servo motor and control box for grounding. |

(2) CN1A

| Signals | Symbols | Connector Pin No. | Functions / Applications |
|--------------------------------|---------|-------------------|---|
| Digital I/F power supply input | COM | 9 | Used to output 24VDC for input interface. Digital interface power supply input terminal. Connect the positive terminal of the 24VDC(200mA or more) external power supply. |
| Open corrector power input | OPC | 11 | When using a pulse train in the open collector from the Manual pulse generator, supply this terminal with the positive(+) power of 24VDC. |
| Digital I/F common | SG | 10, 20 | Common terminal for VDD and COM. Pins are connected internally. (24VDC common). Separated from LG. |
| power supply | P15R | 4 | Used to output 15VDC. |
| Control common | LG | 1 | Common terminal for 15VDC, 5VDC. |
| Forward run pulse train | PP | 3 | Used to enter a forward command pulse train. |
| | PG | 13 | Open collector system , Differential receiver system. |
| Reverse run pulse train | NP | 2 | Used to enter a reverse command pulse train. |
| | NG | 12 | Open collector system , Differential receiver system. |
| Proximity DOG | DOG | 8 | Proximity DOG signal input terminal.(DOG-SG) |
| Zero point return completion | ZP | 18 | Zero point return completion output terminal. ZP-SG are connected when Zero point return completed. In the absolute position detection system, ZP-SG are connected when SON is ON and the controller is ready to operate. |
| Servo ON | SON | 19 | Connect SON-SG to switch on the base circuit and make the servo amplifier ready to operate (Servo-ON). Disconnect SON-SG to shut off the base circuit (Servo-OFF) and coast the servo motor. |
| Shield | SD | Plate | Connect the external conductor of the shield cable. |

(3) CN1B

| Signals | Symbols | Connector Pin No. | Functions / Applications | | | | | | | | | | | | | | | | | | | | | | | | | | | | | | | | | | | | |
|--------------------------------|------------|-------------------|---|-----|-----|-----|----------------------|---|---|---|--------------|---|---|---|--------------|---|---|---|--------------|---|---|---|--------------|---|---|---|--------------|---|---|---|--------------|---|---|---|--------------|---|---|---|--------------|
| I/F internal power supply | VDD | 3 | Driver's power terminal for digital interface. Outputs 24V±10% between 24V commons SG. Connect to Vin when not using an external power supply. Do not allow the sum of current for the command unit and input/output relay drive to exceed 80mA. | | | | | | | | | | | | | | | | | | | | | | | | | | | | | | | | | | | | |
| Digital I/F power supply input | COM | 13 | Used to output 24VDC for input interface. Digital interface power supply input terminal. Connect the positive terminal of the 24VDC(200mA or more) external power supply. | | | | | | | | | | | | | | | | | | | | | | | | | | | | | | | | | | | | |
| power supply | P15R | 11 | Used to output 15VDC. | | | | | | | | | | | | | | | | | | | | | | | | | | | | | | | | | | | | |
| Digital I/F common | SG | 10,20 | Common terminal for VDD and COM. Pins are connected internally. (24VDC common). Separated from LG. | | | | | | | | | | | | | | | | | | | | | | | | | | | | | | | | | | | | |
| Control common | LG | 1 | Common terminal for 15VDC, 5VDC. | | | | | | | | | | | | | | | | | | | | | | | | | | | | | | | | | | | | |
| Forward run stroke end | LSP | 16 | Forward run stroke end input terminal. The forward run stroke end signal must be ON to run the servo motor (CW direction). Connecting LSP and SG makes the unit operable in a CW direction, but inoperable in a CCW direction. | | | | | | | | | | | | | | | | | | | | | | | | | | | | | | | | | | | | |
| Reverse run stroke end | LSN | 17 | Reverse run stroke end input terminal. The reverse run stroke end signal must be ON to run the servo motor (CCW direction). Connecting LSP and SG makes the unit operable in a CCW direction, but inoperable in a CW direction. | | | | | | | | | | | | | | | | | | | | | | | | | | | | | | | | | | | | |
| Program input-1 | PI1 | 8 | Program input device terminal - 1. During to running program, signal to commanded SYNC(1). | | | | | | | | | | | | | | | | | | | | | | | | | | | | | | | | | | | | |
| Program input-2 | PI2 | 9 | Program input device terminal - 2. During to running program, signal to commanded SYNC(2). | | | | | | | | | | | | | | | | | | | | | | | | | | | | | | | | | | | | |
| Forward start | ST1 | 7 | Forward start signal input terminal. In the program operation mode, connection between ST1-SG to start the commanded program number. In the JOG operation mode, connected ST1-SG to runs the motor in the forward JOG operation. | | | | | | | | | | | | | | | | | | | | | | | | | | | | | | | | | | | | |
| Program No. selection | PS0 PS1 | 5 14 | <p>Program number selection input terminal. DIO and DI1 relationship between signal status and operation are as follows.</p> <table border="1" style="margin-left: 20px;"> <thead> <tr> <th>PS2</th> <th>PS1</th> <th>PS0</th> <th>Selected program No.</th> </tr> </thead> <tbody> <tr><td>0</td><td>0</td><td>0</td><td>Program No.1</td></tr> <tr><td>0</td><td>0</td><td>1</td><td>Program No.2</td></tr> <tr><td>0</td><td>1</td><td>0</td><td>Program No.3</td></tr> <tr><td>0</td><td>1</td><td>1</td><td>Program No.4</td></tr> <tr><td>1</td><td>0</td><td>0</td><td>Program No.5</td></tr> <tr><td>1</td><td>0</td><td>1</td><td>Program No.6</td></tr> <tr><td>1</td><td>1</td><td>0</td><td>Program No.7</td></tr> <tr><td>1</td><td>1</td><td>1</td><td>Program No.8</td></tr> </tbody> </table> <p>PS2 is not in the factory default. It is necessary to allocate by parameter No.59-63. 0 : Open 1 : Short</p> | PS2 | PS1 | PS0 | Selected program No. | 0 | 0 | 0 | Program No.1 | 0 | 0 | 1 | Program No.2 | 0 | 1 | 0 | Program No.3 | 0 | 1 | 1 | Program No.4 | 1 | 0 | 0 | Program No.5 | 1 | 0 | 1 | Program No.6 | 1 | 1 | 0 | Program No.7 | 1 | 1 | 1 | Program No.8 |
| PS2 | PS1 | PS0 | Selected program No. | | | | | | | | | | | | | | | | | | | | | | | | | | | | | | | | | | | | |
| 0 | 0 | 0 | Program No.1 | | | | | | | | | | | | | | | | | | | | | | | | | | | | | | | | | | | | |
| 0 | 0 | 1 | Program No.2 | | | | | | | | | | | | | | | | | | | | | | | | | | | | | | | | | | | | |
| 0 | 1 | 0 | Program No.3 | | | | | | | | | | | | | | | | | | | | | | | | | | | | | | | | | | | | |
| 0 | 1 | 1 | Program No.4 | | | | | | | | | | | | | | | | | | | | | | | | | | | | | | | | | | | | |
| 1 | 0 | 0 | Program No.5 | | | | | | | | | | | | | | | | | | | | | | | | | | | | | | | | | | | | |
| 1 | 0 | 1 | Program No.6 | | | | | | | | | | | | | | | | | | | | | | | | | | | | | | | | | | | | |
| 1 | 1 | 0 | Program No.7 | | | | | | | | | | | | | | | | | | | | | | | | | | | | | | | | | | | | |
| 1 | 1 | 1 | Program No.8 | | | | | | | | | | | | | | | | | | | | | | | | | | | | | | | | | | | | |
| Program Output 1 | OUT1 | 4 | Program output1 device. OUT1 is device signal when commanded OUTON(1)/OUTOF(1) in the program. It is possible turn on time by Parameter No.54. | | | | | | | | | | | | | | | | | | | | | | | | | | | | | | | | | | | | |
| Movement complete | PED | 6 | Movement complete synchronous output device. After the command remaining distance and smoothing reach zero, this signal is output (PED-SG are connected) within the droop pulses set in Parameter No.12. | | | | | | | | | | | | | | | | | | | | | | | | | | | | | | | | | | | | |
| Malfunction | ALM | 18 | Malfunction signal output terminal. ALM-SG are disconnected when power is turned off or the protective circuit is activated to shut off the base circuit. | | | | | | | | | | | | | | | | | | | | | | | | | | | | | | | | | | | | |
| Ready | RD | 19 | Ready signal output terminal. RD-SG are connected after servo is turned on when there are no malfunction and the unit is operable. | | | | | | | | | | | | | | | | | | | | | | | | | | | | | | | | | | | | |
| Reset | RES | 15 | Alarm reset signal input device. Short-circuiting RES-SG causes the malfunction to be rest. | | | | | | | | | | | | | | | | | | | | | | | | | | | | | | | | | | | | |
| Shield | SD | Plate | Connect to one of the shield wire. | | | | | | | | | | | | | | | | | | | | | | | | | | | | | | | | | | | | |

(4) CN3

| Signals | Symbols | Connector Pin No. | Functions / Applications |
|-----------------------------|---------|-------------------|--|
| Monitor output | MO1 | 4 | Monitor output signal terminal. |
| | MO2 | 14 | Analog output of the parameter-set data. |
| RS-485I/F | SDP | 9 | RS-485 communication terminal. RS-485 and RS-232C can not use both together, select by parameter No.16. |
| | SDN | 19 | |
| | RDP | 5 | |
| | RDN | 15 | |
| RS-485 termination resistor | TRE | 10 | RS-485I/F termination resistor terminal. Connection between TRE and RDN. |
| RS-232C I/F | TXD | 2 | RS-232C communication terminal. |
| | RXD | 12 | RS-232C and RS-485 can not use both together, select by parameter No.16. |
| Monitor common | LG | 3,13 | Control common is used for monitor common. |
| Shield | SD | Plate | Connect to one of the shield wire. |

(5) Function devices

The following devices can be set the external I/O with Windows based S/W(MRZJW3-SETUP51E)
And also available to be set with the communication individually.

Input Terminal Designation: Set by one of following parameters.

- Parameter No.59 for CN1A-8 and CN1A-19
- Parameter No.60 for CN1B-5 and CN1B-7
- Parameter No.61 for CN1B-8 and CN1B-9
- Parameter No.62 for CN1B-14 and CN1B-15
- Parameter No.63 for CN1B-16 and CN1B-17

Output Terminal Designation: Set by one of following parameters.

- Parameter No.66 for CN1A-18 and CN1A-19
- Parameter No.67 for CN1B-6 and CN1B-4
- Parameter No.68 for CN1B-18 and CN1B-19

Terminal CN1A-19 can be set as either Input or Output by Parameter No.58.

Note) The device can be changed without considering setting the parameter No. with set-up S/W.

Input devices

| Signals | Symbols | Descriptions | | | | | | | | | | | | | | | | | | | | | | | | | | | | | | | | |
|--------------------|---------------------|--|---------------------|---------------------|---------|---------------------|-------|---------------|-------|-----------------|-------|----------------|-------|---------------|-------|-------------|-------|--------------------|-------|----------------|-------|-----------------|-------|-----------------|-------|------------|-------|---------------|-------|------------|-------|---------------|--|--|
| None function | — | Nothing function | | | | | | | | | | | | | | | | | | | | | | | | | | | | | | | | |
| Emergency stop | EMG | Emergency stop input device. Disconnection EMG-SG puts the unit in emergency stop state ; power to the base is cut OFF and the dynamic brake is activated. Short circuiting EMG-SG in the emergency stop state causes the unit to automatically exit the emergency stop state. | | | | | | | | | | | | | | | | | | | | | | | | | | | | | | | | |
| Servo ON | SON | Preparation for operation signal input device. Short-circuiting SON-SG places the unit in an operable state. Disconnecting these terminals causes power to the base to be cut OFF and the servo motor to enter a free running condition. | | | | | | | | | | | | | | | | | | | | | | | | | | | | | | | | |
| Reset | RES | Alarm reset signal input device. Short-circuiting RES-SG causes the malfunction to be rest. While the alarm is being reset, power to the base is cut OFF. The following alarm can not be rest. <table border="1" style="margin: 10px auto;"> <thead> <tr> <th>Display</th> <th>Safety feature name</th> <th>Display</th> <th>Safety feature name</th> </tr> </thead> <tbody> <tr> <td>A. 11</td> <td>Board error 1</td> <td>A. 20</td> <td>Encoder error 2</td> </tr> <tr> <td>A. 12</td> <td>Memory error 1</td> <td>A. 25</td> <td>ABS data loss</td> </tr> <tr> <td>A. 13</td> <td>Clock error</td> <td>A. 30</td> <td>Regeneration error</td> </tr> <tr> <td>A. 15</td> <td>Memory error 1</td> <td>A. 37</td> <td>Parameter error</td> </tr> <tr> <td>A. 16</td> <td>Encoder error 1</td> <td>A. 50</td> <td>Overload 1</td> </tr> <tr> <td>A. 17</td> <td>Board error 2</td> <td>A. 51</td> <td>Overload 2</td> </tr> <tr> <td>A. 18</td> <td>Board error 3</td> <td></td> <td></td> </tr> </tbody> </table> Malfunctions related to Regeneration error and Overloading can not be reset with the alarm rest signal immediately after their occurrence. | Display | Safety feature name | Display | Safety feature name | A. 11 | Board error 1 | A. 20 | Encoder error 2 | A. 12 | Memory error 1 | A. 25 | ABS data loss | A. 13 | Clock error | A. 30 | Regeneration error | A. 15 | Memory error 1 | A. 37 | Parameter error | A. 16 | Encoder error 1 | A. 50 | Overload 1 | A. 17 | Board error 2 | A. 51 | Overload 2 | A. 18 | Board error 3 | | |
| Display | Safety feature name | Display | Safety feature name | | | | | | | | | | | | | | | | | | | | | | | | | | | | | | | |
| A. 11 | Board error 1 | A. 20 | Encoder error 2 | | | | | | | | | | | | | | | | | | | | | | | | | | | | | | | |
| A. 12 | Memory error 1 | A. 25 | ABS data loss | | | | | | | | | | | | | | | | | | | | | | | | | | | | | | | |
| A. 13 | Clock error | A. 30 | Regeneration error | | | | | | | | | | | | | | | | | | | | | | | | | | | | | | | |
| A. 15 | Memory error 1 | A. 37 | Parameter error | | | | | | | | | | | | | | | | | | | | | | | | | | | | | | | |
| A. 16 | Encoder error 1 | A. 50 | Overload 1 | | | | | | | | | | | | | | | | | | | | | | | | | | | | | | | |
| A. 17 | Board error 2 | A. 51 | Overload 2 | | | | | | | | | | | | | | | | | | | | | | | | | | | | | | | |
| A. 18 | Board error 3 | | | | | | | | | | | | | | | | | | | | | | | | | | | | | | | | | |
| Forward stroke end | LSP | Forward stroke end input device. Connecting LSP and SG makes the unit operable in a CW direction, but inoperable in a CCW direction. To operate in a CCW direction, connect between LSP and SG with a limit switch. | | | | | | | | | | | | | | | | | | | | | | | | | | | | | | | | |
| Reverse stroke end | LSN | Reverse stroke end input device. Connecting LSN and SG makes the unit operable in a CCW direction, but inoperable in a CCW direction. To operate in a CW direction, connect between LSP and SG with a limit switch. | | | | | | | | | | | | | | | | | | | | | | | | | | | | | | | | |
| Program input | PI1 PI2 PI3 | Program input device terminal. During to running program, PI1 is device signal when commanded SYNC(1). During to running program, PI2 is device signal when commanded SYNC(2). During to running program, PI3 is device signal when commanded SYNC(3). | | | | | | | | | | | | | | | | | | | | | | | | | | | | | | | | |

| Signals | Symbols | Descriptions | | | | | | | | | | | | | | | | | | | | | | | | | | | | | | | | | | | | |
|--|-------------------|--|----------------------|-----|--------------------------------------|----------------------|---|---------------------------|---|--------------|-----------------|---|---|------------------|---|---|-------------------|--------------|---|---|---|--------------|---|---|---|--------------|---|---|---|--------------|---|---|---|--------------|---|---|---|--------------|
| Forward start | ST1 | Forward start signal input terminal. In the program operation mode, connection between ST1-SG to start the commanded program number. In the JOG operation mode, connected ST1-SG to runs the motor in the forward JOG operation. (the forward means increasing address direction) | | | | | | | | | | | | | | | | | | | | | | | | | | | | | | | | | | | | |
| Reverse start | ST2 | Reverse JOG start signal input device. In the JOG operation mode, connected ST2-SG to runs the motor in the reverse JOG operation. (the reverse means decreasing address direction) | | | | | | | | | | | | | | | | | | | | | | | | | | | | | | | | | | | | |
| Automatic / manual selection | MD0 | Automatic and manual selection signal input device. Connection MD1-SG to the programming operation mode, disconnection MD1-SG to the JOG operation mode. After changed the mode to the programming operation from the JOG operation, re-command program number operation is necessary. | | | | | | | | | | | | | | | | | | | | | | | | | | | | | | | | | | | | |
| Proximity DOG | DOG | Proximity DOG switch input device: Short-circuited between DOG-SG, the DOG signal will be ON. | | | | | | | | | | | | | | | | | | | | | | | | | | | | | | | | | | | | |
| Program No. selection | PS0 PS1 PS2 | Program number selection signal input device. During the program operation mode, it is selected when ST1 signal up-edge. PS0,PS1 and PS2 relationship between the select signal and program number are as follows. <table border="1" style="margin-left: auto; margin-right: auto;"> <thead> <tr> <th>PI2</th> <th>PI1</th> <th>PI0</th> <th>Selected program No.</th> </tr> </thead> <tbody> <tr> <td>0</td> <td>0</td> <td>0</td> <td>Program No.1</td> </tr> <tr> <td>0</td> <td>0</td> <td>1</td> <td>Program No.2</td> </tr> <tr> <td>0</td> <td>1</td> <td>0</td> <td>Program No.3</td> </tr> <tr> <td>0</td> <td>1</td> <td>1</td> <td>Program No.4</td> </tr> <tr> <td>1</td> <td>0</td> <td>0</td> <td>Program No.5</td> </tr> <tr> <td>1</td> <td>0</td> <td>1</td> <td>Program No.6</td> </tr> <tr> <td>1</td> <td>1</td> <td>0</td> <td>Program No.7</td> </tr> <tr> <td>1</td> <td>1</td> <td>1</td> <td>Program No.8</td> </tr> </tbody> </table> <p style="text-align: right;">0 : Open 1 : Short</p> | PI2 | PI1 | PI0 | Selected program No. | 0 | 0 | 0 | Program No.1 | 0 | 0 | 1 | Program No.2 | 0 | 1 | 0 | Program No.3 | 0 | 1 | 1 | Program No.4 | 1 | 0 | 0 | Program No.5 | 1 | 0 | 1 | Program No.6 | 1 | 1 | 0 | Program No.7 | 1 | 1 | 1 | Program No.8 |
| PI2 | PI1 | PI0 | Selected program No. | | | | | | | | | | | | | | | | | | | | | | | | | | | | | | | | | | | |
| 0 | 0 | 0 | Program No.1 | | | | | | | | | | | | | | | | | | | | | | | | | | | | | | | | | | | |
| 0 | 0 | 1 | Program No.2 | | | | | | | | | | | | | | | | | | | | | | | | | | | | | | | | | | | |
| 0 | 1 | 0 | Program No.3 | | | | | | | | | | | | | | | | | | | | | | | | | | | | | | | | | | | |
| 0 | 1 | 1 | Program No.4 | | | | | | | | | | | | | | | | | | | | | | | | | | | | | | | | | | | |
| 1 | 0 | 0 | Program No.5 | | | | | | | | | | | | | | | | | | | | | | | | | | | | | | | | | | | |
| 1 | 0 | 1 | Program No.6 | | | | | | | | | | | | | | | | | | | | | | | | | | | | | | | | | | | |
| 1 | 1 | 0 | Program No.7 | | | | | | | | | | | | | | | | | | | | | | | | | | | | | | | | | | | |
| 1 | 1 | 1 | Program No.8 | | | | | | | | | | | | | | | | | | | | | | | | | | | | | | | | | | | |
| Override selection | OVR | Override selection input device. Short-circuit between OVR-SG to operable the external analog override. 0V input 100%, 10V input 200%, -10v input 0% | | | | | | | | | | | | | | | | | | | | | | | | | | | | | | | | | | | | |
| External torque limit selection | TL0 | External torque limit input device. Connection TL0-SG limit the torque to the external analog torque limit level. | | | | | | | | | | | | | | | | | | | | | | | | | | | | | | | | | | | | |
| Internal torque limit selection | TL1 | Internal torque limit input device. Disconnection TL1-SG limit the torque to the parameter No.28(TL1) level, connection TL1-SG limit the torque to the parameter No.29 (TL2) level. | | | | | | | | | | | | | | | | | | | | | | | | | | | | | | | | | | | | |
| Proportional control | PC | Proportional control input device. Connection PC-SG to the speed amplifier from the proportional integral type to the Proportional type. | | | | | | | | | | | | | | | | | | | | | | | | | | | | | | | | | | | | |
| Temporary stop/restart | STP | Temporary stop and restart input device. Push-button on the signal across STP-SG to the stop operation, during program operation, and re-push the button to restart operation where it had stopped. During the temporary stopping, short circuited SYNC(1)(2) signals which is ignored. During the temporary stopping, and mode changed from program operation to manual operation that would be cleared movement left distances automatically. During Zero point return operating, temporary stop/restart signals would be ignored. | | | | | | | | | | | | | | | | | | | | | | | | | | | | | | | | | | | | |
| Manual pulse generator magnification selection | TP0 TP1 | Manual pulse generator magnification selection input device. <table border="1" style="margin-left: auto; margin-right: auto;"> <thead> <tr> <th>TP1</th> <th>TP0</th> <th>Manual pulse generator magnification</th> </tr> </thead> <tbody> <tr> <td>0</td> <td>0</td> <td>Parameter setting (Pr-01)</td> </tr> <tr> <td>0</td> <td>1</td> <td>1 - time pulses</td> </tr> <tr> <td>1</td> <td>0</td> <td>10 - time pulses</td> </tr> <tr> <td>1</td> <td>1</td> <td>100 - time pulses</td> </tr> </tbody> </table> <p style="text-align: right;">0 : Open 1 : Short</p> | TP1 | TP0 | Manual pulse generator magnification | 0 | 0 | Parameter setting (Pr-01) | 0 | 1 | 1 - time pulses | 1 | 0 | 10 - time pulses | 1 | 1 | 100 - time pulses | | | | | | | | | | | | | | | | | | | | | |
| TP1 | TP0 | Manual pulse generator magnification | | | | | | | | | | | | | | | | | | | | | | | | | | | | | | | | | | | | |
| 0 | 0 | Parameter setting (Pr-01) | | | | | | | | | | | | | | | | | | | | | | | | | | | | | | | | | | | | |
| 0 | 1 | 1 - time pulses | | | | | | | | | | | | | | | | | | | | | | | | | | | | | | | | | | | | |
| 1 | 0 | 10 - time pulses | | | | | | | | | | | | | | | | | | | | | | | | | | | | | | | | | | | | |
| 1 | 1 | 100 - time pulses | | | | | | | | | | | | | | | | | | | | | | | | | | | | | | | | | | | | |

Output devices

| Signals | Symbols | Descriptions |
|---------------------------------|----------------------|--|
| None function | — | Nothing function |
| Ready | RD | Ready signal output device. RD-SG are connected after servo is turned on when there are no malfunction and the unit is operable. |
| Malfunction output | ALM | Malfunction signal output device. ALM-SG are disconnected when power is turned OFF or the protective circuit is activated to shut off the base circuit. If everything is normal when the power is turned ON, the connection is made. |
| Movement complete | PED | After the command remaining distance and smoothing reach zero, this signal is output within the droop pulses set in parameter No.12. |
| Zero point return complete | ZP | Zero point return complete output device. ZP-SG are connected upon completion of Zero point return. In an absolute position detection system, ZP-SG are connected when the controller is ready to operate. ZP-SG are disconnected when : <ol style="list-style-type: none"> 1) SON is OFF 2) Disconnected EMG-SG 3) RES is ON 4) Alarm has occurred 5) Forward / reverse run limit switch is OFF (LSP/LSN) 6) Never Zero point return operation 7) When never Zero point return operation after occurred A. 25 or A. E3. 8) When never Zero point return operation after changed electronics gear parameter. 9) When never Zero point return operation after changed ABS valid form invalid. 10) When changed ST1 status. 11) During the communication time out. |
| Position range output | POT | Position range output device. POT-SG are connected when the number of actual position address is in the preset position range. (During the base off and when not complete Zero point return, not output.) |
| Warning output | WNG | Warning output device. When occurred warning status, the connection between WNG-SG is made. |
| Battery warning output | BWNG | Battery warning output device. When occurred A. 92 or A. 9F, the connection between BWNG-SG is made. |
| Torque limit in effect | TLC | Torque limit in effect output device. When the set torque limit is reached, the connection between TLC-SG is made. Not output when the base is turned OFF. |
| Temporary stopping output | PUS | Temporary stopping output device. When stopping with temporary stop signal, the connection between PUS-GS is made. Output from deceleration start of the temporary stop. |
| Program output | OUT1 OUT2 OUT3 | Program output device. OUT1 is device signal when commanded OUTON(1)/OUTOF(1) in the program. OUT2 is device signal when commanded OUTON(2)/OUTOF(2) in the program. OUT3 is device signal when commanded OUTON(3)/OUTOF(3) in the program. |
| SYNC synchronous output | SOUT | SYNC synchronous output device. Connecting between SOUT-SG, when waiting for SYNC () command. |
| Electromagnetic brake interlock | MBR | Electromagnetic brake interlock output device. In the servo-OFF or alarm status, MBR-SG are disconnected. |
| Dynamic brake interlock | DBR | Dynamic brake interlock output device. |

(5) Notes of output signal

If the machine is directly driven by the D-O output device of MR-J2-S100, you need the following attention.

MR-J2-S100 can have 6 output device (CN1A-18, CN1B-14,-6,-18,-19,and reversible device CN1A-19).

As for CN1B-6, during amplifier initializing period, it differ from condition of other output device.

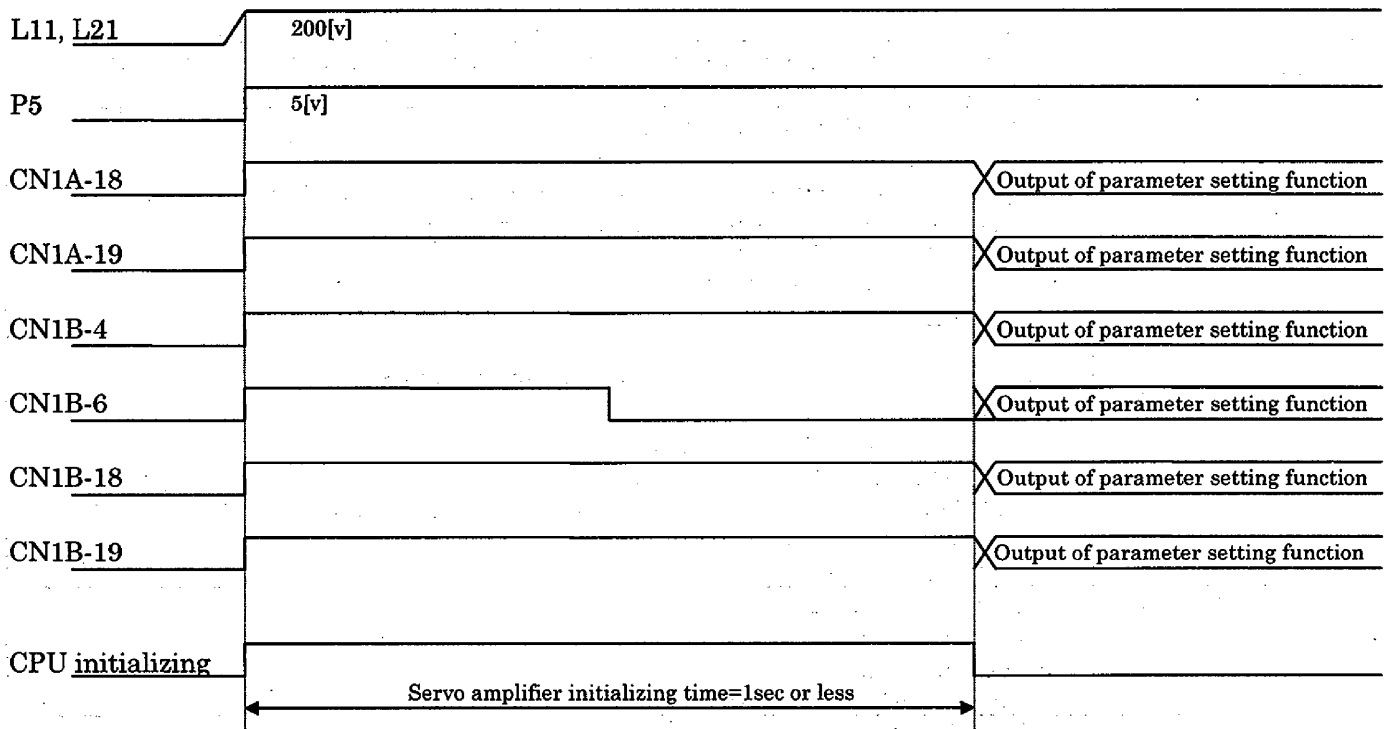

5. Program language specifications

(1) Program language specifications

- The language used in the program operation-edit window will be described below.
- Simple language for program operation (60 steps programming with Setup S/W)
- 8 program numbers within total 60 steps can be selected by external "PS" switches or communication.

| Command | Name | Setting (*: Set value) | Setting Range | Unit | Description |
|---------|--|---------------------------|---------------------|----------------------------|--|
| SPN | Speed (Motor speed) | SPN(**) | 0 ~ Max Speed | r/min | Used to set the command speed given to the motor for positioning. The set value should be not more than the maximum speed of the motor. |
| STC | Acceleration/ Deceleration time | STC(**) | 0~20000 | msec | Used to set both the acceleration and deceleration time. (Time required to reach the rated speed of the corresponding servo motor) STA and STB commands can set the acceleration and deceleration time Individually. It can not be changed during command outputting. |
| STA | Acceleration time | STA(**) | 0~20000 | msec | Used to set the acceleration time required to reach the rated speed from zero speed. It can not be changed during command outputting. |
| STB | Deceleration time | STB(**) | 0~20000 | msec | Used to set the deceleration time required to reach the rated speed from zero speed. It can not be changed during command outputting. |
| MOV | Move command | MOV(**) | -999999 ~ 999999 | × 10 ⁵ mm μm | Movement by set values. Positioning operation is performed with the set Values of the feed rate (SPN) and acceleration /deceleration time (STC) (STA) (STB). No symbol : CCW rotation. -CW rotation. Incremental system or absolute system can select by parameter. |
| MOVA | Continuous move command | MOVA(**) | -999999 ~ 999999 | × 10 ⁵ mm μm | Continuous movement by set values. Incremental system or absolute System can select by parameter. Programming point is after MOV command , otherwise error has occurred. Incremental system or absolute system can select by parameter. MOVA command must be at after MOV command, otherwise error has occurred. |
| SYNC | Waiting external signal to switch on | SYNC(**) | — | — | Used to hold the next operation until the preset digital input signal (DI) of the servo amplifier switches on. After SOUT output and On-edge signal is valid. |
| OUTON | External signal ON output | OUTON (**) | — | — | External output device signal turns ON (short). |
| OUTOF | External signal OFF output | OUTOF (**) | — | — | External output device signal turns OFF (open). |
| TRIP | Trip point | TRIP (**) | -999999~ 999999 | ×10 ⁵ mm μm | When the trip point is reached, the next step will be executed. |
| COUNT | External Pulse counter | COUNT (**) | -999999~ 999999 | pulse | The next step will be executed when external pulse input counter reach set counter value. COUNT(0) is clearing of the pulse counter. |
| TIM | Dwell command time | TIM(**) | 0, 1~2000 | ×10 msec | Used to hold the next operation until the preset time elapses. After smoothing 0, started to count up. |
| ZRT | Zero point return | ZRT | — | — | Zero point return operation. Set to the Zero point return method at parameter No.8. |
| TIMES | Program repeat Command | TIMES(**) | 0, 1~10000 | Times | Describe TIMES (setting value) at the head of the program, and STOP at the end of the program. The program will repeat execution number of times. This is not required when the program is to be run only once. The program will be run infinitely when 0 is set. It is not possible to repeatedly run a set part of a program. |
| STOP | Program end | — | — | — | Program stops signal, and it must be at end of the program. (Required) |

Note)

- 1) SYNC, OUTON, OUTOF, TRIP and COUNT commands are available to be validated during command outputting.
- 2) SPN, STA, STB and STC commands will be validated, when the MOV and MOVA command.
- 3) If you set the parameter by OUTON command. During setting time, this command does not execute following command.

(2) Details of programming languages

1) Positioning command conditions (SPN, STA, STB, STC)

SPN, STC, STA and STB commands will be validated, when the MOV and MOVA commands are executing. The setting numbers will be validated, expect resetting the numbers.

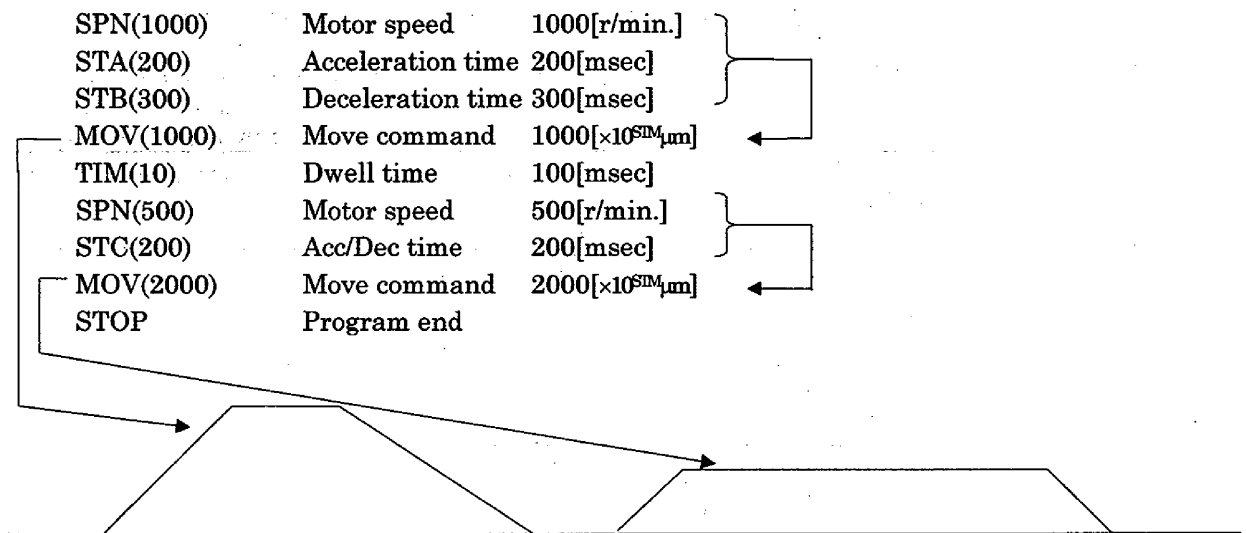
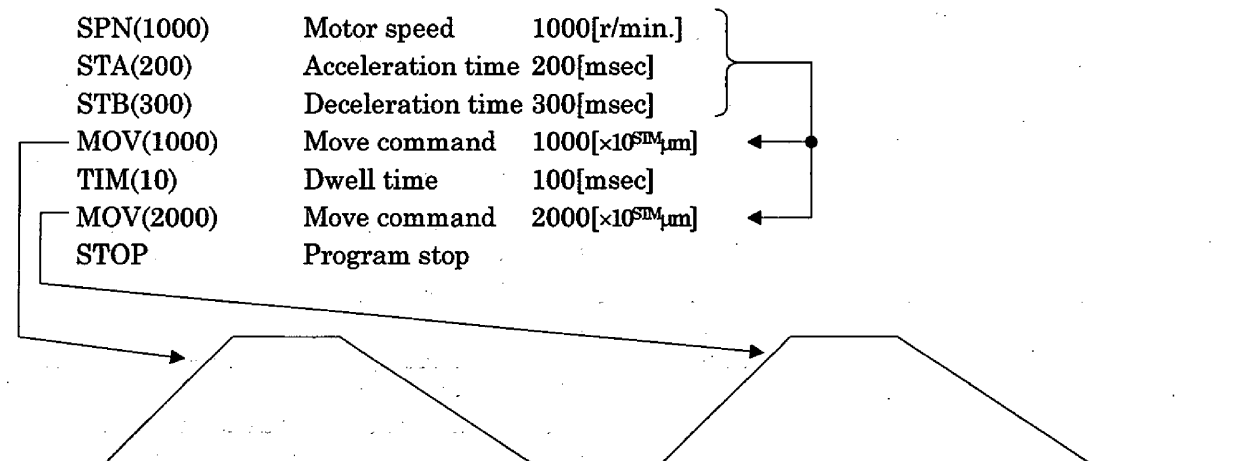

2) Move command (MOV, MOVA)

- MOVA command is continuous movement command of MOV / MOVA command.
- The change speed point of MOVA command is a deceleration begin point of the previous MOV / MOVA command when execution by along.
- The acceleration / deceleration time when continuous operation of MOVA command is execution value of previous MOV / MOVA command.

(if programming the MOVA command after the command output completed, setting number will be validated)

- MOVA command is available to programming to by along.

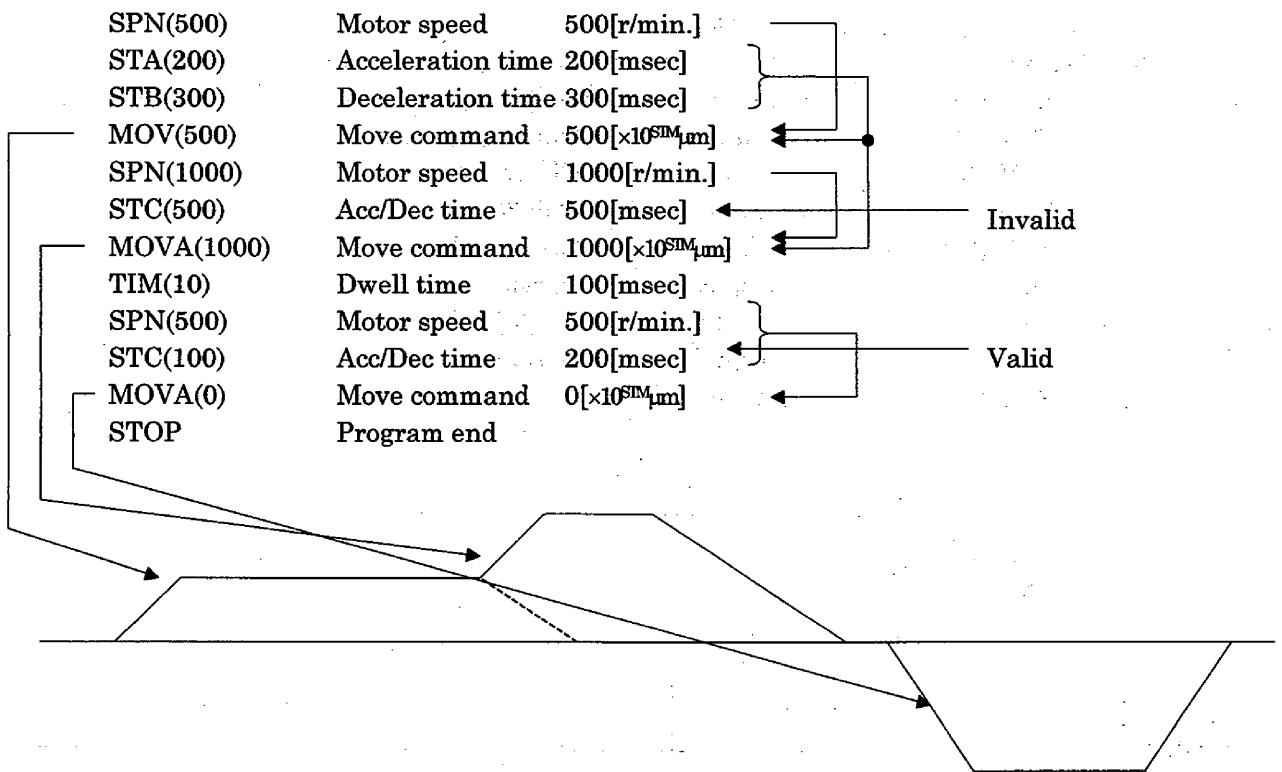
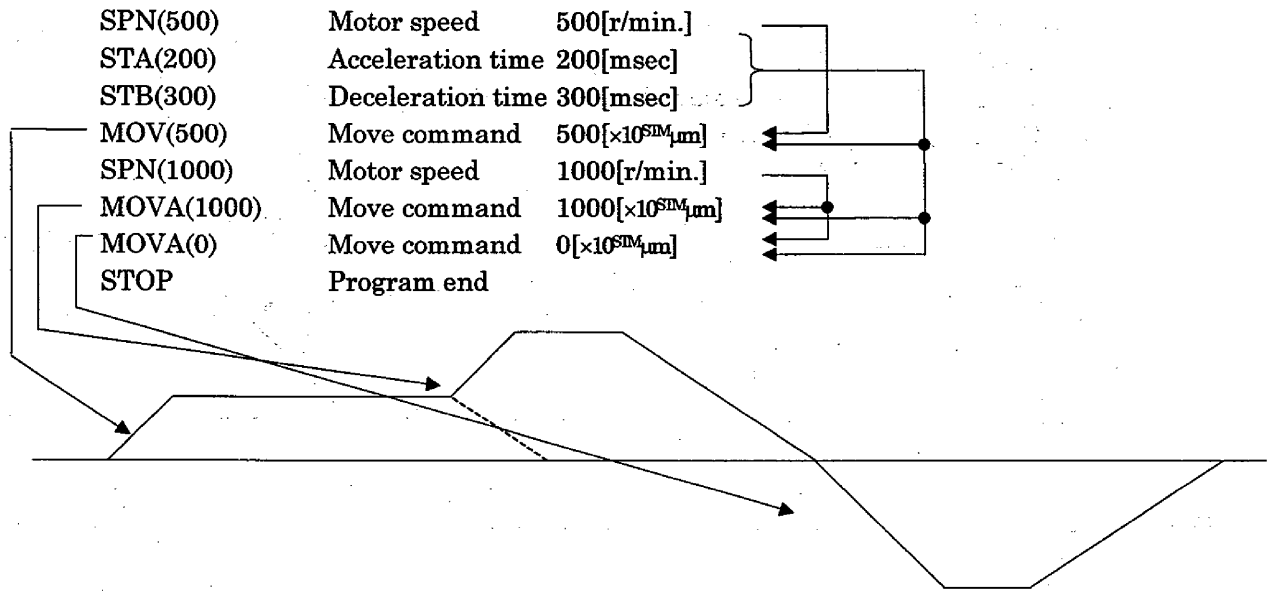

3) Input / Output command (SYNC, OUTON, OUTOF)

- SYNC, OUTON and OUTOF will not be checked the command output complete.

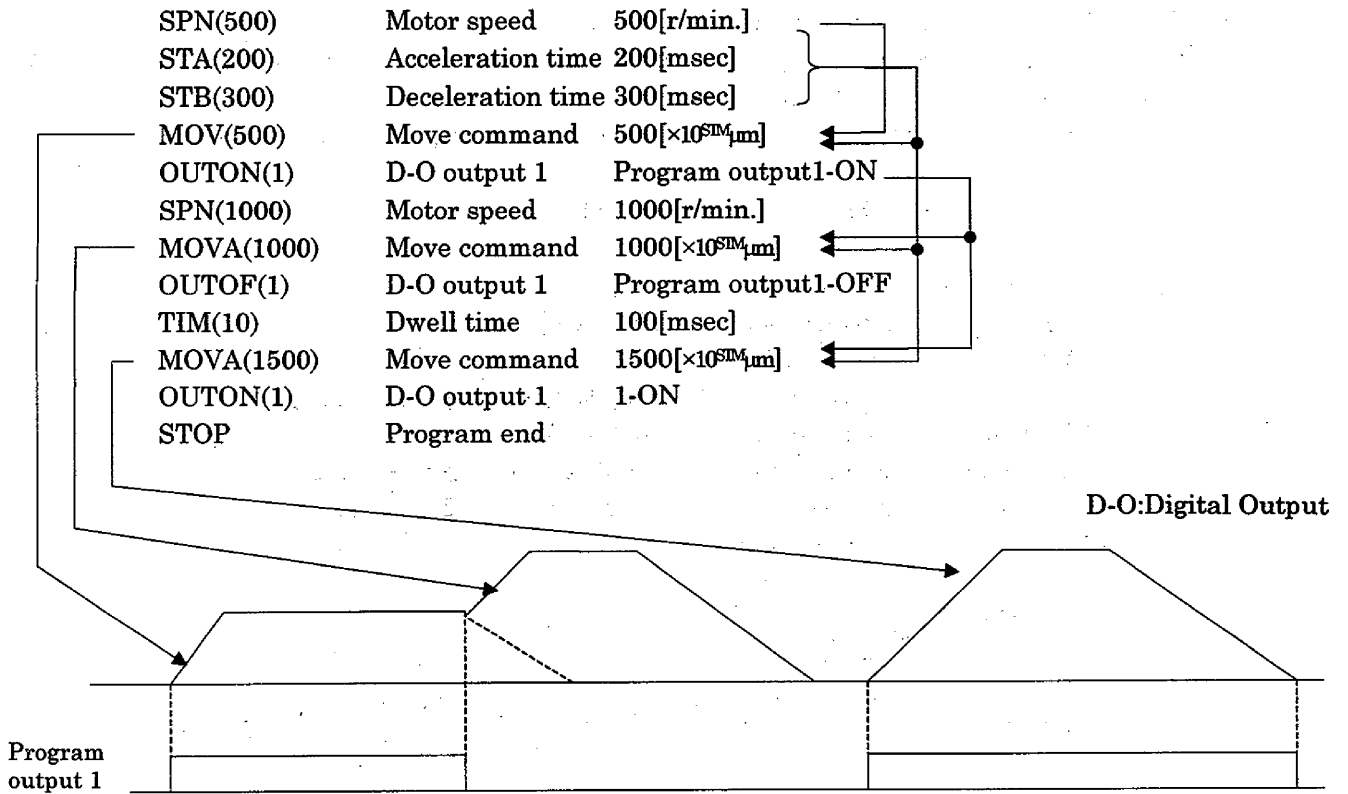

4) Trip Point instruction command (TRIP)

- TRIP command will not be checked the command output complete.

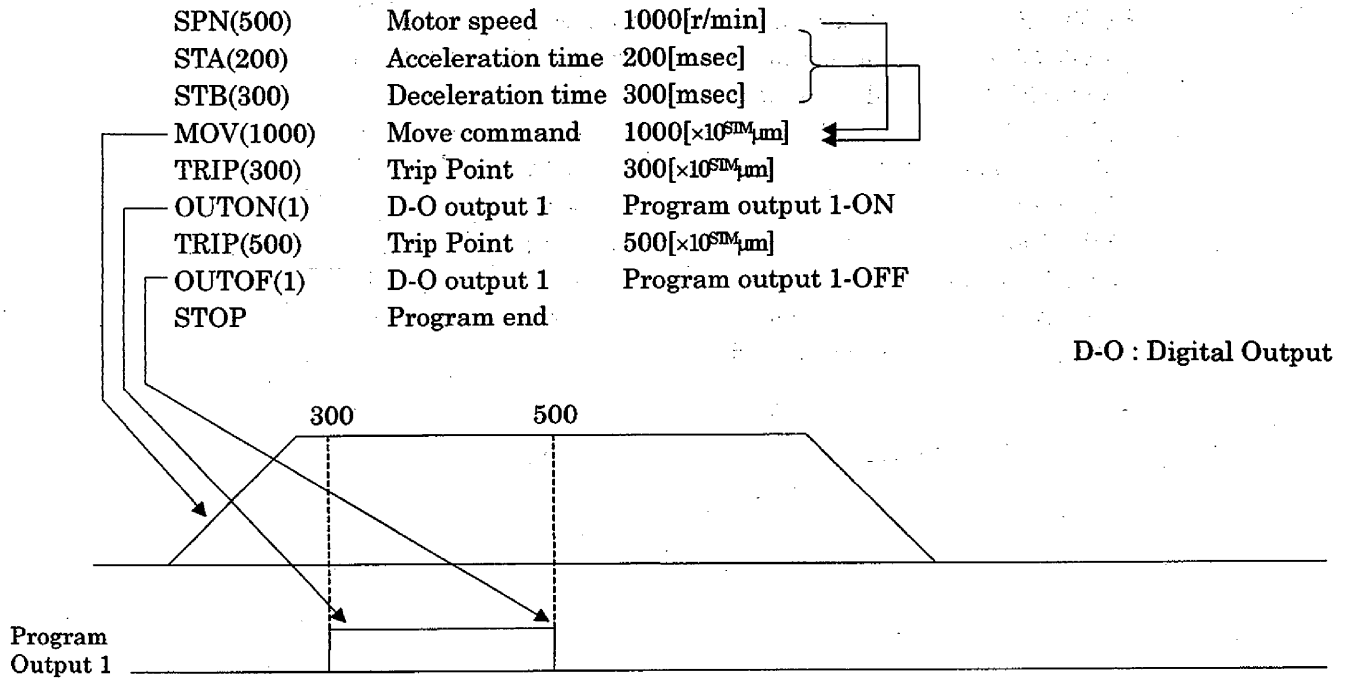

5) External Pulse Count command (COUNT)

- Even if the program is running, COUNT command is valid.

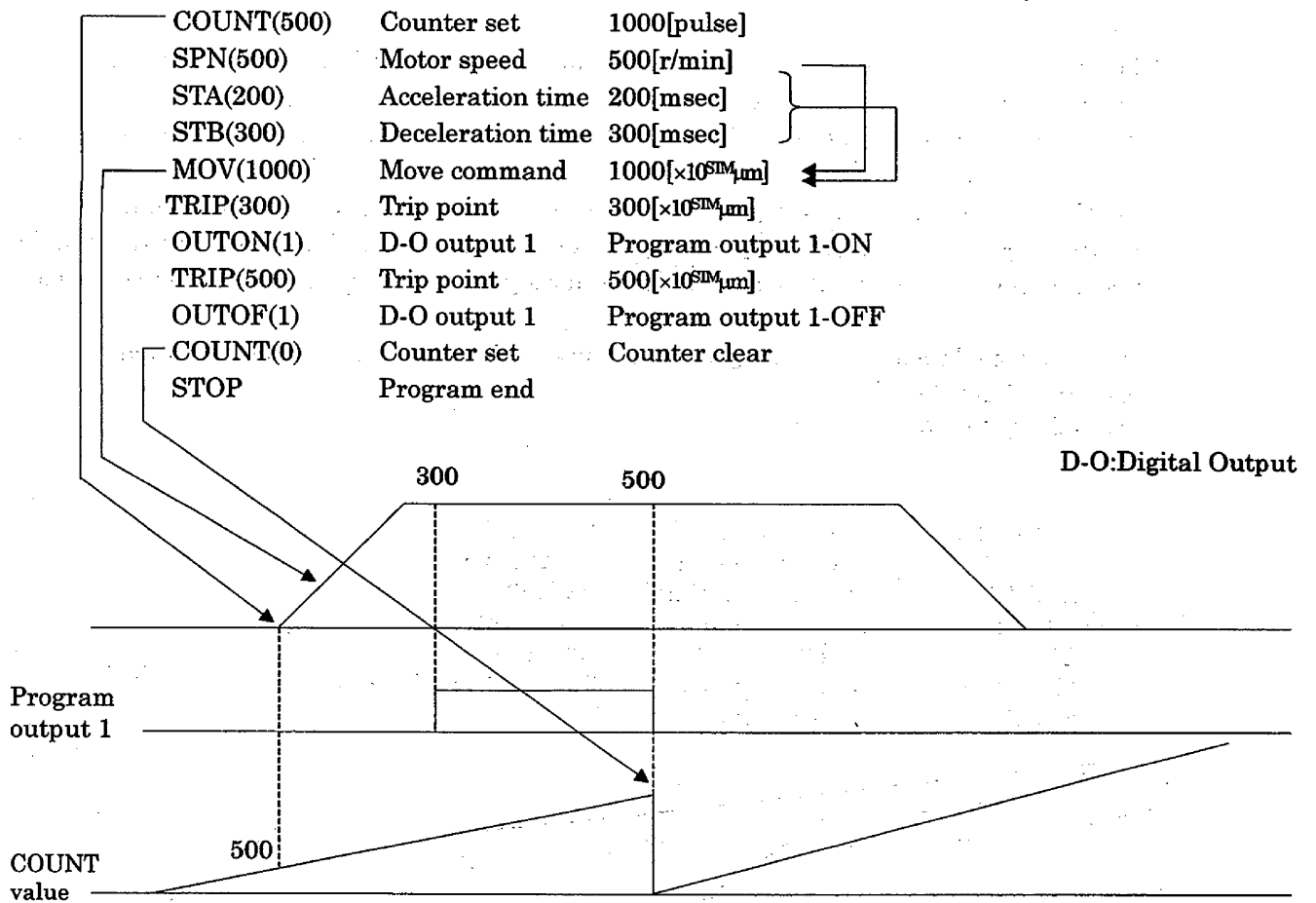

6) Zero point return command (ZRT)

- Set to parameter the Zero point return operation.
- Programming the MOVA command after the ZRT command which will be operated after Zero point return complete, however it would not be continuous operation.

7) Indirect addressing

- The settings of the SPN, STA, STB, STC, MOV, TIM and TIMES commands can each be addressed indirectly.
- The data set by indirect addressing are stored in the general-purpose register (R1, R2, D1, D2) region.
- The general-purpose register (R1, R2, D1, D2) data can be changed by the communication commands during no program execution.
- The general-purpose register (R1, R2, D1, D2) data are cleared when the servo amplifier is powered off.

Note that the general-purpose register (R1, R2) data may also be saved on EEPROM.

- The setting ranges of the general-purpose register (R1, R2, D1, D2) data depend on those of the corresponding commands with which the general-purpose registers (R1, R2, D1, D2) are used.

If the following data are set to the general-purpose registers before program execution:

R1=1000, R2=2000

D1=200, D2=300

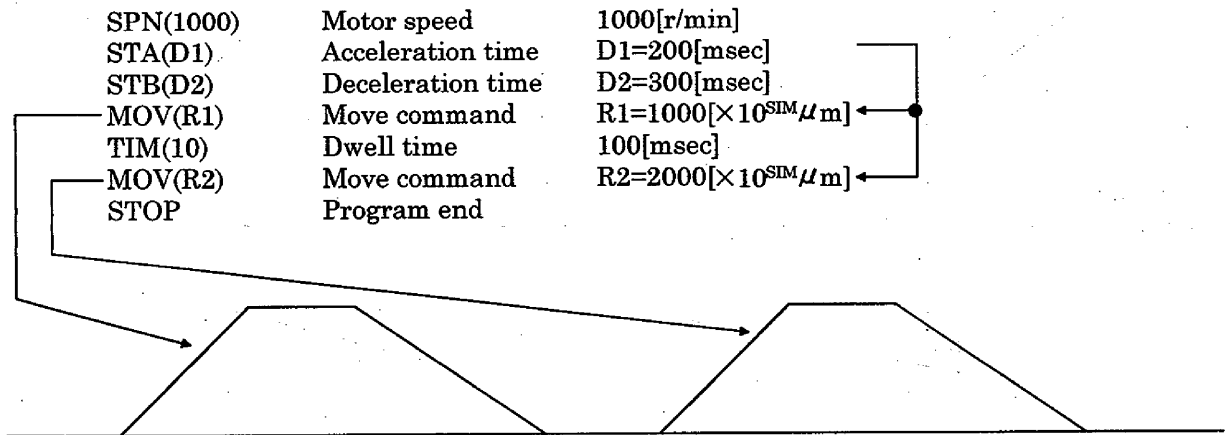

8) Program control (TIMES, STOP)

- TIMES command must be at head of the program and STOP command must be at end of the program. if these commands be at other lines, it will be occurred error.

[Programming example]

| | | |
|------------|--------------------------------|--------------------------------------|
| TIMES(100) | 100[time] | Program repeat numbers |
| SYNC(1) | | Waiting external signal to switch on |
| STC(100) | 100[msec] | Acceleration / Deceleration time |
| SPN(1000) | 1000[r/min.] | Motor speed |
| MOV(5000) | 5000[$\times 10^{SM}\mu m$] | Move command |
| SPN(500) | 500[r/min.] | Motor speed |
| MOVA(2000) | 2000[$\times 10^{SM}\mu m$] | Continuous move command |
| SYNC(1) | | Waiting external signal to switch on |
| TIM(100) | 1000[msec] | Dwell time |
| SPN(500) | 500[r/min.] | Motor speed |
| STA(200) | 200[msec] | Acceleration time |
| STB(500) | 500[msec] | Deceleration time |
| MOV(-7000) | -7000[$\times 10^{SM}\mu m$] | Move command |
| TIM(500) | 5000[msec] | Dwell time |
| STOP | | Program end |

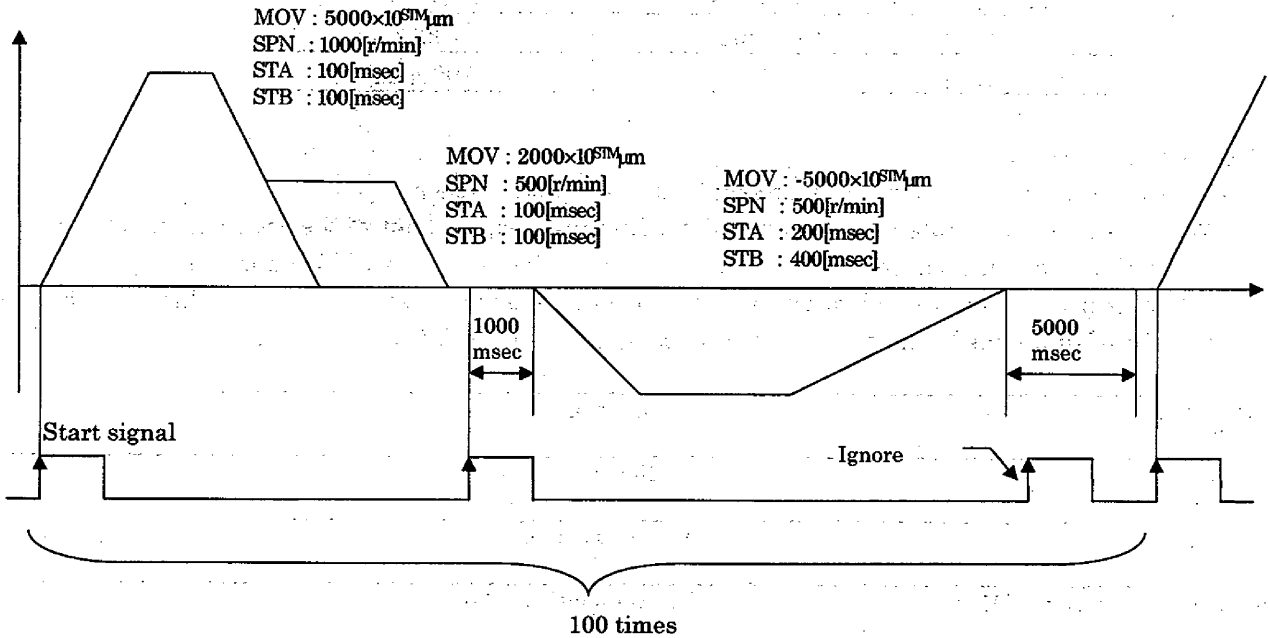

6. Automatic program-operation

(1) Positioning operation with digital input.

1) Parameter setting

- Select the positioning system of absolute or incremental in parameter No.00(STY).

| Setting | Positioning system |
|--|--------------------|
| <input type="checkbox"/> <input type="checkbox"/> 0 <input type="checkbox"/> | Absolute |
| <input type="checkbox"/> <input type="checkbox"/> 1 <input type="checkbox"/> | Incremental |

- Set the direction of the motor rotation with address increases in parameter No.01(FTY).

| Setting | Rotary directions |
|--|--------------------------------------|
| <input type="checkbox"/> <input type="checkbox"/> <input type="checkbox"/> 0 | CCW direction with address increases |
| <input type="checkbox"/> <input type="checkbox"/> <input type="checkbox"/> 1 | CW direction with address decreases |

- Set the magnification of command unit in parameter No.01(FTY).

| Setting | Command unit | Moving distance |
|--|--------------|-----------------------|
| <input type="checkbox"/> <input type="checkbox"/> 0 <input type="checkbox"/> | 1-time | 1[μm] |
| <input type="checkbox"/> <input type="checkbox"/> 1 <input type="checkbox"/> | 10-times | 10[μm] |
| <input type="checkbox"/> <input type="checkbox"/> 2 <input type="checkbox"/> | 100-times | 100[μm] |
| <input type="checkbox"/> <input type="checkbox"/> 3 <input type="checkbox"/> | 1000-times | 1000[μm] |

2) Positioning operation

- Select to the program number at external Digital Input switches.
- When using the absolute value command, positioning is carried out to the set position data for which the zero point has been set as the reference by the MOV or MOVA command.
- When using the incremental value command, positioning is carried out to the set data for which the current position has been set as the reference by the MOV or MOVA command.

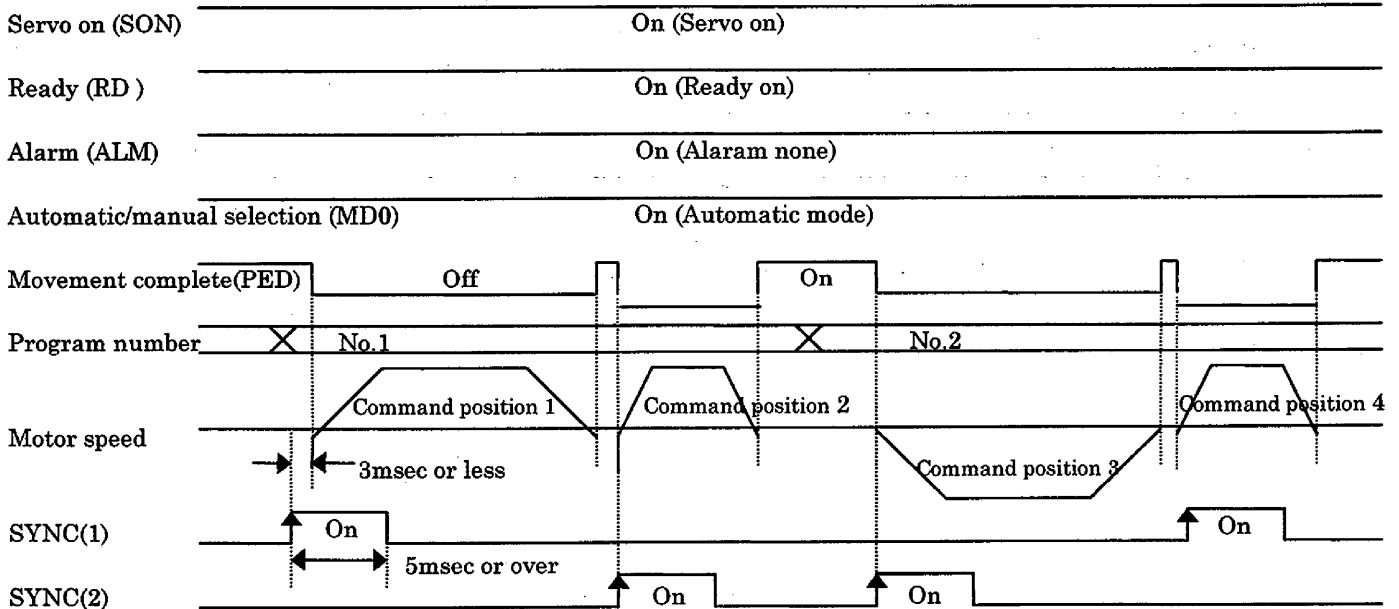

Notice) Start device must turn on ,whenever program change.

(2) Positioning operation with serial communication

1) Parameter setting

- Select the positioning system of absolute or incremental in parameter No.00(STY).

| Setting | Positioning system |
|--|--------------------|
| <input type="checkbox"/> <input type="checkbox"/> 0 <input type="checkbox"/> | Absolute |
| <input type="checkbox"/> <input type="checkbox"/> 1 <input type="checkbox"/> | Incremental |

- Set the direction of the motor rotation with address increases in parameter No.01(FTY).

| Setting | Rotary directions |
|--|--------------------------------------|
| <input type="checkbox"/> <input type="checkbox"/> <input type="checkbox"/> 0 | CCW direction with address increases |
| <input type="checkbox"/> <input type="checkbox"/> <input type="checkbox"/> 1 | CW direction with address decreases |

- Set the magnification of command unit in parameter No.01(FTY).

| Setting | Command unit | Moving distance |
|--|--------------|-----------------|
| <input type="checkbox"/> <input type="checkbox"/> 0 <input type="checkbox"/> | 1-time | 1[μ m] |
| <input type="checkbox"/> <input type="checkbox"/> 1 <input type="checkbox"/> | 10-times | 10[μ m] |
| <input type="checkbox"/> <input type="checkbox"/> 2 <input type="checkbox"/> | 100-times | 100[μ m] |
| <input type="checkbox"/> <input type="checkbox"/> 3 <input type="checkbox"/> | 1000-times | 1000[μ m] |

2) Communication command

- Command to the program number with communication.

Communication D-I valid



Command to the program number with communication D-I



Start signal input

3) Operation by RS-232C / 485 communication

- When using the absolute value command, positioning is carried out to the set position data for which the zero point has been set as the reference by the MOV or MOVA command.
- When using the incremental value command, positioning is carried out to the set data for which the current position has been set as the reference by the MOV or MOVA command.

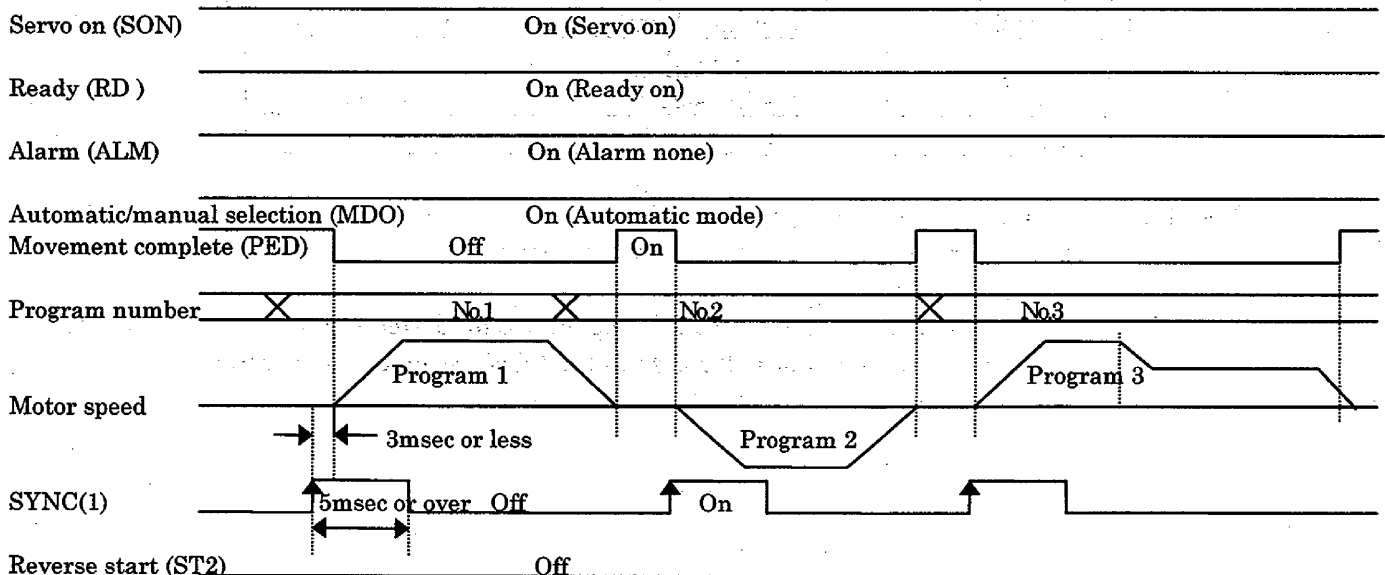

7. Manual operations

1) JOG operation

Procedure1 : Set to the JOG speed.

Acceleration and deceleration time is set at Parameter No.40.

S-pattern acceleration/deceleration time is set at parameter No.14(STC)

Procedure2 : External input device of start signal (ST1, ST2) turns on.

• Timing chart

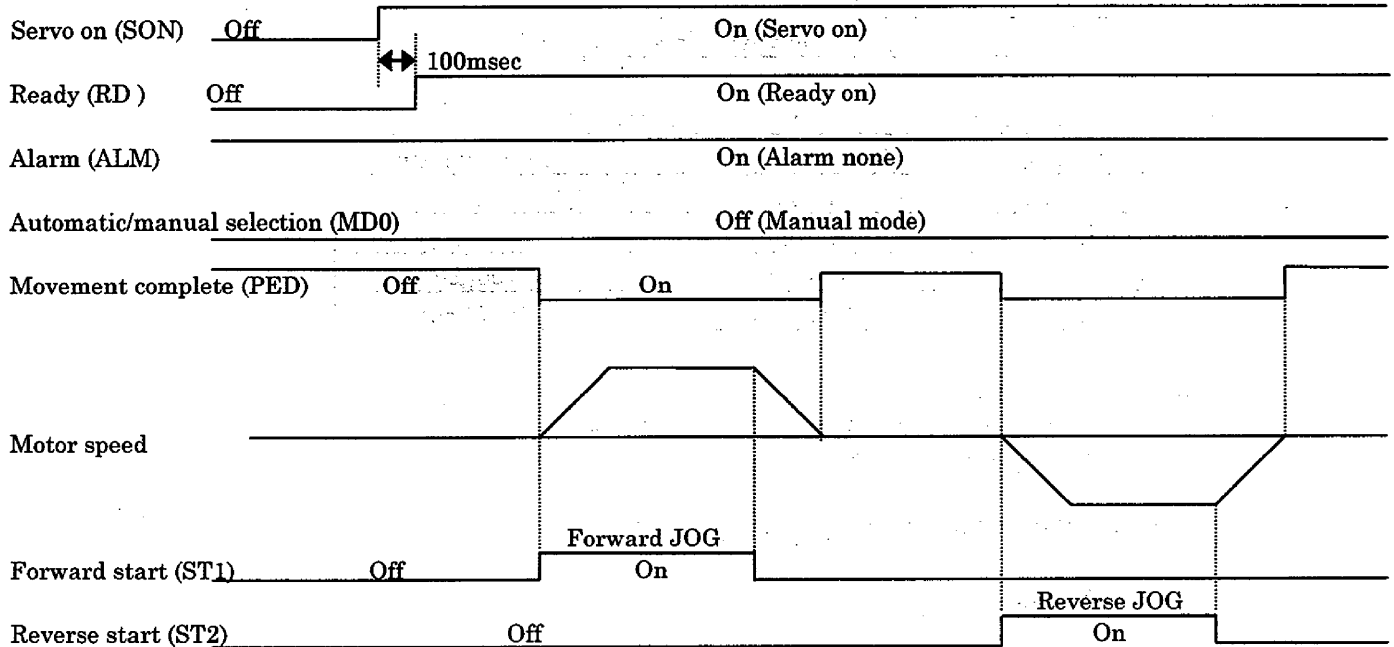

2) The operation with manual pulse generator

Procedure1 : Set the input magnification in parameter No.01(FTY) as follows.

| Setting | Command unit | Moving distance |
|--|------------------|-----------------|
| <input type="checkbox"/> 0 <input type="checkbox"/> <input type="checkbox"/> | 1-time pulses | 1[μ m] |
| <input type="checkbox"/> 1 <input type="checkbox"/> <input type="checkbox"/> | 10-times pulses | 10[μ m] |
| <input type="checkbox"/> 2 <input type="checkbox"/> <input type="checkbox"/> | 100-times pulses | 100[μ m] |

Procedure2 : When the manual pulse generator is rotated, the servo motor will rotate.

The servo motor rotation direction can be changed by the "ST1 coordinate system" setting in parameter NO. 1.

When "0" is set and the manual pulse generator is rotated in the CW (forward run) direction, the servo motor will rotate in the CCW (reverse run) direction.

8. Zero point return operations

(1) Zero point return operation

1) Set to the Zero point return operation type selection.

- Zero point return operation type select in parameter No.08(ZTY)

| Setting | Zero point return type selection |
|--|----------------------------------|
| <input type="checkbox"/> <input type="checkbox"/> <input type="checkbox"/> 0 | DOG method |
| <input type="checkbox"/> <input type="checkbox"/> <input type="checkbox"/> 1 | Count method |
| <input type="checkbox"/> <input type="checkbox"/> <input type="checkbox"/> 2 | Data set method |
| <input type="checkbox"/> <input type="checkbox"/> <input type="checkbox"/> 3 | Stopper method |
| <input type="checkbox"/> <input type="checkbox"/> <input type="checkbox"/> 4 | SON point method |

- Zero point return direction select in parameter No.08(ZTY)

| Setting | Zero point return direction |
|--|-----------------------------|
| <input type="checkbox"/> <input type="checkbox"/> 0 <input type="checkbox"/> | Address increases direction |
| <input type="checkbox"/> <input type="checkbox"/> 1 <input type="checkbox"/> | Address decreases direction |

- Proximity DOG input polarity select in parameter No.08(ZTY)

| Setting | Proximity DOG input polarity |
|--|------------------------------|
| <input type="checkbox"/> 0 <input type="checkbox"/> <input type="checkbox"/> | DOG is ON at open |
| <input type="checkbox"/> 1 <input type="checkbox"/> <input type="checkbox"/> | DOG is ON at close |

- Set the Zero point return speed in parameter No.09(ZRF)
(DOG method, Count method, Stopper method)
- Set the Zero point return creep speed in parameter No.10(CRF)
(DOG method, Count method)
- Set the Zero point return shift distance in parameter No.11(ZST)
(DOG method, Count method)
- Set the Zero point return position data in parameter No.42(ZPS)
(DOG method, Count method, Stopper method, Data set method, SON point method)
- Set the Moving distance after proximity DOG signal on in parameter No.43(DCT)
(Count method)
- Set the stopper method Zero point return operation stopper time in parameter No.44(ZTM)
(Stopper method)
- Set the Stopper method Zero point return operation torque limit value in parameter No.45(ZTT)
(Stopper method)

Set the Zero point return operation acceleration/deceleration time constant in parameter No.41(ZTS)
[the parameter 14 (STC) of S-pattern acceleration/deceleration times is invalidated]

(2) DOG method Zero point return operation

- The timing chart of the Zero point is the first Z-phase pulse after the DOG turns OFF.

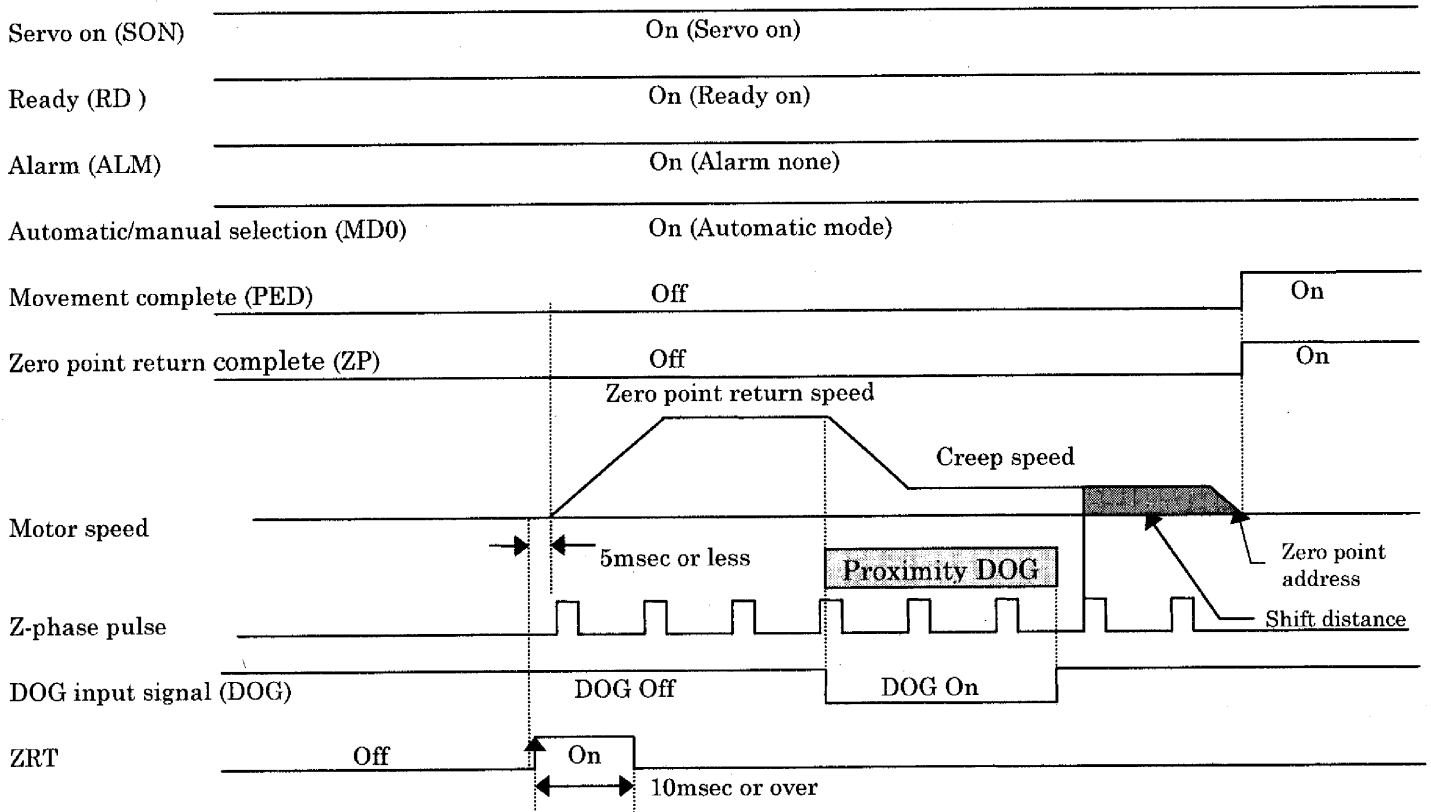

Zero point return is possible even from above the dog. The axis will move in the reverse direction from the Zero point return direction, and then will return to and decelerate to a stop at the front end of the dog. After that, the normal Zero point return will be carried out automatically.

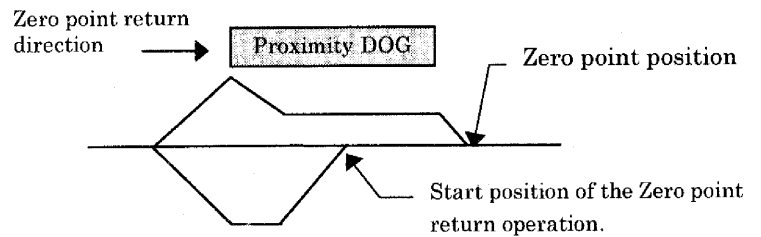

Zero point return is also possible from a position exceeding the dog. In this case, the axis will move once in the Zero point return direction. When the maximum limit switch functions, the rotation direction will reverse, and the axis will return to and decelerate to a stop at the front end of the dog. After that, the normal Zero point return will be carried out automatically.

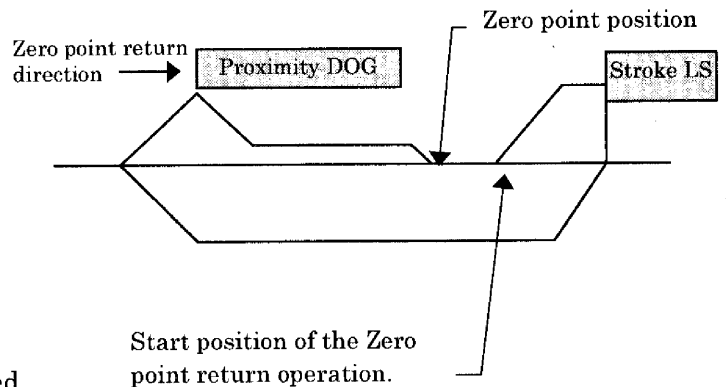

Note) When returning to the Zero point from a position that exceeds the dog, if the dog cannot be detected, the axis will stop at the maximum limit switch in the direction opposite the Zero point return direction. The soft limit is invalid during Zero point return.

(3) Count method Zero point return operation

- The timing chart of the Zero point is the Encoder pulse count after DOG turns ON.

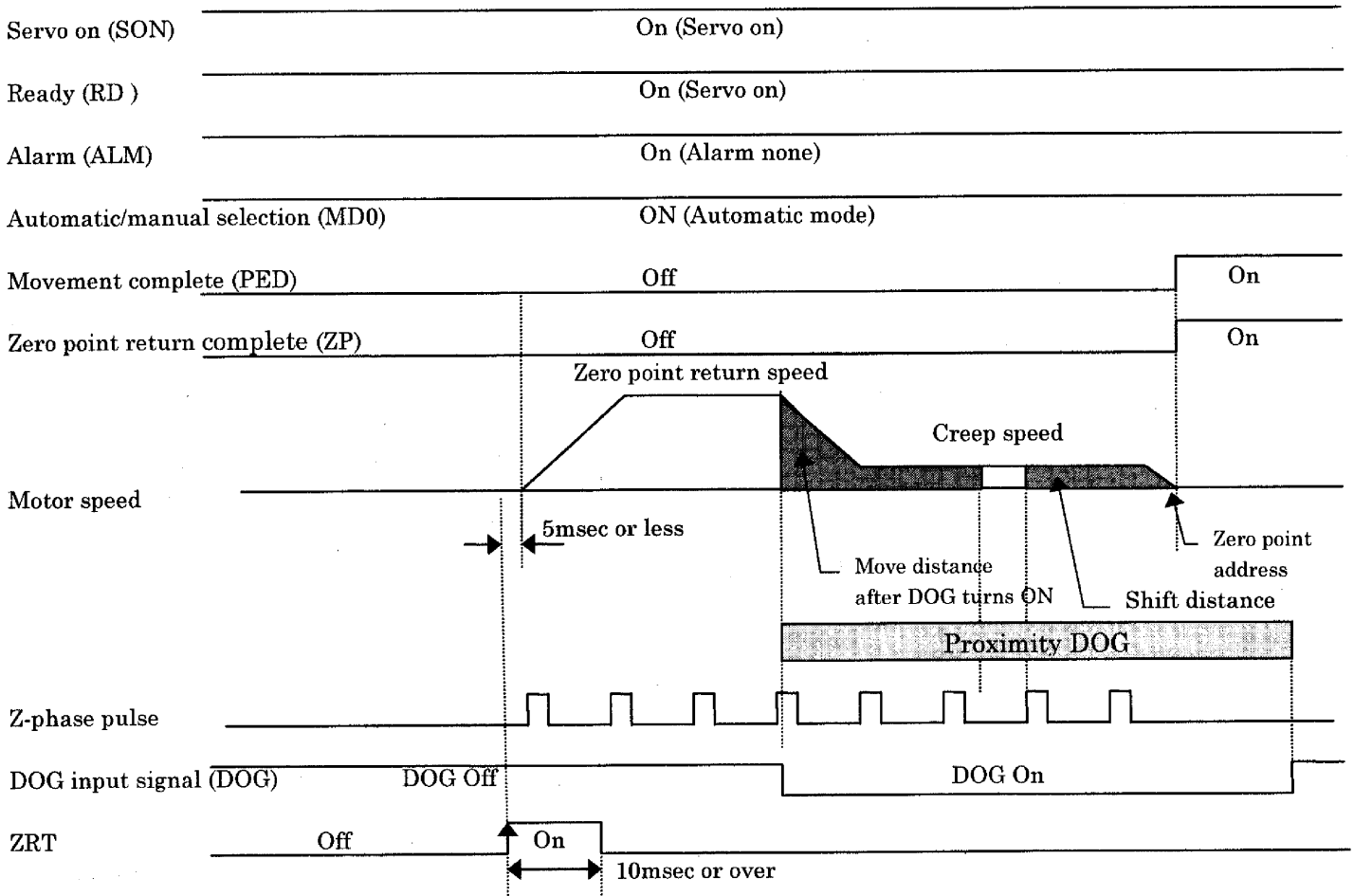

Zero point return is possible even from above the dog. The axis will move in the reverse direction from the Zero point return direction, and then will return to and decelerate to a stop at the front end of the dog. After that, the normal Zero point return will be carried out automatically.

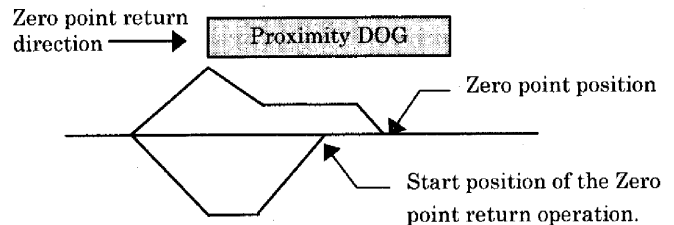

Zero point return is also possible from a position exceeding the dog. In this case, the axis will move once in the Zero point return direction. When the maximum limit switch functions, the rotation direction will reverse, and the axis will return to and decelerate to a stop at the front end of the dog. After that, the normal Zero point return will be carried out automatically.

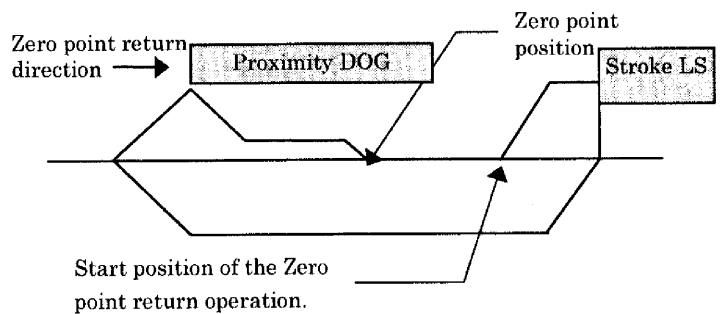

Note) When returning to the Zero point from a position that exceeds the dog, if the dog cannot be detected, the axis will stop at the maximum limit switch in the direction opposite the Zero point return direction. The soft limit is invalid during Zero point return.

(4) Data set method Zero point return operation

- The timing chart of the Zero point is the data set. (not requires DOG switch)

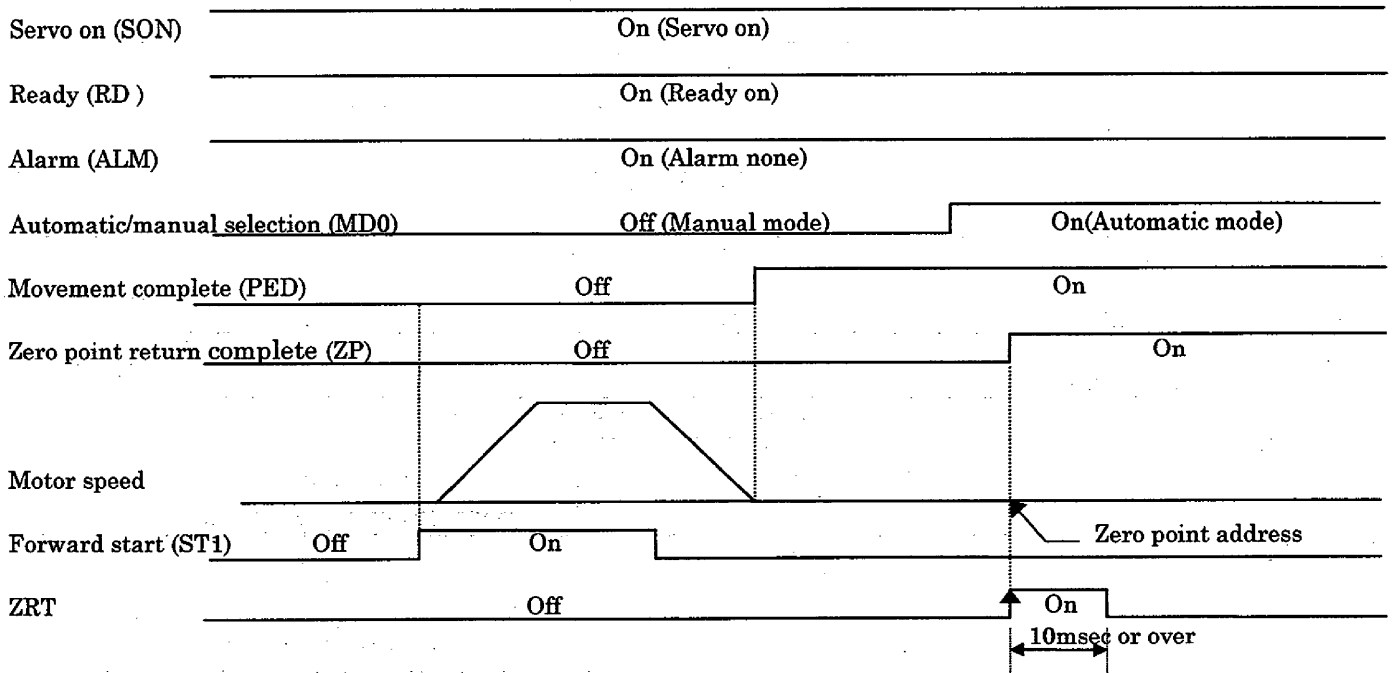

(5) Stopper method Zero point return

- The timing chart of the Zero point return position at stopper position of stroke.

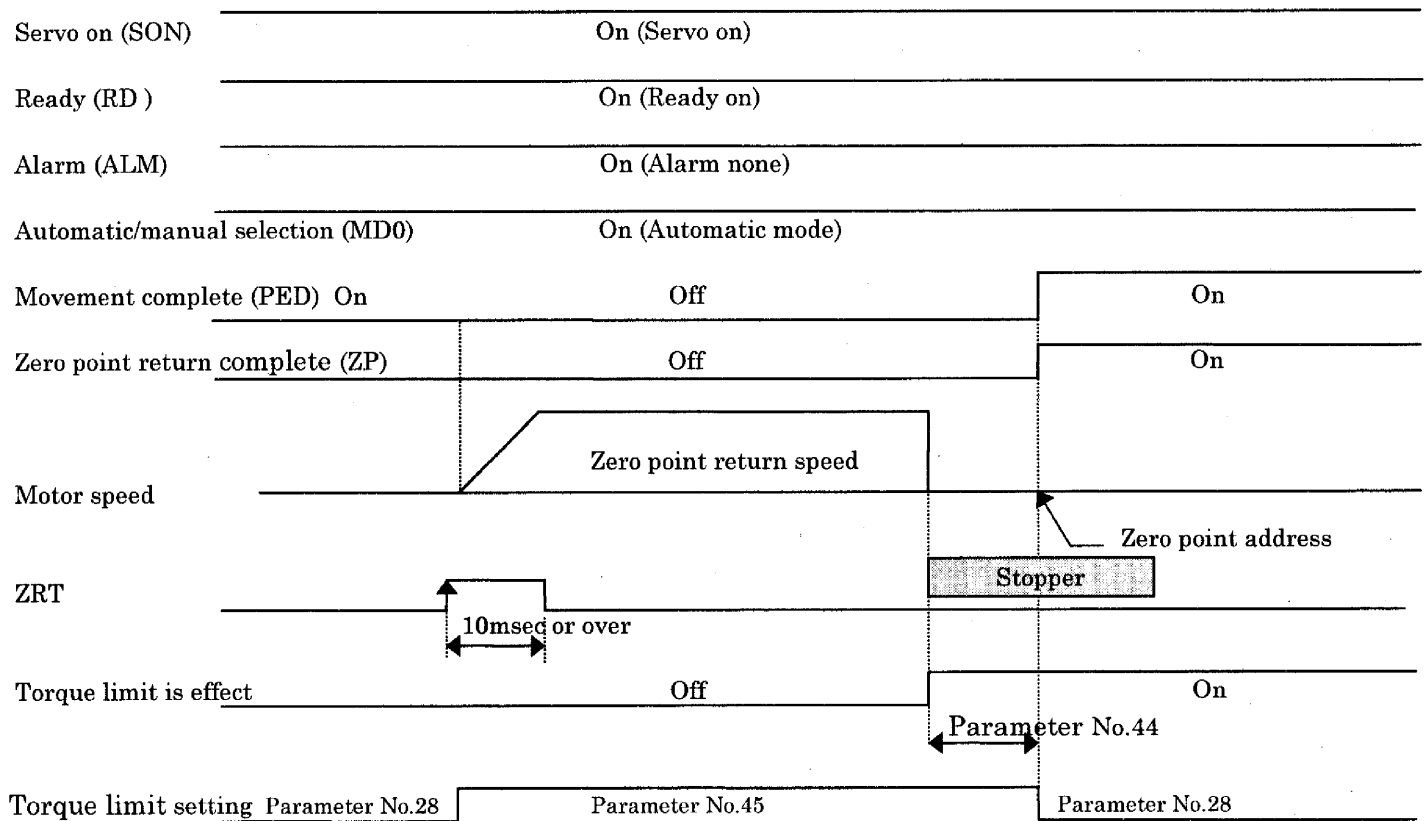

(6) SON point method

- The timing chart of the Zero point return position at SON point method.

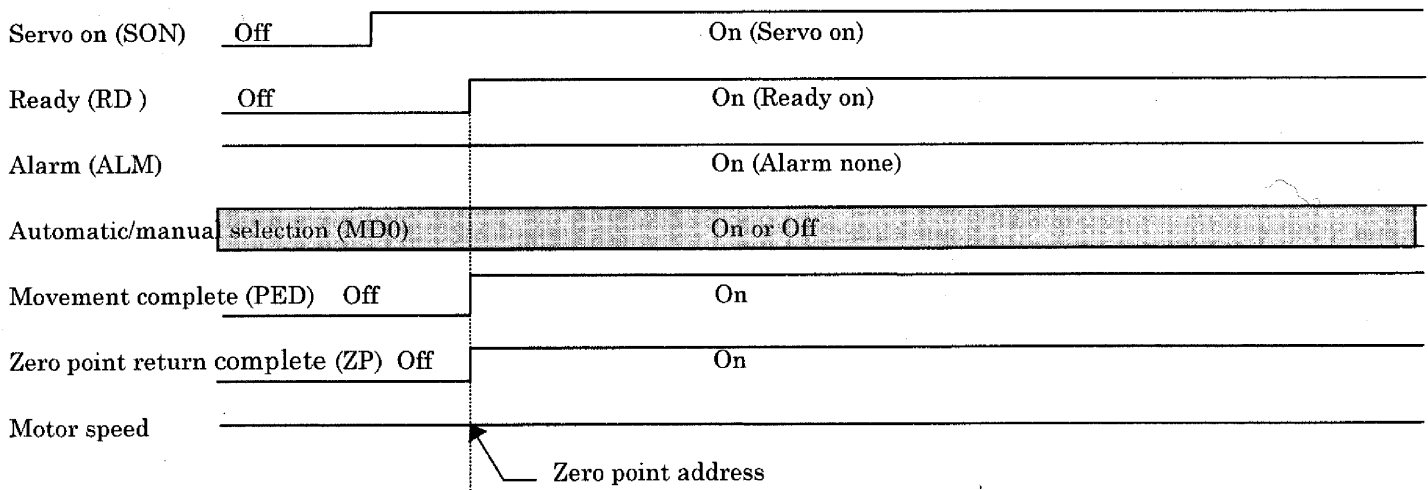

9. Display

(1) Front Panel Display Sequence

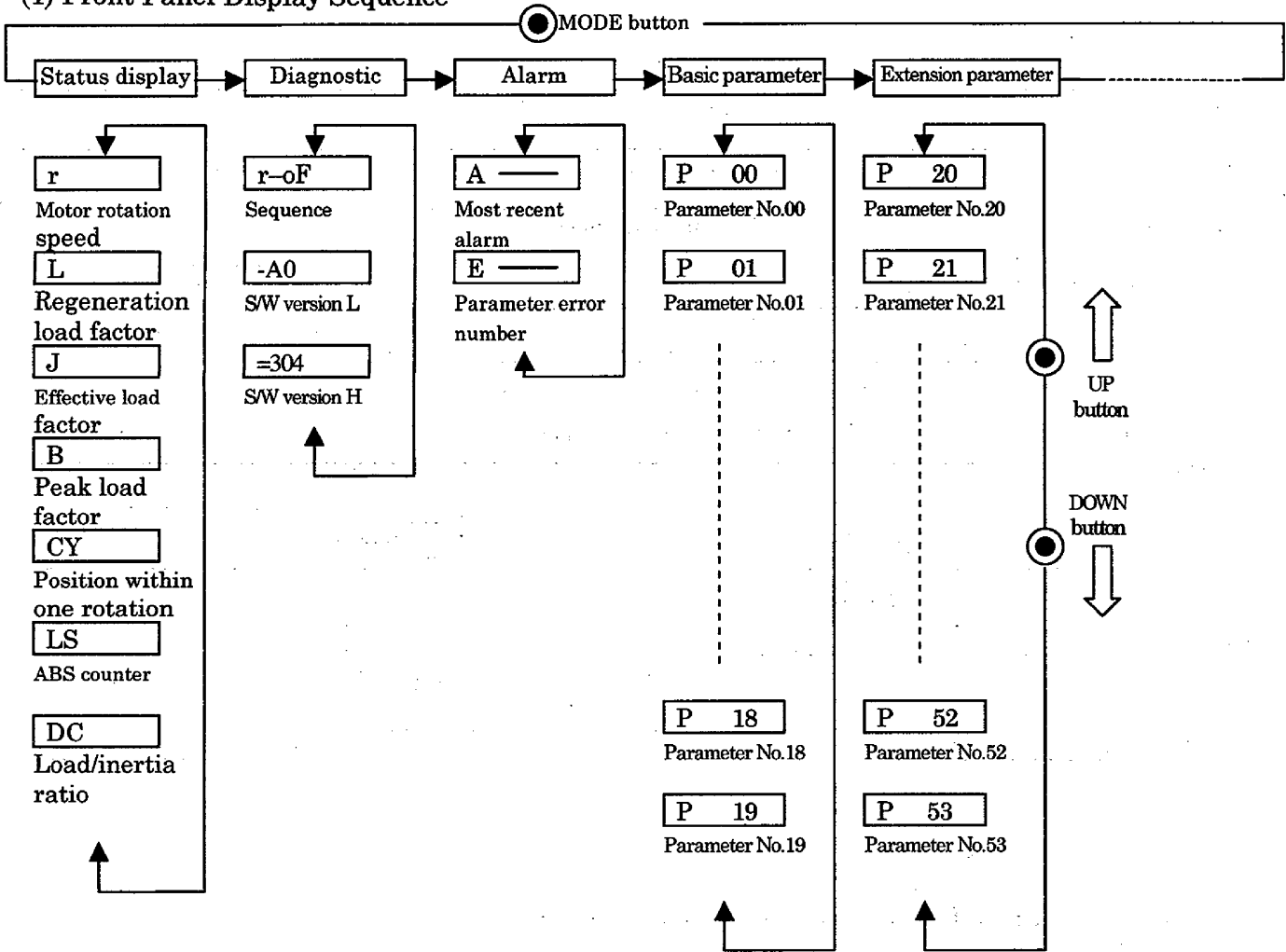

-**MODE** button to select **Main Category**.
 -**UP/DOWN** button to select **Sub-Category**.
 -**SET** button to **View Display**.

(2) Status display



| Name | Symbol | Display range | Unit | Description |
|------------------------------|--------|--------------------|-------|--|
| Servo motor speed | r | -5400 ~ 5400 | r/min | The servo motor speed is displayed. When the servo motor is rotating in reverse direction, the decimal points in the upper 3-digits are lit. |
| Regenerative load factor | L | 0 ~ 100 | % | The ratio of regenerative power to permissible regenerative power is displayed in % . |
| Effective load ratio | J | 0 ~ 300 | % | The continuous effective load torque is displayed. When rated torque is generated, this value is 100%. The effective value for the past 15 seconds is displayed. |
| Peak load ratio | b | 0 ~ 300 | % | The peak load torque is displayed. When rated torque is generated, this value is 100%. The peak torque for the past 15 seconds is displayed. |
| Position within one rotation | CY | 0 ~ 9999 | pulse | Position within one revolution is display in encoder pulses. When the value exceeds 9999, it begins with 0. |
| ABS counter | LS | -9999 ~ 9999 | rev | Travel value from the Zero point in the absolute position detection system is displayed in terms of the absolute position detection's counter value. |
| Load/inertia ratio | dc | 0.0 ~ 100.0 | Times | The estimated ratio of the load inertia moment to the servo motor inertia moment is displayed. |

The servo status during operation is shown on the 4-digit, 7-segment LED display. When the required data is selected , the corresponding symbol is displayed. Press the Set button to display that data.



If a negative value is displayed for each status display, the 2, 3 or 4th digit decimal point will light.

Note that if the decimal point display is provided, the decimal point position will not light.

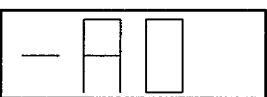
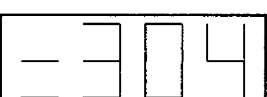
(3) Diagnostic

| Name | Display | Description |
|---------------------|---|---|
| Sequence |  | Not ready Indicates that the servo amplifier is being initialized or alarm has occurred. |
| |  | Ready Indicates that the servo was switched on after completion of initialization and servo amplifier is ready to operate. |
| S/W version Low |  | Indicates the version of the software. |
| S/W version High |  | Indicates the system number of the software. |

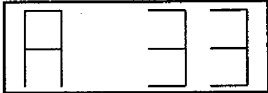
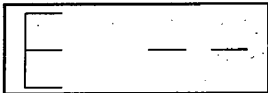
(4) Alarm display

| Name | Display | Description |
|-----------------|---|---|
| Current alarm |  | Indicates no occurrence of an alarm. |
| |  | Indicates the occurrence of alarm 33 (over voltage) Flickers at occurrence of alarm. |
| Parameter error |  | Indicates the occurrence of alarm 37 (parameter error). |
| |  | Indicates that the data of parameter No.1 is faulty. |

Functions at occurrence of an alarm.

- (1) Any mode screen displays the current alarm.
- (2) The other screen visible during occurrence of an alarm. At this time, the decimal point in the fourth digit flickers.
- (3) To clear any alarm, switch power off, then on or press the **SET** button on the current alarm screen. Note that this should be done after removing the cause of alarm.
- (4) Use parameter No.16 to clear the alarm history.

10. Parameters

(1) Parameter listing

| | No | Symbol | Name | Initial value | Unit | Mark |
|------------------|------|-----------------------------|---|---------------|--------|------|
| Basic parameters | 00 | *STY | Control mode, Regenerative brake option selection | 0000 | | |
| | 01 | *FTY | Feeding system selection | 0000 | | |
| | 02 | *OP1 | Function selection 1 | 0000 | | |
| | 03 | ATU | Auto tuning | 0102 | | |
| | 04 | *CMX | Electronic gear (command pulse magnification numerator) | 1 | | |
| | 05 | *CDV | Electronic gear (command pulse magnification denominator) | 1 | | |
| | 06 | PDE | Movement complete output range | 100 | pulse | |
| | 07 | PG1 | Position control gain 1 | 36 | rad/s | |
| | 08 | *ZTY | Zero point return type | 0010 | | |
| | 09 | ZRF | Zero point return speed | 500 | r/min | |
| | 10 | CRF | Zero point return creep speed | 10 | r/min. | |
| | 11 | ZST | Zero point return shift distance | 0 | μm | |
| | 12 | | Spare | 0 | | |
| | 13 | JOG | JOG speed | 100 | r/min. | |
| | 14 | *STC | S-pattern acceleration/deceleration time constant | 0 | msec | |
| | 15 | *SNO | RS-485 channel number setting | 0 | ch. | |
| | 16 | *BPS | Communication baud-rate selection | 0100 | | |
| | 17 | MOD | Analog monitor output selection | 0100 | | |
| | 18 | *DMD | Status display selection, Alarm history clear | 0000 | | |
| 19 | *BLK | Parameter entry prohibition | 0000 | | | |

For parameters marked with an asterisk (*), turn the power off after setting and the power back on to complete the setting.

| | No | Symbol | Name | Initial value | Unit | Mark |
|----------------------|------|------------------------------------|---|---------------|-------------------------|------|
| Expansion parameters | 20 | *OP2 | Function selection 2 | 0000 | | |
| | 21 | *OP3 | Spare | 0002 | | |
| | 22 | *OP4 | Function selection 4 | 0000 | | |
| | 23 | SIC | Serial communication time-out selection | 0 | sec | |
| | 24 | FFC | Feed forward gain | 0 | % | |
| | 25 | VCO | Analog override offset | 0 | mV | |
| | 26 | TLO | Analog torque limit offset | 0 | mV | |
| | 27 | | Spear | 0 | | |
| | 28 | TL1 | Internal torque limit 1 | 100 | % | |
| | 29 | TL2 | Internal torque limit 2 | 100 | % | |
| | 30 | *BKC | Backlash compensation | 0 | pulse | |
| | 31 | MO1 | Analog monitor output 1 offset | 0 | mV | |
| | 32 | MO2 | Analog monitor output 2 offset | 0 | mV | |
| | 33 | MBR | Electromagnetic brake sequence output | 100 | msec | |
| | 34 | GD2 | Ratio of load inertia moment to servo motor inertia moment | 70 | 0.1-times | |
| | 35 | PG2 | Position control gain 2 | 30 | rad/s | |
| | 36 | VG1 | Speed control gain 1 | 216 | rad/s | |
| | 37 | VG2 | Speed control gain 2 | 714 | rad/s | |
| | 38 | VIC | Speed integral compensation | 20 | msec | |
| | 39 | VDC | Speed differential compensation | 980 | | |
| | 40 | JTS | JOG operation acceleration/deceleration time constant | 100 | msec | |
| | 41 | ZTS | Zero point return operation acceleration/deceleration time constant | 100 | msec | |
| | 42 | *ZPS | Zero point return position data | 0 | $\times 10^{SIM} \mu$ | |
| | 43 | DCT | Moving distance after proximity DOG signal on | 1000 | $\times 10^{SIM} \mu$ | |
| | 44 | ZTM | Stopper method Zero point return operation stopper time | 100 | msec | |
| | 45 | ZTT | Stopper method Zero point return operation torque limit value | 15 | % | |
| | 46 | *LP1 | Software limit address +high | 0 | $\times 10^{SIM} \mu m$ | |
| | 47 | *LP2 | Software limit address +low | 0 | | |
| | 48 | *LN1 | Software limit address -high | 0 | $\times 10^{SIM} \mu m$ | |
| | 49 | *LN2 | Software limit address -low | 0 | | |
| | 50 | *PP1 | Position range output address +high | 0 | $\times 10^{SIM} \mu m$ | |
| | 51 | *PP2 | Position range output address +low | 0 | | |
| | 52 | *NP1 | Position range output address -high | 0 | $\times 10^{SIM} \mu m$ | |
| 53 | *NP2 | Position range output address -low | 0 | | | |

For parameters marked with an asterisk (*), turn the power off after setting and the power back on to complete the setting.

| | No | Symbol | Name | Initial value | Unit | Mark |
|--------------------|------|---------------------------|------------------------------------|---------------|------|------|
| Special parameters | 54 | OUT1 | OUT1 output time selection. | 0 | | |
| | 55 | OUT2 | OUT2 output time selection. | 0 | | |
| | 56 | OUT3 | OUT3 output time selection. | 0 | | |
| | 57 | *SYC | Selected to program input polarity | 0000 | | |
| | 58 | *DIO | Input / Output device selection | 0000 | | |
| | 59 | *DI1 | Input device selection 1 | 0209 | | |
| | 60 | *DI2 | Input device selection 2 | 060A | | |
| | 61 | *DI3 | Input device selection 3 | 1615 | | |
| | 62 | *DI4 | Input device selection 4 | 030B | | |
| | 63 | *DI5 | Input device selection 5 | 0504 | | |
| | 64 | *DI6 | Input device selection 6 | 0102 | | |
| | 65 | *DI7 | Input device selection 7 | 0000 | | |
| | 66 | *DO1 | Output device selection 1 | 0005 | | |
| | 67 | *DO2 | Output device selection 2 | 110D | | |
| 68 | *DO3 | Output device selection 3 | 0102 | | | |

For parameters marked with an asterisk (*), turn the power off after setting and the power back on to complete the setting.

(2) Detailed explanation of the parameters

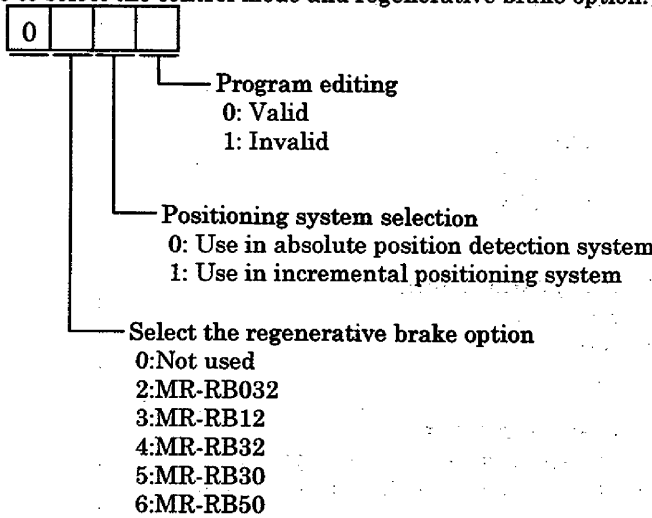
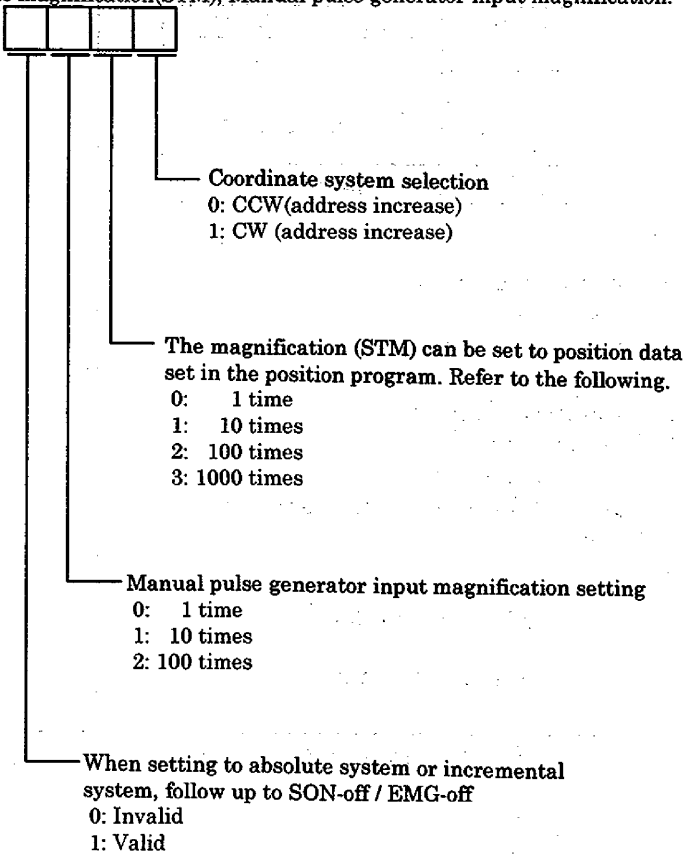
| | No | Symbol | Name and function | Initial value | Unit | Setting range |
|------------------|----|--------|---|---------------|------|---------------------|
| Basic parameters | 00 | *STY | <p>Control mode, Regenerative brake option selection Use to select the control mode and regenerative brake option.</p>  <ul style="list-style-type: none"> Program editing 0: Valid 1: Invalid Positioning system selection 0: Use in absolute position detection system 1: Use in incremental positioning system Select the regenerative brake option 0: Not used 2: MR-RB032 3: MR-RB12 4: MR-RB32 5: MR-RB30 6: MR-RB50 | 0000 | | 0000h ~ 0611h |
| | 01 | *FTY | <p>Feeding system selection The magnification (STM), Manual pulse generator input magnification.</p>  <ul style="list-style-type: none"> Coordinate system selection 0: CCW (address increase) 1: CW (address increase) The magnification (STM) can be set to position data set in the position program. Refer to the following. 0: 1 time 1: 10 times 2: 100 times 3: 1000 times Manual pulse generator input magnification setting 0: 1 time 1: 10 times 2: 100 times When setting to absolute system or incremental system, follow up to SON-off / EMG-off 0: Invalid 1: Valid | 0000 | | 0000h ~ 1231h |

For parameters marked with an asterisk (*), turn the power off after setting and the power back on to complete the setting.

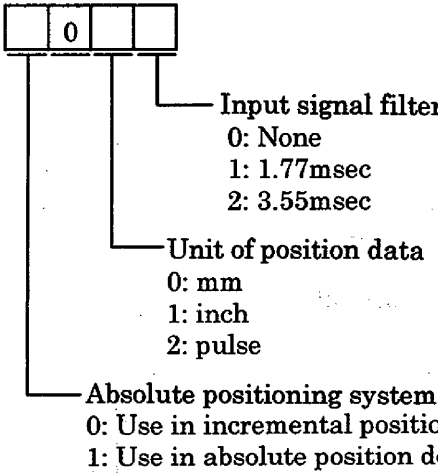
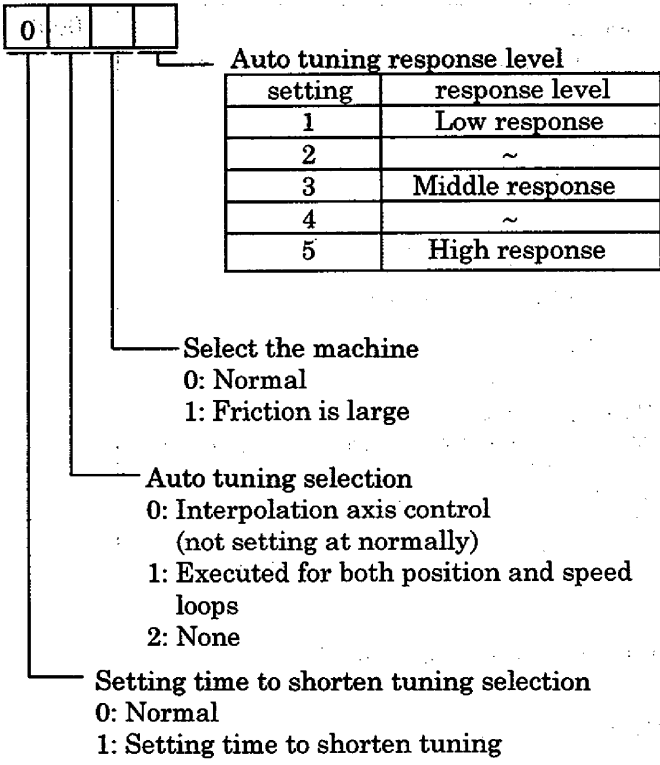
| | No. | Symbol | Name and function | Initial value | Unit | Setting range | | | | | | | | | | | | |
|------------------|-----------------|---|---|---------------|----------------|---------------------|--------------|---|---|---|-----------------|---|---|---|---------------|------|--|---------------------|
| Basic parameters | 02 | *OP1 | <p>Function selection 1 Used to select the input signal filter, CN1B-Pin 19's output signal and absolute position detection system.</p>  <p>Input signal filter 0: None 1: 1.77msec 2: 3.55msec</p> <p>Unit of position data 0: mm 1: inch 2: pulse</p> <p>Absolute positioning system 0: Use in incremental positioning system 1: Use in absolute position detection system</p> | 0000 | | 0000h ~ 1002h | | | | | | | | | | | | |
| | 03 | ATU | <p>Auto tuning Use to set the response level, etc. for execution of auto tuning.</p>  <table border="1" data-bbox="582 940 1021 1142"> <thead> <tr> <th>setting</th> <th>response level</th> </tr> </thead> <tbody> <tr> <td>1</td> <td>Low response</td> </tr> <tr> <td>2</td> <td>~</td> </tr> <tr> <td>3</td> <td>Middle response</td> </tr> <tr> <td>4</td> <td>~</td> </tr> <tr> <td>5</td> <td>High response</td> </tr> </tbody> </table> <p>Auto tuning response level</p> <p>Select the machine 0: Normal 1: Friction is large</p> <p>Auto tuning selection 0: Interpolation axis control (not setting at normally) 1: Executed for both position and speed loops 2: None</p> <p>Setting time to shorten tuning selection 0: Normal 1: Setting time to shorten tuning</p> | setting | response level | 1 | Low response | 2 | ~ | 3 | Middle response | 4 | ~ | 5 | High response | 0102 | | 0001h ~ 1215h |
| | setting | response level | | | | | | | | | | | | | | | | |
| 1 | Low response | | | | | | | | | | | | | | | | | |
| 2 | ~ | | | | | | | | | | | | | | | | | |
| 3 | Middle response | | | | | | | | | | | | | | | | | |
| 4 | ~ | | | | | | | | | | | | | | | | | |
| 5 | High response | | | | | | | | | | | | | | | | | |
| 04 | *CMX | <p>Use to set the multiplier for the command pulse input.</p> <p>Set in the range of $\frac{1}{20} < \frac{CMX}{CDV} < 20$</p> <p>If set over than $\frac{1}{100} < \frac{CMX}{CDV} < 100$, occurred the parameter error.</p> | 1 | | 1~32767 | | | | | | | | | | | | | |

For parameters marked with an asterisk (*), turn the power off after setting and the power back on to complete the setting.

| Basic parameters | No. | Symbol | Name and function | Initial value | Unit | Setting range |
|------------------|-----|--------|--|---------------|--------|-----------------------|
| | 05 | *CDV | <p>Use to set the divisor for the command pulse input.</p> <p>Setting example. Roll diameter : 50mm Reduction ratio : 3/7 Encoder pulses : 16384pulse</p> $\frac{\text{Encoder pulse (CMX)}}{\text{Moving distance (CDX)}} = \frac{16384}{50 \times \pi \times 3/7 \times 1000} = \frac{7168}{9375\pi}$ $= \frac{7168}{29452}$ <p>Hence, set CMX=7168 and CDV=29452 Note) When the fraction is produced, carry within the setting range and round that fraction off.</p> | 1 | | 1~32767 |
| | 06 | PED | <p>Movement complete output range</p> <p>Used to set the droop pulse range of PED signal output</p> | 100 | pulse | 0~10000 |
| | 07 | PG1 | <p>Position control gain 1</p> <p>Used to set the range for model position loop gain. Increase the gain to raise tracking performance in response to the position command.</p> | 36 | rad/s | 4~1000 |
| | 08 | *ZTY | <p>Zero point return type</p> <p>Select the Zero point setting method, Zero point return direction and proximity DOG signal input polarity.</p> <div style="border: 1px solid black; width: 100px; height: 20px; margin: 10px 0; display: flex; align-items: center;"> 0 </div> <ul style="list-style-type: none"> — Zero point return setting mode 0: DOG method 1: Count method 2: Data set method 3: Stopper method 4: SON point method <ul style="list-style-type: none"> — Zero point return direction 0: Address increases direction 1: Address decreases direction <ul style="list-style-type: none"> — Proximity DOG input polarity 0: DOG is on by open 1: DOG is on by close | 0014 | | 0000h ~ 0114h |
| | 09 | ZRF | <p>Zero point return speed</p> <p>Used to set the servo motor speed for Zero point return.</p> | 500 | r/min. | 0~ Max motor speed |
| | 10 | CRF | <p>Zero point return creep speed</p> <p>Used to set the creep speed applied when the proximity DOG signal on.</p> | 10 | r/min. | 0~ Max motor speed |
| | 11 | ZST | <p>Zero point return shift distance</p> <p>Used to set the shift distance from the Z-phase pulse detection position in the encoder.</p> | 0 | μm | 0~65535 |

For parameters marked with an asterisk (*), turn the power off after setting and the power back on to complete the setting.

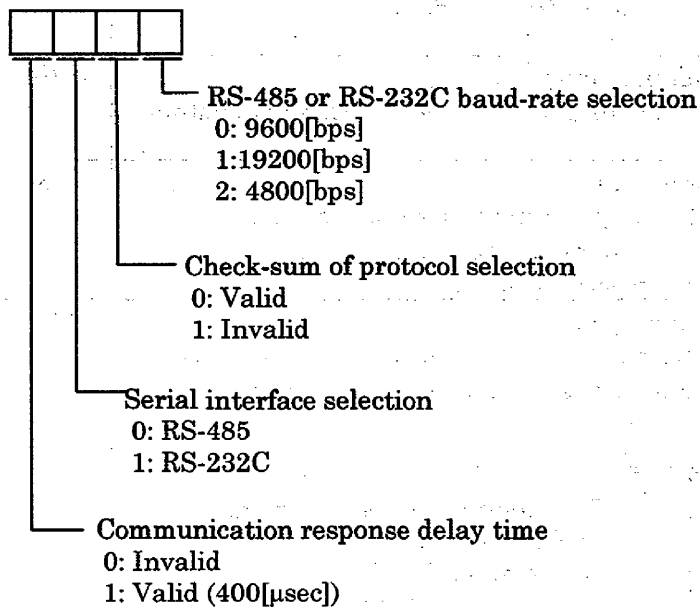
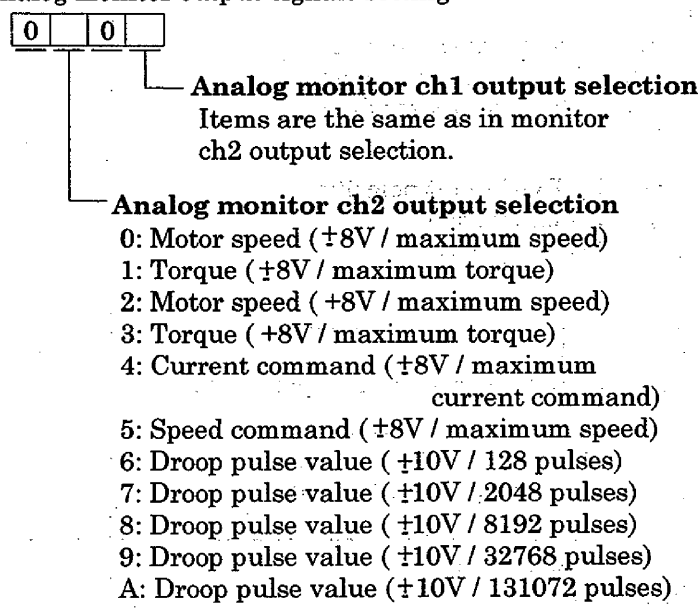
| | No. | Symbol | Name and function | Initial value | Unit | Setting range |
|------------------|-----|--|--|---------------|---------------------|-----------------------|
| Basic parameters | 12 | | Spare | 0 | | |
| | 13 | JOG | JOG speed Used to set speed of the JOG speed command. | 100 | r/min. | 0~ Max motor speed |
| | 14 | *STC | S-pattern acceleration/deceleration time constant Used to smooth start/stop of the servo motor, S-pattern Acceleration/deceleration time set in the program. Invalid for the Zero point returning. | 0 | msec | 0~100 |
| | 15 | *SNO | RS-485 channel number setting Set to the channel number of RS-485 multi-drop. If set the same channel number, it is incorrectly. | 0 | ch. | 0~31 |
| | 16 | *BPS | Communication baud-rate selection Select the baud-rate for the RS-232C or RS-485  | 0100 | | 0000h ~ 1112h |
| 17 | MOD | Analog monitor output selection Analog monitor output signals setting  | 0100 | | 0000h ~ 0A0Ah | |

For parameters marked with an asterisk (*), turn the power off after setting and the power back on to complete the setting.

| | No. | Symbol | Name and function | Initial value | Unit | Setting range | | | | | | | | | | | | | | | | | |
|------------------|-----------------------|---|--|-----------------|-------------|---------------|----------|----------|---------------------|-------|-------|------|-----------------------|----------|------|-----------------------|-----------------------|------|-----------------------|-----------------------|------|--|---------------------|
| Basic parameters | 18 | *DMD | <p>Status display selection, Alarm history clear Used to select the status display shown at power on and alarm history clear.</p> <div style="display: flex; align-items: center;"> <table border="1" style="border-collapse: collapse; margin-right: 10px;"> <tr> <td style="width: 20px; height: 20px; text-align: center;">0</td> <td style="width: 20px; height: 20px;"></td> <td style="width: 20px; height: 20px;"></td> </tr> </table> <div> <p>Selection of status display at power on.</p> <ul style="list-style-type: none"> 0: Motor speed 1: Regeneration load factor 2: Effective load factor 3: Peak load factor 4: Position within one rotation 5: ABS counter 6: Load/inertia ratio <p>Selection of status display at the DP-60</p> <ul style="list-style-type: none"> 0: Current position 1: Command position 2: Command remaining distance 3: Program number 4: Feedback pulse accumulation 5: Motor speed 6: Droop pulse 7: Override 8: Torque limit command voltage 9: Regeneration load factor A: Effective load factor B: Peak load factor C: Position within one rotation D: ABS counter E: Load/inertia ratio <p>Alarm history clear</p> <ul style="list-style-type: none"> 0: Invalid 1: Valid </div> </div> <p>When alarm history clear is made valid, the alarm history is cleared at next power-on, after the alarm history cleared, the setting is automatically made invalid (reset to 0)</p> | 0 | | | 0000 | | 0000h ~ 10E6h | | | | | | | | | | | | | | |
| | 0 | | | | | | | | | | | | | | | | | | | | | | |
| 19 | *BLK | <p>Parameter entry prohibition Used to select the reference and write ranges of the parameters.</p> <table border="1" style="border-collapse: collapse; width: 100%;"> <thead> <tr> <th>Set value</th> <th>Reference range</th> <th>Write range</th> </tr> </thead> <tbody> <tr> <td>0000</td> <td>No. 0~19</td> <td>No. 0~19</td> </tr> <tr> <td>000A</td> <td>No.19</td> <td>No.19</td> </tr> <tr> <td>000B</td> <td>No. 0~19 No. 20~53</td> <td>No. 0~19</td> </tr> <tr> <td>000C</td> <td>No. 0~19 No. 20~53</td> <td>No. 0~19 No. 20~53</td> </tr> <tr> <td>000E</td> <td>No. 0~19 No. 20~68</td> <td>No. 0~19 No. 20~68</td> </tr> </tbody> </table> <p>When use the Setup S/W for read and write of the devices, set"000E".</p> | Set value | Reference range | Write range | 0000 | No. 0~19 | No. 0~19 | 000A | No.19 | No.19 | 000B | No. 0~19 No. 20~53 | No. 0~19 | 000C | No. 0~19 No. 20~53 | No. 0~19 No. 20~53 | 000E | No. 0~19 No. 20~68 | No. 0~19 No. 20~68 | 0000 | | 0000h ~ FFFFh |
| Set value | Reference range | Write range | | | | | | | | | | | | | | | | | | | | | |
| 0000 | No. 0~19 | No. 0~19 | | | | | | | | | | | | | | | | | | | | | |
| 000A | No.19 | No.19 | | | | | | | | | | | | | | | | | | | | | |
| 000B | No. 0~19 No. 20~53 | No. 0~19 | | | | | | | | | | | | | | | | | | | | | |
| 000C | No. 0~19 No. 20~53 | No. 0~19 No. 20~53 | | | | | | | | | | | | | | | | | | | | | |
| 000E | No. 0~19 No. 20~68 | No. 0~19 No. 20~68 | | | | | | | | | | | | | | | | | | | | | |

For parameters marked with an asterisk (*), turn the power off after setting and the power back on to complete the setting.

| Expansion parameters | No. | Symbol | Name and function | Initial value | Unit | Setting range | | | | | | | | | | | | | | | | | |
|----------------------|---------------------|--------|---|---------------|---------------------|---------------------|----------|---|------|---|-----|---|-----|---|-----|---|-----|---|-----|---|-----|------|--|
| | 20 | *OP2 | Function selection 2 Used to select the torque limit valid direction of the motor rotation and slight vibration suppression control. <div style="display: flex; align-items: center; margin-top: 10px;"> <div style="border: 1px solid black; padding: 2px; margin-right: 5px;">0</div> <div style="border: 1px solid black; padding: 2px; margin-right: 5px;">0</div> <div style="border: 1px solid black; padding: 2px; margin-right: 5px;"> </div> <div style="border: 1px solid black; padding: 2px; margin-right: 5px;"> </div> </div> <ul style="list-style-type: none"> — Selection of torque limit valid to directions 0: CCW/CW both of directions are valid 1: CCW direction is valid 2: CW direction is valid — Slight vibration suppression control 0: Invalid 1: Valid | 0000 | | 0000h ~ 1102h | | | | | | | | | | | | | | | | | |
| | 21 | *OP3 | Spare | 0002 | | | | | | | | | | | | | | | | | | | |
| | 22 | *OP4 | Function selection 4 <div style="display: flex; align-items: center; margin-top: 10px;"> <div style="border: 1px solid black; padding: 2px; margin-right: 5px;"> </div> <div style="border: 1px solid black; padding: 2px; margin-right: 5px;">0</div> <div style="border: 1px solid black; padding: 2px; margin-right: 5px;"> </div> <div style="border: 1px solid black; padding: 2px; margin-right: 5px;"> </div> </div> <ul style="list-style-type: none"> — Selection of motor stop pattern at LSP/LSN signal off 0: Sudden stop 1: Slow stop — Selection of stop procedure at alarm clear "RES" signal is on. 0: Alarm clear and not base shut off within the edge. 1: Alarm clear and base shut off during the "RES" is on within the edge. — Machine resonance suppression filter <table border="1" style="margin-left: 20px; margin-top: 10px;"> <thead> <tr> <th>Set value</th> <th>Notch frequency[Hz]</th> </tr> </thead> <tbody> <tr><td>0</td><td>Not used</td></tr> <tr><td>1</td><td>1125</td></tr> <tr><td>2</td><td>563</td></tr> <tr><td>3</td><td>375</td></tr> <tr><td>4</td><td>282</td></tr> <tr><td>5</td><td>225</td></tr> <tr><td>6</td><td>188</td></tr> <tr><td>7</td><td>161</td></tr> </tbody> </table> | Set value | Notch frequency[Hz] | 0 | Not used | 1 | 1125 | 2 | 563 | 3 | 375 | 4 | 282 | 5 | 225 | 6 | 188 | 7 | 161 | 0000 | |
| Set value | Notch frequency[Hz] | | | | | | | | | | | | | | | | | | | | | | |
| 0 | Not used | | | | | | | | | | | | | | | | | | | | | | |
| 1 | 1125 | | | | | | | | | | | | | | | | | | | | | | |
| 2 | 563 | | | | | | | | | | | | | | | | | | | | | | |
| 3 | 375 | | | | | | | | | | | | | | | | | | | | | | |
| 4 | 282 | | | | | | | | | | | | | | | | | | | | | | |
| 5 | 225 | | | | | | | | | | | | | | | | | | | | | | |
| 6 | 188 | | | | | | | | | | | | | | | | | | | | | | |
| 7 | 161 | | | | | | | | | | | | | | | | | | | | | | |

For parameters marked with an asterisk (*), turn the power off after setting and the power back on to complete the setting.

| | | No. | Symbol | Name and function | Initial value | Unit | Setting range |
|----------------------|----|-----|--|---|---------------|--------|------------------|
| Expansion parameters | | 23 | SIC | Serial communication time-out selection Set to time of serial communication time-out check. Not time-out check at set "0". | 0 | sec | 0~60 |
| | | 24 | FFC | Feed forward gain Used to set the feed forward gain in position control. By setting 100% for constant-speed operation, droop pulses will not be generated. Note that sudden acceleration/deceleration will increase overshoot. (As a guideline, acceleration/deceleration time to/from rated speed is 1 sec. or longer when the set value is 100. When setting this parameter, always turn off the auto-tuning (parameter No. 3) | 0 | % | 0~100 |
| | | 25 | VCO | Analog override offset Used to set the offset voltage of the analog override command. | 0 | mV | -999~999 |
| | | 26 | TLO | Analog torque limit offset Used to set the offset voltage of the analog torque limit command. | 0 | mV | -999~999 |
| | | 27 | | Spare | 0 | | |
| | | 28 | TL1 | Internal torque limit 1 Set this parameter to limit servo motor-generated torque on the assumption that the maximum torque is 100%. When 0 is set, torque is not produced. | 100 | % | 0~100 |
| | | 29 | TL2 | Internal torque limit 2 Set this parameter to limit servo motor-generated torque on the assumption that the maximum torque is 100%. When 0 is set, torque is not produced. Internal torque limit selection signal must be on. | 100 | % | 0~100 |
| | | 30 | *BKC | Backlash compensation Used to set the backlash compensated foe when the Command direction is reversed. | 0 | pulse | 0~1000 |
| | | 31 | MO1 | Analog monitor output 1 offset Used to set the offset voltage of the analog monitor ch1 output (MO1). | 0 | mV | -999 ~ 999 |
| | | 32 | MO2 | Analog monitor output 2 offset Used to set the offset voltage of the analog monitor ch2 output (MO2). | 0 | mV | -999 ~ 999 |
| | 33 | MBR | Electromagnetic brake sequence output Used to set the delay time between when the Electromagnetic brake interlock signal (MBR) switches off and when the base circuit is shut off. | 100 | msec | 0~1000 | |



For parameters marked with an asterisk (*), turn the power off after setting and the power back on to complete the setting.

| Expansion parameters | No. | Symbol | Name and function | Initial value | Unit | Setting range |
|----------------------|-----|--------|---|---------------|-------|---------------|
| | 34 | GD2 | Inertia Ratio of load to motor Used to set the ratio of the load inertia moment to the servo motor inertia moment. Note that when auto tuning is selected, the result of automatically set. | 70 | ×0.1 | 0~1000 |
| | 35 | PG2 | Position control gain 2 Used to set the gain of the position loop. Set this parameter to increase position response to load disturbance. Higher setting increases the response level but is liable to generate vibration and/or noise. Note that when auto tuning is selected, the result of automatically set. | 30 | rad/s | 1~500 |
| | 36 | VG1 | Speed control gain 1 Normally this parameter setting need not be changed. Higher setting increases the response level but is liable to generate vibration and/or noise. Note that when auto tuning is selected, the result of automatically set. | 216 | rad/s | 20~5000 |
| | 37 | VG2 | Speed control gain 2 Set the parameter when vibration occurs on the machine of low rigidity or large back-rush. Higher setting increases the response level but is liable to generate vibration and/or noise. Note that when auto tuning is selected, the result of automatically set. | 714 | rad/s | 20~8000 |
| | 38 | VIC | Speed integral compensation Used to set the constant of integral compensation. Note that when auto tuning is selected, the result of automatically set. | 20 | msec | 1~1000 |
| | 39 | VDC | Speed differential compensation Used to set the differential compensation value. | 980 | | 0~1000 |
| | 40 | JTS | JOG operation acc / dec time constant Used to set the acceleration/deceleration time when JOG operation. | 100 | msec | 1~20000 |
| | 41 | ZTS | Zero point return operation acc / dec time constant Used to set the acceleration/deceleration time when Zero point return operation. | 100 | msec | 1~20000 |

For parameters marked with an asterisk (*), turn the power off after setting and the power back on to complete the setting.

| | | No. | Symbol | Name and function | Initial value | Unit | Setting range |
|----------------------|----------|------|--|-------------------|--------------------------|------------------------|---------------|
| Expansion parameters | 42 | *ZPS | Zero point return position data Used to set the current position reached on completion of Zero point return. The actual Zero point position data is 10 ^{STM} times greater than the set value. | 0 | ×10 ^{STM} μm | -32768 ~ 32767 | |
| | 43 | DCT | Moving distance after proximity DOG signal on Used in the count type Zero point return method to set the moving distance after the proximity DOG signal is switched on. Set the value not less than the distance required to decelerate from the Zero point return speed. | 1000 | ×10 ^{STM} μm | 0~65535 | |
| | 44 | ZTM | Stopper method Zero point return operation stopper time Used to set the time from pressing the stopper and reaching the parameter No. 45 (ZTT) torque limit to setting the Zero point position while using the stopper method Zero point return. | 100 | msec | 5~1000 | |
| | 45 | ZTT | Stopper method Zero point return operation Torque limit value Used to set the torque limit value for stopper method Zero point return as a percentage (%) in respect to the max. torque. | 15 | % | 1~100 | |
| | 46 47 | *LMP | Software limit address +high Software limit address +low Used to set the software stroke limit address to the Increment side. If the same value as "software limit -" is set, the software limit will be disabled. Set the same sign for No. 46 and 47. If differing signs are set, a parameter error will occur. | 0 | ×10 ^{STM} μm | -999999 ~ 999999 | |
| | 48 49 | *LMN | Software limit address -high Software limit address -low Used to set the software stroke limit address to the decrement side. Parameter No. 50 will be the high-order three digits. If the same value as "software limit +" is set, the software limit will be disabled. Set the same sign for No. 48 and 49. If differing signs are set, a parameter error will occur. | 0 | ×10 ^{STM} μm | -999999 ~ 999999 | |
| | 50 51 | *LPP | Position range output address +high Position range output address +low Used to set the position range output address to the Address increment side. Parameter No. 50 will be the high-order three digits. Set the same sign for No. 50 and 51. If differing signs are set, a parameter error will occur. | 0 | ×10 ^{STM} μm | -999999 ~ 999999 | |
| | 52 53 | *LNP | Position range output address -high Position range output address -low Used to set the position range output address to the Address decrement side. Parameter No. 52 will be the High-order three digits. Set the same sign for No. 52 and 53. If differing signs are set, a parameter error will occur. | 0 | ×10 ^{STM} μm | -999999 ~ 999999 | |

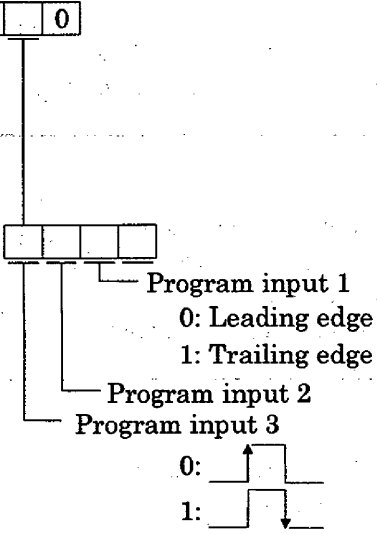
For parameters marked with an asterisk (*), turn the power off after setting and the power back on to complete the setting.

| | No. | Symbol | Name and function | Initial value | Unit | Setting range | | | |
|--------------------|-----|--------|---|---------------|--------|---------------|------|------|---------------------|
| Special parameters | 54 | OUT1 | OUT1 output time selection This parameter turn on OUT1 during the set time. If "0" is set, OUT1 turn on to the OUT OF(1) command | 0 | 10msec | 0~ 2000 | | | |
| | 55 | OUT2 | OUT2 output time selection This parameter turn on OUT2 during the set time. If "0" is set, OUT2 turn on to the OUT OF(2) command | 0 | 10msec | 0~ 2000 | | | |
| | 56 | OUT3 | OUT3 output time selection This parameter turn on OUT3 during the set time. If "0" is set, OUT3 turn on to the OUT OF(3) command | 0 | 10msec | 0~ 2000 | | | |
| | 57 | *SYC | Selected to program input porality Used to select the device which reverses the program input polarity. <div style="text-align: center;"> <table border="1" style="display: inline-table; border-collapse: collapse;"> <tr> <td style="padding: 2px;">0</td> <td style="padding: 2px;">0</td> <td style="padding: 2px;">0</td> </tr> </table> </div>  <p style="margin-left: 40px;"> Program input 1 0: Leading edge 1: Trailing edge Program input 2 Program input 3 0:  1:  </p> | 0 | 0 | 0 | 0000 | | 0000h ~ FFFFh |
| | 0 | 0 | 0 | | | | | | |
| | 58 | *DIO | Input / Output device selection Used to select the CN1A-19 pin to output device or input device. <div style="text-align: center;"> <table border="1" style="display: inline-table; border-collapse: collapse;"> <tr> <td style="padding: 2px;"></td> <td style="padding: 2px;">0</td> <td style="padding: 2px;">0</td> <td style="padding: 2px;"></td> </tr> </table> </div> <p style="margin-left: 40px;"> CN1A-19pin. 0: Input device 1: Output device External dynamic-brake selection 0: Invalid 1: Valid When selected the external dynamic-brake output at parameter No.62, 63, 64, it must be set "1". Note: Similar Function could be realized with SETUP S/W. </p> | | 0 | 0 | | 0000 | |
| | 0 | 0 | | | | | | | |

For parameters marked with an asterisk (*), turn the power off after setting and the power back on to complete the setting.

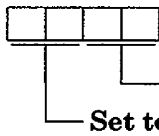
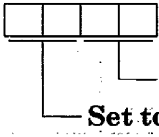
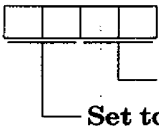
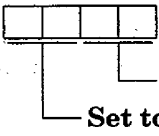
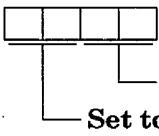
| No. | Symbol | Name and function | Initial value | Unit | Setting range | | | | | | | | | | | | | | | | | | | | | | | | | | | | | | | | | | | | | | | | | | | | | | | | | | | | | | | | |
|--------------------|---|---|----------------------------|-----------------------|---------------|----------------|----|-------------|----|-------|----|----------------|----|--------------------|----|----------|----|-----------------------|----|-------|----|-----------------------|----|--------------------|----|----------------------|----|--------------------|----|--------------------------|----|---------------|----|----------------------------|----|---------------|----|----------------------------|----|----------------------------|----|-----------------|----|---------------|----|-----------------|----|-------------------------|----|-----------------|----|-------------------------|----|-------|----|-------------------------|----|-------|------|--|---------------------|
| Special parameters | 59 | <p>*DI1 Input device selection 1 Used to select the function of CN1A-8 pin and CN1A-19 pin.</p>  <p style="text-align: center;">Set to the function of CN1A-8pin. Set to the function of CN1A-19pin.</p> <table border="1" style="width: 100%; border-collapse: collapse;"> <thead> <tr> <th>Setting</th> <th>Input function</th> <th>Setting</th> <th>Input function</th> </tr> </thead> <tbody> <tr> <td>00</td> <td>No function</td> <td>0D</td> <td>Spare</td> </tr> <tr> <td>01</td> <td>Emergency stop</td> <td>0E</td> <td>Override selection</td> </tr> <tr> <td>02</td> <td>Servo on</td> <td>0F</td> <td>External torque limit</td> </tr> <tr> <td>03</td> <td>Reset</td> <td>10</td> <td>Internal torque limit</td> </tr> <tr> <td>04</td> <td>Forward stroke end</td> <td>11</td> <td>Proportional control</td> </tr> <tr> <td>05</td> <td>Reverse stroke end</td> <td>12</td> <td>Temporarily stop/restart</td> </tr> <tr> <td>06</td> <td>Forward start</td> <td>13</td> <td>Manual P.G magnification 1</td> </tr> <tr> <td>07</td> <td>Reverse start</td> <td>14</td> <td>Manual P.G magnification 2</td> </tr> <tr> <td>08</td> <td>Automatic/manual selection</td> <td>15</td> <td>Program input 1</td> </tr> <tr> <td>09</td> <td>Proximity DOG</td> <td>16</td> <td>Program input 2</td> </tr> <tr> <td>0A</td> <td>Program No. selection 1</td> <td>17</td> <td>Program input 3</td> </tr> <tr> <td>0B</td> <td>Program No. selection 2</td> <td>18</td> <td>Spare</td> </tr> <tr> <td>0C</td> <td>Program No. selection 3</td> <td>19</td> <td>Spare</td> </tr> </tbody> </table> <p>Note : Similar Function could be realized with SETUP S/W</p> | Setting | Input function | Setting | Input function | 00 | No function | 0D | Spare | 01 | Emergency stop | 0E | Override selection | 02 | Servo on | 0F | External torque limit | 03 | Reset | 10 | Internal torque limit | 04 | Forward stroke end | 11 | Proportional control | 05 | Reverse stroke end | 12 | Temporarily stop/restart | 06 | Forward start | 13 | Manual P.G magnification 1 | 07 | Reverse start | 14 | Manual P.G magnification 2 | 08 | Automatic/manual selection | 15 | Program input 1 | 09 | Proximity DOG | 16 | Program input 2 | 0A | Program No. selection 1 | 17 | Program input 3 | 0B | Program No. selection 2 | 18 | Spare | 0C | Program No. selection 3 | 19 | Spare | 0209 | | 0000h ~ 1F1Fh |
| | Setting | Input function | Setting | Input function | | | | | | | | | | | | | | | | | | | | | | | | | | | | | | | | | | | | | | | | | | | | | | | | | | | | | | | | | |
| | 00 | No function | 0D | Spare | | | | | | | | | | | | | | | | | | | | | | | | | | | | | | | | | | | | | | | | | | | | | | | | | | | | | | | | | |
| | 01 | Emergency stop | 0E | Override selection | | | | | | | | | | | | | | | | | | | | | | | | | | | | | | | | | | | | | | | | | | | | | | | | | | | | | | | | | |
| | 02 | Servo on | 0F | External torque limit | | | | | | | | | | | | | | | | | | | | | | | | | | | | | | | | | | | | | | | | | | | | | | | | | | | | | | | | | |
| 03 | Reset | 10 | Internal torque limit | | | | | | | | | | | | | | | | | | | | | | | | | | | | | | | | | | | | | | | | | | | | | | | | | | | | | | | | | | |
| 04 | Forward stroke end | 11 | Proportional control | | | | | | | | | | | | | | | | | | | | | | | | | | | | | | | | | | | | | | | | | | | | | | | | | | | | | | | | | | |
| 05 | Reverse stroke end | 12 | Temporarily stop/restart | | | | | | | | | | | | | | | | | | | | | | | | | | | | | | | | | | | | | | | | | | | | | | | | | | | | | | | | | | |
| 06 | Forward start | 13 | Manual P.G magnification 1 | | | | | | | | | | | | | | | | | | | | | | | | | | | | | | | | | | | | | | | | | | | | | | | | | | | | | | | | | | |
| 07 | Reverse start | 14 | Manual P.G magnification 2 | | | | | | | | | | | | | | | | | | | | | | | | | | | | | | | | | | | | | | | | | | | | | | | | | | | | | | | | | | |
| 08 | Automatic/manual selection | 15 | Program input 1 | | | | | | | | | | | | | | | | | | | | | | | | | | | | | | | | | | | | | | | | | | | | | | | | | | | | | | | | | | |
| 09 | Proximity DOG | 16 | Program input 2 | | | | | | | | | | | | | | | | | | | | | | | | | | | | | | | | | | | | | | | | | | | | | | | | | | | | | | | | | | |
| 0A | Program No. selection 1 | 17 | Program input 3 | | | | | | | | | | | | | | | | | | | | | | | | | | | | | | | | | | | | | | | | | | | | | | | | | | | | | | | | | | |
| 0B | Program No. selection 2 | 18 | Spare | | | | | | | | | | | | | | | | | | | | | | | | | | | | | | | | | | | | | | | | | | | | | | | | | | | | | | | | | | |
| 0C | Program No. selection 3 | 19 | Spare | | | | | | | | | | | | | | | | | | | | | | | | | | | | | | | | | | | | | | | | | | | | | | | | | | | | | | | | | | |
| 60 | <p>*DI2 Input device selection 2 Used to select the function of CN1B-5 pin and CN1B-7 pin.</p>  <p style="text-align: center;">Set to the function of CN1B-5pin. Set to the function of CN1B-7pin.</p> <p>Note : Similar Function could be realized with SETUP S/W</p> | 060A | | 0000h ~ 1F1Fh | | | | | | | | | | | | | | | | | | | | | | | | | | | | | | | | | | | | | | | | | | | | | | | | | | | | | | | | | |
| 61 | <p>*DI3 Input device selection 3 Used to select the function of CN1B-8 pin and CN1B-9 pin.</p>  <p style="text-align: center;">Set to the function of CN1B-8pin. Set to the function of CN1B-9pin.</p> <p>Note : Similar Function could be realized with SETUP S/W</p> | 1615 | | 0000h ~ 1F1Fh | | | | | | | | | | | | | | | | | | | | | | | | | | | | | | | | | | | | | | | | | | | | | | | | | | | | | | | | | |
| 62 | <p>*DI4 Input device selection 4 Used to select the function of CN1B-14 pin and CN1B-15 pin.</p>  <p style="text-align: center;">Set to the function of CN1B-14pin. Set to the function of CN1B-15pin.</p> <p>Note : Similar Function could be realized with SETUP S/W</p> | 030B | | 0000h ~ 1F1Fh | | | | | | | | | | | | | | | | | | | | | | | | | | | | | | | | | | | | | | | | | | | | | | | | | | | | | | | | | |
| 63 | <p>*DI5 Input device selection 5 Used to select the function of CN1B-16 pin and CN1B-17 pin.</p>  <p style="text-align: center;">Set to the function of CN1B-16pin. Set to the function of CN1B-17pin.</p> <p>Note : Similar Function could be realized with SETUP S/W</p> | 0504 | | 0000h ~ 1F1Fh | | | | | | | | | | | | | | | | | | | | | | | | | | | | | | | | | | | | | | | | | | | | | | | | | | | | | | | | | |

For parameters marked with an asterisk (*), turn the power off after setting and the power back on to complete the setting.

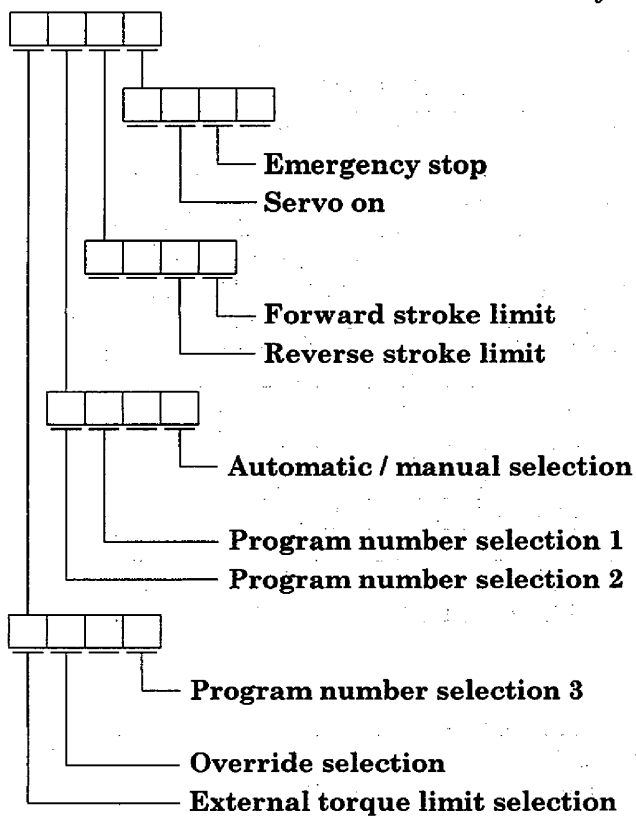
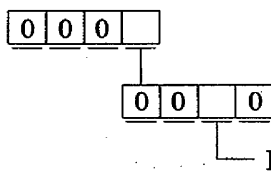
| | No. | Symbol | Name and function | Initial value | Unit | Setting range |
|--------------------|-----|--------|--|---------------|------|---------------------|
| Special parameters | 64 | *DI6 | <p>Input / Output device selection 6 Selected to the function device signal turns on automatically.</p>  <p style="text-align: center;">0: Invalid 1: Valid</p> <p>Note : Similar Function could be realized with SETUP S/W.</p> | 0102 | | 0000h ~ FFFFh |
| | 65 | *DI7 | <p>Input / Output device selection 7 Selected to the function device signal turns on automatically.</p>  <p style="text-align: center;">0: Invalid 1: Valid</p> <p>Note : Similar Function could be realized with SETUP S/W.</p> | 0000 | | 0000h ~ FFFFh |

For parameters marked with an asterisk (*), turn the power off after setting and the power back on to complete the setting.

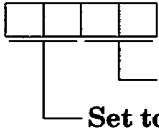
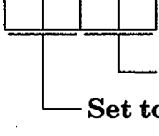
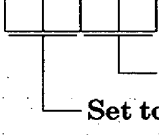
| | No. | Symbol | Name and function | Initial value | Unit | Setting range | | | | | | | | | | | | | | | | | | | | | | | | | | | | | | | | | | | | | | | | |
|--------------------|----------------------------|-----------------|--|-----------------|-----------------|---------------------|-----------------|----|-------------|----|---------|----|-------|----|-----------------|----|-------|----|------------------------|----|-------|----|--------------------|----|-------|----|------------------|----|----------------------------|----|------------------|----|-----------------------|----|------------------|----|---------------|----|------------------|----|----------------|----|-------------------|------|--|---------------------|
| Special parameters | 66 | *DO1 | <p>Output device selection 1 Used to select the function of CN1A-18 pin and CN1A-19 pin.</p>  <p>— Set to the function of CN1A-18pin. — Set to the function of CN1A-19pin.</p> <table border="1" data-bbox="349 398 1088 707"> <thead> <tr> <th>Setting</th> <th>Output function</th> <th>Setting</th> <th>Output function</th> </tr> </thead> <tbody> <tr> <td>00</td> <td>No function</td> <td>09</td> <td>Warning</td> </tr> <tr> <td>01</td> <td>Ready</td> <td>0A</td> <td>Battery warning</td> </tr> <tr> <td>02</td> <td>Alarm</td> <td>0B</td> <td>Torque limit in effect</td> </tr> <tr> <td>03</td> <td>Spare</td> <td>0C</td> <td>Temporary stopping</td> </tr> <tr> <td>04</td> <td>Spare</td> <td>0D</td> <td>Program output 1</td> </tr> <tr> <td>05</td> <td>Zero point return complete</td> <td>0E</td> <td>Program output 2</td> </tr> <tr> <td>06</td> <td>Electromagnetic brake</td> <td>0F</td> <td>Program output 3</td> </tr> <tr> <td>07</td> <td>Dynamic brake</td> <td>10</td> <td>SYNC synchronous</td> </tr> <tr> <td>08</td> <td>Position range</td> <td>11</td> <td>Movement complete</td> </tr> </tbody> </table> <p>Note : Similar Function could be realized with SETUP S/W.</p> | Setting | Output function | Setting | Output function | 00 | No function | 09 | Warning | 01 | Ready | 0A | Battery warning | 02 | Alarm | 0B | Torque limit in effect | 03 | Spare | 0C | Temporary stopping | 04 | Spare | 0D | Program output 1 | 05 | Zero point return complete | 0E | Program output 2 | 06 | Electromagnetic brake | 0F | Program output 3 | 07 | Dynamic brake | 10 | SYNC synchronous | 08 | Position range | 11 | Movement complete | 0005 | | 0000h ~ 1F1Fh |
| | Setting | Output function | Setting | Output function | | | | | | | | | | | | | | | | | | | | | | | | | | | | | | | | | | | | | | | | | | |
| | 00 | No function | 09 | Warning | | | | | | | | | | | | | | | | | | | | | | | | | | | | | | | | | | | | | | | | | | |
| 01 | Ready | 0A | Battery warning | | | | | | | | | | | | | | | | | | | | | | | | | | | | | | | | | | | | | | | | | | | |
| 02 | Alarm | 0B | Torque limit in effect | | | | | | | | | | | | | | | | | | | | | | | | | | | | | | | | | | | | | | | | | | | |
| 03 | Spare | 0C | Temporary stopping | | | | | | | | | | | | | | | | | | | | | | | | | | | | | | | | | | | | | | | | | | | |
| 04 | Spare | 0D | Program output 1 | | | | | | | | | | | | | | | | | | | | | | | | | | | | | | | | | | | | | | | | | | | |
| 05 | Zero point return complete | 0E | Program output 2 | | | | | | | | | | | | | | | | | | | | | | | | | | | | | | | | | | | | | | | | | | | |
| 06 | Electromagnetic brake | 0F | Program output 3 | | | | | | | | | | | | | | | | | | | | | | | | | | | | | | | | | | | | | | | | | | | |
| 07 | Dynamic brake | 10 | SYNC synchronous | | | | | | | | | | | | | | | | | | | | | | | | | | | | | | | | | | | | | | | | | | | |
| 08 | Position range | 11 | Movement complete | | | | | | | | | | | | | | | | | | | | | | | | | | | | | | | | | | | | | | | | | | | |
| | 67 | *DO2 | <p>Output device selection 2 Used to select the function of CN1B-6 pin and CN1B-4 pin.</p>  <p>— Set to the function of CN1B-4pin. — Set to the function of CN1B-6pin.</p> <p>Note : Similar Function could be realized with SETUP S/W.</p> | 110D | | 0000h ~ 1F1Fh | | | | | | | | | | | | | | | | | | | | | | | | | | | | | | | | | | | | | | | | |
| | 68 | *DO3 | <p>Output device selection 3 Used to select the function of CN1B-18 pin and CN1B-19 pin.</p>  <p>— Set to the function of CN1B-18pin. — Set to the function of CN1B-19pin.</p> <p>Note : Similar Function could be realized with SETUP S/W.</p> | 0102 | | 0000h ~ 1F1Fh | | | | | | | | | | | | | | | | | | | | | | | | | | | | | | | | | | | | | | | | |

For parameters marked with an asterisk (*), turn the power off after setting and the power back on to complete the setting.

11. Set-up S/W

(1) Set-up software

The Set-up S/W of the MR-J2-□□ C-S100 is an exclusive Set-up S/W which has an extension screen within standard Set-up S/W.

(2) Screen

The screen definitions of this Set-up S/W is same as standard version.

(3) File

Same as MR-J2A

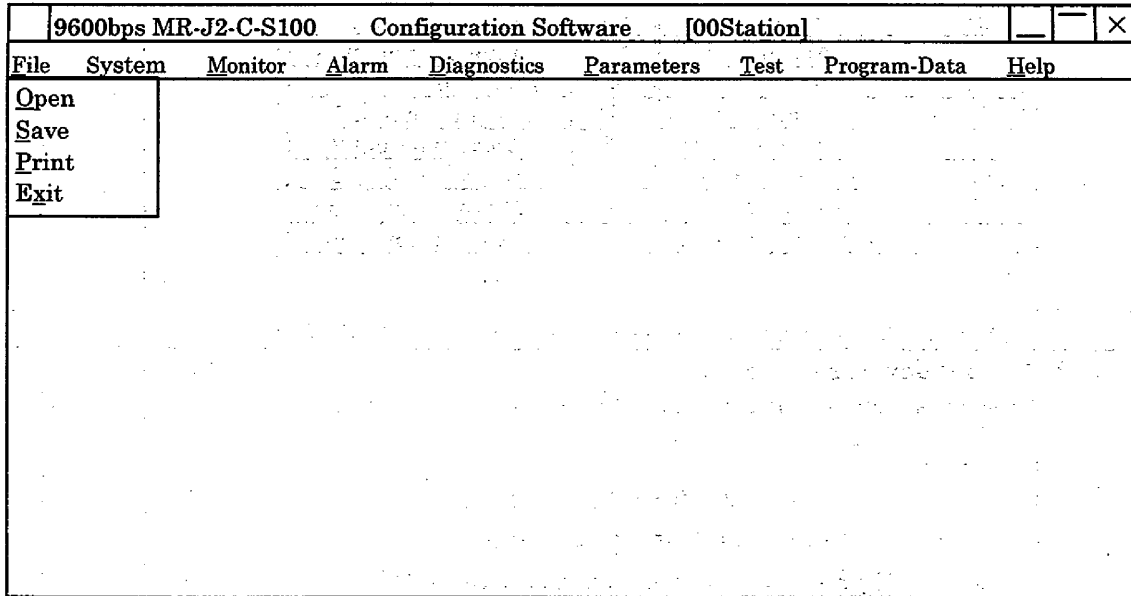

(4) System

Same as MR-J2A

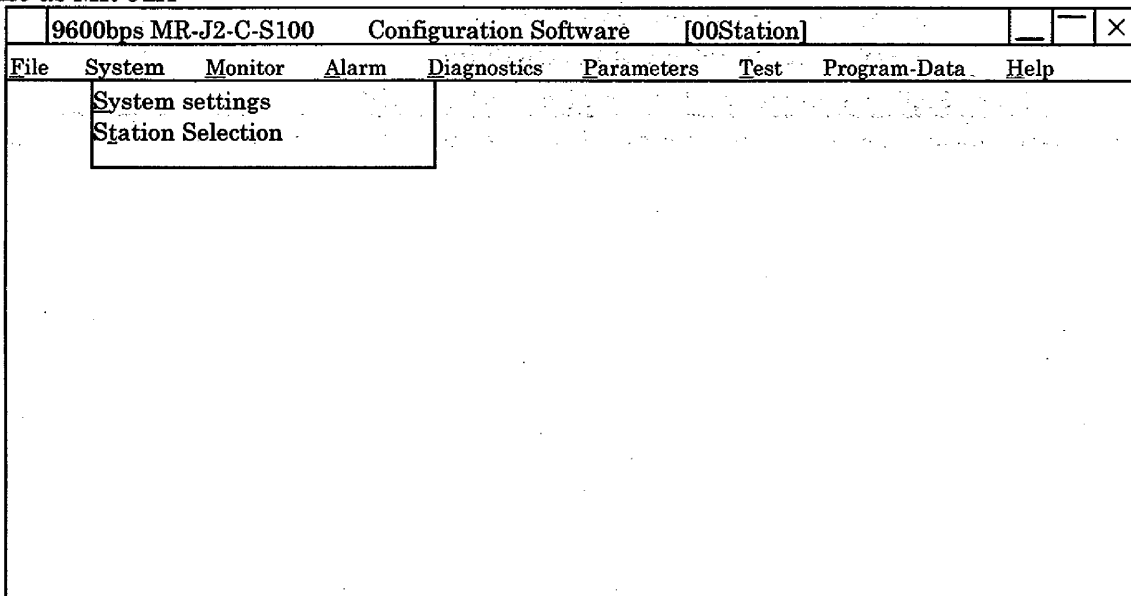

(5) Monitor

Same as MR-J2A

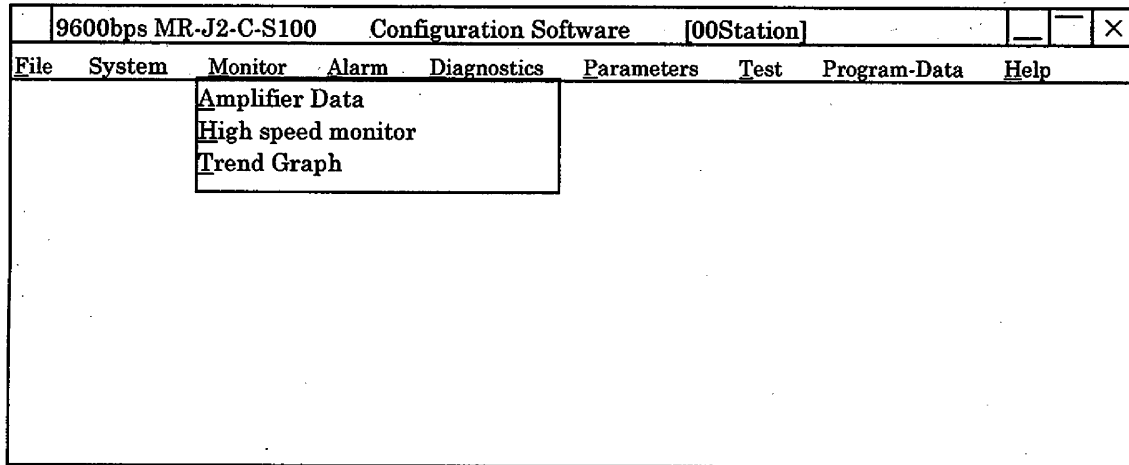

The monitor display items are as followings :

| Name | Display range | Unit | Description |
|------------------------------|--------------------------|-------|---|
| Current position | -999999 ~ 999999 | mm | The current position from the machine home position of 0 is displayed. |
| Command position | -999999 ~ 999999 | mm | The position data in the program data or setting data to command position is displayed. |
| Command remaining distance | -999999 ~ 999999 | mm | During operation, the remaining distance between current position and command position is display. During the stop, the next fee distance is displayed. |
| Program number | 1~8 | | The executing program number is displayed. |
| Feedback pulse accumulation | -9999999 ~ 9999999 | pulse | Feedback pulses from the servo motor encoder are counted and displayed. When the value exceeds ± 999999 , it begins with 0. Press the clear button to reset the display value to 0. |
| Motor speed | -5400 ~ 5400 | r/min | The servo motor speed is displayed. |
| Drop pulse | -9999999 ~ 9999999 | pulse | The number of droop pulses in the deviation counter is displayed. |
| Override | 0~200 | % | Override setting value at the parameter is displayed. When set to the override invalid, this display is 100%. |
| Torque limit command voltage | 0.00 ~ 10.00 | V | Torque limit command voltage is displayed. |
| Regeneration load factor | 0~100 | % | The ration of regenerative power to permissible regenerative power is displayed in %. |
| Effective load factor | 0~300 | % | The continuous effective load torque is displayed. When rated torque is generated, this value is 100%. The effective value for the past 15 seconds is displayed. |
| Peak load factor | 0~300 | % | The peak load torque is displayed. When rated torque is generated, this value is 100%. The peak torque for the past 15 seconds is displayed. |
| Position within one rotation | 0~16383 | pulse | Position within one revolution is display in encoder pulses. When the value exceeds 8192 on the HC-FF and HC-MF, it begins with 0. The value exceeds 16384 on other motors. |
| ABS counter | -32768 ~ 32767 | rev | Travel value from the home position in the absolute position detection system is displayed in terms of the absolute position detection's counter value. |
| Load/inertia ratio | 0.0~100.0 | times | The estimated ratio of the load inertia moment to the servo motor inertia moment is displayed. |

(6) Alarm

Same as MR-J2A

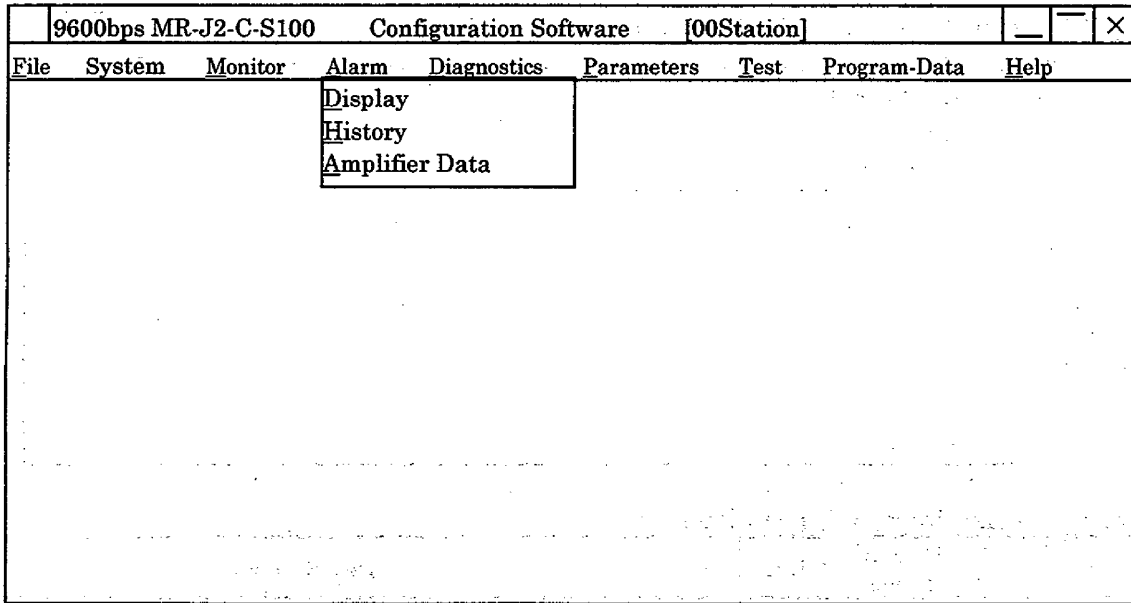

(7) Diagnostic

Added to the function device displays

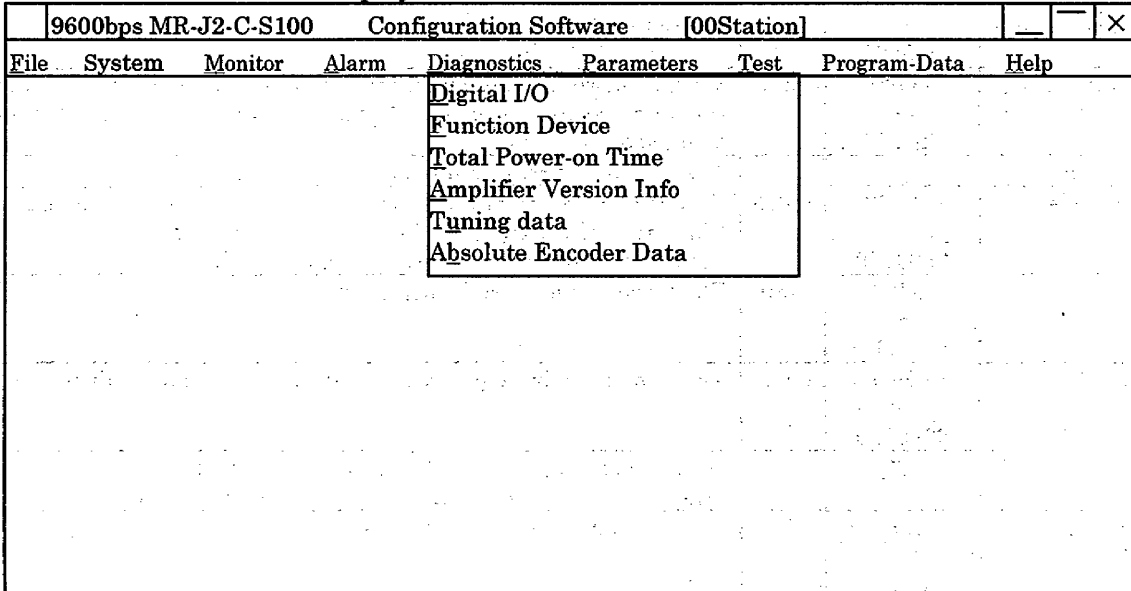

(8) Parameter

9600bps MR-J2-C-S100 Configuration Software [00Station]

File System Monitor Alarm Diagnostics Parameters Test Program-Data Help

Parameter list
I/O Devices

(9) I/O Device

MR-J2-CX 19200bps Servo Set-up Software

File System Monitor Alarm Diagnostics Parameters Test Program-Data Help

| Input device setting | | Output device setting | |
|-----------------------------|------------------|----------------------------|-------------------|
| Function | Input PIN-number | Function | Output PIN-number |
| EMG : Emergency stop | | RD : Ready | CN1B-19 |
| SON : Servo on | | ALM : Trouble | CN1B-18 |
| RES : Alarm reset | | SPARE | CN1B-6 |
| LSP : Forward rot. stroke | CN1B-16 | SPARE | |
| LSN : Reverse rot. stroke | CN1B-17 | ZP : Z phase | CN1A-18 |
| ST1 : Forward rot. start | CN1B-7 | MBR : Elec. Brake | |
| ST2 : Reverse rot. start | CN1A-19 | DBR : Dynamic brake | |
| MDO : Automatic/manual | | POT : Position range | |
| DOG : Proximity DOG | CN1A-8 | WNG : Warning | |
| PS0 : Program selection 1 | CN1B-5 | BWNG : Battery warning | |
| PS1 : Program selection 2 | CN1B-14 | TLC : Limiting torque | |
| PS2 : Program selection 3 | CN1B-15 | PUS : Temporary stopping | |
| SPARE | | OUT1 : Output program 1 | CN1B-4 |
| OVR : Override | | OUT2 : Output program 2 | |
| TL : External torque limit | | OUT3 : Output program 3 | |
| TL2 : Internal torque limit | | SOUT : Output Sync. Signal | |
| PC : Proportion control | | PED : Moving completed | |
| STP : Temp. stop/restart | | | |
| TP0 : Pulse gen. Mul.1 | | | |
| TP1 : Pulse gen. Mul.2 | | | |
| PI1 : Program input1 | CN1B-8 | | |
| PI2 : Program input2 | CN1B-9 | | |
| PI3 : Program input3 | | | |

Select CN1A-19
 Input
 Output

Read All
Write All
Set to Default
Close

Verify
Free Pins

Help

(10) Test

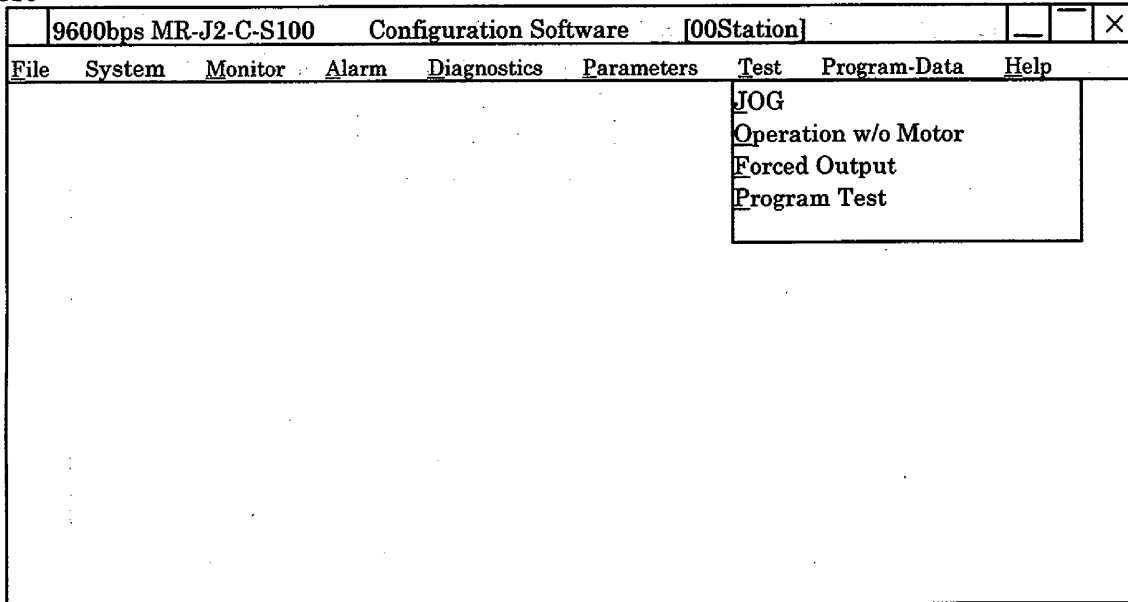

(11) Program test operation

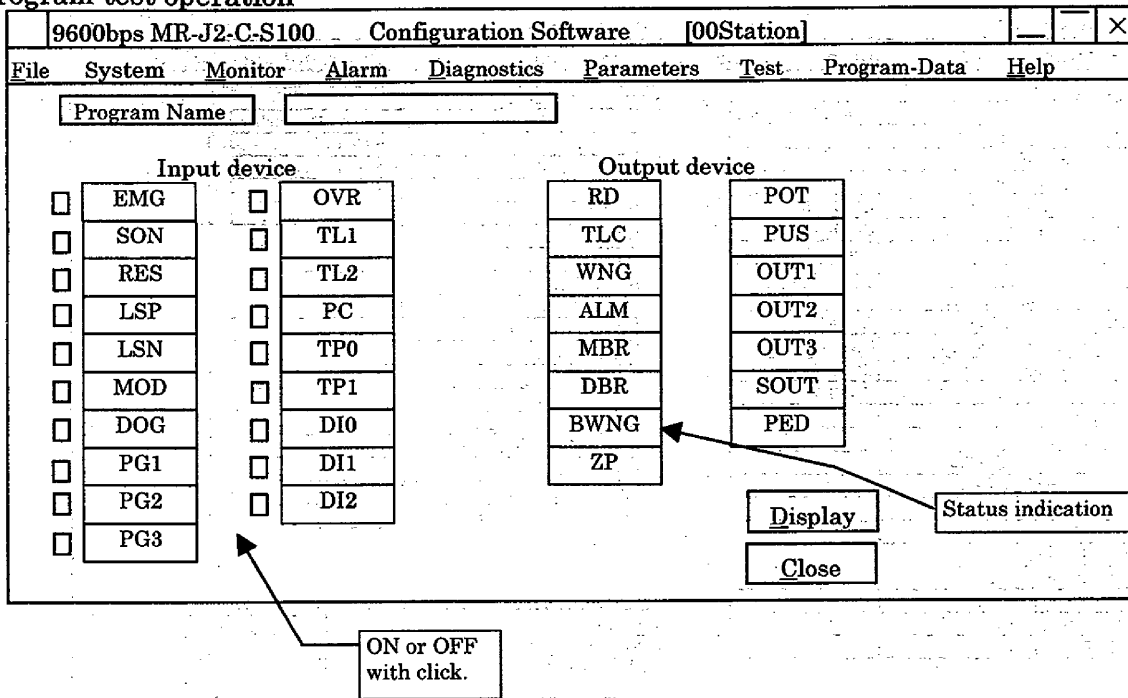

(12) Program test operation

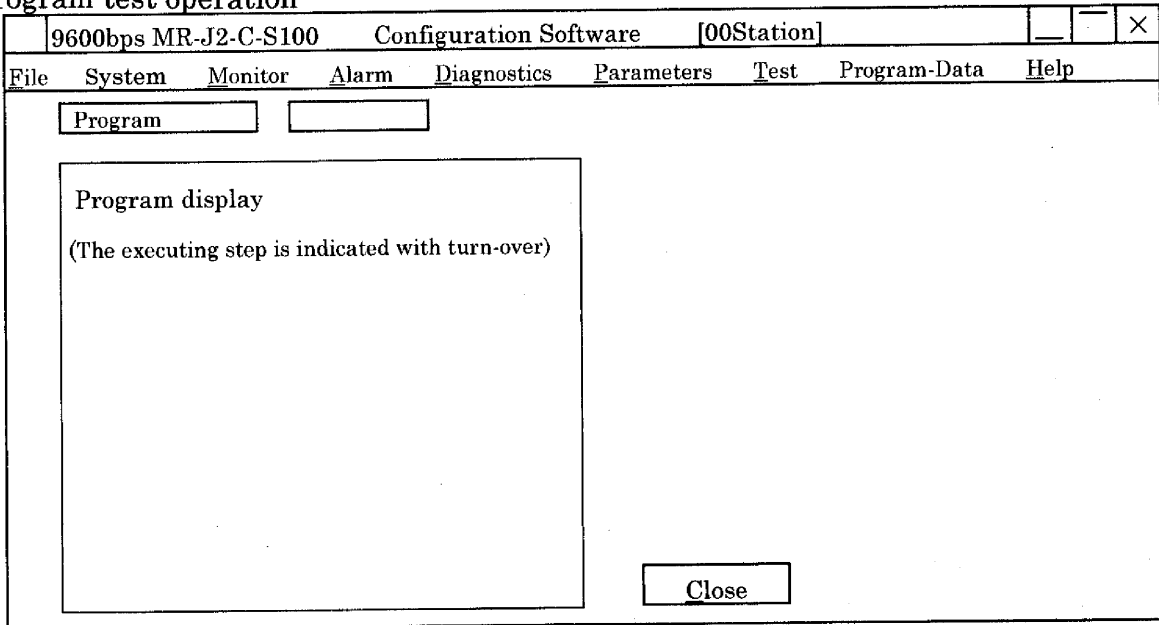

(13) How to call the general-purpose register write screen

1) Calling the Indirect Addressing screen from the menu of the main screen

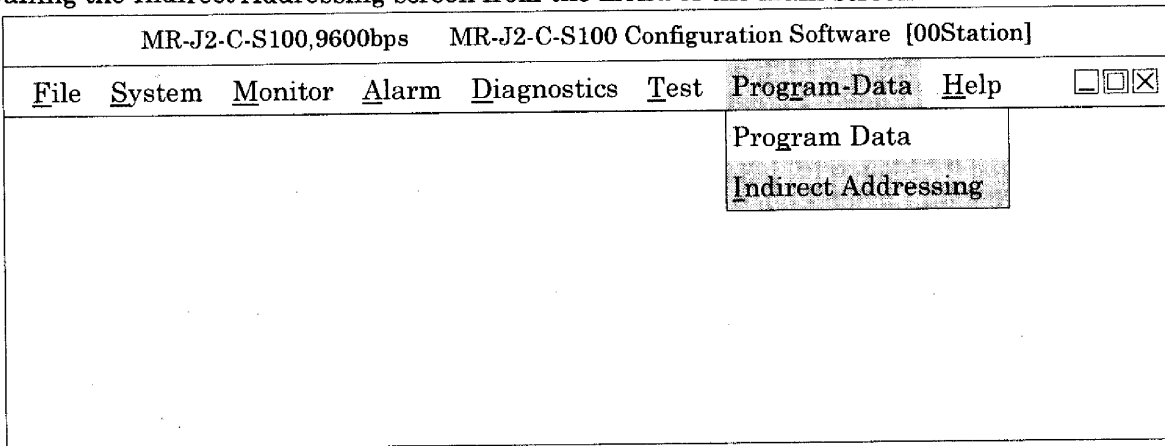

2) Indirect Addressing screen

Indirect Addressing

D1 : 50 D2 : 200

Register Writing Mode

R1 R2

1000 300000

RAM RAM

EEPROM EEPROM

Read All Write All Close

Data input area

- The Indirect Addressing screen is called from the menu.
- Press the Read All button to read the register data from the servo amplifier.
Commands used Rx ... [6D] [Register number]
 Dx ... [6E] [Register number]
- Set any value in the data input field. (Leave the field blank for default value setting)
- In the Register Writing Mode, set the write mode of register Rx. (The default setting is RAM write)
- Press the Write All button to write the data to the servo amplifier. (If all settings are blank, an error occurs.)
Commands used Rx ... [B9] [Register number]
 Dx ... [BA] [Register number]
- Press the Close button to close the Indirect Addressing screen.

(14) Program data

Set to the program data

Program command screen

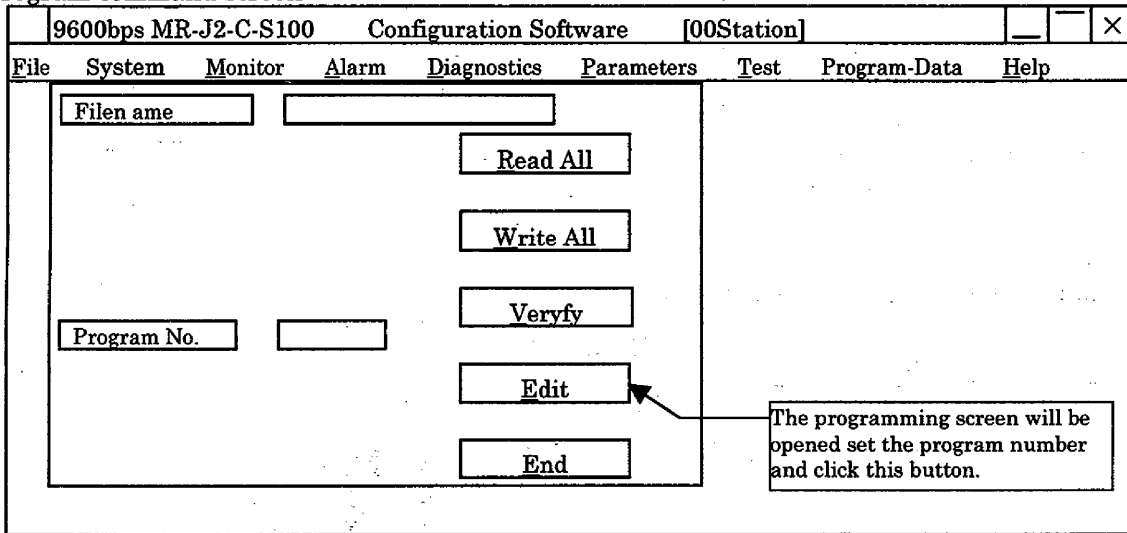

(15) Programming screen

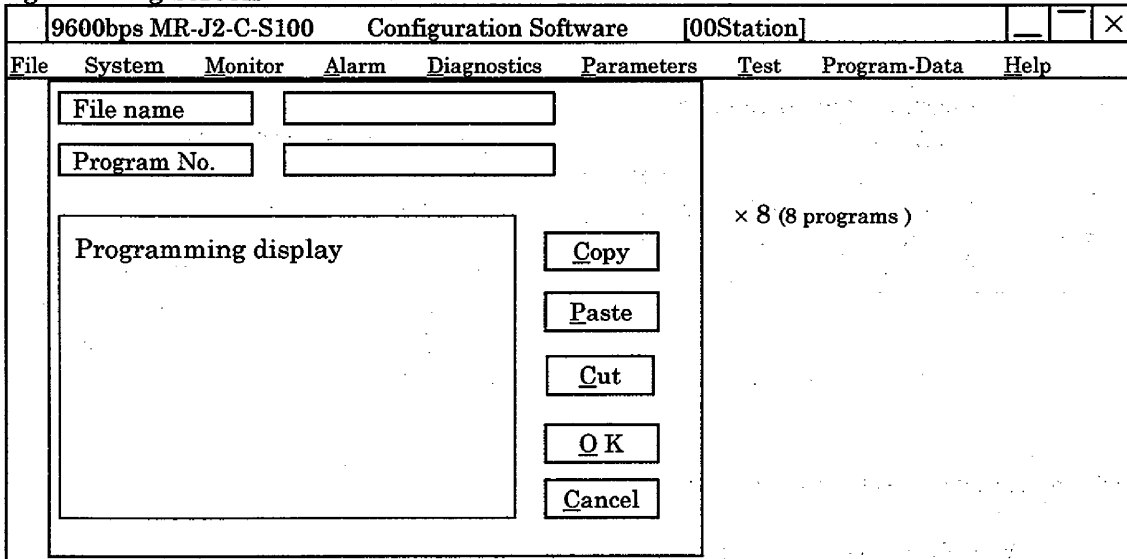

(16) Help

Same as MR-J2A

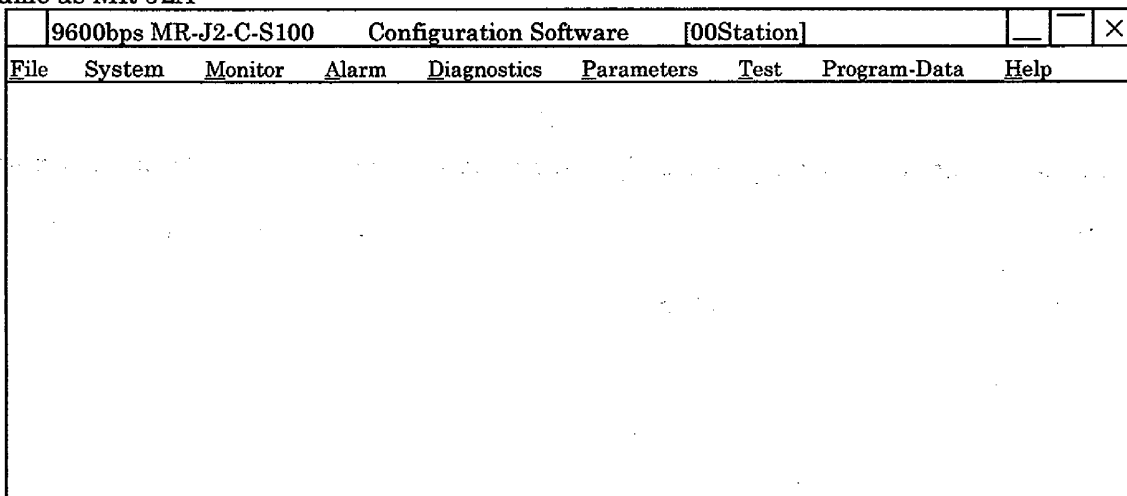

(3) Character codes used

1) Control code

| Code name | Hexadecimal (ASCII code) | Contents | Conventional key operations at a personal computer or terminal. |
|-----------|-----------------------------|---|--|
| SOH | 01H | Start of head (communication start) | ctrl + A |
| STX | 02H | Start of text (text start) | ctrl + B |
| ETX | 03H | End of text (text end) | ctrl + C |
| EOT | 04H | End of transmission(communication interruption) | ctrl + D |

2) Data code

Use the JIS8 unit codes:

| | | | | | | | | |
|----------------|---|---|---|---|---|---|---|---|
| b ₈ | 0 | 0 | 0 | 0 | 0 | 0 | 0 | 0 |
| b ₇ | 0 | 0 | 0 | 0 | 1 | 1 | 1 | 1 |
| b ₆ | 0 | 0 | 1 | 1 | 0 | 0 | 1 | 1 |
| b ₅ | 0 | 1 | 0 | 1 | 0 | 1 | 0 | 1 |

| b ₈ b ₇ b ₆ b ₅ | b ₄ | b ₃ | b ₂ | b ₁ | R/C | 0 | 1 | 2 | 3 | 4 | 5 | 6 | 7 |
|---|----------------|----------------|----------------|----------------|-----|-----|-----------------|-------|---|---|---|---|-----|
| 0000 | 0 | 0 | 0 | 0 | 0 | NUL | DLE | Space | 0 | @ | P | \ | p |
| 0001 | 0 | 0 | 0 | 1 | 1 | SOH | DC ₁ | ! | 1 | A | Q | a | q |
| 0010 | 0 | 0 | 1 | 0 | 2 | STX | DC ₂ | " | 2 | B | R | b | r |
| 0011 | 0 | 0 | 1 | 1 | 3 | ETX | DC ₃ | # | 3 | C | S | c | s |
| 0100 | 0 | 1 | 0 | 0 | 4 | | | \$ | 4 | D | T | d | t |
| 0101 | 0 | 1 | 0 | 1 | 5 | | | % | 5 | E | U | e | u |
| 0110 | 0 | 1 | 1 | 0 | 6 | | | & | 6 | F | V | f | v |
| 0111 | 0 | 1 | 1 | 1 | 7 | | | ' | 7 | G | W | g | w |
| 1000 | 1 | 0 | 0 | 0 | 8 | | | (| 8 | H | X | h | x |
| 1001 | 1 | 0 | 0 | 1 | 9 | | |) | 9 | I | Y | i | y |
| 1010 | 1 | 0 | 1 | 0 | 10 | | | * | : | J | Z | j | z |
| 1011 | 1 | 0 | 1 | 1 | 11 | | | + | ; | K | [| k | { |
| 1100 | 1 | 1 | 0 | 0 | 12 | | | , | < | L | ¥ | l | |
| 1101 | 1 | 1 | 0 | 1 | 13 | | | - | = | M |] | m | } |
| 1110 | 1 | 1 | 1 | 0 | 14 | | | . | > | N | ^ | n | □ |
| 1111 | 1 | 1 | 1 | 1 | 15 | | | / | ? | O | _ | o | DEL |

3) Stations

There are 32 stations from station 0 to station 31. JIS8 unit code are used to designate the station.

| | | | | | | | | | | | | | | | | |
|-----------|----|----|----|----|----|----|----|----|----|----|----|----|----|----|----|----|
| Station | 0 | 1 | 2 | 3 | 4 | 5 | 6 | 7 | 8 | 9 | 10 | 11 | 12 | 13 | 14 | 15 |
| JIS8 code | 0 | 1 | 2 | 3 | 4 | 5 | 6 | 7 | 8 | 9 | A | B | C | D | E | F |
| Station | 16 | 17 | 18 | 19 | 20 | 21 | 22 | 23 | 24 | 25 | 26 | 27 | 28 | 29 | 30 | 31 |
| JIS8 code | G | H | I | J | K | L | M | N | O | P | Q | R | S | T | U | V |

Example) For station number "0" (1st axis)
Transfer "00H" as a hexadecimal.

(4) Error code

The error code are used in the following cases, and are transmitted in 1-code lengths.
As the response for when transmitting data from the controller to the servo (slave station), the servo transmits an error code to the controller.

| Error code | | Error mane | Descriptions | Remarks |
|--------------|-------------|------------------|--|-------------------|
| Servo normal | Servo alarm | | | |
| [A] | [a] | Normal operation | Data transmitted was processed properly. | Positive response |
| [B] | [b] | Parity error | Parity error occurred in the send data transmitted. | Negative response |
| [C] | [c] | Checksum error | Checksum error occurred in the send data transmitted. | |
| [D] | [d] | Character error | Character transmitted is not included in the specifications. | |
| [E] | [e] | Command error | Command transmitted is not included in the specifications. | |
| [F] | [f] | Data No. error | Data No. transmitted is not included in the specifications. | |

(5) Checksum

Checksum calculation range

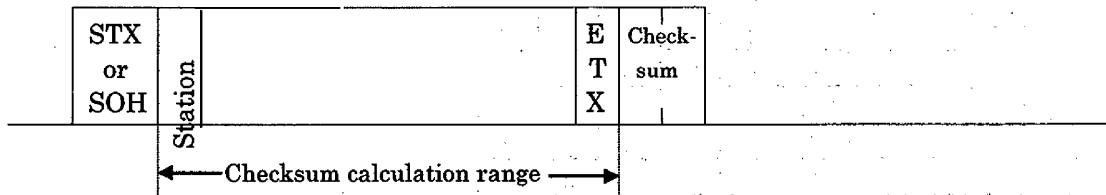

To find a checksum to be appended, the hexadecimal numbers of character codes between the one following the first control code and EXT are summed, and the two least significant digits of the checksum are converted into hexadecimal.

(Example)

| | | | | | | | | | |
|---|-----|-----|-----|-----|-----|-----|-----|-----|-----|
| S | | | | | | | E | | |
| T | [0] | [A] | [1] | [2] | [5] | [F] | T | [5] | [2] |
| X | | | | | | | X | | |
| | 02H | 30H | 41H | 31H | 32H | 35H | 46H | 03H | |

$$30H + 41H + 31H + 32H + 35H + 46H + 03H = 152H$$

The last two digits, 52, are sent as ASCII code [5][2].

(6) Time-out processing's

If the servo (slave) dose not start the return operation (if STX is not received) after the communication process from the controller (master) is completed, EOT will be transmitted to the master after 300mses.

After waiting another 100msec, the statement will be transmitted again.

If there is no response from the slave even after the above operation has been repeated three times, time-out will apply. (communication error)

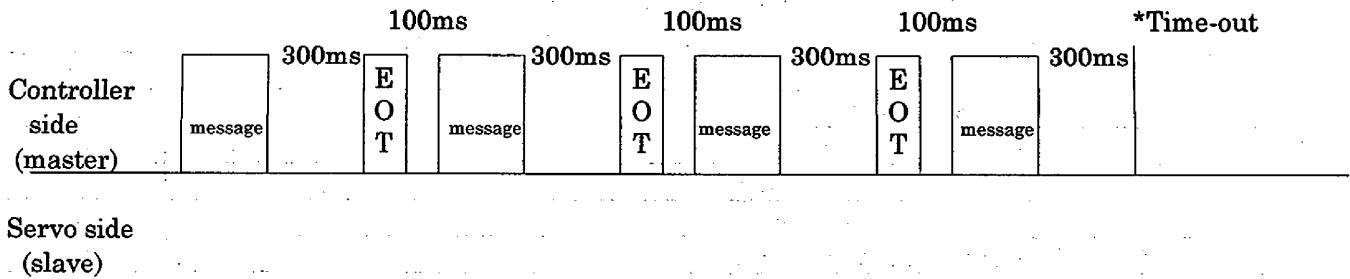

(7) Retry processing's

If an obstacle occurs in the communication between the controller and servo, the error code responded from the servo side will be a not-acknowledge code ([B]~[I], [b]~[I]).

At this time, the controller will transmit the statement that caused the obstacle again as the retry operation. (retry operation)

If the obstacle error code occurs three times or more in succession when the above operation is repeated, a communication error will occur.

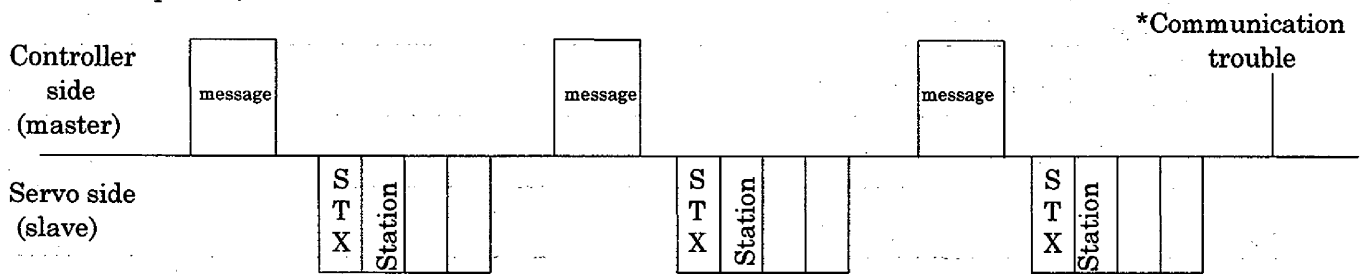

If the controller detects an obstacle (check sum, parity, etc.) in the response data from the servo, the controller will transmit the statement that caused the obstacle again.

When the retry operation has been carried out three times, a communication error will occur.

(8) Communication commands

1) Read commands

| Command | Data No. | Descriptions | Frame length |
|---------|-----------------|---|--------------|
| 01 | 80~8E | Data value and processing information of status display. | 12 |
| 02 | 00 | Current alarm number | 4 |
| 02 | 90 | Absolute position of motor end in pulse unit. | 8 |
| 02 | 91 | Absolute position in command unit. | 8 |
| 05 | 00~35 | Current value of corresponding parameters(the decimal numbers in data number correspond to the parameter numbers) | 8 |
| | | | |
| 12 | 00 | Input devices status | 8 |
| 12 | 40 | External input pin status | 8 |
| 12 | 60 | Communication-ON device | 8 |
| 12 | 80 | Output devices status | 8 |
| 12 | C0 | External output pin status | 8 |
| | | | |
| 33 | 10~15 | Alarm number in alarm history | 4 |
| 33 | 20~25 | Time of alarm occurrence alarm history | 8 |
| 35 | 80~8E | Data value an processing information of status display at alarm occurrence. | 12 |
| | | | |
| 68 | 00~3F | Program data | 8 |
| 69 | Command number | Minimum value of command argument | 8 |
| 6A | Command number | Maximum value of command argument | 8 |
| 6D | Register number | Register (Rx) amount | 8 |
| 6E | Register number | Register (Dx) amount | 8 |

2) Write command

| Command | Data No. | Descriptions | Setting range | Frame length |
|---------|-----------------|--|----------------------------------|--------------|
| 81 | 00 | Status display data clear | 1EA5 | 4 |
| | | | | |
| 82 | 00 | Alarm reset | 1EA5 | 4 |
| 82 | 20 | Alarm history clear | 1EA5 | 4 |
| | | | | |
| 84 | 00~35 | Write of corresponding parameters (the decimal number in data number correspond to the parameter number) | Aries according to parameter No. | 8 |
| | | | | |
| 92 | 60 | Communication device input signal | | 8 |
| | | | | |
| B8 | 00~3F | Program data | | 8 |
| B9 | Register number | Register (Rx) amount | | 8 |
| BA | Register number | Register (Dx) amount | | 8 |

(9) Command

1) Status display read for status display data, its data value and data processing information are return when the data number is transmitted.

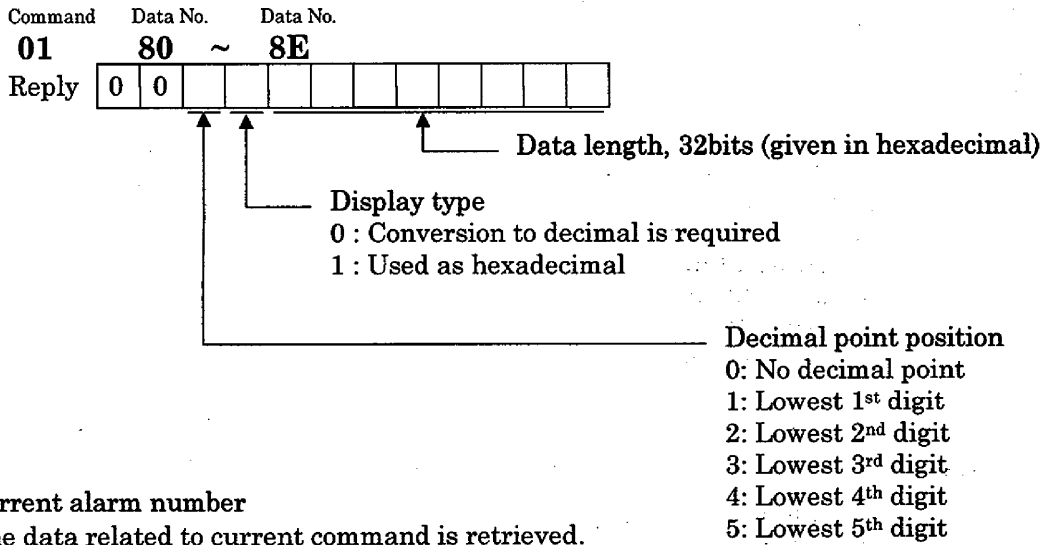

2) Current alarm number

The data related to current command is retrieved.

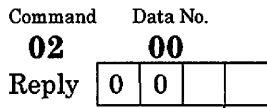

The alarm number is transmitted as a decimal notation.
 (Example)
 For A.32 : data 0032
 For A.50 : data 0050
 For A. : data 00ff (no alarm)

3) Motor end pulse unit absolute position

The absolute position is read with the motor end pulse unit.

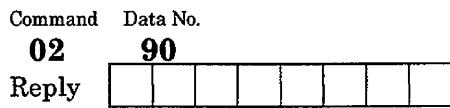

The absolute position is transmitted with the motor end pulse unit as a hexadecimal notation.
 Conversion from hexadecimal to decimal is required.
 (Example)
 Data 000186a0 will be 100000pulses as the motor end pulse unit.

4) Command unit absolute position.

Read the absolute position with the command unit.

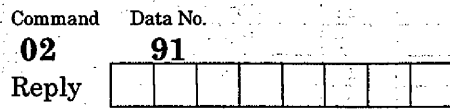

The absolute unit is transmitted with the command unit as a hexadecimal notation.
 Conversion from hexadecimal to decimal is required.
 (Example)
 Data 000186A0 will be 100000pulses as the motor end pulse unit.

7) External input pins read

The status of the external input pins are read.

Command Data No.
12 **40**



Command for each bit is sent to the slave in hexadecimal.
0 : OFF **1 : ON**

| bit | External input pin | bit | External input pin |
|-----|--------------------|-----|--------------------|
| 0 | CN1B-16 | 5 | CN1A-8 |
| 1 | CN1B-17 | 6 | CN1B-7 |
| 2 | CN1B-15 | 7 | CN1B-8 |
| 3 | CN1B-5 | 8 | CN1B-9 |
| 4 | CN1B-14 | 9 | CN1A-19 |

8) Communication-ON device read

The status of the communication-on devices are read.

Command Data No.
12 **60**



Command for each bit is sent to the slave in hexadecimal.
0 : OFF **1 : ON**

| bit | Signals | bit | Signals | bit | Signals |
|-----|---------------------------------------|-----|-------------------------------|-----|--|
| 0 | Servo on (SON) | 10 | | 20 | Program No. selection 2 (PS1) |
| 1 | Forward stroke end (LSP) | 11 | Forward start (ST1) | 21 | Program No. selection 3 (PS2) |
| 2 | Reverse stroke end (LSN) | 12 | Reverse start (ST2) | 22 | Program No. selection 4 (PS3) |
| 3 | External torque limit selection (TL) | 13 | | 23 | Override selection (OVR) |
| 4 | Internal torque limit selection (TL2) | 14 | | 24 | Temporary stop/Restart (STP) |
| 5 | Proportional control (PC) | 15 | | 25 | Manual pulse generator multiplier 1(TP0) |
| 6 | Rest (RES) | 16 | Emergency stop (EMG) | 26 | Manual pulse generator multiplier 2(TP1) |
| 7 | | 17 | Automatic/Manual (MDO) | 27 | Program input 1 (PI1) |
| 8 | | 18 | Proximity (DOG) | 28 | Program input 2 (PI2) |
| 9 | | 19 | Program No. selection 1 (PS0) | 29 | Program input 3 (PI3) |

9) Output devices status read

The status of the output device status are read.

Command Data No.
12 **80**

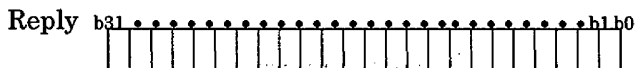

Command for each bit is sent to the slave in hexadecimal.
0 : OFF **1 : ON**

| bit | Signals | bit | Signals | bit | Signals |
|-----|------------------------------|-----|-----------------------------|-----|--------------------------|
| 0 | Ready (RD) | 9 | | 18 | Position range (POT) |
| 1 | | 10 | Electromagnetic brake (MBR) | 19 | Temporary stopping (PUS) |
| 2 | | 11 | Dynamic brake (DRB) | 20 | Program output 1 (OUT1) |
| 3 | Torque limit in effect (TLC) | 12 | | 21 | Program output 2 (OUT2) |
| 4 | | 13 | | 22 | Program output 3 (OUT3) |
| 5 | | 14 | | 23 | SYNC synchronous (SOUT) |
| 6 | | 15 | Battery warning (BWNG) | 24 | Movement complete (PED) |
| 7 | Warning output (WNG) | 16 | | 25 | |
| 8 | Alarm (ALM) | 17 | Z-phase (ZP) | 26 | |

10) External output pins read

The status of the external output pins are read.

Command Data No.
12 **C0**

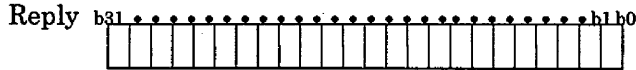

Command for each bit is sent to the slave in hexadecimal.
0 : OFF **1 : ON**

| bit | External output pins | bit | External output pins |
|-----|----------------------|-----|----------------------|
| 0 | CN1A-19 | 5 | CN1B-18 |
| 1 | CN1A-18 | 6 | |
| 2 | CN1B-19 | | |
| 3 | CN1B-6 | | |
| 4 | CN1B-4 | | |

11) Alarm number in alarm history

The history of alarm which occurred in the past are read.

Command Data No. Data No.
33 **10** ~ **15**

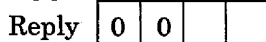

The alarm number is transferred in decimal.
 (Example)
 Data 0032 for A.32
 Data 0052 for A.50
 Data 00FF for A. (None alarm)

12) Alarm occurrence time in alarm history.

The alarm occurrence from time in alarm history which occurred in the past are read.

Command Data No. Data No.
33 **20** ~ **25**

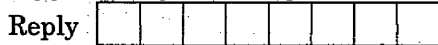

The time is transmitted as a hexadecimal notation.
 Conversion from hexadecimal to decimal is required.
 (Example)
 Data 01F5 indicates that the alarm occurred 501 hours after operation was started.

13) Reading of status display when alarm occurs.

The status display data is read out when an alarm occurs.

The status display data transmits the data value and data machining information when the data number is transmitted.

Command Data No. Data No.
35 **80** ~ **8E**



32-bit length data (hexadecimal notation)

Display type
 0: Conversion to decimal is required
 1: Use as hexadecimal

Decimal point position
 0: No decimal point
 1: Lowest 1st digit
 2: Lowest 2nd digit
 3: Lowest 3rd digit
 4: Lowest 4th digit
 5: Lowest 5th digit

14) Program data read

Used to read the program data.

Command Data No. Data No.
68 **00** ~ **3F**

Reply

| | | | | | | | |
|--|--|--|--|--|--|--|--|
| | | | | | | | |
|--|--|--|--|--|--|--|--|

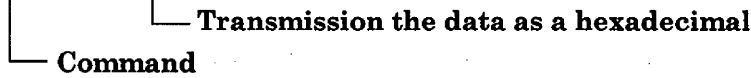

15) General-purpose register read (Rx)

Used to read the general-purpose register (Rx).

Command Data No. Data No.
6D **01** ~ **02**

Reply

| | | | | | | | |
|--|--|--|--|--|--|--|--|
| | | | | | | | |
|--|--|--|--|--|--|--|--|

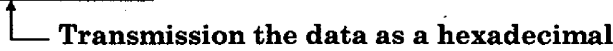

16) General-purpose register read (Dx)

Used to read the general-purpose register (Dx).

Command Data No. Data No.
6E **01** ~ **02**

Reply

| | | | | | | | |
|--|--|--|--|--|--|--|--|
| | | | | | | | |
|--|--|--|--|--|--|--|--|

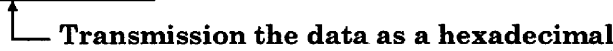

17) Status display data clear

The cumulated status display feedback pulse and cumulated command pulse data is cleared.

Command Data No.
81 **00**

Transmission data

| | | | |
|---|---|---|---|
| 1 | E | A | 5 |
|---|---|---|---|

18) Current alarm reset

The servo amplifier alarm is reset in the same manner as when the terminal RES is input.

Command Data No.
82 **00**

Transmission data

| | | | |
|---|---|---|---|
| 1 | E | A | 5 |
|---|---|---|---|

19) Alarm history clear

The alarm history is cleared.

Command Data No.
82 **20**

Transmission data

| | | | |
|---|---|---|---|
| 1 | E | A | 5 |
|---|---|---|---|

20) Parameter write

Used to write the parameter setting value in the servo amplifier.
Do not write a value exceeding the setting range.

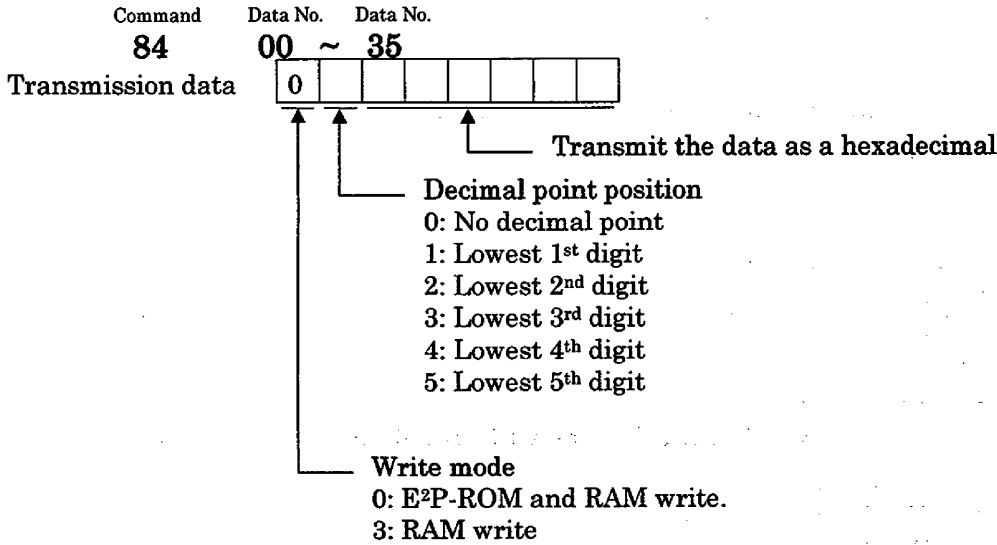

If the parameters are changed many times with the communication, it must be set "3" and changing the parameters to only RAM data. Otherwise, E²P-ROM error occurrence.

21) Communication-on input device

The signals can be turned ON / OFF forcible.
It will be "OR logic" with the external input signal.

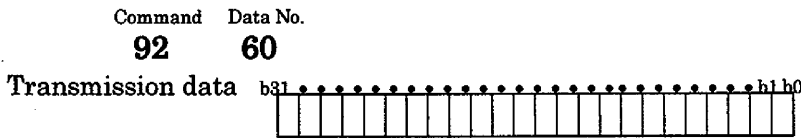

Command for each bit is sent to the slave in hexadecimal.

0 : OFF 1 : ON

| bit | Signals |
|-----|---------------------------------------|
| 0 | Servo on (SON) |
| 1 | Forward stroke end (LSP) |
| 2 | Reverse stroke end (LSN) |
| 3 | External torque limit selection (TL) |
| 4 | Internal torque limit selection (TL2) |
| 5 | Proportional control (PC) |
| 6 | Rest (RES) |
| 7 | |
| 8 | |
| 9 | |

| bit | Signals |
|-----|-------------------------------|
| 10 | |
| 11 | Forward start (ST1) |
| 12 | Reverse start (ST2) |
| 13 | |
| 14 | |
| 15 | |
| 16 | Emergency stop (EMG) |
| 17 | Automatic/Manual (MDO) |
| 18 | Proximity (DOG) |
| 19 | Program No. selection 1 (PS0) |

| bit | Signals |
|-----|--|
| 20 | Program No. selection 2 (PS1) |
| 21 | Program No. selection 3 (PS2) |
| 22 | |
| 23 | Override selection (OVR) |
| 24 | Temporary stop/Restart (STP) |
| 25 | Manual pulse generator multiplier 1(TP0) |
| 26 | Manual pulse generator multiplier 2(TP1) |
| 27 | Program input 1 (PI1) |
| 28 | Program input 2 (PI2) |
| 29 | Program input 3 (PI3) |

22) Program data write

Used to write the program data.

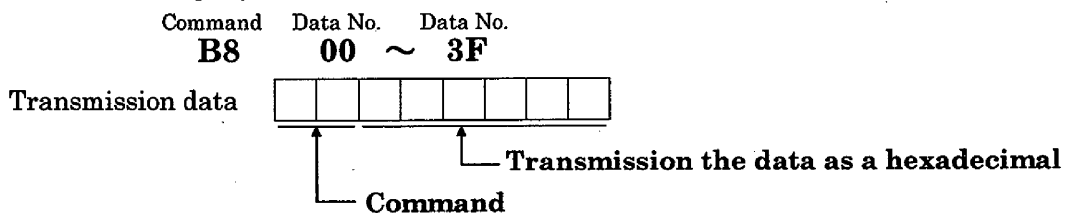

23) General-purpose register write (Rx)

Used to write the general-purpose register (Rx) setting to the servo amplifier.

The value written should not exceed the permissible setting range of the command argument with which the general-purpose register is used.

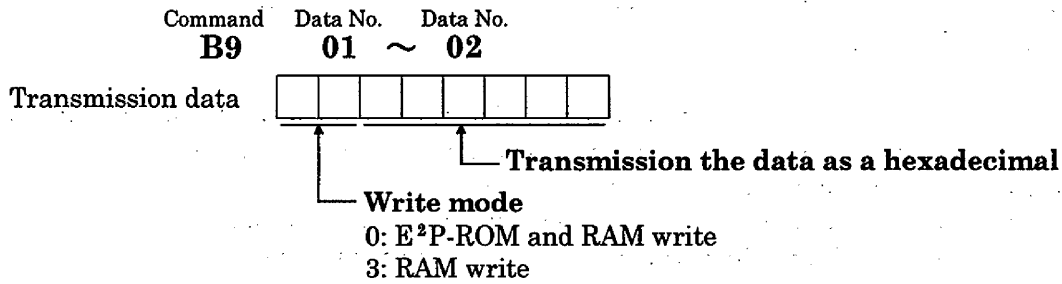

When the general-purpose register (Rx) value is changed frequently through communication, set this value to "3" and change only the data on RAM. Frequent changing of the E²P-ROM value will result in an E²P-ROM fault due to excess of the E²P-ROM write times.

24) General-purpose register write (Dx)

Used to write the general-purpose register (Dx) setting to the servo amplifier.

The value written should not exceed the permissible setting range of the command argument with which the general-purpose register is used.

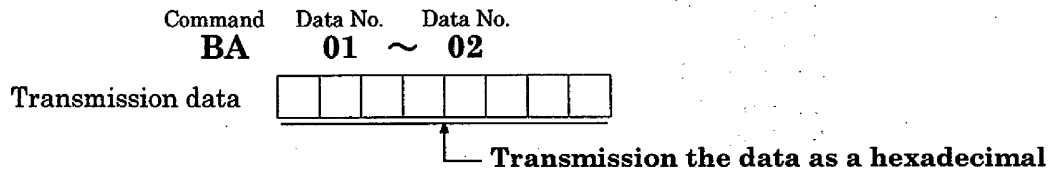

(10) Group refer command

Set to the group for "n"-axis, the same command can be transferred to the set group.

- Set to the group for the servo amplifiers which is started at same time.
- Set to the response command permission for the group setting a servo amplifier.
- Communicated to the group.

Note) - The group setting and the response command permission must be set with RS485 communication.

- The response command permission must be the group setting a servo amplifier.
If set to more than 1 servo amplifier, an error is occurred.
- When refer to "*" at the station number, all connecting amplifiers are valid.
In this case, the responsible amplifier will be set "0" at the station number.

1) Group reference setting

Used to the group reference setting write to the amplifier.

Command Data No.

1F **00**

Replay

| | | | |
|---|--|---|--|
| 0 | | 0 | |
|---|--|---|--|

Refer to group

0: Group refers is invalid

1 : Group "a"

2 : Group "b"

3 : Group "c"

4 : Group "d"

5 : Group "e"

6 : Group "f"

Response command permission

0 : Response prohibition

1 : Response permission

2) Group reference read

Used to the group reference setting read to the amplifier.

Command Data No.

9F **00**

Transmission data

| | | | |
|---|--|---|--|
| 0 | | 0 | |
|---|--|---|--|

Refer to group

0: Group refers is invalid

1 : Group "a"

2 : Group "b"

3 : Group "c"

4 : Group "d"

5 : Group "e"

6 : Group "f"

Response command permission

0 : Response prohibition

1 : Response permission

13. Troubleshooting

(1) Alarm and warning list

| | Alarm No. | Alarm / Warning | Reset |
|---------|-----------------|-------------------------------------|-------|
| Alarm | A. 10 | Undervoltage | TR C |
| | A. 11 | Board error 1 | P |
| | A.12 | Memory error 1 | P |
| | A. 13 | Clock error | P |
| | A. 15 | Memory error 2 | P |
| | A. 16 | Encoder error 1 | P |
| | A. 17 | Board error 2 | P |
| | A. 18 | Board error 3 | P |
| | A. 20 | Encoder error 2 | P |
| | A. 24 | Motor output ground fault | TR C |
| | A. 25 | Absolute position erase | P |
| | A. 30 | Regenerative error | TR C |
| | A. 31 | Over speed | TR C |
| | A. 32 | Over current | TR C |
| | A. 33 | Over voltage | TR C |
| | A. 35 | Command pulse error | TR C |
| | A. 37 | Parameter error | C |
| | A. 39 | Program error | P |
| | A. 46 | Servo motor overheat | TR C |
| | A. 50 | Overload 1 | TR C |
| | A. 51 | Overload 2 | TR C |
| | A. 52 | Error excessive | TR C |
| | A. 63 | Zero return incomplete | TR C |
| | A. 64 | Zero setting error | TR C |
| | A. 8A | Communication time-out error | P |
| | A. 8E | RS485 (232C) communication error | TR C |
| | A. 92 | Open battery cable warning | P |
| | A. 98 | Software limit warning | P |
| A. 9F | Battery warning | P | |
| Warning | A. E0 | Excessive regenerative load warning | --- |
| | A. E1 | Overload warning | --- |
| | A. E3 | Absolute position counter warning | --- |
| | A. E6 | Servo emergency stop | --- |
| | A. E9 | Main circuit off warning | --- |
| | 8888 | Watchdog | P |

TR : Reset by reset signal C : Reset by controller P : Reset by power supply off-on is necessary

Note) When any of the following alarms has occurred, always remove its cause and allow about 30minits for cooling before resuming operation. If operation is repeated by switching control circuit power off, then on to reset the alarm, the servo amplifier, servo motor and regenerative brake option may become faulty.

- Regenerative error (A. 30)
- Overload 1 (A. 50)
- Overload 2 (A. 51)

(2) Detail of alarms and warnings are same as the standard MR-J2-C series specification.

REVISIONS

*The manual number is given on the bottom right of the front cover.

| Print Data | *Manual Number | Revision | |
|------------|----------------|---------------|--|
| | SH(NA)3197-A | First edition | |
| July, 1999 | SH(NA)3197-B | 5 (2) 7) | Addition of indirect addressing |
| | | 10 (1) | Addition of parameter No. 57 *SYC Selected to program input polarity |
| | | 10 (2) | Addition of parameter No. 57 *SYC Selected to program input polarity |
| | | 11 (13) | Addition of how to call the general-purpose register write screen |
| | | 12 (8) 1) | Addition of commands 68, 69, 6A, 6D, 6E |
| | | 12 (8) 2) | Addition of commands B8, B9, BA |
| | | 12 (9) 14) | Addition of program data read |
| | | 12 (9) 15) | Addition of general-purpose register read (Rx) |
| | | 12 (9) 16) | Addition of general-purpose register read (Dx) |
| | | 12 (9) 22) | Addition of program data write |
| | | 12 (9) 23) | Addition of general-purpose register write (Rx) |
| | | 12 (9) 24) | Addition of general-purpose register write (Dx) |