



Motion Controller

MELSEC **Q** series

Q173HCPU/Q172HCPU
Motion Controller (SV22)
Programming Manual (VIRTUAL MODE)

-Q172HCPU
-Q173HCPU

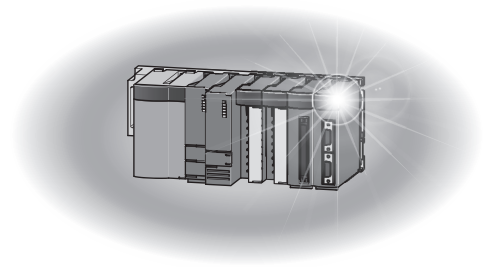

● SAFETY PRECAUTIONS ●

(Read these precautions before using.)

When using this equipment, thoroughly read this manual and the associated manuals introduced in this manual. Also pay careful attention to safety and handle the module properly.

These precautions apply only to this equipment. Refer to the Q173HCPU/Q172HCPU Users manual for a description of the Motion controller safety precautions.

These SAFETY PRECAUTIONS classify the safety precautions into two categories: "DANGER" and "CAUTION".



Indicates that incorrect handling may cause hazardous conditions, resulting in death or severe injury.



Indicates that incorrect handling may cause hazardous conditions, resulting in medium or slight personal injury or physical damage.

Depending on circumstances, procedures indicated by  CAUTION may also be linked to serious results.

In any case, it is important to follow the directions for usage.

Store this manual in a safe place so that you can take it out and read it whenever necessary. Always forward it to the end user.

For Safe Operations

1. Prevention of electric shocks

DANGER

- Never open the front case or terminal covers while the power is ON or the unit is running, as this may lead to electric shocks.
- Never run the unit with the front case or terminal cover removed. The high voltage terminal and charged sections will be exposed and may lead to electric shocks.
- Never open the front case or terminal cover at times other than wiring work or periodic inspections even if the power is OFF. The insides of the Motion controller and servo amplifier are charged and may lead to electric shocks.
- When performing wiring work or inspections, turn the power OFF, wait at least ten minutes, and then check the voltage with a tester, etc.. Failing to do so may lead to electric shocks.
- Be sure to ground the Motion controller, servo amplifier and servomotor. (Ground resistance : 100 Ω or less) Do not ground commonly with other devices.
- The wiring work and inspections must be done by a qualified technician.
- Wire the units after installing the Motion controller, servo amplifier and servomotor. Failing to do so may lead to electric shocks or damage.
- Never operate the switches with wet hands, as this may lead to electric shocks.
- Do not damage, apply excessive stress, place heavy things on or sandwich the cables, as this may lead to electric shocks.
- Do not touch the Motion controller, servo amplifier or servomotor terminal blocks while the power is ON, as this may lead to electric shocks.
- Do not touch the built-in power supply, built-in grounding or signal wires of the Motion controller and servo amplifier, as this may lead to electric shocks.

2. For fire prevention

CAUTION

- Install the Motion controller, servo amplifier, servomotor and regenerative resistor on inflammable material. Direct installation on flammable material or near flammable material may lead to fire.
- If a fault occurs in the Motion controller or servo amplifier, shut the power OFF at the servo amplifier's power source. If a large current continues to flow, fire may occur.
- When using a regenerative resistor, shut the power OFF with an error signal. The regenerative resistor may abnormally overheat due to a fault in the regenerative transistor, etc., and may lead to fire.
- Always take heat measures such as flame proofing for the inside of the control panel where the servo amplifier or regenerative resistor is installed and for the wires used. Failing to do so may lead to fire.

3. For injury prevention

CAUTION

- Do not apply a voltage other than that specified in the instruction manual on any terminal. Doing so may lead to destruction or damage.
- Do not mistake the terminal connections, as this may lead to destruction or damage.
- Do not mistake the polarity (+ / -), as this may lead to destruction or damage.
- Do not touch the servo amplifier's heat radiating fins, regenerative resistor and servomotor, etc., while the power is ON and for a short time after the power is turned OFF. In this timing, these parts become very hot and may lead to burns.
- Always turn the power OFF before touching the servomotor shaft or coupled machines, as these parts may lead to injuries.
- Do not go near the machine during test operations or during operations such as teaching. Doing so may lead to injuries.

4. Various precautions

Strictly observe the following precautions.

Mistaken handling of the unit may lead to faults, injuries or electric shocks.

(1) System structure

CAUTION

- Always install a leakage breaker on the Motion controller and servo amplifier power source.
- If installation of an electromagnetic contactor for power shut off during an error, etc., is specified in the instruction manual for the servo amplifier, etc., always install the electromagnetic contactor.
- Install the emergency stop circuit externally so that the operation can be stopped immediately and the power shut off.
- Use the Motion controller, servo amplifier, servomotor and regenerative resistor with the combinations listed in the instruction manual. Other combinations may lead to fire or faults.
- If safety standards (ex., robot safety rules, etc.,) apply to the system using the Motion controller, servo amplifier and servomotor, make sure that the safety standards are satisfied.
- Construct a safety circuit externally of the Motion controller or servo amplifier if the abnormal operation of the Motion controller or servo amplifier differ from the safety directive operation in the system.
- In systems where coasting of the servomotor will be a problem during the forced stop, emergency stop, servo OFF or power supply OFF, use dynamic brakes.
- Make sure that the system considers the coasting amount even when using dynamic brakes.
- In systems where perpendicular shaft dropping may be a problem during the forced stop, emergency stop, servo OFF or power supply OFF, use both dynamic brakes and electromagnetic brakes.
- The dynamic brakes must be used only on errors that cause the forced stop, emergency stop, or servo OFF. These brakes must not be used for normal braking.

 CAUTION

- The brakes (electromagnetic brakes) assembled into the servomotor are for holding applications, and must not be used for normal braking.
- The system must have a mechanical allowance so that the machine itself can stop even if the stroke limits switch is passed through at the max. speed.
- Use wires and cables that have a wire diameter, heat resistance and bending resistance compatible with the system.
- Use wires and cables within the length of the range described in the instruction manual.
- The ratings and characteristics of the parts (other than Motion controller, servo amplifier and servomotor) used in a system must be compatible with the Motion controller, servo amplifier and servomotor.
- Install a cover on the shaft so that the rotary parts of the servomotor are not touched during operation.
- There may be some cases where holding by the electromagnetic brakes is not possible due to the life or mechanical structure (when the ball screw and servomotor are connected with a timing belt, etc.). Install a stopping device to ensure safety on the machine side.

(2) Parameter settings and programming

 CAUTION

- Set the parameter values to those that are compatible with the Motion controller, servo amplifier, servomotor and regenerative resistor model and the system application. The protective functions may not function if the settings are incorrect.
- The regenerative resistor model and capacity parameters must be set to values that conform to the operation mode, servo amplifier and servo power supply module. The protective functions may not function if the settings are incorrect.
- Set the mechanical brake output and dynamic brake output validity parameters to values that are compatible with the system application. The protective functions may not function if the settings are incorrect.
- Set the stroke limit input validity parameter to a value that is compatible with the system application. The protective functions may not function if the setting is incorrect.
- Set the servomotor encoder type (increment, absolute position type, etc.) parameter to a value that is compatible with the system application. The protective functions may not function if the setting is incorrect.
- Set the servomotor capacity and type (standard, low-inertia, flat, etc.) parameter to values that are compatible with the system application. The protective functions may not function if the settings are incorrect.
- Set the servo amplifier capacity and type parameters to values that are compatible with the system application. The protective functions may not function if the settings are incorrect.
- Use the program commands for the program with the conditions specified in the instruction manual.

 **CAUTION**

- Set the sequence function program capacity setting, device capacity, latch validity range, I/O assignment setting, and validity of continuous operation during error detection to values that are compatible with the system application. The protective functions may not function if the settings are incorrect.
- Some devices used in the program have fixed applications, so use these with the conditions specified in the instruction manual.
- The input devices and data registers assigned to the link will hold the data previous to when communication is terminated by an error, etc. Thus, an error correspondence interlock program specified in the instruction manual must be used.
- Use the interlock program specified in the special function module's instruction manual for the program corresponding to the special function module.

(3) Transportation and installation

 **CAUTION**

- Transport the product with the correct method according to the mass.
- Use the servomotor suspension bolts only for the transportation of the servomotor. Do not transport the servomotor with machine installed on it.
- Do not stack products past the limit.
- When transporting the Motion controller or servo amplifier, never hold the connected wires or cables.
- When transporting the servomotor, never hold the cables, shaft or detector.
- When transporting the Motion controller or servo amplifier, never hold the front case as it may fall off.
- When transporting, installing or removing the Motion controller or servo amplifier, never hold the edges.
- Install the unit according to the instruction manual in a place where the mass can be withstood.
- Do not get on or place heavy objects on the product.
- Always observe the installation direction.
- Keep the designated clearance between the Motion controller or servo amplifier and control panel inner surface or the Motion controller and servo amplifier, Motion controller or servo amplifier and other devices.
- Do not install or operate Motion controller, servo amplifiers or servomotors that are damaged or that have missing parts.
- Do not block the intake/outtake ports of the servomotor with cooling fan.
- Do not allow conductive matter such as screw or cutting chips or combustible matter such as oil enter the Motion controller, servo amplifier or servomotor.
- The Motion controller, servo amplifier and servomotor are precision machines, so do not drop or apply strong impacts on them.

 **CAUTION**

- Securely fix the Motion controller and servo amplifier to the machine according to the instruction manual. If the fixing is insufficient, these may come off during operation.
- Always install the servomotor with reduction gears in the designated direction. Failing to do so may lead to oil leaks.
- Store and use the unit in the following environmental conditions.

Environment	Conditions	
	Motion controller/Servo amplifier	Servomotor
Ambient temperature	According to each instruction manual.	0°C to +40°C (With no freezing) (32°F to +104°F)
Ambient humidity	According to each instruction manual.	80% RH or less (With no dew condensation)
Storage temperature	According to each instruction manual.	-20°C to +65°C (-4°F to +149°F)
Atmosphere	Indoors (where not subject to direct sunlight). No corrosive gases, flammable gases, oil mist or dust must exist	
Altitude	1000m (3280.84ft.) or less above sea level	
Vibration	According to each instruction manual	

- When coupling with the synchronization encoder or servomotor shaft end, do not apply impact such as by hitting with a hammer. Doing so may lead to detector damage.
- Do not apply a load larger than the tolerable load onto the servomotor shaft. Doing so may lead to shaft breakage.
- When not using the module for a long time, disconnect the power line from the Motion controller or servo amplifier.
- Place the Motion controller and servo amplifier in static electricity preventing vinyl bags and store.
- When storing for a long time, please contact with our sales representative.

(4) Wiring

⚠ CAUTION

- Correctly and securely wire the wires. Reconfirm the connections for mistakes and the terminal screws for tightness after wiring. Failing to do so may lead to run away of the servomotor.
- After wiring, install the protective covers such as the terminal covers to the original positions.
- Do not install a phase advancing capacitor, surge absorber or radio noise filter (option FR-BIF) on the output side of the servo amplifier.
- Correctly connect the output side (terminals U, V, W). Incorrect connections will lead the servomotor to operate abnormally.
- Do not connect a commercial power supply to the servomotor, as this may lead to trouble.
- Do not mistake the direction of the surge absorbing diode installed on the DC relay for the control signal output of brake signals, etc. Incorrect installation may lead to signals not being output when trouble occurs or the protective functions not functioning.
- Do not connect or disconnect the connection cables between each unit, the encoder cable or PLC expansion cable while the power is ON.
- Securely tighten the cable connector fixing screws and fixing mechanisms. Insufficient fixing may lead to the cables combing off during operation.
- Do not bundle the power line or cables.

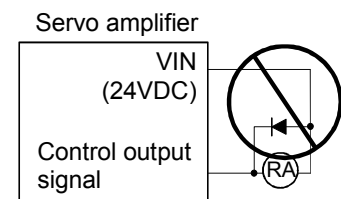

(5) Trial operation and adjustment

⚠ CAUTION

- Confirm and adjust the program and each parameter before operation. Unpredictable movements may occur depending on the machine.
- Extreme adjustments and changes may lead to unstable operation, so never make them.
- When using the absolute position system function, on starting up, and when the Motion controller or absolute value motor has been replaced, always perform a home position return.

(6) Usage methods

⚠ CAUTION

- Immediately turn OFF the power if smoke, abnormal sounds or odors are emitted from the Motion controller, servo amplifier or servomotor.
- Always execute a test operation before starting actual operations after the program or parameters have been changed or after maintenance and inspection.
- The units must be disassembled and repaired by a qualified technician.
- Do not make any modifications to the unit.
- Keep the effect or electromagnetic obstacles to a minimum by installing a noise filter or by using wire shields, etc. Electromagnetic obstacles may affect the electronic devices used near the Motion controller or servo amplifier.
- When using the CE Mark-compliant equipment, refer to the "EMC Installation Guidelines" (data number IB(NA)-67339) for the Motion controllers and refer to the corresponding EMC guideline information for the servo amplifiers, inverters and other equipment.
- Use the units with the following conditions.

Item	Conditions					
	Q61P-A1	Q61P-A2	Q61P	Q62P	Q63P	Q64P
Input power	100 to 120VAC ^{+10%} _{-15%} (85 to 132VAC)	200 to 240VAC ^{+10%} _{-15%} (170 to 264VAC)	100 to 240VAC ^{+10%} _{-15%} (85 to 264VAC)		24VDC ^{+30%} _{-35%} (15.6 to 31.2VDC)	100 to 120VAC ^{+10%} _{-15%} / 200 to 240VAC ^{+10%} _{-15%} (85 to 132VAC/ 170 to 264VAC)
Input frequency	50/60Hz ±5%					
Tolerable momentary power failure	20ms or less					

(7) Corrective actions for errors

⚠ CAUTION

- If an error occurs in the self diagnosis of the Motion controller or servo amplifier, confirm the check details according to the instruction manual, and restore the operation.
- If a dangerous state is predicted in case of a power failure or product failure, use a servomotor with electromagnetic brakes or install a brake mechanism externally.
- Use a double circuit construction so that the electromagnetic brake operation circuit can be operated by emergency stop signals set externally.

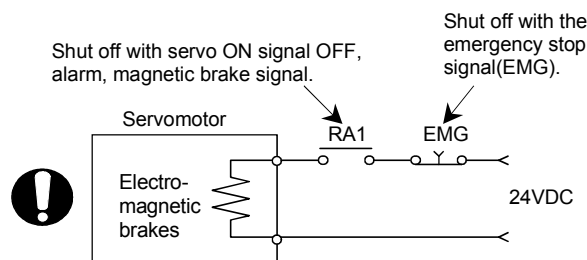

 **CAUTION**

- If an error occurs, remove the cause, secure the safety and then resume operation after alarm release.
- The unit may suddenly resume operation after a power failure is restored, so do not go near the machine. (Design the machine so that personal safety can be ensured even if the machine restarts suddenly.)

(8) Maintenance, inspection and part replacement

 **CAUTION**

- Perform the daily and periodic inspections according to the instruction manual.
- Perform maintenance and inspection after backing up the program and parameters for the Motion controller and servo amplifier.
- Do not place fingers or hands in the clearance when opening or closing any opening.
- Periodically replace consumable parts such as batteries according to the instruction manual.
- Do not touch the lead sections such as ICs or the connector contacts.
- Do not place the Motion controller or servo amplifier on metal that may cause a power leakage or wood, plastic or vinyl that may cause static electricity buildup.
- Do not perform a megger test (insulation resistance measurement) during inspection.
- When replacing the Motion controller or servo amplifier, always set the new module settings correctly.
- When the Motion controller or absolute value motor has been replaced, carry out a home position return operation using one of the following methods, otherwise position displacement could occur.
 - 1) After writing the servo data to the Motion controller using programming software, switch on the power again, then perform a home position return operation.
 - 2) Using the backup function of the programming software, load the data backed up before replacement.
- After maintenance and inspections are completed, confirm that the position detection of the absolute position detector function is correct.
- Do not short circuit, charge, overheat, incinerate or disassemble the batteries.
- The electrolytic capacitor will generate gas during a fault, so do not place your face near the Motion controller or servo amplifier.
- The electrolytic capacitor and fan will deteriorate. Periodically replace these to prevent secondary damage from faults. Replacements can be made by our sales representative.

(9) About processing of waste

When you discard Motion controller, servo amplifier, a battery (primary battery) and other option articles, please follow the law of each country (area).

CAUTION

- This product is not designed or manufactured to be used in equipment or systems in situations that can affect or endanger human life.
- When considering this product for operation in special applications such as machinery or systems used in passenger transportation, medical, aerospace, atomic power, electric power, or submarine repeating applications, please contact your nearest Mitsubishi sales representative.
- Although this product was manufactured under conditions of strict quality control, you are strongly advised to install safety devices to forestall serious accidents when it is used in facilities where a breakdown in the product is likely to cause a serious accident.

(10) General cautions

CAUTION

- All drawings provided in the instruction manual show the state with the covers and safety partitions removed to explain detailed sections. When operating the product, always return the covers and partitions to the designated positions, and operate according to the instruction manual.

REVISIONS

* The manual number is given on the bottom left of the back cover.

Print Date	* Manual Number	Revision
Jun., 2005	IB(NA)-0300114-A	First edition
Sep., 2006	IB(NA)-0300114-B	[Additional model] Q61P, MR-J3-□B(Large capacity), MR-J3-□B-RJ006 [Additional function] Control loop changing command, Control loop monitor status [Additional correction/partial correction] About Manuals, Device lists, Error codes, etc.

Japanese Manual Number IB(NA)-0300094

This manual confers no industrial property rights or any rights of any other kind, nor does it confer any patent licenses. Mitsubishi Electric Corporation cannot be held responsible for any problems involving industrial property rights which may occur as a result of using the contents noted in this manual.

INTRODUCTION

Thank you for choosing the Q173HCPU/Q172HCPU Motion Controller.
Please read this manual carefully so that equipment is used to its optimum.

CONTENTS

Safety Precautions	A- 1
Revisions	A-11
Contents	A-12
About Manuals	A-15
1. OVERVIEW	1- 1 to 1- 4
1.1 Overview	1- 1
1.2 Motion Control in SV13/SV22 Real Mode	1- 3
1.3 Motion Control in SV22 Virtual Mode	1- 4
2. STARTING UP THE MULTIPLE CPU SYSTEM	2- 1 to 2- 8
2.1 Starting Up the System	2- 1
2.2 Differences Between Incremental System and Absolute System	2- 3
2.2.1 Operation for incremental system	2- 3
2.2.2 Operation for absolute (absolute position) system	2- 4
2.3 Differences Between Real Mode and Virtual Mode	2- 5
2.3.1 Positioning data	2- 5
2.3.2 Positioning devices	2- 5
2.3.3 Servo programs	2- 6
2.3.4 Control change (Current value change/speed change)	2- 7
3. PERFORMANCE SPECIFICATIONS	3- 1 to 3- 2
4. POSITIONING DEDICATED SIGNALS	4- 1 to 4-92
4.1 Internal Relays	4- 2
4.1.1 Axis statuses	4-17
4.1.2 Axis command signals	4-24
4.1.3 Virtual servomotor axis statuses	4-28
4.1.4 Virtual servomotor axis command signals	4-33
4.1.5 Synchronous encoder axis statuses	4-38
4.1.6 Synchronous encoder axis command signals	4-40
4.1.7 Cam axis command signals	4-41
4.1.8 Smoothing clutch complete signals	4-42
4.1.9 Common devices	4-44
4.2 Data Registers	4-59
4.2.1 Axis monitor devices	4-67
4.2.2 Control change registers	4-69
4.2.3 Virtual servomotor axis monitor devices	4-70

4.2.4 Current value after virtual servomotor axis main shaft's differential gear	4-72
4.2.5 Synchronous encoder axis monitor devices.....	4-74
4.2.6 Current value after synchronous encoder axis main shaft's differential gear	4-75
4.2.7 Cam axis monitor devices.....	4-77
4.2.8 Common devices	4-78
4.3 Motion registers(#)	4-82
4.4 Special relays (SP.M)	4-83
4.5 Special registers (SP.D).....	4-85

5. MECHANICAL SYSTEM PROGRAM	5- 1 to 5- 6
-------------------------------------	---------------------

5.1 Mechanical Module Connection Diagram	5- 2
5.2 Mechanical Module List	5- 5

6. DRIVE MODULE	6- 1 to 6-26
------------------------	---------------------

6.1 Virtual Servomotor	6- 1
6.1.1 Operation description	6- 1
6.1.2 Parameter list	6-11
6.1.3 Virtual servomotor axis devices (Internal relays, data registers).....	6-16
6.2 Synchronous Encoder.....	6-17
6.2.1 Operation description	6-17
6.2.2 Parameter list	6-21
6.2.3 Synchronous encoder axis devices (Internal relays, data registers).....	6-22
6.3 Virtual Servomotor/Synchronous Encoder Control Change.....	6-23
6.3.1 Virtual servomotor control change.....	6-23
6.3.2 Synchronous encoder control change.....	6-25

7. TRANSMISSION MODULE	7- 1 to 7-38
-------------------------------	---------------------

7.1 Gear.....	7- 3
7.1.1 Operation	7- 3
7.1.2 Parameters	7- 3
7.2 Clutch.....	7- 5
7.2.1 Operation	7-11
7.2.2 Parameters	7-28
7.3 Speed Change Gear	7-34
7.3.1 Operation	7-34
7.3.2 Parameters	7-35
7.4 Differential Gear	7-37
7.4.1 Operation	7-37
7.4.2 Parameters (Must be not set)	7-37

8. OUTPUT MODULE	8- 1 to 8-38
-------------------------	---------------------

8.1 Rollers.....	8- 4
8.1.1 Operation	8- 4
8.1.2 Parameter list	8- 5
8.2 Ball Screw.....	8- 8
8.2.1 Operation	8- 8

8.2.2 Parameter list	8- 9
8.3 Rotary Tables	8-12
8.3.1 Operation	8-12
8.3.2 Parameter list	8-13
8.4 Cam	8-20
8.4.1 Operation	8-21
8.4.2 Settings items at cam data creating	8-24
8.4.3 Parameter list	8-27
8.4.4 Cam curve list.....	8-35
8.5 Phase Compensation Function	8-36

9. REAL/VIRTUAL MODE SWITCHING AND STOP/RE-START	9- 1 to 9-12
---------------------------------------------------------	---------------------

9.1 Switching from the Real to Virtual Mode	9- 1
9.2 Switching from the Virtual to Real Mode	9- 5
9.2.1 Switching from the virtual to real mode by user side	9- 5
9.2.2 Switching from the virtual to real mode by operating system software	9- 5
9.2.3 Continuous operation on servo error in virtual mode	9- 6
9.3 Precautions at Real/Virtual Mode Switching	9- 7
9.4 Stop and re-start.....	9- 9
9.4.1 Stop operation/stop causes during operation and re-starting operation list.....	9-10

10. AUXILIARY AND APPLIED FUNCTIONS	10- 1 to 10- 8
--------------------------------------------	-----------------------

10.1 Mixed Function of Virtual Mode with Real Mode	10- 1
10.2 Cam/Ball Screw Switching Function.....	10- 7

APPENDICES	App- 1 to App-77
-------------------	-------------------------

APPENDIX 1 Cam Curves.....	App- 1
APPENDIX 2 Error Codes Stored Using The Motion CPU	App- 5
APPENDIX 2.1 Expression Method for Word Data Axis No.....	App- 8
APPENDIX 2.2 Related Systems and Error Processing.....	App- 9
APPENDIX 2.3 Servo program setting errors (Stored in D9190).....	App-10
APPENDIX 2.4 Drive module errors.....	App-14
APPENDIX 2.5 Servo errors.....	App-19
APPENDIX 2.6 PC link communication errors	App-38
APPENDIX 2.7 Output Module Errors	App-39
APPENDIX 2.8 Errors at Real/Virtual Mode Switching	App-45
APPENDIX 3 Special Relays/special registers	App-47
APPENDIX 3.1 Special relays	App-47
APPENDIX 3.2 Special registers	App-50
APPENDIX 4 Setting Range for Indirect Setting Devices.....	App-54
APPENDIX 5 Processing Times of the Motion CPU	App-56

About Manuals

The following manuals are related to this product.

Referring to this list, please request the necessary manuals.

Related Manuals

(1) Motion controller

Manual Name	Manual Number (Model Code)
<p>Q173HCPU/Q172HCPU Motion controller User's Manual</p> <p>This manual explains specifications of the Motion CPU modules, Q172LX Servo external signal interface module, Q172EX Serial absolute synchronous encoder interface module, Q173PX Manual pulse generator interface module, Teaching units, Power supply modules, Servo amplifiers, SSCNETⅢ cables, synchronous encoder cables and others.</p> <p>(Optional)</p>	IB-0300110 (1XB910)
<p>Q173HCPU/Q172HCPU Motion controller Programming Manual (COMMON)</p> <p>This manual explains the Multiple CPU system configuration, performance specifications, common parameters, auxiliary/applied functions and others.</p> <p>(Optional)</p>	IB-0300111 (1XB911)
<p>Q173HCPU/Q172HCPU Motion controller (SV13/SV22) Programming Manual (Motion SFC)</p> <p>This manual explains the functions, programming, debugging, error codes and others of the Motion SFC.</p> <p>(Optional)</p>	IB-0300112 (1XB912)
<p>Q173HCPU/Q172HCPU Motion controller (SV13/SV22) Programming Manual (REAL MODE)</p> <p>This manual explains the servo parameters, positioning instructions, device list, error list and others.</p> <p>(Optional)</p>	IB-0300113 (1XB913)
<p>Q173HCPU/Q172HCPU Motion controller (SV43) Programming Manual</p> <p>This manual describes the dedicated instructions to execute the positioning control by Motion program of EIA language (G-code).</p> <p>This manual explains the servo parameters, positioning instructions, device list, error list and others.</p> <p>(Optional)</p>	IB-0300115 (1XB915)

(2) PLC

Manual Name	Manual Number (Model Code)
QCPU User's Manual (Hardware Design, Maintenance and Inspection) This manual explains the specifications of the QCPU modules, power supply modules, base modules, extension cables, memory card battery and others. (Optional)	SH-080483ENG (13JR73)
QCPU User's Manual (Function Explanation, Program Fundamentals) This manual explains the functions, programming methods and devices and others to create programs with the QCPU. (Optional)	SH-080484ENG (13JR74)
QCPU User's Manual (Multiple CPU System) This manual explains the functions, programming methods and cautions and others to construct the Multiple CPU system with the QCPU. (Optional)	SH-080485ENG (13JR75)
QCPU (Q Mode)/QnACPU Programming Manual (Common Instructions) This manual explains how to use the sequence instructions, basic instructions, application instructions and micro computer program. (Optional)	SH-080039 (13JF58)
QCPU (Q Mode)/QnACPU Programming Manual (PID Control Instructions) This manual explains the dedicated instructions used to exercise PID control. (Optional)	SH-080040 (13JF59)
QCPU (Q Mode)/QnACPU Programming Manual (SFC) This manual explains the system configuration, performance specifications, functions, programming, debugging, error codes and others of MELSAP3. (Optional)	SH-080041 (13JF60)
I/O Module Type Building Block User's Manual This manual explains the specifications of the I/O modules, connector, connector/terminal block conversion modules and others. (Optional)	SH-080042 (13JL99)

(3) Servo amplifier

Manual Name	Manual Number (Model Code)
MR-J3-□B Servo amplifier Instruction Manual This manual explains the I/O signals, parts names, parameters, start-up procedure and others for MR-J3-□B Servo amplifier. (Optional)	SH-030051 (1CW202)
Fully Closed Loop Control MR-J3-□B-RJ006 Servo amplifier Instruction Manual This manual explains the I/O signals, parts names, parameters, start-up procedure and others for Fully Closed Loop Control MR-J3-□B-RJ006 Servo amplifier. (Optional)	SH-030056 (1CW304)

1. OVERVIEW

1.1 Overview

This programming manual describes the dedicated instructions, positioning control parameters and positioning dedicated devices for mechanical system program comprised of a virtual main shaft or mechanical module required to execute the synchronous control in the Motion controller (SV22 virtual mode).

The following positioning control is possible in the Motion controller (SV22 virtual mode).

Applicable CPU	Number of positioning control axes
Q173HCPU (32 axes)	Up to 32 axes
Q172HCPU (8 axes)	Up to 8 axes

In this manual, the following abbreviations are used.

Generic term/Abbreviation	Description
Q173HCPU/Q172HCPU or Motion CPU (module)	Q173HCPU/Q172HCPU/Q173HCPU-T/Q172HCPU-T Motion CPU module
Q172LX/Q172EX/Q173PX or Motion module	Q172LX Servo external signals interface module/ Q172EX-S2/-S3 Serial absolute synchronous encoder interface module ^(Note-1) / Q173PX(-S1) Manual pulse generator interface module
MR-J3-□B	Servo amplifier model MR-J3-□B
AMP or Servo amplifier	General name for "Servo amplifier model MR-J3-□B"
QCPU, PLC CPU or PLC CPU module	Qn(H)CPU
Multiple CPU system or Motion system	Abbreviation for "Multiple PLC system of the Q series"
CPU _n	Abbreviation for "CPU No.n (n= 1 to 4) of the CPU module for the Multiple CPU system"
Programming software package	General name for "MT Developer" and "GX Developer"
Operating system software	General name for "SW□RN-SV□Q□"
SV13	Operating system software for conveyor assembly use (Motion SFC) : SW6RN-SV13Q□
SV22	Operating system software for automatic machinery use (Motion SFC) : SW6RN-SV22Q□
MT Developer	Abbreviation for Integrated start-up support software package "MT Developer (Version 00K or later)"
GX Developer	Abbreviation for MELSEC PLC programming software package "GX Developer (Version 6 or later)"
Manual pulse generator or MR-HDP01	Abbreviation for "Manual pulse generator (MR-HDP01)"
Serial absolute synchronous encoder or Q170ENC	Abbreviation for "Serial absolute synchronous encoder (Q170ENC)"
SSCNET III ^(Note-2)	High speed synchronous network between Motion controller and servo amplifier
SSCNET ^(Note-2)	High speed serial communication between Motion controller and servo amplifier
Absolute position system	General name for "system using the servomotor and servo amplifier for absolute position"
Battery holder unit	Battery holder unit (Q170HBATC)

1 OVERVIEW

Generic term/Abbreviation	Description
External battery	General name for "Q170HBATC" and "Q6BAT"
A□0BD-PCF	A10BD-PCF/A30BD-PCF SSC I/F board
SSC I/F communication cable	Abbreviation for "Cable for SSC I/F board/card"
Intelligent function module	Abbreviation for "MELSECNET/H module/Ethernet module/CC-Link module/Serial communication module"

(Note-1) : Q172EX can be used in SV22.

(Note-2) : SSCNET: Servo System Controller NETwork

REMARK

For information about the each module, design method for program and parameter, refer to the following manuals relevant to each module.

Item	Reference Manual	
Motion CPU module/Motion unit	Q173HCPU/Q172HCPU User's Manual	
PLC CPU, peripheral devices for PLC program design, I/O modules and intelligent function module	Manual relevant to each module	
Operation method for MT Developer	Help of each software	
SV13/SV22	<ul style="list-style-type: none"> • Multiple CPU system configuration • Performance specification • Design method for common parameter • Auxiliary and applied functions (common) 	Q173HCPU/Q172HCPU Motion controller Programming Manual (COMMON)
	<ul style="list-style-type: none"> • Design method for Motion SFC program • Design method for Motion SFC parameter • Motion dedicated PLC instruction 	Q173HCPU/Q172HCPU Motion controller (SV13/SV22) Programming Manual (Motion SFC)
	<ul style="list-style-type: none"> • Design method for positioning control program in the real mode • Design method for positioning control parameter 	Q173HCPU/Q172HCPU Motion controller (SV13/SV22) Programming Manual (REAL MODE)

CAUTION

- When designing the system, provide external protective and safety circuits to ensure safety in the event of trouble with the Motion controller.
- There are electronic components which are susceptible to the effects of static electricity mounted on the printed circuit board. When handling printed circuit boards with bare hands you must ground your body or the work bench.
Do not touch current-carrying or electric parts of the equipment with bare hands.
- Make parameter settings within the ranges stated in this manual.
- Use the program instructions that are used in programs in accordance with the conditions stipulated in this manual.
- Some devices for use in programs have fixed applications: they must be used in accordance with the conditions stipulated in this manual.

1 OVERVIEW

1.2 Motion Control in SV13/SV22 Real Mode

- (1) System with servomotor is controlled directly using the servo program in (SV13/SV22) real mode.
- (2) Setting of the positioning parameter and creation of the servo program/Motion SFC program are required.
- (3) The procedure of positioning control is shown below:
 - 1) Motion SFC program is requested to start using the S(P). SFCS instruction of the PLC program.
(Motion SFC program can also be started automatically by parameter setting.)

↓

 - 2) Execute the positioning control using the specified Motion SFC program.
(Output to the servo amplifier)

↓

 - 3) The servomotor is controlled.

Program structure in SV13/SV22 real mode

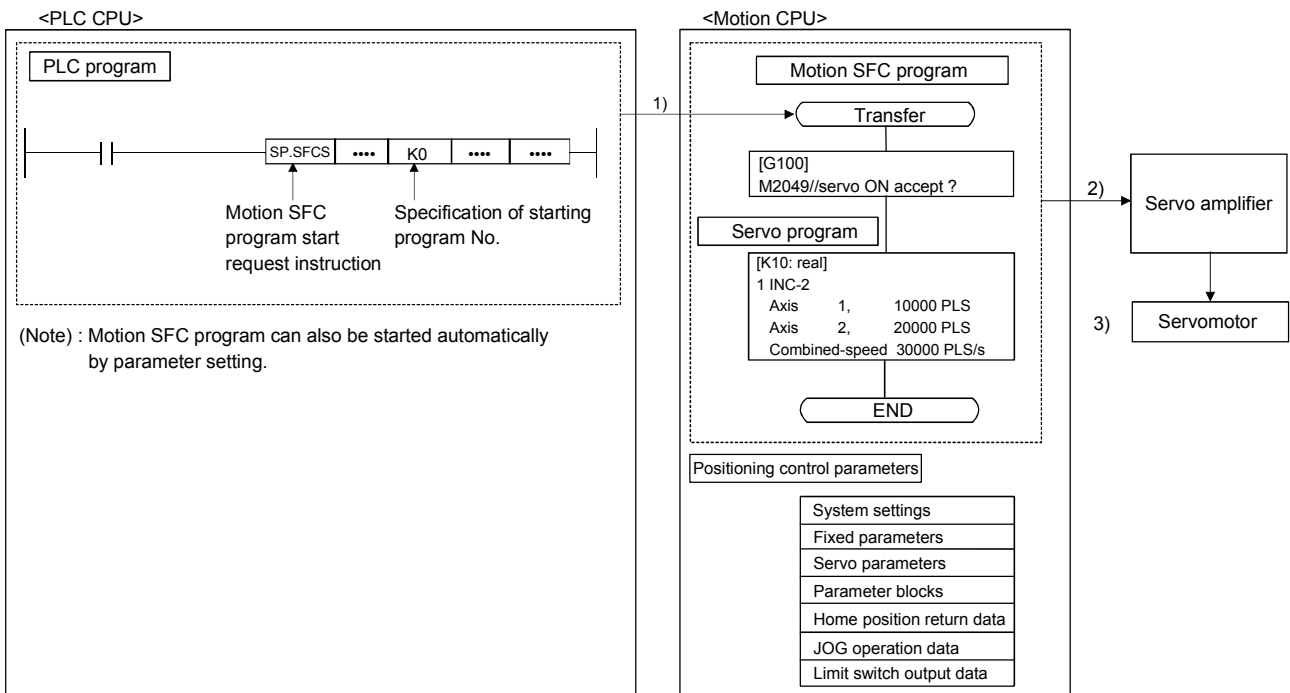

1 OVERVIEW

1.3 Motion Control in SV22 Virtual Mode

- (1) Synchronous control with software is performed using the mechanical system program comprised by virtual main shaft and mechanical module in (SV22) virtual mode.
- (2) Mechanical system programs is required in addition to the positioning parameter, servo program/Motion SFC program used in real mode.
- (3) The procedure of positioning control in virtual model is shown below:
 - 1) Motion SFC program for virtual mode is requested to start using the S(P). SFCS instruction of the PLC program.
(Motion SFC program can also be started automatically by parameter setting.)
- ↓
- 2) The virtual servomotor of the mechanical system program is started.
- ↓
- 3) Output the operation result obtained through the transmission module to the servo amplifier set as the output module.
- ↓
- 4) The servomotor is controlled.

Program structure in SV22 virtual mode

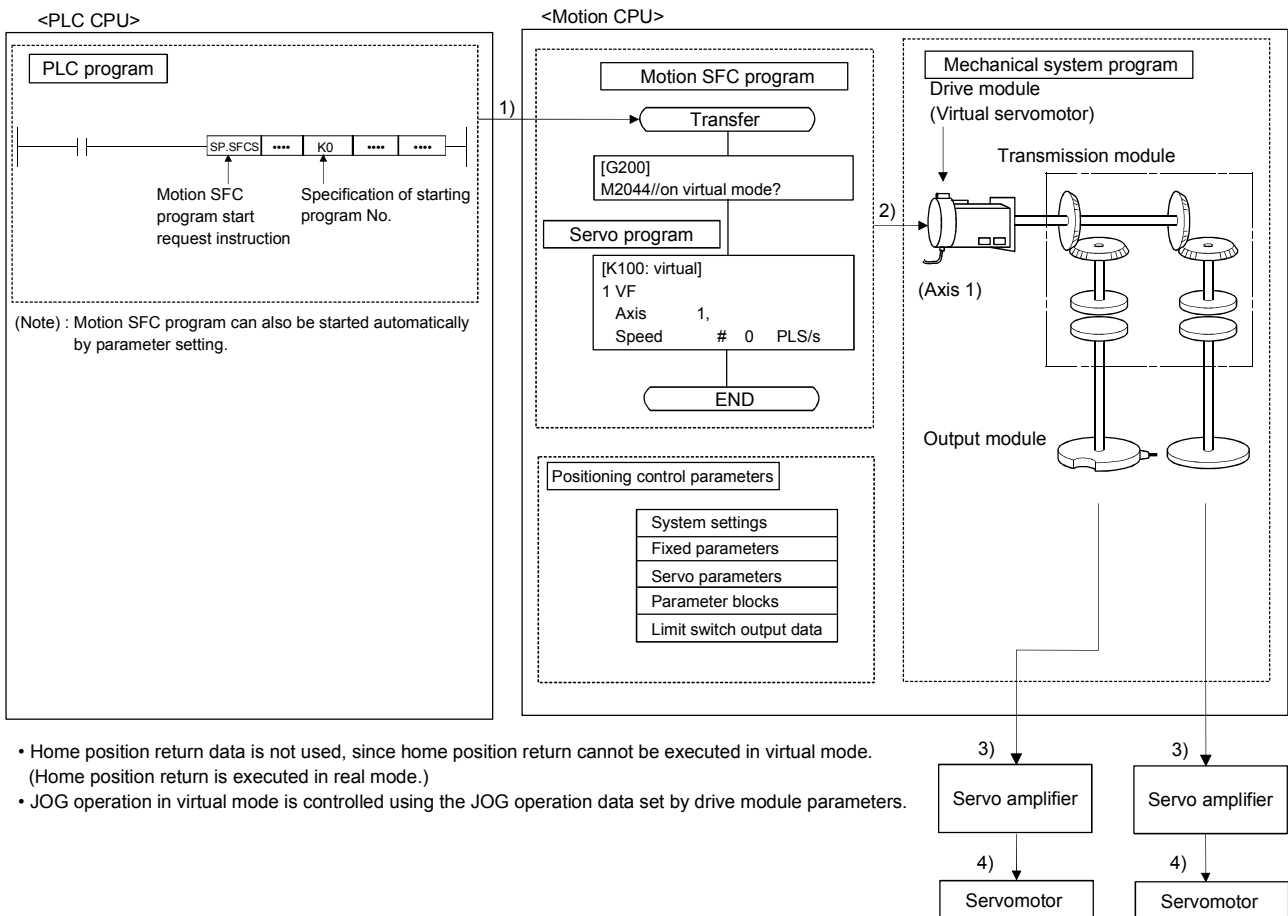

- Home position return data is not used, since home position return cannot be executed in virtual mode. (Home position return is executed in real mode.)
- JOG operation in virtual mode is controlled using the JOG operation data set by drive module parameters.

2. STARTING UP THE MULTIPLE CPU SYSTEM

The procedure for virtual mode positioning control is shown below.

2.1 Starting Up the System

The procedure to start up for virtual mode system is shown below.

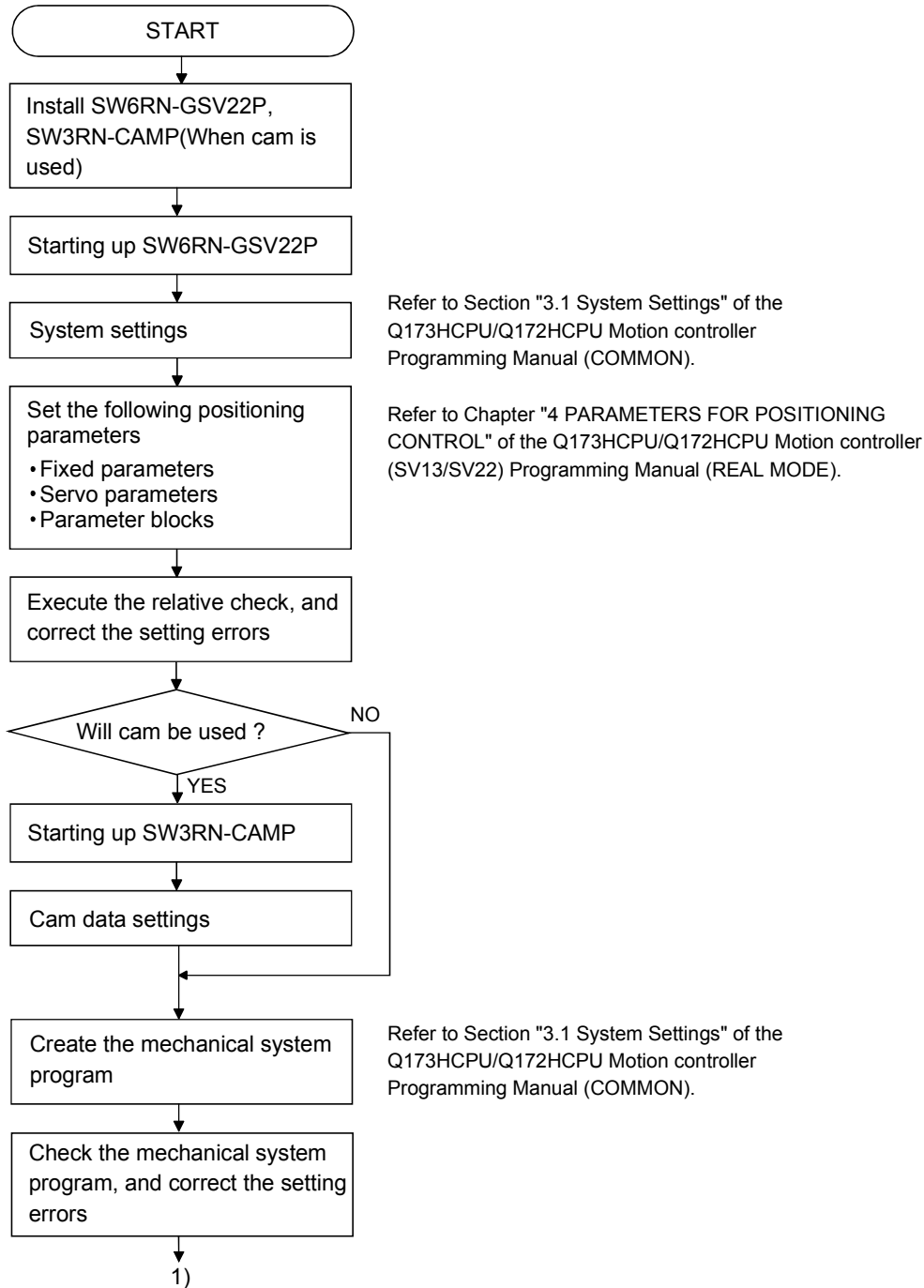

2 STARTING UP THE MULTIPLE CPU SYSTEM

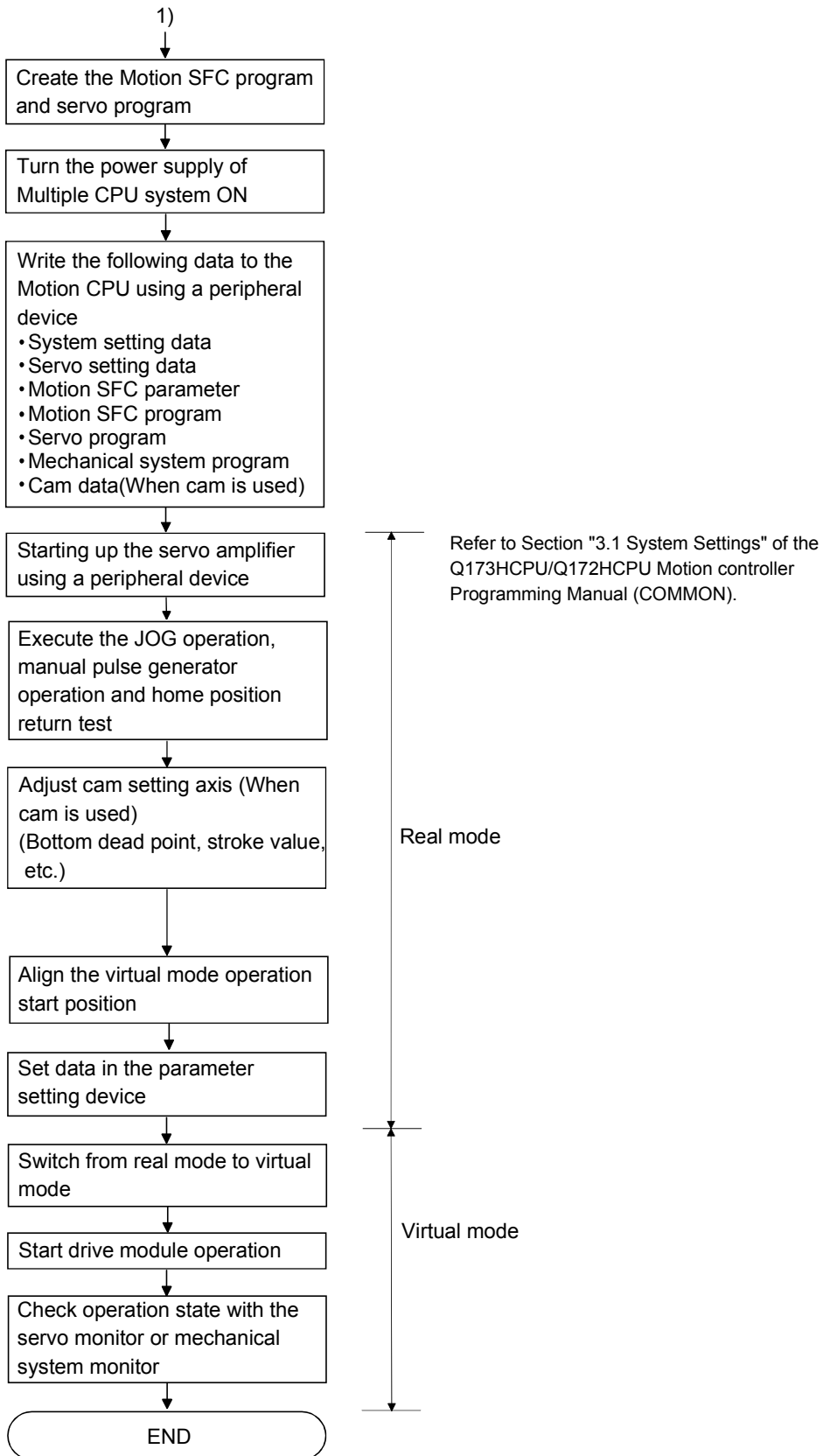

2 STARTING UP THE MULTIPLE CPU SYSTEM

2.2 Differences Between Incremental System and Absolute System

The procedure for virtual mode operation is shown below.

2.2.1 Operation for incremental system

The operation procedure for incremental system is shown below.

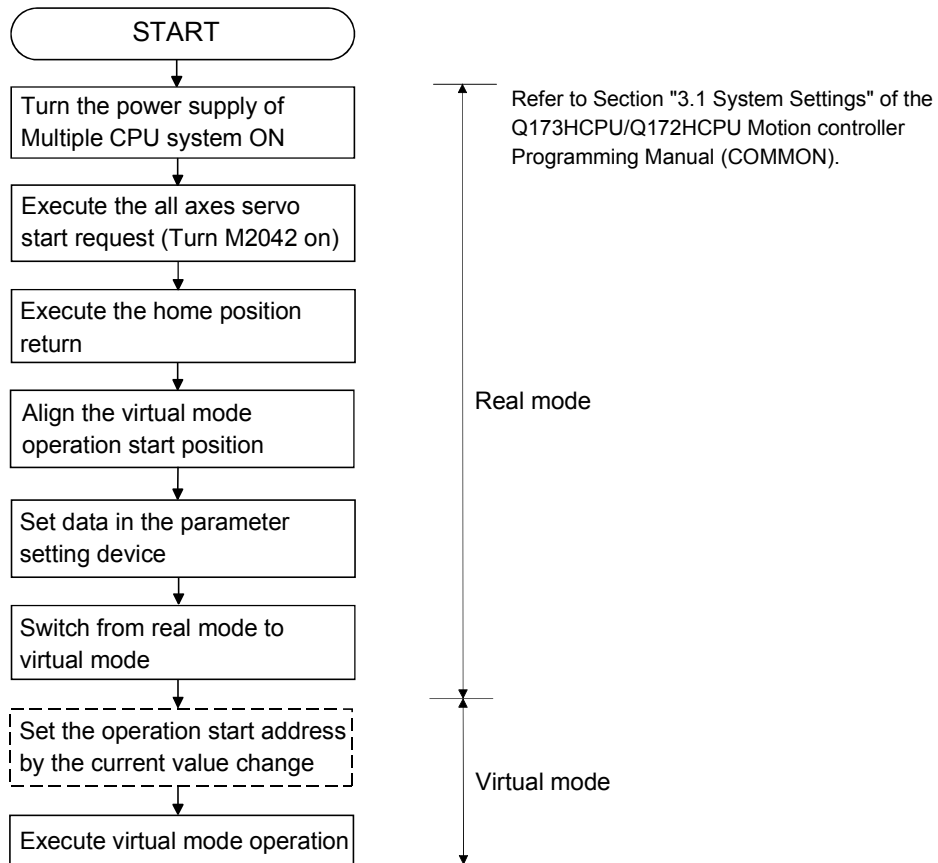

2 STARTING UP THE MULTIPLE CPU SYSTEM

2.2.2 Operation for absolute (absolute position) system

The operation procedure for absolute system is shown below.

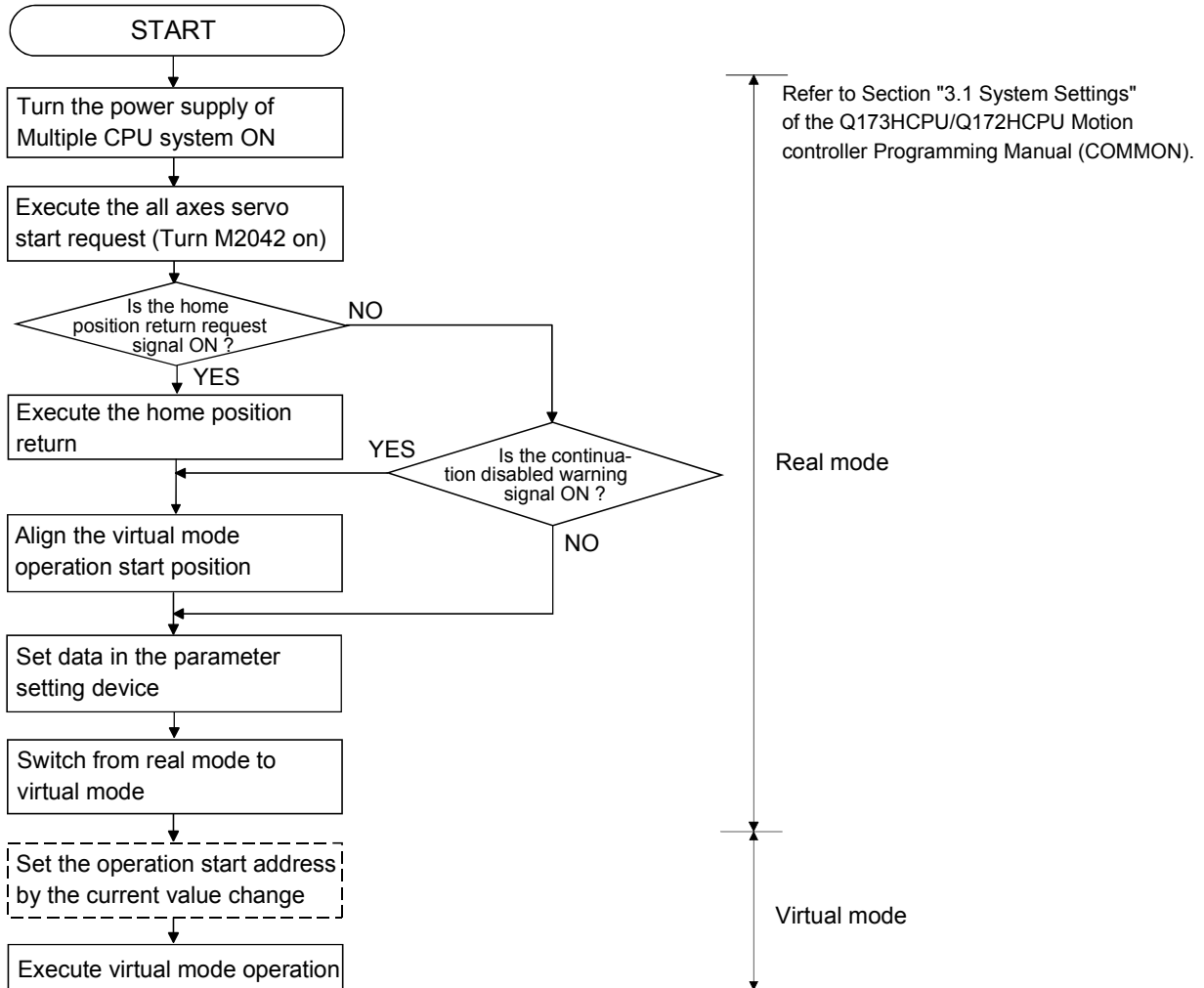

2 STARTING UP THE MULTIPLE CPU SYSTEM

2.3 Differences Between Real Mode and Virtual Mode

Specifications of the positioning data, positioning devices and servo programs, etc. used in the real mode differ in part in the virtual mode.

When using them in the virtual mode, refer to the "Q173HCPU/Q172HCPU Motion controller (SV13/SV22) Programming Manual (REAL MODE)" after checking about a different point in the real mode.

2.3.1 Positioning data

Positioning data used in the virtual mode are shown in Table 2.1 below.

Table 2.1 Positioning Data List

Item	Real mode	Virtual mode	Remark
System settings	○	○	
Fixed parameters	○	△	Usable units differ according to the output module.
Servo parameters	○	○	
Parameter blocks	○	△	Only [PLS] usable.
Home position return data	○	—	
JOG operation data	○	—	
Limit switch output data	○	△	

○ : Used

△ : Used (Restrictions in part)

— : Not used

2.3.2 Positioning devices

The operating ranges of positioning devices used in virtual mode are shown in Table 2.2 below.

Table 2.2 Operating Range of Positioning Devices

Device name	Real mode	Virtual mode
Internal relays	M2000 to M3839 M4640 to M4687 M5440 to M5487	M2000 to M5599
Special relays	M9073 to M9079	
Data registers	D0 to D799 D1120 to D1239	D0 to D1559
Special registers	D9180 to D9201	

2 STARTING UP THE MULTIPLE CPU SYSTEM

2.3.3 Servo programs

- (1) Servo program area
 - (a) The same servo program (Kn) No. cannot be used in both the real and virtual modes. The range of the servo program (Kn) used in the virtual mode must be set in advance.
(The range is set using a peripheral device which started SW6RN-GSV22P.)
- (2) Servo instructions
 - (a) The home position return, speed control (II), speed/position switching control, high-speed oscillation control and speed control with fixed position stop among the controls which can be used in the real mode cannot be used in the virtual mode.
 - (b) Control units of the parameter block and the torque limit value among the positioning data which can be set using the servo program are not used.
- (3) Differences of the servo instruction between real mode and virtual mode are shown in Table 2.3 below.

Table 2.3 Differences of Servo Instruction List

Item		Real mode	Virtual mode	Remark	
Servo instruction	Speed/position control	VPF			
		VPR	○	×	
		VPSTART			
	Speed control (II)	VVF	○	×	
		VVR			
	Home position return	ZERO	○	×	Switch to virtual mode after home position return in the real mode.
	High-speed oscillation	OSC	○	×	
Speed control with fixed position stop	PVF	○	×		
	PVR				
Positioning data	Parameter block	Control units	○	Fixed as "PLS"	
		Torque limit value	○	×	The torque limit value is set with the "drive module parameter".

○ : Used, × : Unusable, — : Not used

(Note) : It is common in the real mode and virtual mode about instructions except for the above table.

2 STARTING UP THE MULTIPLE CPU SYSTEM

2.3.4 Control change (Current value change/speed change)

When a control change is executed in the virtual mode, the feed current value/speed of the drive module is changed.

Control changes are not possible for the output module (except for cam).

Differences between control changes in the real and virtual modes are shown in Table 2.4 below.

Table 2.4 Differences List of Control Change

Item	Real mode	Virtual mode					
		Drive module		Output module			
		Virtual servomotor	Synchronous encoder	Roller	Ball screw	Rotary table	Cam
Current value change	○	○	○	×	×	×	○
Speed change	○	○	×	× (Note-1)			

○ : Used, × : Unusable

(Note-1) : If the output module is a roller which uses a speed change gear, a speed change can be executed by changing the speed change gear ratio.

REMARK

1) Refer to the following Chapters for details of the drive and output modules.

- Drive module : Chapter 5 and 6
- Output module : Chapter 5 and 8

3 PERFORMANCE SPECIFICATIONS

3. PERFORMANCE SPECIFICATIONS

Performance specifications of the Motion CPU are shown in Table 3.1 below.

Table 3.1 Motion CPU Performance Specifications (Virtual Mode)

Item		Q173HCPU(-T)		Q172HCPU(-T)		
Number of control axes		Up to 32 axes (Simultaneous : 2 to 4 axes) (Independent : 32 axes)		Up to 8 axes (Simultaneous : 2 to 4 axes) (Independent : 8 axes)		
Control method		Synchronous control, PTP (Point to Point), speed control, fixed-pitch feed, constant-speed control, position follow-up control, speed-switching control				
Control units	Drive module	Virtual servomotor	PLS			
		Synchronous encoder				
	Output module	Roller	mm, inch			
		Ball screw				
		Rotary table				Fixed as "degree"
Cam	mm, inch, PLS					
Program language		Dedicated instructions (Servo program + mechanical system program)				
Servo program	Capacity	14k steps (14334 steps) ^(Note-2)				
	Number of positioning points	Total of 3200 points (It changes with programs, indirect specification is possible.)				
Mechanical system program	Number of modules which can be set per CPU					
	Drive modules	Virtual module	32 axes		8 axes	
		Synchronous encoder	12 axes		8 axes	
	Virtual axes	Main shaft	32		8	
		Auxiliary input axis	32		8	
	Transmission modules	Gear	64		16	
		Clutch	64		16	
		Speed change gear	64		16	
		Differential gear	32		8	
	Output modules	Differential gear to main shaft	32		8	
		Roller	32	Total of 32	8	Total of 8
	Ball screw	32	8			
	Rotary table	32	8			
	Cam	32	8			
Program setting method		WindowsNT [®] 4.0/ Windows [®] 98/ Windows [®] 2000/ Windows [®] XP which started SW6RN-GSV22P				
Cam	Types	Up to 256 ^(Note-3)				
	Resolution per cycle	256 • 512 • 1024 • 2048 ^(Note-3)				
	Memory capacity	132k bytes				
	Storage memory for cam data	CPU internal RAM memory				
	Stroke resolution	32767				
	Control mode	Two-way cam/feed cam				
Cam data setting method		WindowsNT [®] 4.0/ Windows [®] 98/ Windows [®] 2000/ Windows [®] XP which started SW3RN-CAMP				

3

3 PERFORMANCE SPECIFICATIONS

Table 3.1 Motion CPU Performance Specifications (Virtual Mode) (Continued)

Item		Q173HCPU(-T)	Q172HCPU(-T)						
Virtual servomotor	Interpolation functions	Linear interpolation (2 to 4 axes), circular interpolation (2 axes)							
	Control methods	PTP (Point to Point), speed control, fixed-pitch feed, constant-speed control, position follow-up control							
	Positioning	Method	PTP : Selection of absolute or incremental data method Fixed-pitch feed : Incremental data method Constant-speed control : Both absolute and incremental data method can be used together Position follow-up control : Absolute data method						
		Position command	Address setting range : -2147483648 to 2147483647 [PLS]						
		Speed command	Speed setting range : 1 to 2147483647 [PLS/s]						
	Acceleration/ deceleration control	Automatic trapezoidal acceleration/ deceleration	<table border="1"> <thead> <tr> <th>Acceleration-fixed acceleration/deceleration</th> <th>Time-fixed acceleration/deceleration</th> </tr> </thead> <tbody> <tr> <td>Acceleration time : 1 to 65535 [ms]</td> <td rowspan="2">Acceleration/deceleration time:1 to 5000 [ms] (Only constant-speed control is possible.)</td> </tr> <tr> <td>Deceleration time : 1 to 65535 [ms]</td> </tr> </tbody> </table>	Acceleration-fixed acceleration/deceleration	Time-fixed acceleration/deceleration	Acceleration time : 1 to 65535 [ms]	Acceleration/deceleration time:1 to 5000 [ms] (Only constant-speed control is possible.)	Deceleration time : 1 to 65535 [ms]	
		Acceleration-fixed acceleration/deceleration	Time-fixed acceleration/deceleration						
	Acceleration time : 1 to 65535 [ms]	Acceleration/deceleration time:1 to 5000 [ms] (Only constant-speed control is possible.)							
	Deceleration time : 1 to 65535 [ms]								
	S-curve acceleration/ deceleration	S-curve ratio : 0 to 100[%]							
JOG operation function	Provided								
M-function (with mode)	M-code output function provided, M-code complete wait function provided								
Manual pulse generator operation function (Test mode only)	Up to 3 units can be connected. Up to 3 axes can be operated simultaneously. Setting of magnification : 1 to 10000 Setting of smoothing magnification provided.								

(Note-1) : When the TREN input signal is used as "external input mode clutch", the high speed reading function cannot be used.

(Note-2) : Capacity matching the servo program for real mode.

(Note-3) : Relation between a resolution per cycle of cam and type are shown below.

Resolution per cycle	256	512	1024	2048
Type	256	128	64	32

4. POSITIONING DEDICATED SIGNALS

The internal signals of the Motion CPU and the external signals to the Motion CPU are used as positioning signals.

(1) Internal signals

The following five devices of the Motion CPU are used as the internal signals of the Motion CPU.

- Internal relay (M) M2000 to M5599 (3600 points)
- Special relay (SP.M) M9073 to M9079 (7 points)
- Data register (D) D0 to D1599 (1600 points)
- Motion register (#) #8000 to #8191 (192 points)
- Special register (SP.D) D9112, D9180 to D9201 (23 points)

(2) External signals

The external input signals to the Motion CPU are shown below.

- Upper/lower limit switch input The upper/lower limit of the positioning range is controlled.
- Stop signal This signal makes the starting axis stop.
- Proximity dog signal..... ON/OFF signal from the proximity dog.
- Speed/position switching signal Signal for switching from speed to position.
- Manual pulse generator input Signal from the manual pulse generator.

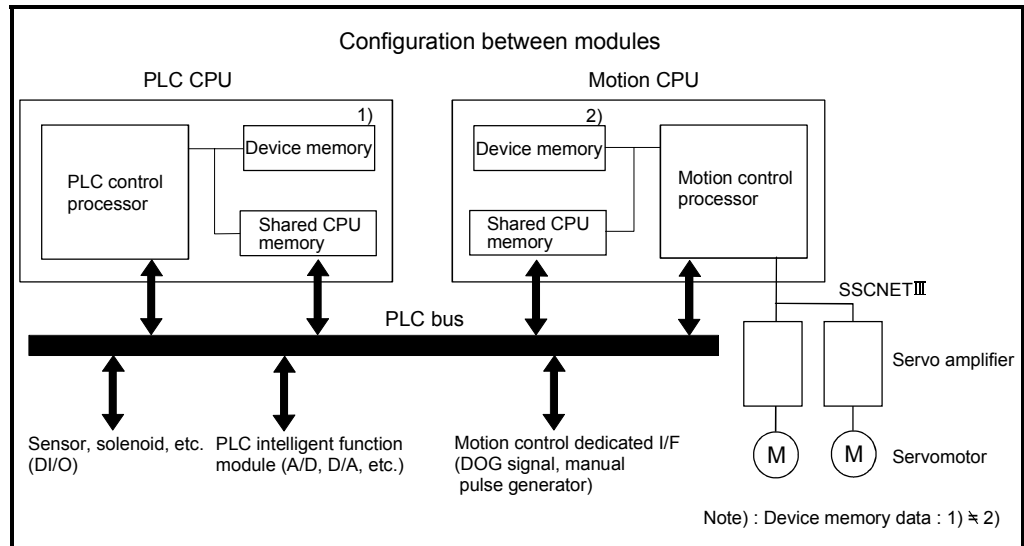

Fig.4.1 Flow of the internal signals/external signals

4 POSITIONING DEDICATED SIGNALS

The positioning dedicated devices are shown below.

It indicates the device refresh cycle of the Motion CPU for status signal with the positioning control, and the device fetch cycle of the Motion CPU for command signal with the positioning control.

The operation cycle and main cycle of the Motion CPU are shown below.

(a) Operation cycle

Item		Q173HCPU	Q172HCPU
Number of control axes		Up to 32 axes	Up to 8 axes
Operation cycle (Default)	SV22	0.88[ms] / 1 to 5 axes 1.77[ms] / 6 to 14 axes 3.55[ms] / 15 to 28 axes 7.11[ms] / 29 to 32 axes	0.88[ms] / 1 to 5 axes 1.77[ms] / 6 to 8 axes

(b) Main cycle is not fixed-cycle as operation cycle. The cycle is dozens[ms] to hundreds[ms].

4.1 Internal Relays

(1) Internal relay list

Q173HCPU				Q172HCPU			
Device No.	Purpose	Real	Virtual	Device No.	Purpose	Real	Virtual
M0 to	User device (2000 points)			M0 to	User device (2000 points)		
M2000 to	Common device (320 points)	○	○	M2000 to	Common device (320 points)	○	○
M2320 to	Special relay allocated device (Status) (80 points)	○	○	M2320 to	Special relay allocated device (Status) (80 points)	○	○
M2400 to	Axis status (20 points × 32 axes) Real mode Each axis Virtual mode ... Output module	○	○	M2400 to	Axis status (20 points × 8 axes) Real mode Each axis Virtual mode ... Output module	○	○
M3040 to	Unusable (32 points)	—	—	M2560 to	Unusable (512 points)	—	—
M3072 to	Common device (Command signal) (64 points)	○	○	M3072 to	Common device (Command signal) (64 points)	○	○
M3136 to	Special relay allocated device (Command signal) (64 points)	○	○	M3136 to	Special relay allocated device (Command signal) (64 points)	○	○
M3200 to	Axis command signal (20 points × 32 axes) Real mode Each axis Virtual mode ... Output module	○	○	M3200 to	Axis command signal (20 points × 8 axes) Real mode Each axis Virtual mode ... Output module	○	○
M3840 to M3999	Unusable (160 points)	—	—	M3360 to M3999	Unusable (640 points)	—	—

} Real/
virtual
community

4 POSITIONING DEDICATED SIGNALS

Internal relay list (Continued)

Q173HCPU				Q172HCPU			
Device No.	Purpose	Real	Virtual	Device No.	Purpose	Real	Virtual
M4000 (Note-1) to	Virtual servomotor axis status (20 points × 32 axes) (Note-2)	Back up	○	M4000 (Note-1) to	Virtual servomotor axis status (20 points × 8 axes) (Note-2)	Back up	○
				M4160 (Note-1) to	Unusable (480 points)	—	—
M4640 (Note-1) to	Synchronous encoder axis status (4 points × 12 axes)	○	○	M4640 (Note-1) to	Synchronous encoder axis status (4 points × 8 axes)	○	○
M4688 (Note-1) to	Unusable (112 points)	—	—	M4672 (Note-1) to	Unusable (128 points)	—	—
M4800 (Note-1) to	Virtual servomotor axis command signal (20 points × 32 axes) (Note-2)	×	○	M4800 (Note-1) to	Virtual servomotor axis command signal (20 points × 8 axes) (Note-2)	×	○
				M4960 (Note-1) to	Unusable (480 points)	—	—
M5440 (Note-1) to	Synchronous encoder axis command signal (4 points × 12 axes)	×	○	M5440 (Note-1) to	Synchronous encoder axis command signal (4 points × 8 axes)	×	○
				M5472 (Note-1) to	Unusable (16 points)	—	—
M5488 (Note-1) to	Cam axis command signal (1 point × 32 axes) (Note-3)	×	○	M5488 (Note-1) to	Cam axis command signal (1 point × 8 axes) (Note-3)	×	○
				M5496 to	Unusable (24 points)	—	—
M5520 to	Smoothing clutch complete signal (2 points × 32 axes) (Note-2)	×	○	M5520 to	Smoothing clutch complete signal (2 points × 8 axes) (Note-2)	×	○
M5584 to	Unusable (16 points)	—	—	M5536 to	Unusable (64 points)	—	—
M5600 to	User device (2592 points)			M5600 to	User device (2592 points)		
M8191				M8191			

Virtual

○ : Valid, × : Invalid

It can be used as a user device.

POINT

- Total number of user device points

4592 points

(Note-1) : Do not set M4000 to M5599 as the latch range in virtual mode.

(Note-2) : This signal occupies only the area of the axis set in the mechanical system program. The unused axis areas in the mechanical system program can be used as a user device.

(Note-3) : Unused axis of cam axis command signal can be used as a user device.

(Note-4) : As for "axis status (M2400 to)" and "axis command signal (M3200 to)", only details for internal relays used in the virtual mode are described in this manual. If it is required, refer to the "Q173HCPU/Q172HCPU Motion controller (SV13/SV22) Programming Manual (REAL MODE)".

4 POSITIONING DEDICATED SIGNALS

(2) Axis status list

Axis No.	Device No.	Signal name										
		Signal name	Real	Virtual					Refresh cycle	Fetch cycle	Signal direction	
Roller	Ball screw			Rotary table	Cam	Real Mode axis						
1	M2400 to M2419											
2	M2420 to M2439											
3	M2440 to M2459											
4	M2460 to M2479											
5	M2480 to M2499											
6	M2500 to M2519	0		OFF					Operation cycle	Status signal		
7	M2520 to M2539	1		OFF								
8	M2540 to M2559	2		○								
9	M2560 to M2579	3		OFF								
10	M2580 to M2599	4		OFF								
11	M2600 to M2619	5		OFF								
12	M2620 to M2639	6		OFF								
13	M2640 to M2659	7		OFF								
14	M2660 to M2679	8	○									Immediately
15	M2680 to M2699	9										Operation cycle
16	M2700 to M2719	10		○					Main cycle			
17	M2720 to M2739	11							Operation cycle			
18	M2740 to M2759	12							Main cycle			
19	M2760 to M2779	13							Operation cycle			
20	M2780 to M2799	14							Main cycle			
21	M2800 to M2819	15							Operation cycle			
22	M2820 to M2839	16							Operation cycle			
23	M2840 to M2859	17	—	—					—			
24	M2860 to M2879	18	○	○					At virtual mode transition	Status signal		
25	M2880 to M2899	19		OFF					Operation cycle			
26	M2900 to M2919											
27	M2920 to M2939											
28	M2940 to M2959											
29	M2960 to M2979											
30	M2980 to M2999											
31	M3000 to M3019											
32	M3020 to M3039											

○ : Valid

(Note-1) : It is unusable in the SV22 real mode.

(Note-2) : The range of axis No.1 to 8 is valid in the Q172HCPU.

(Note-3) : Device area of 9 axes or more is unusable in the Q172HCPU.

REMARK

(Note-1) : Details except for internal relays used in the virtual mode are not described in this manual.

If it is required, refer to Section "3.1.1 Axis statuses" of the "Q173HCPU/Q172HCPU Motion controller (SV13/SV22) Programming Manual (REAL MODE)".

4 POSITIONING DEDICATED SIGNALS

(3) Axis command signal list

Axis No.	Device No.	Signal name									
		Signal name	Real	Virtual					Refresh cycle	Fetch cycle	Signal direction
Roller	Ball screw			Rotary table	Cam	Real mode axis					
1	M3200 to M3219										
2	M3220 to M3239										
3	M3240 to M3259										
4	M3260 to M3279										
5	M3280 to M3299										
6	M3300 to M3319	0	Stop command							Operation cycle	Command signal
7	M3320 to M3339	1	Rapid stop command							Main cycle	
8	M3340 to M3359	2	Forward rotation JOG start command								
9	M3360 to M3379	3	Reverse rotation JOG start command	○		×			○		
10	M3380 to M3399	4	Complete signal OFF command								
11	M3400 to M3419	5	Speed/position switching enable command							Operation cycle	
12	M3420 to M3439	6	Unusable	—		—		—	—	—	—
13	M3440 to M3459	7	Error reset command								
14	M3460 to M3479	8	Servo error reset command	○		○			○	Main cycle	Command signal
15	M3480 to M3499	9	External stop input disable at start command			×				At start	
16	M3500 to M3519	10	Unusable	—		—		—	—	—	—
17	M3520 to M3539	11	Unusable	—		—		—	—	—	—
18	M3540 to M3559	12	Feed current value update request command	○		×			○	At start	Command signal
19	M3560 to M3579	13	Address clutch reference setting command (Note-1)		×		○			At virtual mode transition	
20	M3580 to M3599	14	Cam reference position setting command (Note-1)	×		×		○	×	Operation cycle	
21	M3600 to M3619	15	Servo OFF command								
22	M3620 to M3639	16	Gain changing command	○		○			○	Operation cycle (Note-4)	
23	M3640 to M3659	17	Unusable	—		—		—	—	—	—
24	M3660 to M3679	18	Control loop changing command	○		○			○	Operation cycle	Command signal
25	M3680 to M3699	19	FIN signal			×					

○ : Valid, × : Invalid

(Note-1) : It is unusable in the SV22 real mode.

(Note-2) : The range of axis No.1 to 8 is valid in the Q172HCPU.

(Note-3) : Device area of 9 axes or more is unusable in the Q172HCPU.

(Note-4) : Operation cycle 7.1[ms] or more: Every 3.5[ms]

REMARK

(Note-1) : Details except for internal relays used in the virtual mode are not described in this manual. If it is required, refer to Section "3.1.2 Axis command signals" of the "Q173HCPU/Q172HCPU Motion controller (SV13/SV22) Programming Manual (REAL MODE)".

4 POSITIONING DEDICATED SIGNALS

(4) Virtual servomotor axis status list

Axis No.	Device No.	Signal name									
		Signal name	Real	Virtual					Refresh cycle	Fetch cycle	Signal direction
				Roller	Ball screw	Rotary table	Cam	Real mode axis			
1	M4000 to M4019										
2	M4020 to M4039										
3	M4040 to M4059										
4	M4060 to M4079										
5	M4080 to M4099										
6	M4100 to M4119	0 Positioning start complete	Backup					Operation cycle	/	Status signal	
7	M4120 to M4139	1 Positioning complete			○						×
8	M4140 to M4159	2 Unusable	—					—	—	—	
9	M4160 to M4179	3 Command in-position	Backup					Operation cycle	/	Status signal	
10	M4180 to M4199	4 Speed controlling			○						×
11	M4200 to M4219	5 Unusable	—					—	—	—	
12	M4220 to M4239	6 Unusable	—					—	—	—	
13	M4240 to M4259	7 Error detection	Backup					Immediately	/	Status signal	
14	M4260 to M4279				○						×
15	M4280 to M4299	8 Unusable	—					—	—	—	
16	M4300 to M4319	9 Unusable	—					—	—	—	
17	M4320 to M4339	10 Unusable	—					—	—	—	
18	M4340 to M4359	11 Unusable	—					—	—	—	
19	M4360 to M4379	12 Unusable	—					—	—	—	
20	M4380 to M4399	13 Unusable	—					—	—	—	
21	M4400 to M4419	14 Unusable	—					—	—	—	
22	M4420 to M4439	15 Unusable	—					—	—	—	
23	M4440 to M4459	16 Unusable	—					—	—	—	
24	M4460 to M4479	17 Unusable	—					—	—	—	
25	M4480 to M4499	18 Unusable	—					—	—	—	
26	M4500 to M4519	19 M-code outputting signal	Backup					Operation cycle	/	Status signal	
27	M4520 to M4539				○						×
28	M4540 to M4559										
29	M4560 to M4579										
30	M4580 to M4599										
31	M4600 to M4619										
32	M4620 to M4639										

○ : Valid, × : Invalid

(Note-1) : The range of axis No.1 to 8 is valid in the Q172HCPU.

(Note-2) : The unused axis areas in the mechanical system program can be used as an user device.

4 POSITIONING DEDICATED SIGNALS

(5) Virtual servomotor axis command signal list

Axis No.	Device No.	Signal name									
		Signal name	Real	Virtual					Refresh cycle	Fetch cycle	Signal direction
				Roller	Ball screw	Rotary table	Cam	Real mode axis			
1	M4800 to M4819										
2	M4820 to M4839										
3	M4840 to M4859										
4	M4860 to M4879										
5	M4880 to M4899										
6	M4900 to M4919	0 Stop command						/	Operation cycle		
7	M4920 to M4939	1 Rapid stop command									
8	M4940 to M4959	2 Forward rotation JOG start command					Main cycle				
9	M4960 to M4979	3 Reverse rotation JOG start command	×		○						
10	M4980 to M4999	4 Complete signal OFF command				×					
11	M5000 to M5019	5 Unusable	—				—	—	—	—	
12	M5020 to M5039	6 Unusable	—				—	—	—	—	
13	M5040 to M5059	7 Error reset command	×				×	/	Main cycle	Command signal	
14	M5060 to M5079	8 Unusable	—				—	—	—	—	
15	M5080 to M5099	9 External stop input disable at start command	×				×	/	At start	Command signal	
16	M5100 to M5119	10 Unusable	—				—	—	—	—	
17	M5120 to M5139	11 Unusable	—				—	—	—	—	
18	M5140 to M5159	12 Unusable	—				—	—	—	—	
19	M5160 to M5179	13 Unusable	—				—	—	—	—	
20	M5180 to M5199	14 Unusable	—				—	—	—	—	
21	M5200 to M5219	15 Unusable	—				—	—	—	—	
22	M5220 to M5239	16 Unusable	—				—	—	—	—	
23	M5240 to M5259	17 Unusable	—				—	—	—	—	
24	M5260 to M5279	18 Unusable	—				—	—	—	—	
25	M5280 to M5299	19 FIN signal	×				×	/	Operation cycle	Command signal	
26	M5300 to M5319										
27	M5320 to M5339										
28	M5340 to M5359										
29	M5360 to M5379										
30	M5380 to M5399										
31	M5400 to M5419										
32	M5420 to M5439										

○ : Valid, × : Invalid

(Note-1) : The range of axis No.1 to 8 is valid in the Q172HCPU.

(Note-2) : The unused axis areas in the mechanical system program can be used as an user device.

4 POSITIONING DEDICATED SIGNALS

(6) Synchronous encoder axis status list

Axis No.	Device No.	Signal name																						
1	M4640 to M4643	<table border="1"> <thead> <tr> <th>Signal name</th> <th>Real</th> <th>Virtual</th> <th>Refresh cycle</th> <th>Fetch cycle</th> <th>Signal direction</th> </tr> </thead> <tbody> <tr> <td>0 Error detection</td> <td rowspan="3">○</td> <td rowspan="3">○</td> <td>Immediately</td> <td rowspan="3">/</td> <td rowspan="3">Status signal</td> </tr> <tr> <td>1 External signal TREN</td> <td>Main cycle</td> </tr> <tr> <td>2 Virtual mode continuation operation disable warning</td> <td>Main cycle</td> </tr> <tr> <td>3 Unusable</td> <td>—</td> <td>—</td> <td>—</td> <td>—</td> <td>—</td> </tr> </tbody> </table>	Signal name	Real	Virtual	Refresh cycle	Fetch cycle	Signal direction	0 Error detection	○	○	Immediately	/	Status signal	1 External signal TREN	Main cycle	2 Virtual mode continuation operation disable warning	Main cycle	3 Unusable	—	—	—	—	—
Signal name	Real		Virtual	Refresh cycle	Fetch cycle	Signal direction																		
0 Error detection	○		○	Immediately	/	Status signal																		
1 External signal TREN				Main cycle																				
2 Virtual mode continuation operation disable warning				Main cycle																				
3 Unusable	—		—	—	—	—																		
2	M4644 to M4647																							
3	M4648 to M4651																							
4	M4652 to M4655																							
5	M4656 to M4659																							
6	M4660 to M4663																							
7	M4664 to M4667																							
8	M4668 to M4671																							
9	M4672 to M4675																							
10	M4676 to M4679																							
11	M4680 to M4683																							
12	M4684 to M4687																							

○ : Valid

(Note-1) : The range of axis No.1 to 8 is valid in the Q172HCPU.

(Note-2) : Device area of 9 axes or more is unusable in the Q172HCPU.

(7) Synchronous encoder axis command signal list

Axis No.	Device No.	Signal name																				
1	M5440 to M5443	<table border="1"> <thead> <tr> <th>Signal name</th> <th>Real</th> <th>Virtual</th> <th>Refresh cycle</th> <th>Fetch cycle</th> <th>Signal direction</th> </tr> </thead> <tbody> <tr> <td>0 Error reset</td> <td>×</td> <td>○</td> <td>/</td> <td>Main cycle</td> <td>Status signal</td> </tr> <tr> <td>1</td> <td rowspan="3">—</td> <td rowspan="3">—</td> <td rowspan="3">—</td> <td rowspan="3">—</td> <td rowspan="3">—</td> </tr> <tr> <td>2 Unusable</td> </tr> <tr> <td>3</td> </tr> </tbody> </table>	Signal name	Real	Virtual	Refresh cycle	Fetch cycle	Signal direction	0 Error reset	×	○	/	Main cycle	Status signal	1	—	—	—	—	—	2 Unusable	3
Signal name	Real		Virtual	Refresh cycle	Fetch cycle	Signal direction																
0 Error reset	×		○	/	Main cycle	Status signal																
1	—		—	—	—	—																
2 Unusable																						
3																						
2	M5444 to M5447																					
3	M5448 to M5451																					
4	M5452 to M5455																					
5	M5456 to M5459																					
6	M5460 to M5463																					
7	M5464 to M5467																					
8	M5468 to M5471																					
9	M5472 to M5475																					
10	M5476 to M5479																					
11	M5480 to M5483																					
12	M5484 to M5487																					

○ : Valid, × : Invalid

(Note-1) : The range of axis No.1 to 8 is valid in the Q172HCPU.

(Note-2) : Device area of 9 axes or more is unusable in the Q172HCPU.

4 POSITIONING DEDICATED SIGNALS

(8) Cam axis command signal list

Device No.	Signal name	Refresh cycle	Fetch cycle	Signal direction	Remark
M5488	Axis-1 cam/ball screw switching		Main cycle	Command signal	
M5489	Axis-2 cam/ball screw switching				
M5490	Axis-3 cam/ball screw switching				
M5491	Axis-4 cam/ball screw switching				
M5492	Axis-5 cam/ball screw switching				
M5493	Axis-6 cam/ball screw switching				
M5494	Axis-7 cam/ball screw switching				
M5495	Axis-8 cam/ball screw switching				
M5496	Axis-9 cam/ball screw switching				
M5497	Axis-10 cam/ball screw switching				
M5498	Axis-11 cam/ball screw switching				
M5499	Axis-12 cam/ball screw switching				
M5500	Axis-13 cam/ball screw switching				
M5501	Axis-14 cam/ball screw switching				
M5502	Axis-15 cam/ball screw switching				
M5503	Axis-16 cam/ball screw switching				
M5504	Axis-17 cam/ball screw switching				
M5505	Axis-18 cam/ball screw switching				
M5506	Axis-19 cam/ball screw switching				
M5507	Axis-20 cam/ball screw switching				
M5508	Axis-21 cam/ball screw switching				
M5509	Axis-22 cam/ball screw switching				
M5510	Axis-23 cam/ball screw switching				
M5511	Axis-24 cam/ball screw switching				
M5512	Axis-25 cam/ball screw switching				
M5513	Axis-26 cam/ball screw switching				
M5514	Axis-27 cam/ball screw switching				
M5515	Axis-28 cam/ball screw switching				
M5516	Axis-29 cam/ball screw switching				
M5517	Axis-30 cam/ball screw switching				
M5518	Axis-31 cam/ball screw switching				
M5519	Axis-32 cam/ball screw switching				

(Note-1) : The range of axis No.1 to 8 is valid in the Q172HCPU.

(Note-2) : Device area of 9 axes or more is unusable in the Q172HCPU.

(Note-3) : Unused axis of cam axis command signal can be used as an user device.

4 POSITIONING DEDICATED SIGNALS

(9) Smoothing clutch complete signal list

Device No.	Signal name		Refresh cycle	Fetch cycle	Signal direction	Remark
M5520	Output axis 1	Main shaft side	Operation cycle		Status signal	
M5521		Auxiliary input side				
M5522	Output axis 2	Main shaft side				
M5523		Auxiliary input side				
M5524	Output axis 3	Main shaft side				
M5525		Auxiliary input side				
M5526	Output axis 4	Main shaft side				
M5527		Auxiliary input side				
M5528	Output axis 5	Main shaft side				
M5529		Auxiliary input side				
M5530	Output axis 6	Main shaft side				
M5531		Auxiliary input side				
M5532	Output axis 7	Main shaft side				
M5533		Auxiliary input side				
M5534	Output axis 8	Main shaft side				
M5535		Auxiliary input side				
M5536	Output axis 9	Main shaft side				
M5537		Auxiliary input side				
M5538	Output axis 10	Main shaft side				
M5539		Auxiliary input side				
M5540	Output axis 11	Main shaft side				
M5541		Auxiliary input side				
M5542	Output axis 12	Main shaft side				
M5543		Auxiliary input side				
M5544	Output axis 13	Main shaft side				
M5545		Auxiliary input side				
M5546	Output axis 14	Main shaft side				
M5547		Auxiliary input side				
M5548	Output axis 15	Main shaft side				
M5549		Auxiliary input side				
M5550	Output axis 16	Main shaft side				
M5551		Auxiliary input side				
M5552	Output axis 17	Main shaft side				
M5553		Auxiliary input side				
M5554	Output axis 18	Main shaft side				
M5555		Auxiliary input side				
M5556	Output axis 19	Main shaft side				
M5557		Auxiliary input side				
M5558	Output axis 20	Main shaft side				
M5559		Auxiliary input side				
M5560	Output axis 21	Main shaft side				
M5561		Auxiliary input side				
M5562	Output axis 22	Main shaft side				
M5563		Auxiliary input side				
M5564	Output axis 23	Main shaft side				
M5565		Auxiliary input side				
M5566	Output axis 24	Main shaft side				
M5567		Auxiliary input side				
M5568	Output axis 25	Main shaft side				
M5569		Auxiliary input side				
M5570	Output axis 26	Main shaft side				
M5571		Auxiliary input side				
M5572	Output axis 27	Main shaft side				
M5573		Auxiliary input side				
M5574	Output axis 28	Main shaft side				
M5575		Auxiliary input side				
M5576	Output axis 29	Main shaft side				
M5577		Auxiliary input side				
M5578	Output axis 30	Main shaft side				
M5579		Auxiliary input side				
M5580	Output axis 31	Main shaft side				
M5581		Auxiliary input side				
M5582	Output axis 32	Main shaft side				
M5583		Auxiliary input side				

(Note-1) : The range of axis No.1 to 8 is valid in the Q172HCPU.

(Note-2) : Device area of 9 axes or more is unusable in the Q172HCPU.

(Note-3) : Unused axis of mechanical system program can be used as an user device.

4 POSITIONING DEDICATED SIGNALS

(10) Common device list

Device No.	Signal name	Refresh cycle	Fetch cycle	Signal direction	Remark (Note-5)
M2000	PLC ready flag	/	Main cycle	Command signal (Note-4)	M3072
M2001	Axis 1	Start accept flag	Operation cycle	Status signal (Note-1), (Note-2)	
M2002	Axis 2				
M2003	Axis 3				
M2004	Axis 4				
M2005	Axis 5				
M2006	Axis 6				
M2007	Axis 7				
M2008	Axis 8				
M2009	Axis 9				
M2010	Axis 10				
M2011	Axis 11				
M2012	Axis 12				
M2013	Axis 13				
M2014	Axis 14				
M2015	Axis 15				
M2016	Axis 16				
M2017	Axis 17				
M2018	Axis 18				
M2019	Axis 19				
M2020	Axis 20				
M2021	Axis 21				
M2022	Axis 22				
M2023	Axis 23				
M2024	Axis 24				
M2025	Axis 25				
M2026	Axis 26				
M2027	Axis 27				
M2028	Axis 28				
M2029	Axis 29				
M2030	Axis 30				
M2031	Axis 31				
M2032	Axis 32				
M2033	Unusable	—	—	—	—
M2034	Personal computer link communication error flag	Operation cycle	/	Status signal	
M2035	Motion SFC error history clear request flag (Note-6)	/	Main cycle	Command signal	M3080
M2036	Unusable	—	—	—	—
M2037	(3 points)				
M2038					
M2039	Motion SFC error detection flag	/	Immediate	Status signal	
M2040	Speed switching point specified flag	/	At start	Command signal (Note-4)	M3073
M2041	System setting error flag	Operation cycle	/	Status signal	
M2042	All axes servo ON command	/	Operation cycle	Command signal	M3074
M2043	Real/virtual mode switching request (SV22)	/	At virtual mode transition	Command signal (Note-4)	M3075
M2044	Real/virtual mode switching status (SV22)	At virtual mode transition	/	Status signal	
M2045	Real/virtual mode switching error detection (SV22)				
M2046	Out-of-sync warning (SV22)				
M2047	Motion slot fault detection flag	Operation cycle	/	Status signal	
M2048	JOG operation simultaneous start command	/	Main cycle	Command signal (Note-4)	M3076
M2049	All axes servo ON accept flag	Operation cycle	/	Status signal	
M2050	Start buffer full				
M2051	Manual pulse generator 1 enable flag	/	Main cycle	Command signal (Note-4)	M3077
M2052	Manual pulse generator 2 enable flag				
M2053	Manual pulse generator 3 enable flag	/	Main cycle	Command signal (Note-4)	M3079
M2054	Operation cycle over flag	Operation cycle	/	Status signal	
M2055	Unusable (6 points)	—	—	—	—
M2056					
M2057					
M2058					
M2059					
M2060					
M2061	Axis 1	Speed changing flag	Operation cycle	Status signal (Note-1), (Note-2)	
M2062	Axis 2				
M2063	Axis 3				
M2064	Axis 4				
M2065	Axis 5				
M2066	Axis 6				
M2067	Axis 7				
M2068	Axis 8				
M2069	Axis 9				
M2070	Axis 10				
M2071	Axis 11				
M2072	Axis 12				
M2073	Axis 13				
M2074	Axis 14				
M2075	Axis 15				
M2076	Axis 16				
M2077	Axis 17				
M2078	Axis 18				
M2079	Axis 19				
M2080	Axis 20				
M2081	Axis 21				
M2082	Axis 22				
M2083	Axis 23				
M2084	Axis 24				
M2085	Axis 25				
M2086	Axis 26				
M2087	Axis 27				
M2088	Axis 28				
M2089	Axis 29				
M2090	Axis 30				
M2091	Axis 31				
M2092	Axis 32				
M2093	Unusable (8 points)	—	—	—	—
M2094					
M2095					
M2096					
M2097					
M2098					
M2099					
M2100					
M2101	Axis 1	Synchronous encoder current value changing flag (Note-3) (12 axes)	Operation cycle	Status signal (Note-1), (Note-2)	
M2102	Axis 2				
M2103	Axis 3				
M2104	Axis 4				
M2105	Axis 5				
M2106	Axis 6				
M2107	Axis 7				
M2108	Axis 8				
M2109	Axis 9				
M2110	Axis 10				
M2111	Axis 11				
M2112	Axis 12				
M2113	Unusable (6 points)	—	—	—	—
M2114					
M2115					
M2116					
M2117					
M2118					

4 POSITIONING DEDICATED SIGNALS

Common device list (Continued)

Device No.	Signal name	Refresh cycle	Fetch cycle	Signal direction	Remark (Note-5)	Device No.	Signal name	Refresh cycle	Fetch cycle	Signal direction	Remark (Note-5)								
M2119	Unusable (9 points)	—	—	—	—	M2180	Output Main shaft side	—	—	—	—								
M2120						Auxiliary input side													
M2121						Main shaft side													
M2122							Auxiliary input side												
M2123						Main shaft side													
M2124							Auxiliary input side												
M2125						Main shaft side													
M2126							Auxiliary input side												
M2127						Main shaft side													
M2128	Axis 1	Operation cycle	—	—	—	M2186	Output Main shaft side	Operation cycle	—	—	Status signal (Note-1), (Note-2)								
M2129	Axis 2																		
M2130	Axis 3																		
M2131	Axis 4																		
M2132	Axis 5																		
M2133	Axis 6																		
M2134	Axis 7																		
M2135	Axis 8																		
M2136	Axis 9																		
M2137	Axis 10																		
M2138	Axis 11																		
M2139	Axis 12																		
M2140	Axis 13																		
M2141	Axis 14																		
M2142	Axis 15																		
M2143	Axis 16																		
M2144	Axis 17																		
M2145	Axis 18																		
M2146	Axis 19																		
M2147	Axis 20																		
M2148	Axis 21																		
M2149	Axis 22																		
M2150	Axis 23																		
M2151	Axis 24																		
M2152	Axis 25																		
M2153	Axis 26																		
M2154	Axis 27																		
M2155	Axis 28																		
M2156	Axis 29																		
M2157	Axis 30																		
M2158	Axis 31																		
M2159	Axis 32																		
M2160	Output axis 1	Clutch status (SV22) ^(Note-3)	—	—	—	M2187	Output Auxiliary input side	Clutch status (SV22) ^(Note-3)	—	—	—								
M2161	Auxiliary input side																		
M2162	Output axis 2																		
M2163	Auxiliary input side																		
M2164	Output axis 3																		
M2165	Auxiliary input side																		
M2166	Output axis 4																		
M2167	Auxiliary input side																		
M2168	Output axis 5																		
M2169	Auxiliary input side																		
M2170	Output axis 6																		
M2171	Auxiliary input side																		
M2172	Output axis 7																		
M2173	Auxiliary input side																		
M2174	Output axis 8																		
M2175	Auxiliary input side																		
M2176	Output axis 9																		
M2177	Auxiliary input side																		
M2178	Output axis 10																		
M2179	Auxiliary input side																		
M2200	Output axis 20					Clutch status (SV22) ^(Note-3)	—					—	—	M2188	Output Main shaft side	Clutch status (SV22) ^(Note-3)	—	—	—
M2201	Auxiliary input side																		
M2202	Output axis 21																		
M2203	Auxiliary input side																		
M2204	Output axis 22																		
M2205	Auxiliary input side																		
M2206	Output axis 23																		
M2207	Auxiliary input side																		
M2208	Output axis 24																		
M2209	Auxiliary input side																		
M2210	Output axis 25																		
M2211	Auxiliary input side																		
M2212	Output axis 26																		
M2213	Auxiliary input side																		
M2214	Output axis 27																		
M2215	Auxiliary input side																		
M2216	Output axis 28																		
M2217	Auxiliary input side																		
M2218	Output axis 29																		
M2219	Auxiliary input side																		
M2220	Output axis 30																		
M2221	Auxiliary input side																		
M2222	Output axis 31																		
M2223	Auxiliary input side																		
M2224	Output axis 32																		
M2225	Auxiliary input side																		
M2226	Unusable (5 points)	—	—	—	—			M2227	—	—	—			—	—				
M2228								—											
M2229																			

4 POSITIONING DEDICATED SIGNALS

Common device list (Continued)

Device No.	Signal name	Refresh cycle	Fetch cycle	Signal direction	Remark (Note-5)				
M2229	Unusable (11 points)	—	—	—	—				
M2230									
M2231									
M2232									
M2233									
M2234									
M2235									
M2236									
M2237									
M2238									
M2239									
M2240	Axis 1	Operation cycle			Status signal (Note-1), (Note-2)				
M2241	Axis 2								
M2242	Axis 3								
M2243	Axis 4								
M2244	Axis 5								
M2245	Axis 6								
M2246	Axis 7								
M2247	Axis 8								
M2248	Axis 9								
M2249	Axis 10								
M2250	Axis 11								
M2251	Axis 12								
M2252	Axis 13								
M2253	Axis 14								
M2254	Axis 15								
M2255	Axis 16								
M2256	Axis 17								
M2257	Axis 18								
M2258	Axis 19								
M2259	Axis 20								
M2260	Axis 21								
M2261	Axis 22								
M2262	Axis 23								
M2263	Axis 24								
M2264	Axis 25								
M2265	Axis 26								
M2266	Axis 27								
M2267	Axis 28								
M2268	Axis 29								
M2269	Axis 30								
M2270	Axis 31								
M2271	Axis 32								
M2272	Axis 1	Control loop monitor status			Status signal (Note-1), (Note-2)				
M2273	Axis 2								
M2274	Axis 3								
M2275	Axis 4								
M2276	Axis 5	Operation cycle			Status signal (Note-1), (Note-2)				
M2277	Axis 6								
M2278	Axis 7								
M2279	Axis 8								
M2280	Axis 9								
M2281	Axis 10								
M2282	Axis 11								
M2283	Axis 12								
M2284	Axis 13								
M2285	Axis 14								
M2286	Axis 15								
M2287	Axis 16								
M2288	Axis 17								
M2289	Axis 18								
M2290	Axis 19								
M2291	Axis 20								
M2292	Axis 21								
M2293	Axis 22								
M2294	Axis 23								
M2295	Axis 24								
M2296	Axis 25								
M2297	Axis 26								
M2298	Axis 27								
M2299	Axis 28								
M2300	Axis 29								
M2301	Axis 30								
M2302	Axis 31								
M2303	Axis 32								
M2304	Unusable (16 points)					—	—	—	—
M2305									
M2306									
M2307									
M2308									
M2309									
M2310									
M2311									
M2312									
M2313									
M2314									
M2315									
M2316									
M2317									
M2318									
M2319									

4 POSITIONING DEDICATED SIGNALS

Explanation of the request register

No.	Function	Bit device	Request register
1	PLC ready flag	M2000	D704
2	Speed switching point specified flag	M2040	D705
3	All axes servo ON command	M2042	D706
4	Real/virtual mode switching request (SV22)	M2043	D707
5	JOG operation simultaneous start command	M2048	D708
6	Manual pulse generator 1 enable flag	M2051	D755
7	Manual pulse generator 2 enable flag	M2052	D756
8	Manual pulse generator 3 enable flag	M2053	D757

(Note-1) : The range of axis No.1 to 8 is valid in the Q172HCPU.

(Note-2) : Device area of 9 axes or more is unusable in the Q172HCPU.

(Note-3) : This signal is unusable in the SV22 real mode.

(Note-4) : Handling of D704 to D708 and D755 to D757 registers

Because cannot be turn ON/OFF for every bit from the PLC CPU, the above bit devices are assigned to D register, and each bit device becomes on with the lowest rank bit 0 → 1 of each register, and each bit device becomes off with 1 → 0.

Use it when the above functions are requested from the PLC CPU using the S(P).DDR and S(P).DDWR instruction. Refer to the "Q173HCPU/Q172HCPU Motion controller (SV13/SV22) Programming Manual (Motion SFC)" for the S(P).DDR and S(P).DDWR instruction.

The direct bit device ON/OFF is possible in the Motion SFC program.

(Note-5) : It can also be ordered the device of a remark column.

(Note-6) : M3080 does not turn off automatically. Turn it off as an user side.

CAUTION

- The data executed later becomes effective when the same device is executed in the Motion SFC program and PLC program.

4 POSITIONING DEDICATED SIGNALS

(11) Special relay allocated device list (Status)

Device No.	Signal name	Refresh cycle	Fetch cycle	Signal direction	Remark ^(Note-1)
M2320	Fuse blown detection	Error occurrence	/	Status signal	M9000
M2321	AC / DC DOWN detection				M9005
M2322	Battery low				M9006
M2323	Battery low latch				M9007
M2324	Self-diagnostic error				M9008
M2325	Diagnostic error				M9010
M2326	Always ON	Main operation			M9036
M2327	Always OFF	M9037			
M2328	Clock data error	Error occurrence			M9026
M2329	PCPU WDT error flag	M9073			
M2330	PCPU READY complete flag	At request			M9074
M2331	Test mode ON flag				M9075
M2332	External forced stop input flag	Operation cycle			M9076
M2333	Manual pulse generator axis setting error flag	Error occurrence			M9077
M2334	TEST mode request error flag				M9078
M2335	Servo program setting error flag				M9079
M2336	CPU No.1 reset flag	At status change			M9240
M2337	CPU No.2 reset flag				M9241
M2338	CPU No.3 reset flag				M9242
M2339	CPU No.4 reset flag				M9243
M2340	CPU No.1 error flag				M9244
M2341	CPU No.2 error flag		M9245		
M2342	CPU No.3 error flag		M9246		
M2343	CPU No.4 error flag		M9247		
M2344	Unusable	—	—	—	—
M2345	CPU No.1 MULTR complete flag	At instruction completion	/	Status signal	M9216
M2346	CPU No.2 MULTR complete flag				M9217
M2347	CPU No.3 MULTR complete flag				M9218
M2348	CPU No.4 MULTR complete flag				M9219
M2349 to M2399	Unusable (51 points)	—	—	—	—

(Note-1) : The same status as a remark column is output.

4 POSITIONING DEDICATED SIGNALS

(12) Common device list (Command signal)

Device No.	Signal name	Refresh cycle	Fetch cycle	Signal direction	Remark (Note-1), (Note-2)
M3072	PLC ready flag	/	Main cycle	Command signal	M2000
M3073	Speed switching point specified flag		At start		M2040
M3074	All axes servo ON command		Operation cycle		M2042
M3075	Real/virtual mode switching request (SV22)		At virtual mode transition		M2043
M3076	JOG operation simultaneous start command		Main cycle		M2048
M3077	Manual pulse generator 1 enable flag				M2051
M3078	Manual pulse generator 2 enable flag				M2052
M3079	Manual pulse generator 3 enable flag				M2053
M3080	Motion SFC error history clear request flag (Note-3)				M2035
M3081 to M3135	Unusable (55 points)	—	—	—	—

(Note-1) : The device of a remarks column turns ON by OFF to ON of the above device, and the device of a remarks column turns OFF by ON to OFF of the above device. The state of a device is not in agreement when the device of a remarks column is turned on directly. In addition, when the request from a data register and the request from the above device are performed simultaneously, the request from the above device becomes valid.

(Note-2) : It can also be ordered the device of a remark column.

(Note-3) : M3080 does not turn off automatically. Turn it off as an user side.

(13) Special relay allocated device list (Command signal)

Device No.	Signal name	Refresh cycle	Fetch cycle	Signal direction	Remark (Note-1), (Note-2)
M3136	Clock data set request	/	Main cycle	Command signal	M9025
M3137	Clock data read request				M9028
M3138	Error reset				M9060
M3139 to M3199	Unusable (61 points)	—	—	—	—

(Note-1) : The device of a remarks column turns ON by OFF to ON of the above device, and the device of a remarks column turns OFF by ON to OFF of the above device. The state of a device is not in agreement when the device of a remarks column is turned on directly.

(Note-2) : It can also be ordered the device of a remark column.

4 POSITIONING DEDICATED SIGNALS

4.1.1 Axis statuses

(1) In-position signal (M2402+20n) Status signal

- (a) This signal turns on when the number of droop pulses in the deviation counter becomes below the "in-position range" set in the servo parameters. It turns off at the start.

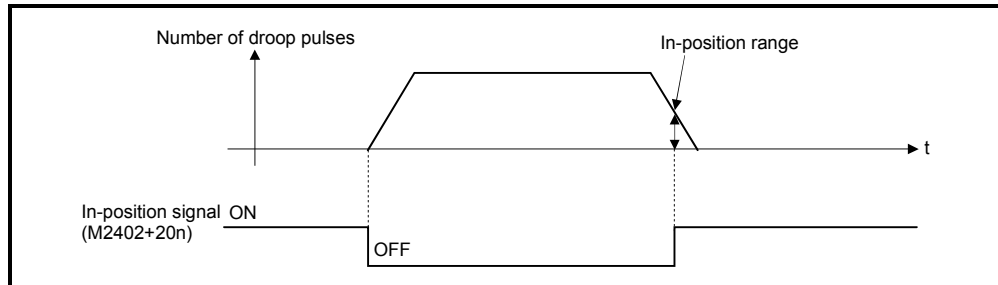

- (b) An in-position check is performed in the following cases.

- When the servo power supply is turned on.
- After the automatic deceleration is started during positioning control.
- After the deceleration is started with the JOG start signal OFF.
- During the manual pulse generator operation.
- After the proximity dog ON during a home position return.
- After the deceleration is started with the stop command.
- When the speed change to a speed "0" is executed.
- Anytime.....

} At real mode

} At virtual mode

(2) Zero pass signal (M2406+20n) Status signal

This signal turns on when the zero point is passed after the power supply on of the servo amplifier.

Once the zero point has been passed, it remains on state until the CPU has been reset.

However, in the home position return method of proximity dog, count, dog cradle or limit switch combined type, this signal turns off once at the home position return in real mode start and turns on again at the next zero point passage.

(3) Error detection signal (M2407+20n) Status signal

- (a) This signal turns on with detection of a minor error or major error, and it is used as judgement of the error available/not available.

The applicable error code ^(Note-1) is stored in the minor error code storage register with detection of a minor error. (Refer to Section 4.2.1 (4))

The applicable error code ^(Note-1) is stored in the major error code storage register with detection of a major error. (Refer to Section 4.2.1 (5))

4 POSITIONING DEDICATED SIGNALS

(b) This signal turns off when the error reset command (M3207+20n) turns on.

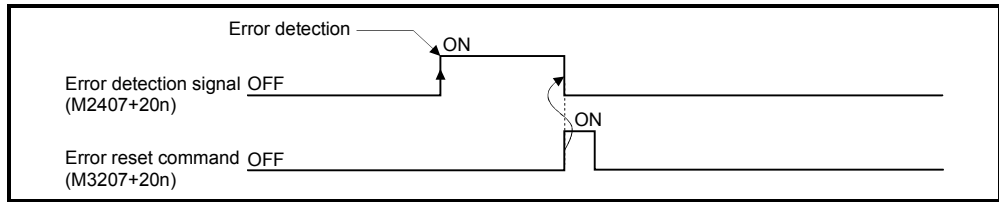

REMARK

(Note-1) : Refer to APPENDIX 2 for the error codes with detection of major/minor errors.

(4) Servo error detection signal (M2408+20n) Status signal

(a) This signal turns on when an error occurs at the servo amplifier side (except for errors cause of alarms and emergency stops) (Note-1), and it is used as judgement of the servo error available/not available.

When an error is detected at the servo amplifier side, the applicable error code (Note-1) is stored in the servo error code storage register (Refer to Section 4.2.1).

(b) This signal turns off when the servo error reset command (M3208+20n) turns on or the servo power supply turns on again.

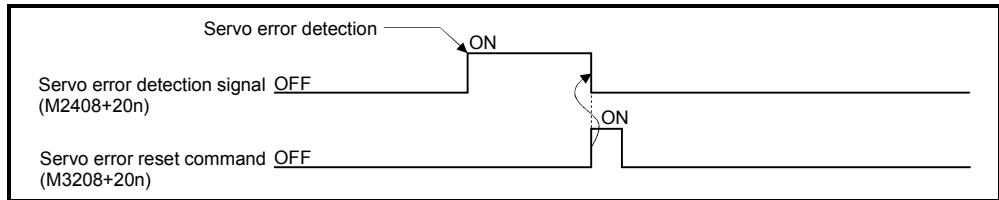

REMARK

(Note-1) : Refer to APPENDIX 2.5 for the error codes on errors detected at the servo amplifier side.

(5) Home position return request signal (M2409+20n)

..... Status signal

This signal turns on when it is necessary to confirm the home position address.

(a) When not using an absolute position system

1) This signal turns on in the following cases:

- Motion CPU power supply on or reset
- Servo amplifier power supply on
- Home position return start

(Unless a home position return is completed normally, the home position return request signal does not turn off.)

2) This signal turns off by the completion of home position return.

4 POSITIONING DEDICATED SIGNALS

(b) When using an absolute position system

1) This signal turns on in the following cases:

- When not executing a home position return once after system start.
- Home position return start
(Unless a home position return is completed normally, the home position return request signal does not turn off.)
- Erase of an absolute data in Motion CPU according to causes, such as battery error
- Servo error [2025] (absolute position erase) occurrence
- Servo error [2143] (absolute position counter warning) occurrence
- Major error [1203] or [1204] occurrence
- When the "rotation direction selection" of servo parameter is changed.

2) This signal turns off by the completion of the home position return.

 **CAUTION**

- When using the absolute position system function, on starting up, and when the Motion controller or absolute value motor has been replaced, always perform a home position return in real mode. In the case of the absolute position system, use the PLC program to check the home position return request before performing the positioning operation. Failure to observe this could lead to an accident such as a collision.

(6) Home position return complete signal (M2410+20n)

..... Status signal

- (a) This signal turns on when the home position return operation using the servo program has been completed normally.
- (b) This signal turns off at the positioning start, JOG operation start and manual pulse generator operation start.
- (c) If the home position return of proximity dog, dog cradle or stopper type using the servo program is executed during this signal on, the "continuous home position return start error (minor error: 115)" occurs and it cannot be start the home position return.

(7) FLS signal (M2411+20n) ^(Note-1) Status signal

- (a) This signal is controlled by the ON/OFF state for the upper stroke limit switch input (FLS) of the Q172LX/servo amplifier.
- Upper stroke limit switch input OFF FLS signal: ON
 - Upper stroke limit switch input ON FLS signal: OFF

4 POSITIONING DEDICATED SIGNALS

(b) The state for the upper stroke limit switch input (FLS) when the FLS signal is ON/OFF is shown below.

1) Q172LX use ^(Note-2)

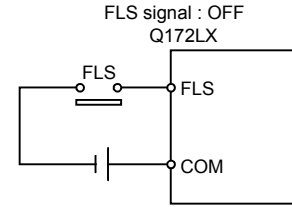
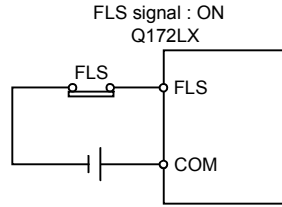

2) Servo amplifier input use ^(Note-3)

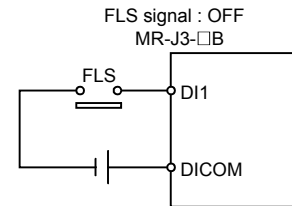
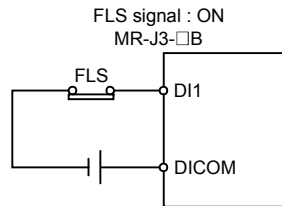

(Note-1): Refer to the "Q173HCPU/Q172HCPU Motion controller Programming Manual (COMMON)" for an external signal.

(Note-2): Refer to the "Q173HCPU/Q172HCPU User's Manual" for a pin configuration.

(Note-3): Refer to the "MR-J3-□B Servo Amplifier Instruction Manual" for a pin configuration.

(8) RLS signal (M2412+20n) ^(Note-1) Status signal

(a) This signal is controlled by the ON/OFF state for the lower stroke limit switch input (RLS) of the Q172LX/servo amplifier.

- Lower stroke limit switch input OFF RLS signal: ON
- Lower stroke limit switch input ON RLS signal: OFF

(b) The state of the lower stroke limit switch input (RLS) when the RLS signal is ON/OFF is shown below.

1) Q172LX use ^(Note-2)

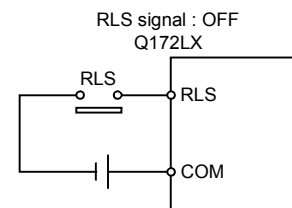
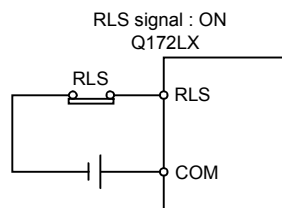

2) Servo amplifier input use ^(Note-3)



(Note-1): Refer to the "Q173HCPU/Q172HCPU Motion controller Programming Manual (COMMON)" for an external signal.

(Note-2): Refer to the "Q173HCPU/Q172HCPU User's Manual" for a pin configuration.

(Note-3): Refer to the "MR-J3-□B Servo Amplifier Instruction Manual" for a pin configuration.

(9) STOP signal (M2413+20n) Status signal

(a) This signal is controlled by the ON/OFF state for the stop signal input (STOP) of the Q172LX.

- Stop signal input of the Q172LX OFF STOP signal: OFF
- Stop signal input of the Q172LX ON STOP signal: ON

(b) The state of the stop signal input (STOP) of the Q172LX when the STOP signal input is ON/OFF is shown below.



(10) DOG/CHANGE signal (M2414+20n) ^(Note-1) Status signal

(a) This signal turns on/off by the proximity dog input (DOG) of the Q172LX/servo amplifier at the home position return in the real mode. This signal turns on/off by the speed/position switching input (CHANGE) of the Q172LX at the speed/position switching control in the real mode. (There is no CHANGE signal in the servo amplifier.)

(b) When using the Q172LX, "Normally open contact input" and "Normally closed contact input" of the system setting can be selected. The state of the speed/position switching input (CHANGE) when the CHANGE signal is ON/OFF is shown below.

1) Q172LX use ^(Note-2)



4 POSITIONING DEDICATED SIGNALS

2) Servo amplifier input use ^(Note-3)



(Note-1): Refer to the "Q173HCPU/Q172HCPU Motion controller Programming Manual (COMMON)" for an external signal.

(Note-2): Refer to the "Q173HCPU/Q172HCPU User's Manual" for a pin configuration.

(Note-3): Refer to the "MR-J3-□B Servo Amplifier Instruction Manual" for a pin configuration.

(11) Servo ready signal (M2415+20n) Status signal

(a) This signal turns on when the servo amplifiers connected to each axis are in the READY state.

(b) This signal turns off in the following cases.

- M2042 is off
- Servo amplifier is not installed
- Servo parameter is not set
- It is received the forced stop input from an external source
- Servo OFF by the servo OFF command (M3215+20n) ON
- Servo error occurs

Refer to APPENDIX 2.5 "Servo errors" for details.

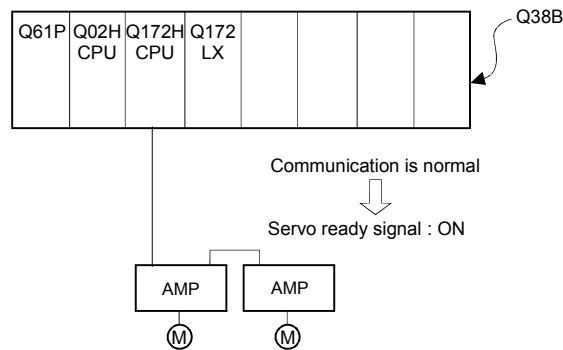

POINT

When the part of multiple servo amplifiers connected to the SSCNETⅢ becomes a servo error, only an applicable axis becomes the servo OFF state.

(12) Torque limiting signal (M2416+20n) Status signal

This signal turns on while torque limit is executed.

The signal toward the torque limiting axis turns on.

(13) Virtual mode continuation operation disable warning signal (M2418+20n) Status signal

When the difference between the final servo command value in previous virtual mode last time and the servo current value at virtual mode switching next time exceeds the "Allowable travel value during power off (× Number of feedback pulses)" set in the "System setting", "Virtual mode continuation operation disable warning signal device" of the applicable axis is turned on as warning of being uncontinuable in virtual mode operation.

It checks for the following cases.

No.	Check	Remark
1	Servo amplifier power supply ON for absolute axis.	<ul style="list-style-type: none"> • A minor error [901] (power supply on in real mode)/[9010] (power supply on in virtual mode) are also set.
2	Anytime during real mode operation.	<ul style="list-style-type: none"> • It also turns on at the following cases. <ol style="list-style-type: none"> 1) Home position return 2) Current value change 3) Fixed-pitch feed, speed control (I), (II) or speed/position switching control.

Reset the "Virtual mode continuation operation disable warning signal device" using the Motion SFC program.

4 POSITIONING DEDICATED SIGNALS

4.1.2 Axis command signals

(1) Error reset command (M3207+20n) Command signal

This command is used to clear the minor/major error code storage register of an axis for which the error detection signal has turn on (M2407+20n: ON), and reset the error detection signal (M2407+20n).

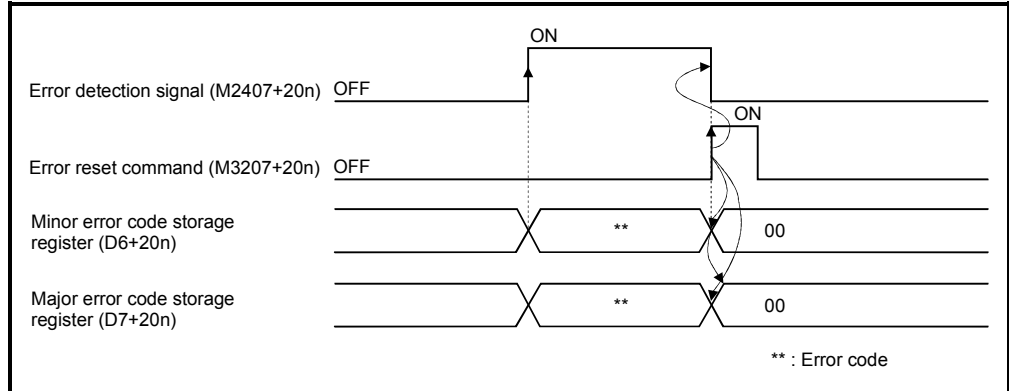

(2) Servo error reset command (M3208+20n) Command signal

This command is used to clear the servo error code storage register of an axis for which the servo error detection signal has turn on (M2408+20n: ON), and reset the servo error detection signal (M2408+20n).

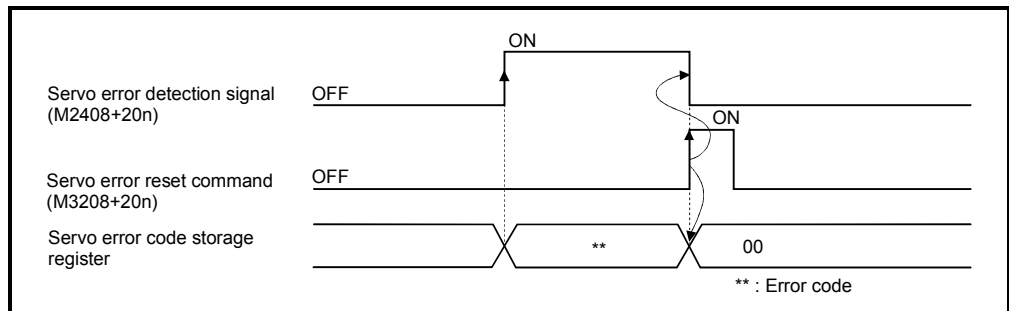

(3) Address clutch reference setting command (M3213+20n) Command signal

This signal is only effective when the output module is a cam connected an address mode clutch or a rotary table, and it is used to specify the "0" reference position for the current value within 1 virtual axis revolution.

The following processings are executed based on the ON/OFF state of the address clutch reference setting command at the switching request from real to virtual mode.

(a) M3213+20n : ON

Virtual mode operation starts as "0" for the current value within 1 virtual axis revolution of the main shaft and auxiliary input axis.

(b) M3213+20n : OFF

- If the drive module is a virtual servomotor or an incremental synchronous encoder, operation will be continued from the current value within 1 virtual axis revolution for the main shaft and auxiliary input axis in the previous virtual mode.
- If the drive module is an absolute synchronous encoder, operation will be continued from the current value within 1 virtual axis revolution for the main shaft and auxiliary input axis calculated from the current value of synchronous encoder.

(4) Cam reference position setting command (M3214+20n)

..... Command signal

This signal is only effective when the output module is a cam, and it is used to specify the cam reference position.

The following processings are executed based on the ON/OFF state of the cam reference position setting command at the switching request from real to virtual mode.

(a) M3214+20n : ON

- The current value is cam reference position.
- The current feed current value is lower stroke limit value (bottom dead point). Moreover, a cam table search is conducted from the beginning of a cycle, and the bottom dead point (0) is specified as the current value within 1 cam shaft revolution.

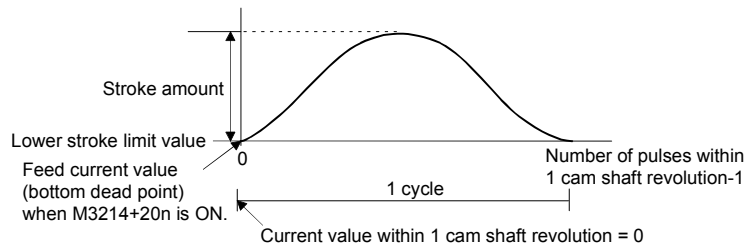

- After the bottom dead point alignment of cam is completed at the system start-up, it must be turned on at the first real to virtual mode switching. Once the bottom dead point setting is set, operation will be continued with M3214+20n ON by switching from real to virtual mode. (The bottom dead point position is stored in the backup memory.)

(b) M3214+20n : OFF

(Final servo command value in previous virtual mode operation) – (Current servo current value) ≤ (In-position)1)

- For formula 1)
Operation will be continued by making the lower stroke limit value and current value within 1 cam shaft revolution into the lower stroke limit value and current value within 1 cam shaft revolution at the previous virtual mode operation.

(Final servo command value in previous virtual mode operation) – (Current servo current value) > (In-position)2)

4 POSITIONING DEDICATED SIGNALS

- For formula 2)

Current value within 1 cam shaft revolution for current feed current value is calculated and operation will be continued by making the lower stroke limit value into the lower stroke limit value at the previous virtual mode operation.

[Calculation of current value within 1 cam shaft revolution]

$$\text{(Feed current value)} = \text{(Stroke amount)} \times \text{(Stroke ratio)} \times \text{(Lower stroke limit value)}$$

The stroke ratio(y) used as above formula is calculated, the cam table of the setting cam No. is searched from the beginning of a cycle, and the current value within 1 cam shaft revolution for applicable point is calculated.

Because the current value within 1 cam shaft revolution is searched always from the beginning of a cycle, beware of cases where the same stroke ratio appears more than once in the cycle.

(Make the necessary position adjustment at the switching from the real to virtual mode.)

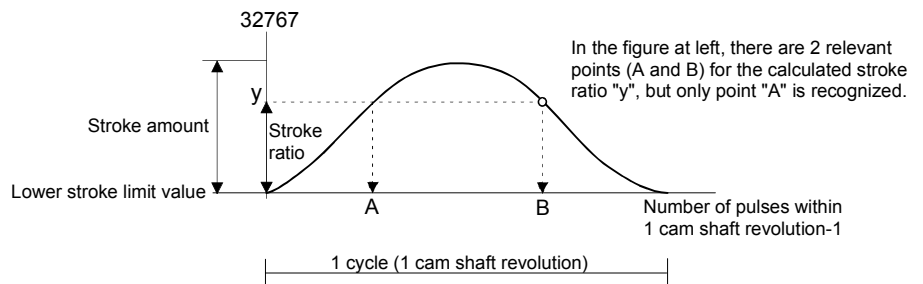

(5) Servo OFF command (M3215+20n) Command signal

This command is used to execute the servo OFF state (free run state).

- M3215+20n : OFF Servo ON
- M3215+20n : ON Servo OFF (free run state)

This command becomes invalid during positioning, and should therefore be executed after completion of positioning.

When the servo OFF command is executed in virtual mode, the clutch will be disengaged first. If it is executed while a "clutch ON" state, a minor error occurs and the servo OFF command becomes invalid.

! CAUTION

- Turn the power supply of the servo amplifier side off before touching a servomotor, such as machine adjustment.

4 POSITIONING DEDICATED SIGNALS

(6) Gain changing command (M3216+20n)Command signal

This signal is used to change the gain of servo amplifier in the Motion controller by the gain changing command ON/OFF.

- ON Gain changing command ON
- OFF Gain changing command OFF

Refer to the "MR-J3-□B Servo Amplifier Instruction Manual" for details of gain changing function.

Instruction Manual list is shown below.

Servo amplifier type	Instruction manual name
MR-J3-□B	MR-J3-□B Servo Amplifier Instruction Manual (SH-030051)

(7) Control loop changing command (M3216+20n)

..... Command signal

When using the fully closed loop control servo amplifier, this signal is used to change the fully closed loop control/semi closed loop control of servo amplifier in the Motion controller by the control loop changing command ON/OFF.

- ON During fully closed loop control
- OFF During semi closed loop control

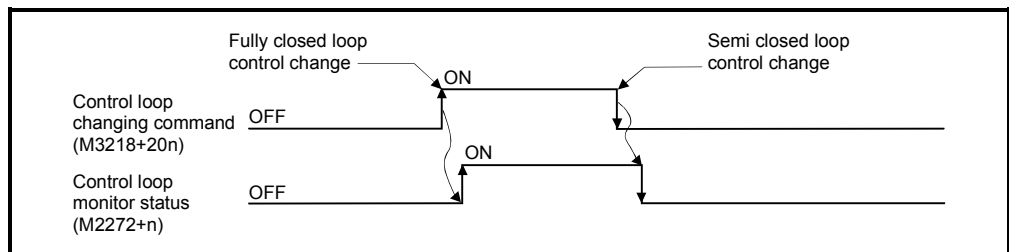

Refer to the "Fully closed loop control MR-J3-□B-RJ006 Servo Amplifier Instruction Manual" for details of control loop changing.

Instruction Manual list is shown below.

Servo amplifier type	Instruction manual name
MR-J3-□B-RJ006	Fully closed loop control MR-J3-□B-RJ006 Servo Amplifier Instruction Manual (SH-030056)

POINTS

- (1) When the servo amplifier is not started (LED: "AA", "Ab", "AC", "Ad" or "AE"), if the control loop changing command is turned ON/OFF, the command becomes invalid.
- (2) When the followings are operated during the fully closed loop, it returns to the semi closed loop control.
 - (a) Power supply ON or reset of the Motion CPU
 - (b) Wire breakage of the SSCNET III cable between the servo amplifier and Motion controller
 - (c) Control circuit power supply OFF of the servo amplifier

REMARK

It can be use in the SW6RN- SV22Q□ (Ver.00D or later).

4 POSITIONING DEDICATED SIGNALS

4.1.3 Virtual servomotor axis statuses

(1) Positioning start complete signal (M4000+20n) (Note-1)

..... Status signal

(a) This signal turns on with the start completion for the positioning control of the axis specified with the servo program. It does not turn on at the starting using JOG operation or speed control.

It can be used to read a M-code (Note-2) at the positioning start.

(b) This signal turns off at turning the complete signal OFF command (M4804+20n) (Note-1) off to on or positioning completion.

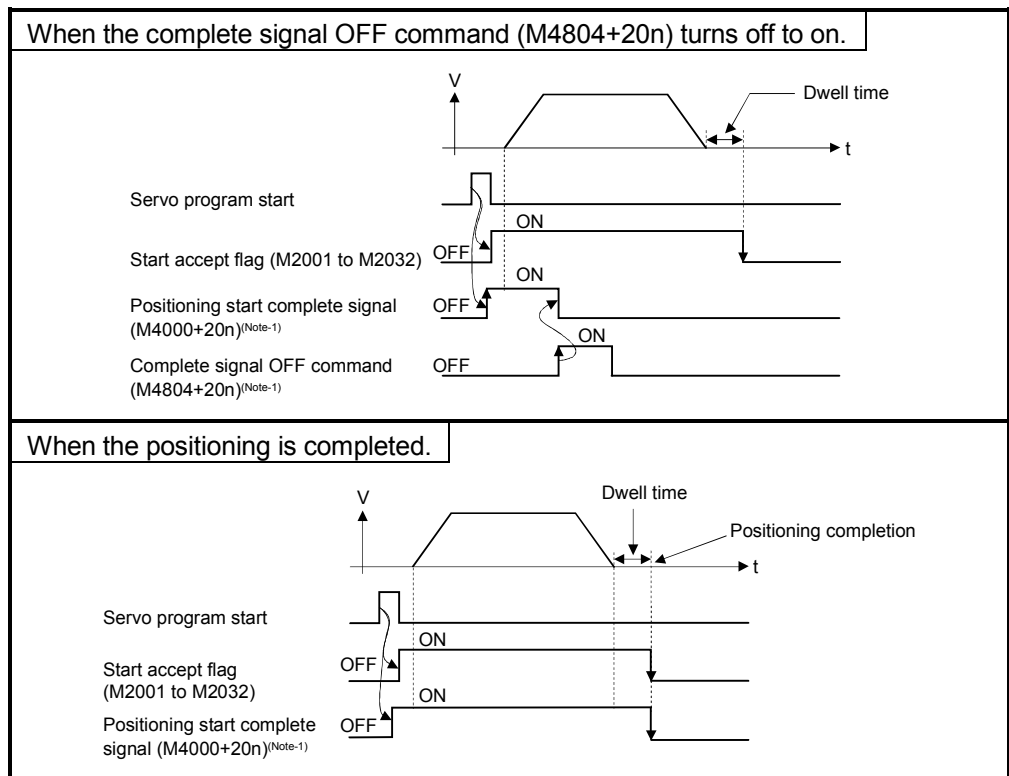

4 POSITIONING DEDICATED SIGNALS

REMARK

(Note-1) : In the front page descriptions, "n" in "M4000+20n" or "M4804+20n" etc. indicates a value corresponding to axis No. such as the following tables.

Axis No.	n	Axis No.	n	Axis No.	n	Axis No.	n
1	0	9	8	17	16	25	24
2	1	10	9	18	17	26	25
3	2	11	10	19	18	27	26
4	3	12	11	20	19	28	27
5	4	13	12	21	20	29	28
6	5	14	13	22	21	30	29
7	6	15	14	23	22	31	30
8	7	16	15	24	23	32	31

- Calculate as follows for the device No. corresponding to each axis.

(Example) For axis 32

$$M4000+20n \text{ (Positioning start complete)} = M4000+20 \times 31 = M4620$$

$$M4804+20n \text{ (Complete signal OFF command)} = M4804+20 \times 31 = M5424$$

- The range (n=0 to 7) of axis No.1 to 8 is valid in the Q172HCPU.

(Note-2) : Refer to Section "7.1 M-code Output Function" of the "Q173HCPU/Q172HCPU Motion controller (SV13/SV22) Programming manual (REAL MODE)".

(2) Positioning complete signal (M4001+20n) Status signal

(a) This signal turns on with the completion for the positioning control of the axis specified with the servo program.

It does not turn on at the start or stop on the way using JOG operation or speed control.

It does not turn on at the stop on the way during positioning.

It can be used to read a M-code at the positioning completion.

(Refer to Section 7.1 of the "Q173HCPU/Q172HCPU Motion controller (SV/13/SV22) Programming Manual (REAL MODE)".)

(b) This signal turns off at turning the complete signal OFF command (M4804+20n) off to on or positioning start.

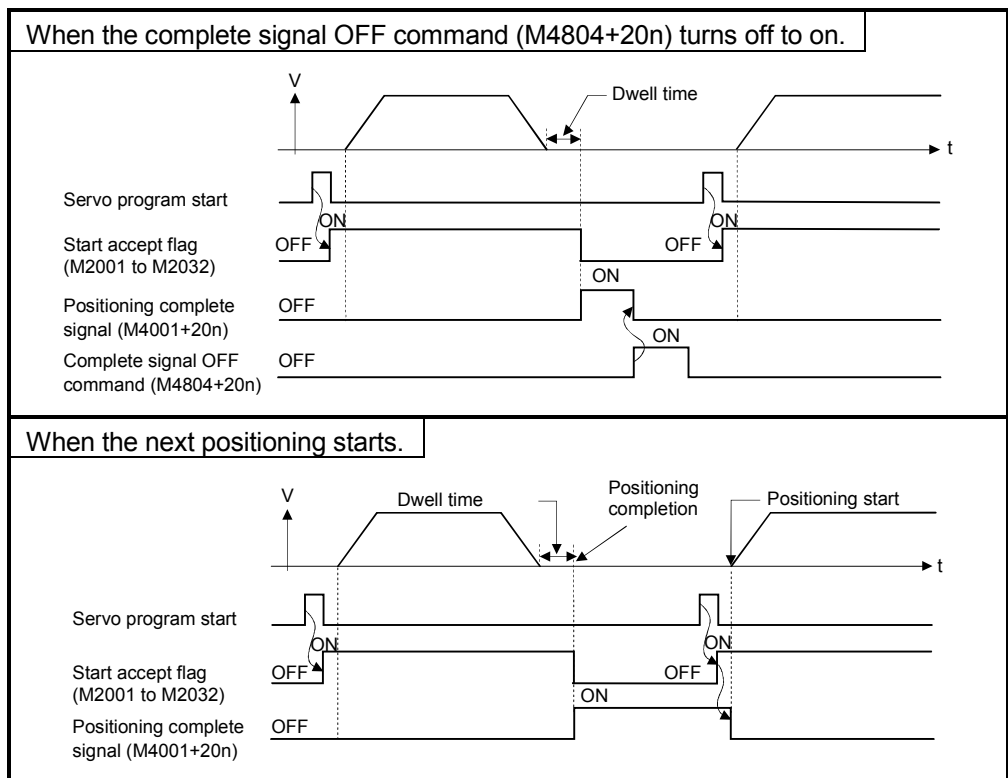

(3) Command in-positioning signal (M4003+20n) Status signal

(a) This signal turns on when the absolute value of the difference between the command position and the feed current value becomes below the "command in-position range" set in the parameters of virtual servomotor (Refer to Section 6.1.2).

This signal turns off in the following cases.

- Positioning control start
- Speed control
- JOG operation

4 POSITIONING DEDICATED SIGNALS

- (b) Command in-position check is continually executed during position control. This check is not executed during speed control.

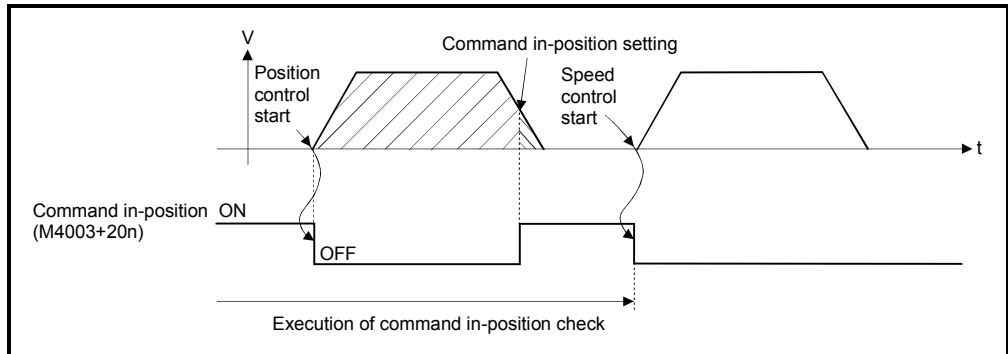

(4) Speed controlling signal (M4004+20n) Status signal

- (a) This signal turns on during speed control, and it is used as judgement of during the speed control or position control. The speed controlling signal that turned on with speed control turns off at the positioning control start of following figure.

- (b) This signal turns off at the power supply on and during position control.

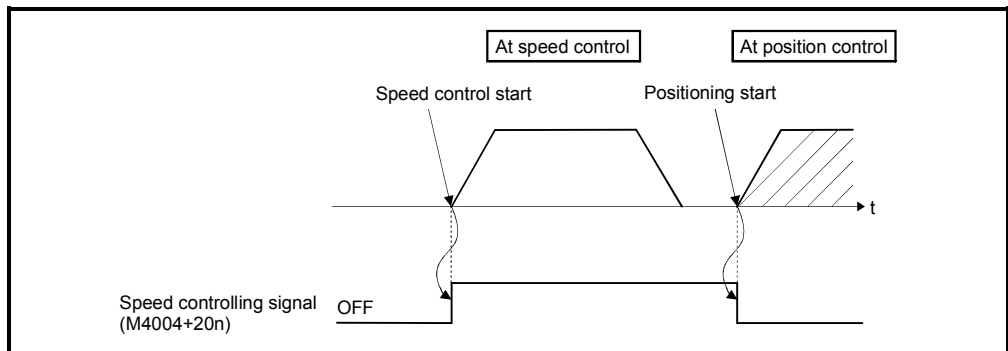

(5) Error detection signal (M4007+20n) Status signal

- (a) This signal turns on when a minor error or major error is detected in a virtual servomotor or output module connected to a virtual servomotor. It is used as judgement of the error available/not available by turning the error detection signal on/off.

- (b) When the error detection signal turns on, the applicable error code is stored in the error code storage register.

- Minor error code ^(Note-1) ... Stored in the minor error code storage register _(Note-2).
- Major error code ^(Note-1) ... Stored in the major error code storage register _(Note-2).

The judgement of the virtual servomotor/output module for detected error can be confirmed by the error code details or turning the error detection signal of output module on/off.

4 POSITIONING DEDICATED SIGNALS

- (c) When the error reset command (M4807+20n) turns on in the state where the virtual servomotor or output module connected to the virtual servomotor turns on is normal, the error detection signal turns off.

REMARK

(Note-1) : Refer to APPENDIX 2.4 for details of the virtual servomotor minor/major error codes.

Refer to APPENDIX 2.7 for details of the output module minor/major error codes.

(Note-2) : Refer to Section 4.2.3 for details of the minor/major error code storage register.

(6) M-code outputting signal (M4019+20n) Status signal

(a) This signal turns during M-code is outputting.

(b) This signal turns off when the stop command, cancel signal, skip signal or FIN signal are inputted.

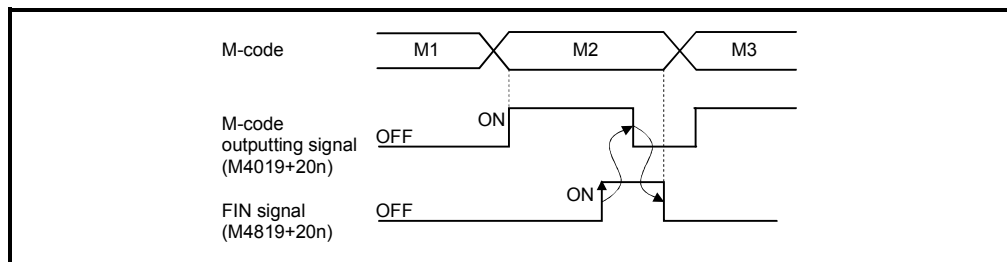

POINT

- (1) The FIN signal and M-code outputting signal are both signal for the FIN signal wait function.
- (2) The FIN signal and M-code outputting signal are effective only when FIN acceleration/deceleration is designated in the servo program. Otherwise, the FIN signal wait function is disabled, and the M-code outputting signal does not turn on.

4 POSITIONING DEDICATED SIGNALS

4.1.4 Virtual servomotor axis command signals

(1) Stop command (M4800+20n) (Note-1) Command signal

- (a) This command stops a starting axis from an external source and becomes effective at the turning signal off to on. (An axis for which the stop command is turning on cannot be started.)

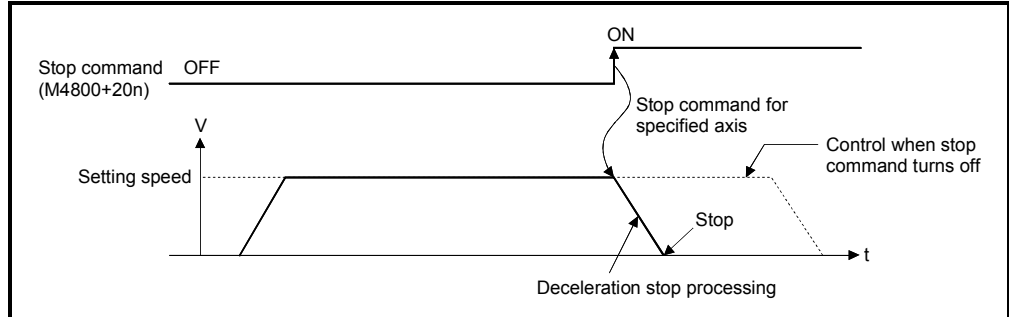

- (b) It can also be used as the stop command during the speed control. (Refer to Section "6.13 Speed Control (I)" of the "Q173HCPU/Q172HCPU Motion controller (SV13/SV22) Programming Manual (REAL MODE)" for details of the speed control.

- (c) Stop processing details when the stop command turned on is shown in Table 4.1.

Table 4.1 Stop Processing at Stop command ON

Control details during execution	Processing at the turning stop command on	
	During control	During deceleration stop processing
Positioning control	The axis decelerates to a stop in the deceleration time set in the parameter block or servo program.	The stop command is ignored and deceleration stop processing is continued.
Speed control		
JOG operation		

- (d) The stop command in a dwell time is invalid. (After a dwell time, the start accept flag (M2001+n) turns OFF, and the positioning complete signal (M4001+20n) turns ON.)

4 POSITIONING DEDICATED SIGNALS

REMARK

(Note-1) : In the above descriptions, "n" in "M4800+20n", etc. indicates a value corresponding to axis No. such as the following tables.

Axis No.	n	Axis No.	n	Axis No.	n	Axis No.	n
1	0	9	8	17	16	25	24
2	1	10	9	18	17	26	25
3	2	11	10	19	18	27	26
4	3	12	11	20	19	28	27
5	4	13	12	21	20	29	28
6	5	14	13	22	21	30	29
7	6	15	14	23	22	31	30
8	7	16	15	24	23	32	31

• Calculate as follows for the device No. corresponding to each axis.

(Example) For axis 32

$$M4800+20n \text{ (Stop command)} = M4800+20 \times 31 = M5420$$

• The range (n=0 to 7) of axis No.1 to 8 is valid in the Q172HCPU.

(2) Rapid stop command (M4801+20n) Command signal

(a) This command is a signal which stop a starting axis rapidly from an external source and becomes effective when the signal turns off to on. (An axis for which the rapid stop command turns on cannot be started.)

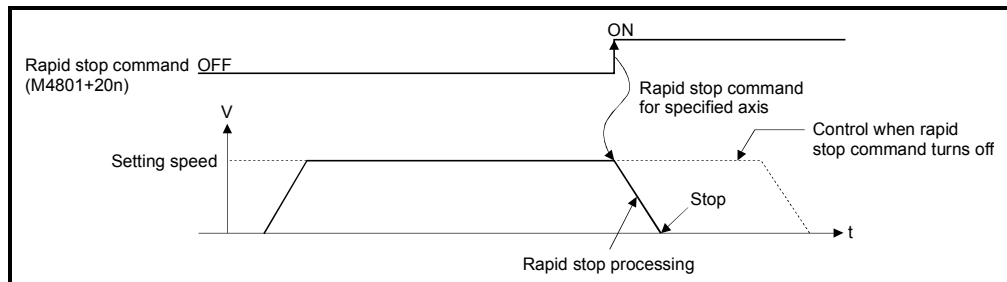

(b) The details of stop processing when the rapid stop command turns on are shown in Table 4.2.

4 POSITIONING DEDICATED SIGNALS

Table 4.2 Details of stop processing when the rapid stop command turns on

Control details during execution	Processing at the turning rapid stop command on	
	During control	During deceleration stop processing
Positioning control	Rapid stop processing is executed.	Deceleration processing is stopped and rapid stop processing is executed.
Speed control		
JOG operation		

- (c) The rapid stop command in a dwell time is invalid. (After a dwell time, the start accept flag (M2001+n) turns OFF, and the positioning complete signal (M4001+20n) turns ON.)

REMARK

(Note-1) : Rapid stop processing is deceleration stop with deceleration time set in the parameter block or servo program.

- (3) Forward rotation JOG start command (M4802+20n)/Reverse rotation JOG start command (M4803+20n) Command signal
- (a) JOG operation to the address increase direction is executed while forward rotation JOG start command (M4802+20n) is turning on.
When M4802+20n is turned off, a deceleration stop is executed in the deceleration time set in the parameter block.
- (b) JOG operation to the address decrease direction is executed while reverse rotation JOG start command (M4803+20n) is turning on.
When M4803+20n is turned off, a deceleration stop is executed in the deceleration time set in the parameter block.

POINT

Take an interlock so that the forward rotation JOG start command (M4802+20n) and reverse rotation JOG start command (M4803+20n) may not turn on simultaneously.

(4) Complete signal OFF command (M4804+20n)

..... Command signal

- (a) This command is used to turn off the positioning start complete signal (M4000+20n) and positioning complete signal (M4001+20n).

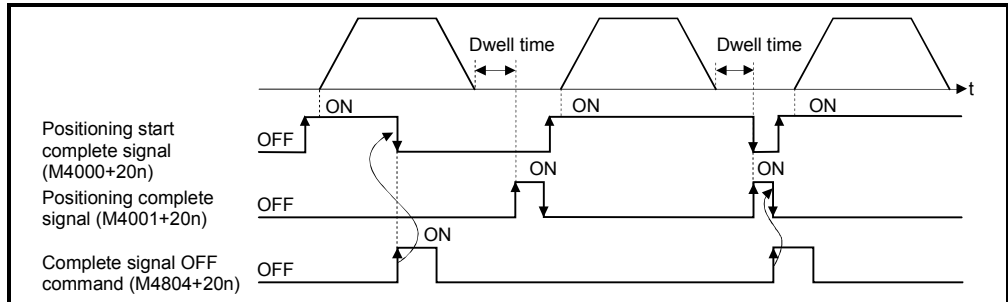

POINT

Do not turn the complete signal OFF command on with a PLS instruction. If it is turned on with a PLS instruction, it cannot be turned off the positioning start complete signal (M4000+20n) and the positioning complete signal (M4001+20n).

(5) Error reset command (M4807+20n) Command signal

- (a) This command is used to clear the minor/major error code storage register of an axis for which the error detection signal has turn on (M4007+20n : ON), and reset the error detection signal (M4007+20n).

- (b) The following processing is executed when the error reset command turns on.

- If the virtual servomotor and output module are normal, the minor/major error code storage registers are cleared and the error detection signal (M4007+20n) is reset.
- If the virtual servomotor and output module error has not been canceled, the error code is again stored in the minor/major error code storage register.

In this case, the error detection signal (M4007+20n) remains on.

(6) External stop input disable at start command (M4809+20n)

..... Command signal

This command is used to set the external stop signal input valid or invalid.

- ON..... External stop input is set as invalid, and even axes which stop input is turning on can be started.
- OFFExternal stop input is set as valid, and axes which stop input is turning on cannot be started.

POINT

When it stops an axis with the external stop input after it starts by turning on the external stop input disable at command (M4809+20n), switch the external stop input from OFF → ON (If the external stop input is turning on at the starting, switch it from ON → OFF → ON).

4 POSITIONING DEDICATED SIGNALS

(7) FIN signal (M4819+20n) Command signal

When a M-code is set in a servo program, transit to the next block does not execute until the FIN signal changes as follows: OFF → ON → OFF. Positioning to the next block begins after the FIN signal changes as above.

It is effective, only when the FIN acceleration/deceleration is set and FIN signal wait function is selected.

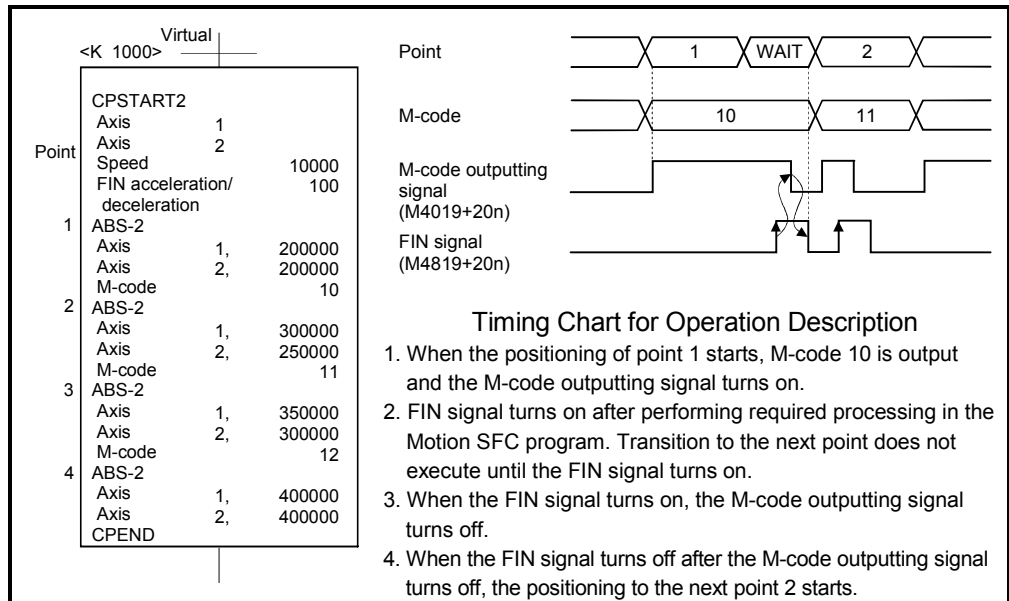

POINT

- (1) The FIN signal and M-code outputting signal are both signal for the FIN signal wait function.
- (2) The FIN signal and M-code outputting signal are valid only when FIN acceleration/deceleration is designated in the servo program. Otherwise, the FIN signal wait function is disabled, and the M-code outputting signal does not turn on.

4.1.5 Synchronous encoder axis statuses

- (1) Error detection signal (M4640+4n) ^(Note-1) Status signal
- (a) This signal turns on when a minor error or major error is detected in a synchronous encoder or output module connected to the synchronous encoder.
It is used as judgement of the error available/not available by turning the error detection signal on/off.
- (b) When the error detection signal turns on, the applicable error code is stored in the error code storage register.
- Minor error code ^(Note-2) ... Stored in the minor error code storage register ^(Note-3).
 - Major error code ^(Note-2) ... Stored in the major error code storage register ^(Note-3).
- The judgement of the synchronous encoder/output module for detected error can be confirmed by the error code details or turning the error detection signal of output module on/off.
- (c) When the error reset command (M5440+4n) turns on in the state where the synchronous encoder or output module connected to the synchronous encoder is normal, the error detection signal turns off.
- (2) External signal TREN (M4641+4n) ^(Note-1) Status signal
- (a) This signal is used for clutch control in the external input mode. It turns on by turning on the Q172EX/Q173PX "TREN" input terminal, and indicates the input ON/OFF state of the "TREN" terminal.
- (3) Virtual mode continuation operation disabled warning signal (M4642+4n) ^(Note-1) Status signal
- (a) When the inputted current value at the power supply on of the Multiple CPU system differs from the memorized current value (Final current value in virtual mode operation) at the power supply off of the Multiple CPU system, like the absolute synchronous encoder is moved during the power supply off of the Multiple CPU system, this signal turns on.
The validity of continuation operation in virtual mode can be confirmed at the power supply on or resetting of the Multiple CPU system.

4 POSITIONING DEDICATED SIGNALS

REMARK

(Note-1) : "n" in M4640+4n, M4641+4n and M4642+4n indicates a value corresponding to the synchronous encoder No. such as the following tables.

Synchronous encoder No.	n	Synchronous encoder No.	n
P1 / E1	0	P7 / E7	6
P2 / E2	1	P8 / E8	7
P3 / E3	2	P9 / E9	8
P4 / E4	3	P10 / E10	9
P5 / E5	4	P11 / E11	10
P6 / E6	5	P12 / E12	11

• The range of synchronous encoder No. P1/E1 to P8/E8 is valid in the Q172HCPU.

(Note-2) : Refer to APPENDIX 2.4 for details of the minor/major error code for the synchronous encoder.

Refer to APPENDIX 2.7 for details of the minor/major error code for the output module.

(Note-3) : Refer to Section 4.2.5 for details of the minor/major error code storage register.

4.1.6 Synchronous encoder axis command signals

- (1) Error reset command (M5440+4n) Command signal
- (a) This command is used to clear the minor/major error code storage register of synchronous encoder of an axis for which the error detection signal has turn on (M4640+4n : ON), and reset the error detection signal (M4640+4n).
- (b) The following processing is executed when the error reset command turns on.
- If the synchronous encoder and output module are normal, the minor/major error code storage registers are cleared and the error detection signal (M4640+4n) is reset.
 - If the synchronous encoder and output module error has not been canceled, the error code is again stored in the minor/major error code storage register.
In this case, the error detection signal (M4640+4n) remains on.

4.1.7 Cam axis command signals

(1) Cam/ball screw switching command (M5488+n)

..... Command signal

- (a) This command is used when a cam is set as output module in the mechanical system program.

Cam executes the same operation as a ball screw by turning ON the cam/ball screw switching command corresponding to each output axis No..

- OFF Specified cam pattern operation
- ON Same operation as ball screw

(Command to servo amplifier [PLS] = Preset command to servo amplifier + Drive module travel value [PLS] × Electronic gear ratio)

Feed current value is calculated based on the travel value per pulse set in the fixed parameter.

Therefore, it is invalid to turn ON the cam/ball screw switching command to axis that except cam axis is set as output module.

If the cam/ball screw switching command is turned OFF outside the range of "lower stroke limit value to stroke amount for cam", a minor error (error code: 5000) will occur.

The current value within 1 cam shaft revolution is calculated based on the feed current value, lower stroke limit value, stroke amount and cam No. (cam pattern) by turning OFF the cam/ball screw switching command.

4 POSITIONING DEDICATED SIGNALS

4.1.8 Smoothing clutch complete signals

(1) Smoothing clutch complete signals (M5520+2n, M5521+2n)

..... Status signal

(a) ON/OFF state of smoothing clutch is indicated. (Only exponential function system and linear acceleration/deceleration system^(Note-1) are valid.)

- ON "(Remainder slippage) < (Slippage in-position range)"
- OFF.... Smoothing processing start (Clutch ON/OFF)

(b) Set the slippage in-position range setting device^(Note-2) to use the smoothing clutch complete signal.

• Smoothing clutch complete signals are shown below.

Connected module		Applicable device	Connected module		Applicable device
Output module for axis 1	Main shaft side	M5520	Output module for axis 17	Main shaft side	M5552
	Auxiliary input axis side	M5521		Auxiliary input axis side	M5553
Output module for axis 2	Main shaft side	M5522	Output module for axis 18	Main shaft side	M5554
	Auxiliary input axis side	M5523		Auxiliary input axis side	M5555
Output module for axis 3	Main shaft side	M5524	Output module for axis 19	Main shaft side	M5556
	Auxiliary input axis side	M5525		Auxiliary input axis side	M5557
Output module for axis 4	Main shaft side	M5526	Output module for axis 20	Main shaft side	M5558
	Auxiliary input axis side	M5527		Auxiliary input axis side	M5559
Output module for axis 5	Main shaft side	M5528	Output module for axis 21	Main shaft side	M5560
	Auxiliary input axis side	M5529		Auxiliary input axis side	M5561
Output module for axis 6	Main shaft side	M5530	Output module for axis 22	Main shaft side	M5562
	Auxiliary input axis side	M5531		Auxiliary input axis side	M5563
Output module for axis 7	Main shaft side	M5532	Output module for axis 23	Main shaft side	M5564
	Auxiliary input axis side	M5533		Auxiliary input axis side	M5565
Output module for axis 8	Main shaft side	M5534	Output module for axis 24	Main shaft side	M5566
	Auxiliary input axis side	M5535		Auxiliary input axis side	M5567
Output module for axis 9	Main shaft side	M5536	Output module for axis 25	Main shaft side	M5568
	Auxiliary input axis side	M5537		Auxiliary input axis side	M5569
Output module for axis 10	Main shaft side	M5538	Output module for axis 26	Main shaft side	M5570
	Auxiliary input axis side	M5539		Auxiliary input axis side	M5571
Output module for axis 11	Main shaft side	M5540	Output module for axis 27	Main shaft side	M5572
	Auxiliary input axis side	M5541		Auxiliary input axis side	M5573
Output module for axis 12	Main shaft side	M5542	Output module for axis 28	Main shaft side	M5574
	Auxiliary input axis side	M5543		Auxiliary input axis side	M5575
Output module for axis 13	Main shaft side	M5544	Output module for axis 29	Main shaft side	M5576
	Auxiliary input axis side	M5545		Auxiliary input axis side	M5577
Output module for axis 14	Main shaft side	M5546	Output module for axis 30	Main shaft side	M5578
	Auxiliary input axis side	M5547		Auxiliary input axis side	M5579
Output module for axis 15	Main shaft side	M5548	Output module for axis 31	Main shaft side	M5580
	Auxiliary input axis side	M5549		Auxiliary input axis side	M5581
Output module for axis 16	Main shaft side	M5550	Output module for axis 32	Main shaft side	M5582
	Auxiliary input axis side	M5551		Auxiliary input axis side	M5583

(Note) : The range of output module for axis No. 1 to 8 is valid in the Q172HCPU.

4 POSITIONING DEDICATED SIGNALS

(c) Operation for smoothing clutch

1) Exponential function system

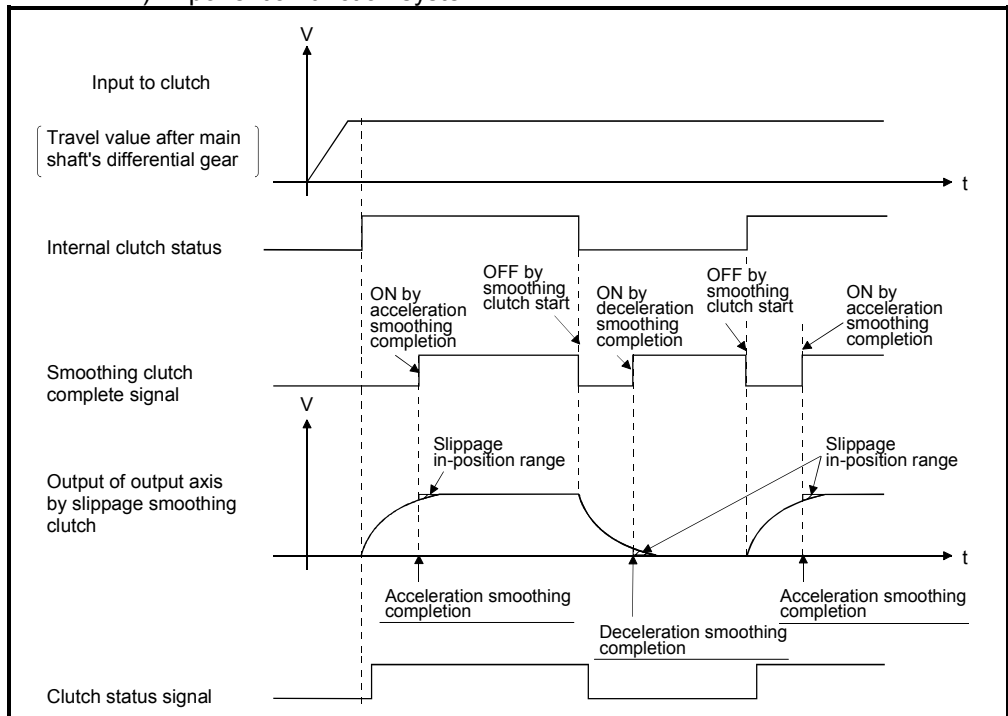

2) Linear acceleration/deceleration system

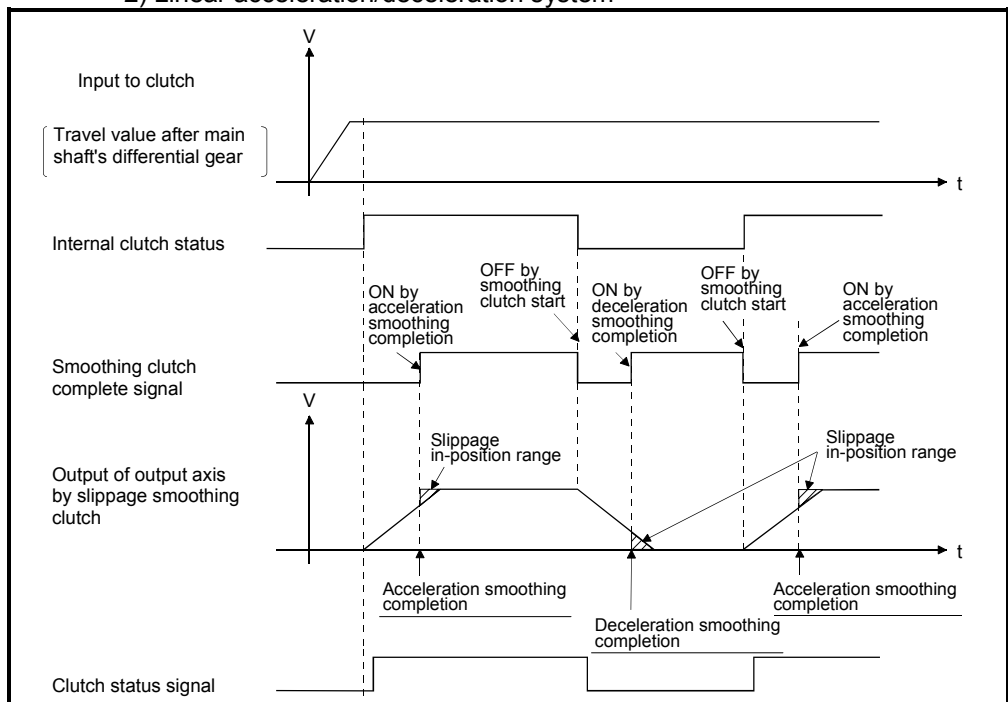

REMARK

(Note-1) : Refer to Section 7.2 for exponential function system/linear acceleration/deceleration system of smoothing clutch.

(Note-2) : Refer to Section 7.2.2 for slippage in-position range setting device.

4 POSITIONING DEDICATED SIGNALS

4.1.9 Common devices

POINT
(1) Internal relays for positioning control are not latched even within the latch range. In this manual, in order to indicate that internal relays for positioning control are not latched, the expression used in this text is "M2000 to M2319".
(2) The range devices allocated as internal relays for positioning control cannot be used by the user even if their applications have not been set.

- (1) PLC ready flag (M2000) Command signal
- (a) This signal informs the Motion CPU that the PLC CPU is normal.
- 1) The positioning control, home position return or JOG operation using the servo program which performs the Motion SFC program when the M2000 is ON.
 - 2) The above 1) control is not performed even if the M2000 is turned on during the test mode [TEST mode ON flag (M9075) : ON] using a peripheral device.
- (b) The setting data such as the fixed parameters, servo parameters and limit switch output data can be changed using a peripheral device when the M2000 is OFF only.
The above data using a peripheral device cannot be written when the M2000 is ON.
- (c) The following processings are performed when the M2000 turns OFF to ON.
- 1) Processing details
 - Clear the M-code storage area of all axes.
 - Turn the PCPU READY complete flag (M9074) on.
(Motion SFC program can be executed.)
 - Start to execute the Motion SFC program of the automatic starting from the first.
 - 2) If there is a starting axis, an error occurs, and the processing in above (c) 1) is not executed.
 - 3) The processing in above (c) 1) is not executed during the test mode.
It is executed when the test mode is cancelled and M2000 is ON.

4 POSITIONING DEDICATED SIGNALS

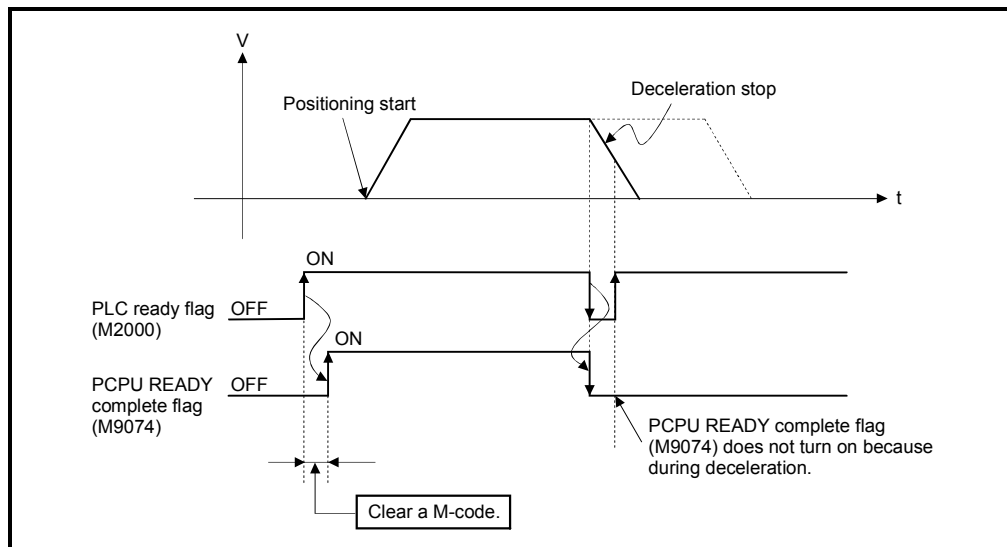

(d) The following processings are performed when the M2000 turns ON to OFF.

1) Processing details

- Turn the PCPU READY complete flag (M9074) off.
- Deceleration stop of the starting axis.
- Stop to execute the Motion SFC program.
- Turn all points of the real output PY off.

(e) Operation setting at STOP → RUN

The condition which the PLC ready flag (M2000) turns on is set in the system setting. Select the following either.

1) M2000 turns on by the switch (STOP → RUN). (Default)

The condition which M2000 turns OFF to ON.

- Move the RUN/STOP switch from STOP to RUN.
- Turn the power supply on or release to reset where the RUN/STOP switch is moved to RUN.

The condition which M2000 turns ON to OFF.

- Move the RUN/STOP switch from RUN to STOP.

2) M2000 turns on by set "1" to the switch (STOP → RUN) + setting register.

(M2000 is turned on by set "1" to the switch RUN \wedge setting register.)

The condition which M2000 is turned ON to OFF.

- Set "1" to the setting register (D704) of the PLC ready flag where the RUN/STOP switch is moved to RUN. (The Motion CPU detects the change of the lowest rank bit 0 → 1 in D704.)

The condition which M2000 is turned on to off.

- Set "0" to the setting register (D704) of the PLC ready flag where the RUN/STOP switch is moved to RUN. (The Motion CPU detects the change of the lowest rank bit 1 → 0 in D704.)
- Move the RUN/STOP switch from RUN to STOP.

4 POSITIONING DEDICATED SIGNALS

(2) Virtual servo start accept flag (M2001 to M2032)

..... Status signal

(a) This flag turns on when the servo program is started. The start accept flag corresponding to an axis specified with the servo program turns on.

(b) The ON/OFF processing of the start accept flag is shown below.

- 1) When the servo program is started using the Motion SFC program or Motion dedicated PLC instruction (S(P).SVST), the start accept flag corresponding to an axis specified with the servo program turns on and it turns off at the positioning completion. This flag also turns off when it is made to stopping on the way. (When it is made to stop on the way by the speed change to speed "0", this flag remains on.)

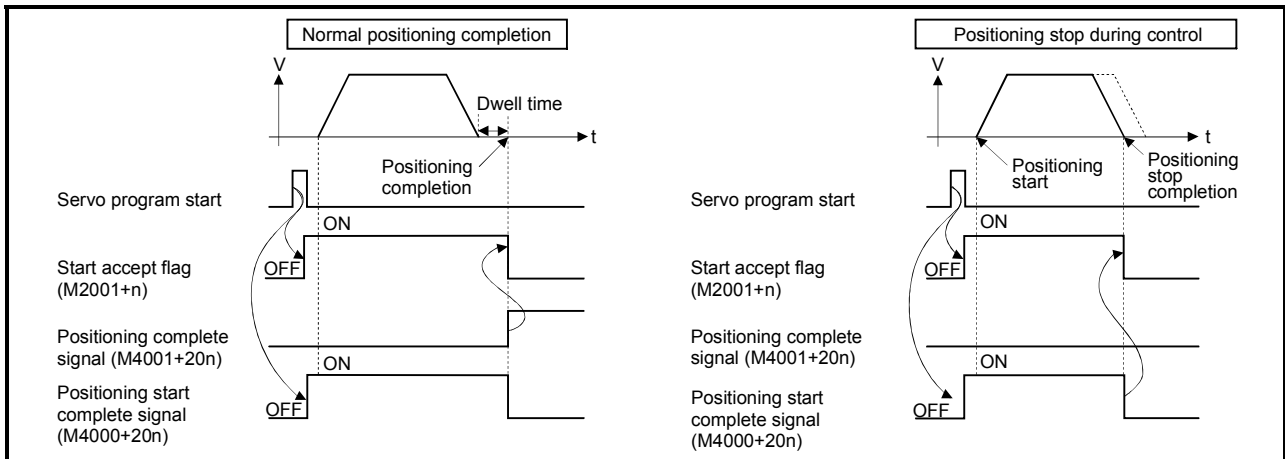

- 2) This flag turns on at the positioning control by turning on the JOG start command (M4802+20n or M4803+20n), and turns off at the positioning stop by turning off the JOG start command.
- 3) This flag turns on during the manual pulse generator enable (M2051 to M2053: ON), and turns off at the manual pulse generator disable (M2051 to M2053: OFF).
- 4) This flag turns on during a current value change by the CHGA instruction of servo program or Motion dedicated PLC instruction (S(P).CHGA), and turns off at the completion of the current value change.

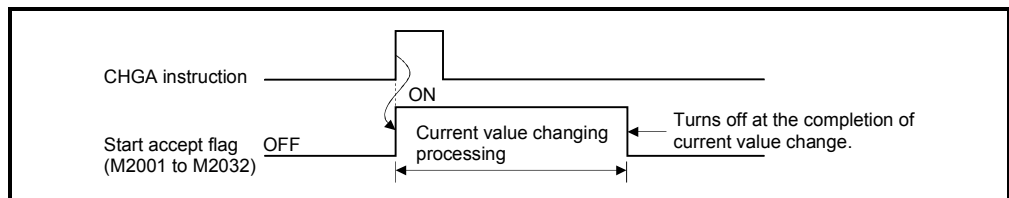

4 POSITIONING DEDICATED SIGNALS

The start accept flag list is shown below.

Axis No.	Device No.	Axis No.	Device No.	Axis No.	Device No.	Axis No.	Device No.
1	M2001	9	M2009	17	M2017	25	M2025
2	M2002	10	M2010	18	M2018	26	M2026
3	M2003	11	M2011	19	M2019	27	M2027
4	M2004	12	M2012	20	M2020	28	M2028
5	M2005	13	M2013	21	M2021	29	M2029
6	M2006	14	M2014	22	M2022	30	M2030
7	M2007	15	M2015	23	M2023	31	M2031
8	M2008	16	M2016	24	M2024	32	M2032

(Note): The range of axis No.1 to 8 is valid in the Q172HCPU.

CAUTION

- Do not turn the start accept flags ON/OFF in the user side.
- If the start accept flag is turned off using the Motion SFC program or peripheral devices while this flag is on, no error will occur but the positioning operation will not be reliable. Depending on the type of machine, it might operate in an unanticipated operation.
- If the start accept flag is turned on using the Motion SFC program or peripheral devices while this flag is off, no error will occur but the "start accept on error" will occur at the next starting and cannot be started.

(3) Personal computer link communication error flag (M2034) Status signal

This flag turns on when the communication error occurs in the personal computer link communication.

- ON : Personal computer link communication error occurs
- OFF: No personal computer link communication error
(It turns off if normal communication is resumed.)

Refer to APPENDIX 2.6 for details on the PC link communication error.

(4) Motion SFC error history clear request flag (M2035) Command signal

This flag is used to clear the backed-up Motion SFC error history (#8000 to #8063).

The Motion SFC error history is cleared at the turning M2035 OFF to ON. After detection of the turning M2035 OFF to ON, the Motion SFC error history is cleared, and then the M2035 is automatically turned OFF.

(5) Motion SFC error detection flag (M2039) Status signal

This flag turns on with error occurrence at the execution of the Motion SFC program.

When turned off this flag, execute it by the user side after checking the error contents.

(6) Speed switching point specified flag (M2040) Command signal

This flag is used when the speed change is specified at the pass point of the constant speed control.

4 POSITIONING DEDICATED SIGNALS

- (a) By turning M2040 on before the starting of the constant speed control (before the servo program is started), control with the change speed can be executed from the first of pass point.
- OFF Speed is changed to the specified speed from the pass point of the constant speed control.
 - ON Speed has been changed to the specified speed at the pass point of the constant speed control.

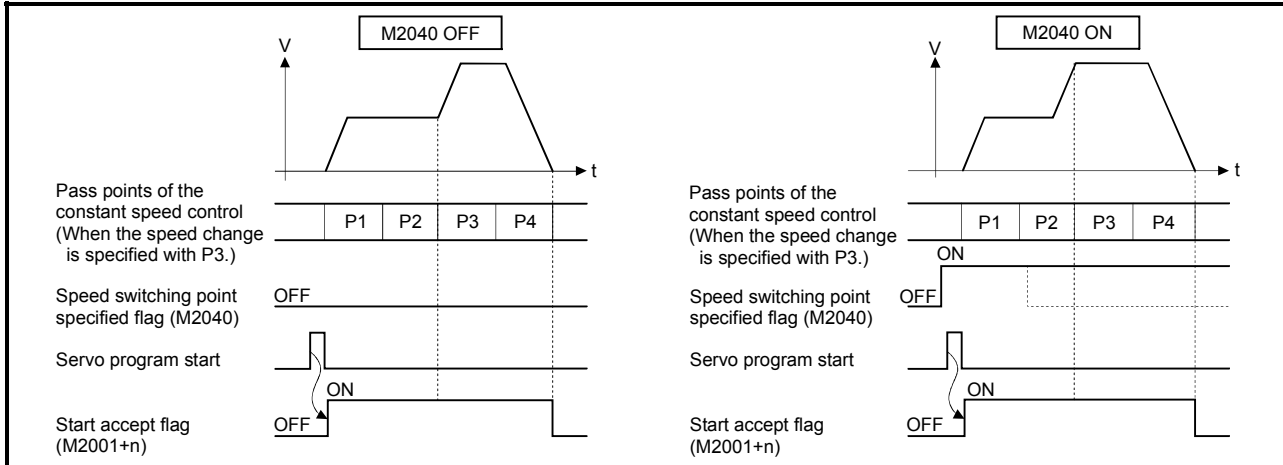

- (7) System setting error flag (M2041) Status signal
- This flag set the "system setting data" and performs an adjustment check with a real installation state (CPU base unit/extension base units) at the power supply on or resetting of the Motion CPU.
- ON Error
 - OFF Normal
- (a) When an error occurs, the ERR.LED at the front of the CPU turns on. The error contents can be confirmed using the error list monitor of a peripheral device started by SW6RN-GSV□P.
- (b) When M2041 is on, positioning cannot be started. Remove an error factor, and turn the power supply on again or reset the Multiple CPU system.

REMARK

Even if the module which is not set as the system setting with the peripheral device is installed in the slot, it is not set as the object of an adjustment check. And the module which is not set as the system setting cannot be used in the Motion CPU.

- (8) All axes servo ON command (M2042) Command signal
- This command is used to enable servo operation.
- (a) Servo operation enabled M2042 turns on while the servo OFF command (M3215+20n) is off and there is no servo error.
- (b) Servo operation disable M2042 is off
- The servo OFF command (M3215+20n) is on
 - Servo error state

4 POSITIONING DEDICATED SIGNALS

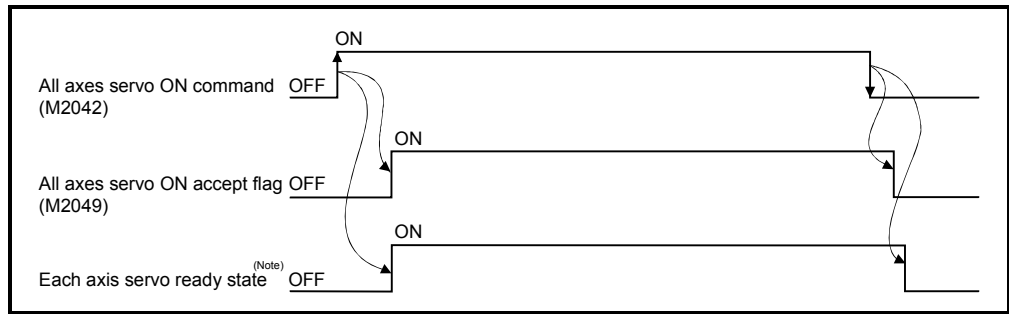

(Note): Refer to Section "3.1.1 Axis statuses "Servo ready signal"" of the Q173CHPU/Q172HCPU Motion controller (SV13/SV22) Programming Manual (REAL MODE) for details.

POINT

When M2042 turns on, it is not turned off even if the CPU is set in the STOP state.

(9) Real/virtual mode switching request flag (M2043)

..... Command signal

This flag is used for switching between the real and virtual modes.

- (a) Turn the M2043 on after the PCPU READY flag has turn on for switching from the real to virtual mode.
 - An error check is executed when the M2043 is switched from off to on. If no error is detected, switch to the virtual mode, and the real/virtual mode status switching status flag (M2044) turns on.
 - If an error is detected, not switch to the virtual mode. In this case, the real/virtual mode switching error detection flag (M2045) turns on, and the error code is stored in the real/virtual mode switching error code storage register (D9193).
- (b) Turn the M2043 off for switching from the virtual to real mode.
 - If all axes of the virtual servomotors stopped, switch to the real mode, and M2044 turns off.
 - If the virtual servomotor is operating also with 1 axis, not switch to the real mode. In this case, the M2045 turns on, and the error code is stored in the D9193.
- (c) Refer to Chapter 9 for switching between the real and virtual modes.

(10) Real/virtual mode switching status flag (M2044)

..... Status signal

This flag checks the switching competition between the real and virtual modes, and the current mode.

- This flag turns off with during the real mode or switching completion from the virtual to real mode.
- This flag turns on with switching completion from the real to virtual mode.

It can be used as an interlock for the servo program start or control change (speed change, current value change).

(11) Real/virtual mode switching error detection flag (M2045) Status signal

This flag is used as judgement of the error available/not available at the mode switching (between the real and virtual modes).

- This flag remains off if no error was detected at mode switching.
- This flag turns on if an error was detected at mode switching.

In this case, the error code is stored in the D9193.

(12) Out-of-sync warning flag (M2046) Status signal

- (a) This signal turns on mode when a discrepancy of synchronized positions between the drive module and output module occurs during the virtual mode.

It is used as judgement for validity of the continuation operation when the drive module has stopped.

- M2046 : ON.....Continuation operation disabled
- M2046 : OFFContinuation operation enabled

- (b) This flag turns on the following cases.

- Stop by the forced stop.
- The servo error in the output module.

- (c) When the out-of-sync warning flag turns on, resume operation by the following procedure.

1) Return to the real mode and eliminate the error cause.

↓

2) Synchronize the axes.

↓

3) Turn the out-of-sync warning flag (M2046) off.

↓

4) Switch to the virtual mode.

↓

5) Resume operation.

(13) Motion slot fault detection flag (M2047) Status signal

This flag is used as judgement which modules installed in the motion slot of the CPU base unit is "normal" or "abnormal".

- ON.....Installing module is abnormal
- OFFInstalling module is normal

The module information at the power supply on and after the power supply injection are always checked, and errors are detected.

- (a) Perform the disposal (stop the starting axis, servo OFF, etc.) of error detection using the Motion SFC program.

(14) JOG operation simultaneous start command (M2048) Command signal

- (a) When M2048 turns on, JOG operation simultaneous start based on the JOG operation execution axis set in the JOG operation simultaneous start axis setting register (D710 to D713).
- (b) When M2048 turns off, the axis during operation decelerates to a stop.

(15) All axes servo ON accept flag (M2049) Status signal

This flag turns on when the Motion CPU accepts the all axes servo ON command (M2042).

Since the servo ready state of each axis is not checked, confirm it in the servo ready signal (M2415+20n).

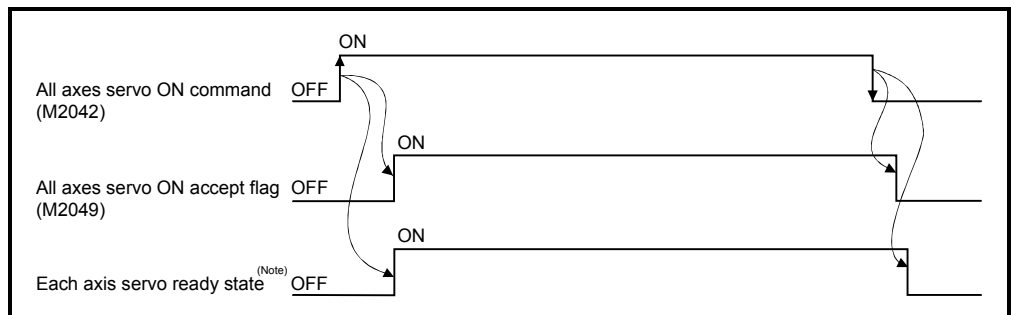

(Note) : Refer to Section "3.1.1 Axis statuses "Servo ready signal"" of the Q173HCPU/Q172HCPU Motion controller (SV13/SV22) Programming Manual (REAL MODE) for details.

(16) Manual pulse generator enable flag (M2051 to M2053) Command signal

This flag set the enabled or disabled state for positioning with the pulse input from the manual pulse generators connected to P1 to P3 (Note) of the Q173PX.

- ON Positioning control is executed by the input from the manual pulse generators.
- OFF Positioning control cannot be executed by the manual pulse generators because of the input from the manual pulse generators is ignored.

Default value is invalid (OFF).

REMARK

(Note) : Refer to the "Q173HCPU/Q172HCPU User's Manual" for P1 to P3 connector of the Q173PX.

4 POSITIONING DEDICATED SIGNALS

(17) Operation cycle over flag (M2054) Status signal

This flag turns on when the time concerning motion operation exceeds the operation cycle of the Motion CPU setting. Perform the following operation, in making it turn off.

- Turn the power supply of the Multiple CPU system on to off
- Reset the Multiple CPU system
- Reset using the user program

[Error measures]

- 1) Change the operation cycle into a large value in the system setting.
- 2) The number of instruction completions of an event task or NMI task in the Motion SFC program.

(18) Speed changing flag (M2061 to M2092) Status signal

This flag turns on during speed change by the control change (CHGV) instruction (or Motion dedicated PLC instruction (S(P).CHGV)) of the Motion SFC program.

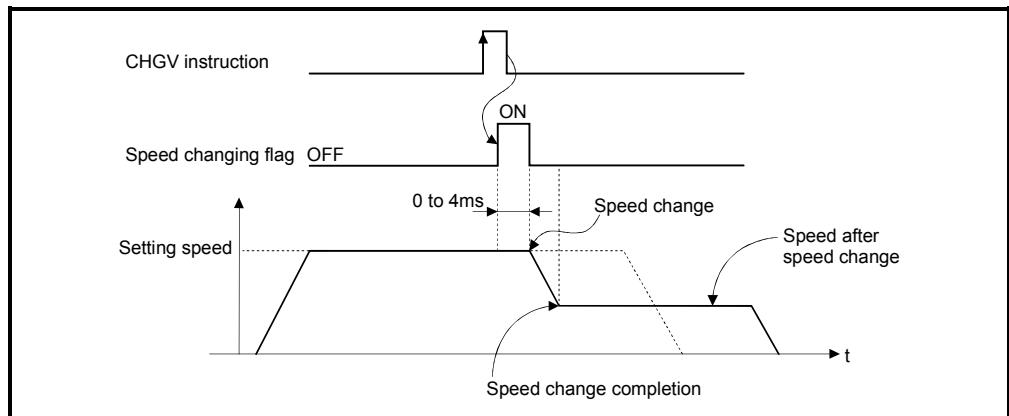

The speed changing flag list is shown below.

Axis No.	Device No.	Axis No.	Device No.	Axis No.	Device No.	Axis No.	Device No.
1	M2061	9	M2069	17	M2077	25	M2085
2	M2062	10	M2070	18	M2078	26	M2086
3	M2063	11	M2071	19	M2079	27	M2087
4	M2064	12	M2072	20	M2080	28	M2088
5	M2065	13	M2073	21	M2081	29	M2089
6	M2066	14	M2074	22	M2082	30	M2090
7	M2067	15	M2075	23	M2083	31	M2091
8	M2068	16	M2076	24	M2084	32	M2092

(Note) : The range of axis No.1 to 8 is valid in the Q172HCPU.

4 POSITIONING DEDICATED SIGNALS

(19) Automatic decelerating flag (M2128 to M2159) Status signal

This signal turns on while automatic deceleration processing is performed at the positioning control or position follow-up control.

- (a) This flag turns on during automatic deceleration processing to the command address at the position follow-up control, but it turns off if the command address is changed.
- (b) When the normal start is completed at the control in all control system, it turns off.
- (c) In any of the following cases, this flag does not turn off.
 - During deceleration by the JOG signal off
 - During manual pulse generator operation
 - At deceleration on the way due to stop command or stop cause occurrence
 - When travel value is 0

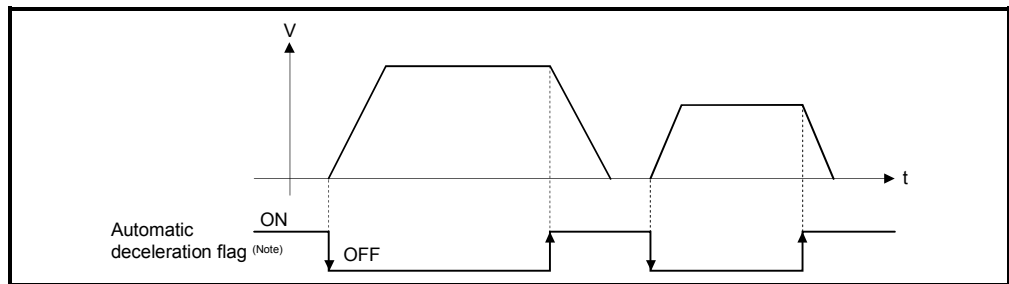

The automatic deceleration flag list is shown below.

Axis No.	Device No.	Axis No.	Device No.	Axis No.	Device No.	Axis No.	Device No.
1	M2128	9	M2136	17	M2144	25	M2152
2	M2129	10	M2137	18	M2145	26	M2153
3	M2130	11	M2138	19	M2146	27	M2154
4	M2131	12	M2139	20	M2147	28	M2155
5	M2132	13	M2140	21	M2148	29	M2156
6	M2133	14	M2141	22	M2149	30	M2157
7	M2134	15	M2142	23	M2150	31	M2158
8	M2135	16	M2143	24	M2151	32	M2159

(Note) : The range of axis No.1 to 8 is valid in the Q172HCPU.

4 POSITIONING DEDICATED SIGNALS

(20) Clutch status (M2160 to M2223) Status signal

Clutch ON/OFF state is indicated.

ON: Clutch ON state

OFF: Clutch OFF state

The clutch status list is shown below.

Connected Module		Applicable Device	Connected Module		Applicable Device
Output module for axis 1	Main shaft side	M2160	Output module for axis 17	Main shaft side	M2192
	Auxiliary input axis side	M2161		Auxiliary input axis side	M2193
Output module for axis 2	Main shaft side	M2162	Output module for axis 18	Main shaft side	M2194
	Auxiliary input axis side	M2163		Auxiliary input axis side	M2195
Output module for axis 3	Main shaft side	M2164	Output module for axis 19	Main shaft side	M2196
	Auxiliary input axis side	M2165		Auxiliary input axis side	M2197
Output module for axis 4	Main shaft side	M2166	Output module for axis 20	Main shaft side	M2198
	Auxiliary input axis side	M2167		Auxiliary input axis side	M2199
Output module for axis 5	Main shaft side	M2168	Output module for axis 21	Main shaft side	M2200
	Auxiliary input axis side	M2169		Auxiliary input axis side	M2201
Output module for axis 6	Main shaft side	M2170	Output module for axis 22	Main shaft side	M2202
	Auxiliary input axis side	M2171		Auxiliary input axis side	M2203
Output module for axis 7	Main shaft side	M2172	Output module for axis 23	Main shaft side	M2204
	Auxiliary input axis side	M2173		Auxiliary input axis side	M2205
Output module for axis 8	Main shaft side	M2174	Output module for axis 24	Main shaft side	M2206
	Auxiliary input axis side	M2175		Auxiliary input axis side	M2207
Output module for axis 9	Main shaft side	M2176	Output module for axis 25	Main shaft side	M2208
	Auxiliary input axis side	M2177		Auxiliary input axis side	M2209
Output module for axis 10	Main shaft side	M2178	Output module for axis 26	Main shaft side	M2210
	Auxiliary input axis side	M2179		Auxiliary input axis side	M2211
Output module for axis 11	Main shaft side	M2180	Output module for axis 27	Main shaft side	M2212
	Auxiliary input axis side	M2181		Auxiliary input axis side	M2213
Output module for axis 12	Main shaft side	M2182	Output module for axis 28	Main shaft side	M2214
	Auxiliary input axis side	M2183		Auxiliary input axis side	M2215
Output module for axis 13	Main shaft side	M2184	Output module for axis 29	Main shaft side	M2216
	Auxiliary input axis side	M2185		Auxiliary input axis side	M2217
Output module for axis 14	Main shaft side	M2186	Output module for axis 30	Main shaft side	M2218
	Auxiliary input axis side	M2187		Auxiliary input axis side	M2219
Output module for axis 15	Main shaft side	M2188	Output module for axis 31	Main shaft side	M2220
	Auxiliary input axis side	M2189		Auxiliary input axis side	M2221
Output module for axis 16	Main shaft side	M2190	Output module for axis 32	Main shaft side	M2222
	Auxiliary input axis side	M2191		Auxiliary input axis side	M2223

(Note) : The range of output module for axis No.1 to 8 is valid in the Q172HCPU.

(21) Speed change "0" accepting flag (M2240 to M2271)

..... Status signal

This flag turns on while a speed change request to speed "0" or negative speed change is being accepted.

It turns on when the speed change request to speed "0" or negative speed change is accepted during a start. After that, this signal turns off when a speed change is accepted or on completion of a stop due to a stop cause.

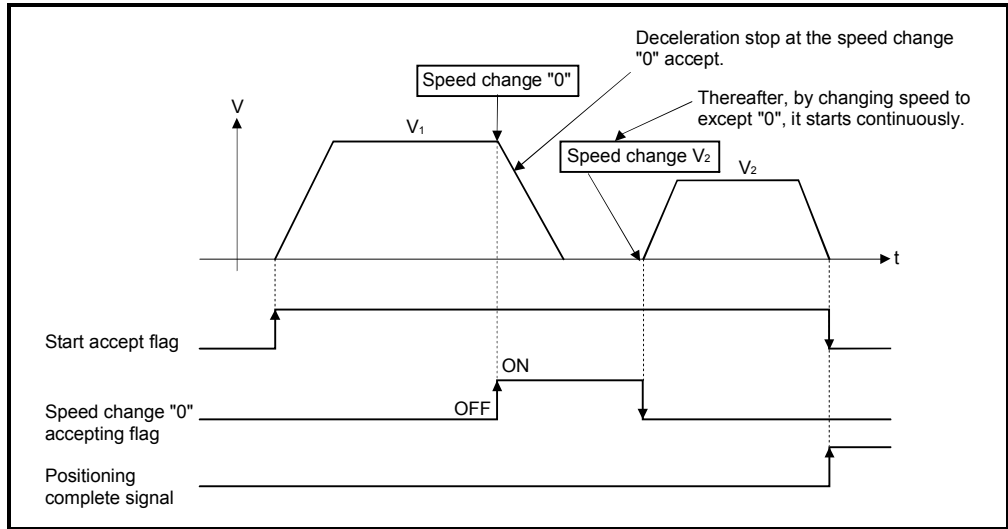

The speed change "0" accepting flag list is shown below.

Axis No.	Device No.	Axis No.	Device No.	Axis No.	Device No.	Axis No.	Device No.
1	M2240	9	M2248	17	M2256	25	M2264
2	M2241	10	M2249	18	M2257	26	M2265
3	M2242	11	M2250	19	M2258	27	M2266
4	M2243	12	M2251	20	M2259	28	M2267
5	M2244	13	M2252	21	M2260	29	M2268
6	M2245	14	M2253	22	M2261	30	M2269
7	M2246	15	M2254	23	M2262	31	M2270
8	M2247	16	M2255	24	M2263	32	M2271

(Note) : The range of axis No.1 to 8 is valid in the Q172HCPU.

REMARK

- (1) Even if it has stopped, when the start accept flag (M2001 to M2032) is ON state, the state where the request of speed change "0" is accepted is indicated.
Confirm by this speed change "0" accepting flag.
- (2) During interpolation, the flags corresponding to the interpolation axes are set.
- (3) In any of the following cases, the speed change "0" request is invalid.
 - After deceleration by the JOG signal off
 - After positioning automatic deceleration start
 - After deceleration due to stop cause

4 POSITIONING DEDICATED SIGNALS

(a) The flag turns off if a speed change request occurs during deceleration to a stop due to speed change "0".

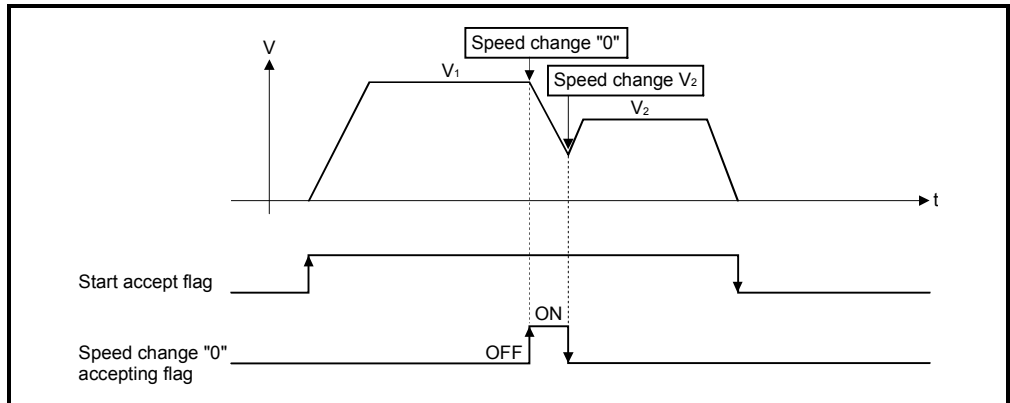

(b) The flag turns off if a stop cause occurs after speed change "0" accept.

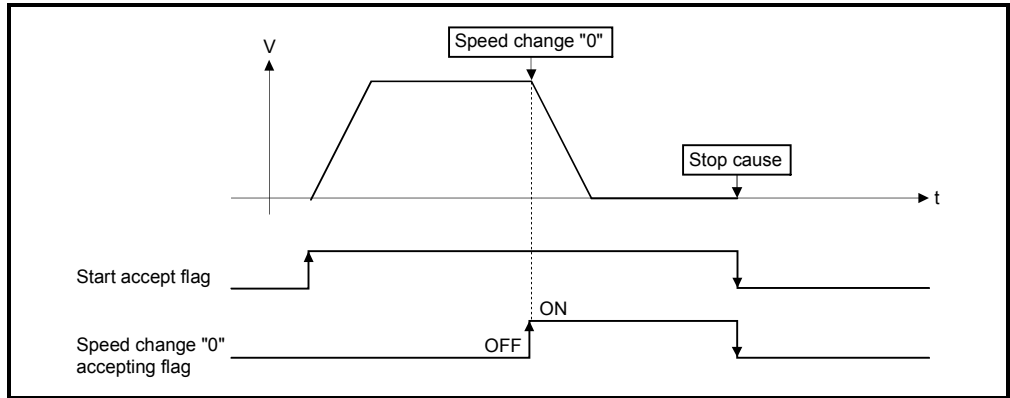

(c) The speed change "0" accepting flag does not turn on if a speed change "0" occurs after an automatic deceleration start.

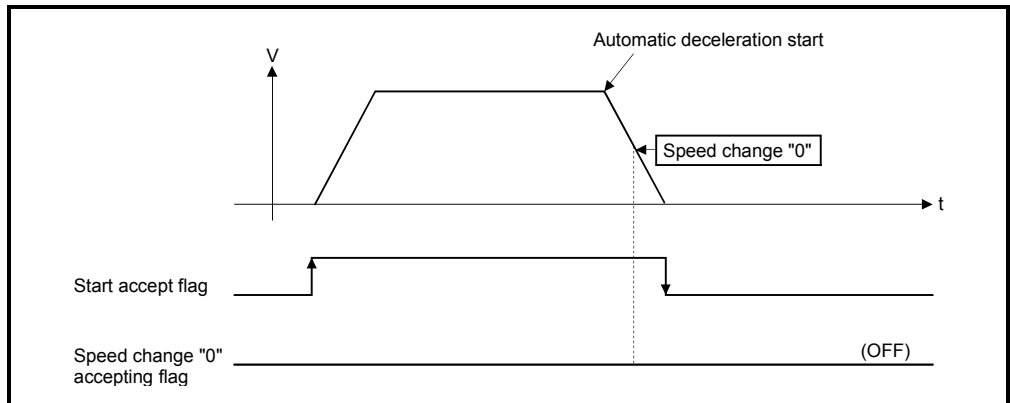

4 POSITIONING DEDICATED SIGNALS

- (d) Even if it is speed change "0" after the automatic deceleration start to the "command address", speed change "0" accepting flag turns on.

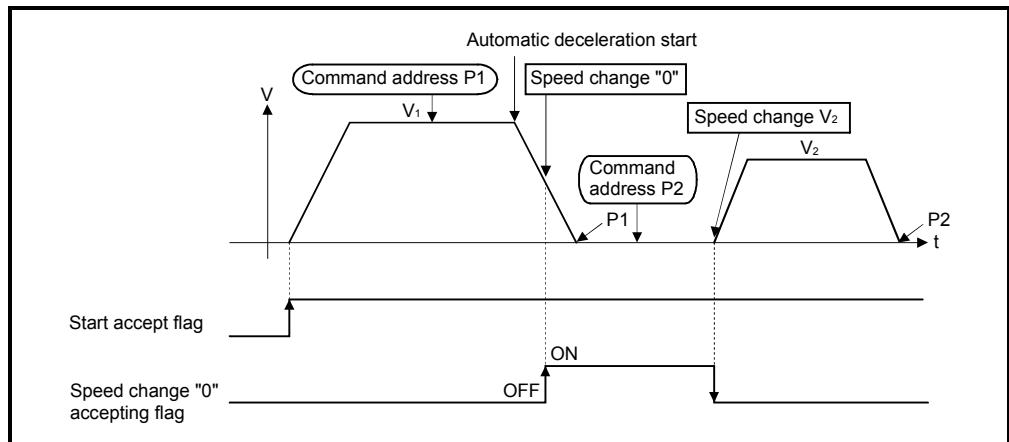

REMARK

It does not start, even if the "command address" is changed during speed change "0" accepting.

(22) Control loop monitor status (M2272 to M2303)

..... Command signal

When using the fully closed loop control servo amplifier, this signal is used to check the fully closed loop control/semi closed loop control of servo amplifier.

- ON During fully closed loop control
- OFF During semi closed loop control

It can be changed the fully closed loop control/semi closed loop control of servo amplifier in the Motion controller by the control loop changing command ON/OFF.

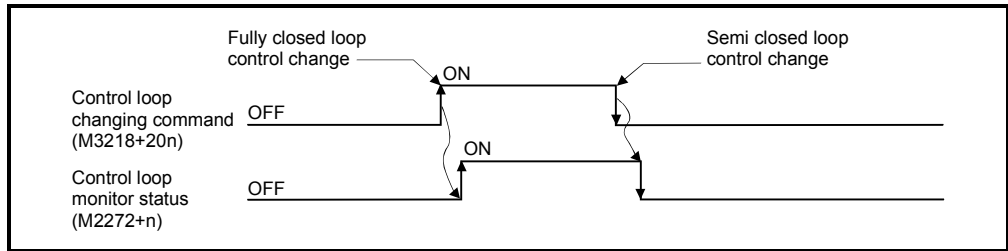

The Control loop monitor status list is shown below.

Axis No.	Device No.	Axis No.	Device No.	Axis No.	Device No.	Axis No.	Device No.
1	M2272	9	M2280	17	M2288	25	M2296
2	M2273	10	M2281	18	M2289	26	M2297
3	M2274	11	M2282	19	M2290	27	M2298
4	M2275	12	M2283	20	M2291	28	M2299
5	M2276	13	M2284	21	M2292	29	M2300
6	M2277	14	M2285	22	M2293	30	M2301
7	M2278	15	M2286	23	M2294	31	M2302
8	M2279	16	M2287	24	M2295	32	M2303

(Note): The range of axis No.1 to 8 is valid in the Q172HCPU.

REMARK

It can be use in the SW6RN-SV22Q□ (Ver.00D or later).

4 POSITIONING DEDICATED SIGNALS

4.2 Data Registers

(1) Data register list

Q173HCPU				Q172HCPU				
Device No.	Purpose	Real	Virtual	Device No.	Purpose	Real	Virtual	
D0 to	Axis monitor device (20 points × 32 axes) Real mode Each axis Virtual mode Output module	○	○	D0 to	Axis monitor device (20 points × 8 axes) Real mode Each axis Virtual mode Output module	○	○	
				D160 to	Unusable (480 points)	—	—	
D640 to	Control change register (2 points × 32 axes)	○	○	D640 to	Control change register (2 points × 8 axes)	○	○	
				D656 to	Unusable (48 points)	—	—	
D704 to	Common device (Command signal) (54 points)	○	○	D704 to	Common device (Command signal) (54 points)	○	○	
D758 to	Common device (Monitor) (42 points)	○	○	D758 to	Common device (Monitor) (42 points)	○	○	
D800	Virtual servomotor axis monitor device (6 points × 32 axes) (Note-1)	Back up	○	D800 to	Virtual servomotor axis monitor device (6 points × 8 axes) (Note-1)	Back up	○	
	Current value after virtual servomotor axis main shaft's differential gear (4 points × 32 axes) (Note-1)				Current value after virtual servomotor axis main shaft's differential gear (4 points × 8 axes) (Note-1)			
					D880 to	Unusable (240 points)	—	—
D1120 to	Synchronous encoder axis monitor device (6 points × 12 axes)					D1120 to	Synchronous encoder axis monitor device (6 points × 8 axes)	Back up
	Current value after synchronous encoder axis main shaft's differential gear (4 points × 12 axes)				Current value after synchronous encoder axis main shaft's differential gear (4 points × 8 axes)			
D1240 to	Cam axis monitor device (10 points × 32 axes) (Note)			D1200 to	Unusable (40 points)	—	—	
				D1240 to	Cam axis monitor device (10 points × 8 axes) (Note-1)	Back up	○	
				D1320 to	Unusable (6872 points)			—
D1560 to D8191	User device (6632 points)			D1560 to D8191	User device (6632 points)			

Real/
virtual
community

□ Usable in the user device.
○ : Valid

4 POSITIONING DEDICATED SIGNALS

POINT

- Total number of points for the user devices

6632 points

(Note-1) : This device occupies only the areas of the axes set in the mechanical system program. The unused axis areas in the mechanical system program can be used as an user side.

(Note-2) : Only details for data registers used in the virtual mode are described in this manual. If it is required, refer to the "Q173HCPU/Q172HCPU Motion controller (SV13/SV22) Programming Manual (REAL MODE)".

4 POSITIONING DEDICATED SIGNALS

(2) Axis monitor device list

Axis No.	Device No.	Signal name									
		Signal name	Real	Virtual				Real mode axis	Refresh cycle	Fetch cycle	Signal direction
Roller	Ball screw			Rotary table	Cam						
1	D0 to D19										
2	D20 to D39										
3	D40 to D59										
4	D60 to D79										
5	D80 to D99										
6	D100 to D119	0	Feed current								
7	D120 to D139	1	value/roller cycle speed								
8	D140 to D159	2	Real current value					Operation cycle		Monitor device	
9	D160 to D179	3									
10	D180 to D199	4	Deviation counter value		○			Main cycle		Monitor device	
11	D200 to D219	5									
12	D220 to D239	6	Minor error code					Immediately			
13	D240 to D259	7	Major error code								
14	D260 to D279	8	Servo error code								
15	D280 to D299	9	Home position return re-travel value	○	Backup		Backup	Operation cycle		Monitor device	
16	D300 to D319	10									
17	D320 to D339	11	Travel value after proximity dog ON								
18	D340 to D359	12	Execute program No.					At start			
19	D360 to D379	13	M-code		×			Operation cycle			
20	D380 to D399	14	Torque limit value								
21	D400 to D419	15	Data set pointer for constant-speed control				○	At start/ during start		Monitor device	
22	D420 to D439	16									
23	D440 to D459	17	Travel value change register		×				Operation cycle	Command device	
24	D460 to D479	18	Real current value at stop input					Operation cycle		Monitor device	
25	D480 to D499	19									
26	D500 to D519										
27	D520 to D539										
28	D540 to D559										
29	D560 to D579										
30	D580 to D599										
31	D600 to D619										
32	D620 to D639										

○ : Valid, × : Invalid

(Note-1) : The range of axis No.1 to 8 is valid in the Q172HCPU.

(Note-2) : Device area of 9 axes or more is unusable in the Q172HCPU.

4 POSITIONING DEDICATED SIGNALS

(3) Control change register list

Axis No.	Device No.	Signal name					
1	D640, D641						
2	D642, D643						
3	D644, D645						
4	D646, D647						
5	D648, D649						
6	D650, D651						
7	D652, D653						
8	D654, D655						
9	D656, D657						
10	D658, D659						
11	D660, D661						
12	D662, D663						
13	D664, D665						
14	D666, D667						
15	D668, D669						
16	D670, D671						
17	D672, D673						
18	D674, D675						
19	D676, D677						
20	D678, D679						
21	D680, D681						
22	D682, D683						
23	D684, D685						
24	D686, D687						
25	D688, D689						
26	D690, D691						
27	D692, D693						
28	D694, D695						
29	D696, D697						
30	D698, D699						
31	D700, D701						
32	D702, D703						

	Signal name	Real	Virtual	Refresh cycle	Fetch cycle	Signal direction
0	JOG speed setting	○	○	/	At start	Command device
1						

○ : Valid

(Note-1) : The range of axis No.1 to 8 is valid in the Q172HCPU.

(Note-2) : Device area of 9 axes or more is unusable in the Q172HCPU.

4 POSITIONING DEDICATED SIGNALS

(4) Virtual servomotor axis monitor device list

Axis No.	Device No.	Signal name										
	Signal name	Real	Virtual					Refresh cycle	Fetch cycle	Signal direction		
			Roller	Ball screw	Rotary table	Cam	Real mode axis					
1	D800 to D809											
2	D810 to D819											
3	D820 to D829											
4	D830 to D839											
5	D840 to D849											
6	D850 to D859	Backup						Operation cycle		Monitor device		
7	D860 to D869										0	Feed current value
8	D870 to D879										1	Minor error code
9	D880 to D889										2	Major error code
10	D890 to D899										3	Execute program No.
11	D900 to D909										4	M-code
12	D910 to D919										5	Current value after virtual servomotor axis main shaft's differential gear
13	D920 to D929										6	Error search output axis No.
14	D930 to D939										7	Data set pointer for constant-speed control
15	D940 to D949										8	
16	D950 to D959											
17	D960 to D969											
18	D970 to D979											
19	D980 to D989											
20	D990 to D999											
21	D1000 to D1009											
22	D1010 to D1019											
23	D1020 to D1029											
24	D1030 to D1039											
25	D1040 to D1049											
26	D1050 to D1059											
27	D1060 to D1069											
28	D1070 to D1079											
29	D1080 to D1089											
30	D1090 to D1099											
31	D1100 to D1109											
32	D1100 to D1119											

○ : Valid, × : Invalid

(Note-1) : The range of axis No.1 to 8 is valid in the Q172HCPU.

(Note-2) : The unused axis areas in the mechanical system program can be used as an user side.

4 POSITIONING DEDICATED SIGNALS

(5) Synchronous encoder axis monitor device list

Axis No.	Device No.	Signal name																																																																																																	
1	D1120 to D1129	<table border="1"> <thead> <tr> <th></th> <th>Signal name</th> <th>Real</th> <th>Virtual</th> <th>Refresh cycle</th> <th>Fetch cycle</th> <th>Signal direction</th> </tr> </thead> <tbody> <tr> <td>0</td> <td>Current value</td> <td rowspan="3">Backup</td> <td rowspan="3">○</td> <td>Operation cycle</td> <td rowspan="3">/</td> <td rowspan="3">Monitor device</td> </tr> <tr> <td>1</td> <td>Minor error code</td> <td>Immediately</td> </tr> <tr> <td>2</td> <td>Major error code</td> <td></td> </tr> <tr> <td>3</td> <td>D1140 to D1149</td> <td>4</td> <td>Unusable</td> <td>—</td> <td>—</td> <td>—</td> <td>—</td> </tr> <tr> <td>4</td> <td>D1150 to D1159</td> <td>5</td> <td>Unusable</td> <td>—</td> <td>—</td> <td>—</td> <td>—</td> </tr> <tr> <td>5</td> <td>D1160 to D1169</td> <td>6</td> <td>Current value after synchronous encoder axis main shaft's differential gear</td> <td rowspan="2">Backup</td> <td rowspan="2">○</td> <td rowspan="2">Operation cycle</td> <td rowspan="2">/</td> <td rowspan="2">Monitor device</td> </tr> <tr> <td>6</td> <td>D1170 to D1179</td> <td>7</td> <td>Error search output axis No.</td> </tr> <tr> <td>7</td> <td>D1180 to D1189</td> <td>8</td> <td>Unusable</td> <td>—</td> <td>—</td> <td>—</td> <td>—</td> </tr> <tr> <td>8</td> <td>D1190 to D1199</td> <td>9</td> <td>Unusable</td> <td>—</td> <td>—</td> <td>—</td> <td>—</td> </tr> <tr> <td>9</td> <td>D1200 to D1209</td> <td></td> <td></td> <td></td> <td></td> <td></td> <td></td> </tr> <tr> <td>10</td> <td>D1210 to D1219</td> <td></td> <td></td> <td></td> <td></td> <td></td> <td></td> </tr> <tr> <td>11</td> <td>D1220 to D1229</td> <td></td> <td></td> <td></td> <td></td> <td></td> <td></td> </tr> <tr> <td>12</td> <td>D1230 to D1239</td> <td></td> <td></td> <td></td> <td></td> <td></td> <td></td> </tr> </tbody> </table>		Signal name	Real	Virtual	Refresh cycle	Fetch cycle	Signal direction	0	Current value	Backup	○	Operation cycle	/	Monitor device	1	Minor error code	Immediately	2	Major error code		3	D1140 to D1149	4	Unusable	—	—	—	—	4	D1150 to D1159	5	Unusable	—	—	—	—	5	D1160 to D1169	6	Current value after synchronous encoder axis main shaft's differential gear	Backup	○	Operation cycle	/	Monitor device	6	D1170 to D1179	7	Error search output axis No.	7	D1180 to D1189	8	Unusable	—	—	—	—	8	D1190 to D1199	9	Unusable	—	—	—	—	9	D1200 to D1209							10	D1210 to D1219							11	D1220 to D1229							12	D1230 to D1239						
	Signal name		Real	Virtual	Refresh cycle	Fetch cycle	Signal direction																																																																																												
0	Current value		Backup	○	Operation cycle	/	Monitor device																																																																																												
1	Minor error code	Immediately																																																																																																	
2	Major error code																																																																																																		
3	D1140 to D1149	4	Unusable	—	—	—	—																																																																																												
4	D1150 to D1159	5	Unusable	—	—	—	—																																																																																												
5	D1160 to D1169	6	Current value after synchronous encoder axis main shaft's differential gear	Backup	○	Operation cycle	/	Monitor device																																																																																											
6	D1170 to D1179	7	Error search output axis No.																																																																																																
7	D1180 to D1189	8	Unusable	—	—	—	—																																																																																												
8	D1190 to D1199	9	Unusable	—	—	—	—																																																																																												
9	D1200 to D1209																																																																																																		
10	D1210 to D1219																																																																																																		
11	D1220 to D1229																																																																																																		
12	D1230 to D1239																																																																																																		
		○ : Valid																																																																																																	

(Note-1) : It is unusable in the SV22 real mode.

(Note-2) : The range of axis No.1 to 8 is valid in the Q172HCPU.

(Note-3) : Device area of 9 axes or more is unusable in the Q172HCPU.

4 POSITIONING DEDICATED SIGNALS

(6) Cam axis monitor device list

Axis No.	Device No.	Signal name				
1	D1240 to D1249					
2	D1250 to D1259					
3	D1260 to D1269					
4	D1270 to D1279					
5	D1280 to D1289					
6	D1290 to D1299					
7	D1300 to D1309					
8	D1310 to D1319					
9	D1320 to D1329					
10	D1330 to D1339					
11	D1340 to D1349					
12	D1350 to D1359					
13	D1360 to D1369					
14	D1370 to D1379					
15	D1380 to D1389					
16	D1390 to D1399					
17	D1400 to D1409					
18	D1410 to D1419					
19	D1420 to D1429					
20	D1430 to D1439					
21	D1440 to D1449					
22	D1450 to D1459					
23	D1460 to D1469					
24	D1470 to D1479					
25	D1480 to D1489					
26	D1490 to D1499					
27	D1500 to D1509					
28	D1510 to D1519					
29	D1520 to D1529					
30	D1530 to D1539					
31	D1540 to D1549					
32	D1550 to D1559					

Signal name	Real	Virtual	Refresh cycle	Fetch cycle	Signal direction
0 Unusable	—	—	—	—	—
1 Execute cam No.	Backup	○	Operation cycle	/	Monitor device
2 Execute stroke amount					
3					
4 Current value within 1 cam shaft revolution					
5	—	—	—	—	—
6 Unusable	—	—	—	—	—
7	—	—	—	—	—
8	—	—	—	—	—
9	—	—	—	—	—

○ : Valid

(Note-1) : The range of axis No.1 to 8 is valid in the Q172HCPU.

(Note-2) : The unused axis areas in the mechanical system program can be used as an user side.

4 POSITIONING DEDICATED SIGNALS

(7) Common device list

Device No.	Signal name	Refresh cycle	Fetch cycle	Signal direction	Device No.	Signal name	Refresh cycle	Fetch cycle	Signal direction	
D704	PLC ready flag request	/	Main cycle	Command device	D752	Manual pulse generator 1 smoothing magnification setting register	/	At the manual pulse generator enable flag ┌ └	Command device	
D705	Speed switching point specified flag request				D753	Manual pulse generator 2 smoothing magnification setting register				
D706	All axes servo ON command request				D754	Manual pulse generator 3 smoothing magnification setting register				
D707	Real/virtual mode switching request (SV22)				D755	Manual pulse generator 1 enable flag request				
D708	JOG operation simultaneous start command request				D756	Manual pulse generator 2 enable flag request				
D709	Unusable	—	—	—	D757	Manual pulse generator 3 enable flag request	/	Main cycle	—	
D710	JOG operation simultaneous start axis setting register	/	At start	Command device	D758	Unusable	—	—	—	
D711					At the manual pulse generator enable flag ┌ └	D759	PCPU ready complete flag status	Main cycle	/	Monitor device
D712						D760	Unusable (30 points)	—	—	—
D713						D761				
D714			Manual pulse generator axis 1 No. setting register			D762				
D715			Manual pulse generator axis 2 No. setting register		D763					
D716			Manual pulse generator axis 3 No. setting register		D764					
D717			Manual pulse generator axis 1 No. setting register		D765					
D718	Manual pulse generator axis 2 No. setting register	D766								
D719	Manual pulse generator axis 3 No. setting register	D767								
D720	Axis 1	D768								
D721	Axis 2	D769								
D722	Axis 3	D770								
D723	Axis 4	D771								
D724	Axis 5	D772								
D725	Axis 6	D773								
D726	Axis 7	D774	—	—	—					
D727	Axis 8	D775	—	—	—					
D728	Axis 9	D776	—	—	—					
D729	Axis 10	D777	—	—	—					
D730	Axis 11	D778	—	—	—					
D731	Axis 12	D779	—	—	—					
D732	Axis 13	D780	—	—	—					
D733	Axis 14	D781	—	—	—					
D734	Axis 15	D782	—	—	—					
D735	Axis 16	D783	—	—	—					
D736	Axis 17	D784	—	—	—					
D737	Axis 18	D785	—	—	—					
D738	Axis 19	D786	—	—	—					
D739	Axis 20	D787	—	—	—					
D740	Axis 21	D788	—	—	—					
D741	Axis 22	D789	—	—	—					
D742	Axis 23	D790	Main cycle	/	Monitor device					
D743	Axis 24	D791	Main cycle	/	Monitor device					
D744	Axis 25	D792	—	—	—					
D745	Axis 26	D793	—	—	—					
D746	Axis 27	D794	—	—	—					
D747	Axis 28	D795	—	—	—					
D748	Axis 29	D796	—	—	—					
D749	Axis 30	D797	—	—	—					
D750	Axis 31	D798	—	—	—					
D751	Axis 32	D799	—	—	—					

(Note-1): This signal is unusable in the SV22 real mode.

(Note-2): The range of axis No.1 to 8 is valid in the Q172HCPU.

(Note-3): Device area of 9 axes or more is unusable in the Q172HCPU.

4 POSITIONING DEDICATED SIGNALS

4.2.1 Axis monitor devices

The monitoring data area is used by the Motion CPU to store data such as the feed current value during positioning control, the real current value and the number of droop pulses in the deviation counter.

It can be used to check the positioning control state using the Motion SFC program. The user cannot write data to the monitoring data area (except the travel value change register).

Refer to APPENDIX 5 "Processing Times of the Motion CPU" for the delay time between a positioning device (input, internal relay and special relay) turning on/off and storage of data in the monitor data area.

(1) Feed current value/roller cycle speed storage register (D0+20n, D1+20n) Monitor device

(a) The target address which is output to the servo amplifier is stored in this register. The target address is based on the command address calculated from the mechanical system program settings.

(b) The stroke range check is performed on this feed current value data.

(c) Roller cycle speed is stored.

The storage range for cycle speed the roller cycle speed storage register is shown below.

Setting Units	Storage Range	Real Roller Cycle Speed
mm	1 to 600000000	0.01 to 6000000.00 [mm/min]
inch		0.001 to 600000.000 [inch/min]

(2) Real current value storage register (D2+20n, D3+20n) Monitor device

(a) This register stores the real current value which took the droop pulses of the servo amplifier into consideration to the feed current value.

(b) The "feed current value" is equal to the "real current value" in the stopped state.

(3) Deviation counter value storage register (D4+20n, D5+20n) Monitor device

This register stores the droop pulses read from the servo amplifier.

(4) Minor error code storage register (D6+20n) Monitor device

(a) This register stores the corresponding error code (Refer to APPENDIX 2.4 and 2.7) at the minor error occurrence. If another minor error occurs after error code storing, the previous error code is overwritten by the new error code.

(b) Minor error codes can be cleared by an error reset command (M3207+20n).

- (5) Major error code storage register (D7+20n) Monitor device
 - (a) This register stores the corresponding error code (Refer to APPENDIX 2.4 and 2.7) at the major error occurrence. If another major error occurs after error code storing, the previous error code is overwritten by the new error code.
 - (b) Major error codes can be cleared by an error reset command (M3207+20n).

- (6) Servo error code storage register (D8+20n) Monitor device
 - (a) This register stores the corresponding error code (Refer to APPENDIX 2.5) at the servo error occurrence. If another servo error occurs after error code storing, the previous error code is overwritten by the new error code.
 - (b) It returns to the real mode by the servo error.

- (7) Torque limit value storage register (D14+20n) Monitor device
This register stores the torque limit value imposed on the servo amplifier.
The default value "300[%]" is stored at the power supply of servo amplifier ON.

4 POSITIONING DEDICATED SIGNALS

4.2.2 Control change registers

This area stores the JOG operation speed data of the virtual servomotor axis.

Table 4.3 Data storage area for control change list

Name	Axis 1	Axis 2	Axis 3	Axis 4	Axis 5	Axis 6	Axis 7	Axis 8
JOG speed setting register	D641, D640	D643, D642	D645, D644	D647, D646	D649, D648	D651, D650	D653, D652	D655, D654
	Axis 9	Axis 10	Axis 11	Axis 12	Axis 13	Axis 14	Axis 15	Axis 16
	D657, D656	D659, D658	D661, D660	D663, D662	D665, D664	D667, D666	D669, D668	D671, D670
	Axis 17	Axis 18	Axis 19	Axis 20	Axis 21	Axis 22	Axis 23	Axis 24
	D673, D672	D675, D674	D677, D676	D679, D678	D681, D680	D683, D682	D685, D684	D687, D686
	Axis 25	Axis 26	Axis 27	Axis 28	Axis 29	Axis 30	Axis 31	Axis 32
	D689, D688	D691, D690	D693, D692	D695, D694	D697, D696	D699, D698	D701, D700	D703, D702

(Note): The range of axis No.1 to 8 is valid in the Q172HCPU.

(1) JOG speed setting registers (D640+2n) Command device

(a) This register stores the JOG speed at the JOG operation.

(b) Setting range of the JOG speed is shown below.

Item \ Unit	PLS	
	Setting Range	Unit
JOG speed	1 to 2147483647	[PLS/s]

(c) The JOG speed is the value stored in the JOG speed setting registers when the JOG start signal turns off to on.

Even if data is changed during JOG operation, JOG speed cannot be changed.

(d) Refer to Section 6.21 of the "Q173HCPU/Q172HCPU Motion controller (SV13/SV22) Programming Manual (REAL MODE)" for details of the JOG operation.

4 POSITIONING DEDICATED SIGNALS

4.2.3 Virtual servomotor axis monitor devices

(1) Feed current value storage register (D800+10n) (Note-1)
 Monitor device

- (a) This register stores the target address output to the servo amplifier based on the positioning address/travel value specified with the servo program.
- (b) The stroke range check is performed on this feed current value data.
- (c) Ring address is -2^{31} [-2^{31}] [PLS] to $2^{31}-1$ [$2^{31}-1$] [PLS] in the infinite operation.

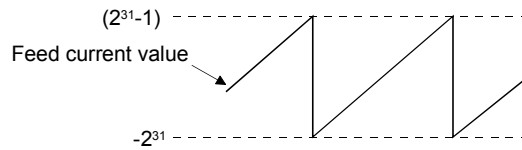

- (d) The date of feed current value storage register is also stored in a backup memory at the power supply off or resetting of the Multiple CPU system.

(2) Minor error code storage register (D802+10n)
 Monitor device

- (a) This register stores the corresponding error code (refer to APPENDIX 2.4, 2.7) at the minor error occurrence in the virtual servomotor or output module. If another minor error occurs after error code storing, the previous error code is overwritten by the new error code.
- (b) Minor error codes in the virtual servomotor can be cleared by an error reset command (Note-2) of the drive module.
 Minor error codes in the output module can be cleared by an error reset command (Note-3) of the output module.

REMARK

(Note-1) : In the above descriptions, "n" in "D800+10n", etc. indicates a value corresponding to axis No. such as the following tables.

Axis No.	n	Axis No.	n	Axis No.	n	Axis No.	n
1	0	9	8	17	16	25	24
2	1	10	9	18	17	26	25
3	2	11	10	19	18	27	26
4	3	12	11	20	19	28	27
5	4	13	12	21	20	29	28
6	5	14	13	22	21	30	29
7	6	15	14	23	22	31	30
8	7	16	15	24	23	32	31

- Calculate as follows for the device No. corresponding to each axis.
 (Example) For axis 32
 $D800+10n$ (Feed current value storage register) = $D800+10 \times 31 = D1110$
- The range (n = 0 to 7) of axis No.1 to 8 is valid in the Q172HCPU.

4 POSITIONING DEDICATED SIGNALS

(Note-2) : Refer to Section 4.1.4 for details of the error reset command for the virtual servomotor axis.

(Note-3) : Refer to Section 4.1.2 for details of the error reset command for the output module.

(3) Major error code storage register (D803+10n)

..... Monitor device

(a) This register stores the corresponding error code (refer to APPENDIX 2.4, 2.7) at the major error occurrence in the virtual servomotor or output module. If another major error occurs after error code storing, the previous error code is overwritten by the new error code.

(b) Major error codes in the virtual servomotor can be cleared by an error reset command ^(Note-1) of the drive module.
Major error codes in the output module can be cleared by an error reset command ^(Note-2) of the output module.

REMARK

(Note-1) : Refer to Section 4.1.4 for details of the error reset command for the virtual servomotor axis.

(Note-2) : Refer to Section 4.1.2 for details of the error reset command for the output module.

4 POSITIONING DEDICATED SIGNALS

4.2.4 Current value after virtual servomotor axis main shaft's differential gear

- (1) Current value after virtual servomotor axis main shaft's differential gear storage register (D806+10n, D807+10n) (Note-1)

..... Monitor device

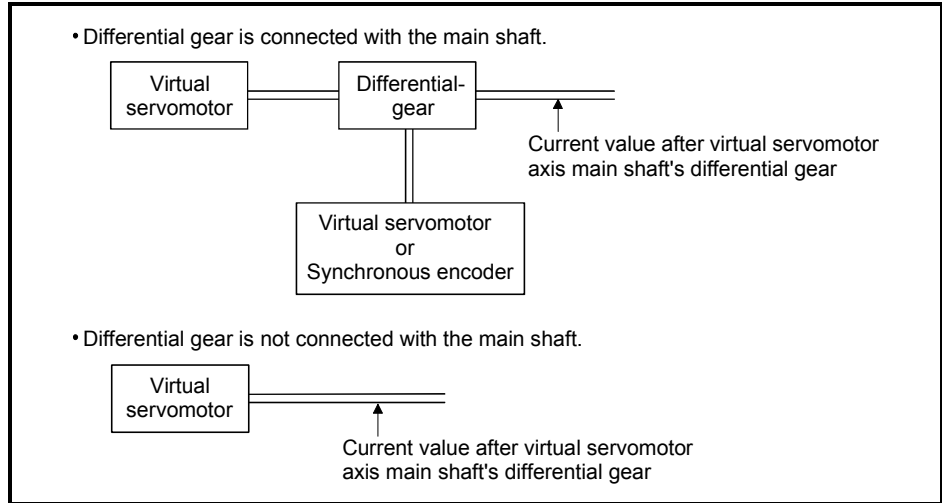

- (a) The current value will be the same as the drive module current value of the main shaft side at the virtual mode switching.
- (b) When the current value change is executed toward the drive module current value of the main shaft side, the current value after main shaft's differential gear is also simultaneously changed to the specified current value.
- (c) If the differential gear is not connected with the main shaft, drive module feed current value of the main shaft side is always stored in the current value storage register after main shaft's differential gear.

REMARK

(Note-1) : In the above descriptions, "n" in "D806+10n", "D807+10n" indicates a value corresponding to axis No. such as the following tables.

Axis No.	n	Axis No.	n	Axis No.	n	Axis No.	n
1	0	9	8	17	16	25	24
2	1	10	9	18	17	26	25
3	2	11	10	19	18	27	26
4	3	12	11	20	19	28	27
5	4	13	12	21	20	29	28
6	5	14	13	22	21	30	29
7	6	15	14	23	22	31	30
8	7	16	15	24	23	32	31

- Calculate as follows for the device No. corresponding to each axis.

(Example) For axis 32

$$D806+10n = D806+10 \times 31 = D1116$$

- The range (n = 0 to 7) of axis No.1 to 8 is valid in the Q172HCPU

- (2) Error search output axis No. storage register (D808+10n)
..... Monitor device
- (a) This register stores the axis No. of the output module in error by the error search function in the virtual mode.
 - (b) If there are no errors at the virtual servomotor axes of the main shaft and auxiliary input axis, the error occurrence output axis No. is stored into the error search output axis No. storage register of the corresponding drive module No. when a minor or major error occurs at the connected output axis.
 - (c) Error search and error reset
 - 1) Searching the main shaft for error
The output axes connected to the main shaft are searched for an error in order of lower to higher numbers. If either a minor or major error has occurred, the corresponding output axis No. is stored into the error search output axis No. storage register.
Resetting the error of the corresponding output axis stores the other error occurrence output axis No. connected to the same main shaft.
 - 2) Searching the auxiliary input axis for error
If either a minor or major error has occurred at the output axis connected to the auxiliary input axis, the corresponding output axis No. is stored into the error search output axis No. storage register.
However, when the differential gear (for virtual main shaft connection) is used to provide auxiliary input to the main shaft, the output axis connected to the auxiliary input axis is not searched for an error. Use the main shaft side error search output axis No. storage register to confirm the error occurrence output axis No.
 - (d) When error occurs at the drive module axis
When an error occurs at the main shaft/auxiliary input axis to which the output axis is connected, "0" (no error) is stored into the error search output axis No. storage device if an error occurred at the output axis.

4.2.5 Synchronous encoder axis monitor devices

- (1) Current value storage register (D1120+10n, D1121+10n) Monitor device
 - (a) This register stores the synchronous encoder current value of the drive module.
 - (b) Ring address is "-2147483648 (-2^{31}) to 2147483647 ($2^{31}-1$)" [PLS].
 - (c) The current value storage register data is also stored in a backup memory at the power supply off or resetting of the Multiple CPU system.
- (2) Minor error code storage register (D1122+10n) Monitor device
 - (a) This register stores the corresponding error code (refer to APPENDIX 2.4, 2.7) at the minor error occurrence in the synchronous encoder or output module. If another minor error occurs after error code storing, the previous error code is overwritten by the new error code.
 - (b) Minor error codes in the synchronous encoder can be cleared by an error reset command ^(Note-1) of the synchronous encoder axis.
Minor error codes in the output module can be cleared by an error reset command ^(Note-2) of the output module.

REMARK

(Note-1) : Refer to Section 4.1.6 for details of the error reset command for the synchronous encoder axis.

(Note-2) : Refer to Section 4.1.2 for details of the error reset command for the output module.

- (3) Major error code storage register (D1123+10n) Monitor device
 - (a) This register stores the corresponding error code (refer to APPENDIX 2.4, 2.7) at the major error occurrence in the synchronous encoder or output module. If another major error occurs after error code storing, the previous error code is overwritten by the new error code.
 - (b) Major error codes in the synchronous encoder axis can be cleared by an error reset command ^(Note-1) of the synchronous encoder.
Major error codes in the output module can be cleared by an error reset command ^(Note-2) of the output module.

REMARK

(Note-1) : Refer to Section 4.1.6 for details of the error reset command for the synchronous encoder axis.

(Note-2) : Refer to Section 4.1.2 for details of the error reset command for the output module.

4.2.6 Current value after synchronous encoder axis main shaft's differential gear

- (1) Current value after synchronous encoder axis main shaft's differential gear storage registers (D1126+10n, D1127+10n)
 Monitor device

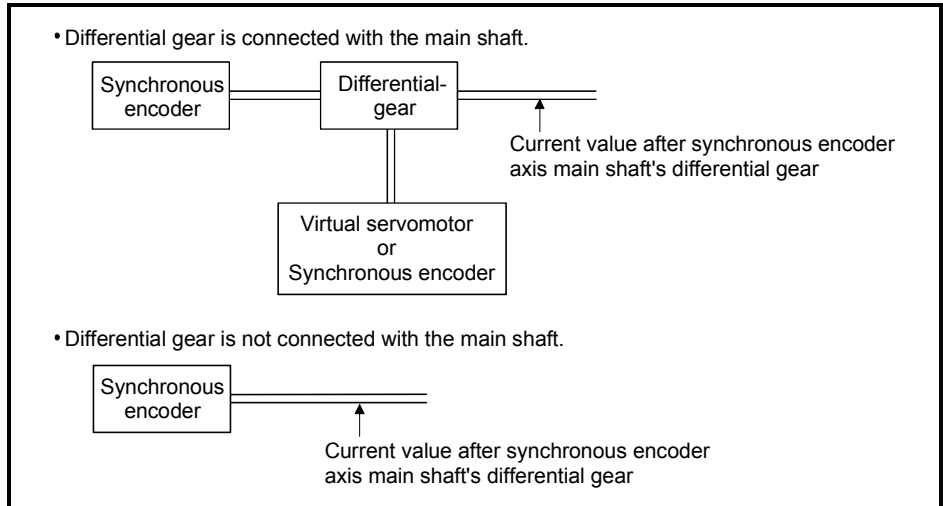

- (a) The current value will be the same as the drive module current value of the main shaft side at the virtual mode switching.
- (b) When the current value change is executed toward the drive module current value of the main shaft side, the current value after main shaft's differential gear is also simultaneously changed to the specified current value.
- (c) If the differential gear is not connected with the main shaft, drive module current value of the main shaft side is always stored in the current value storage register after main shaft's differential gear.

- (2) Error search output axis No. storage register (D1128+10n) Monitor device
- (a) This register stores the axis No. of the output module in error by the error search function in the virtual mode.
 - (b) If there are no errors at the virtual servomotor axes of the main shaft and auxiliary input axis, the error occurrence output axis No. is stored into the error search output axis No. storage register of the corresponding drive module No. when a minor or major error occurs at the connected output axis.
 - (c) Error search and error reset
 - 1) Searching the main shaft for error
The output axes connected to the main shaft are searched for an error in order of lower to higher numbers. If either a minor or major error has occurred, the corresponding output axis No. is stored into the error search output axis No. storage register.
Resetting the error of the corresponding output axis stores the other error occurrence output axis No. connected to the same main shaft.
 - 2) Searching the auxiliary input axis for error
If either a minor or major error has occurred at the output axis connected to the auxiliary input axis, the corresponding output axis No. is stored into the error search output axis No. storage register.
However, when the differential gear (for virtual main shaft connection) is used to provide auxiliary input to the main shaft, the output axis connected to the auxiliary input axis is not searched for an error. Use the main shaft side error search output axis No. storage register to confirm the error occurrence output axis No.
 - (d) When error occurs at the drive module axis
When an error occurs at the main shaft/auxiliary input axis to which the output axis is connected, "0" (no error) is stored into the error search output axis No. storage device if an error occurred at the output axis.

4.2.7 Cam axis monitor devices

- (1) Execute cam No. storage register (D1241+10n) ... Monitor device
 - (a) This register stores the cam No. currently being controlled.
 - (b) Cam No. of the execute cam No. storage register is held until next cam is executed. (Cam No. is not cleared, even if cam control is completed.)
- (2) Execute stroke amount storage register (D1242+10n, D1243+10n) Monitor device
 - (a) This register stores the cam No. currently being controlled.
- (3) Current value within 1 cam shaft revolution storage register (D1244+10n, D1245+10n) Monitor device
 - (a) This register stores the current value within 1 cam shaft revolution set in the parameter.
The current value is a ring address of "0 to [Number of pulses per cam shaft revolution (Nc)-1]".

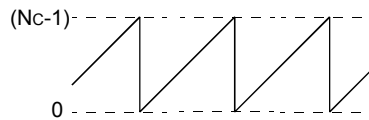

4 POSITIONING DEDICATED SIGNALS

4.2.8 Common devices

- (1) Common bit device SET/RST request register (D704 to D708, D755 to D757) Command device
 Because cannot be turn on/off in every bit from the PLC CPU, the bit device is assigned to D register, and each bit device turns on with the lowest rank bit 0 to 1 and each bit device becomes off with 1 to 0.
 The details of request register are shown below.
 (Refer to Section "4.1.9 Common devices" for the bit device M2000 to M2053.)

Details of the request register

No.	Function	Bit device	Request register
1	PLC ready flag	M2000	D704
2	Speed switching point specified flag	M2040	D705
3	All axes servo ON command	M2042	D706
4	Real/virtual mode switching request (SV22)	M2043	D707
5	JOG operation simultaneous start command	M2048	D708
6	Manual pulse generator 1 enable flag	M2051	D755
7	Manual pulse generator 2 enable flag	M2052	D756
8	Manual pulse generator 3 enable flag	M2053	D757

- (2) JOG operation simultaneous start axis setting registers (D710 to D713) Command device
 (a) These registers set the virtual servomotor axis No. and direction which start simultaneously the JOG operation.

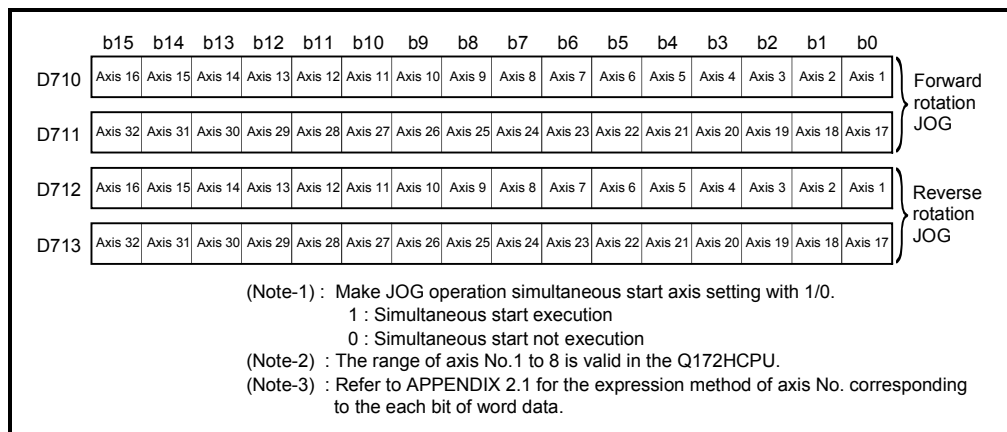

- (b) Refer to Section 6.21.3 of the "Q173HCPU/Q172HCPU Motion controller (SV13/SV22) Programming Manual (REAL MODE)" for details of the JOG operation simultaneous start.

4 POSITIONING DEDICATED SIGNALS

(3) Manual pulse generator axis No. setting registers (D714 to D719) Command signal

(a) These registers stores the virtual servomotor axis No. controlled with the manual pulse generator.

	b15	b14	b13	b12	b11	b10	b9	b8	b7	b6	b5	b4	b3	b2	b1	b0	
P1	D714	Axis 16	Axis 15	Axis 14	Axis 13	Axis 12	Axis 11	Axis 10	Axis 9	Axis 8	Axis 7	Axis 6	Axis 5	Axis 4	Axis 3	Axis 2	Axis 1
	D715	Axis 32	Axis 31	Axis 30	Axis 29	Axis 28	Axis 27	Axis 26	Axis 25	Axis 24	Axis 23	Axis 22	Axis 21	Axis 20	Axis 19	Axis 18	Axis 17
P2	D716	Axis 16	Axis 15	Axis 14	Axis 13	Axis 12	Axis 11	Axis 10	Axis 9	Axis 8	Axis 7	Axis 6	Axis 5	Axis 4	Axis 3	Axis 2	Axis 1
	D717	Axis 32	Axis 31	Axis 30	Axis 29	Axis 28	Axis 27	Axis 26	Axis 25	Axis 24	Axis 23	Axis 22	Axis 21	Axis 20	Axis 19	Axis 18	Axis 17
P3	D718	Axis 16	Axis 15	Axis 14	Axis 13	Axis 12	Axis 11	Axis 10	Axis 9	Axis 8	Axis 7	Axis 6	Axis 5	Axis 4	Axis 3	Axis 2	Axis 1
	D719	Axis 32	Axis 31	Axis 30	Axis 29	Axis 28	Axis 27	Axis 26	Axis 25	Axis 24	Axis 23	Axis 22	Axis 21	Axis 20	Axis 19	Axis 18	Axis 17

(Note-1) : Make the axis No. controlled with the manual pulse generator setting with 1/0.
 1 : Specified axis
 0 : Unspecified axis

(Note-2) : The range of axis No.1 to 8 is valid in the Q172HCPU.

(Note-3) : Refer to APPENDIX 2.1 for the expression method of axis No. corresponding to the each bit of word data.

(b) Refer to Section 6.22 of the "Q173HCPU/Q172HCPU Motion controller (SV13/SV22) Programming Manual (REAL MODE)" for details of the manual pulse generator operation.

(4) Manual pulse generator 1-pulse input magnification setting registers (D720 to D751) Command device

(a) These register set the magnification (1 to 10000) per pulse of number of the input pulses from manual pulse generator at the pulse generator operation.

1-pulse input magnification setting register	Axis No.	Setting range	1-pulse input magnification setting register	Axis No.	Setting range
D720	Axis 1	1 to 10000	D736	Axis 17	1 to 10000
D721	Axis 2		D737	Axis 18	
D722	Axis 3		D738	Axis 19	
D723	Axis 4		D739	Axis 20	
D724	Axis 5		D740	Axis 21	
D725	Axis 6		D741	Axis 22	
D726	Axis 7		D742	Axis 23	
D727	Axis 8		D743	Axis 24	
D728	Axis 9		D744	Axis 25	
D729	Axis 10		D745	Axis 26	
D730	Axis 11		D746	Axis 27	
D731	Axis 12		D747	Axis 28	
D732	Axis 13		D748	Axis 29	
D733	Axis 14		D749	Axis 30	
D734	Axis 15		D750	Axis 31	
D735	Axis 16		D751	Axis 32	

(Note-1) : The range of axis No.1 to 8 is valid in the Q172HCPU.

4 POSITIONING DEDICATED SIGNALS

(b) Refer to Section 6.22 of the "Q173HCPU/Q172HCPU Motion controller (SV13/SV22) Programming Manual (REAL MODE)" for details of the manual pulse generator operation.

(5) Manual pulse generator smoothing magnification setting registers (D752 to D754) Command device

(a) These registers set the smoothing time constants of manual pulse generators.

Manual pulse generator smoothing magnification setting register	Setting range
Manual pulse generator 1 (P1): D752	0 to 59
Manual pulse generator 2 (P1): D753	
Manual pulse generator 3 (P1): D754	

(b) When the smoothing magnification is set, the smoothing time constant is as indicated by the following expression.

$$\text{Smoothing time constant (t)} = (\text{Smoothing magnification} + 1) \times 56.8 \text{ [ms]}$$

(c) Operation

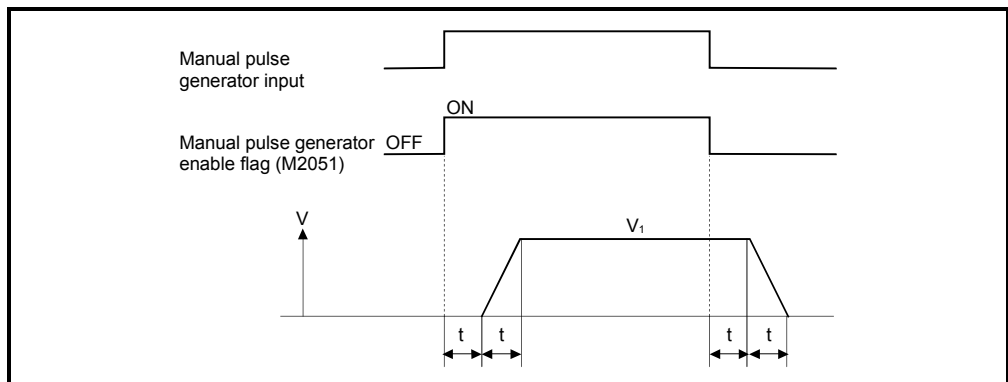

$$\text{Output speed (V}_1\text{) [PLS/s]} = (\text{Number of input pulses/s}) \times (\text{Manual pulse generator 1-pulse input magnification setting})$$

$$\text{Travel value (L)} = (\text{Number of input pulses}) \times (\text{Manual pulse generator 1-pulse input magnification setting})$$

(d) The manual pulse operation in the virtual mode is effective at the only test mode.

REMARK

(1) The smoothing time constant is 56.8[ms] to 3408[ms].

4 POSITIONING DEDICATED SIGNALS

(6) Real mode axis information register (D790, D791)

..... Monitor device

This signal is used to store the information used as a real mode axis at the time of switching from real mode to virtual mode.

The real mode axis information does not change at the time of switching from virtual mode to real mode.

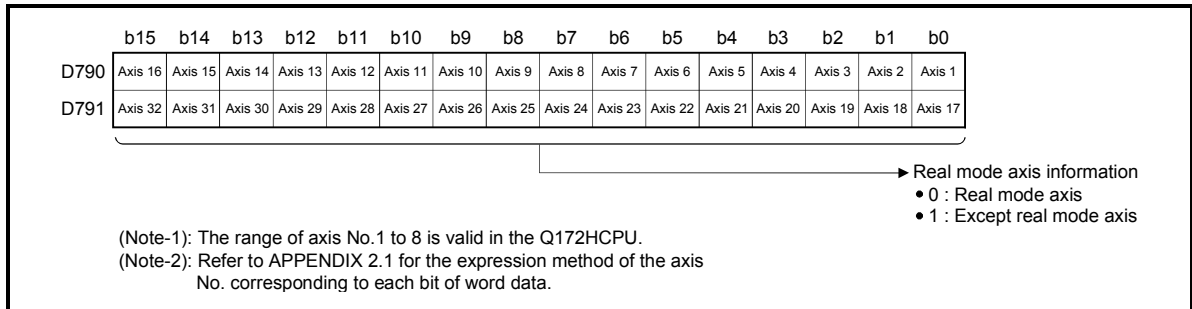

4 POSITIONING DEDICATED SIGNALS

4.3 Motion registers (#)

There are motion registers (#0 to #8191) in the Motion CPU. #8000 to #8063 are used as the Motion SFC dedicated device and #8064 to #8191 are used as the servo monitor device. Refer to the "Q173HCPU/Q172HCPU Motion Controller (SV13/SV22) Programming Manual (Motion SFC)" for details of the motion registers and Motion SFC dedicated device.

- (1) Servo monitor devices (#8064 to #8191) Monitor device
 Information about "servo amplifier type", "motor current" and "motor speed" for each axis is stored the servo monitor devices.
 The details of the storage data are shown below.

Axis No.	Device No.	Signal name				
1	#8064 to #8067					
2	#8068 to #8071					
3	#8072 to #8075					
4	#8076 to #8079					
5	#8080 to #8083					
6	#8084 to #8087					
7	#8088 to #8091					
8	#8092 to #8095					
9	#8096 to #8099					
10	#8100 to #8103	+0	Servo amplifier type	0 : Unused 256 : MR-J3-B 257 : MR-J3-B (Fully closed loop control) 258 : MR-J3-B (Linear)	When the servo amplifier power-on	Monitor device
11	#8104 to #8107	+1	Motor current	× 0.1[%]	Operation cycle 1.7[ms] or less: Operation cycle Operation cycle 3.5[ms] or more: 3.5[ms]	
12	#8108 to #8111	+2	Motor speed	× 0.1[r/min]		
		+3				
13	#8112 to #8115					
14	#8116 to #8119					
15	#8120 to #8123					
16	#8124 to #8127					
17	#8128 to #8131					
18	#8132 to #8135					
19	#8136 to #8139					
20	#8140 to #8143					
21	#8144 to #8147					
22	#8148 to #8151					
23	#8152 to #8155					
24	#8156 to #8159					
25	#8160 to #8163					
26	#8164 to #8167					
27	#8168 to #8171					
28	#8172 to #8175					
29	#8176 to #8179					
30	#8180 to #8183					
31	#8184 to #8187					
32	#8188 to #8191					

(Note-1) : The value that the lowest servo monitor device No. was added "+0, +1 ..." on each axis is shown.

4.4 Special relays (SP.M)

There are 256 special relay points of M9000 to M9255 in the Motion CPU. Of these, 7 points of the M9073 to M9079 are used for the positioning control, and their applications are indicated in Table 4.4. (Refer to APPENDIX 3.1 "Special relays" for the applications of the special relays except M9073 to M9079.)

Table 4.4 Special relay list

Device No.	Signal name	Refresh cycle	Signal type
M9073	PCPU WDT error flag	Main cycle	Status signal
M9074	PCPU REDAY complete flag		
M9075	TEST mode ON flag		
M9076	External forced stop input flag		
M9077	Manual pulse generator axis setting error flag		
M9078	TEST mode request error flag		
M9079	Servo program setting error flag		

(1) PCPU WDT error flag (M9073) Status signal

This flag turns on when a "watchdog timer error" is detected of the Motion CPU self-diagnosis function.

When the Motion CPU detects a WDT error, it executes an immediate stop without deceleration of the operating axes.

If the Motion CPU WDT error flag has turn on, reset the Motion CPU.

If M9073 remains on after resetting, there is a fault at the Motion CPU side.

The error cause is stored in the "Motion CPU WDT error cause (D9184)".

(Refer to Section 4.5(3)).

(2) PCPU REDAY complete flag (M9074) Status signal

This flag is used as judgement of the normal or abnormal in the Motion CPU side using the PLC program.

(a) When the PLC ready flag (M2000) turns off to on, the fixed parameters, servo parameters and limit switch output data are checked, and if error is not detected, this flag turns on.

The servo parameters are written to the servo amplifiers and the M-codes are cleared.

(b) This flag turns off when the PLC ready flag (M2000) turns off.

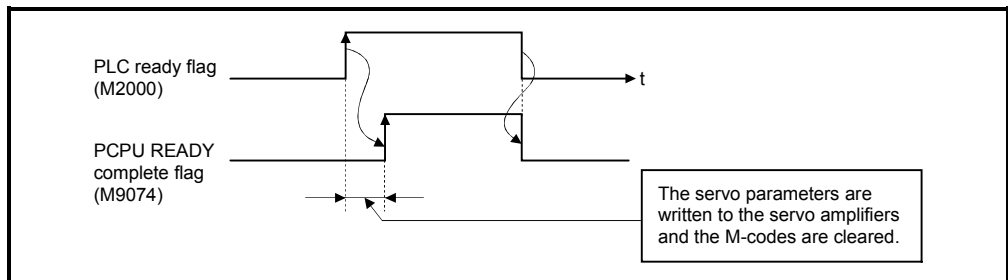

- (3) TEST mode ON flag (M9075) Status signal
- (a) This flag is used as judgement of during the test mode or not using a peripheral.
Use it for an interlock, etc. at the starting of the servo program using the Motion SFC program.
- OFF Except the test mode
 - ON During the test mode
- (b) If the test mode request is executed in the test mode request from the peripheral device, the TEST mode request error flag (M9078) turns on.
- (4) External forced stop input flag (M9076) Status signal
- This flag checks the external forced stop input signal ON/OFF.
- OFF During the external forced stop input on
 - ON During the external forced stop input off

POINT
<p>(1) If the forced stop signal is input during positioning, the feed current value is advanced within the rapid stop deceleration time set in the parameter block. At the same time, the servo OFF state is established because the all axes servo ON command (M2042) turns off. When the rapid stop deceleration time has elapsed after input of the forced stop signal, the feed current value returns to the value at the point when the emergency stop was initiated.</p> <p>(2) If the forced stop is reset before the emergency stop deceleration time has elapsed, a servo error occurs.</p>

- (5) Manual pulse generator axis setting error flag (M9077) Status signal
- (a) This flag is use as judgement of normal or abnormal setting of the manual pulse generator axis No. setting registers (D714 to D719).
- OFF D714 to D719 is normal
 - ON D714 to D719 is abnormal
- (b) When M9077 turns on, the error contents are stored in the manual pulse generator axis setting error information (D9185 to D9187).
- (6) TEST mode request error flag (M9078) Status signal
- (a) This flag turns on when the test mode is not executed in the test mode request using a peripheral device.
- (b) When M9078 turns on, the error contents are stored in the test mode request error information (D9182, D9183).
- (7) Servo program setting error flag (M9079) Status signal
- This flag is used as judgement of normal or abnormal for the servo program positioning data.
- OFF Normal
 - ON Abnormal

4 POSITIONING DEDICATED SIGNALS

4.5 Special registers (SP.D)

There are 256 special register points of D9000 to D9255 in the Motion CPU. Of these, 23 points of the D9112 and D9180 to D9201 are used for the positioning control.

The special registers used for positioning are shown below. (Refer to APPENDIX 3.2 "Special registers" for the applications of the special registers except D9112 and D9180 to D9201.)

Table 4.5 Special register list

Device No.	Signal name	Refresh cycle	Fetch cycle	Signal direction	
D9112	Connect/disconnect	Main cycle	Main cycle	Command device/ Monitor device	
D9180	Unusable	—	—	—	
D9181					
D9182	Test mode request error information	At test mode request		Monitor device	
D9183					
D9184	Motion CPU WDT error cause	At Motion CPU WDT error occurrence			
D9185	Manual pulse generator axis setting error information	At the manual pulse generator enable flag \uparrow			
D9186					
D9187					
D9188	Motion operation cycle	Operation cycle			
D9189	Error program No.	At start			
D9190	Error item information				
D9191	Servo amplifier loading information	At power supply on/ operation cycle			
D9192					
D9193	Real/virtual mode switching error information (SV22)	At virtual mode transition			
D9194					
D9195					
D9196	PC link communication error codes	Operation cycle			
D9197	Operation cycle of the Motion CPU setting	At power supply on			
D9198	Unusable	—	—		—
D9199					
D9200	State of switch	Main cycle			Monitor device
D9201	State of LED	Immediate			

(1) Connect/disconnect (D9112)

..... Command device/Monitor device

This function is used to connect/disconnect the SSCNET communication temporarily, when the servo amplifiers or SSCNETⅢ cables on the SSCNET system are exchanged during power supply on of the Motion CPU. The user side requires to connect/disconnect for a system, and the system side stores the states of command accept waiting or execute waiting for connect/disconnect. Moreover, also connect the servo amplifiers disconnected with the connect/disconnect device using this device. When turning the power supply OFF/ON for the axis 1 of SSCNET system, there is no necessity for connect/disconnect processing.

- 0 Connect/disconnect command accept waiting
- -1 Connect/disconnect execute waiting
- 1 to 32 Disconnect command
- -10 Re-connect command
- -2 Connect/disconnect execute command

(2) Test mode request error information (D9182, D9183)

..... Monitor device

If there are operating axis at a test mode request from a peripheral device, a test mode request error occurs, the test mode request error flag (M9078) turns on, and the during operation/stop data of the each axis are stored.

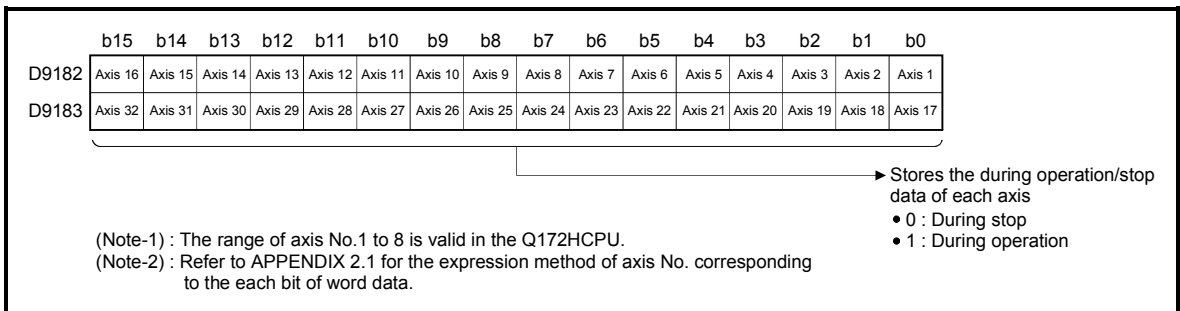

4 POSITIONING DEDICATED SIGNALS

(3) Motion CPU WDT error cause (D9184) Monitor device

This register is used as judgement of the error contents in the Motion CPU.

Error code	Error cause	Operation when error occurs	Action to take		
1	SW fault 1	All axes stop immediately, after which operation cannot be started.	<ul style="list-style-type: none"> • Reset with the reset key. • If the error reoccurs after resetting, <ol style="list-style-type: none"> 1) Change the operation cycle into a large value in the system setting. 2) Reduce the number of command execution of the event task or NMI task in the system setting. • Reset with the reset key. • If the error reoccurs after resetting, the relevant module or the relevant slot (base unit) is probably faulty: replace the module/base unit. • Reset with the reset key. • If the error reoccurs after resetting, explain the error symptom and get advice from our sales representative. • Reset with the reset key. • If the error reoccurs after resetting, the relevant module or the relevant slot (base unit) is probably faulty: replace the module/base unit. • Reset with the reset key. • Use 8 or more points of CPSTART instruction to start programs within the number of simultaneously startable programs. 		
2	Operation cycle time over				
3	Q bus WDT error				
4	WDT error				
30	Information processor H/W error				
201 to 215	Q bus H/W fault 201 Error contents 01 : Q bus error 1 02 : Q bus error 2 04 : Q bus error 4 08 : Q bus error 8 Error code = Total of the error contents + 200				
250 to 253	Servo amplifier interface H/W fault 250 Faulty SSCNET ^{III} No. 0 : SSCNET ^{III} 1 1 : SSCNET ^{III} 2 Error code = Total of the faulty SSCNET ^{III} No. + 250				
300	SW fault3				
301	8 or more points of CPSTART instruction were used to start programs in excess of simultaneously startable program. <table border="1" style="margin-left: 20px;"> <tr> <td>Number of simultaneous startable programs</td> </tr> <tr> <td style="text-align: center;">14</td> </tr> </table>			Number of simultaneous startable programs	14
Number of simultaneous startable programs					
14					

4 POSITIONING DEDICATED SIGNALS

(4) Manual pulse generator axis setting error information (D9185 to D9187) Monitor device

The setting information is checked when the manual pulse generator enable signal turns off to on, if an error is found, the following error information is stored into D9185 to D9187 and the manual pulse generator axis setting error flag (M9077) turns on.

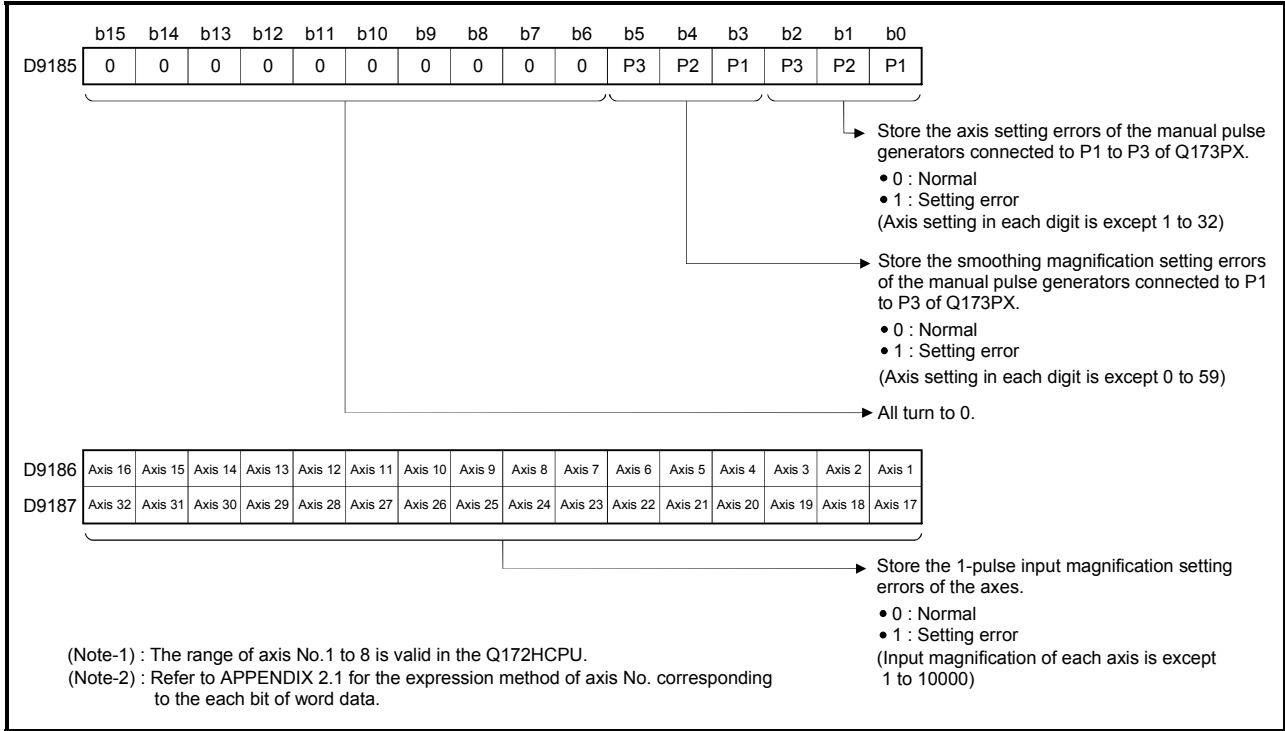

(5) Motion operation cycle (D9188) Monitor device

The time which motion operation took for every motion operation cycle is stored in [μ s] unit.

(6) Error program No. (D9189) Monitor device

(a) When the servo program error occurs at the servo program operation, the program setting error flag (M9079) turns on and the error servo program No. (0 to 4095).

(b) If an error occurs in another servo program when error program No. has been stored, the program No. of the new error is stored.

(7) Error item information (D9190) Monitor device

When the servo program error occurs at the servo program operation, the program setting error flag (M9079) turns on and the error code corresponds to the error setting item is stored.

Refer to APPENDIX 2.3 for details of servo program setting errors.

4 POSITIONING DEDICATED SIGNALS

(8) Servo amplifier loading information (D9191 to D9192)

..... Monitor device

The installation state of the servo amplifier is checked at the power supply on or resetting of the Motion CPU and its results are stored in this device.

If communication with servo amplifier stops, it is reset.

Installation state is stored also about the axis which from non-installation to installation or from installation to non-installation after power supply on.

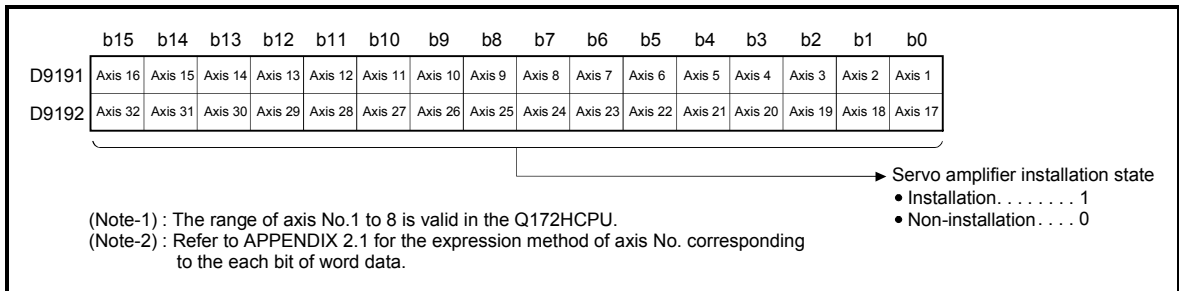

(a) Servo amplifier installation state

1) Installation/non-installation state

- "Installation" state The servo amplifier is normal.
(Communication with the servo amplifier is normal.)
- "Non-installation" state ... No servo amplifier is installed.
The servo amplifier power is off.
Normal communication with the servo amplifier is not possible due to a connecting cable fault, etc.

2) The system settings and servo amplifier installation states are shown below.

System Settings	Servo amplifier	
	Installation	Non-installation
Used (axis No. setting)	1 is stored	0 is stored
Unused	0 is stored	

4 POSITIONING DEDICATED SIGNALS

(9) Real/virtual mode switching error information (D9193 to D9195) Monitor device

When a mode switching error occurs in real-to-virtual or virtual-to-real mode switching, or a mode continuation error occurs in the virtual mode, its error information is stored.

Refer to APPENDIX 2.8 for details of the stored error code.

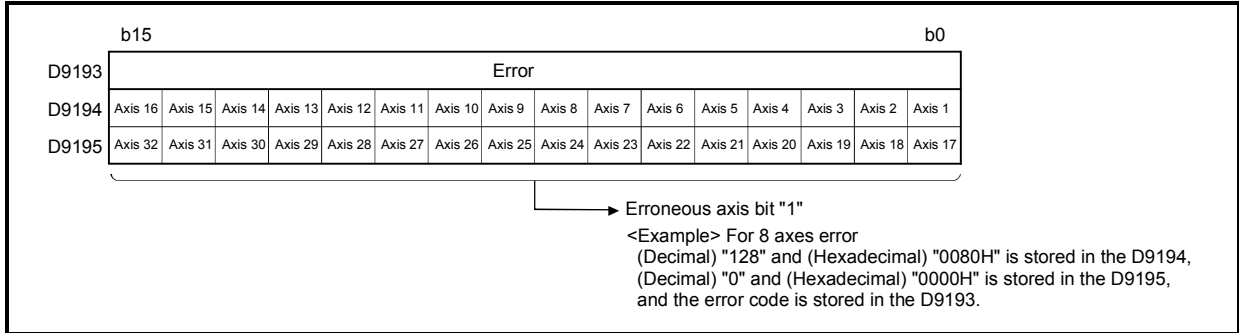

(10) PC link communication error codes (D9196) Monitor device

When an error occurs during the PC link communication, the error code is stored in this device.

PC communication error code storage register	Contents
D9196	00: No error 01: Receiving timing error 02: CRC error 03: Communication response code error 04: Received frame error 05: Communication task start error (Each error code is reset to "00" when normal communication is restarted.)

Refer to APPENDIX 2.6 for details of the PC link communication errors.

(11) Operation cycle of the Motion CPU setting (D9197) Monitor device

The setting operation cycle is stored in [μ s] unit.

When the "Automatic setting" is set in the system setting, the operation cycle corresponding to the number of setting axes. When "0.44[ms] / 0.8[ms] / 1.7[ms] / 3.5[ms] / 7.1[ms] / 14.2[ms]" is set in the system setting, the operation cycle corresponding to each setting.

(Note): If the servo amplifiers of 9 axes or more are connected to one SSCNET III system, it does not support an operation cycle of 0.4[ms]. 0.8[ms] is used as the real operation cycle, even if 0.4[ms] is set in the system setting.

(12) State of switch (D9200) Monitor device

The switch state of CPU is stored in the form of the following.

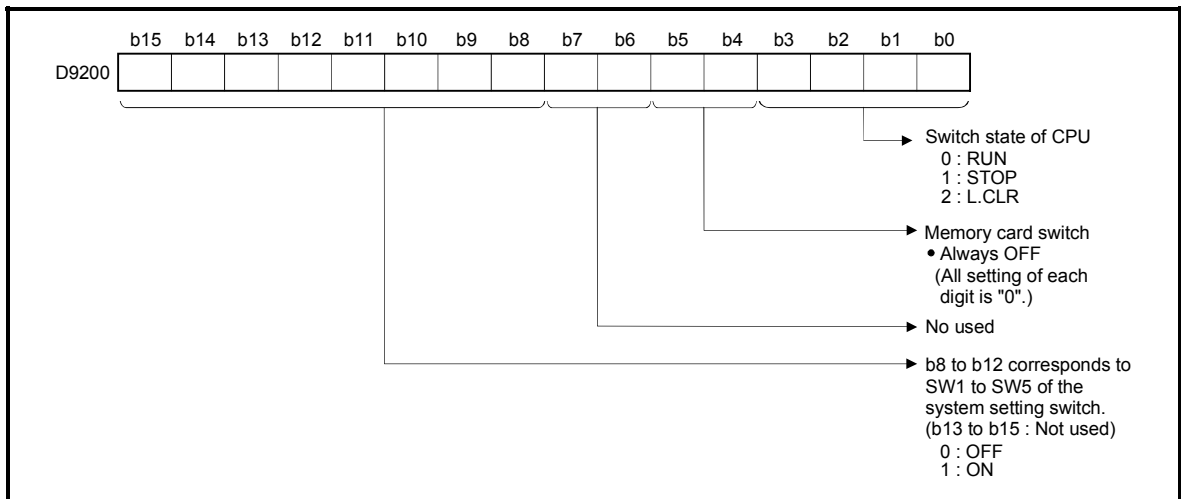

(13) State of LED (D9201) Monitor device

It stores whether the LED of CPU is in which state in next by the following bit patterns. 0 is OFF, 1 is ON and 2 is Flicker.)

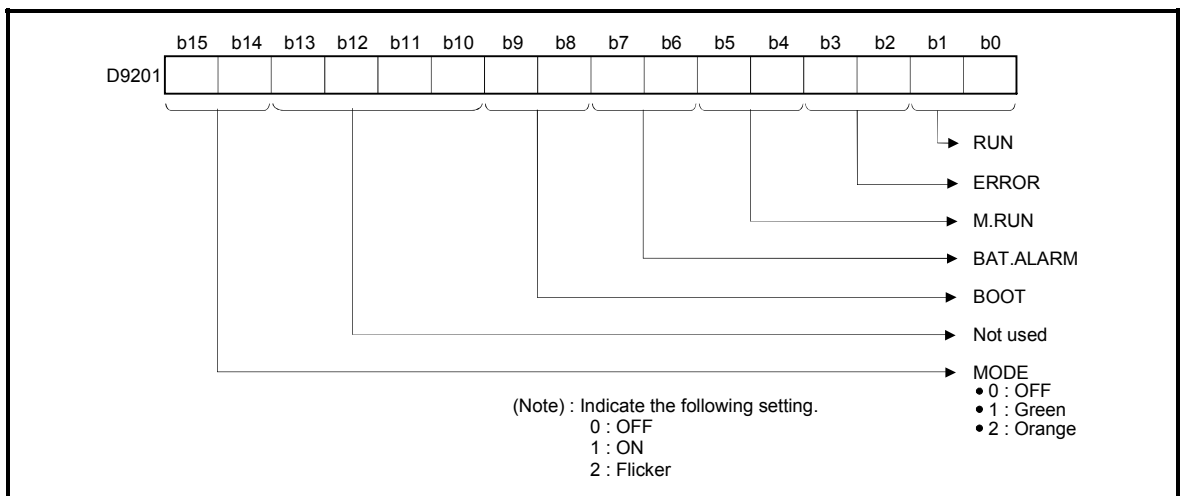

5. MECHANICAL SYSTEM PROGRAM

This section describes the mechanical system program in the virtual mode.

In the mechanical system program (Mechanical support language), what was performing synchronous control by hardware using the gear, shaft, belt, pulley, cam or infinitely variable speed changer, etc. is transposed to software, and same operation control is performed.

The mechanical system program is composed with the mechanical module connection diagram and mechanical module parameter.

- The mechanical module connection diagram shows the virtual mechanical system which connected the virtual mechanical modules.
- The mechanical module parameters are used to control of the mechanical modules used at the mechanical module connection diagram.

Refer to the mechanical module parameter lists shown in Chapters 6 to 8 for the mechanical module parameters.

5 MECHANICAL SYSTEM PROGRAM

5.1 Mechanical Module Connection Diagram

The mechanical module connection diagram shows a virtual system diagram which arranged the mechanical modules and was composed.

Configuration of the mechanical module connection is shown in Fig. 5.1 below.

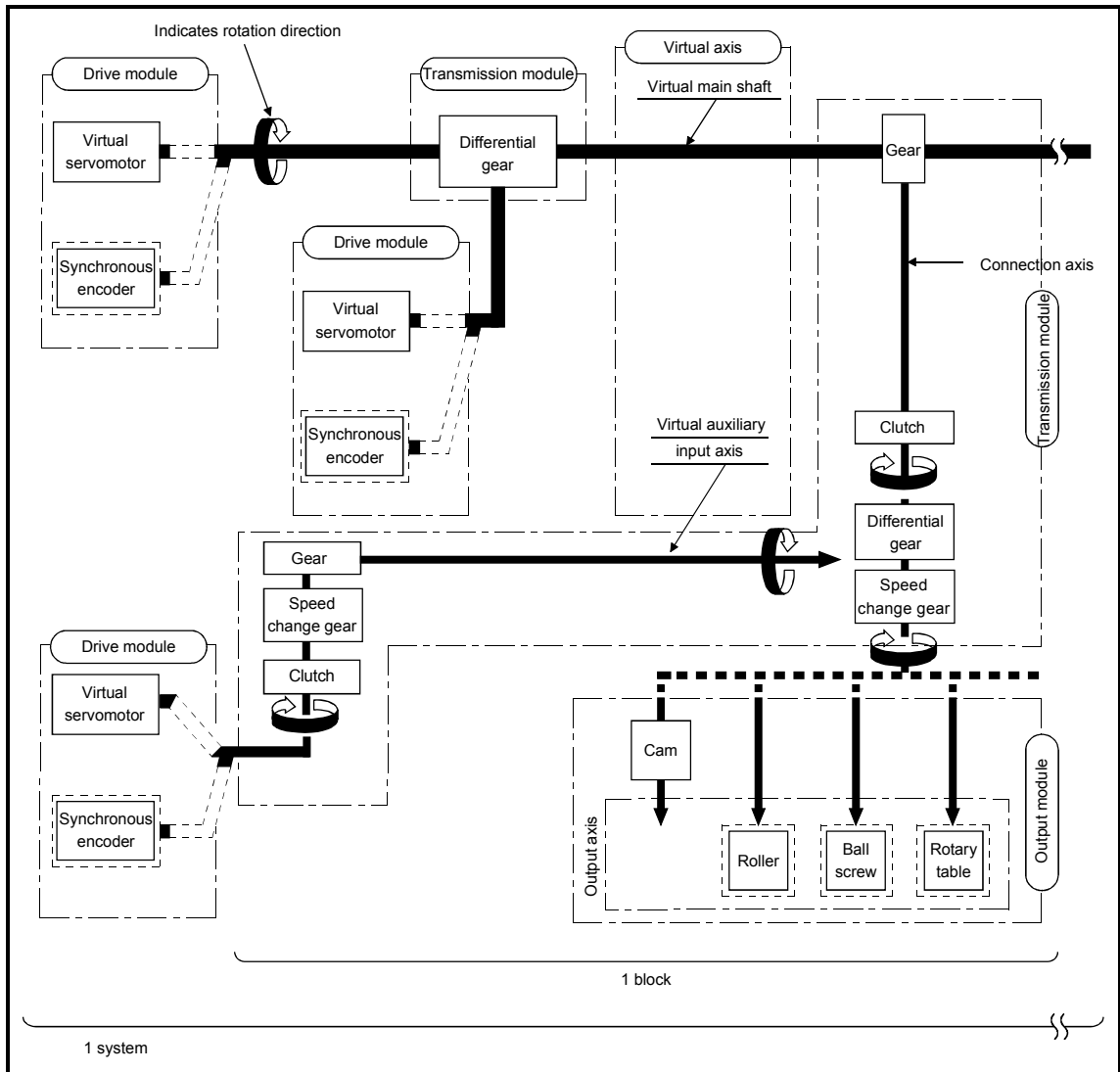

Fig. 5.1 Configuration of the Mechanical Module Connection

POINT

- (1) Either a virtual servomotor or a synchronous encoder can be connected in the drive module.
- (2) One of the cam, roller, ball screw or rotary table can be connected in the output module.

(1) Block

The term "block" is one relation from the virtual transmission module (gear) connected to the virtual main shaft to the output module.

Refer to Section 5.2 for the number of mechanical modules which can be connected in one block.

(2) System

The term "system" is a generic term of multiple blocks connected to one virtual main shaft.

The number of blocks connectable with one system is up to 32 blocks.

(3) Transmission module connections

There are 3 transmission module connection patterns:

- Pattern 1..... Without a differential gear.
- Pattern 2..... Without a speed change gear at the output side of the differential gear.
- Pattern 3..... With a speed change gear at the output side of the differential gear.

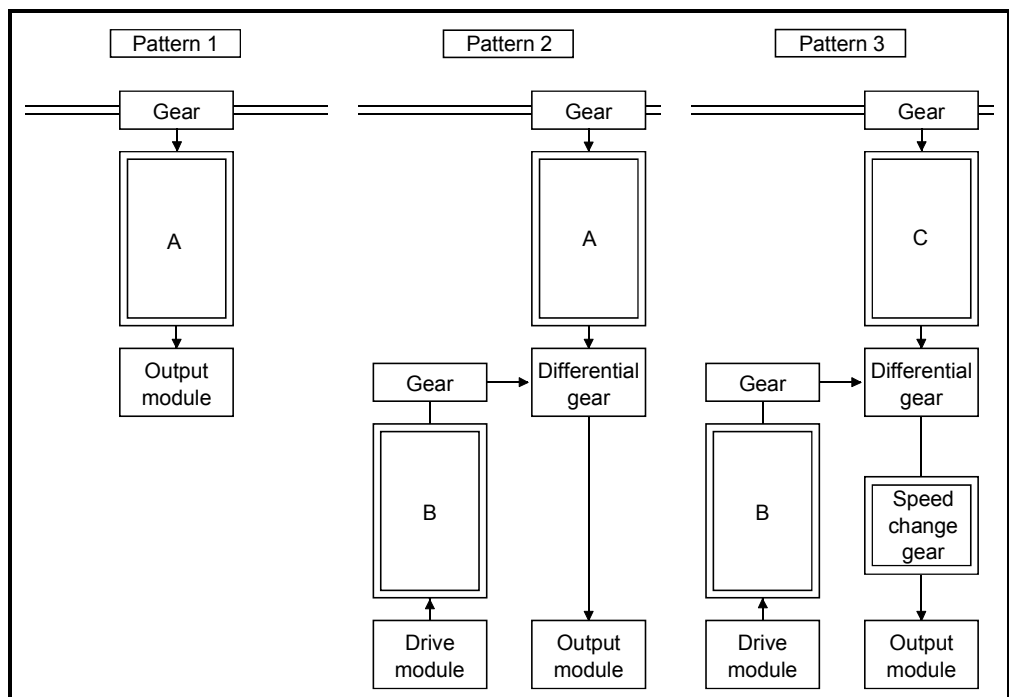

5 MECHANICAL SYSTEM PROGRAM

- (a) Transmission modules which can be connected at "A" and "B" above
- 1) A clutch, speed change gear, and "clutch + speed change gear" can be connected at "A" and "B".
 - 2) If a "clutch + speed change gear" are used, connection constraints have not restrictions.

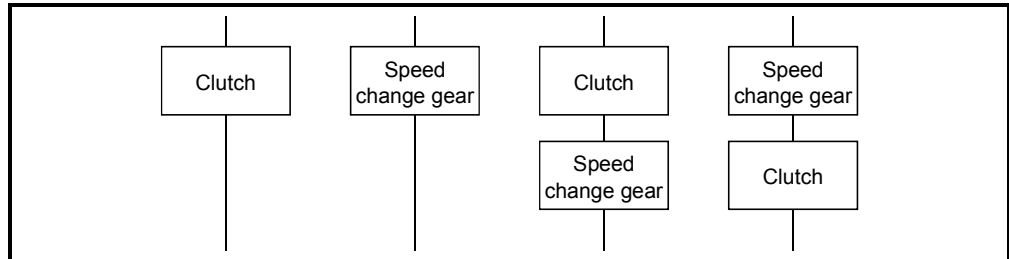











- (b) Transmission module which can be connected at "C" (pattern 3)
Only a clutch can be connected at "C".

5 MECHANICAL SYSTEM PROGRAM

5.2 Mechanical Module List

An overview of the mechanical modules used at the mechanical module connection diagrams in the virtual mode is shown in Tables 5.1. Refer to Chapter 6 to 8 for details of the each mechanical module.

Table 5.1 Mechanical Module List

Classification	Mechanical Module		Maximum Number of Usable										Function Description	Section
			Q173HCPU					Q172HCPU						
	Name	Appearance	Number Per Motion CPU module	Number Per System	Number Per Block		Number Per Motion CPU module	Number Per System	Number Per Block					
				Connection Shaft Side	Auxiliary Input Axis Side			Connection Axis Side	Auxiliary Input Axis Side					
Drive module	Virtual servomotor		32	32	—	—	8	8	—	—	<ul style="list-style-type: none"> It is used to drive the virtual axis of the mechanical system program by the servo program or JOG operation. 	Section 6.1		
	Synchronous encoder		12	12	—	—	8	8	—	—		<ul style="list-style-type: none"> It is used to drive the virtual axis by the input pulses from the external synchronous encoder. 	Section 6.2	
Virtual axis	Virtual main shaft	—	32	32	—	—	8	8	—	—	<ul style="list-style-type: none"> This is a virtual "link shaft". Drive module rotation is transferred to the transmission module. 	—		
	Virtual auxiliary input axis	—	32	32	—	—	8	8	—	—		<ul style="list-style-type: none"> This is the auxiliary input axis for input to the differential gear of transmission module. It is automatically displayed when a differential gear and gear are connected. 	—	
Transmission module	Gear		64	64	1	1	16	16	1	1	<ul style="list-style-type: none"> The drive module rotation is transmitted to the output axis. A setting gear ratio is applied to the travel value (pulse) input from the drive module, and then transmits to the output axis that it becomes in the setting rotation direction. 	Section 7.1		
	Direct clutch		64	64	1	1	16	16	1	1		<ul style="list-style-type: none"> Transmit or separate the drive module rotation to the output module. There are a direct clutch transmitted directly and the smoothing clutch which performs the acceleration/deceleration and transmission by the smoothing time constant setting at the switching ON/OFF of the clutch. It can be selected the ON/OFF mode, address mode or the external input mode depending on the application. Time constant system or slippage system can be selected as a smoothing method. 	Section 7.2	
	Smoothing clutch													
	Speed change gear		64	64	1	1	16	16	1	1		<ul style="list-style-type: none"> It is used to change the speed of output module (roller). The setting speed change ratio is applied to input axis speed, and transmits to the output axis. 	Section 7.3	
	Differential gear		32	32	1	—	8	8	1	—		<ul style="list-style-type: none"> Auxiliary input axis rotation is subtracted from virtual main shaft rotation and the result is transmitted to the output axis. Auxiliary input axis rotation is subtracted from virtual main shaft rotation, and the result is transmitted to the output axis. (Connected to the virtual main shaft) 	Section 7.4	
32			1	—	8	1	—							
Output module	Roller		32	32	1	1	8	8	1	1	<ul style="list-style-type: none"> It is used to perform the speed control at the final output. 	Section 8.1		
	Ball screw		32	32			8	8				<ul style="list-style-type: none"> It is used to perform the linear positioning control at the final output. 	Section 8.2	
	Total		32	32			8	8					<ul style="list-style-type: none"> It is used to perform the angle control at the final output. 	Section 8.3
	Rotary table		32	32			8	8						
Cam		32	32	8	8	<ul style="list-style-type: none"> It is used to control except the above. Position control is executed based on the cam pattern setting data. There are 2 cam control modes: the two-way cam and feed cam. 	Section 8.4							

6. DRIVE MODULE

The drive module is the source of drive for the virtual axis (virtual main shaft, virtual auxiliary input axis).

There are following 2 types drive module.

- Virtual servomotor Refer to Section 6.1
- Synchronous encoder Refer to Section 6.2

6.1 Virtual Servomotor

The virtual servomotor is used to operate the virtual axis (virtual main shaft, virtual auxiliary input axis) using the servo program or JOG operation.

Virtual servomotor operation and parameters are shown below.

6.1.1 Operation description

(1) Operation

When the virtual servomotor is started, the pulses are transmitted to the virtual axis (virtual main shaft, virtual auxiliary input axis) by the start conditions.

The transmitted pulses are transmitted to the output module connected via the transmission module (gear, differential gear, clutch, speed change gear).

(2) Starting method

The virtual servomotor is started using the servo program or JOG operation.

(a) Start using the servo program

The servo program of Motion SFC program (motion control step) is executed.

At this time, the start accept flag ^(Note) (M2001 to M2032) of the starting axis turns on.

Example of the Motion SFC program is shown below.

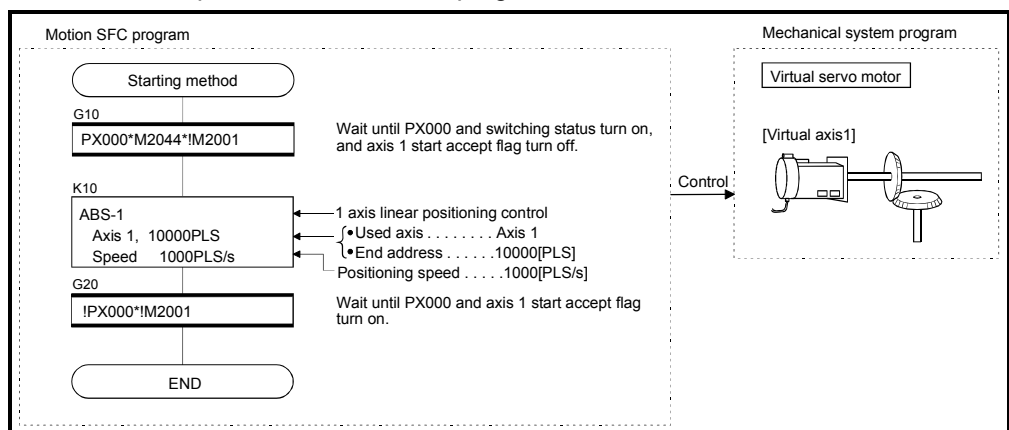

(Note) : Example of the above Motion SFC program is started using the automatic start or PLC program.

REMARK

(Note) : Refer to Section 4.1.9 (2) for details of the start accept flag.

(b) Start using the JOG operation

An individual start and simultaneous start can be executed in the JOG operation (Note-1).

1) Individual start

.....It is started by turning on the forward/reverse JOG command (Note-2) of each axis.

Motion SFC program for which executes the JOG operation is shown below.

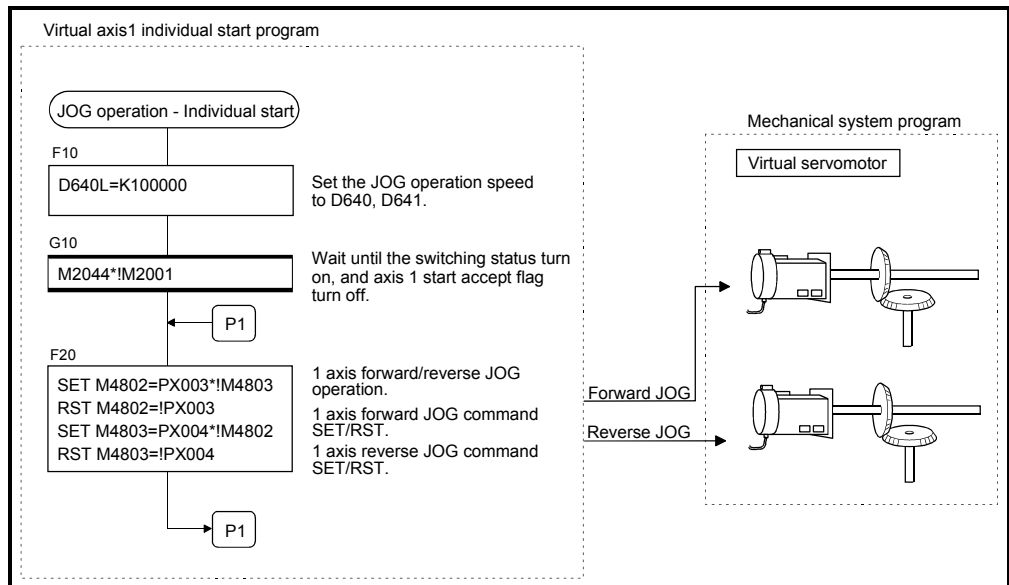

(Note) : Example of the above Motion SFC program is started using the automatic start or PLC program.

2) Simultaneous start

.....The simultaneous start axis No. and directions (forward/reverse) are set by the JOG operation simultaneous start axis setting register (D710 to D713) (Note-3), and it is started by turning on the JOG operation simultaneous start command flag (M2048) (Note-3).

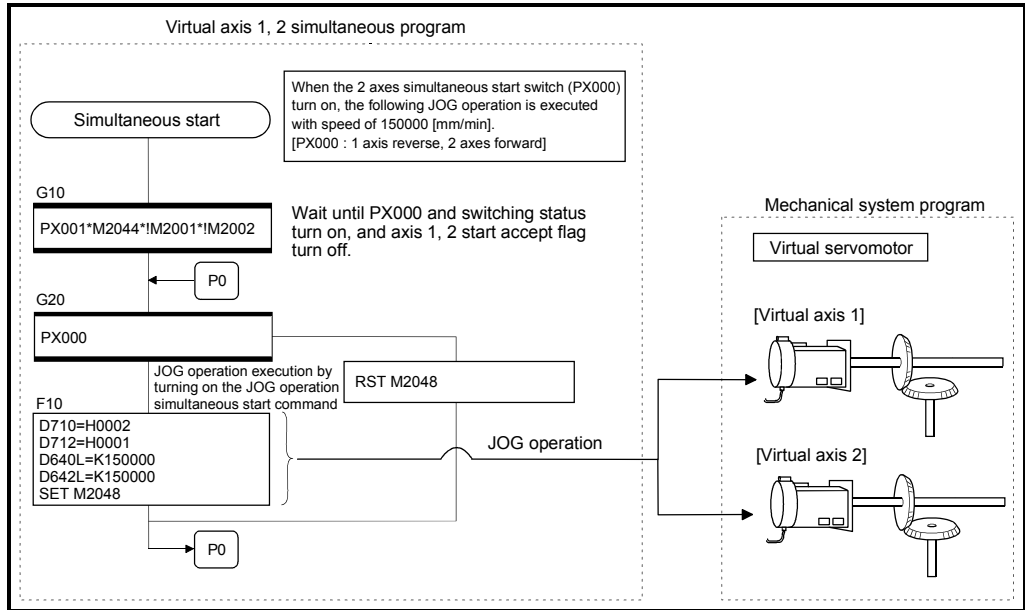

(Note) : Example of the above Motion SFC program is started using the automatic start or PLC program.

REMARK

- (Note-1) : Refer to Section "6.21 JOG Operation" of the "Q173HCPU/Q172HCPU Motion controller (SV13/SV22) Programming Manual (REAL MODE)" for details of the JOG operation.
- (Note-2) : Refer to Section 4.1.4 for details of the forward/reverse JOG start commands.
- (Note-3) : Refer to Section 4.2.8 (2) for details of the JOG operation simultaneous start axis setting registers, and Section 4.1.9 (14) for details of the JOG operation simultaneous start command.

(3) Stopping method during operation

When the virtual servomotor is stopped during operation after the start, turn the stop command (M4800+20n)/rapid stop command (M4801+20n) on using the Motion SFC program.

(There are no external stop causes (STOP, FLS, RLS) for the virtual servomotor.)

(4) Control items

(a) It is controlled as the virtual servomotor backlash compensation amount "0" at the positioning control.

(b) The deviation counter value and the real current value are not stored, so that the virtual servomotor has no feedback pulse.

(c) The feed current value of virtual servomotor is recorded in a backup memory, and it is restored at the switching from real to virtual mode after the power supply of the Multiple CPU system turned on.

1) When the output module is using the absolute position system, continuation operation is possible. However, if the servomotor of the output module connected to the virtual servomotor is operated while the power supply of the Multiple CPU system turns off, continuation operation is impossible even if the absolute position system is being used. At this time, the virtual mode continuation operation disabled warning signal ^(Note-1) turns on.

Set the virtual servomotor or servomotor of output module to the position which synchronous operation is possible.

2) When the output module is not using the absolute position system, correct the feed current value of virtual servomotor by the current value change switching from real to virtual mode.

(5) Control change

The following control changes are possible for the virtual servomotor.

- Current value change
- Speed change

Refer to the "Q173HCPU/Q172HCPU Motion controller (SV13/SV22) Programming Manual (Motion SFC)" for details of the current value change or speed change.

REMARK

(Note-1) : Refer to Section 4.1.5 (3) for details of the virtual mode continuation operation disabled warning signal.

(6) Error-time operation mode

The processings are shown below when major errors occurred with the output modules per 1 system.

The following control is executed based on the parameter settings (Refer to Section 6.1.2) of the virtual servomotor connected to the virtual main shaft.

(a) Continuation

Even if a major error occurs with the output module, the output module continues operation. At this time, the error detection signal (M2407+20n) turns on, and the applicable error code is stored in the major error code storage register.

Use the Motion SFC program for continue/stop of the system and the output module operation at the major error occurrence.

(b) Clutch OFF

If a major error occurs with the output module, the clutch within 1 system turns off and stops connected output modules. (The smoothing processing is executed by the clutch setting.)

At this time, the clutch ON/OFF command device does not turn off.

However, the clutch status storage device turns off regardless of the clutch ON/OFF command device's ON/OFF status.

Operation continues at axes where no clutch is connected.

Use the Motion SFC program to stop the drive module.

Eliminate the error cause, then turn the clutch ON/OFF command device off to on to resume the operation.

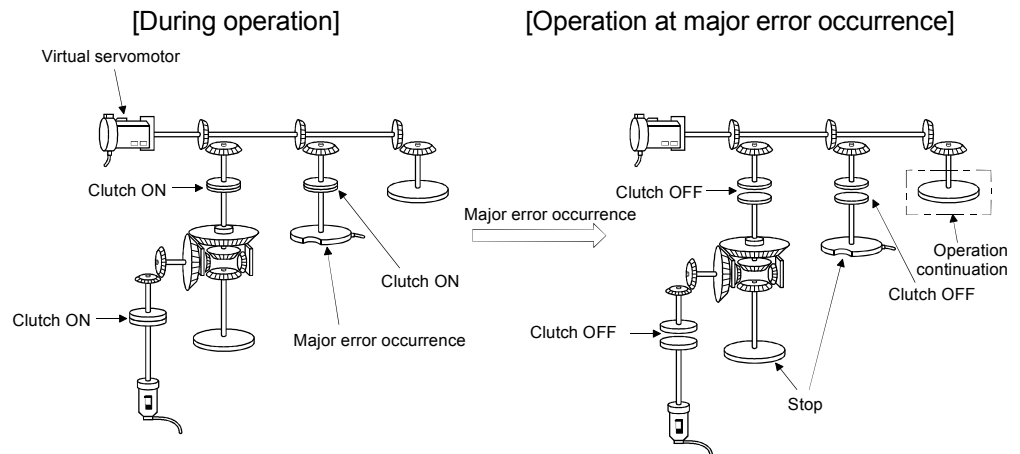

(7) Virtual servomotor axis infinite operation

By setting the upper stroke limit value and lower stroke limit value of the virtual servomotor parameters such that the "upper stroke limit value = lower stroke limit value", the stroke limit becomes invalid and infinite operation becomes possible. When the stroke limit is invalid, it is also possible for the start of the feed current value to take place in a direction that exceeds 32 bits. In this case, the feed current value is converted to a 32 bits ring address.

▶ -2147483648.....2147483647 ◀

The following operations are possible by the control mode.

Control mode	Control contents
Positioning (Linear)	<ul style="list-style-type: none"> When the ABS command is used for the start, it starts in a direction within the 32 bits range. It does not start in a direction that exceeds the 32 bits range.
Speed-switching	
Constant-speed (Linear)	<ul style="list-style-type: none"> When the INC command is used for the start, it starts in the specified direction, so it also can be start in a direction that exceeds 32 bits.
Fixed-pitch feed	<ul style="list-style-type: none"> It starts in the specified direction, it also can be start in a direction that exceeds 32 bits.
Position follow-up	<ul style="list-style-type: none"> The command address is controlled by the absolute method so it does not start in a direction that exceeds the 32 bits range.
Speed	<ul style="list-style-type: none"> Stroke is invalid. (It is ignored.) Moves in the specified direction.
JOG	
Manual pulse generator (Test mode)	
Positioning (Circular, Helical)	<ul style="list-style-type: none"> A start error (107, 108, 109) accompanies the ABS, ABH, INC or INH command and start is not possible.
Constant-speed (Circular, Helical)	

(8) Reverse return during positioning

By specifying a negative speed and making a speed change request by the CHGV instruction during the start, allow the axis start deceleration at that point and return in the opposite direction upon completion of deceleration.

The following operations by the servo instruction are shown below.

Control mode	Servo instruction	Operation
Linear control	<div style="display: flex; flex-direction: column; gap: 5px;"> <div style="display: flex; gap: 10px;">ABS-1 INC-1</div> <div style="display: flex; gap: 10px;">ABS-2 INC-2</div> <div style="display: flex; gap: 10px;">ABS-3 INC-3</div> <div style="display: flex; gap: 10px;">ABS-4 INC-4</div> </div>	<ul style="list-style-type: none"> On completion of deceleration, the axis reverses its travel direction, returns to the positioning start point at the absolute value of the specified speed, and stops (waits). For circular interpolation, the axis returns in the circular path.
Circular/helical interpolation control	<div style="display: flex; flex-direction: column; gap: 5px;"> <div style="display: flex; gap: 10px;">ABS circular ABH circular</div> <div style="display: flex; gap: 10px;">INC circular INH circular</div> </div>	
Fixed-pitch feed	<div style="display: flex; gap: 10px;"> FEED-1 FEED-2 FEED-3 </div>	
Constant-speed control	<div style="display: flex; flex-direction: column; gap: 5px;"> <div style="display: flex; gap: 10px;">CPSTART1 CPSTART2</div> <div style="display: flex; gap: 10px;">CPSTART3 CPSTART4</div> </div>	<ul style="list-style-type: none"> On completion of deceleration, the axis reverses its travel direction, returns to the preceding point at the absolute value of the specified speed, and stops (waits).
Speed control (I)	<div style="display: flex; gap: 10px;"> VF VR </div>	<ul style="list-style-type: none"> On completion of deceleration, the axis reverses its travel direction at the absolute value of the specified speed. The axis does not stop until a stop instruction is input.
Position follow-up control	<div style="border: 1px solid black; padding: 2px; display: inline-block;">PFSTART</div>	<ul style="list-style-type: none"> The axis cannot return. The speed change request is regarded as a normal speed change request. Minor error [305]^(Note) occurs and the axis is controlled at the speed limit value.
Speed-switching control	<div style="border: 1px solid black; padding: 2px; display: inline-block;">VSTART</div>	
JOG operation		

(Note) : Minor error [305]: The setting speed is outside the range of 0 to the speed limit value.

[Control contents]

- (1) If a speed change is made to a negative speed, control is executed with the control mode during the start as indicated in the front page.
- (2) The returning command speed is the absolute value of the change speed. If it exceeds the speed limit value, the minor error [305] occurs, and it is controlled the speed limit value.
- (3) When the axis is waiting at the return position
 - (a) Signal states
 - Start accept (M2001+n)..... ON (Unchanged from before execution of CHGV instruction)
 - Positioning start complete (M4000+20n)..... ON (Unchanged from before execution of CHGV instruction)
 - Positioning complete (M4001+20n)..... OFF
 - Command in-position (M4003+20n) OFF
 - Speed change "0" accepting flag (M2240+n)...ON
 - (b) Make a speed change to a positive speed for a restart.
 - (c) Turn on the stop command to end the positioning.
 - (d) A negative speed change again is ignored.
- (4) While the axis is reversion in the speed control mode
 - (a) Make a speed change to a positive speed to change the travel direction again.
 - (b) Turn on the stop command to make a stop.
 - (c) A speed change is made in the opposite direction if a negative speed change is made again.

[Error contents]

- (1) During the start of control mode which can return, if the absolute value of the negative changed speed exceeds the speed limit, the minor error [305] occurs and reversion control is executed with the speed limit value.
- (2) During the constant-speed control, if the absolute value of the negative changed speed exceeds the speed set in the servo program, reversion control is executed with the speed set in the program. (Speed clamp control for a speed change during constant-speed control) At this time, an error will not occur.
- (3) Not enabled after the initial automatic deceleration. Minor error [303] occurs.

[Operation at the constant-speed control]

The operation when a reverse return is requested for the constant-speed control is shown below.

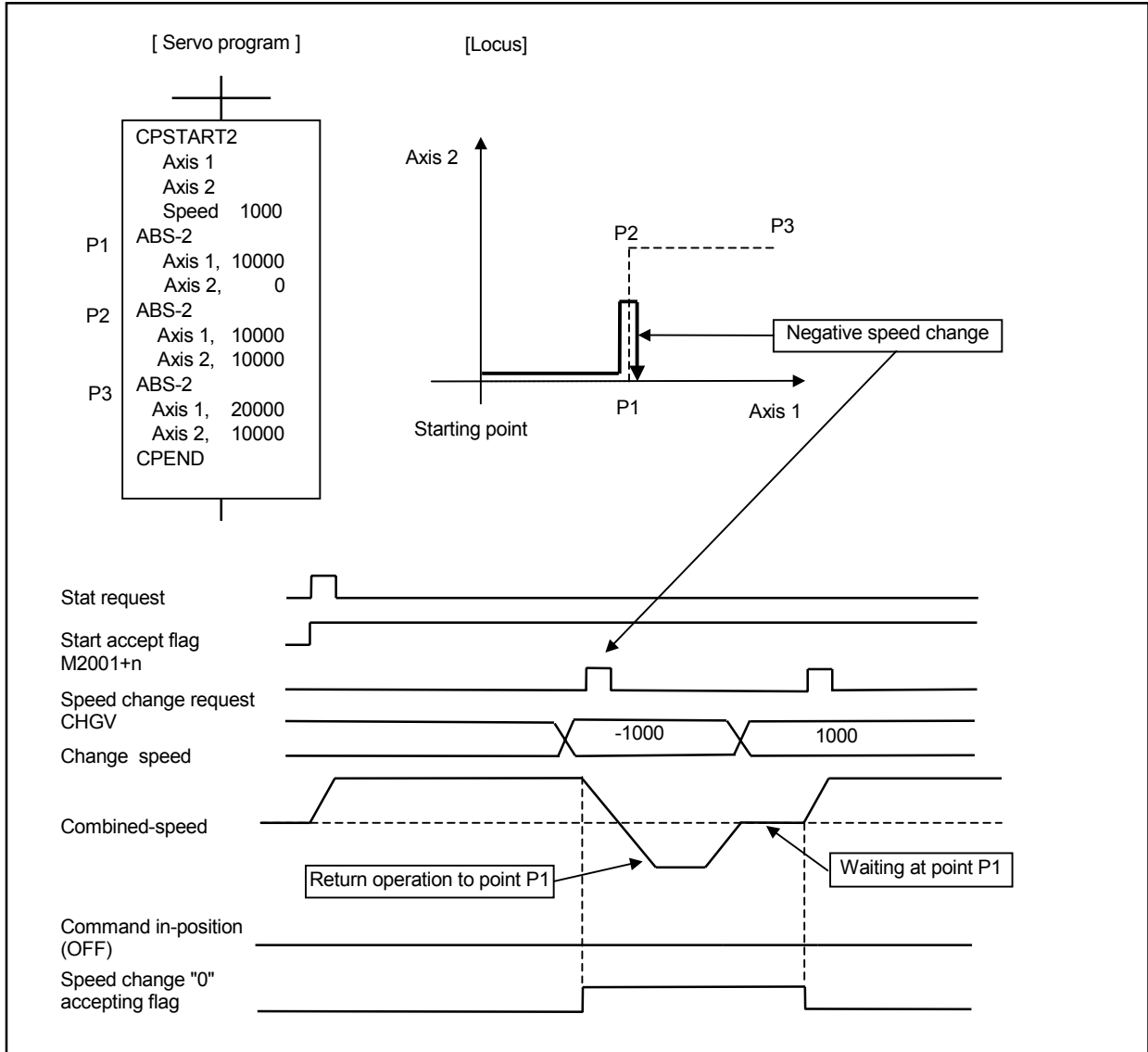

If a speed change to a negative speed is made during execution of positioning to P2 as shown above, the axis returns to P1 along the program specified locus and waits at P1.

POINT

- Precautions at the speed change
 - (1) A speed change may be invalid if the speed change is executed until the "positioning start complete signal" status changes to ON at the servo program start request . When making a speed change at almost the same timing as a start, always create a program which will execute the speed change after the "positioning start complete signal" has turned on.
 - (2) When the M-code FIN signal wait function is used in the constant-speed control and reverse return is requested during stop in the FIN wait, it is ignored.
 - (3) In the above example, if reverse return is requested before P2 and the axis passes through P2 during deceleration, it return to P2.
 - (4) There will be a delay of time equivalent to an operation cycle at the maximum in the response time from when the CHGV instruction is executed until the speed begins to change actually.

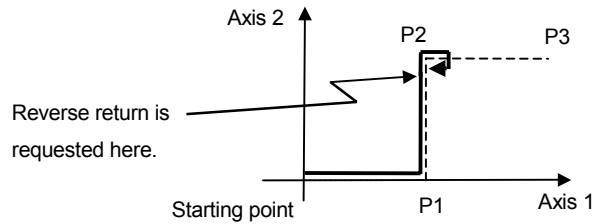

6.1.2 Parameter list

The virtual servomotor parameters are shown in Table 6.1 and the parameters shown in this table are explained in items (1) to (4) below.

Refer to the help of SW6RN-GSV22P for the parameter setting method of virtual servomotor.

A parameter is requested except for the above for program operation of the virtual servomotor. Refer to the item (5) for precautions of the parameter blocks.

Table 6.1 Virtual Servomotor Parameter List

No.	Setting item	Default value		Setting range		
1	Virtual axis No.	—	—	Q173HCPU : 1 to 32 Q172HCPU : 1 to 8	—	
2	Upper stroke limit value	2147483647	PLS	-2147483648 to 2147483647	PLS	
3	Lower stroke limit value	0	PLS	-2147483648 to 2147483647	PLS	
4	Command in-position range	100	PLS	1 to 32767	PLS	
5	JOG operation-time	JOG speed restriction	200000	PLS/s	1 to 2147483647	PLS/s
6	parameter	Parameter block No.	1	—	1 to 64	—
7	Operation mode at error occurrence	Continuation	—	Continuation/Clutch OFF	—	

(1) Virtual axis No. setting

The virtual axis No. is set in the servo program at the virtual mode operation. The axis No. of the virtual servomotor connected to the virtual main shaft or virtual auxiliary input axis.

(2) Upper/lower stroke limit value settings

The stroke limit range of the virtual servomotor axis is set.

(a) When the stroke limit value is made valid:

Set the stroke range of the "Lower stroke limit value < upper stroke limit value".

The stroke limit check and control details at the start/during start are shown below.

Control mode		Error check ^(Note)				Remarks
		At start	During start			
		106	207	208	220	
Positioning	Linear	○	—	—	—	Start in the return direction in a stroke limit range from outside the stroke limit range is possible.
	Circular	○	○	○	—	
Fixed-pitch feed		○	—	—	—	
Speed-switching		○	○	○	—	
Constant-speed/Helical		○	○	○	—	
Position follow-up		○	○	—	○	
Speed		—	—	—	—	Stroke limit is invalid.
JOG		—	○	—	—	Start in the return direction in a stroke limit range from outside the stroke limit range is possible.
Manual pulse generator		—	○	○	—	Start in the return direction in a stroke limit range from outside the stroke limit range is possible.

(Note) : ○ Code detected at the error check.

<Error check at start>

Error code	Contents	Operation
106	Command position is outside the stroke limit range at start.	Operation does not start.

<Error check during start>

Error code	Contents	Operation
207	Feed current value is outside the stroke limit range during start.	Deceleration stop.
208	Feed current value of another axis is outside the stroke limit range at the circular interpolation start.	
220	Command address is outside the stroke limit range during position follow-up control.	

(b) When the stroke limit value is invalid.

Set the stroke range of the "Lower stroke limit value = upper stroke limit value".

When the stroke limit is invalid, feed current value startup in a direction that exceeds 32 bits is possible.

In such a case the feed current value is converted to a 32 bit ring address.

▶ -2147483648.....2147483647 ◀

The following operations are possible by the control mode.

Control mode	Control contents
Positioning (Linear)	<ul style="list-style-type: none"> When the ABS command is used at the start, it starts in a direction within the 32 bits range. It does not start in a direction that exceeds the 32 bits range.
Speed-switching	
Constant-speed (Linear)	<ul style="list-style-type: none"> When the INC command is used at the start, it starts in the specified direction, so it also can be start in a direction that exceeds 32 bits.
Fixed-pitch feed	<ul style="list-style-type: none"> It starts in the specified direction, it also can be start in a direction that exceeds 32 bits.
Position follow-up	<ul style="list-style-type: none"> The command address is controlled by the absolute method so it does not start in a direction that exceeds the 32 bits range.
Speed	<ul style="list-style-type: none"> Stroke is invalid. (It is ignored.) Travel in the specified direction.
JOG	
Manual pulse generator	
Positioning (Circular, Helical)	<ul style="list-style-type: none"> A start error (107, 108, 109) occurs in the ABS, ABH, INC or INH command and start is not possible.
Constant-speed (Circular, Helical)	

(3) Command in-position range

The command in-position is the difference between the positioning address (command position) and feed current value.

Once the value for the command in-position has been set, the command in-position signal (M2403 + 20n) turns on when the difference between the command position and the feed current value enters the set range $[(\text{command position} - \text{feed current value}) \leq (\text{command in-position range})]$.

The command in-position check is executed, continuously during position control. (The command in-position range is not checked during the speed control and JOG operation.)

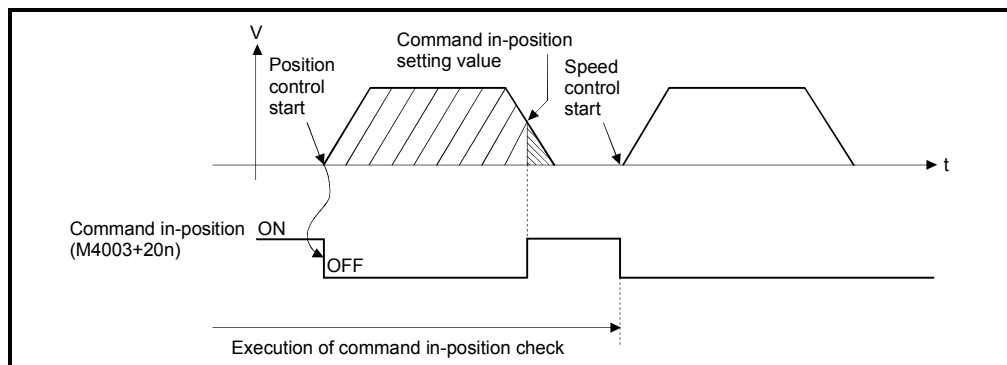

Fig. 6.1 Command in-position range

(4) Setting of the JOG speed restriction and parameter block No.

The JOG speed restriction and parameter block No. used in the JOG operation are shown below.

(a) JOG speed restriction

This is the maximum speed setting at the JOG operation for virtual axis. If the JOG speed exceeds the JOG speed restriction, the JOG speed is controlled with the JOG speed restriction.

(b) Parameter block No. setting

This is the parameter block No. setting at the JOG operation.

The following parameter block data items are valid in the JOG operation.

- Acceleration time
- Deceleration time
- Rapid stop deceleration time

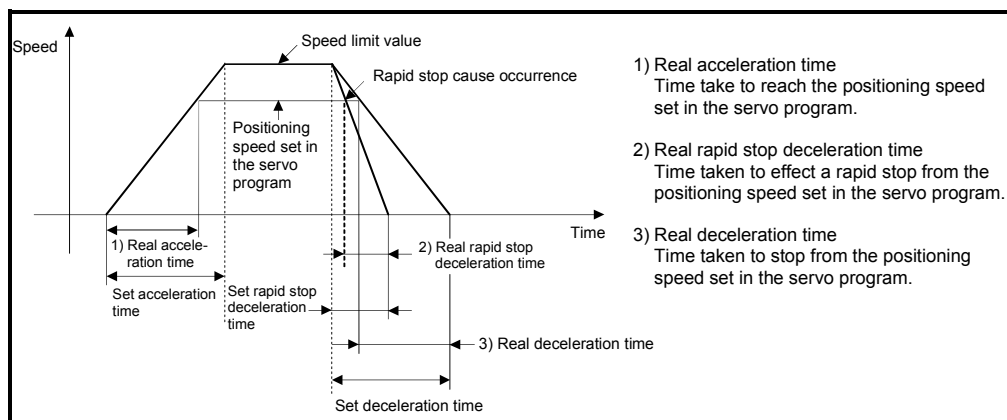
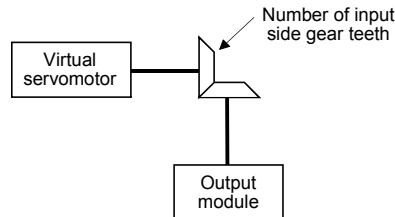

Fig. 6.2 Relationships between the JOG speed restriction, acceleration time, deceleration time and rapid stop time

POINT

- (1) Unit is fixed at [PLS] regardless of the interpolation control unit setting of parameter block in the JOG operation.
- (2) Even if the JOG speed of virtual servomotor is within the JOG speed restriction, when the JOG speed has not satisfied the condition " $(\text{Command speed [PLS/s]} \times \text{Operation cycle [ms]} \times \text{Number of input side gear teeth}) < 2147483647 \times 10^3$ ", the speed of output module becomes abnormal. Be sure to use within the range of above conditional expression.



(Example) Relation between an operation cycle, number of input side gear teeth and maximum speed

Operation cycle [ms]	Speed [Unit: PLS/s]		
	Number of input side gear teeth		
	1	10000	65535
0.88	2147483647	225000000	34332800
1.77		112500000	17166400
3.55		56250000	8583200
7.11		28125000	4291600
14.2		14062500	2145800

REMARK

Regardless of the speed limit value of parameter block for also program start of virtual servomotor, when the command speed has not satisfied the condition " $(\text{Command speed [PLS/s]} \times \text{Operation cycle [ms]} \times \text{Number of input side gear teeth}) < 2147483647 \times 10^3$ ", the speed of output module becomes abnormal. Be sure to use within the range of above conditional expression.

- (5) The parameter block No. for the program operation of virtual servomotor is set in the servo program for virtual mode. (If the parameter block No. setting is omitted, it is controlled with the contents of parameter block No.1.)

The valid parameter block data are shown below.

Item	Control unit
Interpolation control unit	[PLS] only ^(Note-1)
Speed limit value	[PLS/s] only ^(Note-1)
Acceleration time	○
Deceleration time	○
Rapid stop deceleration time	○
S-curve ratio	○
Torque limit value	× ^(Note-2)
STOP input-time deceleration processing	×
Circular interpolation error permissible range	[PLS] only ^(Note-1)

○: Valid, ×: Invalid

(Note-1) : If it is set except for the [PLS] or [PLS/s], the program operation is executed as [PLS] automatically.

(Note-2) : It is set for every output module with a parameter of output module.

<Example>

Item	Specified parameter block setting value	Value used for the program operation
Interpolation control unit	[mm]	[PLS]
Speed limit value	2000.00[mm/min]	200000[PLS/s]
Acceleration time	1000[ms]	1000[ms]
Deceleration time	1000[ms]	1000[ms]
Rapid stop deceleration time	1000[ms]	1000[ms]
S-curve ratio	0[%]	0[%]
Torque limit value	300[%]	—
STOP input-time deceleration processing	Deceleration stop	—
Circular interpolation error permissible range	0.0100[mm]	100[PLS]

6.1.3 Virtual servomotor axis devices (Internal relays, data registers)

(1) Virtual servomotor axis status

Refer to Section 4.1.3 for details of the virtual servomotor axis statuses.

(2) Virtual servomotor axis command signal

Refer to Section 4.1.4 for details of the virtual servomotor axis command signals.

(3) Virtual servomotor axis monitor device

Refer to Section 4.2.3 for details of the virtual servomotor axis monitor devices.

(4) Current value after virtual servomotor axis main shaft's differential gear

Refer to Section 4.2.4 for details of the current value after virtual servomotor axis main shaft's differential gear.

6.2 Synchronous Encoder

The synchronous encoder is used to operate the virtual axis (virtual main shaft, virtual auxiliary input axis) with the external input pulse.

Synchronous encoder operation and parameters are shown below.

6.2.1 Operation description

(1) Operations

Although a synchronous encoder does not need to start using the servo program etc. in order to operate it by external devices, it needs cautions for the timing which begins to input the input pulse from a synchronous encoder.

The input timing from a synchronous encoder is shown below.

(a) Operation start

The input timing of input pulse from an external synchronous encoder is shown below.

- At the switching from real to virtual mode
- At the external signal ^(Note-2) (TREN : Synchronous encoder input start signal) input

1) When the input pulse is started to input at the switching from real mode to virtual mode.

a) The input pulse is inputted from the external synchronous encoder at the switching from real mode to virtual mode.

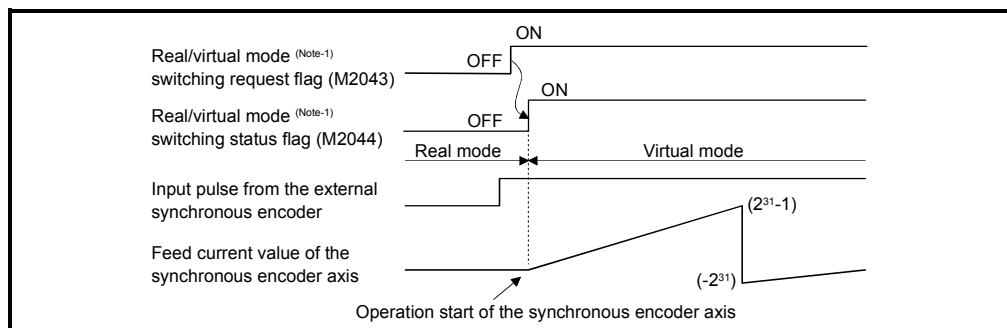

b) The control mode ^(Note-3) of a clutch is operation in the case of ON/OFF mode and address mode. It can be used with the synchronous encoder for the incremental/absolute data method.

c) It depends on the state of connected clutch whether synchronous encoder operation is transmitted or not to the output module.

- Clutch ON Transmit to the output module.
- Clutch OFF Not transmit to the output module.

! CAUTION

- If the mode is switched from real to virtual mode in the state of clutch ON, use the smoothing clutch. If the direct clutch is used and the mode is switched from real to virtual mode in the state of clutch ON, the rapid acceleration occurs at the output module axis, causing a servo error, and the machine will be subjected to a jolt.

- 2) When the input pulse is inputted from an external synchronous encoder.
 - a) The input pulse is started to input from the external synchronous encoder, when the clutch is switched on.

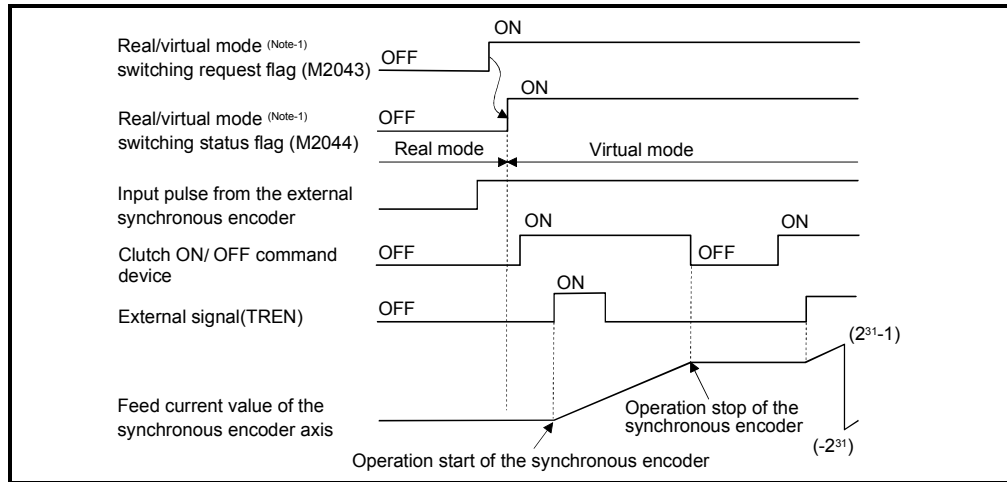

- b) The control mode ^(Note-3) of a clutch is operation in the case of external input mode. Operation of the synchronous encoder and clutch corresponds. It can be used with the synchronous encoder for the incremental data method only.

(b) Operation end

- 1) Operation of the synchronous encoder axis is executed the real/virtual mode switching request (M2043 : ON → OFF) and ends at the switching to real mode.
- 2) The procedure for ending operation of the synchronous encoder axis is shown below.
 - a) Stop the output module
 - Stop the external synchronous encoder.
 - Switch the connected clutch OFF.
 - b) Switch from the virtual to real mode.

! CAUTION

- If the mode is switched from virtual to real mode while the synchronous encoder and connected output module are operating, the rapid stop occurs at the output module axis, causing a servo error, and the machine will be subjected to a jolt.

REMARK

(Note-1) : Refer to Section 4.1.9 (9) and 4.1.9 (10) for details of the real/virtual mode switching request flag and real/virtual mode switching status flag.

Refer to Chapter 9 for switching of the real to virtual mode.

(Note-2) : The synchronous encoder input start signal is inputted to the Q173PX "TREN" terminal.

Refer to the "Q173HCPU/Q172HCPU User's Manual" for details of the Q173PX "TREN" terminal.

(Note-3) : Refer to Section 7.2.1 for details of the clutch control mode.

(c) Stopping method

Stop the external synchronous encoder for stopping the external synchronous encoder.

There are no external inputs (FLS, RLS, STOP) or stop command/rapid stop command from the Motion SFC program for the synchronous encoder.

(d) Control items

1) The deviation counter value and the real current value are not stored, so that the synchronous encoder has no feedback pulse.

2) The current value of synchronous encoder is recorded in a backup memory, and it is restored at the switching from real to virtual mode after the power supply of the Multiple CPU system turned on.

a) When the output module is using the absolute position system, continuation operation is possible. However, if the servomotor of the output module connected to the synchronous encoder or synvchronoue encoder is operated while the power supply of the Multiple CPU system turns off, continuation operation is impossible even if the absolute position system is being used.

At this time, the virtual mode continuation operation disabled warning signal turns on.

Set the servomotor of output module to the position which synchronous operation is possible.

b) When the output module is not using the absolute position system, correct the feed current value by the current value change switching from real to virtual mode.

(e) Control change

The following current value change is possible for the synchronous encoder.

Refer to Section 7.3 of the "Q173HCPU/Q172HCPU Motion controller (SV13/SV22) Programming Manual (Motion SFC)" for details of the current value change.

(f) Error-time operation mode

The processings are shown below when major errors occurred with the output modules per 1 system.

The following control is executed based on the parameter settings (Refer to Table 6.2) of the synchronous encoder connected to the virtual main shaft.

1) Continuation

Even if a major error occurs with the output module, the output module continues operation. At this time, the error detection signal (M2407+20n) turns on, and the applicable error code is stored in the major error code storage register.

Use the Motion SFC program for continue/stop of the system and the output module operation at the major error occurrence.

2) Clutch OFF

If a major error occurs with the output module, the clutch within 1 system turns off and stops connected output modules.

At this time, the clutch ON/OFF command device does not turn off.

However, the clutch status storage device turns off regardless of the clutch ON/OFF command device's ON/OFF status.

Operation continues at axes where no clutch is connected.

Use the Motion SFC program to stop the drive module.

Eliminate the error cause, then turn the clutch ON/OFF command device off to on to resume the operation.

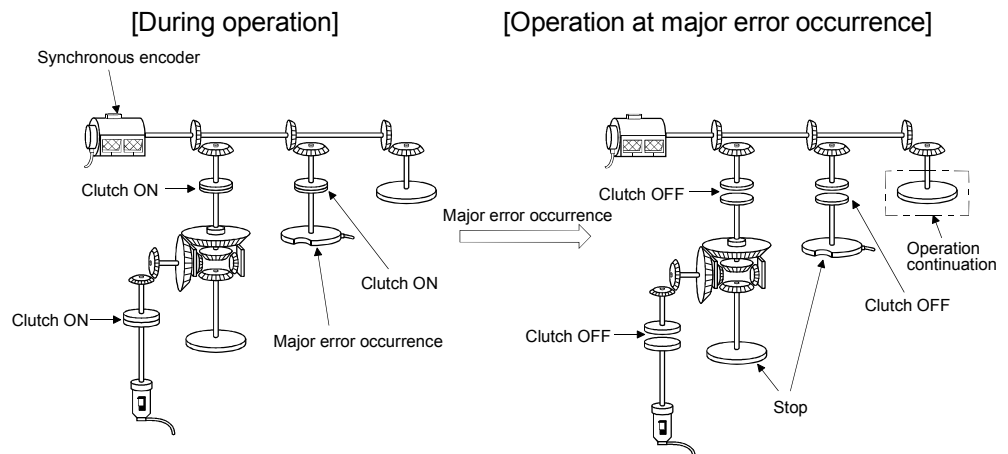

6.2.2 Parameter list

The synchronous encoder parameters are shown in Table 6.2 and the parameters shown in this table are explained in items (1) below.

Refer to the help of SW6RN-GSV22P for the parameter setting method of synchronous encoder.

Table 6.2 Synchronous Encoder Parameter List

No.	Setting item	Default value	Setting range
1	Synchronous encoder No.	—	Q173HCPU : 1 to 12 Q172HCPU : 1 to 8
2	Error-time operation mode	Continuation	Continuation/ Clutch OFF

(1) Synchronous encoder No.

The synchronous encoder No. is set connected to the Q172EX/Q173PX.

Connecting position of the Q172EX/Q173PX	Synchronous encoder No.
P1/E1	1
P2/E2	2
P3/E3	3
P4/E4	4
P5/E5	5
P6/E6	6
P7/E7	7
P8/E8	8
P9/E9	9
P10/E10	10
P11/E11	11
P12/E12	12

P1 to P12: Connect to the Q173PX.

This is incremental type synchronous encoders.

E1 to E12: Connect to the Q172EX.

This is absolute synchronous encoder.

REMARK

(Note-1) : The absolute and incremental synchronous encoders can be used (set) together.

(Note-2) : The synchronous encoder No.1 to 8 are valid in the Q172HCPU.

6.2.3 Synchronous encoder axis devices (Internal relays, data registers)

(1) Synchronous encoder axis status

Refer to Section 4.1.5 for details of the synchronous encoder axis statuses.

(2) Synchronous encoder axis command signal

Refer to Section 4.1.6 for details of the synchronous encoder axis command signals.

(3) Synchronous encoder axis monitor device

Refer to Section 4.2.5 for details of the synchronous encoder axis monitor devices.

(4) Current value after synchronous encoder axis main shaft's differential gear

Refer to Section 4.2.6 for details of the current value after synchronous encoder axis main shaft's differential gear.

6 DRIVE MODULE

6.3 Virtual Servomotor/Synchronous Encoder Control Change

The current value change and JOG speed change of the virtual servomotor and the current value of synchronous encoder.

Refer to the "Q173HCPU/Q172HCPU Motion controller (SV13/SV22) Programming Manual (Motion SFC)" for details of the current value change/speed change.

6.3.1 Virtual servomotor control change

(1) Control change registers

Axis No.	Device No.	Signal name						
1	D640, D641							
2	D642, D643							
3	D644, D645	0						
4	D646, D647	1	JOG speed setting	○	○	/	At start	Command signal
5	D648, D649							
6	D650, D651							
7	D652, D653							
8	D654, D655							
9	D656, D657							
10	D658, D659							
11	D660, D661							
12	D662, D663							
13	D664, D665							
14	D666, D667							
15	D668, D669							
16	D670, D671							
17	D672, D673							
18	D674, D675							
19	D676, D677							
20	D678, D679							
21	D680, D681							
22	D682, D683							
23	D684, D685							
24	D686, D687							
25	D688, D689							
26	D690, D691							
27	D692, D693							
28	D694, D695							
29	D696, D697							
30	D698, D699							
31	D700, D701							
32	D702, D703							

○: Valid

(Note-1) : The range of axis No.1 to 8 is valid in the Q172HCPU.

(Note-2) : Device area of 9 axes or more is unusable in the Q172HCPU.

- (a) JOG speed setting registers (D640+2n, D641+2n) Command device
 - 1) This register stores the JOG speed at the JOG operation.
 - 2) Setting range of the JOG speed is 1 to 2147483647 [PLS/s].
 - 3) The JOG speed is the value stored in the JOG speed setting registers when the JOG start signal turns off to on.

Even if data is changed during JOG operation, JOG speed cannot be changed.

(Note) : Refer to Section 6.21 of the "Q173HCPU/Q172HCPU Motion controller (SV13/SV22) Programming Manual (REAL MODE)" for details of the JOG operation.

(2) Current value change

- (a) Current value change by the CHGA instruction

Motion SFC program for which executes the servo program is shown below. Current value change program of the virtual servomotor (When 1 axis feed current value of the virtual servomotor is changed to 1000 PLS.)

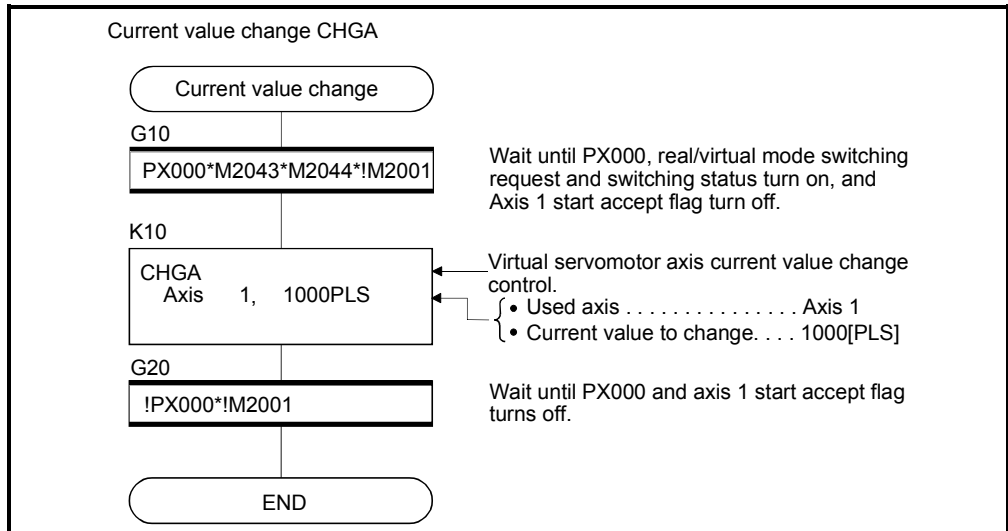

(Note) : Example of the above Motion SFC program is started using the automatic start or PLC program.

6.3.2 Synchronous encoder control change

(1) Current value change by the CHGA-E instruction

Motion SFC program for which executes the servo program is shown below.

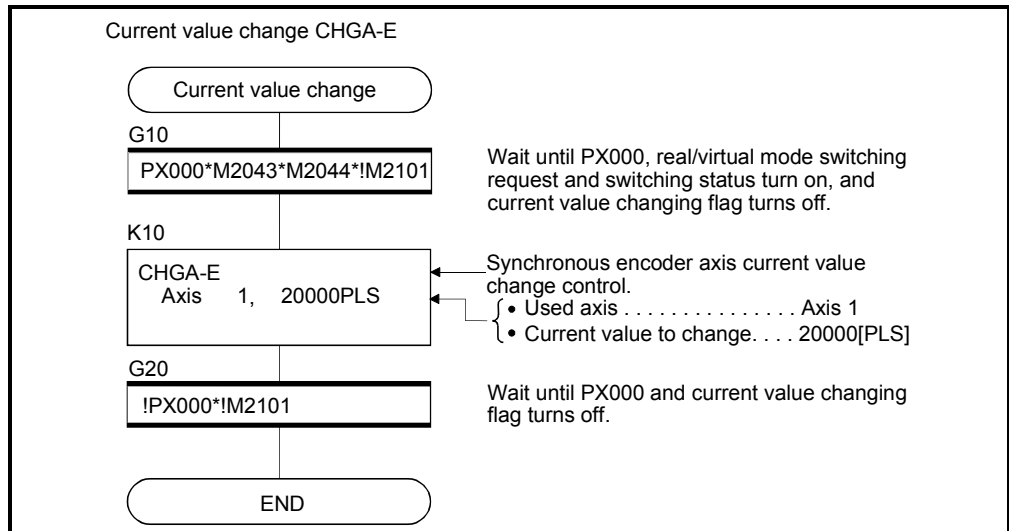

(Note) : Example of the above Motion SFC program is started using the automatic start or PLC program.

(a) The current value to change uses the following devices.

- Indirect setting..... Data register (D)
 - Link register (W)
 - Motion register (#)
 } 2 word
- Direct setting Decimal constant (K)

(b) Precautions

- When the synchronous encoder current value is changed in the real mode, an error occurs and the current value change is not executed.
- The synchronous encoder current value change can be executed even during operation in the virtual mode operation (during pulse input from the synchronous encoder).
When the current value is changed, the synchronous encoder current value will be continued from the changed value.
- Even if a synchronous encoder current value is changed, it will have no effect on the output module current value.

7. TRANSMISSION MODULE

The transmission module transmits the pulse outputted from the drive module to output module.

There are following 4 types transmission modules.

- Gear Section 7.1
- Clutch Section 7.2
- Speed change gear Section 7.3
- Differential gear Section 7.4

The device range and setting procedure for indirect setting in the parameter setting of the transmission module are show below.

(1) Device range

The number of device words and device range at the indirect setting are shown below.

Module	Item	Number of device words	Device setting range	Remark														
Clutch	Clutch ON/OFF command device	Bit	<table border="1"> <thead> <tr> <th>Device</th> <th>Range</th> </tr> </thead> <tbody> <tr> <td>X</td> <td>0000 to 1FFF</td> </tr> <tr> <td>Y</td> <td>0000 to 1FFF</td> </tr> <tr> <td>M/L</td> <td>0 to 8191</td> </tr> <tr> <td>M</td> <td>9000 to 9255</td> </tr> <tr> <td>B</td> <td>0000 to 1FFF</td> </tr> <tr> <td>F</td> <td>0 to 2047</td> </tr> </tbody> </table>	Device	Range	X	0000 to 1FFF	Y	0000 to 1FFF	M/L	0 to 8191	M	9000 to 9255	B	0000 to 1FFF	F	0 to 2047	
			Device	Range														
			X	0000 to 1FFF														
			Y	0000 to 1FFF														
			M/L	0 to 8191														
			M	9000 to 9255														
B	0000 to 1FFF																	
F	0 to 2047																	
Mode setting device	1	<table border="1"> <thead> <tr> <th>Device</th> <th>Range</th> </tr> </thead> <tbody> <tr> <td>D</td> <td>800 to 3069 3080 to 8191</td> </tr> <tr> <td>W</td> <td>0000 to 1FFF</td> </tr> </tbody> </table>	Device	Range	D	800 to 3069 3080 to 8191	W	0000 to 1FFF										
Device	Range																	
D	800 to 3069 3080 to 8191																	
W	0000 to 1FFF																	
Clutch ON address setting device	2																	
Clutch OFF address setting device	2																	
Slippage setting device	2																	
Slippage in-position range setting device	2																	
Gear	Input axis side tooth count	1																
	Output axis side tooth count	1																
Speed change gear	Speed change ratio setting device	1																

POINT

- (1) Be sure to set an even-numbered device for the items set as 2-word. And, when the data is set to device in the Motion SFC program, set it as 32-bit integer type.
- (2) When a 2-word monitor device is read in the Motion SFC program, read it as 32-bit integer type.

7 TRANSMISSION MODULE

(2) Device data input

The all device data set indirectly is inputted as "initial value" at the switching from real to virtual mode, thereafter the input control for module is executed during the virtual mode operation.

The input timing of each setting device and refresh cycle of setting device are shown below.

Module	Item	Input device	Refresh device	Device input timing		Refresh cycle
				Real→ Virtual mode switching	During the virtual mode operation	
Clutch	Clutch ON/OFF command device	○	—	○	Input for every operation cycle (Note).	—
	Mode setting device	○	—	○		
	Clutch ON address setting device	○	—	○		
	Clutch OFF address setting device	○	—	○		
	Slippage setting device	○	—	○	—	
	Slippage in-position range setting device	○	—	○	—	
Gear	Input axis side tooth count	○	—	○	Input when the current value change of the connection source drive module (virtual servomotor axis/synchronous encoder axis) is executed and the gear ratio is changed.	—
	Output axis side tooth count	○	—	○		
Speed change gear	Speed change ratio setting device	○	—	○	Input for every operation cycle (Note).	—

REMARK

(Note) : The operation cycle is set in the "operation cycle setting" of system basic setting.

Refer to the "Q173HCPU/Q172HCPU Motion controller Programming Manual (COMMON)" for details of setting contents.

The operation cycle of Motion CPU is shown below.

Item		Q173HCPU	Q172HCPU
Number of control axes		Up to 32 axes	Up to 8 axes
Operation cycle (Default)	SV22	0.88[ms] / 1 to 5 axes 1.77[ms] / 6 to 14 axes 3.55[ms] / 15 to 28 axes 7.11[ms] / 29 to 32 axes	0.88[ms] / 1 to 5 axes 1.77[ms] / 6 to 8 axes

7 TRANSMISSION MODULE

7.1 Gear

This section describes the gear operation and the parameters required to use a gear.

7.1.1 Operation

Relation between the number of pulses outputted from the synchronous encoder or virtual servomotor and the output module is adjusted by parameter setting of the encoder resolution of servomotor, the gear ratio in consideration of the deceleration ratio for machine system etc. and rotation direction.

The gear operation is shown below.

- (1) The gear transmits the number of pulses which applied the gear ratio set in the gear parameter to the travel value (number of pulses) of drive module (virtual servomotor, synchronous encoder).

$$\left[\begin{array}{c} \text{Number of output} \\ \text{axis pulses} \end{array} \right] = \left[\begin{array}{c} \text{Number of input} \\ \text{axis pulses} \end{array} \right] \times [\text{Gear ratio}] \quad [\text{PLS}]$$

- (2) The rotation direction of output axis is set in the gear parameters.

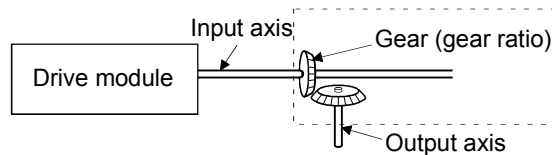

REMARK

Refer to Section 7.1.2 for details of the gear parameters.

7.1.2 Parameters

The gear parameters are shown in Table 7.1 and the parameters shown in this table are explained in items (1) to (2) below.

Refer to the help of SW6RN-GSV22P for the gear parameter setting method.

Table 7.1 Gear Parameter List

No.	Setting Item		Default	Setting range	
				Direct setting	Indirect setting
1	Gear ratio	Input axis side tooth count (GI)	1	1 to 65535	D800 to D3069 (Note) D3080 to D8191
					W0 to W1FFF
	Output axis side tooth count (GO)	1	1 to 65535	D800 to D3069 (Note) D3080 to D8191	
					W0 to W1FFF
2	Rotation direction of output axis		Forward rotation	Forward rotation Reverse rotation	—

(Note) : D800 to D1559 are dedicated devices of the virtual servomotor axis, synchronous encoder axis and output module "Cam" in the virtual mode. Unused areas of virtual servomotor axis and cam axis can be used as an user device.

(1) Gear ratio

- (a) The number of pulses transmitted to the output axis through 1 pulse outputted from the drive module by the gear module is set in the gear ratio.
- (b) The gear ratio is based on the settings for the input axis side tooth count (GI) and output axis side tooth count (GO).

$\text{Gear ratio} = \frac{\text{Input axis side tooth count (GI)}}{\text{Output axis side tooth count (GO)}}$

(2) Rotation direction of output axis

- (a) The rotation direction of the output axis forward the rotation direction of the input axis is set.
- (b) There are two types for rotation directions of the output axis: forward and reverse.

1) Forward

When the input axis rotates to the address increase direction, the output axis also rotates to the address increase direction.

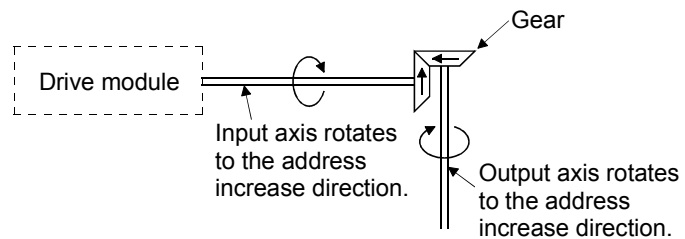

2) Reverse

When the input axis rotates to the address increase direction, the output axis rotates to the address decrease direction.

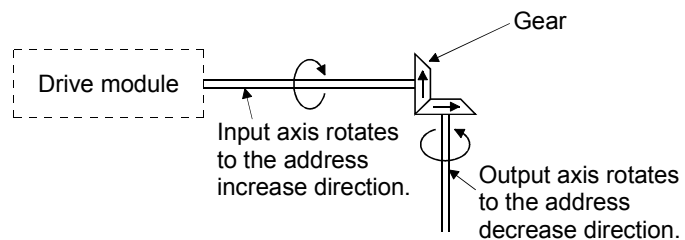

POINT	<p>If the gear ratio is set indirectly, the timing that the gear ratio set in Motion SFC program becomes valid is shown below.</p> <ul style="list-style-type: none"> (1) When the real mode is switched to virtual mode. (2) When the current value of the drive module is changed in the virtual mode.
--------------	----------------------------------------------------------------------------------------------------------------------------------------------------------------------------------------------------------------------------------------------------------------------------------------------------------------------------------

7.2 Clutch

The clutch is used to transmit/disengage the command pulse from drive module side to output module side, and to control the operation/stop of servomotor.

There are two types for clutch: smoothing clutch and direct clutch.

These two clutches operate in the same way, but these have the difference in whether the acceleration/deceleration processing by the smoothing processing is executed or not at the switching of the clutch on/off.

(1) Smoothing clutch and direct clutch

(a) Smoothing clutch

When the clutch is switched on/off, output to the output axis with the acceleration/deceleration processing (smoothing processing) set in the clutch parameters.

There are following three systems for smoothing clutch.

1) Time constant system

2) Slippage system

- Exponential function system • Linear acceleration/deceleration system

(b) Direct clutch

When the clutch is switched on/off, output to the output axis without the acceleration/deceleration processing.

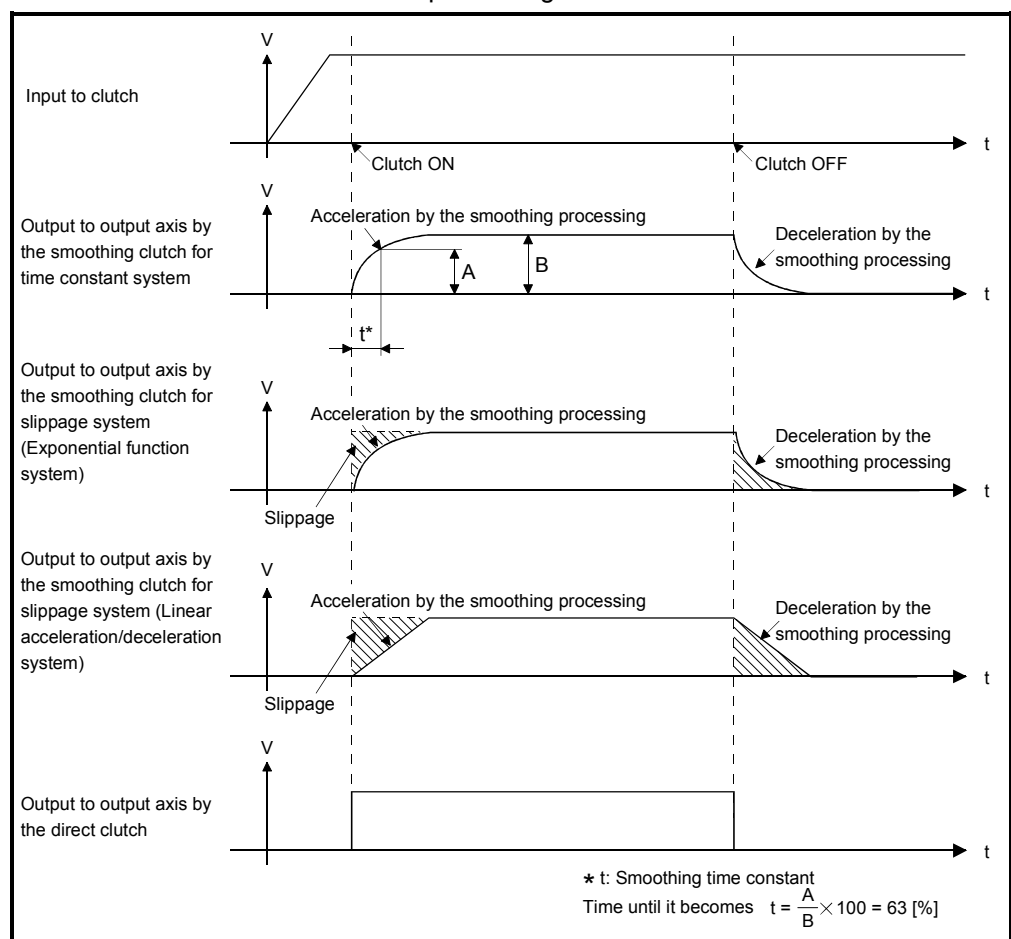
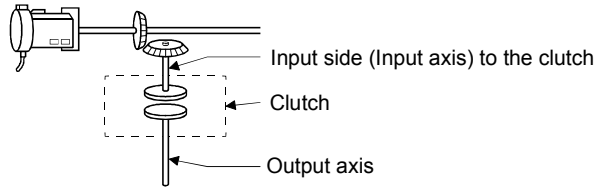

Fig. 7.1 Output to the Output axis by the Smoothing and Direct Clutch

REMARK

(1) Clutch ON/OFF state is shown below.



- Clutch ON state.....The state in which pulses inputted to the clutch are output to the output axis.
- Clutch OFF state.....The state in which pulses inputted to the clutch are not output to the output axis.

(2) Smoothing processing

(a) Time constant system

1) Since the time constant is fixed, the slippage of clutch changes according to the speed of drive module.

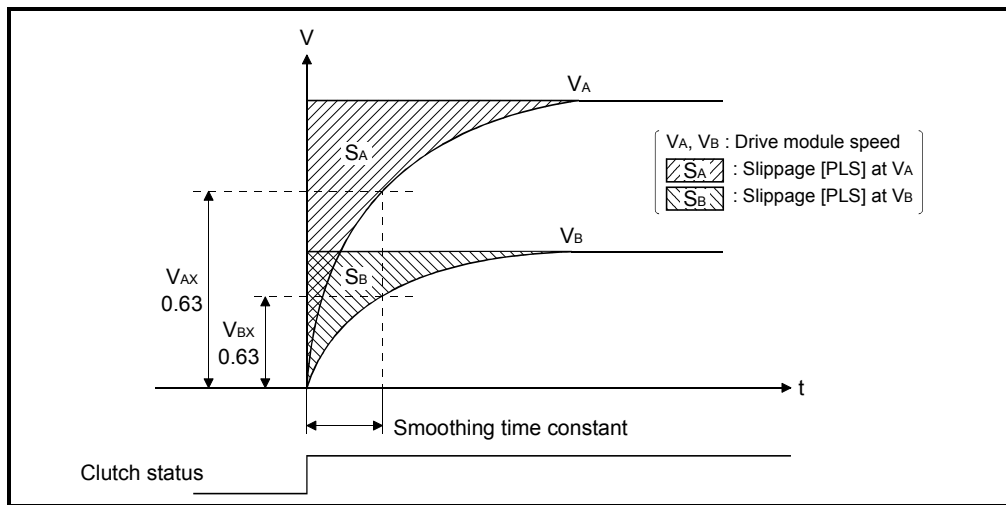

2) If input to clutch (travel value after the main shaft's differential gear) changes after smoothing completion, the smoothing processing is executed at that point.

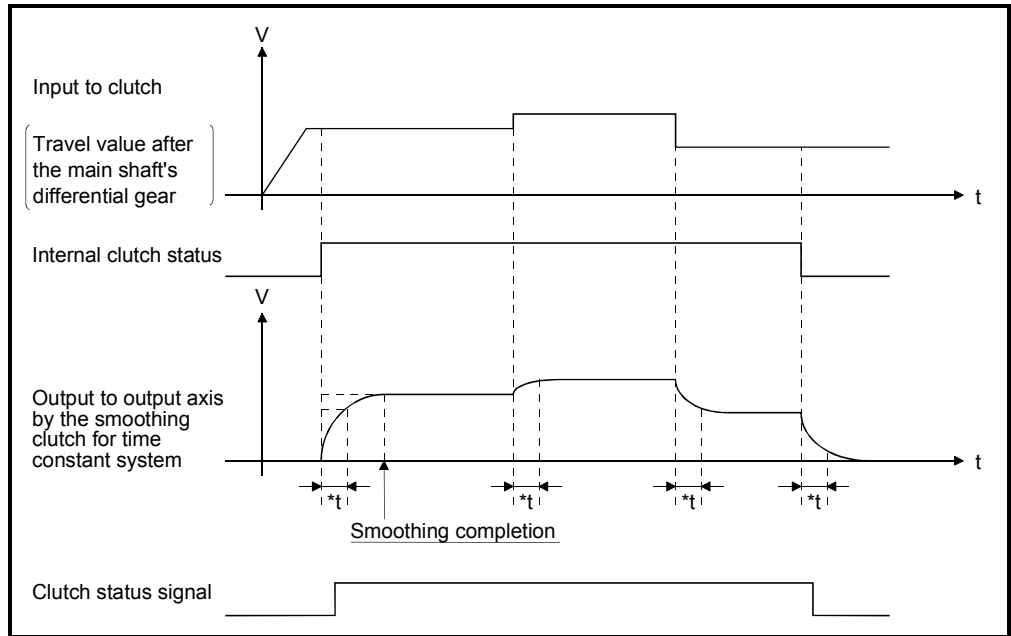

*t : Smoothing time constant

(b) Slippage system

There are following two systems for slippage system.

- Exponential function system
- Linear acceleration/deceleration system

1) Exponential function system

a) Set the slippage indicated by the shaded area in the diagram below.

Slippage is recommended to be set greater than input to clutch (travel value after the main shaft's differential gear).

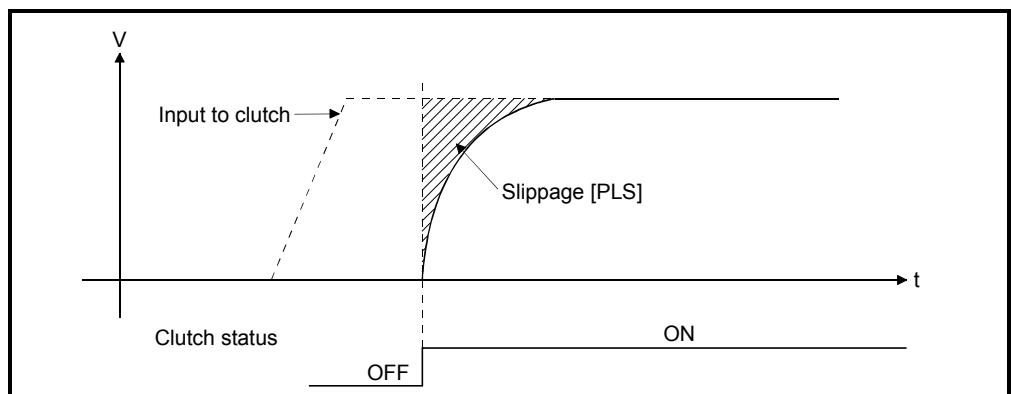

b) Since the slippage remains constant even if the drive module speed changes, the clutch ON/OFF position can be controlled without any influence from speed changes.

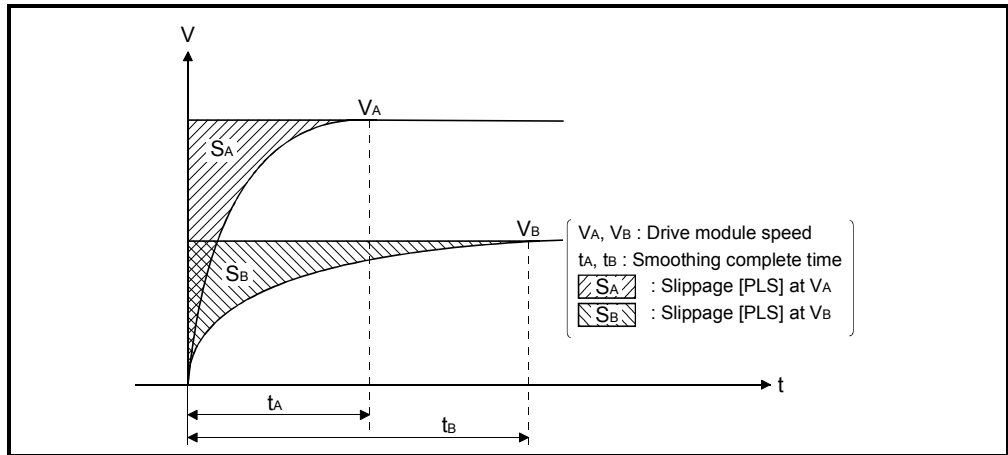

c) If input to clutch (travel value after the main shaft's differential gear) changes after smoothing completion, the smoothing processing is not executed at that point and output directly.

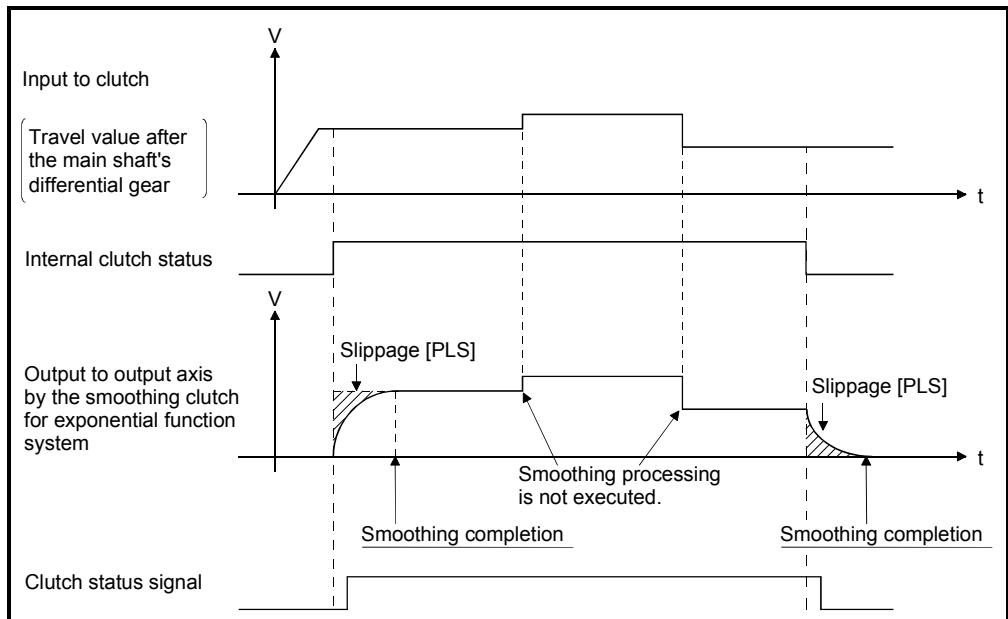

d) The smoothing clutch complete signal (M5520+2n, M5521+2n) turns ON after completion of smoothing processing.

- ON "(Remainder slippage) < (Slippage in-position range)"
- OFF... Smoothing processing start (Clutch ON/OFF)

The smoothing clutch complete signal (M5520+2n, M5521+2n) is used to check the completion of smoothing processing, etc.

2) Linear acceleration/deceleration system

- a) Set the slippage indicated by the shaded area in the diagram below. Slippage is recommended to be set greater than input to clutch (travel value after the main shaft's differential gear).

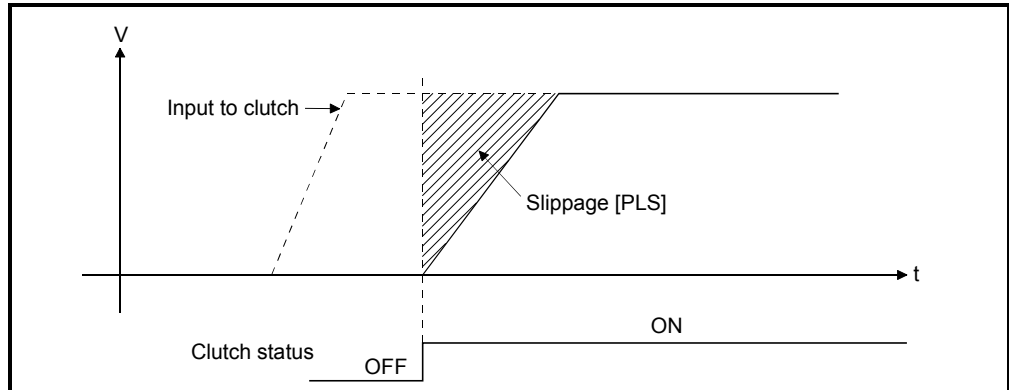

- b) Execute the smoothing processing so that the slippage may become the shaded area by the linear acceleration/deceleration system at clutch ON/OFF.
- c) Since the slippage remains constant even if the drive module speed changes, the clutch ON/OFF position can be controlled without any influence from speed changes.

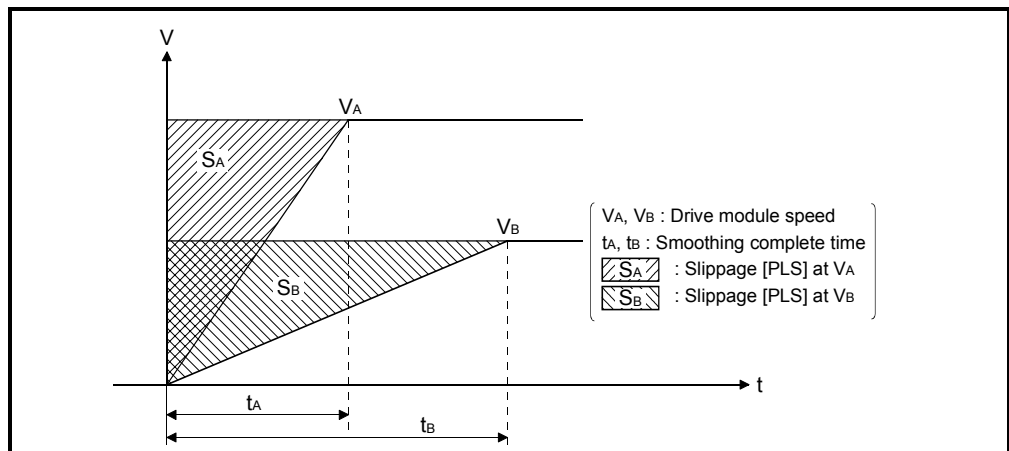

d) If input to clutch (travel value after the main shaft's differential gear) changes after smoothing completion, the smoothing processing is not executed and output directly.

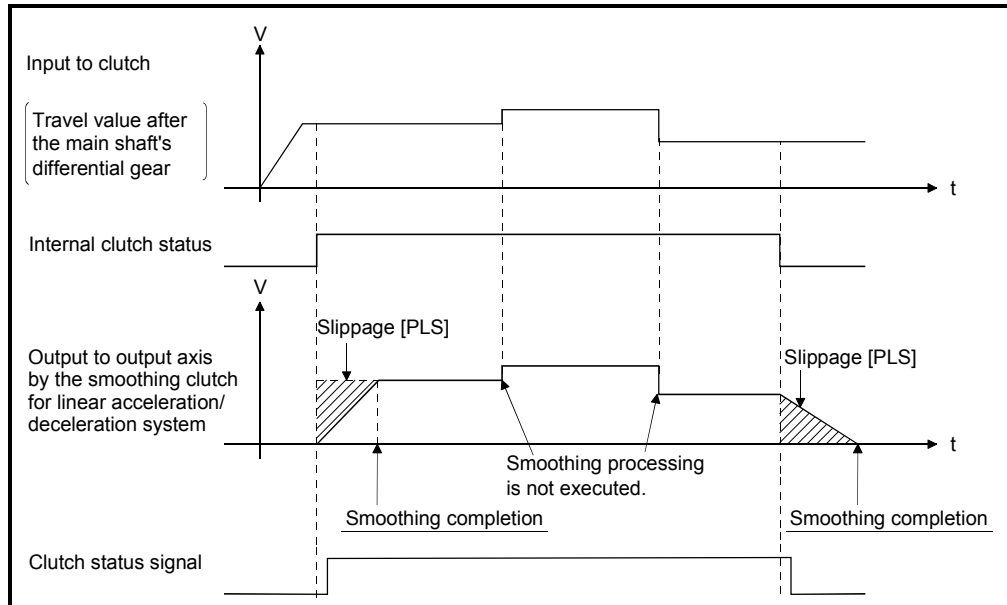

- e) The smoothing clutch complete signal (M5520+2n, M5521+2n) turns ON after completion of smoothing processing.
- ON ... "(Remainder slippage) < (Slippage in-position range)"
 - OFF ... Smoothing processing start (Clutch ON/OFF)

The smoothing clutch complete signal (M5520+2n, M5521+2n) is used to check the completion of smoothing processing, etc.

7.2.1 Operation

There are following five clutch operation modes.

Operation mode	Description
ON/OFF mode	Clutch ON/OFF control is executed by turning the clutch ON/OFF command device on/off.
Address mode	Clutch ON/OFF control is executed by turning the clutch ON/OFF command device on/off and an address of clutch ON/OFF address setting device.
Address mode 2	After clutch ON/OFF command device turns on, Clutch ON/OFF control by an address of clutch ON/OFF address setting device.
One-shot mode	Clutch ON/OFF control is executed based on the drive module current value, setting travel value before clutch ON and setting travel value after clutch ON after the clutch ON/OFF command device from off to on.
External input mode	Only axis that the incremental synchronous encoder (manual pulse generator) is set as drive module can be set. Clutch ON/OFF control is executed by turning the clutch ON/OFF command device on/off and an external input (TREN signal: Synchronous encoder start signal).

Operations for every clutch mode are shown below.

(1) ON/OFF mode

- (a) The clutch ON/OFF control is executed by turning the clutch ON/OFF command device on/off.

Conditions	Clutch operation
Clutch ON/OFF command device: ON	ON
Clutch ON/OFF command device: OFF	OFF

- (b) It takes a time for maximum operation cycle until a clutch will be in the ON/OFF state after turning the clutch ON/OFF command device on/off. If greater accuracy is required, use the "address mode".

POINT
(1) The mode setting device of except "0 to 4" is regarded as an error, and it controls continuously at the previous setting value.
(2) Clutch operation mode can be changed at any time.

7 TRANSMISSION MODULE

(c) The clutch ON/OFF state can be checked by the clutch status signal.

Connected module		Applicable device	Connected module		Applicable device
Output module for axis 1	Main shaft side	M2160	Output module for axis 17	Main shaft side	M2192
	Auxiliary input axis side	M2161		Auxiliary input axis side	M2193
Output module for axis 2	Main shaft side	M2162	Output module for axis 18	Main shaft side	M2194
	Auxiliary input axis side	M2163		Auxiliary input axis side	M2195
Output module for axis 3	Main shaft side	M2164	Output module for axis 19	Main shaft side	M2196
	Auxiliary input axis side	M2165		Auxiliary input axis side	M2197
Output module for axis 4	Main shaft side	M2166	Output module for axis 20	Main shaft side	M2198
	Auxiliary input axis side	M2167		Auxiliary input axis side	M2199
Output module for axis 5	Main shaft side	M2168	Output module for axis 21	Main shaft side	M2200
	Auxiliary input axis side	M2169		Auxiliary input axis side	M2201
Output module for axis 6	Main shaft side	M2170	Output module for axis 22	Main shaft side	M2202
	Auxiliary input axis side	M2171		Auxiliary input axis side	M2203
Output module for axis 7	Main shaft side	M2172	Output module for axis 23	Main shaft side	M2204
	Auxiliary input axis side	M2173		Auxiliary input axis side	M2205
Output module for axis 8	Main shaft side	M2174	Output module for axis 24	Main shaft side	M2206
	Auxiliary input axis side	M2175		Auxiliary input axis side	M2207
Output module for axis 9	Main shaft side	M2176	Output module for axis 25	Main shaft side	M2208
	Auxiliary input axis side	M2177		Auxiliary input axis side	M2209
Output module for axis 10	Main shaft side	M2178	Output module for axis 26	Main shaft side	M2210
	Auxiliary input axis side	M2179		Auxiliary input axis side	M2211
Output module for axis 11	Main shaft side	M2180	Output module for axis 27	Main shaft side	M2212
	Auxiliary input axis side	M2181		Auxiliary input axis side	M2213
Output module for axis 12	Main shaft side	M2182	Output module for axis 28	Main shaft side	M2214
	Auxiliary input axis side	M2183		Auxiliary input axis side	M2215
Output module for axis 13	Main shaft side	M2184	Output module for axis 29	Main shaft side	M2216
	Auxiliary input axis side	M2185		Auxiliary input axis side	M2217
Output module for axis 14	Main shaft side	M2186	Output module for axis 30	Main shaft side	M2218
	Auxiliary input axis side	M2187		Auxiliary input axis side	M2219
Output module for axis 15	Main shaft side	M2188	Output module for axis 31	Main shaft side	M2220
	Auxiliary input axis side	M2189		Auxiliary input axis side	M2221
Output module for axis 16	Main shaft side	M2190	Output module for axis 32	Main shaft side	M2222
	Auxiliary input axis side	M2191		Auxiliary input axis side	M2223

(Note) : The range of output module for axis No. 1 to 8 is valid in the Q172HCPU.

(d) Refer to APPENDIX 5 for the refresh cycle of clutch status signal.

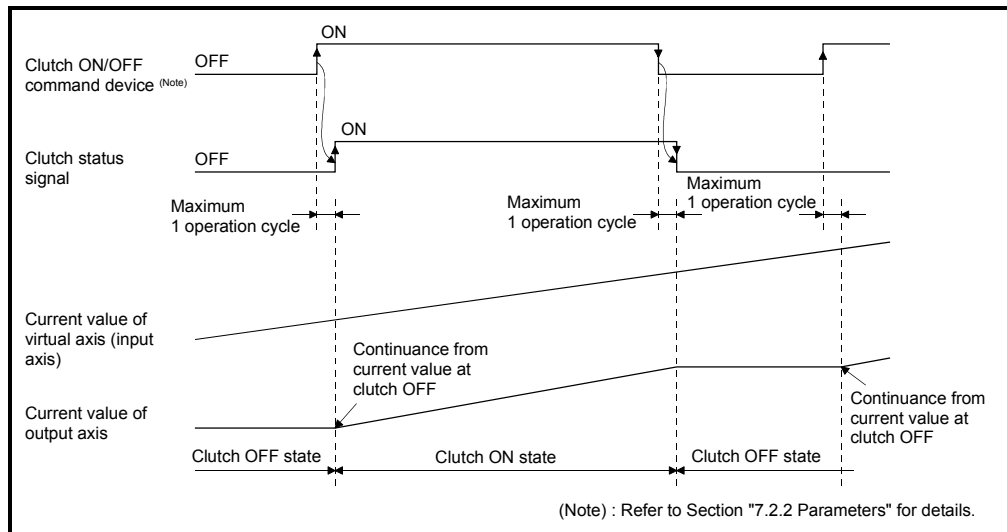

Fig. 7.2 Operation Timing for ON/OFF Mode

(2) Address mode

(a) When the current value of virtual axis reaches an address of clutch ON/OFF address setting device, the clutch ON/OFF is executed. (Mode setting device is "1".)

- 1) When the clutch ON/OFF command device is ON and the current value of virtual axis reaches an address set in the clutch ON address setting device, the clutch is set to the ON state.
- 2) When the clutch ON/OFF command device is OFF and the current value of virtual axis reaches an address set in the clutch OFF address setting device, the clutch is set to the OFF state.

(b) The clutch ON/OFF control differs according to the output module connected as follows.

- 1) For a ball screw or roller
 - The ON/OFF control is executed by the current value of virtual axis.
 - When a differential gear is connected to the main shaft, the ON/OFF control is executed by the current value after the main shaft's differential gear.
- 2) For a rotary table or cam
 - The ON/OFF control is executed by the current value within 1 virtual axis revolution.
 - (Refer to a rotary table or cam of output module for details.)

7 TRANSMISSION MODULE

(c) Turn the clutch ON/OFF command device on/off after setting an address of clutch ON/OFF address setting device.

- 1) When the clutch ON/OFF command device is OFF, even if the current value of virtual axis reaches an address of clutch ON address setting device, the clutch is not set to the ON state.
- 2) When the clutch ON/OFF command device is ON, even if the current value of virtual axis reaches an address of clutch OFF address setting device, the clutch is not set to the OFF state.

(d) The clutch ON/OFF state can be checked by clutch status signal.

Connected module		Applicable device	Connected module		Applicable device
Output module for axis 1	Main shaft side	M2160	Output module for axis 17	Main shaft side	M2192
	Auxiliary input axis side	M2161		Auxiliary input axis side	M2193
Output module for axis 2	Main shaft side	M2162	Output module for axis 18	Main shaft side	M2194
	Auxiliary input axis side	M2163		Auxiliary input axis side	M2195
Output module for axis 3	Main shaft side	M2164	Output module for axis 19	Main shaft side	M2196
	Auxiliary input axis side	M2165		Auxiliary input axis side	M2197
Output module for axis 4	Main shaft side	M2166	Output module for axis 20	Main shaft side	M2198
	Auxiliary input axis side	M2167		Auxiliary input axis side	M2199
Output module for axis 5	Main shaft side	M2168	Output module for axis 21	Main shaft side	M2200
	Auxiliary input axis side	M2169		Auxiliary input axis side	M2201
Output module for axis 6	Main shaft side	M2170	Output module for axis 22	Main shaft side	M2202
	Auxiliary input axis side	M2171		Auxiliary input axis side	M2203
Output module for axis 7	Main shaft side	M2172	Output module for axis 23	Main shaft side	M2204
	Auxiliary input axis side	M2173		Auxiliary input axis side	M2205
Output module for axis 8	Main shaft side	M2174	Output module for axis 24	Main shaft side	M2206
	Auxiliary input axis side	M2175		Auxiliary input axis side	M2207
Output module for axis 9	Main shaft side	M2176	Output module for axis 25	Main shaft side	M2208
	Auxiliary input axis side	M2177		Auxiliary input axis side	M2209
Output module for axis 10	Main shaft side	M2178	Output module for axis 26	Main shaft side	M2210
	Auxiliary input axis side	M2179		Auxiliary input axis side	M2211
Output module for axis 11	Main shaft side	M2180	Output module for axis 27	Main shaft side	M2212
	Auxiliary input axis side	M2181		Auxiliary input axis side	M2213
Output module for axis 12	Main shaft side	M2182	Output module for axis 28	Main shaft side	M2214
	Auxiliary input axis side	M2183		Auxiliary input axis side	M2215
Output module for axis 13	Main shaft side	M2184	Output module for axis 29	Main shaft side	M2216
	Auxiliary input axis side	M2185		Auxiliary input axis side	M2217
Output module for axis 14	Main shaft side	M2186	Output module for axis 30	Main shaft side	M2218
	Auxiliary input axis side	M2187		Auxiliary input axis side	M2219
Output module for axis 15	Main shaft side	M2188	Output module for axis 31	Main shaft side	M2220
	Auxiliary input axis side	M2189		Auxiliary input axis side	M2221
Output module for axis 16	Main shaft side	M2190	Output module for axis 32	Main shaft side	M2222
	Auxiliary input axis side	M2191		Auxiliary input axis side	M2223

(Note) : The range of output module for axis No. 1 to 8 is valid in the Q172HCPU.

(e) The refresh cycle of clutch status signal is an operation cycle.

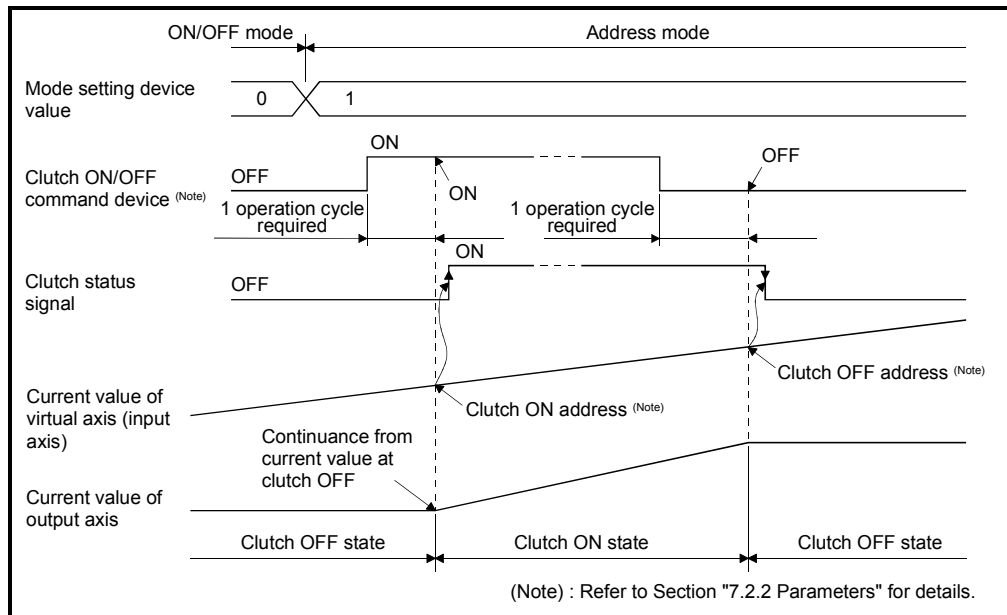

Fig. 7.3 Operation Timing for Address Mode

POINT

- (1) The mode setting device of except for "0 to 4" is regarded as an error, and control is continued at the previous setting value.
- (2) Clutch operation mode changes are valid at any time.
- (3) Clutch ON/OFF address setting device changes are valid at any time. Since they have 2-word data, set it as 32-bit integer type data.

(3) Address mode 2

- (a) When the current value of virtual axis reaches an address of clutch ON/OFF address setting device, the clutch ON/OFF is executed. (Mode setting device is "2".)
- (b) When the clutch ON/OFF command device is ON, the following controls are executed according to the current clutch status.
 - 1) When the current clutch status is OFF.
 - When the current value of virtual axis reaches an address set in the clutch ON address setting device, the clutch is set to the ON state. After that, it is set the state in 2).
 - 2) When the current clutch status is ON.
 - When the current value of virtual axis reaches an address set in the clutch OFF address setting device, the clutch is set to the OFF state. After that, it is set the state in 1).

(c) When the clutch ON/OFF command device is OFF, the clutch is turned off and the above control (b) is not executed. Therefore, the above control is resumed by turning the clutch ON/OFF command device on.

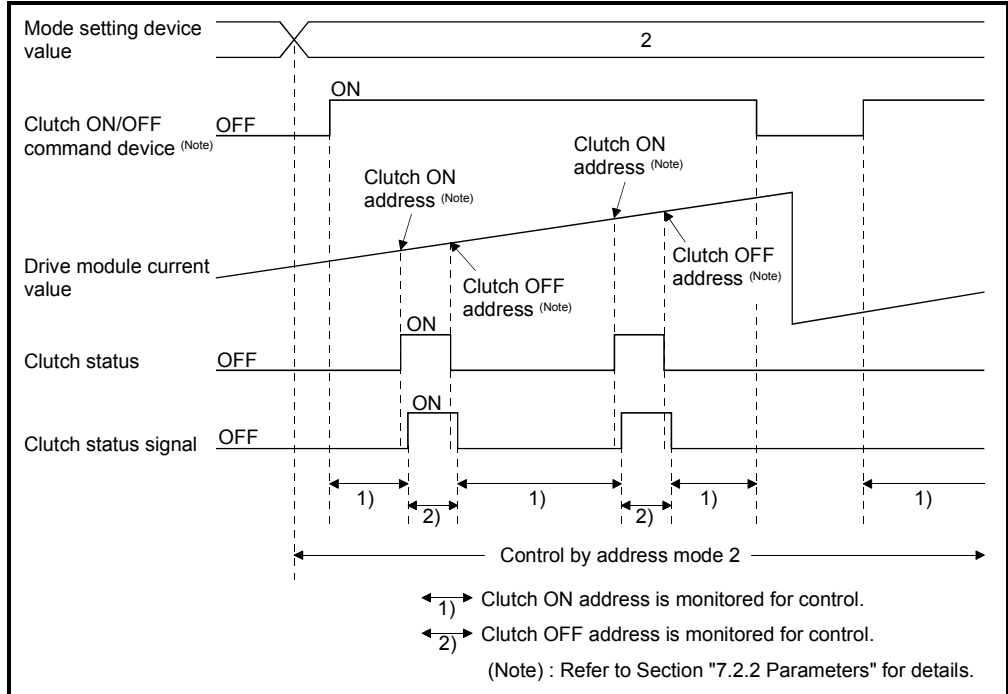
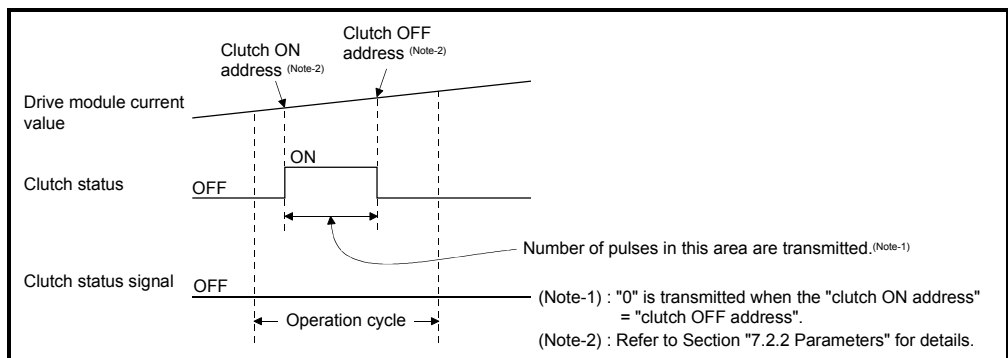

Fig. 7.4 Operation Timing for Address Mode 2

- POINT**
- (1) The mode setting device of except for "0 to 4" is regarded as an error, and control is continued at the previous setting value.
 - (2) Clutch control mode changes are valid at any time.
 - (3) Clutch ON/OFF address setting device changes are valid at any time. Since they have 2-word data, set it as 32-bit integer type data.

(d) The clutch ON/OFF control is executed for every operation cycle. When the current value passes through an address set in the clutch ON/OFF address setting device for 1 operation cycle, the internal control is executed correctly but the clutch status signal does not change.

1) When the clutch status signal is OFF and the current value passes through an address set in the clutch ON/OFF address setting device.



2) When the clutch status signal is ON and the current value passes through an address set in the clutch ON/OFF address setting device.

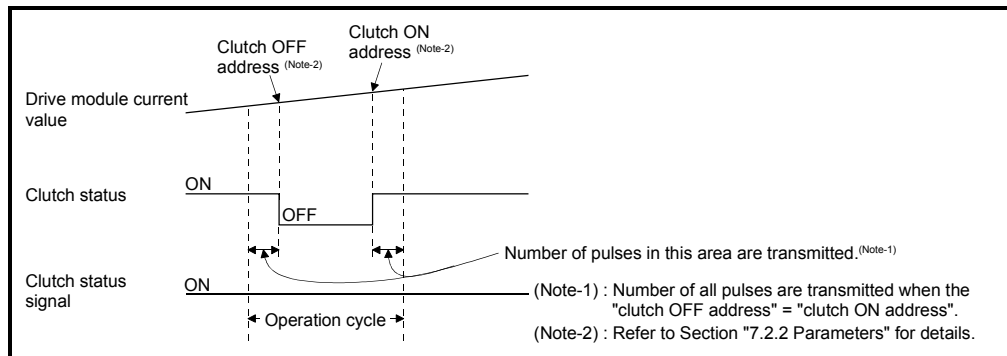

(e) When the "Clutch OFF" is set in the parameter "Error-time operation mode" of drive module and a major error occurs in the output module, the operating system software turns off the clutch. The procedure to resume an operation after an error occurrence is shown below.

- 1) Remove a major error factor.
- 2) Turn the clutch ON/OFF command device off.
 - It returns to normal state.
- 3) Turn the clutch ON/OFF command device on.
 - The clutch ON address is monitored and control is resumed.

(f) The procedure to execute the axis servo OFF or power supply OFF of servo amplifier during operation is shown below.

- 1) Turn the clutch ON/OFF command device off.
 - The clutch status is set to the OFF state. After that, the axis servo OFF command becomes valid.
- 2) Execute the axis servo OFF command or the power supply OFF of servo amplifier.

(g) The procedure to resume an operation after the axis servo OFF or power supply OFF of servo amplifier during operation is shown below.

- 1) Turn the power supply of servo amplifier on.
- 2) Execute the axis servo ON command.
- 3) Turn the clutch ON/OFF command device on.
 - The clutch ON address is monitored and control is resumed.

(4) One-shot mode

(a) When the mode setting device is "3: One-shot mode clutch ON command is valid" or "4: One-shot mode clutch ON command is invalid", it switches to one-shot mode control.

(b) When the mode setting device is "3", the clutch ON/OFF command device becomes valid, and the following controls are executed based on the clutch ON address setting device (setting travel value after clutch ON)/clutch OFF address setting device (setting travel value before clutch ON) by the clutch ON/OFF command device.

- 1) When the clutch ON/OFF command device switches from OFF to ON. The clutch is set to the ON state after moving the travel value set in the setting travel value before clutch ON, and it is set to the OFF state after moving the travel value set in the setting travel value after clutch ON.
- 2) When the clutch ON/OFF command device switches from ON to OFF. It has no influence on the clutch processing. The clutch state is held.

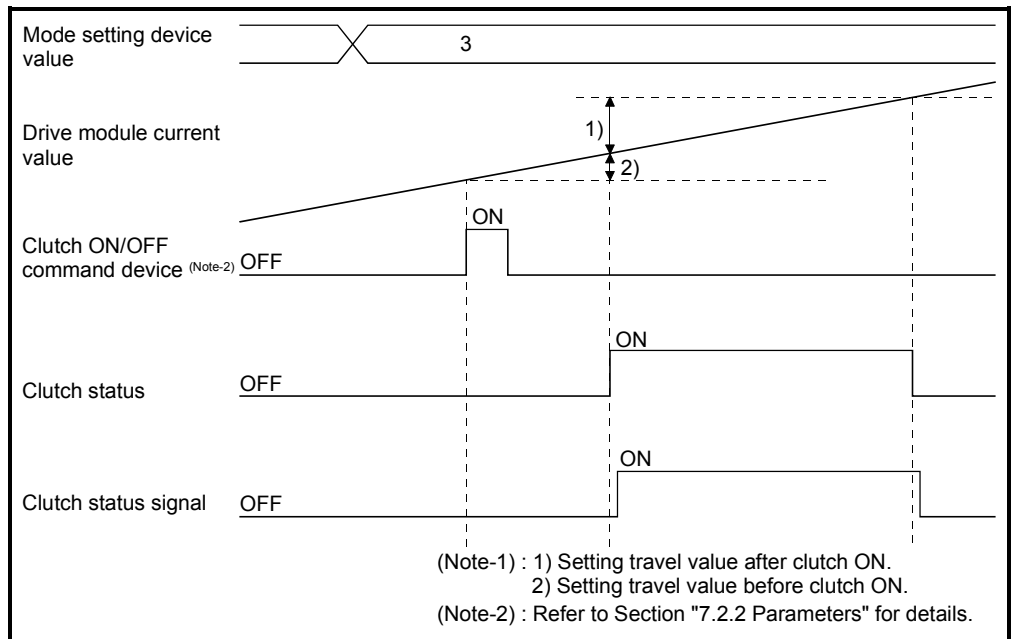
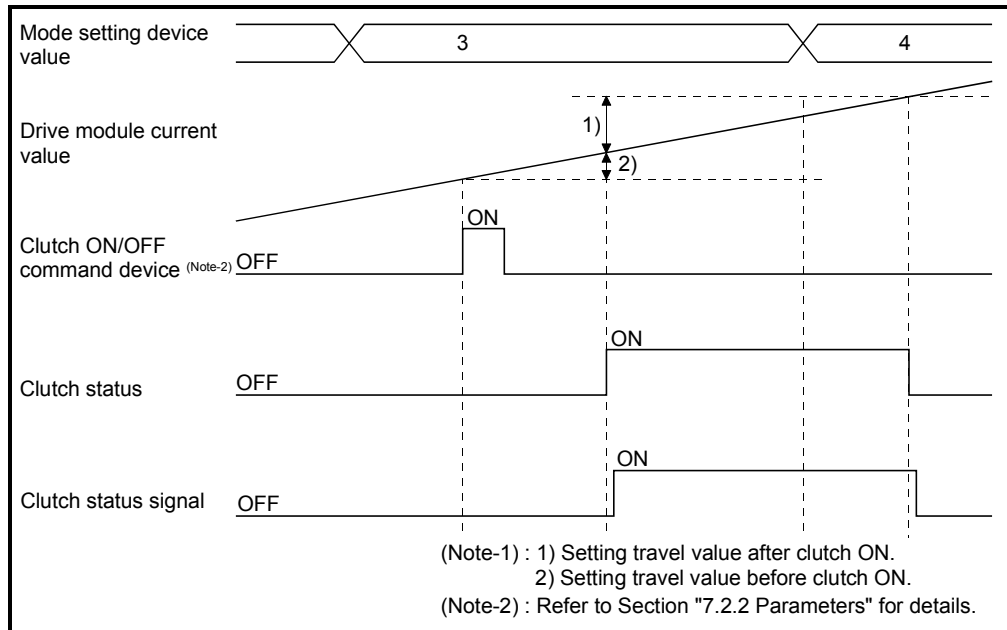

Fig. 7.5 Operation Timing for One-shot Mode

- (c) When the mode setting device is "4", the clutch ON/OFF command device becomes invalid, and the clutch remains OFF. However, when the mode setting device is changed from "3" to "4" during execution of clutch ON/OFF processing by turning the clutch ON/OFF command device on, the clutch ON/OFF processing in execution is executed till the end and the next clutch ON/OFF command or later becomes invalid. The clutch ON/OFF command device becomes valid by changing the mode setting device value to "3" again.



- (d) The details for setting items are shown below.

Setting items	Description
Clutch ON/OFF command device	The clutch ON/OFF processing of one-shot mode starts by turning this device on.
Clutch ON address setting device	The transmitted travel value (setting travel value after clutch ON) of connected drive module from turning on clutch to turning off is set. A positive travel value is stored to indicate a positive direction travel value from the point of clutch ON, and a negative value to indicate a negative travel direction travel value. (Setting range: -2147483648 (-2^{31}) to 2147483647 ($2^{31}-1$) [PLS])
Clutch OFF address setting device	The travel value (setting travel value before clutch ON) of connected drive module from turning on clutch ON/OFF command device to turning on the clutch actually is set. A positive travel value is stored to indicate a positive direction travel value from the point of clutch ON, and a negative value to indicate a negative travel direction travel value. (Setting range: -2147483648 (-2^{31}) to 2147483647 ($2^{31}-1$) [PLS])

(Note) : When the setting travel value before clutch ON is "0", the clutch also becomes ON state simultaneously by turning the clutch ON/OFF command device off to on.

POINT
<p>(1) The mode setting device of except for "0 to 4" is regarded as an error, and control is continued at the previous setting value.</p> <p>(2) Clutch control mode changes are valid at any time.</p> <p>(3) Clutch ON/OFF address setting device changes are valid at any time. Since they have 2-word data, set it as 32-bit integer type data.</p>

(e) The clutch ON/OFF control is executed for every operation cycle. The internal control is executed correctly but the clutch status signal does not change for the setting travel value that the clutch status turns from off to on to off for 1 operation cycle.

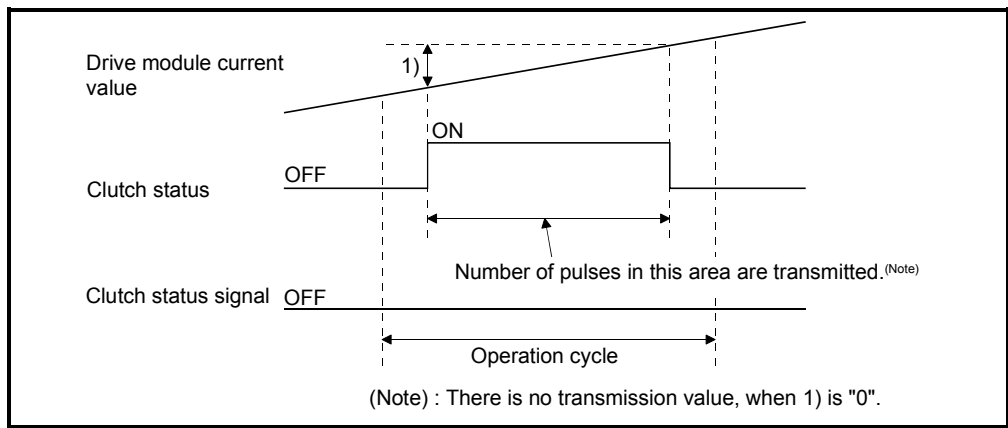

(f) When the mode setting device becomes "3", the clutch ON/OFF control starts based on the setting data while the clutch ON/OFF command device is ON.

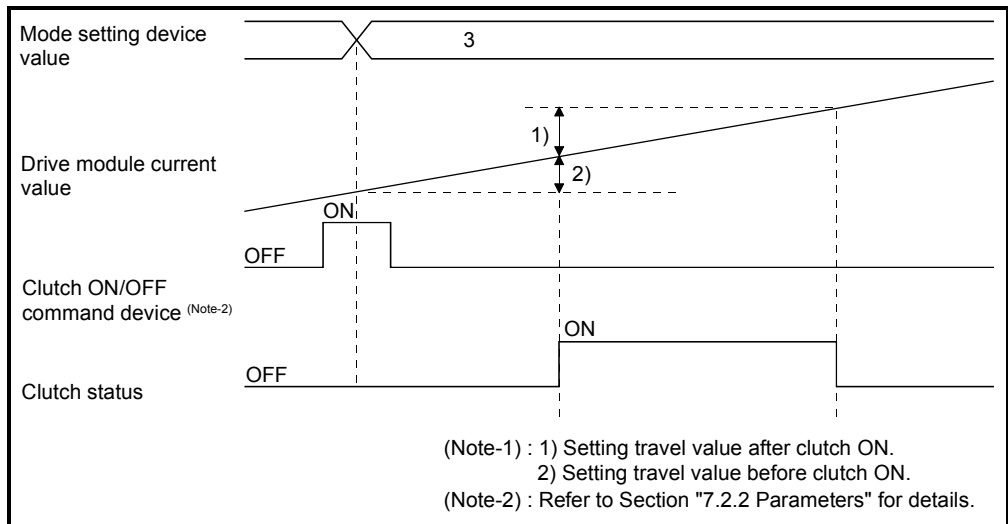

7 TRANSMISSION MODULE

- (g) When the mode setting device becomes "3", the clutch status turns OFF, while the clutch ON/OFF command device is OFF and the clutch status is ON.

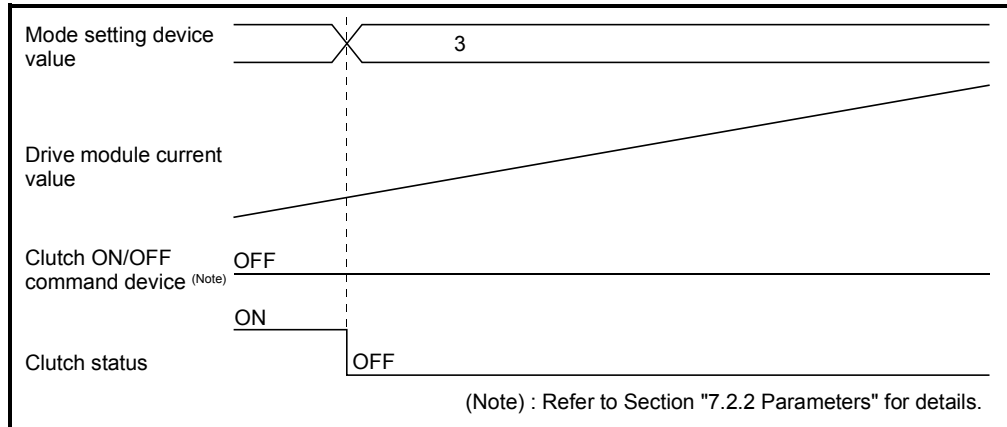

- (h) When the mode setting device is changed from "except 3" to "4", the clutch status turns off regardless of the clutch ON/OFF command device.
- (i) When the clutch ON/OFF address setting device data is changed during the clutch processing of one-shot mode, it becomes valid by turning the next clutch ON/OFF command device off to on.
- (j) When the drive module stops during the clutch ON/OFF processing by turning the clutch ON/OFF command device on, or if the clutch ON/OFF command device is turned on though the drive module stops, the one-shot mode clutch does not end until the travel value condition set to the setting travel value before clutch ON or setting travel value after clutch ON is satisfied.
- (k) When the current value change is made to the drive module during the clutch ON/OFF processing by turning the clutch ON/OFF command device on, the clutch turns off at the position where the setting travel value before clutch ON or setting travel value after clutch ON from the clutch ON position is satisfied.

- (l) When the travel direction of drive module changes during the clutch ON/OFF processing by turning the clutch ON/OFF command device on, the clutch ON/OFF control is executed at the position in which not the travel value of drive module but the setting travel value before clutch ON/ setting travel value after clutch ON to the position where the clutch ON command is given was added.

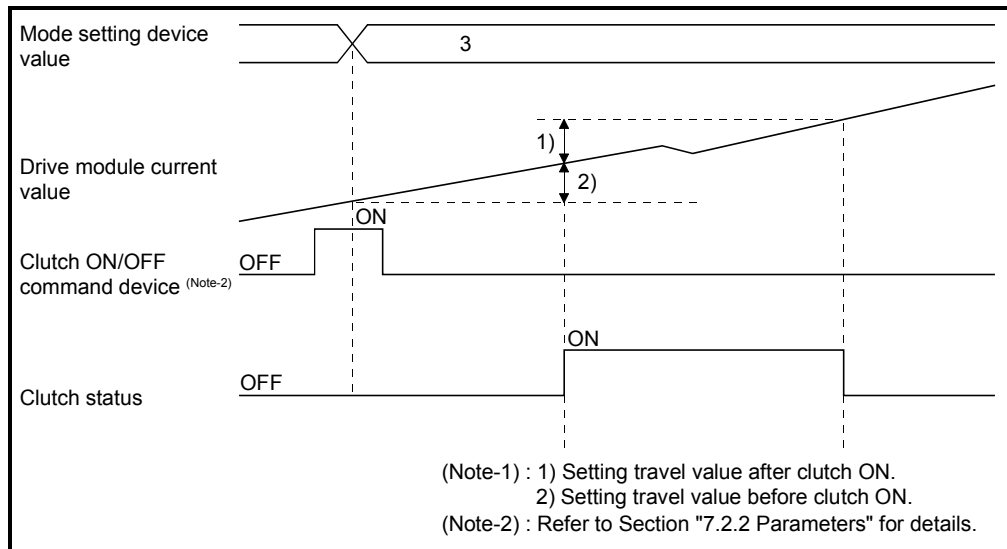

- (m) The setting travel value before clutch ON/setting travel value after clutch ON differs according to the output module connected as follows.

1) For a ball screw or roller

The clutch ON/OFF control is executed by the current travel value of virtual axis connected.

When a differential gear is connected to the main shaft, the clutch ON/OFF control is executed by the current travel value after the main shaft's differential gear.

2) For a rotary table or cam

The clutch ON/OFF control is executed by the travel value of current value within 1 virtual axis revolution. The setting travel value can be set outside the range of current value within 1 virtual axis revolution.

- (n) When the travel direction set in the setting travel value before clutch ON/ setting travel value after clutch ON does not match the virtual axis or current value within 1 virtual axis revolution, note that the clutch will turn on/off even if the condition is not satisfied when the data found by subtracting the travel value from the specified travel value comes out of the range -2147483648 to 2147483647 [PLS] and changes from "+" to "-" or from "-" to "+".

- (o) When the "Clutch OFF" is set in the parameter "Error-time operation mode" of drive module and a major error occurs in the output module, the operating system software turns off the clutch.

The procedure to resume an operation after an error occurrence is shown below.

- 1) Remove a major error factor.
- 2) Turn the clutch ON/OFF command device off.
→ It returns to normal state.
- 3) Turn the clutch ON/OFF command device on.
→ The clutch control of one-shot mode is resumed.

- (p) The procedure to execute the axis servo ON/OFF or power supply OFF of servo amplifier during operation is shown below.

- 1) Turn the clutch revolution OFF command device off, when the clutch status is ON state, wait until the clutch status becomes OFF.
→ After the clutch status to be set to OFF state, the axis servo OFF command becomes valid.
- 2) Execute the axis servo OFF command or the power supply OFF of servo amplifier off.

- (q) The procedure to resume an operation after the axis servo OFF or the power supply OFF of servo amplifier during operation is shown below.

- 1) Turn the power supply of servo amplifier on.
- 2) Execute the axis servo ON command.
- 3) Turn the clutch ON/OFF command device on.
→ The clutch control of one-shot mode is resumed.

(5) External input mode

- (a) The clutch ON/OFF control is executed by turning the clutch ON/OFF command device on/off and external input (TREN signal: Synchronous encoder start signal).

Since the input pulses from synchronous encoder are counted by turning the external input off to on, a high-speed response and high accuracy clutch control is possible.

- 1) The clutch is set to the ON state by turning the external input off to on (OFF → ON) after the clutch ON/OFF command device turns on.
- 2) When the clutch ON/OFF command device turns off, the clutch is set to the OFF state after maximum 2 operation cycles.

- (b) Turn the external input (TREN signal) on after turning the clutch ON/OFF command device on.

In this mode, a time for maximum 2 operation cycles is required to turn the external input on after the clutch ON/OFF command device turns on.

- 1) If the external input turns from off to on when the clutch ON/OFF command device is OFF, the clutch is not set to the ON state.

7 TRANSMISSION MODULE

- 2) If the clutch ON/OFF device turns on when the external input is ON, the clutch is not set to the ON state.
- 3) If the external input turns off after the clutch is set to the ON state, the clutch state remain ON.

(c) The clutch ON/OFF state can be checked by the clutch status signal.
The clutch status signal ON/OFF is refreshed by the operation cycle.

Connected module		Applicable device	Connected module		Applicable device
Output module for axis 1	Main shaft side	M2160	Output module for axis 17	Main shaft side	M2192
	Auxiliary input axis side	M2161		Auxiliary input axis side	M2193
Output module for axis 2	Main shaft side	M2162	Output module for axis 18	Main shaft side	M2194
	Auxiliary input axis side	M2163		Auxiliary input axis side	M2195
Output module for axis 3	Main shaft side	M2164	Output module for axis 19	Main shaft side	M2196
	Auxiliary input axis side	M2165		Auxiliary input axis side	M2197
Output module for axis 4	Main shaft side	M2166	Output module for axis 20	Main shaft side	M2198
	Auxiliary input axis side	M2167		Auxiliary input axis side	M2199
Output module for axis 5	Main shaft side	M2168	Output module for axis 21	Main shaft side	M2200
	Auxiliary input axis side	M2169		Auxiliary input axis side	M2201
Output module for axis 6	Main shaft side	M2170	Output module for axis 22	Main shaft side	M2202
	Auxiliary input axis side	M2171		Auxiliary input axis side	M2203
Output module for axis 7	Main shaft side	M2172	Output module for axis 23	Main shaft side	M2204
	Auxiliary input axis side	M2173		Auxiliary input axis side	M2205
Output module for axis 8	Main shaft side	M2174	Output module for axis 24	Main shaft side	M2206
	Auxiliary input axis side	M2175		Auxiliary input axis side	M2207
Output module for axis 9	Main shaft side	M2176	Output module for axis 25	Main shaft side	M2208
	Auxiliary input axis side	M2177		Auxiliary input axis side	M2209
Output module for axis 10	Main shaft side	M2178	Output module for axis 26	Main shaft side	M2210
	Auxiliary input axis side	M2179		Auxiliary input axis side	M2211
Output module for axis 11	Main shaft side	M2180	Output module for axis 27	Main shaft side	M2212
	Auxiliary input axis side	M2181		Auxiliary input axis side	M2213
Output module for axis 12	Main shaft side	M2182	Output module for axis 28	Main shaft side	M2214
	Auxiliary input axis side	M2183		Auxiliary input axis side	M2215
Output module for axis 13	Main shaft side	M2184	Output module for axis 29	Main shaft side	M2216
	Auxiliary input axis side	M2185		Auxiliary input axis side	M2217
Output module for axis 14	Main shaft side	M2186	Output module for axis 30	Main shaft side	M2218
	Auxiliary input axis side	M2187		Auxiliary input axis side	M2219
Output module for axis 15	Main shaft side	M2188	Output module for axis 31	Main shaft side	M2220
	Auxiliary input axis side	M2189		Auxiliary input axis side	M2221
Output module for axis 16	Main shaft side	M2190	Output module for axis 32	Main shaft side	M2222
	Auxiliary input axis side	M2191		Auxiliary input axis side	M2223

(Note) : The range of output module for axis No. 1 to 8 is valid in the Q172HCPU.

(d) The current value of input axis (synchronous encoder) changes at the clutch ON state only.

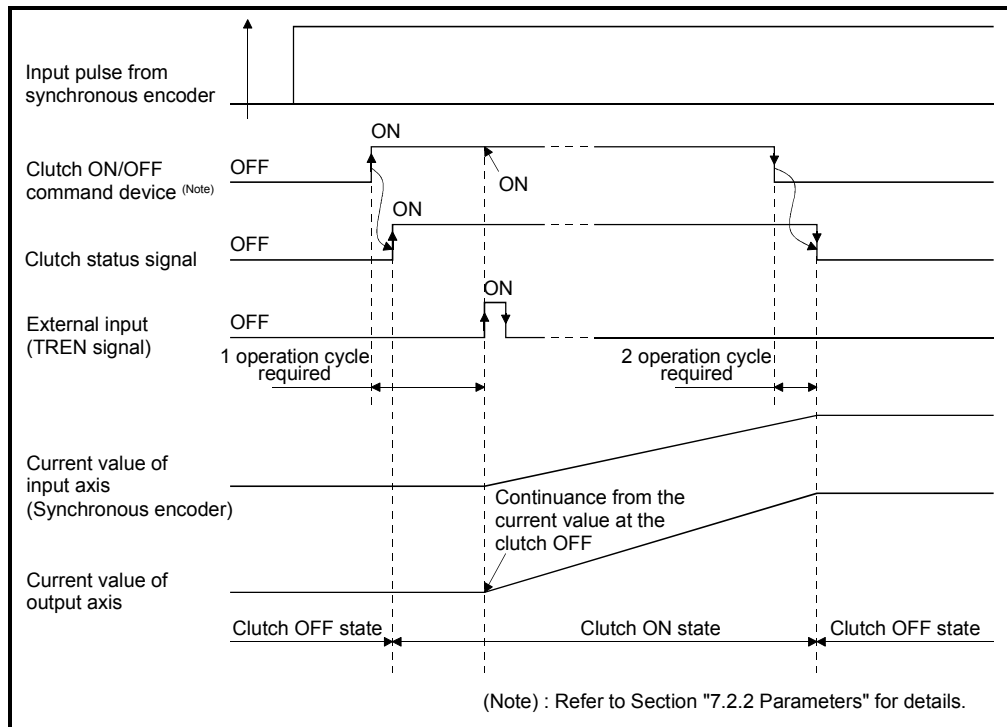

Fig. 7.6 Operation Timing for External Input Mode

(e) Only axis that the incremental synchronous encoder (manual pulse generator) is set as drive module can be used in this mode. When an absolute synchronous encoder is set as the drive module, it cannot be used.

(f) A synchronous encoder, external input and external input mode clutch can be set in only 1:1 ratio. The relationship between the synchronous encoder and external input is shown in the table below.

Synchronous encoder No.	External input (TREN signal)	Synchronous encoder No.	External input (TREN signal)
P1/E1	TREN 1	P7/E7	TREN 7
P2/E2	TREN 2	P8/E8	TREN 8
P3/E3	TREN 3	P9/E9	TREN 9
P4/E4	TREN 4	P10/E10	TREN 10
P5/E5	TREN 5	P11/E11	TREN 11
P6/E6	TREN 6	P12/E12	TREN 12

(Note) : The range of synchronous encoder No. P1/E1 to P8/E8 is valid in the Q172HCPU.

- (g) Set all clutches connected to the same encoder No. to the external input mode to use the clutch connected to an encoder in the external input mode. However, it is permissible to use a combination of direct clutches and smoothing clutches.

< Example 1 > **Synchronous encoder is connected to a drive axis**

When an external input mode clutch is used, set all clutches connected to the synchronous encoder to the external input mode. (Also set clutch ON/OFF device to the same setting.)

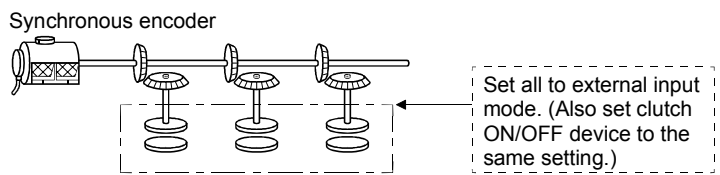

< Example 2 > **Same synchronous encoder is connected to auxiliary input axis**

Set all the clutches connected to the same synchronous encoder set to the external input mode. (Also set clutch ON/OFF devices to the same setting.)

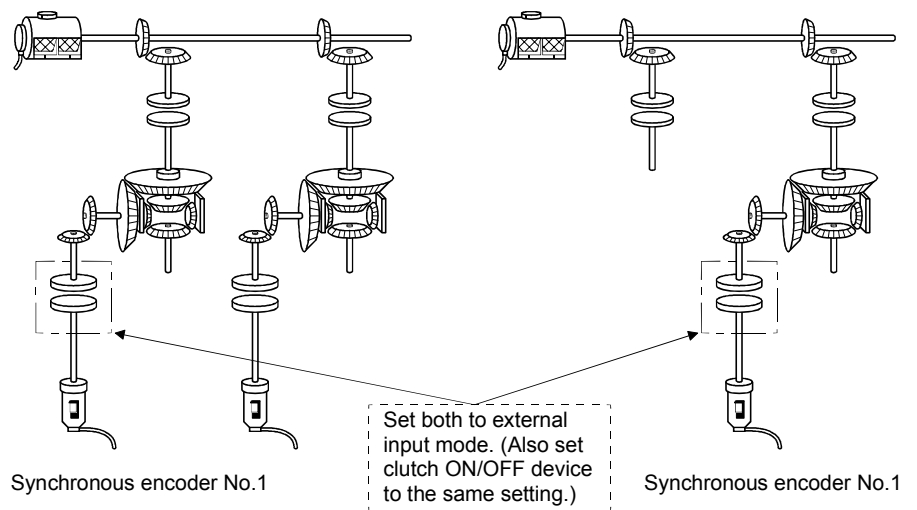

< Example 3 > **Same synchronous encoder is connected to a drive axis and auxiliary input axis**

Set all the connected clutches to the external input mode.
(Refer to examples 1 and 2)

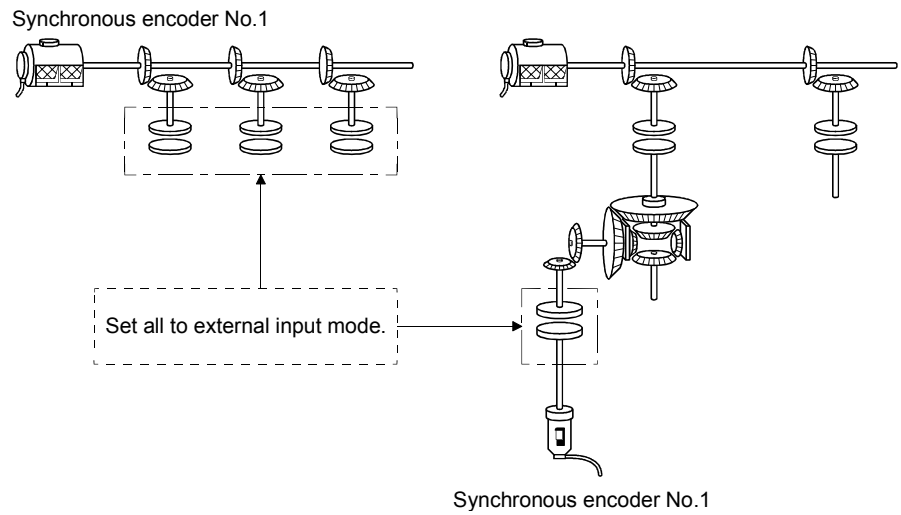

7 TRANSMISSION MODULE

7.2.2 Parameters

The clutch parameters are shown in Table 7.2 and the parameters shown in this table are explained in items (1) to (7) below.

Refer to the help of SW6RN-GSV22P for the clutch parameter setting.

Table 7.2 Clutch Parameter List

No.	Setting item	Default value	Setting range				Setting possible	
1	Operation mode	ON/OFF mode	ON/OFF mode	ON/OFF mode Address mode Address mode 2 One-shot mode	combined use	External input mode	Direct clutch	Smoothing clutch
2	Mode setting device (1 word)	—	—	Word device		—	○	○
3	Clutch ON/OFF command device	—	Bit device				○	○
4	Clutch ON address setting device (2 words)	—	—	Word device		—	○	○
5	Clutch OFF address setting device (2 words)							
6	Smoothing method	Time constant system	Time constant system/slippage system (Exponential function system/Linear acceleration deceleration system)				—	○
7	Smoothing time constant	—	1 to 65535 [ms]				—	○
8	Slippage setting device (2 words)	—	Word device				—	○
9	Slippage in-position range setting device (2 words)	—	Word device				—	○
10	Address mode clutch control system	Current value within 1 virtual axis revolution	Current value within 1 virtual axis revolution/ Current value of virtual axis				Valid when a cam/rotary table is set as the output module.	

○: Enable

(1) Operation mode

(a) This device is used to set the mode to switch clutch ON/OFF.

The following three modes can be set.

- ON/OFF mode
- ON/OFF mode, address mode, address mode 2 and one-shot mode combined use
- External input mode

Refer to Section "7.2.1 Operation" for each operation modes.

- (b) If a synchronous encoder is used as the drive module, the operation modes that can be set differ depending on the encoder interface connected to the Q173PX/Q172EX.

Encoder interface	Clutch operation mode		
	ON/OFF mode	Address mode, Address mode 2, One-Shot mode	External input mode
Manual pulse generator input (INC)	○	○	○
Serial encoder input (ABS)	○	○	×

○ : Enable, × : Disable

- (2) Mode setting device (only ON/OFF mode, address mode, address mode 2 and one-shot mode combined use, 1 word)

- (a) This device is used to switch the ON/OFF mode and address mode.

The mode by mode setting device value are as follows:

Mode setting device No.	Name
0	ON/OFF mode
1	Address mode
2	Address mode 2
3, 4	One-shot mode

The mode setting device of except for "0 to 4" is regarded as an error, and an operation is continued at the previous setting value.

- (b) The following devices can be used as the mode setting device.

Name	Setting range
Data register	D800 to D3069 ^(Note-1) D3080 to D8191
Link register	W0 to W1FFF

(Note-1) : D800 to D1559 are dedicated devices of virtual servomotor axis, synchronous encoder axis and output module "cam" in the virtual mode. Unused areas of virtual servomotor axis and cam axis can be used as an user device.

- (3) Clutch ON/OFF command device

- (a) This device is used to execute the clutch ON/OFF command.

- (b) The following devices can be used as the clutch ON/OFF command device.

Name	Setting range
Input	X0 to X1FFF
Output	Y0 to Y1FFF
Internal relay/Latch relay	M/L0 to M/L8191
Special relay	M9000 to M9255
Link relay	B0 to B1FFF
Annunciator	F0 to F2047

- (4) Clutch ON/OFF address setting device (only ON/OFF mode, address mode, address mode 2 and one-shot mode combined use, 2 words)
- (a) This device is used to set an address to turn the clutch on/off in the address mode.
- (b) The following devices can be used as the clutch ON/OFF address setting devices.

Name	Setting range ^(Note-1)
Data register	D800 to D3068 ^(Note-2) D3080 to D8190
Link register	W0 to W1FFE

(Note-1) : Set an even number as the first device.

(Note-2) : D800 to D1559 are dedicated devices of virtual servomotor axis, synchronous encoder axis and output module "cam" in the virtual mode. Unused areas of virtual servomotor axis and cam axis can be used as an user device.

- (c) The clutch ON/OFF address settings range is as follows.
- 1) The output module is a ball screw/roller, or output module is a cam/rotary table and the address mode clutch control system is current value of virtual axis.
-2147483648 (-2^{31}) to 2147483647 ($2^{31}-1$) [PLS]
 - 2) The output module is a cam/rotary table, and the address mode clutch control system is current value within virtual axis revolution.
0 to number of pulses within 1 output axis revolution -1 [PLS]
- (d) The clutch ON/OFF address setting device value according to the output module is as follows.

Refer to Section 7.2.1 (1) to (5) for details of each mode operation.

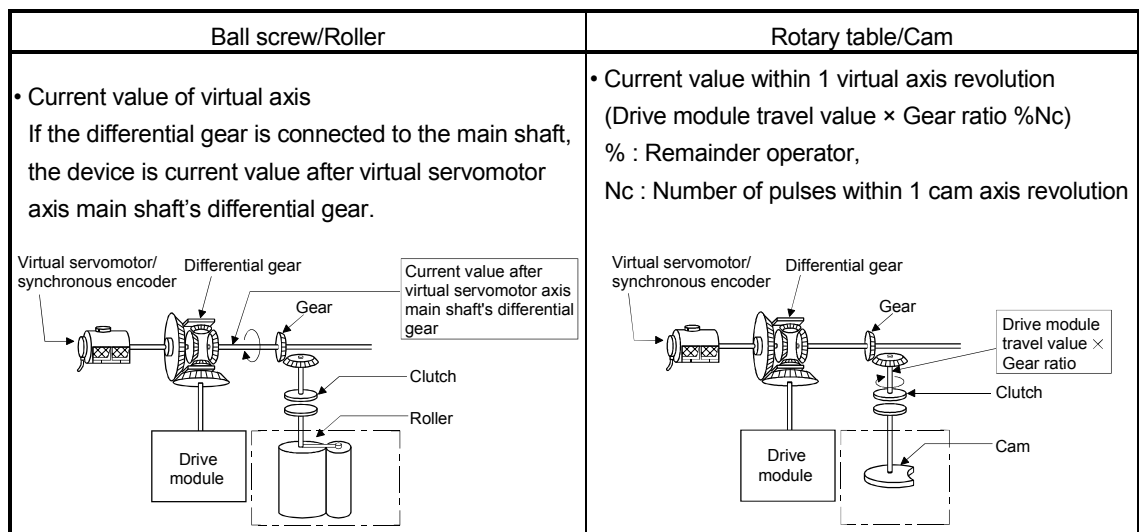

(5) Smoothing method

(a) The method for smoothing processing of the clutch is set.

The following two methods can be set:

- Time constant system
- Slippage system
 - { Exponential function system
 - { Linear acceleration/deceleration system

(b) Refer to Section 7.2 for each system operation.

(6) Smoothing time constant

This is the time taken to reach 63[%] of the output axis speed.

(7) Slippage setting device (2 words)

(a) This device is used to set the slippage of clutch.

(b) The following devices can be used as the slippage setting device.

Name	Setting range ^(Note-1)
Data register	D800 to D3068 ^(Note-2) D3080 to D8190
Link register	W0 to W1FFE

(Note-1) : Set an even number as the first device.

(Note-2) : D800 to D1559 are dedicated devices of virtual servomotor axis, synchronous encoder axis and output module "cam" in the virtual mode. Unused areas of virtual servomotor axis and cam axis can be used as an user device.

(c) The setting range for slippage is 0 to 2147483647 [PLS].

(8) Slippage in-position range setting device (2 words)

(a) This device is used to set the remainder slippage range for judge as smoothing completion.

(b) The following devices can be used as the slippage in-position range setting device.

Name	Setting range ^(Note-1)
Data register	D800 to D3068 ^(Note-2) D3080 to D8190
Link register	W0 to W1FFE

(Note-1) : Set an even number as the first device.

(Note-2) : D800 to D1559 are dedicated devices of virtual servomotor axis, synchronous encoder axis and output module "cam" in the virtual mode. Unused areas of virtual servomotor axis and cam axis can be used as an user device.

(c) The setting range for remainder slippage is 0 to 2147483647 [PLS].

7 TRANSMISSION MODULE

- (d) When "(Remainder slippage) < (Slippage in-position range)" is set, the smoothing clutch complete signal (M5520+2n, M5521+2n) turns on.
The smoothing clutch complete signal ON/OFF is refreshed by the operation cycle.

Connected module		Applicable device	Connected module		Applicable device
Output module for axis 1	Main shaft side	M5520	Output module for axis 17	Main shaft side	M5552
	Auxiliary input axis side	M5521		Auxiliary input axis side	M5553
Output module for axis 2	Main shaft side	M5522	Output module for axis 18	Main shaft side	M5554
	Auxiliary input axis side	M5523		Auxiliary input axis side	M5555
Output module for axis 3	Main shaft side	M5524	Output module for axis 19	Main shaft side	M5556
	Auxiliary input axis side	M5525		Auxiliary input axis side	M5557
Output module for axis 4	Main shaft side	M5526	Output module for axis 20	Main shaft side	M5558
	Auxiliary input axis side	M5527		Auxiliary input axis side	M5559
Output module for axis 5	Main shaft side	M5528	Output module for axis 21	Main shaft side	M5560
	Auxiliary input axis side	M5529		Auxiliary input axis side	M5561
Output module for axis 6	Main shaft side	M5530	Output module for axis 22	Main shaft side	M5562
	Auxiliary input axis side	M5531		Auxiliary input axis side	M5563
Output module for axis 7	Main shaft side	M5532	Output module for axis 23	Main shaft side	M5564
	Auxiliary input axis side	M5533		Auxiliary input axis side	M5565
Output module for axis 8	Main shaft side	M5534	Output module for axis 24	Main shaft side	M5566
	Auxiliary input axis side	M5535		Auxiliary input axis side	M5567
Output module for axis 9	Main shaft side	M5536	Output module for axis 25	Main shaft side	M5568
	Auxiliary input axis side	M5537		Auxiliary input axis side	M5569
Output module for axis 10	Main shaft side	M5538	Output module for axis 26	Main shaft side	M5570
	Auxiliary input axis side	M5539		Auxiliary input axis side	M5571
Output module for axis 11	Main shaft side	M5540	Output module for axis 27	Main shaft side	M5572
	Auxiliary input axis side	M5541		Auxiliary input axis side	M5573
Output module for axis 12	Main shaft side	M5542	Output module for axis 28	Main shaft side	M5574
	Auxiliary input axis side	M5543		Auxiliary input axis side	M5575
Output module for axis 13	Main shaft side	M5544	Output module for axis 29	Main shaft side	M5576
	Auxiliary input axis side	M5545		Auxiliary input axis side	M55477
Output module for axis 14	Main shaft side	M5546	Output module for axis 30	Main shaft side	M5578
	Auxiliary input axis side	M5547		Auxiliary input axis side	M5579
Output module for axis 15	Main shaft side	M5548	Output module for axis 31	Main shaft side	M5580
	Auxiliary input axis side	M5549		Auxiliary input axis side	M5581
Output module for axis 16	Main shaft side	M5550	Output module for axis 32	Main shaft side	M5582
	Auxiliary input axis side	M5551		Auxiliary input axis side	M5583

(Note) : The range of output module for axis No. 1 to 8 is valid in the Q172HCPU.

- (e) When "0" is set in the slippage in-position range setting device, when a clutch is connected/disconnected completely (Remainder slippage=0), the smoothing clutch complete signal (M5520+2n, M5521+2n) turns on.
- (f) Slippage in-position range can be changed at any time.
- (g) When the slippage in-position range setting device is not set, the smoothing clutch complete signal (M5520+2n, M5521+2n) does not turns on.

(h) When the setting value for slippage in-position range setting device is outside the range, a minor error [5430] of output module will occur at the time of switching from real mode to virtual mode. In this case, it controls as a setting value "0".

Besides, the setting value for slippage in-position range is set outside the range during virtual mode operation, a minor error [6170] of output module will occur, and it controls as a setting value "0".

(9) Address mode clutch control system

(a) When a clutch is turned on by the setting value of ON/OFF address setting device in the address mode/address mode 2, the current value (current value within 1 virtual axis revolution/current value of virtual axis) of virtual axis to be used is selected.

1) Current value within 1 virtual axis revolution

..... The ON/OFF control is executed by the current value within 1 virtual axis revolution system.

2) Current value of virtual axis

..... The ON/OFF control is executed by the current value of virtual axis. When a differential gear is connected to the main shaft, the ON/OFF control is executed by the current travel value after the main shaft's differential gear.

(b) The output module connected to clutch is valid for cam/rotary table

7.3 Speed Change Gear

Speed change gear is used to change the rotation speed to output module and travel value during operation.

The operation of speed change gear and parameters required to use it are shown below.

7.3.1 Operation

This section describes the operation of speed change gear.

- (1) The speed that the input axis speed multiplied by a speed change ratio set in the speed change ratio setting device is transmitted to output axis.

$$[\text{Output axis speed}] = [\text{Input axis speed}] \times \frac{[\text{Speed change ratio}]}{10000} [\text{PLS}]$$

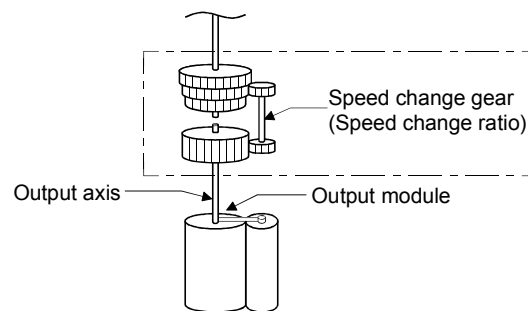

- (2) When a speed change ratio changes, the acceleration/deceleration processing is executed by the smoothing time constant (t) set in the speed change gear parameters.

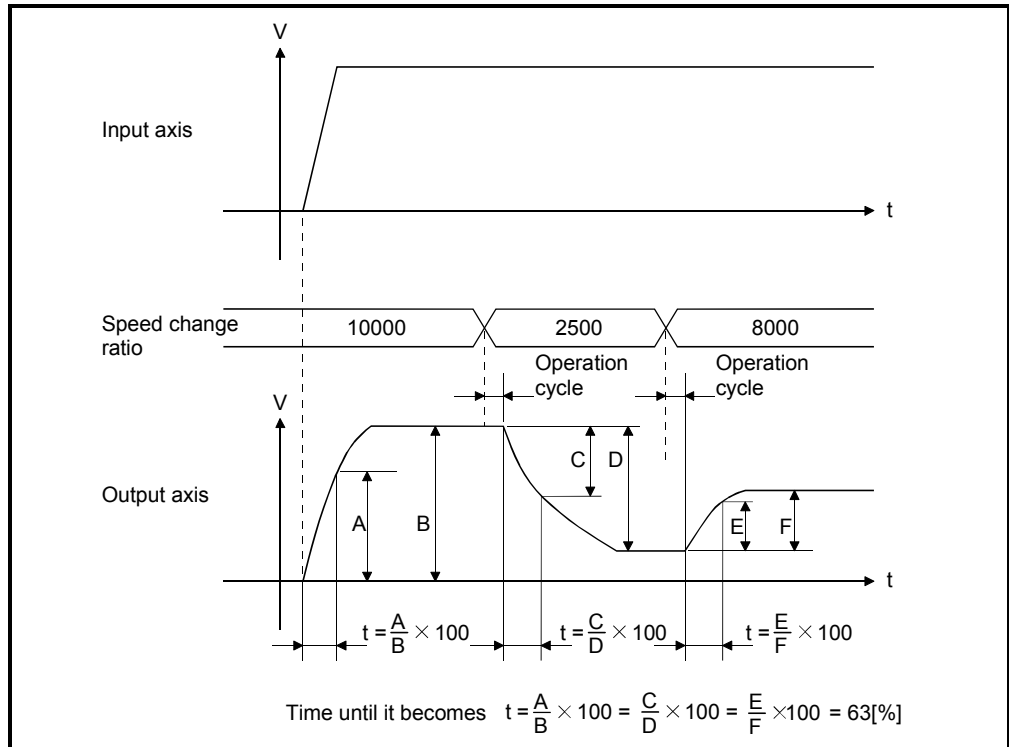

7.3.2 Parameters

The speed change gear parameters are shown in Table 7.3 and the parameters shown in this table are explained in items (1) to (3) below.

Refer to the help of SW6RN-GSV22P for the speed change gear parameter setting method.

Table 7.3 Speed Change Gear Parameter List

No.	Setting Item	Default	Setting range
1	Speed change ratio upper limit value	10000	1 to 10000
2	Speed change ratio lower limit value	1	1 to 10000
3	Speed change ratio setting device (1 word)	—	D800 to D3069 D3080 to D8191 W0 to W1FFF
4	Smoothing time constant	0	0 to 65535 [ms]

- (1) Speed change ratio upper/lower limit value
 (a) The validate range (0.01 to 100[%]) of speed change ratio set in the speed change ratio setting device is set.

- (b) When the setting value of speed change ratio setting device is greater than the speed change ratio upper limit value, an operation is executed by a speed change ratio clamped at the upper limit value.
When the setting value of speed change ratio setting device is smaller than the speed change ratio lower limit value, an operation is executed by a speed change ratio clamped at the lower limit value.

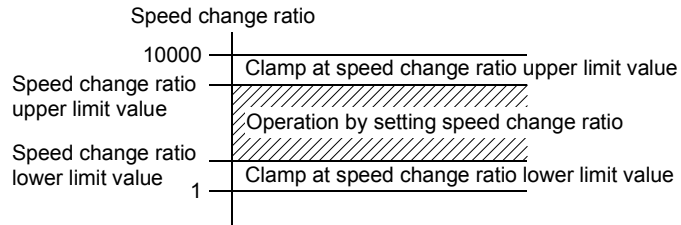

- (c) The speed change ratio upper/lower limit value is set in the range of 1 to 10000, i.e. 100 times the settings actually made: 0.01 to 100%.

- (d) Set the speed change ratio upper/lower limit value as formula below.

$$1 \leq (\text{Speed change ratio lower limit value}) \leq (\text{Speed change ratio upper limit value}) \leq 10000$$

(2) Speed change ratio setting device

- (a) The device to set a speed change ratio of speed change gear.
- (b) The following devices can be used as the speed change ratio setting devices.

Name	Setting range
Data register	D800 to D3069 ^(Note)
	D3080 to D8191
Link register	W0 to W1FFF

(Note) : D800 to D1559 are dedicated devices of virtual servomotor axis, synchronous encoder axis and output module "cam" in the virtual mode. Unused areas of virtual servomotor axis and cam axis can be used as an user device.

- (c) The setting range is "Speed change ratio lower limit value" to "Speed change ratio upper limit value".

(3) Smoothing time constant

This is the time taken to reach 63[%] of the output axis speed.

7.4 Differential Gear

The differential gear is used for the following purposes;

- Output module phase is shifted or alignment of operation start position is executed.
- Individual operation separated from the virtual main shaft is executed.

7.4.1 Operation

(1) When the output module phase is shifted or alignment of the operation start position is executed.

(a) When the input axis clutch turned on.

The differential gear subtracts the auxiliary input shaft travel value from the input shaft travel value and transmits this to the output axis.

$$\boxed{\text{Output axis travel value}} = \boxed{\text{Input axis travel value}} - \boxed{\text{Auxiliary input axis travel value}} \text{ [PLS]}$$

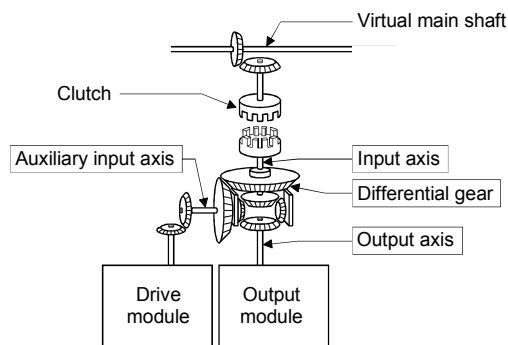

(b) When the input axis clutch turned off.

Individual operation is possible using the auxiliary input axis since the differential gear transmits only the travel value from the auxiliary input axis to the output axis.

(2) When the differential gear is used to connect to the virtual main shaft.

This is used for operation in which the main shaft is switched or when the same drive module is used as auxiliary input to control all blocks.

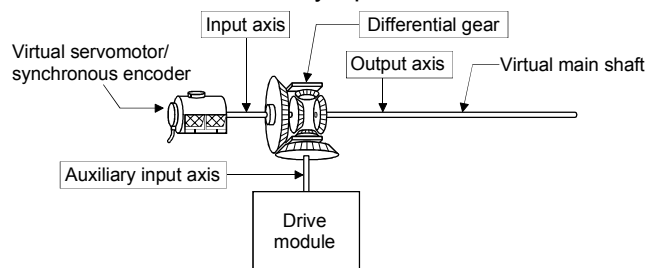

Set the different drive modules for virtual main shaft side and auxiliary input axis side.

7.4.2 Parameters (Must be not set)

No parameters need to be set for the differential gear.

8. OUTPUT MODULE

The command pulse output from drive module is input to output module via the transmission module.

The travel value of servomotor is controlled by the command pulse from output module.

There are following four output modules.

The parameters in accordance with that mechanism is set if necessary.

- Roller..... Section 8.1
- Ball screw..... Section 8.2
- Rotary table..... Section 8.3
- Cam Section 8.4

(1) Output module types

Output module types are shown below.

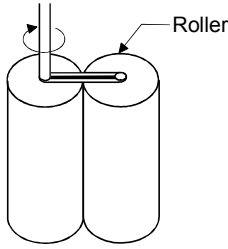
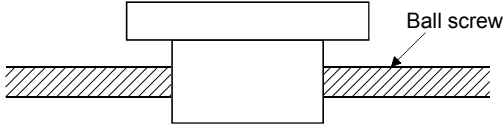
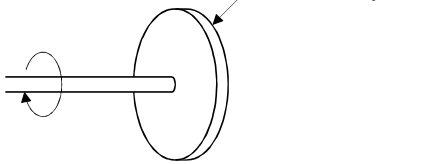
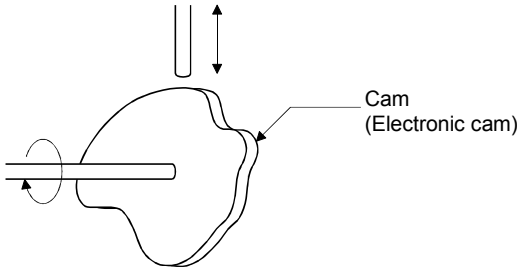
Module	Details	Applications
Roller	The speed control is executed with the final output (axis).	
Ball screw	The linear position control is executed with the final output (axis).	
Rotary table	The angle control is executed with the final output (axis).	
Cam	The electronic cam operation is executed with the final output (axis).	

8 OUTPUT MODULE

(2) Device range of output module parameters and device data input

The device range and setting method of items set in the indirect setting by devices among the output module parameters are shown below.

(a) Device range

The number of device words and device range in the indirect setting are shown below.

Module	Item	Number of device words	Device range		Remark
Roller	Torque limit value setting device	1			
Ball screw	Torque limit value setting device	1			
Rotary table	Torque limit value setting device	1			
	Current value within 1 virtual axis revolution storage device (Main shaft side)	2			
	Current value within 1 virtual axis revolution storage device (Auxiliary input axis side)	2			
Cam	Cam No. setting device	1	D	800 to 3069 3080 to 8191	
	Stroke amount setting device	2	W	0 to 1FFF	
	Torque limit value setting device	1			
	Lower stroke limit value storage device	2			
	Current value within 1 virtual axis revolution storage device (Main shaft side)	2			
	Current value within 1 virtual axis revolution storage device (Auxiliary input axis side)	2			

POINT

- (1) Be sure to set an even-numbered device for the items set as 2-word. And, when the data is set to device in the Motion SFC program, set it as 32-bit integer type.
- (2) When a 2-word monitor device is read in the Motion SFC program, read it as 32-bit integer type.

8 OUTPUT MODULE

(b) Device data input

All indirect setting device data are input as "initial value" at the switching from real to virtual mode, thereafter the input control for module is executed during the virtual mode operation.

The input timing and refresh cycle of setting device are shown below.

Module	Item	Input device	Refresh device	Device input timing		Refresh cycle
				Real → Virtual mode switching	During the Virtual mode operation	
Roller	Torque limit value setting device	○	—	○	Input for every operation cycle. (Note)	—
Ball screw	Torque limit value setting device	○	—	○		
Rotary table	Torque limit value setting device	○	—	○		
	Current value within 1 virtual axis revolution storage device (Main shaft side)	—	○	—	—	Operation cycle (Note)
	Current value within 1 virtual axis revolution storage device (Auxiliary input axis side)	—	○	—		
Cam	Cam No. setting device	○	—	○	Input for every operation cycle. (Note) However, the cam No. and stroke amount switching position pass point are valid.	—
	Stroke amount setting device	○	—	○		
	Torque limit value setting device	○	—	○	Input for every operation cycle. (Note)	Operation cycle (Note)
	Lower stroke limit value storage device	—	○	—		
	Current value within 1 virtual axis revolution storage device (Main shaft side)	—	○	—		
	Current value within 1 virtual axis revolution storage device (Auxiliary input axis side)	—	○	—		

REMARK

(Note) : The operation cycle is set in the "operation cycle setting" of system basic setting.

Refer to the "Q173HCPU/Q172HCPU Motion controller Programming Manual (COMMON)" for details.

The operation cycle of Motion CPU is shown below.

Item		Q173HCPU	Q172HCPU
Number of control axes		Up to 32 axes	Up to 8 axes
Operation cycle (Default)	SV22	0.88[ms] / 1 to 5 axes 1.77[ms] / 6 to 14 axes 3.55[ms] / 15 to 28 axes 7.11[ms] / 29 to 32 axes	0.88[ms] / 1 to 5 axes 1.77[ms] / 6 to 8 axes

8 OUTPUT MODULE

8.1 Rollers

The rollers are used in the following cases.

- The machine connected to the servomotor is operated continuously.
- The system which does not need position control.
(It is used when the speed control (cycle speed/number of rotations) mainly is controlled without the current value and position data.)

This section describes the roller operation and parameters required to use a roller.

8.1.1 Operation

(1) Operation

- (a) The roller is controlled with the speed that the speed/travel value of drive module multiplied by a gear ratio/speed change ratio of transmission module, and it rotates for the travel value.

Roller speed	=	(Drive module speed [PLS/s])	×	(Gear ratio)	×	(Speed change ratio) [PLS/s]
Number of roller revolution	=	(Drive module travel value [PLS])	×	(Gear ratio)	×	(Speed change ratio) [PLS]

The speed/travel value of drive module transmitted to the roller is commanded to the servo amplifier.

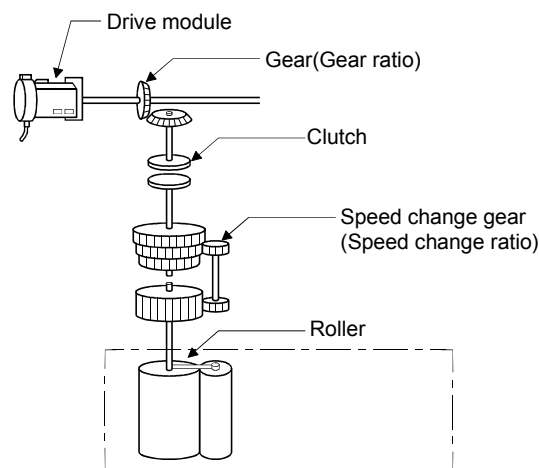

- (b) When a clutch is used, the roller is controlled at clutch ON.

(2) Control details

(a) The roller has no current value.

However, when it switches from the virtual to real mode, it reaches the current value corresponding to the position moved in the virtual mode.

- The current value is a ring address within the range of -2^{31} to $2^{31}-1$ [PLS].

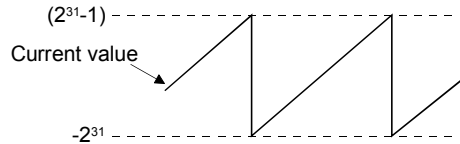

(b) Backlash compensation processing is continued with the settings value of fixed parameters even if it switches the real/virtual mode.

(c) The roller cycle speed can be monitored using a peripheral device and the roller cycle speed storage register.

Refer to Section 8.1.2 for the calculation formula of roller cycle speed, and refer to Section 4.2.1 for details of the roller cycle speed storage register.

8.1.2 Parameter list

The roller parameters are shown in Table 8.1 and the parameters shown in this table are explained in items (1) to (6) below.

Refer to the help of SW6RN-GSV22P for the roller parameter setting method.

Table 8.1 Roller Parameter List

No.	Setting item	Default	Setting range	
1	Output axis No.	0	Q173HCPU : 1 to 32 Q172HCPU : 1 to 8	
2	Output unit	mm	mm	inch
3	Roller diameter (L)	0	0.1 to 214748364.7 [μm]	0.00001 to 21474.83647 [inch]
4	Number of pulses per roller revolution (NL)	0	1 to 2147483647 [PLS]	
5	Permissible droop pulse value	65535	1 to 65535 [×100 PLS]	
6	Speed limit value (VL)	0	0.01 to 6000000.00 [mm/min]	0.001 to 600000.000 [inch/min]
7	Torque limit value setting device (1 word)	—	-(300[%]) / word device (D, W)	
8	Comment	None	32 characters	

(1) Output unit

(a) This device is used to set the unit ([mm]/[inch]) of roller.

(b) The unit (unit in the fixed parameter) for the axis which execute the roller setting in the real mode is permissible to use the any of [mm], [inch], [degree] and [PLS].

(2) Roller diameter (L)/Number of pulses per roller revolution (NL)

- (a) The roller diameter connected to servomotor and the number of pulses per roller revolution are displayed.

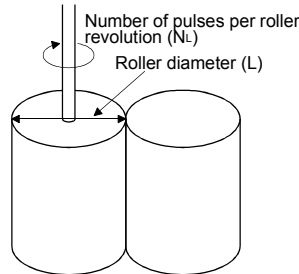

- (b) The roller cycle speed is calculated by the roller diameter and number of pulses per roller revolution as the formula below.

1) Unit : [mm]

$$[\text{Roller cycle speed}] = \left[\frac{\text{Number of input pulses per minute}}{\text{NL}} \right] \times \frac{\pi \times L}{\text{NL}} [\text{mm/min}] \quad L : [\text{mm}]$$

2) Unit : [inch]

$$[\text{Roller cycle speed}] = \left[\frac{\text{Number of input pulses per minute}}{\text{NL}} \right] \times \frac{\pi \times L}{\text{NL}} [\text{inch/min}] \quad L : [\text{inch}]$$

The value calculated by calculations 1) and 2) is stored with an integer value in the roller cycle speed storage register.

Output unit	Roller cycle speed storage register
mm	Calculated value × 100
inch	Calculated value × 1000

(3) Permissible droop pulse value

- (a) This device is used to set the permissible droop pulse value of deviation counter.

- (b) The deviation counter value is continually checked, and if it becomes larger than the permissible droop pulse value, the error detection signal (M2407+20n) turns on.
However, since the roller axis operation continues, execute the error processing by user side.

(4) Speed control limit (VL)

- (a) This device is used to set the maximum speed of roller axis.

- (b) Set the speed limit value within the following range.

$$1 \leq \frac{V_L \times NL}{60 \times \pi \times L} \leq 2147483647 [\text{PLS/s}] \quad \begin{matrix} V_L : [\text{mm/min}] \text{ or } [\text{inch/min}] \\ L : [\text{mm}] \text{ or } [\text{inch}] \end{matrix}$$

- (c) When the roller axis speed exceeds the speed limit value, the error detection signal (M2407+20n) turns on.
 However, the roller axis speed is not clamped.

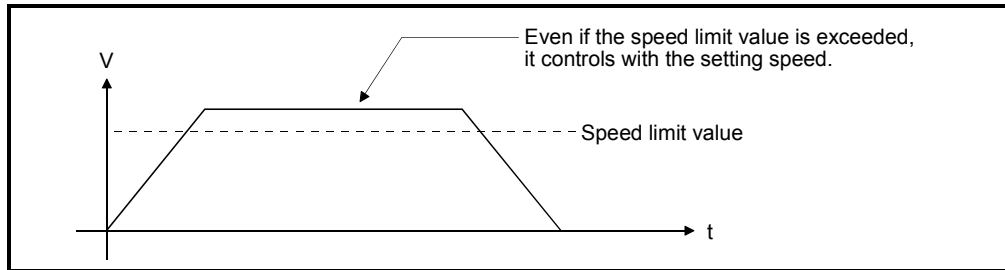

(5) Torque limit value setting device (1 word)

- (a) This device is used to set the torque limit value of roller axis.
 When the device is set, the torque control is executed with the preset device value.
 In the virtual mode, the torque limit setting is always valid.
 If the device is not set, the torque limit is set at 300[%].

- (b) The following devices can be set as the torque limit setting device.

Name	Setting range
Data register	D800 to D3069 ^(Note-1) D3080 to D8191
Link register	W0 to W1FFF

(Note-1) : D800 to D1559 are dedicated devices of virtual servomotor axis, synchronous encoder axis and output module "cam" in the virtual mode. Unused areas of virtual servomotor axis and cam axis can be used as an user device.

- (c) The setting range for torque limit value is 1 to 1000[%].

(6) Comment

- (a) This device is used to create a comment such as purpose of roller axis.
 Made comment can be displayed at monitoring using a peripheral device.
- (b) Comments up to 32 characters long can be created.

POINT
(1) "Roller diameter" or "number of pulses per roller revolution" set in the roller parameter is used for only the cycle speed monitor of servomotor, and it is not related to the rotation speed/travel value of servomotor.
(2) The roller cycle speed monitor device is the same for the "feed current value" in the real mode. Therefore, the position address (current value) of roller axis cannot be monitored in the virtual mode. When it switches from the virtual to real mode, the certain value is stored in the position address (current value). The value at this time is an unfixed value.

8.2 Ball Screw

The ball screw is used to make a machine connected to servomotor operate linearly. This section describes the ball screw operation and parameters required to use ball screws.

8.2.1 Operation

(1) Operation

- (a) The ball screw is controlled with the speed that the speed/travel value of drive module multiplied by a gear ratio of transmission module, and the travel value is output.

$$\text{(Ball screw speed)} = \text{(Drive module speed [PLS/s])} \times \text{(Gear ratio)} \quad \text{[PLS/s]}$$

$$\text{(Ball screw travel value)} = \text{(Drive module travel value [PLS])} \times \text{(Gear ratio)} \quad \text{[PLS]}$$

The speed/travel value of drive module transmitted to the ball screw is commanded to the servo amplifier.

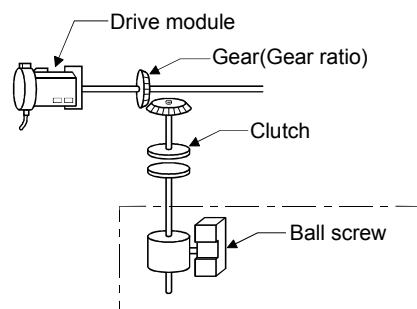

- (b) When a clutch is used, the ball screw is controlled at clutch ON.

(2) Control details

- (a) Feed current value is continued, even if it switches from the real to virtual mode/from the virtual to real mode.
- (b) Backlash compensation processing is continued with the settings value of fixed parameters, even if it switches the real/virtual mode.
- (c) The travel value per pulse is controlled with the travel value per pulse in the fixed parameters.

8.2.2 Parameter list

The ball screw parameters are shown in Table 8.2 and the parameters shown in this table are explained in items (1) to (7) below.

Refer to the help of SW6RN-GSV22P for the ball screw parameter setting method.

Table 8.2 Ball Screw Parameter List

No.	Setting Item	Default	Setting range	
1	Output axis No.	0	Q173HCPU : 1 to 32 Q172HCPU : 1 to 8	
2	Output unit	mm	mm	inch
3	Ball screw pith (P)	Must be not set. It is controlled with the fixed parameter.		
4	Number of pulses per ball screw revolution (NP)			
5	Permissible droop pulse value	65535	1 to 65535 [$\times 100$ PLS]	
6	Upper stroke limit value	214748364.7	-214748364.8 to	-21474.83648 to
7	Lower stroke limit value	0	214748364.7 [μm]	21474.83647 [inch]
8	Speed limit value (VL)	0	0.01 to 6000000.00 [mm/min]	0.001 to 600000.000 [inch/min]
9	Torque limit value setting device (1 word)	—	-(300[%]) / word device (D, W)	
10	Comment	None	32 characters	

(1) Output unit

(a) This device is used to set the unit ([mm]/[inch]) of ball screw.

(b) Set the same unit as used in the real mode (unit in the fixed parameters) for the ball screw unit.

If the ball screw unit differs unit in the real mode, a mode switching error will occur at the switching from real to virtual mode.

(2) Ball screw pitch(P)/Number of pulses per ball screw revolution(NP)

(a) The ball screw pitch connected to the servomotor and number of pulses per ball screw revolution are displayed.

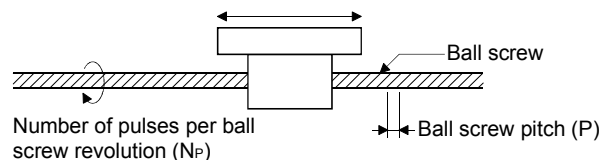

Displayed items	Default	Displayed range
Ball screw pith (P)	Must be not set. It is controlled with the fixed parameter.	
Number of pulses per ball screw revolution (NP)		

- (b) The travel value per pulse is calculated by the ball screw pitch and number of pulses per ball screw revolution as the formula below.

$$\boxed{[\text{Travel value per pulse}] = \frac{P}{N_P}}$$

(3) Permissible droop pulse value

- (a) This device is used to set the permissible droop pulse value of deviation counter.
- (b) The deviation counter value is continually checked, and if it becomes larger than the permissible droop pulse value, the error detection signal (M2407+20n) turns on.
However, since the ball screw axis operation continues, execute the error processing by user side.

(4) Upper/lower stroke limit value

- (a) This device is used to set the stroke range in the virtual mode.
- (b) When it exceeds the stroke range during operation, the error detection signal (M2407+20n) turns on.
However, a stop processing of ball screw axis is not executed.

(5) Speed limit value (VL)

- (a) This device is used to set the maximum speed of ball screw axis.
- (b) Set the speed limit value within the following range.

1) Unit : [mm]

$$\boxed{1 \leq \frac{V_L \times 10^4 \times N_P}{60 \times P} \leq 2147483647 \quad [\text{PLS/s}]}$$

2) Unit : [inch]

$$\boxed{1 \leq \frac{V_L \times 10^5 \times N_P}{60 \times P} \leq 2147483647 \quad [\text{PLS/s}]}$$

- (c) When the ball screw axis speed exceeds the speed limit value, the error detection signal (M2407+20n) turns on.
However, the ball screw axis speed is not clamped.

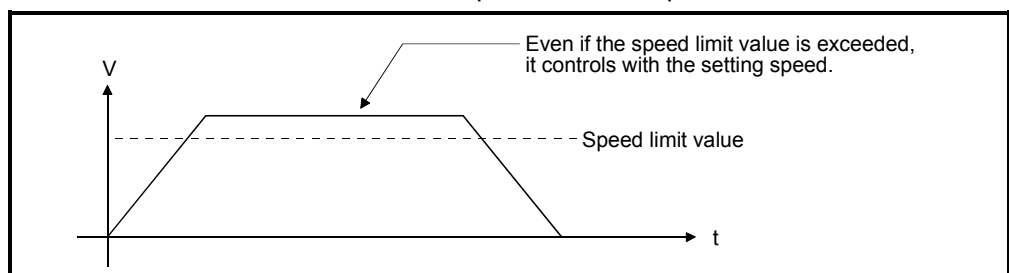

(6) Torque limit value setting device (1 word)

- (a) This device is used to set the torque limit value of ball screw axis.
 When the device is set, the torque control is executed with the preset device value.
 In the virtual mode, the torque limit setting is always valid.
 If the device is not set, the torque limit is set at 300[%].

- (b) The following devices can be set as the torque limit value setting device.

Name	Setting range
Data register	D800 to D3069 ^(Note-1) D3080 to D8191
Link register	W0 to W1FFF

(Note-1) : D800 to D1559 are dedicated devices of virtual servomotor axis, synchronous encoder axis and output module "Cam" in the virtual mode. Unused areas of virtual servomotor axis and cam axis can be used as an user device.

- (c) The setting range for the torque limit value is 1 to 1000[%].

(7) Comment

- (a) This device is used to create a comment such as purpose of ball screw axis.
 Made comment can be displayed at monitoring using a peripheral device.
- (b) Comments up to 32 characters long can be created.

8.3 Rotary Tables

The rotary table is used to make a machine connected to servomotor gyrate. This section describes the rotary table operation and parameters required to use rotary table.

8.3.1 Operation

(1) Operation

- (a) The rotary table is controlled with the speed that the speed/travel value of drive module multiplied by a gear ratio of transmission module, and the travel value is output.

$$\begin{aligned} \text{(Rotary table speed)} &= \text{(Drive module speed) [PLS/s]} \times \text{(Gear ratio) [PLS/s]} \\ \text{(Rotary table travel value)} &= \text{(Drive module travel value) [PLS]} \times \text{(Gear ratio) [PLS]} \end{aligned}$$

The speed/travel value of drive module transmitted to the rotary table is commanded to the servo amplifier.

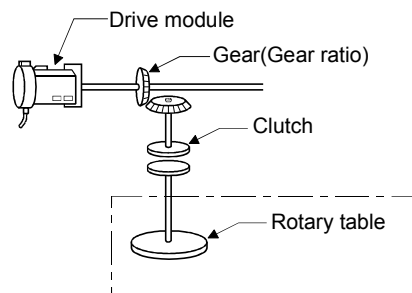

- (b) When a clutch is used, the rotary table is controlled at clutch ON.

(2) Control details

- (a) Feed current value is continued, even if it switches from the real to virtual mode/from the virtual to real mode.
- (b) Backlash compensation processing is continued with the settings value of fixed parameters, even if it switches the real/virtual mode.
- (c) The travel value per pulse is controlled with the travel value per pulse in the fixed parameters.

8.3.2 Parameter list

The rotary table parameters are shown in Table 8.3 and the parameters shown in this table are explained in items (1) to (8) below.

Refer to the help of SW6RN-GSV22P for the rotary table parameter setting method.

Table 8.3 Rotary Table Parameter List

No.	Setting Item	Default	Setting range
1	Output axis No.	0	Q173HCPU : 1 to 32 Q172HCPU : 1 to 8
2	Number of pulses per rotary table revolution (Nd)		Must be not set. It is controlled with the fixed parameter.
3	Permissible droop pulse value	65535	1 to 65535 [× 100 PLS]
4	Upper stroke limit value	0	0 to 359.99999 [degree]
5	Lower stroke limit value	0	0 to 359.99999 [degree]
6	Speed limit value (VL)	0	0.001 to 2147483.647 [degree/min] ^(Note-1)
7	Torque limit value setting device (1 word)	—	-(300[%]) / word device (D, W)
8	Comment	None	32 characters
9	Current value within 1 virtual axis revolution storage device (Main shaft side) (2 words)	—	- / word device (D, W)
10	Current value within 1 virtual axis revolution storage device (Auxiliary input axis side) (2 words)	—	- / word device (D, W)

(Note-1) : When the "speed control 10 × multiplied speed setting for degree axis" is set to "valid", the setting range is 0.01 to 21474836.47[degree/min].

(1) Number of pulses per rotary table revolution (ND)

- (a) The number of pulses per rotary table connected to the servomotor revolution is displayed.

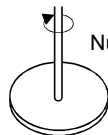

Number of pulses per rotary table revolution (Nd)

Displayed items	Default	Displayed range
Number of pulses per rotary table revolution (Nd)		Must be not set. It is controlled with the fixed parameter. $Nd = Ap[PLS] \times \frac{360[degree]}{AL [degree]}$ AP : Number of pulses value per revolution of fixed parameter AL : Travel value per revolution of fixed parameter

- (b) The travel value per pulse is calculated from the number of pulses per rotary table revolution in accordance with the following formula:

$$\boxed{[\text{Travel value per pulse}] = \frac{360}{N_D} [\text{degree}]}$$

(2) Permissible droop pulse value

- (a) This device is used to set the permissible droop pulse value of deviation counter.
- (b) The deviation counter value is continually checked, and if it becomes larger than the permissible droop pulse value, the error detection signal (M2407+20n) turns on.
However, since the rotary table axis operation continues, execute the error processing by user side.

(3) Upper/lower stroke limit value

- (a) This device is used to set the stroke range in the virtual mode.
The upper/lower stroke limit setting determines whether the stroke limit is valid or not. If the upper stroke limit value is equal to the lower stroke limit value, the stroke limit is invalid.
- (b) When it exceeds the stroke range during operation, the error detection signal (M2407+20n) turns on.
However, a stop processing of rotary table axis is not executed.

(4) Speed limit value (VL)

- (a) This device is used to set the maximum speed of rotary table axis.
- (b) Set the speed limit value within the following range.

$$\boxed{1 \leq \frac{V_L \times 10^5 \times N_D}{60 \times 360 \times 10^5} \leq 2147483647 \quad [\text{PLS/s}]}$$

- (c) When the rotary table axis speed exceeds the speed limit value, the error detection signal (M2407+20n) turns on.
However, the rotary table axis speed is not clamped.

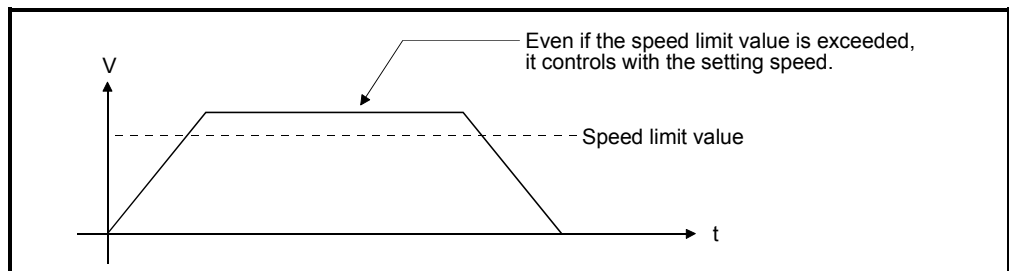

(5) Torque limit value setting device (1 word)

- (a) This device is used to set the torque limit value of rotary table axis.
When the device is set, the torque control is executed with the preset device value.
In the virtual mode, the torque limit setting is always valid.
If the device is not set, the torque limit is set at 300[%].

- (b) The following devices can be set as the torque limit value setting device.

Name	Setting range
Data register	D800 to D3069 ^(Note-1) D3080 to D8191
Link register	W0 to W1FFF

(Note-1) : D800 to D1559 are dedicated devices of virtual servomotor axis, synchronous encoder axis and output module "Cam" in the virtual mode. Unused areas of virtual servomotor axis and cam axis can be used as an user device.

- (c) The setting range for torque limit value is 1 to 1000[%].

(6) Comment

- (a) This device is used to create a comment such as purpose of rotary table axis.
Made comment can be displayed at monitoring using a peripheral device.
- (b) Comments up to 32 characters long can be created.

(7) Current value within 1 virtual axis revolution storage device (Main shaft side) (2 words)

This parameter is set when the address mode clutch is set at the rotary table main shaft side.

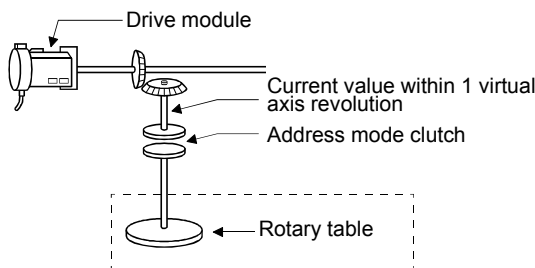

$$\text{Current value within 1 virtual axis revolution} = (\text{Drive module travel value} \times \text{gear}) \% N_D$$

(% : Remainder operator)

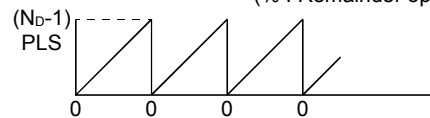

The reference position (0) for the current value within 1 virtual axis revolution is set with the address clutch reference setting command (M3213+20n).

- (a) The current value within 1 virtual axis revolution of rotary table main shaft side is stored in the preset device.

- (b) The following devices can be set as the current value within 1 virtual axis revolution storage device.

Name	Setting range ^(Note-1)
Data register	D800 to D3069 ^(Note-2) D3080 to D8191
Link register	W0 to W1FFF

(Note-1) : Set an even number at the first device.

(Note-2) : D800 to D1559 are dedicated devices of virtual servomotor axis, synchronous encoder axis and output module "Cam" in the virtual mode. Unused areas of virtual servomotor axis and cam axis can be used as an user device.

- (c) The current value within 1 virtual axis revolution is the range of 0 to (ND-1) [PLS].
(ND: Number of pulses per rotary table revolution)
- (d) The address mode clutch is turned on/off with the specified address of the current value within 1 virtual axis revolution range of 0 to (ND-1) [PLS]. Therefore, set the address value within the range of 0 to (ND-1) [PLS] in the clutch ON/OFF address setting device.
- (e) The current value within 1 virtual axis revolution reference position "0" is set by turning the address clutch reference setting command (M3213+20n) on and switching to the virtual mode.
The current values within 1 virtual axis revolution for both the main shaft and the auxiliary input axis is set to "0" at this time.
If the address clutch reference setting command (M3213+20n) is turned off and it switches to the virtual mode, control continues from the current value within 1 virtual axis revolution of last virtual mode.

(f) An example of an address mode clutch operation is shown below.

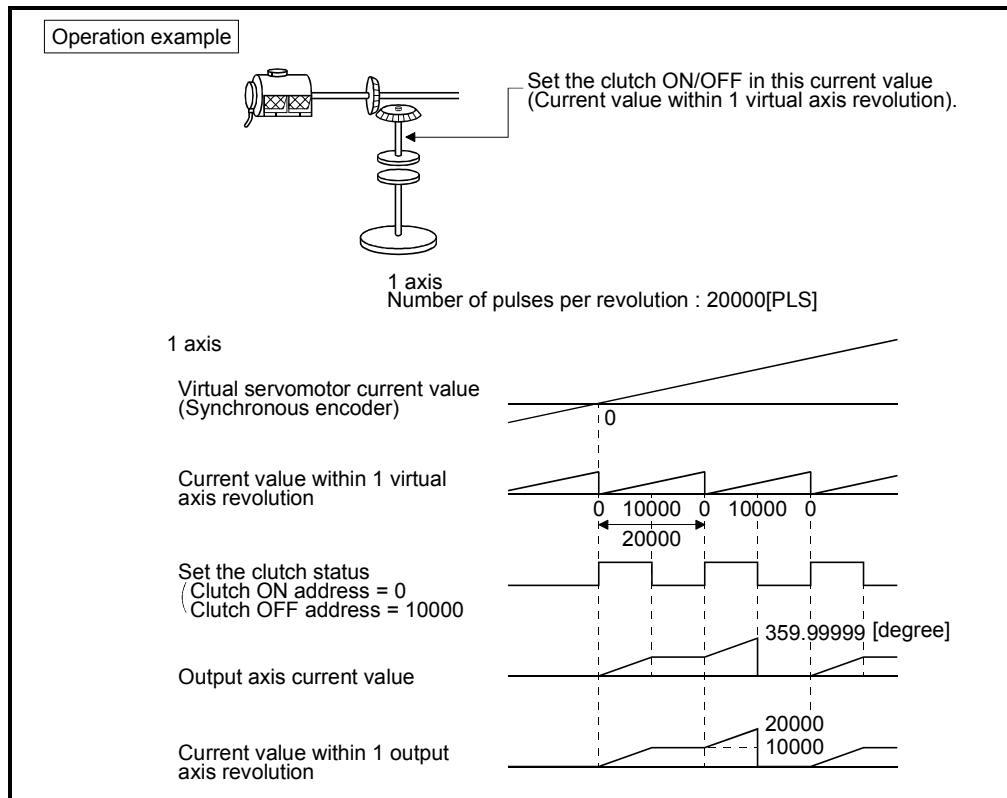

(8) Current value within 1 virtual axis revolution storage device
(Auxiliary input axis side) (2 words)

This parameter is set when the address mode clutch is set at the rotary table auxiliary input axis side.

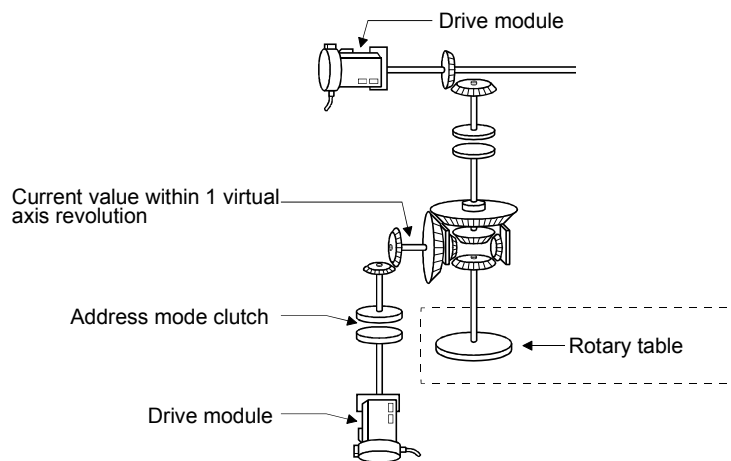

(a) By setting the current value within 1 virtual axis revolution of rotary table auxiliary input axis side for the current value within 1 virtual axis revolution is stored in the preset device.

Current value within 1 virtual axis revolution of auxiliary input axis side	=	Drive module travel value of auxiliary input axis side	×	$\frac{\text{Gear ratio}}{\text{Number of pulses per rotary table revolution}}$
-----------------------------------------------------------------------------	---	--------------------------------------------------------	---	---------------------------------------------------------------------------------

(Note): Current value within 1 virtual axis revolution of auxiliary input axis side is updated regardless of clutch ON/OFF.

- (b) The following devices can be set as the current value within 1 virtual axis revolution storage device.

Name	Setting range ^(Note-1)
Data register	D800 to D3069 D3080 to D8191
Link register	W0 to W1FFF

(Note-1) : Set an even number at the first device.

(Note-2) : D800 to D1559 are dedicated devices of virtual servomotor axis, synchronous encoder axis and output module "Cam" in the virtual mode. Unused areas of virtual servomotor axis and cam axis can be used as an user device.

- (c) The current value within 1 virtual axis revolution is the range of 0 to (ND-1) [PLS].
(ND: Number of pulses per rotary table revolution)
- (d) The address mode clutch is turned on/off with the specified address of the current value within 1 virtual axis revolution range of 0 to (ND-1) [PLS]. Therefore, set the address value within the range of 0 to (ND-1) [PLS] in the clutch ON/OFF address setting device.
- (e) The current value within 1 virtual axis revolution reference position "0" is set by turning the address clutch reference setting command (M3213+20n) on and switching to the virtual mode.
The current values within 1 virtual axis revolution for both the main shaft and the auxiliary input axis is set to "0" at this time.
If the address clutch reference setting command (M3213+20n) is turned off and it switches to the virtual mode, control continues from the current value within 1 virtual axis revolution of last virtual mode.

(f) An example of an address mode clutch operation is shown below.

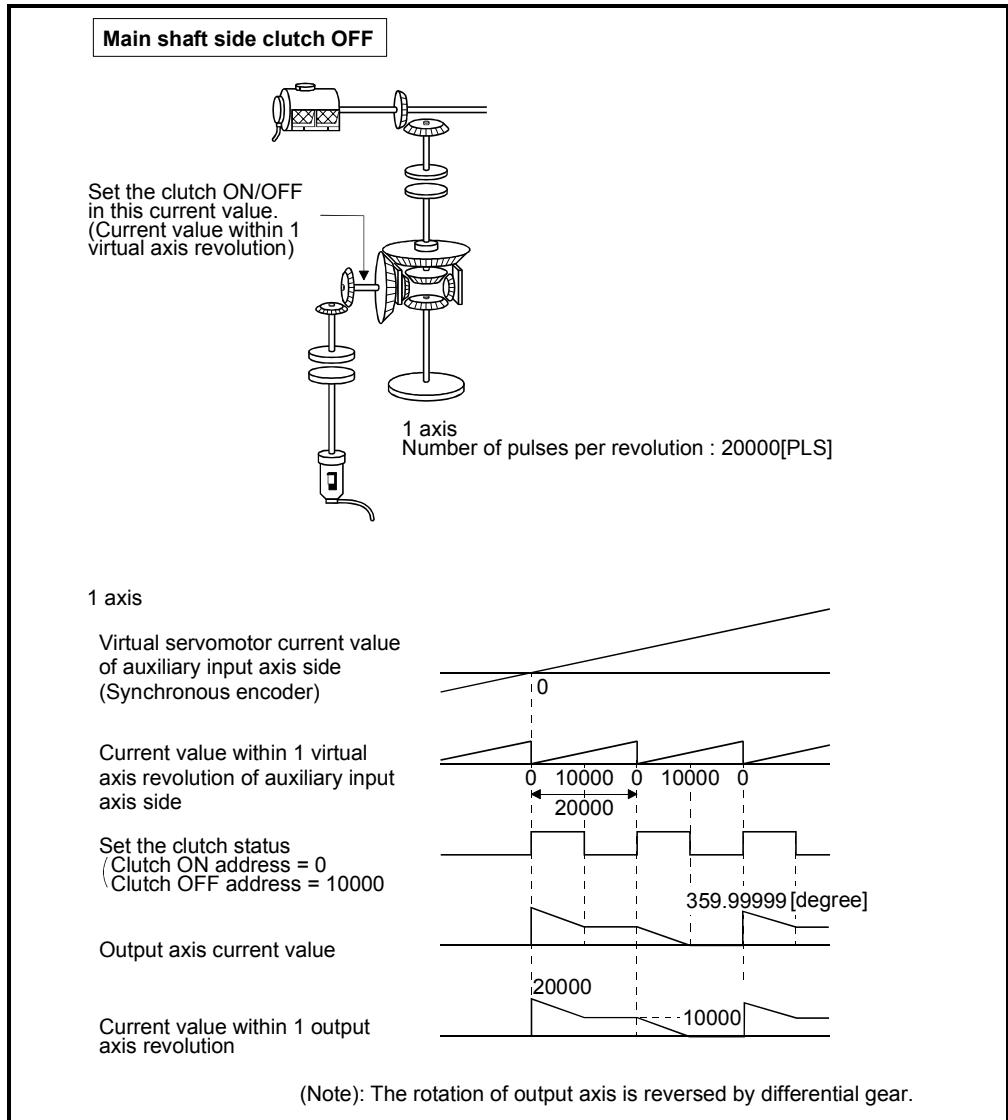

POINT

When the number of pulses per virtual axis revolution is not an integer value, a virtual axis revolution may not become a rotary table revolution.

8.4 Cam

Cam is used to make a machine connected to servomotor operate according to the preset cam pattern.

- (1) For axes at which the cam is set as the output module, the same operation as a cam is executed using a ball screw as shown in the example below.

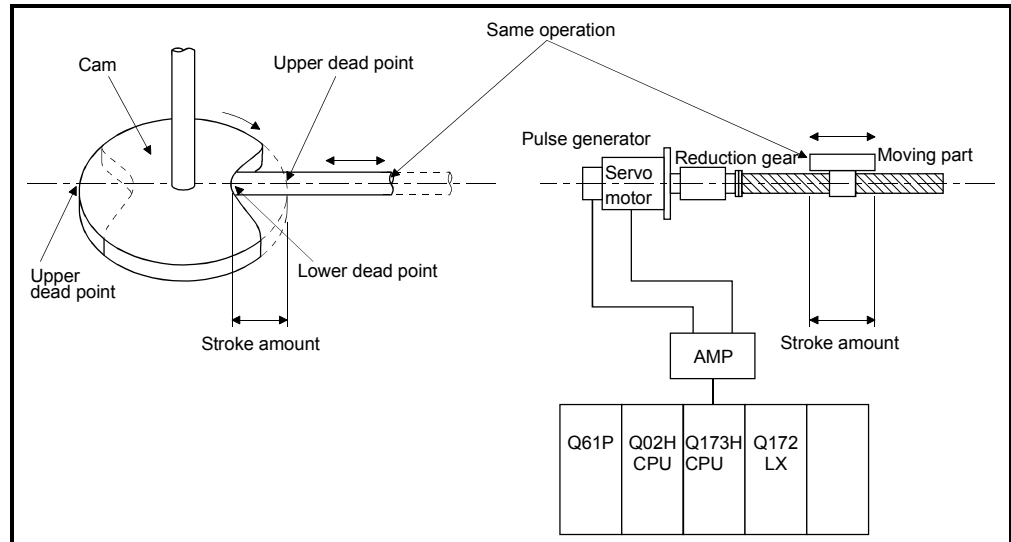

- (2) The following two types data required to use a cam.

- Settings item at cam data creation.

It is set at cam data (cam curve) creation by SW3RN-CAMP.

(Refer to Section 8.4.2)

- Cam parameters

These are the parameters used to set to cam in the output module at mechanical system program creation.

(Refer to Section 8.4.3)

8.4.1 Operation

This section describes the cam operation.

(1) Procedure for switching from the real to virtual mode

Set the devices by the following procedure using the Motion SFC program at the switching from real to virtual mode.

(a) Set the following details.

- Set the cam No. and stroke amount in the "cam No. setting device" and "stroke amount setting device" set in the each cam shaft parameters.
- Turn the cam reference position setting command (M3214+20n) on/off as required .

(Refer to Section 4.1.2 (4))

↓

(b) Execute from the real to virtual mode switching request.

(M2043: OFF → ON)

↓

(c) Start operation based on the cam pattern, stroke amount and cam reference setting command set in the each cam shaft.

(2) Processing at the switching from the real to virtual mode

The current value within 1 cam shaft revolution is indexed based on the cam reference position setting command (M3214+20n), feed current value, lower stroke limit value, stroke amount and cam No. (cam pattern) at the switching from real to virtual mode.

(3) Operation

A value calculated by the stroke ratio of cam data table based on the current value within 1 cam shaft revolution is output.

$$\boxed{[\text{Feed current value}] = [\text{Lower stroke limit value}] + [\text{Stroke amount}] \times [\text{Stroke ratio}]}$$

The current value within 1 cam shaft revolution is set by the travel value that the travel value of drive module multiplied by a gear ratio of transmission module. Number of pulses per stroke amount is controlled based on the travel value per pulse set in the fixed parameter in the real mode.

(4) Switching the stroke amount and cam No. during operation

(a) The cam stroke amount and execute cam No. can be changed using the Motion SFC program during cam operation.

(b) The stroke amount and cam No. are changed by the address set in the "stroke amount, cam No. change point" at the creating cam data.

When the "stroke amount, cam No. change point" is passed, the stroke amount/cam No. is changed based on the value of the stroke amount setting device and cam No. setting device set in the cam parameters.

< Example > Switching between cam No.1 and No.2, and switching timing between stroke amount l1 and l2 when the stroke amount/cam No. change point is set as "0".

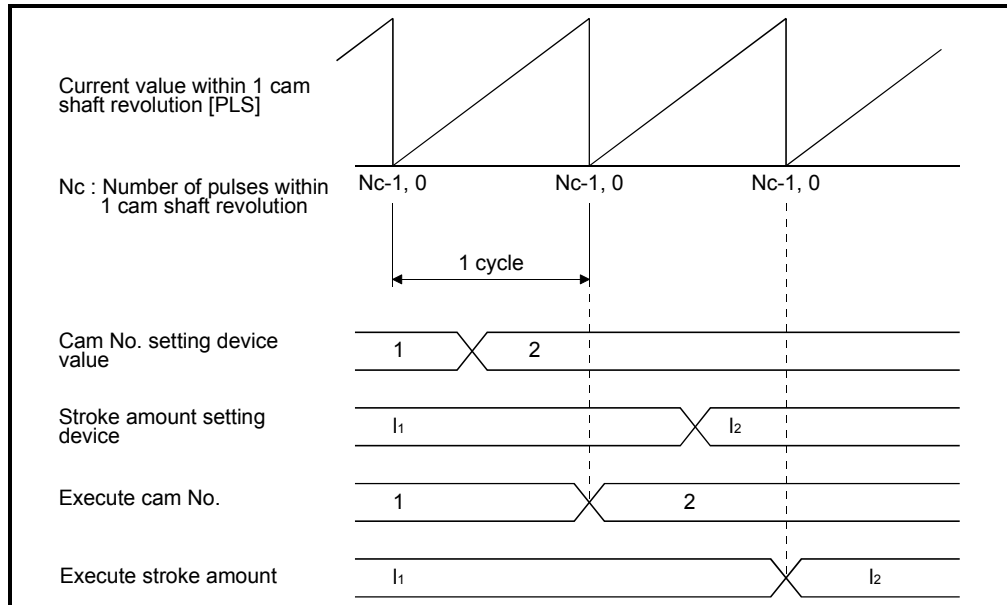

(c) Error causes at the changing stroke amount/cam No. during operation

- 1) The cam No. and stroke amount are always input at the switching from real to virtual mode and in the virtual mode.

A relative check is executed at the time of input. An error occurs in the following cases, the error detection signal (M2407+20n) turns on and the error code is stored in the minor error code storage register.

- The stroke amount is outside the range of 1 to 2147483647 ($2^{31}-1$).
"Lower stroke limit value + Stroke amount" \leq "2147483647 ($2^{31}-1$)" is not satisfied in the two-way cam mode.
- The control mode of cam No. is not same.

2) Processing for the cam No./stroke amount error

- If the error occurs at switching from the real to virtual mode, it does not switch to the virtual mode.
- If the error occurs at reaching the preset "stroke amount, cam No. change point" (during cam operation), operation continues without switching to the preset stroke amount/cam No.

Reset the error detection signal and minor error code storage register by the error reset command (M3207+20n).

3) Processing for the error

- a) If the error occurs at switching from the real to virtual mode, correct by the following procedure.
 - Turn the real/virtual mode switching request flag (M2043) off.
 - Correct the cam No. and stroke amount.
 - Turn the real/virtual mode switching request flag on, and switch to virtual mode.
- b) If the error occurs during cam operation, correct the cam No. and stroke amount.

(5) Control details

- (a) The cam feed current value is continued at switching from the real to virtual mode/from the virtual to real mode.
- (b) Backlash compensation processing is continued with the settings value of fixed parameters, even if switches the real/virtual mode.
- (c) Upper/lower stroke limit value and speed limit value are not checked.

(6) Control change

The current value within 1 cam shaft revolution can be changed to optional value for the cam as the control change during the virtual mode operation. Refer to the "Q173HCPU/Q172HCPU Motion controller (SV13/SV22) Programming Manual (Motion SFC)" for details of current value change.

Motion SFC program for which executes the current value change (CHGA-C) is shown below.

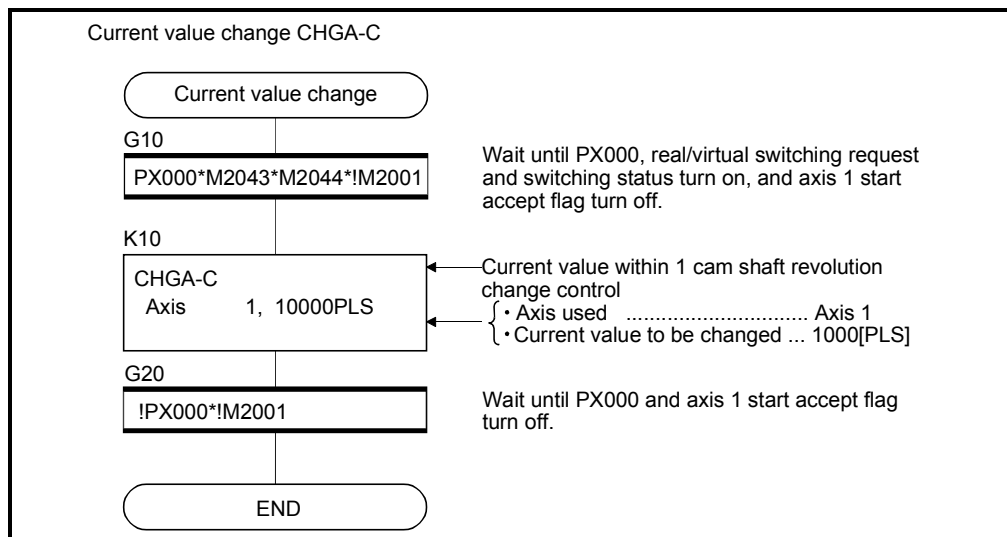

(Note) : Example of the above Motion SFC program is started using the automatic start or PLC program.

[Operation]

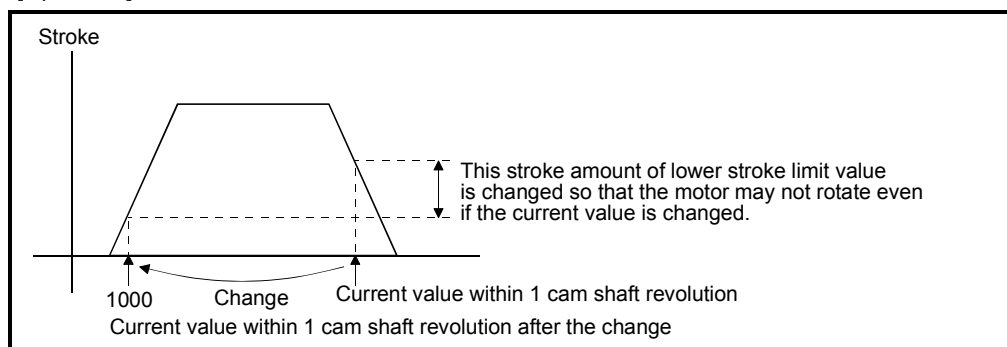

(7) Program example

[Switching from real to virtual mode]

Motion SFC program for switching from real to virtual mode is shown below.

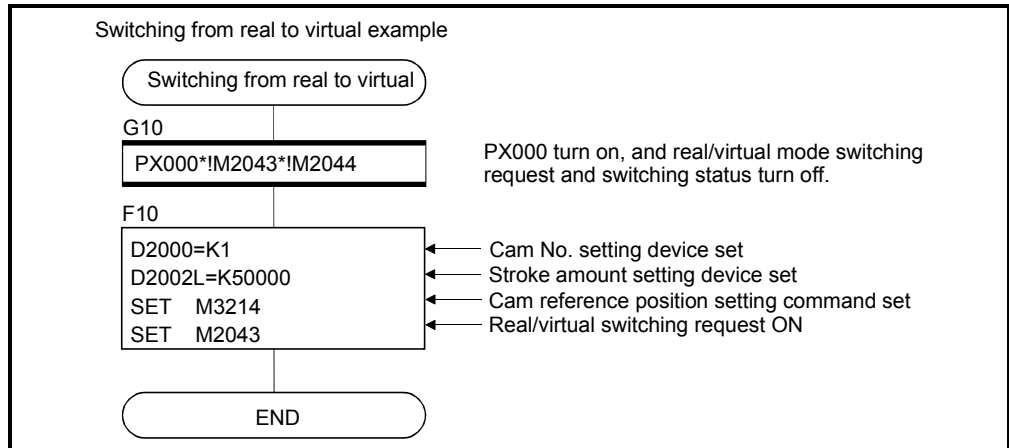

(Note) : Example of the above Motion SFC program is started using the automatic start or PLC program.

[Switching cam No./stroke amount during operation]

Motion SFC program for switching cam No. or stroke amount is shown below.

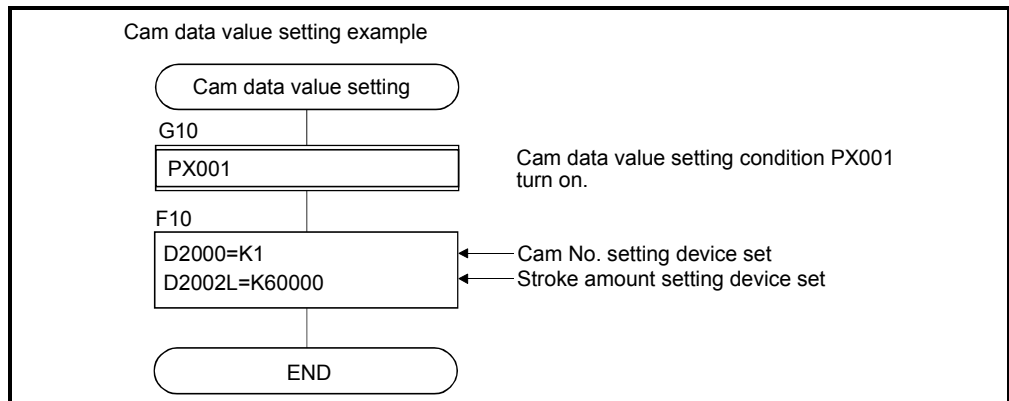

(Note) : Example of the above Motion SFC program is started using the automatic start or PLC program.

8.4.2 Settings items at cam data creating

This section describes the setting items at cam data creating using a peripheral device.

Table 8.4 Table of Settings Items at cam Data Creating

No.	Setting item	Default	Setting range
1	Cam No.	—	Refer to (1)
2	Resolution	256	256, 512, 1024, 2048
3	Stroke amount/ Cam No. change point	0	0 to (resolution-1)
4	Operation mode	Two-way cam mode	<ul style="list-style-type: none"> • Two-way cam mode • Feed cam mode
5	Cam data table	0	0 to 32767

(1) Cam No.

This device is used to set the No. (1 to 64) of created cam data.

A cam No. is used with the number which offset value attached by the machine name sequence registered on mechanical system editing screen in the mechanical system program.

Machine name sequence	Setting cam No.
1	1 to 64
2	101 to 164
3	201 to 264
4	301 to 364

(2) Resolution

(a) This device is used to set the number of index divisions in one cam cycle.

(b) The following conditions need to be satisfied in order to output the all point data of resolution correctly.

- Number of pulses per cam revolution (Nc) \geq Resolution
- Time required per cam revolution \geq Operation cycle \times Resolution

(3) Stroke amount/cam No. change point

(a) This device is used to set a position at which the stroke amount/cam No. is switched during operation.

(b) When the set switching position [range: 0 to (resolution - 1)] is reached, if the stroke amount/cam No. is normal, it is switched to the setting stroke amount and cam No.

(4) Operation mode

(a) This device is used to set the two-way cam mode/feed cam mode.

1) Two-way cam mode A two-way operation is repeated between the lower stroke limit value (lower dead point) and the range set in the stroke amount.

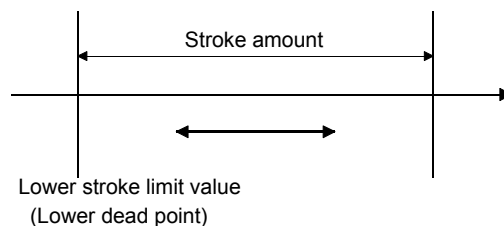

8 OUTPUT MODULE

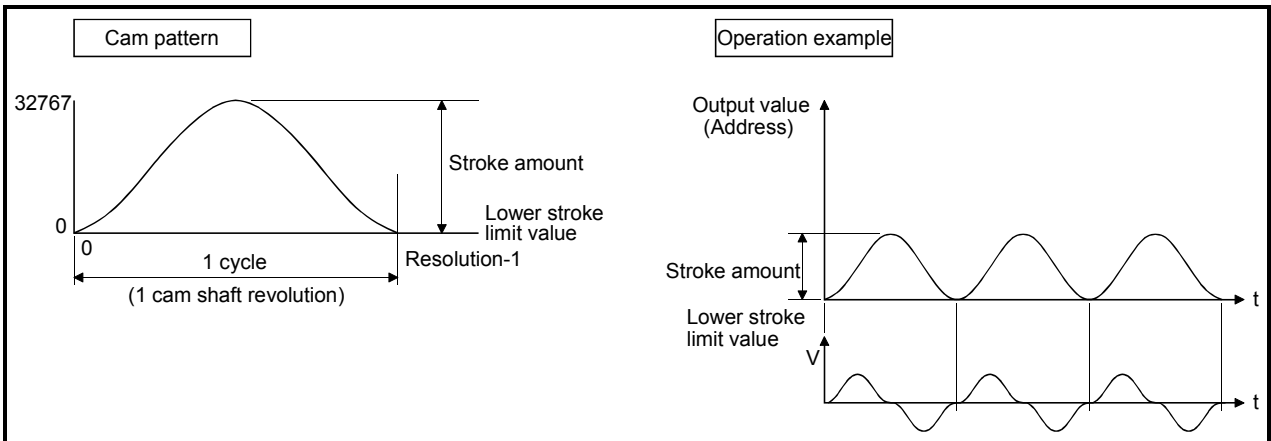

2) Feed cam modeWith the lower stroke limit value (lower dead point) as the operation start position, positioning is executed by feeding one stroke amount per cycle in a fixed direction.

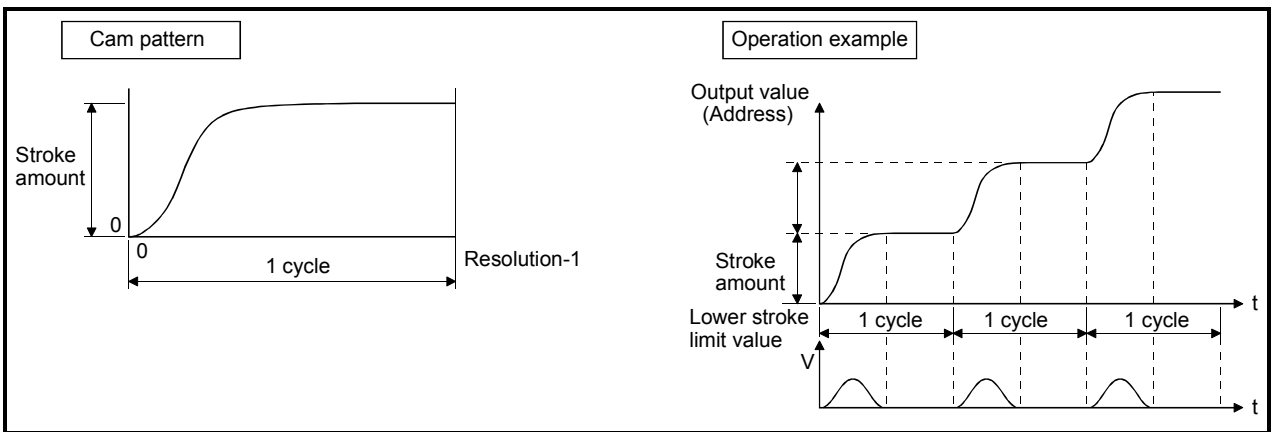
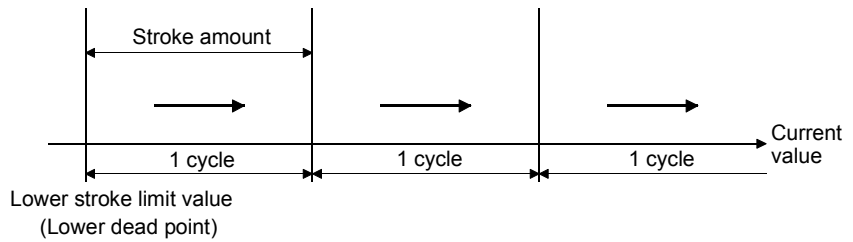

(5) Cam data table

(a) This device is used to set the each point stroke ratio (when the stroke amount is divided into 32767 divisions) in the set resolution.

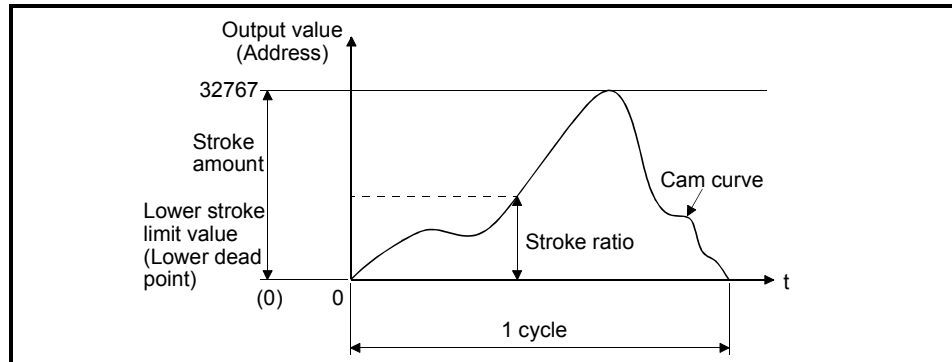

(b) The cam data table is automatically created by creating the cam curve using a peripheral device.
The cam curves which can be used in the Motion CPU are shown in Section 8.4.4.

8.4.3 Parameter list

The cam parameters are shown in Table 8.5 and the parameters No.2 to No.11 shown in this table are explained in items (1) to (10) below.
Refer to the help of SW6RN-GSV22P for the cam parameter setting method.

Table 8.5 Cam Parameter List

No.	Setting item	Default value	Setting range		
1	Output axis No.	0	Q173HCPU : 1 to 32 Q172HCPU : 1 to 8		
2	Number of pulses per cam shaft revolution (Nc)	0	1 to 1073741824 [PLS]		
3	Cam No. setting device (1 word)	—	Word device (D, W)		
4	Permissible droop pulse value	65535	1 to 65535 [× 100 PLS]		
5	Output unit	mm	mm	inch	PLS
6	Stroke amount setting device (2 words)	—	Word device (D, W)		
7	Torque limit value setting device (1 word)	—	-(300[%]) / word device (D, W)		
8	Comment	None	32 characters		
9	Lower stroke limit value storage device (2 words)	—	Word device (D, W)		
10	Current value within 1 virtual axis revolution storage device (Main shaft side, 2 words)	—	- / word device (D, W)		
11	Current value within 1 virtual axis revolution storage device (Auxiliary input axis side, 2 words)	—	- / word device (D, W)		

(1) Number of pulses per cam shaft revolution (Nc)

(a) The number of pulses required to rotate the cam one cycle is displayed.

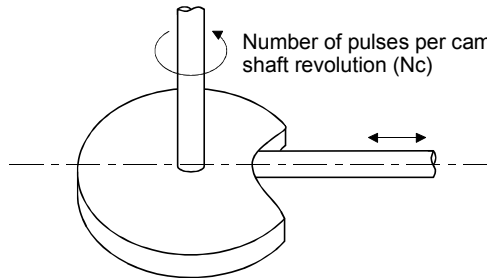

(b) The setting for the number of pulses per cam shaft revolution is not related to the travel value per pulse (fixed parameter setting).

(2) Cam No. setting device (1 word)

(a) This device is used to set the device that sets in the Motion SFC program by which the cam No. to control.

(b) The following devices can be set as the cam No. setting device.

Name	Setting range
Data register	D800 to D3069 ^(Note-1) D3080 to D8191
Link register	W0 to W1FFF

(Note-1) : D800 to D1559 are dedicated devices of virtual servomotor axis, synchronous encoder axis and output module "Cam" in the virtual mode. Unused areas of virtual servomotor axis and cam axis can be used as an user device.

(c) When the cam No. setting device value is changed during operation, it changes to the cam No. changed in the "stroke amount/cam No. switching position" set at the cam creating.

(3) Permissible droop pulse value

(a) This device is used to set the permissible droop pulse value of deviation counter.

(b) The deviation counter value is continually checked, and if it becomes larger than the permissible droop pulse value, the error detection signal (M2407+20n) turns on. However, since the cam shaft operation continues, execute the error processing by user side.

(4) Output unit

(a) This device is used to set the unit ([mm]/[inch]/[PLS]) of cam.

(b) Set the same unit as used in the real mode (unit in the fixed parameters) for the cam shaft.

(5) Stroke amount setting device (2 words)

(a) This device is used to set the cam stroke amount.

(b) The following devices can be set as the stroke amount setting device.

Name	Setting range ^(Note-1)
Data register	D800 to D3069 ^(Note-2)
	D3080 to D8191
Link register	W0 to W1FFF

(Note-1) : Set an even number at the first device.

(Note-2) : D800 to D1559 are dedicated devices of virtual servomotor axis, synchronous encoder axis and output module "Cam" in the virtual mode. Unused areas of virtual servomotor axis and cam axis can be used as a user device.

(c) Set the stroke amount within the following range.

- Setting range in the two-way cam mode
 [mm]: Lower stroke limit value + Stroke amount $\leq 2147483647 \times 10^{-1}$ [μm]
 [inch]: Lower stroke limit value + Stroke amount $\leq 2147483647 \times 10^{-5}$ [inch]
 [PLS]: Lower stroke limit value + Stroke amount ≤ 2147483647 [PLS]
- Setting range in the feed cam mode
 [mm]: $0 < \text{Stroke amount} \leq 2147483647 \times 10^{-1}$ [μm]
 [inch]: $0 < \text{Stroke amount} \leq 2147483647 \times 10^{-5}$ [inch]
 [PLS]: $0 < \text{Stroke amount} \leq 2147483647$ [PLS]

(6) Torque limit value setting device (1 word)

(a) This device is used to set the torque limit value for cam shaft.

When the device is set, the torque control is executed with the preset device value.

In the virtual mode, the torque limit setting is always valid.

If the device is not set, the torque limit is set at 300[%].

(b) The following devices can be set as the torque limit value setting device.

Name	Setting range
Data register	D800 to D3069 ^(Note-1)
	D3080 to D8191
Link register	W0 to W1FFF

(Note-1) : D800 to D1559 are dedicated devices of virtual servomotor axis, synchronous encoder axis and output module "Cam" in the virtual mode. Unused areas of virtual servomotor axis and cam axis can be used as an user device.

(c) The setting range for torque limit value is 1 to 1000[%].

(7) Comment

- (a) This device is used to create a comment such as purpose of cam shaft. Made comment can be displayed at monitoring using a peripheral device.
- (b) Comments up to 32 characters long can be created.

(8) Lower stroke limit value storage device (2 words)

- (a) This device is used to store the cam lower stroke limit value. The current lower stroke limit value is stored.
- (b) The following devices can be set as the lower stroke limit value storage device.

Name	Setting range ^(Note-1)
Data register	D800 to D3069 ^(Note-2) D3080 to D8191
Link register	W0 to W1FFF

(Note-1) : Set an even number at the first device.

(Note-2) : D800 to D1559 are dedicated devices of the virtual servomotor axis, synchronous encoder axis and output module "Cam" in the virtual mode. The unused areas of the virtual servomotor axis and cam axis can be used as a user device.

- (c) The lower stroke limit value is range of $-2147483648 (-2^{31})$ to $2147483647 (2^{31}-1)$.
 - 1) The lower stroke limit value is determined as follows for each unit setting:
 - [mm]: Lower stroke limit value $\times 10^{-1}$ [μm]
 - [inch]: Lower stroke limit value $\times 10^{-5}$ [inch]
 - [PLS]: Lower stroke limit value $\times 1$ [PLS]

(9) Current value within 1 virtual axis revolution storage device (Main shaft side) (2 words)

This parameter is set when the address mode clutch is set at the cam main shaft side.

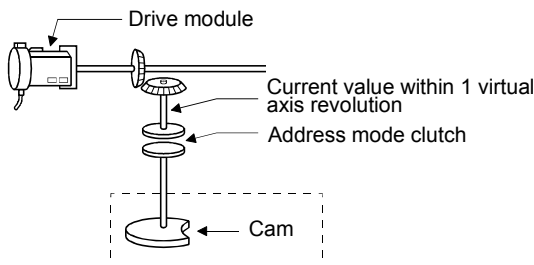

$$\text{Current value within 1 virtual axis revolution} = (\text{Drive module travel value} \times \text{gear}) \% N_c$$

(% : Remainder operator)

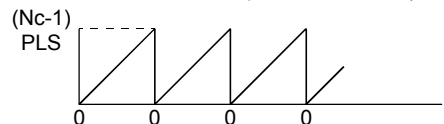

- (a) The current value within 1 virtual axis revolution of cam main shaft side is stored in the preset device.

- (b) The following devices can be set as the current value within 1 virtual axis revolution storage device.

Name	Setting range ^(Note-1)
Data register	D800 to D3069 ^(Note-2) D3080 to D8191
Link register	W0 to W1FFF

(Note-1) : Set an even number at the first device.

(Note-2) : D800 to D1559 are dedicated devices of virtual servomotor axis, synchronous encoder axis and output module "Cam" in the virtual mode. Unused areas of virtual servomotor axis and cam axis can be used as an user device.

- (c) The current value within 1 virtual axis revolution is the range of 0 to (Nc-1) [PLS].
(Nc: Number of pulses per cam shaft revolution)
- (d) The address mode clutch is turned on/off with the specified address of the current value within 1 virtual axis revolution range of 0 to (Nc-1) [PLS]. Therefore, set the address value within the range of 0 to (Nc-1) [PLS] in the clutch ON/OFF address setting device.
- (e) The current value within 1 virtual axis revolution reference position "0" is set by turning the address clutch reference setting command (M3213+20n) on and switching to the virtual mode.
The current values within 1 virtual axis revolution for both the main shaft and the auxiliary input axis is set to "0" at this time.
If the address clutch reference setting command (M3213+20n) is turned off and it switches to the virtual mode, control continues from the current value within 1 virtual axis revolution of last virtual mode.

(f) An example of an address mode clutch operation is shown below.

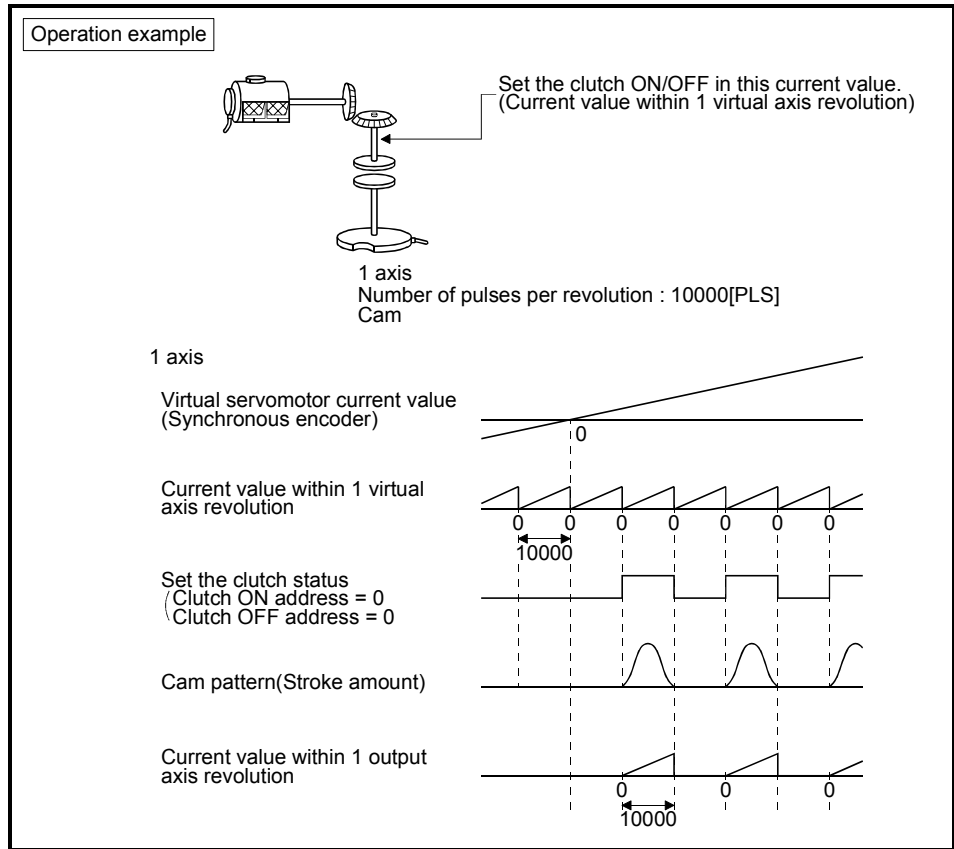

(10) Current value within 1 virtual axis revolution storage device (Auxiliary input axis side) (2 words)

This parameter is set when the address mode clutch is set at the cam auxiliary input axis side.

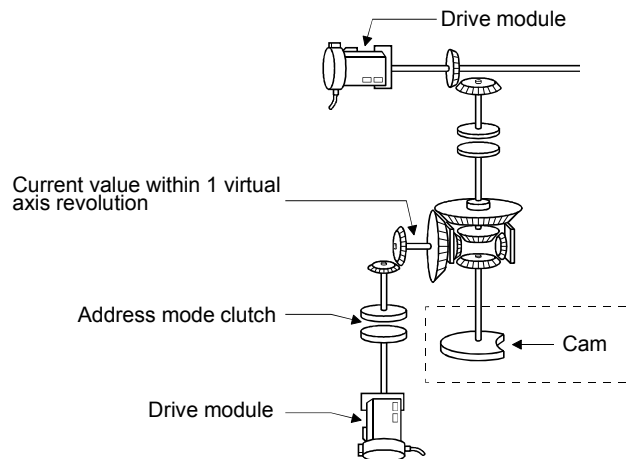

8 OUTPUT MODULE

- (a) By setting the current value within 1 virtual axis revolution of auxiliary input axis side, for the current value within 1 virtual axis revolution is stored in the preset device.

Current value within 1 virtual axis revolution of auxiliary input axis side	=	Drive module travel value of auxiliary input axis side	×	$\frac{\text{Gear ratio}}{\text{Number of pulses per cam revolution}}$
-----------------------------------------------------------------------------	---	--------------------------------------------------------	---	------------------------------------------------------------------------

(Note): Current value within 1 virtual axis revolution of auxiliary input axis side is updated regardless of clutch ON/OFF.

- (b) The following devices can be set as the current value within 1 virtual axis revolution storage device.

Name	Setting range ^(Note-1)
Data register	D800 to D3069 ^(Note-2) D3080 to D8191
Link register	W0 to W1FFF

(Note-1) : Set an even number at the first device.

(Note-2) : D800 to D1559 are dedicated devices of virtual servomotor axis, synchronous encoder axis and output module "Cam" in the virtual mode. Unused areas of virtual servomotor axis and cam axis can be used as an user device.

- (c) The current value within 1 virtual axis revolution is the range of 0 to (NC-1) [PLS].
- (d) The address mode clutch is turned on/off with the specified address of the current value within 1 virtual axis revolution range of 0 to (NC-1) [PLS]. Therefore, set the address value within the range of 0 to (NC-1) [PLS] in the clutch ON/OFF address setting device.
- (e) The current value within 1 virtual axis revolution reference position "0" is set by turning the address clutch reference setting command (M3213+20n) on and switching to the virtual mode. The current values within 1 virtual axis revolution for both the main shaft and the auxiliary input axis is set to "0" at this time. If the address clutch reference setting command (M3213+20n) is turned off and it switches to the virtual mode, control continues from the current value within 1 virtual axis revolution of last virtual mode.

(f) An example of an address mode clutch operation is shown below.

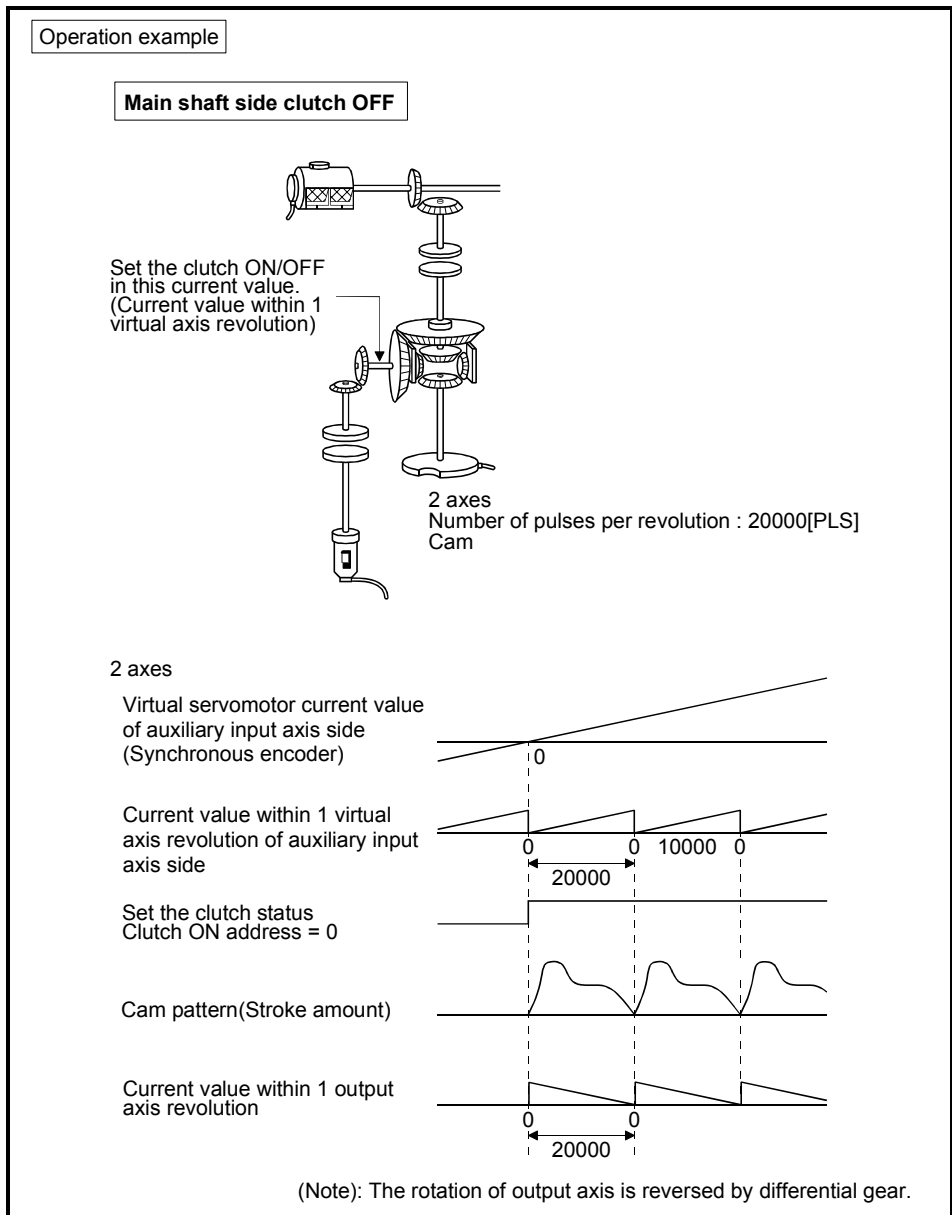











8.4.4 Cam curve list

This section describes the cam curves which can be used in the virtual mode.

(1) Cam curve characteristics comparison

The cam curve characteristics comparison is shown below.

Table 8.6 Cam Curve Characteristics Comparison Table

Class		Cam curve name	Acceleration curve shape	V _m	A _m	(A · V) _m	(V · V) _m	(S · V) _m	Remark
Discontinuity curves		Constant - speed		1.00			1.00	1.00	
		Constant-acceleration		2.00	± 4.00	± 8.00	4.00	1.09	
Two-dwelling curve	Symmetrical curves	5 th curve		1.88	± 5.77	± 6.69	3.52	1.19	
		Cycloid		2.00	± 6.28	± 8.16	4.00	1.26	
		Distorted trapezoid		2.00	± 4.89	± 8.09	4.00	1.20	Ta = 1 / 8
		Distorted sine		1.76	± 5.53	± 5.46	3.10	1.13	Ta = 1 / 8
		Distorted constant-speed		1.28	± 8.01	± 5.73	1.63	1.07	Ta = 1 / 16 Ta = 1 / 4
	Asymmetrical curves	Trapezoid		2.18	± 6.17	± 10.84	4.76	1.28	m = 1
		Reverse trapezoid		2.18	± 6.17	± 10.84	4.76	1.28	m = 1
One-dwelling curve		Double hypotenuse		2.04	+ 5.55 - 9.87	+ 7.75 - 9.89	4.16	1.39	
Non-dwelling curve		Single hypotenuse		1.57	± 4.93	± 3.88	2.47	1.02	

(2) Free-form curve

The spline interpolation function can be used to create free-form cam curves.

8.5 Phase Compensation Function

When carrying out a position follow-up control (synchronous operation) by synchronous encoder, delays in the progresses, etc. cause the phase to deviate at servomotor shaft end in respect to the synchronous encoder. The phase compensation function compensates in this case so that the phase does not deviate.

(1) Parameter list

Set the following devices for axes to execute the phase compensation function.
(Set in the output module parameter.)

Table 8.7 Phase Compensation Function Parameter List

No.	Item	Device setting range	Setting range
1	Phase advance time	D800 to D3068 ^(Note-1) D3080 to D8190 W0 to W1FFE (2 word data) (Note) Set an even number	-2147483648 to 2147483647[μs]
2	Phase compensation time constant	D800 to D3069 ^(Note-1) D3080 to D8191 W0 to W1FFF (1 word data)	0 to 32767[times]
3	Phase compensation processing valid flag	X0 to X1FFF Y0 to Y1FFF M0 to M8191 M9000 to M9255 F0 to F2047 B0 to B1FFF	—
4	Compensation amount monitor device	D800 to D3068 ^(Note-1) D3080 to D8190 W0 to W1FFE (2 word data) (Note) Set an even number	—

(Note-1) : D800 to D1559 are dedicated devices of virtual servomotor axis, synchronous encoder axis and output module "Cam" in the virtual mode.
Unused areas of virtual servomotor axis and cam axis can be used as an user device.

(a) Phase advance time

It is used to set whether a phase is advanced/delayed.
Phase advance time is calculated in the formula below.

$\text{Phase advance time} = \text{Delay time peculiar to system [s]} + 1/\text{PG1 [rad/s]}$ <div style="margin-left: 100px;"> $\left[\begin{array}{l} \text{Delay time peculiar to system [t] : Refer to Table 8.8} \\ \text{Model control gain} \end{array} \right]$ </div>

"Command speed[PLS/s] × Phase advance time[s]" is added to the servo command value as an amount of compensation.

Table 8.8 Delay time peculiar to system

Operation cycle [ms]	Incremental synchronous encoder use [μs]	Q170ENC use [μs]
0.88	2376	2611
1.77	4165	4388
3.55	7715	7943
7.11	18378	78608

(b) Phase compensation time constant

It is used to set to execute the turning off to on/on to off smoothly so that a servomotor does not make rapid acceleration/deceleration at phase compensation.

Set the number of operation cycles as setting unit.

<Example>

For operation cycle is 0.88[ms] and phase compensation time constant is 50[times].

The phase compensation time constant becomes "0.88 × 50 = 44[ms]"

Phase compensation time constant is input at the phase compensation processing valid flag ON.

(c) Phase compensation processing valid flag

It is used to set whether the phase compensation function is "Valid/Invalid".

- ON.....Phase compensation function "Valid"
- OFF.... Phase compensation function "Invalid"

(d) Compensation amount monitor

The compensation amount under compensating is stored to the preset register.

- Except cam axis...Compensation amount of servomotor shaft [PLS]
- Cam axis.....Compensation amount of current value within 1 virtual axis revolution

(2) Operating method

Operating method for phase compensation function is shown below.

(a) Set a phase advance time.

↓

(b) Set a suitable time constant as a phase compensation time constant.

↓

(c) Turn the phase compensation processing valid flag on for every axis before the servomotor start.

↓

(d) For cam axis, make a gain adjustment in the servo amplifier side to improve the flattery for cam pattern. In this case, advance to the phase of cam axis compared with axis of other roller or rotary table, etc.

Therefore, if the phase of cam axis is delayed in the phase advance time setting, a phase with the axis of a roller or rotation table, etc. can be set.

(3) Errors at phase compensation

- (a) When the phase compensation time constant is outside the setting range, a minor error [6300] will occur for applicable axis, a phase compensation is executed without soothing processing.

POINT
<p>(1) It must be reduced a phase compensation time constant to use for delay compensation of synchronous encoder.</p>
<p>(2) When driving 2 axes synchronizing with virtual servomotor, even if the position control gains 1 of each axis differ, a phase discrepancy is removed by the following setting.</p> <p><Example> For Axis 1: PG1= 50[rad/s] and Axis 2: PG1=100[rad/s], Phase advance time = $1/50 - 1/100$ = 0.01[s] (=10000[μs]) Therefore, -10000[μs] is set as a phase advance time of axis 2, a phase of axis 2 can be set with a phase of axis 1.</p>
<p>(3) For cam axis, if it switches from the virtual to real mode in compensation amount except "0", it switches to the real mode with a phase shifted to other axes for compensation amount of remainder. In this case, switch to the real mode after setting "0" as a compensation amount.</p>

9. REAL/VIRTUAL MODE SWITCHING AND STOP/RE-START

This section describes the check details and switching method for the real/virtual mode switching.

(1) Real/virtual mode switching

Real/virtual mode switching is executed by turning the real/virtual mode switching request flag (M2043) ON/OFF.

- Real mode Switching request to the real mode by turning the M2043 OFF.
- Virtual mode Switching request to the virtual mode by turning the M2043 ON.

(2) Real/virtual mode confirmation

The current control mode state (real or virtual) can be confirmed by turning the real/virtual mode switching status flag (M2044) ON/OFF.

- M2044 : OFF Real mode state
- M2044 : ON Virtual mode state

9.1 Switching from the Real to Virtual Mode

When the real to virtual mode switching is requested (M2043 OFF→ON), the following check is executed. (Confirm the check items in Table 9.1 to 9.3 for switching from real to virtual mode, and execute with all normal state.)

- Check to determine if switching to the virtual mode is possible.... Refer to Table 9.1
- Output module check Refer to Table 9.2
- Synchronous encoder axis check Refer to Table 9.3

9 REAL/VIRTUAL MODE SWITCHING AND STOP/RE-START

- (1) Check to determine if switching to the virtual mode is possible
- (a) The items in Table 9.1 are checked to determine if switching to the virtual mode is possible.
When all check items of Table 9.1 are normal, switching to the virtual mode is executed.
- (b) If an error of at least one item of Table 9.1, the real/virtual mode switching error detection flag (M2045) turns on, and the error code is stored in the real/virtual mode switching error information storage register (D9193 to D9195).
Refer to APPENDIX 2.8 for the error codes which are stored in the D9193 to D9195.

Table 9.1 Check Items List for Real to Virtual Mode Switching

Check sequence	Check item	Applicable output module					Normal condition	Abnormal condition
		Roller	Ball screw	Rotary table	Cam	Real mode axis		
1	• Are PLC ready flag (M2000) and PCPU READY complete flag (M9074) ON ?	○	○	○	○	○	ON	OFF
2	• Have all axes stopped ? (M2001 to M2032 : OFF)	○	○	○	○	○	YES	NO
3	• Has cam data using the Motion SFC program changed ?	○	○	○	○	○	NO	YES
4	• Has the mechanical system program been registered ?	○	○	○	○	○	YES	NO
	• Does the axis No. set in the system settings match the output axis set in the mechanical system program ?	○	○	○	○	○	YES	NO
5	• Is the all axes servo ON command (M2042) ON ?	○	○	○	○	○	ON	OFF
6	• Does not the servo start processing by the servo error reset executed at the servo amplifier (axis used) ?	○	○	○	○	○	Completion	During processing
7	• Is the external encoder normal ?	○	○	○	○	○	YES	NO
8	• Is the external forced stop inputted ?	○	○	○	○	○	NO	YES
9	• Are the all axes servo error detection signal (M2408+20n) ON ?	○	○	○	○	○	OFF	ON even if 1 axis
10	• Are the home position return request flag (M2409+20n) OFF ? (Excluding roller axis)	—	○	○	○	—	OFF	ON even if 1 axis
11	• Does the units set in the fixed parameters match that set in the output module ?	—	○	○	○	—	YES	NO
12	• Has the cam data been registered?	—	—	—	○	—	YES	NO
13	• Has the cam No. been set at the "cam No. setting device" set in the cam parameter ?	—	—	—	○	—	YES	NO
14	• Has the stroke amount (1 to 2147483647) been set at the "stroke amount setting device" set in the cam parameter ?	—	—	—	○	—	YES	NO
15	• Is the cam "stroke amount setting device" an even number ?	—	—	—	○	—	YES	NO

9 REAL/VIRTUAL MODE SWITCHING AND STOP/RE-START

(2) Output module check

- (a) The items in Table 9.2 below are checked to determine the output module state.

If an error is detected, it switches to the virtual mode, but the applicable system cannot be started. Correct the error cause in the real mode, and switch to virtual mode again.

- (b) When an error is detected, the error detection signal (M2407+20n) of applicable output module turns on, and the error code is stored in the minor/major error code storage register.

Table 9.2 Check Items List for Output Module

Check sequence	Check item	Applicable output module				Normal condition	Abnormal condition
		Roller	Ball screw	Rotary table	Cam		
1	• Is the feed current value within the stroke limit range ?	—	○	○	—	YES	NO
	• Is the feed current value within the range of "[lower stroke limit value] to [stroke amount]" ?	—	—	—	○		
2	• Does not "[lower stroke limit value] + [stroke amount]" exceed 2147483647 ($2^{31}-1$) in the two-way cam mode ?	—	—	—	○	YES	NO
3	• When the clutch connected to between the drive module and synchronous encoder is "external input mode", are the clutch ON/OFF device the same device ?	○	○	○	○	YES	NO
	• When the clutch connected to between the drive module and synchronous encoder is "external input mode", are the encoder I/F the manual pulse generator input ?	○	○	○	○	YES	NO (Serial encoder (ABS) input)
4	• Is the output module where either a "no clutch" or "clutch ON command" in effect for the virtual main shaft or the virtual auxiliary input axis the servo ready (M2415+20n : ON)?	○	○	○	○	ON	OFF
	• Is the external input signal "STOP" of output module where either a "no clutch" or "clutch ON command" in effect for the main shaft or the auxiliary input axis OFF ?	○	○	○	○	OFF	ON
5	• Can the current value within 1 cam revolution be calculated in the two-way cam mode ?	—	—	—	○	YES	NO
6	• Is the clutch ON/ OFF address setting device for address mode clutch an even number ?	○	○	○	○	YES	NO

(3) Synchronous encoder axis check

- (a) The items in Table 9.3 below are checked to determine the synchronous encoder state.

If an error is detected, it switches to the virtual mode, but the applicable system cannot be started. Correct the error cause in the real mode, and switch to virtual mode again.

- (b) When an error is detected, the error detection signal (M2407+20n) of the applicable output module turns on, and the error code is stored in the minor/major error code storage register.

Table 9.3 Check Items List for Synchronous Encoder Axis

Check sequence	Check item	Applicable synchronous encoder		Normal condition	Abnormal condition
		External synchronous encoder	Output module		
1	• Is the synchronous encoder connected to the Q172EX ?	○	—	Connected	Not connected Cable break

9.2 Switching from the Virtual to Real Mode

Switching from the virtual to real mode is executed by user side or operating system software.

- By user side Turn the real/virtual mode switching request flag (M2043) off.
- By operating system software Switch automatically at the servo error detection.

9.2.1 Switching from the virtual to real mode by user side

- (1) When the virtual to real mode switching is requested (M2043 ON → OFF), the item in Table 9.4 is checked. If normal, it switches to the real mode.
(Confirm the check items in Table 9.4 for the switching from virtual to real mode, and execute with all normal state.)
- (2) The real/virtual mode switching error detection flag (M2045) turns on at the error detection, and the error code is stored in the real/virtual mode switching error information (D9193 to D9195). (Refer to APPENDIX 2.8)

Table 9.4 Check Items List for VIRTUAL to REAL Mode Switching

Check sequence	Check item	Normal condition	Abnormal condition
1	• Are all axes (Virtual axis and real mode axis) stopped? (M2001 to M2032 : OFF)	OFF	ON even if 1 axis

9.2.2 Switching from the virtual to real mode by operating system software

- (1) If the following items are detected in the virtual mode operation, the operating system software automatically switches back to the real mode.
 - The forced stop is input.
 - PLC ready flag (M2000) turns off.
 - When "Return to Real Mode" is set as an operation on servo error, the servo error detection signal (M2408+20n) turns on even if 1 axis.
- (2) The error code is stored in the real/virtual mode switching error information (D9193 to D9195) at the switching back from virtual to real mode. However, the real/virtual mode switching error detection flag (M2045) does not turn on.

9.2.3 Continuous operation on servo error in virtual mode

- (1) Processing on servo error in virtual mode can be set by MT Developer (mechanical system editor screen). (Default: "Return to Real Mode")
 - Mechanical system editor screen

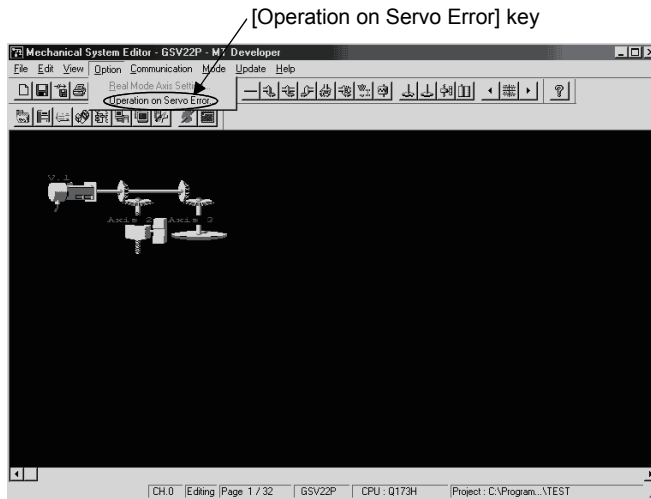

- Operation setting screen on servo error

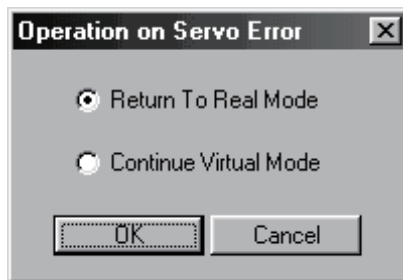

Operation conditions for continuous operation on servo error in virtual mode are shown below.

Operation mode	Details	Operation on servo error	Operation for other axes	Return condition to virtual mode
Return to Real Mode	Motion CPU switches to real mode.	Only axis on servo error is servo OFF, and servomotor coasts.	Rapid stop	After error release in real mode
Continue Virtual Mode	Virtual mode continues.		Normal operation continues	After error release in virtual mode

POINT

When "Continue Virtual Mode" is selected, be sure to use a clutch in the mechanical system program.
 In addition, the drive module connected to output axis on servo error is also continuing operation. Be sure to release a servo error after clutch OFF.

9.3 Precautions at Real/Virtual Mode Switching

This section describes the precautions at real/virtual mode switching.

- (1) The motion control step and the torque limit value change instruction/speed change instruction during mode switching processing execution impossible
 The motion control step and the torque limit value change instruction/speed change instruction during the from real to virtual mode/from virtual to real mode switching processing (part of timing chart (Note-1) cannot execute.
 The real/virtual mode switching request flag (M2043) and real/virtual mode switching status flag (M2044) should be used as an interlock.

[Timing Chart]

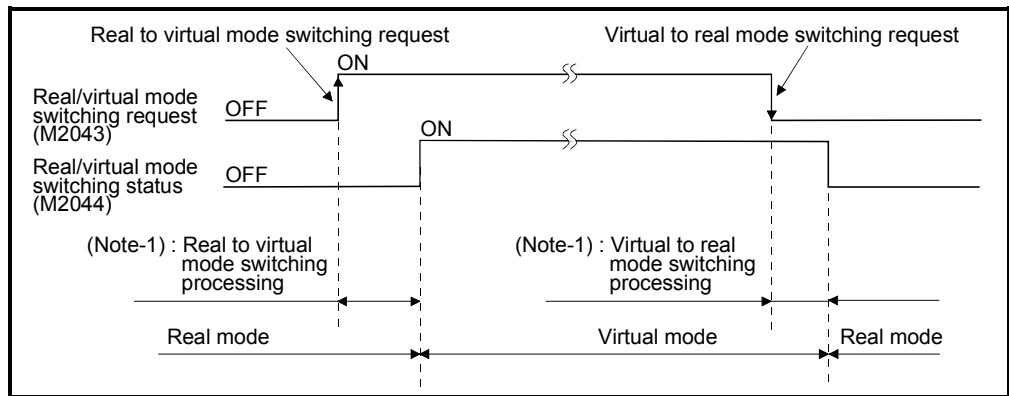

Motion SFC program for which executes the motion control step of real and virtual mode is shown below.

[Program Example]

- (a) Motion control step in the virtual mode
 Example of Motion SFC program is shown below.

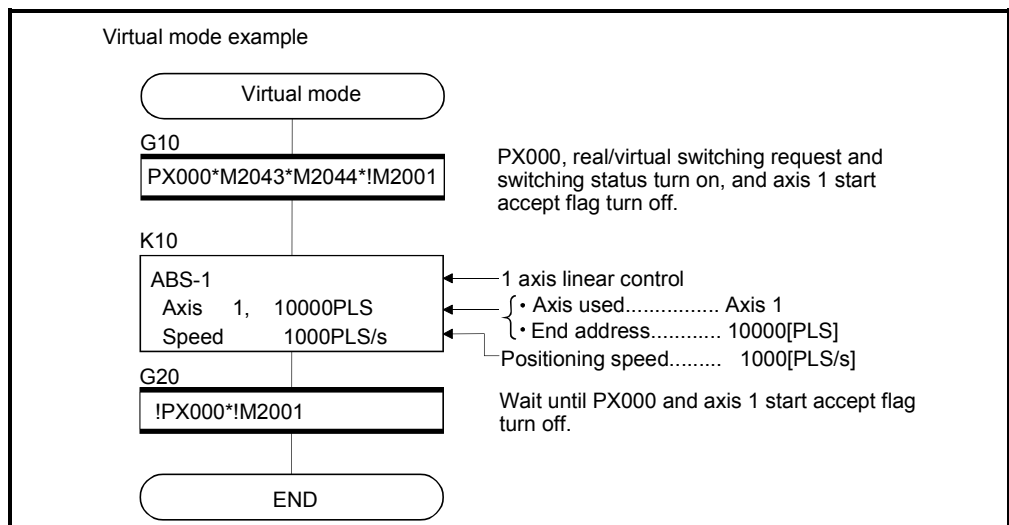

(Note) : Example of the above Motion SFC program is started using the automatic start or PLC program.

(b) Motion control step in the real mode

Example of Motion SFC program is shown below.

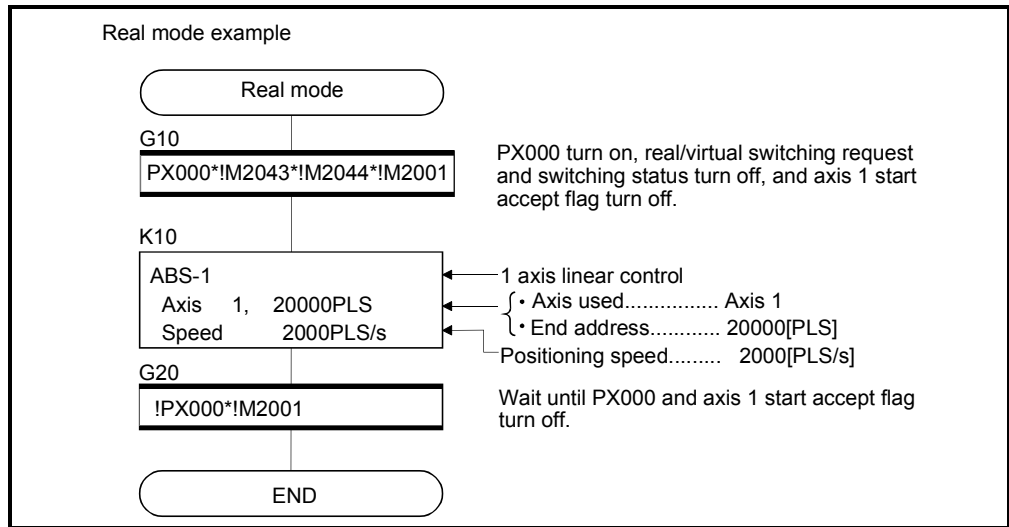

(Note) : Example of the above Motion SFC program is started using the automatic start or PLC program.

REMARK

Refer to the "Q173HCPU/Q172HCPU Motion controller (SV13/SV22) Programming Manual (REAL MODE)" for details.

- (2) M2043 processing during the TEST mode using a peripheral device
 M2043 ON/OFF (Real/virtual mode switching request) is ignored during the test mode using a peripheral device.

Real/virtual mode switching can be executed using a peripheral device, during TEST mode operation using a peripheral device.
 The real/virtual mode switching status flag (M2044) is turned off/on with the real/virtual mode.

REMARK

The same check as the "M2043 (OFF → ON/ON → OFF)" is also executed at the real/virtual mode switching using a peripheral device.

(Refer to Sections 9.1 and 9.2)

9.4 Stop and re-start

The basic method for stopping the system (output module) in the virtual mode operation is to stop the main shaft. If an auxiliary input axis is used, also stop the auxiliary input axis.

(1) Virtual axis stop

The stop operation or causes of virtual axis, the stop processing and re-start after stop are shown below. The following three methods for the virtual servomotor axis stop processing. This processing is also valid for interpolation axes during the interpolation operation.

- Deceleration stop Deceleration stop based on the "stop deceleration time" of parameter block.
- Rapid stop Deceleration stop based on the "rapid stop deceleration time" of parameter block.
- Immediate stop Immediate stop without deceleration.

Because the synchronous encoder axis becomes the input immediate stop, operation should be executed after the synchronous encoder axis has been stopped from the external input, except for abnormal stops such as the forced stop or a servo error occurrence, etc.

(Example : M2000 is OFF, All axes servo OFF command etc,..)

(The servo error occurs by the immediate stop of output module connected to the synchronous encoder axis, and the synchronization discrepancy may occurs.)

When the synchronization discrepancy occurs by the stop cause, the synchronization discrepancy warning (M2046) turns on. In this case, re-align the axes in the real mode, turn M2046 off, then continue the virtual mode operation.

The stop operation/stop causes during operation and re-starting operation after stop are shown in the next page.

9 REAL/VIRTUAL MODE SWITCHING AND STOP/RE-START

9.4.1 Stop operation/stop causes during operation and re-starting operation list

Table 9.5 Stop Operation/stop Causes during Operation and Re-starting Operation List

No.	Stop operation or stop causes during operation	Affected virtual axis			Stop processing		Return to Real mode by operating system software after all virtual axes stop completion	Synchronization discrepancy warning (M2046) set
		Virtual servomotor axis	Synchronous encoder axis	All axes batch	Virtual servomotor axis	Synchronous encoder axis		
1	Stop command ON	○ (Applicable axis)	—	—	Deceleration stop	—	—	—
2	Rapid stop command ON	○ (Applicable axis)	—	—	Rapid stop	—	—	—
3	All-axes servo OFF command (M2042 OFF, Command using a peripheral device in the TEST mode)	—	—	○	Deceleration stop	Immediate input stop	—	—
4	PLC ready flag (M2000) OFF	—	—	○	Deceleration stop	Immediate input stop	○	—
5	Motion CPU stop	—	—	○	Deceleration stop	Immediate input stop	○	—
6	All-axes rapid stop key input from a peripheral device	—	—	○	Rapid stop	Immediate input stop	—	—
7	Stop key input from peripheral device in the TEST mode	○ (All axes)	—	—	Deceleration stop	—	—	—
8	Forced stop input	—	—	○	Rapid stop	Immediate input stop	○	○
9	Servo error at output module even if 1 axis	—	—	○	Rapid stop	Immediate input stop	○	○
10	Motion CPU WDT error	—	—	○	Immediate stop	Immediate input stop	—	—
11	Motion CPU reset	—	—	○	Immediate stop	Immediate input stop	—	—
12	Motion CPU power OFF	—	—	○	Immediate stop	Immediate input stop	—	—
13	Other errors during virtual axis operation	○	—	—	Deceleration stop	—	—	—
14	Error detection at absolute synchronous encoder axis	—	○	—	—	Immediate input stop	—	—

9 REAL/VIRTUAL MODE SWITCHING AND STOP/RE-START

Error set	Output module operation	Operation continuation enabled (○)/ disabled (×)	Re-start operation after stop
—	• Deceleration stop based on the smoothing time constant.	○	• Continuous operation is possible by turning the stop command off (not necessary when on) and starting.
—	• Deceleration stop based on the smoothing time constant.	○	• Continuous operation is possible by turning the stop command off (not necessary when on) and starting.
—	• Servo OFF state after deceleration stop based on the smoothing time constant.	○	• Continuous operation is possible by turning the all clutch off → all axes servo on → clutch on. (However, when the servomotor does not operate during the servo OFF. Also, the clutch OFF/ON is switched as required by the user side.) • For synchronous encoder axes, switch to the real mode, then back to the virtual mode to resume inputs.
Minor error (200) set (virtual axis)	• Deceleration stop based on the smoothing time constant.	○	• Operation is possible by executing the real to virtual mode switching request (M2043 ON), after turning the PLC ready flag (M2000) on.
Minor error (200) set (virtual axis)	• Deceleration stop based on the smoothing time constant.	○	• Operation is possible by executing the real to virtual mode switching request (M2043 ON), after starting the Motion CPU.
—	• Deceleration stop based on the smoothing time constant.	○	• Continuous operation is possible by starting after stop. • For synchronous encoder axes, switch to the real mode, then back to the virtual mode to resume inputs.
—	• Deceleration stop based on the smoothing time constant.	○	• Continuous operation is possible by starting after stop.
—	• Servo OFF state after immediate stop.	×	• Continuous operation is not possible due to a synchronization discrepancy between the virtual axis and output module, and stop. • After release the forced stop, re-align the output module in the real mode, switch the synchronization discrepancy warning (M2046) OFF, then switch back to the virtual mode to resume operation.
Applicable output module (Servo error, Servo error code set)	• Servo OFF state after immediate stop for error axis only. • All other axes are synchronized with the virtual axis, and are then stopped.	×	• After executing a servo error reset in the real mode, re-align the axes, switch the synchronization discrepancy warning (M2046) OFF, then switch back to the virtual mode to resume operation.
M9073 (PCPU WDT error) ON	• Servo OFF state after immediate stop.	×	• Continuous operation is not possible due to a synchronization discrepancy between the virtual axis and output module, and stop. • After resetting the Motion CPU, re-align the output module, then switch to the virtual mode to resume operation.
—	• Servo OFF state after immediate stop.	×	• Continuous operation is not possible due to a synchronization discrepancy between the virtual axis and output module, and stop. • After resetting the Motion CPU, re-align the output module, then switch to the virtual mode to resume operation.
—	• Servo OFF state after immediate stop.	×	• Continuous operation is not possible due to a synchronization discrepancy between the virtual axis and output module, and stop. • After resetting the Motion CPU, re-align the output module, then switch to the virtual mode to resume operation.
Applicable error set	• Deceleration stop based on the smoothing time constant.	○	• Operation is possible by release the error cause.
Applicable error set	• Deceleration stop based on the smoothing time constant.	×	• Return to the real mode, re-align the axes, then switch to the virtual mode to resume operation.

10. AUXILIARY AND APPLIED FUNCTIONS

This section describes the auxiliary and applied functions for positioning control in the Multiple CPU system.

Items	Details	Applications
Mixed function of virtual mode with real mode	Positioning control for preset axis is executed during synchronous control/cam control in the mechanical system program.	It is used in the system for which conveys while executing synchronous control.
Cam/ball screw switching function	Cam axis operation is switched to ball screw operation in the mechanical system program.	When an error occurs during cam axis operation and it becomes outside the stroke range, it can be returned within the stroke range by switching from cam to ball screw.

10.1 Mixed Function of Virtual Mode with Real Mode

When the output axis No. to execute positioning control directly is selected in the mixed function of virtual mode with real mode, a positioning control of axis which is not used in the mechanical system program can be executed simultaneously during the mechanical system program.

(1) Program example

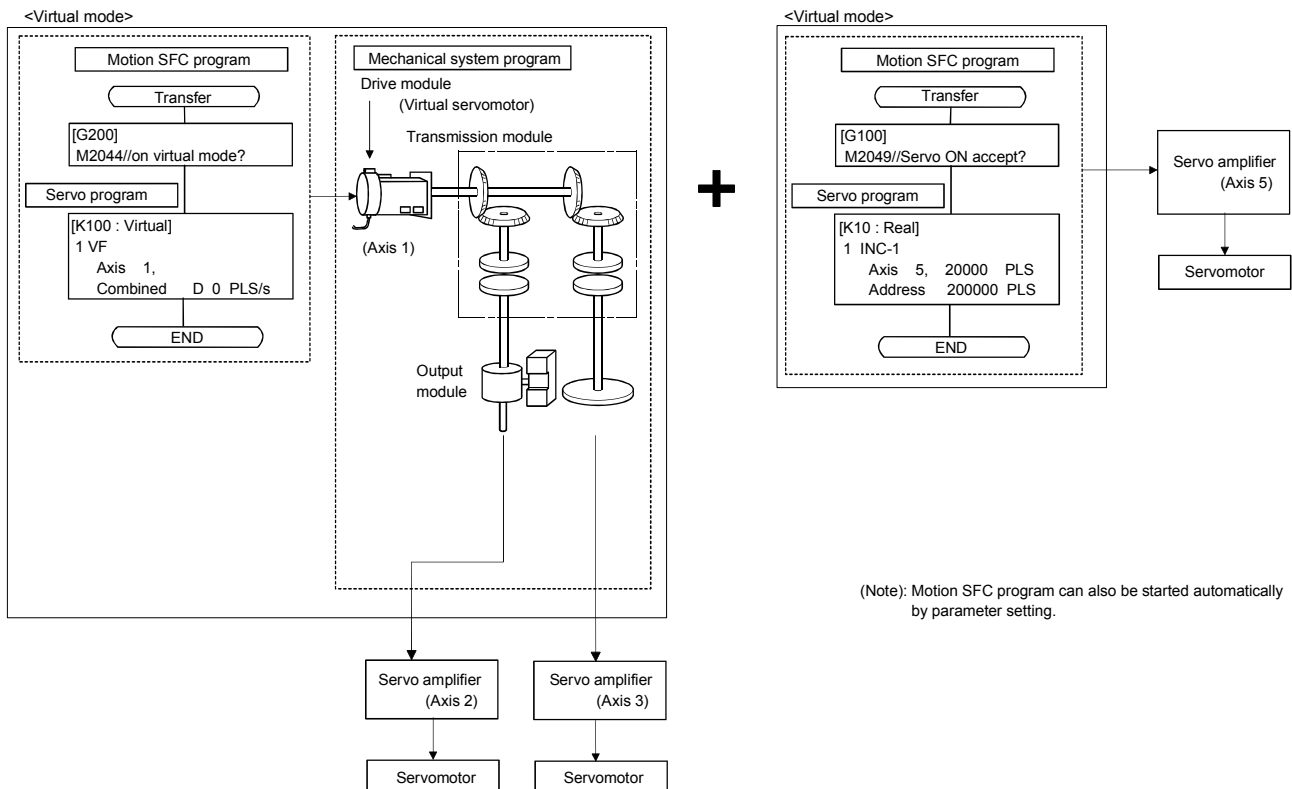

(2) Setting method

Set the axis to control as real mode axis in the [Option] – [Real Mode Axis Setting] key of mechanical system program editor screen in the SW6RN-GSV22P.

- Mechanical system editor screen

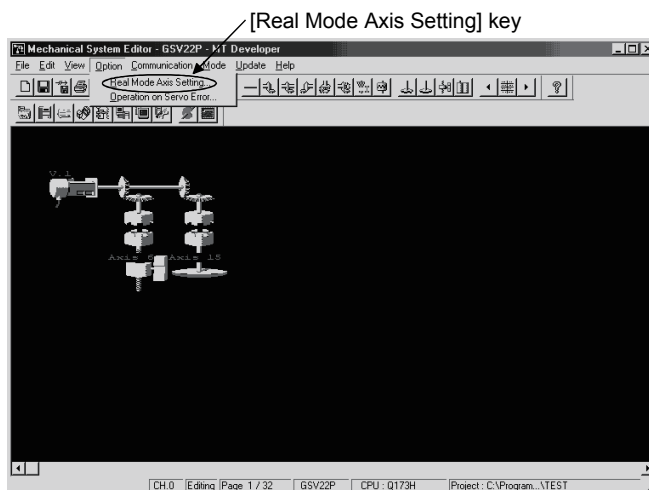

- Real mode axis setting screen

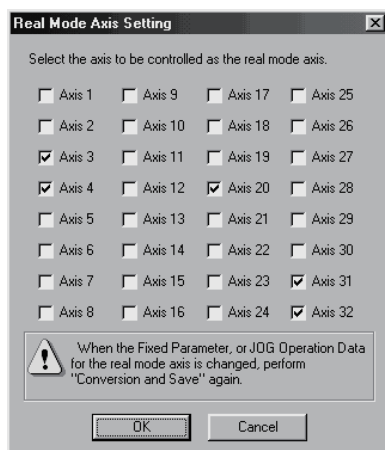

POINT

- (1) Execute "Conversion and Save" after setting "Real mode axis setting" in the mechanical system program editor.
- (2) Axis No. set in the "Real mode axis setting" cannot be set as virtual servomotor axis No.. And, the output No. set in the mechanical system program cannot be also set as real mode axis No..
- (3) When a fixed parameter of each axis is changed, be sure to execute "Conversion and Save" in also the mechanical system program editor screen.
- (4) Operation cycle over may occur for default operation cycle depending on the number of axes for real mode axis. In this case, change an operation cycle to a large value in the system setting.

(a) Usable instructions and controls

Items		Usable/unusable	Remarks	
Servo instructions	Linear positioning control	○	Positioning control with the torque limit value set in the servo program (parameter block)	
	Linear interpolation control			
	Circular interpolation control			
	Helical interpolation control			
	Fixed-pitch feed control			
	Speed control (I)			
	Speed control (II)			
	Speed-position switching control			
	Position follow-up control			
	Constant-speed control			
	Simultaneous start			
	Speed control with fixed position stop			
	Home position return (ZERO)			×
	High-speed oscillation (OSC)			×
JOG operation		○	Control with JOG operation data	
Manual pulse generator operation		×	Test mode disable (Virtual mode)	
Current value change (S(P).CHGA Jn ^(Note) , CHGA)		○		
Speed change (S(P).CHGV, CHGT)				
Torque limit value change (S(P).CHGT, CHGT)				

○ : Usable × : Unusable

(Note) : "n" shows the numerical value correspond to axis No..

(b) Control methods

Items	Control method	Remarks
Servo program start	<ul style="list-style-type: none"> • Use a Motion SFC program start or S(P).SVST instruction • Set a real mode axis No. as axis No.. 	<ul style="list-style-type: none"> • When the ZERO, OSC, CHGA-C or CHGA-E instruction is executed to real mode axis, "Servo program setting error" (error code: 905) occurs. • When the real mode axis is set to the virtual servo program and it starts, "Servo program setting error" (error code: 906) occurs. • When the real mode axis and virtual axis are set together to the interpolation axis if it starts, "Servo program setting error" (error code: 906) occurs.
Stop	<ul style="list-style-type: none"> • Turn the stop command (M3200+20n) or rapid stop command (M3201+20n) ON in real mode. • Turn the external signal (STOP) ON. • Use the deceleration stop or all axes rapid stop (Test mode ON) from the peripheral device. • Change speed to "0". 	Refer to the "Q173HCPU/Q172HCPU Motion controller (SV13/SV22) Programming Manual (REAL MODE)" for details of stop processing.
JOG operation	Use the forward rotation JOG start command (M3202+20n) or reverse rotation JOG start command (M3203+20n).	Control with parameter JOG operation data.
Current value change	<ul style="list-style-type: none"> • Use S(P).CHGA Jn^(Note), CHGA instruction. • Set a real mode axis No. as axis No.. 	<ul style="list-style-type: none"> • When the S(P).CHGA Cn^(Note) or CHGA En^(Note) instruction is executed, the instruction is ignored. • When the CHGA-C or CHGA-E instruction is executed to real mode axis, "Servo program setting error" (error code: 905) occurs.
Speed change	<ul style="list-style-type: none"> • Use S(P).CHGV, CHGV instruction. • Set a real mode axis No. as axis No.. 	
Torque limit value change	<ul style="list-style-type: none"> • Use S(P).CHGT, CHGT instruction. • Set a real mode axis No. as axis No.. 	Torque limit value of real mode axis at switching from real to virtual mode continues the state in real mode.

(Note) : "n" shows the numerical value correspond to axis No..

(c) Error codes in real mode axis

Error codes at positioning control in the mixed function of virtual mode with real mode are shown below.

1) Minor error (1 to 999)

2) Major error (1000 to 1299)

Minor error (4000 to 9990)/major error (10000 to 12990) code of output module in virtual mode are not set in minor/major error code storage register (D6+20n/D7+20n).

10 AUXILIARY AND APPLIED FUNCTIONS

(d) Difference for operation between the output axis of mechanical system program and real mode axis

Operation details for "output axis of mechanical system program" and "real mode axis" on error are shown below.

Items	Operation for output axis of mechanical system program	Operation for real mode axis
Feed current value exceeds the stroke limit range at switching from real mode to virtual mode.	<ul style="list-style-type: none"> • Minor error (error code: 5000) occurs. • Related system cannot be started. 	<ul style="list-style-type: none"> • Minor error (error code: 105) occurs at servo program start, and operation does not start.
Feed current value exceeds the stroke limit range during operation.	<ul style="list-style-type: none"> • Minor error (error code: 6030) occurs. • Operation continues. 	<ul style="list-style-type: none"> • Minor error (error code: 207) occurs, and deceleration stop is executed.
Output speed exceeds the speed limit value.	<ul style="list-style-type: none"> • Minor error (error code: 6010) occurs. • Speed clamp does not process by speed limit value. 	<ul style="list-style-type: none"> • Servo program setting error or minor error occurs. Speed is controlled by speed limit value.
Stop signal (STOP) is ON.	<ul style="list-style-type: none"> • Major error (error code: 11020) occurs. • Operation continues for axis without clutch. • Operation is controlled based on the operation mode on error for axis with clutch. 	<ul style="list-style-type: none"> • Major error (error code: 1000) occurs by turning the stop signal (STOP) on at start, and operation does not start. • Operation stops based on "deceleration processing at stop" of parameter block by turning the stop signal (STOP) on during operation.
External upper LS signal (FLS) turns off during travel to forward direction (address increase direction).	<ul style="list-style-type: none"> • Major error (error code: 11030) occurs. • Operation continues for axis without clutch. • Operation is controlled based on the operation mode on error for axis with clutch. 	<ul style="list-style-type: none"> • Major error (error code: 1001) occurs by turning the external upper LS signal (FLS) off at start to forward direction, and operation does not start. • Major error (error code: 1101) occurs by turning the external upper LS signal (FLS) off during start to forward direction, operation stops based on "deceleration processing at stop" of parameter block.
External lower LS signal (RLS) turns off during travel to reverse direction (address decrease direction).	<ul style="list-style-type: none"> • Major error (error code: 11040) occurs. • Operation continues for axis without clutch. • Operation is controlled based on the operation mode on error for axis with clutch. 	<ul style="list-style-type: none"> • Major error (error code: 1002) occurs by turning the external lower LS signal (RLS) off at start to reverse direction, and operation does not start. • Major error (error code: 1102) occurs by turning the external lower LS signal (RLS) off during start to reverse direction, operation stops based on "deceleration processing at stop" of parameter block.
Change the torque limit value.	Any time valid by setting the torque limit value storage register (D14+20n) of output axis and changing preset value.	<ul style="list-style-type: none"> • Torque limit value change instructions (S(P).CHGT, CHGT) are valid.

(e) Difference for operation between the real mode axis in virtual mode and real mode

When the servo OFF command (M3215+20n) turns on at using the mixed function of virtual mode with real mode in virtual mode, positioning control stops.

Items	Operation for real mode axis in virtual mode	Operation for axis in real mode
Servo OFF command (M3215+20n)	Any time valid at using real mode axis in virtual mode.	Invalid during positioning control.

(f) Cautions

- 1) Axis operation, current value, speed and torque limit value cannot be changed for all axes during mode switching.
- 2) When the feed current value of real mode axis is outside the stroke limit range at virtual mode switching, an error will occur at start of real mode axis. Use the JOG operation to reverse within the stroke limit range.
- 3) Switching from virtual mode to real mode cannot be executed during positioning control of real mode axis. Switch a mode after stop the real mode axis.

10.2 Cam/Ball Screw Switching Function

When a cam is set as output module in the mechanical system program, a cam executes the same operation as ball screw by turning the cam/ball screw switching command (M5488+n) on corresponding to each output axis No..

(1) Operation of output axis by cam/ball screw switching command

Items	Operation details
Cam/ball screw switching command (M5488+n) : OFF	Specified cam pattern operation
Cam/ball screw switching command (M5488+n) : ON	Same operation as ball screw <div style="border: 1px solid black; padding: 5px; margin: 5px 0;"> $\text{Command to servo amplifier} = \text{Preset command to servo amplifier} + \text{Drive module travel value[PLS]} \times \text{Gear ratio}$ </div> (Note): Feed current value is calculated based on the travel value per pulse set in the fixed parameter.

(2) Cautions at cam/ball screw switching

The current value within 1 cam shaft revolution is calculated based on the feed current value, lower stroke limit value, stroke amount and cam No. (cam pattern) by turning off the cam/ball screw switching command.

It is invalid to turn on the cam/ball screw switching command to axis that except cam axis.

If the cam/ball screw switching command (M5488+n) is turned off outside the range of "lower stroke limit value to stroke amount" for cam a minor error (error code: 5000)will occur.

(3) Cam operation re-start procedure on servo error

"Continue Virtual Mode" is set for operation on servo error, if the feed current value of output axis is outside the range of cam operation ("Lower stroke limit value to Stroke amount") by servo error for two-way cam, return the output axis to within cam operation range.

a) Remove servo error cause.

↓

b) Turn the cam/ball screw switching command (M5488+n) ON.

↓

c) Execute the servo error reset (M3208+20n).

↓

d) Return the output axis position within cam operation range to within stroke range by JOG operation, etc.

↓

e) Turn the cam/ball screw switching command (M5488+n) OFF.

↓

f) Re-start virtual mode.

APPENDICES

APPENDIX 1 Cam Curves

The cam acceleration curve formulas used in the virtual mode are shown below.

(1) Acceleration curve formula

<Symbol explanation>

- A : Dimensionless acceleration
- Am : Dimensionless maximum acceleration
- T : Dimensionless time
- Ta, Tb, Tc : T borderlines when section divisions are used

(a) Discontinuity curve

1) Constant-speed curve

$$A = C0$$

2) Constant-acceleration curve

- Section I ($0 \leq T \leq 0.5$)

$$A = 4 + C0$$

- Section II ($0.5 < T \leq 1$)

$$A = -4 + C0$$

(b) Two-dwelling symmetrical curve

1) 5th curve

$$A = 120T^3 - 180T^2 + 60T + C0$$

2) Cycloid curve

$$Am = 2\pi$$

$$A = 2\pi \sin^2 \pi T + C0$$

3) Distorted trapezoid curve

$$Ta = \frac{1}{8}$$

$$Am = \frac{1}{\frac{1}{4} - Ta + \frac{2}{\pi} Ta}$$

- Section I ($0 \leq T \leq Ta$)

$$A = Amsin \frac{\pi}{2Ta} T + C0$$

- Section II ($Ta < T \leq 0.5 - Ta$)

$$A = Am + C0$$

- Section III ($0.5 - Ta < T \leq 0.5 + Ta$)

$$A = Amcos \frac{\pi(T - 0.5 - Ta)}{2Ta} + C0$$

- Section IV ($0.5 + Ta < T \leq 1 - Ta$)

$$A = -Am + C0$$

- Section V ($1 - Ta < T \leq 1$)

$$A = -Amcos \frac{\pi(T - 1 - Ta)}{2Ta} + C0$$

4) Distorted sine curve

$$T_a = \frac{1}{8}$$

$$A_m = \frac{1}{\frac{2T_a}{\pi} + \frac{2 - 8T_a}{\pi^2}}$$

- Section I ($0 \leq T \leq T_a$)

$$A = A_m \sin \frac{\pi}{2T_a} T + C_0$$

- Section II ($T_a < T \leq 1 - T_a$)

$$A = A_m \cos \frac{\pi(T - T_a)}{1 - 2T_a} + C_0$$

- Section III ($1 - T_a < T \leq 1$)

$$A = -A_m \cos \frac{\pi(T - 1 + T_a)}{2T_a} + C_0$$

5) Distorted constant-speed curve

$$T_a = \frac{1}{16}$$

$$T_b = \frac{1}{4}$$

$$A_m = \frac{1}{\frac{2}{\pi} \left\{ \left(2 - \frac{8}{\pi} T_a T_b + \left(\frac{4}{\pi} - 2 \right) T_b^2 + T_b \right) \right\}}$$

- Section I ($0 \leq T \leq T_a$)

$$A = A_m \sin \frac{\pi}{2T_a} T + C_0$$

- Section II ($T_a < T \leq T_b$)

$$A = A_m \cos \frac{\pi(T - T_a)}{2(T_b - T_a)} + C_0$$

- Section III ($T_b < T \leq 1 - T_b$)

$$A = 0 + A_0$$

- Section IV ($1 - T_b < T \leq 1 - T_a$)

$$A = -A_m \sin \frac{\pi(T - 1 + T_a)}{2(T_b - T_a)} + C_0$$

- Section V ($1 - T_a < T \leq 1$)

$$A = -A_m \cos \frac{\pi(T - 1 + T_a)}{2T_a} + C_0$$

(c) Two-dwelling asymmetrical curve

1) Trapecloid curve

$$T_a = \frac{1}{8}$$

$$T_b = \frac{2 - 6T_a + \pi T_a}{2 + \pi}$$

$$T_c = \frac{2 - 2T_a + 3\pi T_a}{2 + \pi}$$

$$A_m = \frac{1}{\left(-\frac{3}{2} + \frac{4}{\pi} + \frac{4}{\pi^2}\right)T_a^2 + \left(1 + \frac{2}{\pi}\right)T_a T_b + \frac{1}{2}T_b^2 \left(\frac{2}{\pi} - \frac{4}{\pi^2}\right)(1 - T_c)^2}$$

• Section I ($0 \leq T \leq T_a$)

$$A = A_m \sin \frac{\pi}{2T_a} T + C_0$$

• Section II ($T_a < T \leq T_b$)

$$A = A_m + C_0$$

• Section III ($T_b < T \leq T_c$)

$$A = A_m \cos \frac{\pi(T - 6T)}{2T_a} + C_0$$

• Section IV ($T_c < T \leq 1$)

$$A = A_m \cos \frac{\pi(T - T_c)}{2(1 - T_c)} + C_0$$

2) Reverse trapezoid curve

$$T_a = \frac{1}{8}$$

$$T_b = \frac{2 - 6T_a + \pi T_a}{2 + \pi}$$

$$T_c = \frac{2 - 2T_a + 3\pi T_a}{2 + \pi}$$

$$A_m = \frac{1}{\left(-\frac{3}{2} + \frac{4}{\pi} + \frac{4}{\pi^2}\right)T_a^2 + \left(1 + \frac{2}{\pi}\right)T_a T_b + \frac{1}{2}T_b^2 \left(\frac{2}{\pi} - \frac{4}{\pi^2}\right)(1 - T_c)^2}$$

$$V_a = \frac{2T_a A_m}{\pi}$$

$$V_b = A_m (T_b - T_a) + V_a$$

$$S_a = \frac{2T_a^2 A_m}{\pi} - \frac{4T_a^2}{\pi^2}$$

$$S_b = \frac{A_m}{2} (T_b - T_a)^2 + V_a (T_b - T_a) + S_a$$

$$S_c = \frac{8T_a^2 A_m}{\pi^2} + 2V_b T_a + S_b$$

- Section I ($0 \leq T \leq 1 - T_c$)

$$A = A_m \cos \frac{\pi (1 - T_c - T)}{2 (1 - T_c)} + C_0$$

- Section II ($1 - T_c < T \leq 1 - T_b$)

$$A = - A_m \cos \frac{\pi (1 - T_b - T)}{2 T_a} + C_0$$

- Section III ($1 - T_b < T \leq 1 - T_a$)

$$A = - A_m + C_0$$

- Section IV ($1 - T_a < T \leq 1$)

$$A = A_m \sin \frac{\pi (1 - T)}{2 T_a} + C_0$$

- (d) One-dwelling curve

- 1) Double hypotenuse curve

$$A = \frac{\pi^2}{2} (\cos \pi T - \cos 2 \pi T) + C_0$$

- (e) Non-dwelling curve

- 1) Single hypotenuse curve

$$A = \frac{\pi^2}{2} \cos \pi T + C_0$$

(2) Cam curve coefficient

- (a) Distorted trapezoid

- Section I

$$0 < \text{Section I} < 0.25 (1/4)$$

Default Value : 0.125 (1/8)

- (b) Distorted sine

- Section I

$$0 < \text{Section I} < 0.5 (1/2)$$

Default Value : 0.125 (1/8)

- (c) Distorted constant-speed (Section I < Section II)

- Section I

$$0 < \text{Section I} < 0.125 (1/4)$$

Default Value : 0.0625 (1/16)

- Section II

$$0 < \text{Section II} < 0.5 (1/2)$$

Default Value : 0.25 (1/4)

- (d) Trapezoid

- Section I

$$0 < \text{Section I} < 0.25 (1/4)$$

Default Value : 0.125 (1/8)

- (e) Reverse trapezoid

- Section I

$$0 < \text{Section I} < 0.25 (1/4)$$

Default Value : 0.125 (1/8)

APPENDIX 2 Error Codes Stored Using The Motion CPU

The following errors are detected in the Motion CPU.

- Servo program setting error
- Positioning error
- Control mode switching error
- Motion SFC error ^(Note-1)
- Motion SFC parameter error ^(Note-1)
- Multiple CPU related error ^(Note-2)

(Note-1): Refer to the "Q173HCPU/Q172HCPU Motion controller (SV13/SV22) Programming Manual (Motion SFC)" for details.

(Note-2): Refer to the "Q173HCPU/Q172HCPU Motion controller Programming Manual (COMMON)" for details.

(1) Servo program setting errors

These are positioning data errors set in the servo program, and it checks at the start of the each servo program.

They are errors that occur when the positioning data is set indirectly.

The operations at the error occurrence are shown below.

- The servo program setting error flag (M9079) turns on.
- The erroneous servo program is stored in the error program No. storage register (D9189).
- The error code is stored in the error item information register (D9190).

(2) Positioning error

(a) Positioning errors occurs at the positioning start or during positioning control. There are minor errors, major errors and servo errors.

1) Minor errors..... These errors occur in the Motion SFC program or servo program, and the error codes (drive module : 1 to 999, output module : 4000 to 9990) are used.

Check the error code, and remove the error cause by correcting the Motion SFC program or servo program.

2) Major errors..... These errors occur in the external input signals or control commands from the Motion SFC program, and the error codes (drive module : 1 to 1999, output module : 10000 to 11990) are used.

Check the error code, and remove the error cause of the external input signal state or Motion SFC program.

3) Servo errorsThese errors detected in the servo amplifier or servo amplifier power supply, and the error codes 2000 to 2999 are used.

Check the error code, and remove the error cause of the servo amplifier side.

APPENDICES

The error applicable range for each error class are shown below.

Error class	Erroneous category	Error module	
		Drive module	Output module
Minor error	Setting data	1 to 99	4000 to 4990
	At start	100 to 199	5000 to 5990
	During operation	200 to 299	6000 to 6990
	At control change	300 to 399	—
Major error	At start	1000 to 1099	10000 to 10990
	During operation	1100 to 1199	11000 to 11990
	System	—	15000 to 15990
Servo error	Servo amplifier	—	2000 to 2799 (2100 to 2499 : warning)
	Servo amplifier power supply module		2800 to 2999 (2900 or later : warning)

(b) The error detection signal of the erroneous axis turns on at the error occurrence, and the error codes are stored in the minor error code, major error code or servo error code storage register.

Device		Error code storage register											
		Axis 1	Axis 2	Axis 3	Axis 4	Axis 5	Axis 6	Axis 7	Axis 8	Axis 9	Axis10	Axis11	Axis12
Virtual servomotor	Minor error code	D802	D812	D822	D832	D842	D852	D862	D872	D882	D892	D902	D912
	Major error code	D803	D813	D823	D833	D843	D853	D863	D873	D883	D893	D903	D913
Synchronous encoder	Minor error code	D1122	D1132	D1142	D1152	D1162	D1172	D1182	D1192	D1202	D1212	D1222	D1232
	Major error code	D1123	D1133	D1143	D1153	D1163	D1173	D1183	D1193	D1203	D1213	D1223	D1233
Output module	Minor error code	D6	D26	D46	D66	D86	D106	D126	D146	D166	D186	D206	D226
	Major error code	D7	D27	D47	D67	D87	D107	D127	D147	D167	D187	D207	D227
	Servo error code	D8	D28	D48	D68	D88	D108	D128	D148	D168	D188	D208	D228

Device		Error code storage register											
		Axis13	Axis14	Axis15	Axis16	Axis17	Axis18	Axis19	Axis20	Axis21	Axis22	Axis23	Axis24
Virtual servomotor	Minor error code	D922	D932	D942	D952	D962	D972	D982	D992	D1002	D1012	D1022	D1032
	Major error code	D923	D933	D943	D953	D963	D973	D983	D993	D1003	D1013	D1023	D1033
Synchronous encoder	Minor error code												
	Major error code												
Output module	Minor error code	D246	D266	D286	D306	D326	D346	D366	D386	D406	D426	D446	D466
	Major error code	D247	D267	D287	D307	D327	D347	D367	D387	D407	D427	D447	D467
	Servo error code	D248	D268	D288	D308	D328	D348	D368	D388	D408	D428	D448	D468

Device		Error code storage register							Error detection signal	Error reset command	
		Axis25	Axis26	Axis27	Axis28	Axis29	Axis30	Axis31			Axis32
Virtual servomotor	Minor error code	D1042	D1052	D1062	D1072	D1082	D1092	D1102	D1112	M4007+20n	M4807+20n
	Major error code	D1043	D1053	D1063	D1073	D1083	D1093	D1103	D1113		
Synchronous encoder	Minor error code								M4640+4n	M5440+4n	
	Major error code										
Output module	Minor error code	D486	D506	D526	D546	D566	D586	D606	D626	M2407+20n	M3207+20n
	Major error code	D487	D507	D527	D547	D567	D587	D607	D627		
	Servo error code	D488	D508	D528	D548	D568	D588	D608	D628		

APPENDICES

- (c) If another error occurs after an error code has been stored, the existing error code is overwritten, deleting it.
However, the error history can be checked using a peripheral device started with the SW6RN-GSV22P.
- (d) Error detection signals and error codes are held until the error reset command (M3207+20n) or servo error reset command (M3208+20n) turns on.

POINT
(1) Even if the servo error reset (M3208+20n) turns on at the servo error occurrence, the same error code might be stored again.
(2) Reset the servo error after removing the error cause of the servo amplifier side at the servo error occurrence.

(3) Error at the real/virtual mode switching

These errors are checked when the real/virtual mode switching request flag (M2043) turns off to on/on to off.

When the check shown in Section 9.1 and 9.2 is executed, and if error is detected, it is as follows.

- It remains the current mode without the real/virtual mode switching.
- The real/virtual mode switching error detection flag (M2045) turns on.
- The error codes are stored in the real/virtual mode switching error information (D9193 to D9195).

POINT																																																																								
<ul style="list-style-type: none"> • The axis error code among the error codes stored in the D9193 to D9195 is shown below. 																																																																								
<table border="1" style="width: 100%; border-collapse: collapse;"> <tr> <td style="width: 10%;"></td> <td style="width: 10%; text-align: center;">b15</td> <td colspan="14" style="text-align: center;">Error</td> <td style="width: 10%; text-align: center;">b0</td> </tr> <tr> <td>D9193</td> <td></td> <td colspan="14"></td> <td></td> </tr> <tr> <td>D9194</td> <td></td> <td>Axis 16</td><td>Axis 15</td><td>Axis 14</td><td>Axis 13</td><td>Axis 12</td><td>Axis 11</td><td>Axis 10</td><td>Axis 9</td><td>Axis 8</td><td>Axis 7</td><td>Axis 6</td><td>Axis 5</td><td>Axis 4</td><td>Axis 3</td><td>Axis 2</td><td>Axis 1</td> <td></td> </tr> <tr> <td>D9195</td> <td></td> <td>Axis 32</td><td>Axis 31</td><td>Axis 30</td><td>Axis 29</td><td>Axis 28</td><td>Axis 27</td><td>Axis 26</td><td>Axis 25</td><td>Axis 24</td><td>Axis 23</td><td>Axis 22</td><td>Axis 21</td><td>Axis 20</td><td>Axis 19</td><td>Axis 18</td><td>Axis 17</td> <td></td> </tr> </table>		b15	Error														b0	D9193																	D9194		Axis 16	Axis 15	Axis 14	Axis 13	Axis 12	Axis 11	Axis 10	Axis 9	Axis 8	Axis 7	Axis 6	Axis 5	Axis 4	Axis 3	Axis 2	Axis 1		D9195		Axis 32	Axis 31	Axis 30	Axis 29	Axis 28	Axis 27	Axis 26	Axis 25	Axis 24	Axis 23	Axis 22	Axis 21	Axis 20	Axis 19	Axis 18	Axis 17	
	b15	Error														b0																																																								
D9193																																																																								
D9194		Axis 16	Axis 15	Axis 14	Axis 13	Axis 12	Axis 11	Axis 10	Axis 9	Axis 8	Axis 7	Axis 6	Axis 5	Axis 4	Axis 3	Axis 2	Axis 1																																																							
D9195		Axis 32	Axis 31	Axis 30	Axis 29	Axis 28	Axis 27	Axis 26	Axis 25	Axis 24	Axis 23	Axis 22	Axis 21	Axis 20	Axis 19	Axis 18	Axis 17																																																							
		<div style="border-top: 1px solid black; width: 100%; height: 5px;"></div> <div style="text-align: right; margin-top: -5px;"> → Erroneous axis bit "1" </div>																																																																						
		<p style="font-size: 10px; margin: 0;"> <Example> For 8 axes error (Decimal) "128" and (Hexadecimal) "0080H" is stored in the D9194, (Decimal) "0" and (Hexadecimal) "0000H" is stored in the D9195, and the error code is stored in the D9193. </p>																																																																						

APPENDICES

APPENDIX 2.1 Expression Method for Word Data Axis No.

The axis No. may be expressed to correspond to each bit of word data for the positioning dedicated signal.

Example of the TEST mode request error information (D9182 to D9183) is shown below.

	b15	b14	b13	b12	b11	b10	b9	b8	b7	b6	b5	b4	b3	b2	b1	b0
D9182	Axis 16	Axis 15	Axis 14	Axis 13	Axis 12	Axis 11	Axis 10	Axis 9	Axis 8	Axis 7	Axis 6	Axis 5	Axis 4	Axis 3	Axis 2	Axis 1
D9183	Axis 32	Axis 31	Axis 30	Axis 29	Axis 28	Axis 27	Axis 26	Axis 25	Axis 24	Axis 23	Axis 22	Axis 21	Axis 20	Axis 19	Axis 18	Axis 17

→ Stores the during operation/stop data of each axis
 • 0 : During stop
 • 1 : During operation

(Note) : The range of axis No.1 to 8 is valid in the Q172HCPU.

(1) Axis 8 : Test mode request error

The controlling signal "1" is stored in D9182 "b7 (axis 8)".

	b15	b14	b13	b12	b11	b10	b9	b8	b7	b6	b5	b4	b3	b2	b1	b0	Decimal	Hexadecimal	
D9182	0	0	0	0	0	0	0	0	1	0	0	0	0	0	0	0	D9182	128	0080H
D9183	0	0	0	0	0	0	0	0	0	0	0	0	0	0	0	0	D9183	0	0000H

(2) Axis 12, 20 : Test mode request error

The controlling signal "1" is stored in D9182 "b11 (axis 12)" and D9183 "b3 (axis 20)".

	b15	b14	b13	b12	b11	b10	b9	b8	b7	b6	b5	b4	b3	b2	b1	b0	Decimal	Hexadecimal	
D9182	0	0	0	0	1	0	0	0	0	0	0	0	0	0	0	0	D9182	2048	0800H
D9183	0	0	0	0	0	0	0	0	0	0	0	1	0	0	0	0	D9183	8	0008H

(3) Axis 4, 10 : Test mode request error

The controlling signal "1" is stored in D9182 "b3 (axis 4)" and D9182 "b9 (axis 10)".

	b15	b14	b13	b12	b11	b10	b9	b8	b7	b6	b5	b4	b3	b2	b1	b0	Decimal	Hexadecimal	
D9182	0	0	0	0	0	0	1	0	0	0	0	0	1	0	0	0	D9182	520	0208H
D9183	0	0	0	0	0	0	0	0	0	0	0	0	0	0	0	0	D9183	0	0000H

APPENDICES

APPENDIX 2.2 Related Systems and Error Processing

There are following 2 types for the related systems of virtual mode.

- System consisting of a drive module and output module.
- Multiple systems used the same drive module.

The following processing occurs, when the error is detected at an output module.

- If an error is detected at least one output module, a drive module cannot start and that system cannot be operate.

The auxiliary input axis operation for the erroneous output module also cannot operate.

- Other systems which use the drive module which could not start by the output module error also cannot operate.

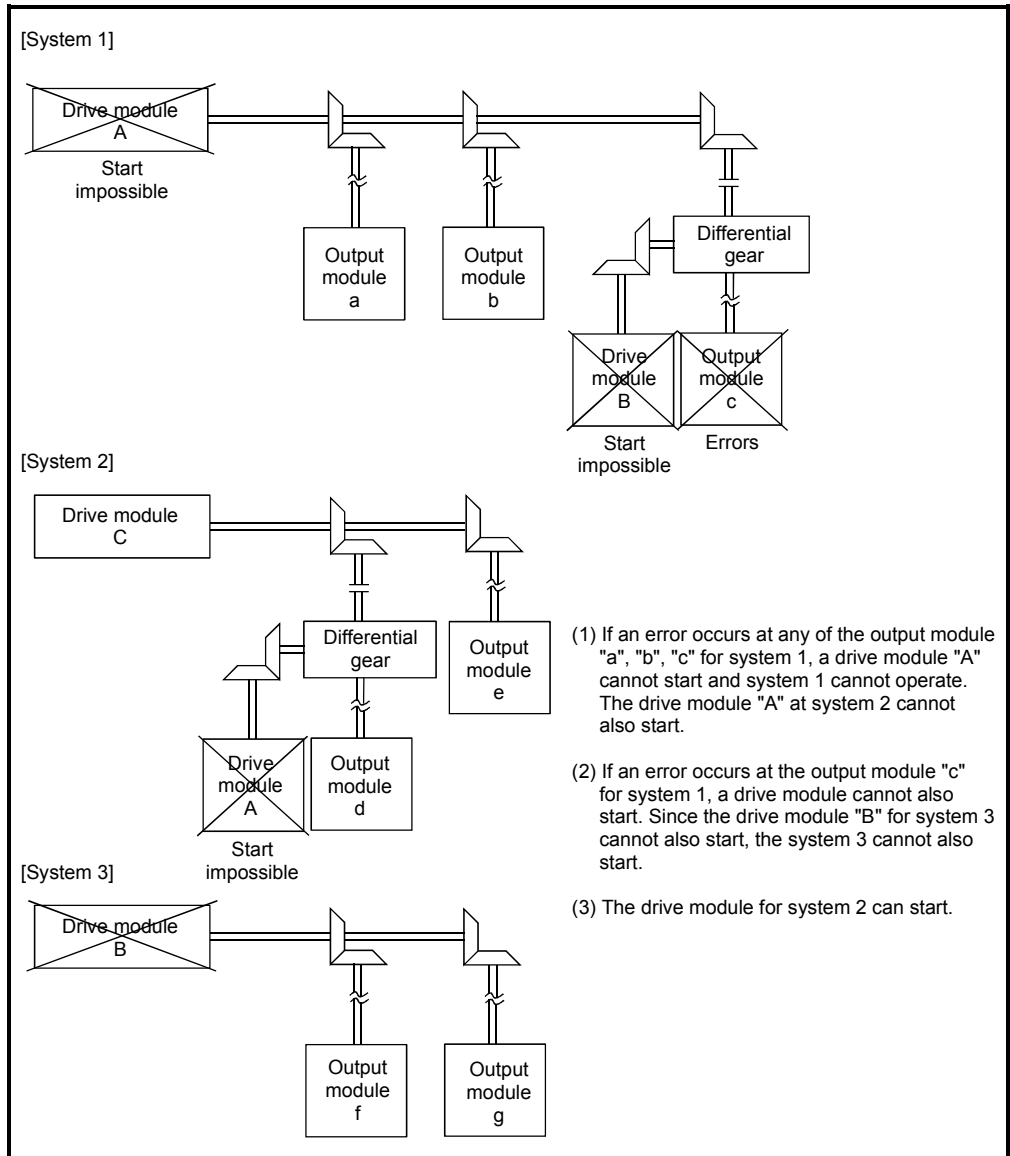

APPENDICES

APPENDIX 2.3 Servo program setting errors (Stored in D9190)

The error codes, error contents and corrective actions for servo program setting errors are shown in Table 2.1.

In the error codes marked with "Note" indicates the axis No. (1 to 32).

Table 2.1 Servo program setting error list

Error code stored in D9190	Error name	Error contents	Error processing	Corrective action															
1	Parameter block No. setting error	The parameter block No. is outside the range of 1 to 64.	Execute the servo program with the default value "1" of parameter block.	Set the parameter block No. within the range of 1 to 64.															
n03 (Note)	Address (travel value) setting error (Except the speed control and speed/position control.) (Setting error for linear axis at the helical-interpolation.)	<p>(1) The address is outside the setting range at the positioning start for absolute data method.</p> <table border="1"> <thead> <tr> <th>Unit</th> <th colspan="2">Address setting range</th> </tr> </thead> <tbody> <tr> <td>degree</td> <td>0 to 35999999</td> <td>$\times 10^{-5}$ [degree]</td> </tr> </tbody> </table> <p>(2) The travel value is set to -2147483648 (H80000000) at the positioning start for incremental data method.</p>	Unit	Address setting range		degree	0 to 35999999	$\times 10^{-5}$ [degree]	<p>(1) Positioning control does not start. (All interpolation control at the interpolation control.)</p> <p>(2) If the error is detected during the speed-switching control or constant-speed control, a deceleration stop is made.</p> <p>(3) If an error occurs in one servo program, all servo programs do not execute during the simultaneous start.</p>	<p>(1) If the control unit is [degree], set the address within the range of 0 to 35999999.</p> <p>(2) Set the travel value within the range of "0 to $\pm (2^{31}-1)$".</p>									
Unit	Address setting range																		
degree	0 to 35999999	$\times 10^{-5}$ [degree]																	
4	Command speed error	<p>(1) The command speed is outside the range of 1 to the speed limit value.</p> <p>(2) The command speed is outside the setting range.</p> <table border="1"> <thead> <tr> <th>Unit</th> <th colspan="2">Speed setting range</th> </tr> </thead> <tbody> <tr> <td>mm</td> <td>1 to 600000000</td> <td>$\times 10^{-2}$ [mm/min]</td> </tr> <tr> <td>inch</td> <td>1 to 600000000</td> <td>$\times 10^{-3}$ [inch/min]</td> </tr> <tr> <td>degree</td> <td>1 to 2147483647</td> <td>$\times 10^{-3}$ [degree /min] (Note-1)</td> </tr> <tr> <td>PLS</td> <td>1 to 2147483647</td> <td>[PLS/s]</td> </tr> </tbody> </table>	Unit	Speed setting range		mm	1 to 600000000	$\times 10^{-2}$ [mm/min]	inch	1 to 600000000	$\times 10^{-3}$ [inch/min]	degree	1 to 2147483647	$\times 10^{-3}$ [degree /min] (Note-1)	PLS	1 to 2147483647	[PLS/s]	<p>(1) Positioning control does not start if the command speed is "0" or less.</p> <p>(2) If the command speed exceeds the speed limit value, control with the speed limit value.</p>	Set the command speed within the range of 1 to the speed limit value.
Unit	Speed setting range																		
mm	1 to 600000000	$\times 10^{-2}$ [mm/min]																	
inch	1 to 600000000	$\times 10^{-3}$ [inch/min]																	
degree	1 to 2147483647	$\times 10^{-3}$ [degree /min] (Note-1)																	
PLS	1 to 2147483647	[PLS/s]																	
5	Dwell time setting error	The dwell time is outside the range of 0 to 5000.	Control with the default value "0".	Set the dwell time within the range of 0 to 5000.															
6	M-code setting error	The M-code is outside the range of 0 to 32767.	Control with the default value "0".	Set the M-code within the range of 0 to 32767.															
7	Torque limit value setting error	The torque limit value is outside the range of 1 to 1000.	Control with the torque limit value of the specified parameter block.	Set the torque limit value within the range of 1 to 1000.															

(Note-1): When the "speed control $10 \times$ multiplier setting for degree axis" is set to "valid", the setting range is 0.01 to 21474836.47 [degree/min].

APPENDICES

Table 2.1 Servo program setting error list (Continued)

Error code stored in D9190	Error name	Error contents	Error processing	Corrective action						
n08 (Note)	Auxiliary point setting error (At the auxiliary point-specified circular interpolation.) (At the auxiliary point-specified helical interpolation.)	(1) The auxiliary point address is outside the setting range at the positioning start for absolute data method. <table border="1" style="margin-left: auto; margin-right: auto;"> <tr> <th>Unit</th> <th colspan="2">Address setting range</th> </tr> <tr> <td>degree</td> <td>0 to 35999999</td> <td>$\times 10^{-5}$ [degree]</td> </tr> </table>	Unit	Address setting range		degree	0 to 35999999	$\times 10^{-5}$ [degree]	Positioning control does not start.	(1) If the control unit is [degree], set the auxiliary point address within the range of 0 to 35999999.
		Unit	Address setting range							
degree	0 to 35999999	$\times 10^{-5}$ [degree]								
(2) The auxiliary point address is set to -2147483648 (H80000000) at the positioning start for incremental data method.	(2) Set the auxiliary point address within the range of 0 to $\pm(2^{31}-1)$.									
n09 (Note)	Radius setting error (At the radius-specified circular interpolation.) (At the radius-specified helical interpolation.)	(1) The radius is outside the setting range at the positioning control for absolute data method. <table border="1" style="margin-left: auto; margin-right: auto;"> <tr> <th>Unit</th> <th colspan="2">Address setting range</th> </tr> <tr> <td>degree</td> <td>0 to 35999999</td> <td>$\times 10^{-5}$ [degree]</td> </tr> </table>	Unit	Address setting range		degree	0 to 35999999	$\times 10^{-5}$ [degree]	Positioning control does not start.	(1) If the control unit is [degree], set the radius within the range of 0 to 35999999.
		Unit	Address setting range							
degree	0 to 35999999	$\times 10^{-5}$ [degree]								
(2) The radius is set to "0" or negative setting at the positioning start for incremental data method.	(2) Set the radius within the range of 1 to $(2^{31}-1)$.									
N10 (Note)	Central point setting error (At the central point-specified circular interpolation.) (At the central point-specified helical interpolation.)	(1) The central point address is outside the setting range at the positioning start for absolute data method. <table border="1" style="margin-left: auto; margin-right: auto;"> <tr> <th>Unit</th> <th colspan="2">Address setting range</th> </tr> <tr> <td>degree</td> <td>0 to 35999999</td> <td>$\times 10^{-5}$ [degree]</td> </tr> </table>	Unit	Address setting range		degree	0 to 35999999	$\times 10^{-5}$ [degree]	Positioning control does not start.	(1) If the control unit is [degree], set the central point address within the range of 0 to 35999999.
		Unit	Address setting range							
degree	0 to 35999999	$\times 10^{-5}$ [degree]								
(2) The central point is set to -2147483648 (H80000000) at the positioning start for incremental data method.	(2) Set the central point address within the range of 0 to $\pm(2^{31}-1)$.									
11	Interpolation control unit setting error	The interpolation control unit is set outside the range of 0 to 3.	Control with the default value "3".	Set the interpolation control unit within the range of 0 to 3.						
12	Speed limit value setting error	The speed limit value is set outside the setting range.	Control with the default value 200000[PLS/s].	Set the speed limit value within the setting range. [For PLS] 1 to 2147483647[PLS/s]						
13	Acceleration time setting error	The acceleration time is set to "0".	Control with the default value "1000".	Set the acceleration time within the range of 1 to 65535.						
	FIN acceleration/ deceleration setting error	The FIN acceleration/deceleration time is set except 1 to 5000.		The FIN acceleration/ deceleration time within the range of 1 to 5000.						
	Fixed position stop acceleration/ deceleration time setting error	The fixed position stop acceleration/ deceleration time is set to "0".		Set the fixed position stop acceleration/ deceleration time within the range of 1 to 65535.						
14	Deceleration time setting error	The deceleration time is set to "0".		Set the deceleration time within the range of 1 to 65535.						

APPENDICES

Table 2.1 Servo program setting error list (Continued)

Error code stored in D9190	Error name	Error contents	Error processing	Corrective action										
15	Rapid stop deceleration time setting error	The rapid stop deceleration time is set to "0".	Control with the default value "1000".	Set the rapid stop deceleration time within the range of 1 to 65535.										
16	Torque limit value setting error	The torque limit value is outside the range of 1 to 1000.	Control with the default value "300[%]".	Set the torque limit value within the range of 1 to 1000.										
17	Allowable error range for circular interpolation setting error	The allowable error range for circular interpolation is outside the setting range. <table border="1" data-bbox="523 651 839 846"> <thead> <tr> <th>Unit</th> <th>Address setting range</th> </tr> </thead> <tbody> <tr> <td>mm</td> <td rowspan="4">0 to 100000</td> </tr> <tr> <td>inch</td> <td>$\times 10^{-5}$ [μm]</td> </tr> <tr> <td>degree</td> <td>$\times 10^{-5}$ [degree]</td> </tr> <tr> <td>PLS</td> <td>[PLS]</td> </tr> </tbody> </table>	Unit	Address setting range	mm	0 to 100000	inch	$\times 10^{-5}$ [μm]	degree	$\times 10^{-5}$ [degree]	PLS	[PLS]	Control with the default value "100[PLS]".	Set the allowable error range for circular interpolation within the setting range.
Unit	Address setting range													
mm	0 to 100000													
inch		$\times 10^{-5}$ [μm]												
degree		$\times 10^{-5}$ [degree]												
PLS		[PLS]												
18	Repeat count error	The repeat count is outside the range of 1 to 32767.	Control the repeat count with "1".	Set the repeat count within the range of 1 to 32767.										
19	START instruction setting error	(1) The servo program specified with the START instruction does not exist. (2) There is a START instruction in the specified servo program. (3) The starting axis of the specified servo program overlap.	Positioning control does not start.	(1) Create the servo program specified with the START instruction. (2) Delete the servo program specified with the START instruction. (3) Do not overlap the starting axis.										
20	Point setting error	Point is not specified in the instruction at the constant-speed control.	Positioning control does not start.	Set a point between CPSTART and CPEND.										
21	Reference axis speed setting error	The axis except interpolation axis is set as the reference axis at the linear interpolation of the reference axis speed-specified method.	Positioning control does not start.	Set one of the interpolation axes as the reference axis.										
22	S-curve ratio setting error	S-curve ratio is set outside the range of 0 to 100[%] at the S-curve acceleration/deceleration.	Control the S-curve ratio with 100[%].	Set the S-curve ratio within the range of 0 to 100[%].										
23	VSTART setting error	Not even one speed-switching point has been set between a VSTART and VEND instruction, or between FOR and NEXT instruction.	Positioning control does not start.	Set the speed switching point between the VSTART and VEND instructions or the FOR and NEXT instructions.										
24	Cancel function start program No. error	The start program No. for the cancel function is set outside the range 0 to 4095.	Positioning control does not start.	Start after set the start program No. within the range of 0 to 4095.										
25	High-Speed oscillation command amplitude error	Operation cannot be started because the amplitude specified with the high-speed oscillation function is outside the range 1 to 2147483647.	Positioning control does not start.	Start after set the command amplitude within the range of 1 to 214783647.										
26	High-Speed oscillation command starting angle error	Operation cannot be started because the starting angle specified with the high-speed oscillation function is outside the range of 0 to 3599 ($\times 0.1$ [degrees]).	Positioning control does not start.	Start after set the starting angle within the range of 0 to 3599 ($\times 0.1$ [degree]).										

APPENDICES

Table 2.1 Servo program setting error list (Continued)

Error code stored in D9190	Error name	Error contents	Error processing	Corrective action
27	High-Speed oscillation command frequency error	Operation cannot be started because the frequency specified with the high-speed oscillation function is outside the range of 1 to 5000[CPM].	Positioning control does not start.	Start after set the frequency within the range of 1 to 5000[CPM].
28	Number of helical interpolation pitches error	The specified number of pitches of helical interpolation is outside the range of 0 to 999.	Positioning control does not start.	Set the specified number of pitches within the range of 0 to 999.
900	START instruction setting error	The servo program specified with the servo program start does not exist.	Positioning control does not start.	Set the correct servo program No..
901	START instruction setting error	The axis No. set in the servo program start is different from the axis No. set in the servo program.	Positioning control does not start.	Set the correct axis No.
902	Servo program instruction code error	The instruction code cannot be decoded. (A non-existent instruction code has been specified.)	Positioning control does not start.	Set the correct instruction code.
903	Start error	A virtual mode program was started in the real mode.	Positioning control does not start.	Check the program mode allocation.
904	Start error	A real mode program was started in the virtual mode.	Positioning control does not start.	
905	Start error	(1) Operation disable instructions (VPF, VPR, VPSTART, PVF, PVR, ZERO, VVF, VVR, OSC) was started in virtual mode.	Positioning control does not start.	Correct the servo program.
		(2) Operation disable instructions (ZERO, OSC, CHGA-C, CHGA-E) was started in real mode axis.		
		(3) Operation disable instructions (CHGA-C, CHGA-E) from the S(P).SVST instruction of Motion dedicated instruction was started.		Use the S(P).CHGA instruction of Motion dedicated instruction.
906	Axis No. setting error	(1) Unused axis of the system setting is set in the Motion SFC program set in the servo program start.	Positioning control does not start.	Set the axis No. set in the system setting or mechanical system program.
		(2) It was started by setting the real mode axis in the virtual servo program.		
		(3) It was started in the condition that the real mode axis had been mixed with virtual axis in the interpolation axis.		
		(4) It was started by setting the virtual axis in the real mode program in virtual mode.		
907	Start error	It was started during processing for switching from real mode to virtual mode.	Positioning control does not start.	Use M2043 (real/virtual mode switching request), M2044 (real/virtual mode switching status) as interlocks for start.
908	Start error	It was stated during processing for switching from virtual mode to real mode.		

APPENDICES

APPENDIX 2.4 Drive module errors

Table 2.2 Drive module error (100 to 1199) list

Error class	Error code	Control mode of virtual servo axis									Error cause	Error processing	Corrective action
		Positioning	Fixed-pitch feed	Speed	Speed switching	Constant-speed	JOG	Manual pulse generator	Synchronous encoder	Position follow-up			
Minor error	100	<input type="checkbox"/>	<input type="checkbox"/>	<input type="checkbox"/>	<input type="checkbox"/>	<input type="checkbox"/>	<input type="checkbox"/>	<input type="checkbox"/>	<input type="checkbox"/>	<input type="checkbox"/>	• The PLC ready flag (M2000) or PCPU ready flag (M9074) is OFF.	Positioning control does not start.	• Set the Motion CPU to RUN. • Turn the PLC ready flag (M2000) on.
	101	<input type="checkbox"/>	<input type="checkbox"/>	<input type="checkbox"/>	<input type="checkbox"/>	<input type="checkbox"/>	<input type="checkbox"/>	<input type="checkbox"/>	<input type="checkbox"/>	<input type="checkbox"/>	• The start accept flag (M2001 to M2032) for applicable axis is ON.		• Take an interlock in the program not to start the starting axis. (Use the start accept flag OFF of the applicable axis as the starting condition).
	103	<input type="checkbox"/>	<input type="checkbox"/>	<input type="checkbox"/>	<input type="checkbox"/>	<input type="checkbox"/>	<input type="checkbox"/>	<input type="checkbox"/>	<input type="checkbox"/>	<input type="checkbox"/>	• The stop command (M4800+20n) for applicable axis is ON.		• Turn the stop command (M4800+20n) off and start.
	104	<input type="checkbox"/>	<input type="checkbox"/>	<input type="checkbox"/>	<input type="checkbox"/>	<input type="checkbox"/>	<input type="checkbox"/>	<input type="checkbox"/>	<input type="checkbox"/>	<input type="checkbox"/>	• The rapid stop command (M4801+20n) for applicable axis is ON.		• Turn the rapid stop command (M4801+20n) off and start.
	105 (Note)	<input type="checkbox"/>	<input type="checkbox"/>	<input type="checkbox"/>	<input type="checkbox"/>	<input type="checkbox"/>	<input type="checkbox"/>	<input type="checkbox"/>	<input type="checkbox"/>	<input type="checkbox"/>	• The feed current value is outside the range of stroke limit at the start.		• Set within the stroke limit range by the JOG operation. • Set within the stroke limit range by the home position return or current value change.
	106 (Note)	<input type="checkbox"/>	<input type="checkbox"/>	<input type="checkbox"/>	<input type="checkbox"/>	<input type="checkbox"/>	<input type="checkbox"/>	<input type="checkbox"/>	<input type="checkbox"/>	<input type="checkbox"/>	• Positioning is outside the range of stroke limit.		• Perform the positioning within the range of stroke limit.
	107	<input type="checkbox"/>	<input type="checkbox"/>	<input type="checkbox"/>	<input type="checkbox"/>	<input type="checkbox"/>	<input type="checkbox"/>	<input type="checkbox"/>	<input type="checkbox"/>	<input type="checkbox"/>	• The address that does not generate an arc is set at the auxiliary point-specified circular interpolation or auxiliary point-specified helical interpolation. (Relationship between the start point, auxiliary point and end point.)		• Correct the addresses of the servo program.
	108 (Note)	<input type="checkbox"/>	<input type="checkbox"/>	<input type="checkbox"/>	<input type="checkbox"/>	<input type="checkbox"/>	<input type="checkbox"/>	<input type="checkbox"/>	<input type="checkbox"/>	<input type="checkbox"/>	• The address that does not generate an arc is set at the R(radius) specified circular interpolation or R(radius) specified helical interpolation. (Relationship between the start point, radius and end point.)		
109	<input type="checkbox"/>	<input type="checkbox"/>	<input type="checkbox"/>	<input type="checkbox"/>	<input type="checkbox"/>	<input type="checkbox"/>	<input type="checkbox"/>	<input type="checkbox"/>	<input type="checkbox"/>	• The address that does not generate an arc is set at the central point-specified circular interpolation or central point-specified helical interpolation. (Relationship between the start point, central point and end point.)			

(Note) : This error code is stored at all relevant interpolation axis storage areas at the interpolation operation.

APPENDICES

Table 2.2 Drive module error (100 to 1199) list (Continued)

Error class	Error code	Control mode of virtual servo axis									Error cause	Error processing	Corrective action	
		Positioning	Fixed-pitch feed	Speed	Speed switching	Constant-speed	JOG	Manual pulse generator	Synchronous encoder	Position follow-up				
Minor error	110 (Note)	<input type="radio"/>				<input type="radio"/>					<ul style="list-style-type: none"> The difference between the end point address and ideal end point is outside the allowable error range for circular interpolation at the circular interpolation. 	Positioning control does not start.	<ul style="list-style-type: none"> Correct the addresses of the servo program. 	
	116										<ul style="list-style-type: none"> The setting JOG speed is "0". 		Control with the JOG speed limit value.	<ul style="list-style-type: none"> Set the correct speed (within the setting range).
							<input type="radio"/>				<ul style="list-style-type: none"> The setting JOG speed exceeded the JOG speed limit value. 	Control with the maximum setting range of each control unit.		<ul style="list-style-type: none"> Set the correct JOG speed limit value (within the setting range).
											<ul style="list-style-type: none"> The setting JOG speed limit value exceeded the setting range. 			
	117						<input type="radio"/>				<ul style="list-style-type: none"> Both of forward and reverse rotation were set at the simultaneous start for the JOG operation. 	Only the applicable axis set to the forward direction starts.	<ul style="list-style-type: none"> Set a correct data. 	
	140	<input type="radio"/>									<ul style="list-style-type: none"> The travel value of the reference axis is set at "0" in the linear interpolation for reference axis specification. 	Positioning control does not start.	<ul style="list-style-type: none"> Do not set axis of travel value "0" as the reference axis. 	
	141								<input type="radio"/>	<ul style="list-style-type: none"> The position command device of position follow-up control is set the odd number. 	<ul style="list-style-type: none"> Set the even number for the position command device of position follow-up control. 			
	151	<input type="radio"/>	<input type="radio"/>	<input type="radio"/>	<input type="radio"/>	<input type="radio"/>	<input type="radio"/>	<input type="radio"/>	<input type="radio"/>	<input type="radio"/>	<ul style="list-style-type: none"> Not allowed axis started in the virtual mode. (It cannot be started with error at real/virtual mode switching.) 		<ul style="list-style-type: none"> Start in the virtual mode again after correct the error cause in the real mode. 	
	152	<input type="radio"/>	<input type="radio"/>	<input type="radio"/>	<input type="radio"/>	<input type="radio"/>	<input type="radio"/>	<input type="radio"/>	<input type="radio"/>	<input type="radio"/>	<ul style="list-style-type: none"> It started at the virtual mode and during deceleration by all axes servo OFF (M2042 OFF). 			
153	<input type="radio"/>	<input type="radio"/>	<input type="radio"/>	<input type="radio"/>	<input type="radio"/>	<input type="radio"/>	<input type="radio"/>	<input type="radio"/>	<input type="radio"/>	<ul style="list-style-type: none"> It started at the virtual mode and during deceleration by occurrence of the output module servo error. 				
200	<input type="radio"/>	<input type="radio"/>	<input type="radio"/>	<input type="radio"/>	<input type="radio"/>	<input type="radio"/>	<input type="radio"/>	<input type="radio"/>	<input type="radio"/>	<ul style="list-style-type: none"> The PLC ready flag (M2000) turned off during the control by the servo program. 	Deceleration stop	<ul style="list-style-type: none"> Turn the PLC ready flag (M2000) on after all axes have stopped. 		

(Note) : This error code is stored at all relevant interpolation axis storage areas at the interpolation operation.

APPENDICES

Table 2.2 Drive module error (100 to 1199) list (Continued)

Error class	Error code	Control mode of virtual servo axis									Error cause	Error processing	Corrective action	
		Positioning	Fixed-pitch feed	Speed	Speed switching	Constant-speed	JOG	Manual pulse generator	Synchronous encoder	Position follow-up				
Minor error	204	<input type="radio"/>	<input type="radio"/>	<input type="radio"/>	<input type="radio"/>	<input type="radio"/>	<input type="radio"/>	<input type="radio"/>	<input type="radio"/>	<input type="radio"/>	<ul style="list-style-type: none"> The PLC ready flag (M2000) turned off to on again during deceleration by turning off the PLC ready flag (M2000). 	No operation	<ul style="list-style-type: none"> Turn the PLC ready flag (M2000) off to on after all axes have stopped. (Turn the PLC ready flag (M2000) off to on during deceleration is "no operation".) 	
	207	<input type="radio"/>			<input type="radio"/>	<input type="radio"/>	<input type="radio"/>			<input type="radio"/>	<ul style="list-style-type: none"> The feed current value exceeded the stroke limit range during positioning control. Only the axis exceed the stroke limit range is stored at the circular/helical interpolation. All interpolation axes are stored in the linear interpolation. 	Deceleration stop	<ul style="list-style-type: none"> Correct the stroke limit range or travel value setting so that positioning control is within the range of the stroke limit. 	
	208	<input type="radio"/>			<input type="radio"/>	<input type="radio"/>			<input type="radio"/>	<ul style="list-style-type: none"> The feed current value of another axis exceeded the stroke limit value during the circular/helical interpolation control or simultaneous manual pulse generator operation. (For detection of other axis errors). 				
	211					<input type="radio"/>				<ul style="list-style-type: none"> During positioning control, an overrun occurred because the deceleration distance for the output speed is not attained at the point where the final positioning address was detected. 	<ul style="list-style-type: none"> Set the speed setting so that overrun does not occur. Set the travel value so that overrun does not occur. 			
	214									<input type="radio"/>	<ul style="list-style-type: none"> The manual pulse generator was enabled during the start of the applicable axis, the manual pulse generator operation was executed. 	Manual pulse generator input is ignored until the axis stops.	<ul style="list-style-type: none"> Execute the manual pulse generator operation after the applicable axis stopped. 	
	215					<input type="radio"/>						<ul style="list-style-type: none"> The speed switching point address exceed the end point address. 	Rapid stop	<ul style="list-style-type: none"> Set the speed-switching point between the previous speed switching point address and the end point address.
												<ul style="list-style-type: none"> The positioning address in the reverse direction was set during the speed switching control. 		
	220										<input type="radio"/>	<ul style="list-style-type: none"> When the control unit is "degrees" during the position follow-up control, the command address exceeded the range of 0 to 35999999. 	Deceleration stop (M2001+n OFF)	<ul style="list-style-type: none"> When the control unit is "degree", set the command address within the range of 0 to 35999999.
<ul style="list-style-type: none"> The command address for the position follow-up control exceeded the stroke limit range. 												<ul style="list-style-type: none"> Set the address within the stroke limit range. 		

APPENDICES

Table 2.2 Drive module error (100 to 1199) list (Continued)

Error class	Error code	Control mode of virtual servo axis									Error cause	Error processing	Corrective action	
		Positioning	Fixed-pitch feed	Speed	Speed switching	Constant-speed	JOG	Manual pulse generator	Synchronous encoder	Position follow-up				
Minor error	225					○					• The speed at the pass point exceeded the speed limit value during the constant-speed control.	Control with the speed limit value.	• Set the speed command value within the range of 1 to speed limit value.	
	230					○					• When the skip is executed in the constant-speed control, the next interpolation instruction is an absolute circular interpolation or absolute helical interpolation.	Immediate stop	• Execute the absolute linear interpolation after a point which make a skip.	
	300	○	○	○	○	○	○	○	○	○	<ul style="list-style-type: none"> • The current value was changed during positioning control of the applicable axis. • The current value was changed for the axis that had not been started. • The current value was changed for the servo OFF axis. 	Current value is not changed.	<ul style="list-style-type: none"> • Use the following devices as interlocks not to change the current value for the applicable axis. (1) The start accept flag (M2001 to M2032) OFF for applicable axis. (2) The servo READY signal (M2415+20n) ON. 	
	302	○				○					• The speed was changed for the axis during circular interpolation.	Speed is not changed.	• Do not change speed during circular interpolation.	
	303	○	○		○	○				○	• The speed was changed after positioning automatic deceleration start.		• Do not change speed after automatic deceleration start for positioning control.	
	304							○			• The speed was changed during deceleration by turning off the JOG start command signal (M4802+20n, M4803+20n).		• Do not change speed during deceleration by turning off the JOG start command signal (M4802+20n, M4803+20n).	
	305					○		○			○	• The speed after speed change is set outside the range of 0 to speed limit value.	Control with the speed limit value.	• Set the speed after speed change within the range of 0 to speed limit value.
		○	○	○		○						• The absolute value of speed after speed change is set outside the range of 0 to speed limit value.		• Set the absolute value of speed after speed change within the range of 0 to speed limit value.
	309											• The current value was changed outside the range of 0 to 35999999 ($\times 10^{-5}$ [degrees]) for the degree axis.	Current value is not changed.	• Set the current value within the range of 0 to 35999999 ($\times 10^{-5}$ [degree]).

APPENDICES

Table 2.2 Drive module error (100 to 1199) list (Continued)

Error class	Error code	Control mode of virtual servo axis									Error cause	Error processing	Corrective action
		Positioning	Fixed-pitch feed	Speed	Speed switching	Constant-speed	JOG	Manual pulse generator	Synchronous encoder	Position follow-up			
Major error	1151										<ul style="list-style-type: none"> • Q172EX or encoder hardware error. 	Immediate input stop	<ul style="list-style-type: none"> • Check (replace) the Q172EX or encoder.
											<ul style="list-style-type: none"> • Disconnected encoder cable 		<ul style="list-style-type: none"> • Check the encoder cable
											○	<ul style="list-style-type: none"> • A synchronous encoder set in the system setting differs from a synchronous encoder actually connected. 	Input from synchronous encoder does not accept.
											<ul style="list-style-type: none"> • Q170ENC is connected to Q172EX/Q172EX-S1. 	<ul style="list-style-type: none"> • Use Q172EX/Q172EX-S1 to connect Q170ENC. 	
	1152									○	<ul style="list-style-type: none"> • Low voltage at Q172EX. 	Operation is continued.	<ul style="list-style-type: none"> • Replace the battery.
	1153									○	<ul style="list-style-type: none"> • No battery or disconnected battery at Q172EX. 		<ul style="list-style-type: none"> • Replace the battery or check (replace) the Q172EX.

APPENDIX 2.5 Servo errors

(1) Servo amplifier errors (2000 to 2899)

These errors are detected by the servo amplifier, and the error codes are [2000] to [2899].

The servo error detection signal (M2408+20n) turns on at the servo amplifier error occurrence. Eliminate the error cause, reset the servo amplifier error by turning on the servo error reset command (M3208+20n) and perform re-start. (The servo error detection signal does not turn on because the codes [2100] to [2599] are for warnings.)

(Note-1): As for the regenerative alarm (error code [2030]) or overload 1 or 2 (error codes [2050], [2051]), the state at the operation is held also for after the protection circuit operation in the servo amplifier. The memory contents are cleared with the external power supply off, but are not cleared by the reset signal.

(Note-2): If resetting by turning off the external power supply is repeated at the occurrence of error code [2030], [2050] or [2051], it may cause devices to be destroyed by overheating. Re-start operation after eliminating the cause of the error certainly.

Details of servo errors are shown in Table 2.3.

CAUTION

- If a controller, servo amplifier self-diagnosis error occurs, check the points stated in this manual and clear the error.

APPENDICES

Table 2.3 Servo error (2000 to 2899) list

Error code	Error cause		Error check	Error processing	Corrective action
	Name	Description			
2010	Undervoltage	<ul style="list-style-type: none"> Power supply voltage is low. MR-J3-□B: 160VAC or less MR-J3-□B1: 83VAC or less MR-J3-□B4: 280VAC or less There was an instantaneous control power failure of 60[ms] or longer. Shortage of power supply capacity caused the power supply voltage to drop at start, etc. The bus voltage dropped to the following value or less. MR-J3-□B: 200VDC MR-J3-□B1: 158VDC MR-J3-□B4: 380VDC Faulty parts in the servo amplifier [Checking method] Servo error [2010] occurs if power is switched on after disconnection of all cables but the control circuit power supply cables. 	Any time during operation	Immediate stop	<ul style="list-style-type: none"> Review the power supply.
2012	Memory error 1 (RAM)	<ul style="list-style-type: none"> Faulty parts in the servo amplifier (RAM memory error) [Checking method] Servo error [2012] occurs if power is switched on after disconnection of all cables but the control circuit power supply cables. 	<ul style="list-style-type: none"> Servo amplifier power on. Multiple CPU system power on. 		<ul style="list-style-type: none"> Replace the servo amplifier.
2013	Clock error	<ul style="list-style-type: none"> Faulty parts in the servo amplifier (Printed board fault) [Checking method] Servo error [2013] occurs if power is switched on after disconnection of all cables but the control circuit power supply cables. Faulty the controller (Clock error transmitted from the controller) [Checking method] Servo error [2013] occurs if Motion CPU is used in the Multiple CPU system. 	Any time during operation		<ul style="list-style-type: none"> Replace the servo amplifier. Replace the Motion CPU.
2014	CPU Watchdog	<ul style="list-style-type: none"> Faulty hardware of servo amplifier 			<ul style="list-style-type: none"> Replace the servo amplifier.
2015	Memory error 2 (EEP-ROM)	<ul style="list-style-type: none"> Faulty parts in the servo amplifier (EEP-ROM fault) [Checking method] Servo error [2015] occurs if power is switched on after disconnection of all cables but the control circuit power supply cables. The number of write times to EEPROM exceeded 100,000. 	<ul style="list-style-type: none"> Servo amplifier power on. Multiple CPU system power on. 		

APPENDICES

Table 2.3 Servo error (2000 to 2899) list (Continued)

Error code	Error cause		Error check	Error processing	Corrective action
	Name	Description			
2016	Encoder error 1 (At power on)	<ul style="list-style-type: none"> Encoder connector (CN2) disconnected. Encoder fault 			<ul style="list-style-type: none"> Connect correctly. Replace the servomotor. Repair or replace the cable.
		<ul style="list-style-type: none"> Encoder cable faulty (Wire breakage or shorted) Encoder cable type (2-wire, 4-wire) selection was wrong in parameter setting. 			<ul style="list-style-type: none"> Set the correct encoder type of servo parameter.
2017	Board error	<ul style="list-style-type: none"> Faulty parts in the servo amplifier (CPU/parts fault) [Checking method] <p>Servo error [2017] occurs if power is switched on after disconnection of all cables but the control circuit power supply cables.</p>	<ul style="list-style-type: none"> Servo amplifier power on. Multiple CPU system power on. 	Immediate stop	<ul style="list-style-type: none"> Replace the servo amplifier.
2019	Memory error 3 (Flash ROM)	<ul style="list-style-type: none"> Faulty parts in the servo amplifier (ROM memory fault) [Checking method] <p>Servo error [2019] occurs if power is switched on after disconnection of all cables but the control circuit power supply cables.</p>			
2020	Encoder error 2	<ul style="list-style-type: none"> Encoder connector (CN2) disconnected. Encoder fault Encoder cable faulty (Wire breakage or shorted) 			<ul style="list-style-type: none"> Connect correctly. Replace the servomotor. Repair or replace the cable.
2024	Main circuit error	<ul style="list-style-type: none"> Power input wires and servomotor power wires are in contact. [Checking method] <p>Servo error [2024] occurs if servo is switched on after disconnecting the U, V and W power cables from the servo amplifier.</p>	Any time during operation		<ul style="list-style-type: none"> Correct the wiring.
		<ul style="list-style-type: none"> Sheathes of servomotor power cables deteriorated, resulting in ground fault. Main circuit of servo amplifier failed. 			<ul style="list-style-type: none"> Replace the cable. Replace the servo amplifier.
2025	Absolute position erase	<ul style="list-style-type: none"> Voltage drop in encoder (Battery of servo amplifier disconnected.) 	<ul style="list-style-type: none"> Servo amplifier power on. Multiple CPU system power on. 	Immediate stop Home position return request ON	<ul style="list-style-type: none"> After leaving the servo error [2025] occurring for a few minutes, switch power off, then on again. Always make home position return again. Replace the battery.
		<ul style="list-style-type: none"> Battery voltage low Battery cable or battery is faulty. Home position return not set. (Power was switched on for the first time in the absolute position detection system.) 			<ul style="list-style-type: none"> Always make home position return again. After leaving the servo error [2025] occurring for a few minutes, switch power off, then on again. Always make home position return again.

APPENDICES

Table 1.12 Servo error (2000 to 2899) list (Continued)

Error code	Error cause		Error check	Error processing	Corrective action
	Name	Description			
2027	Initial magnetic pole detection error	<ul style="list-style-type: none"> • Machine struck. • Accuracy at initial magnetic pole detection is bad. • Wrong wiring of the servomotor wires (U, V, and W). • Linear encoder resolution differs from the setting value. • Mismatch of the linear encoder installation direction. • Magnetic pole detection limit switch is not on. 	<ul style="list-style-type: none"> • Servo amplifier power on. • Multiple CPU system power on. 	Immediate stop	<ul style="list-style-type: none"> • Check the machine. • Review the parameter No.PS09 setting (magnetic pole detection voltage level). • Correct the wiring. • Review the parameter No.PS02 and PS03 setting (linear encoder resolution). • Check the installation of linear encoder. • Check the installation direction of linear encoder. • Connect the magnetic detection limit switch correctly. • Set the limit switch to forced ON by the parameter No.PD02 setting. (When the amplifier input is used in the Motion CPU, do not set to forced ON since it is shared with the input signal.)
2028	Linear encoder error 2	<ul style="list-style-type: none"> • The temperature of linear encoder is high. • The signal level of linear encoder has dropped. 	Any time during operation		<ul style="list-style-type: none"> • Check the temperature of linear encoder and contact with the linear encoder manufacturer. • Check the installation of linear encoder.

APPENDICES

Table 2.3 Servo error (2000 to 2899) list (Continued)

Error code	Error cause		Error check	Error processing	Corrective action
	Name	Description			
2030	Regenerative alarm	<ul style="list-style-type: none"> Wrong setting of system setting (regenerative brake) 	Any time during operation	Immediate stop	<ul style="list-style-type: none"> Check the regenerative brake of system setting and set correctly.
		<ul style="list-style-type: none"> Built-in regenerative brake resistor or regenerative brake option is not connected. High-duty operation or continuous regenerative operation caused the permissible regenerative power of the regenerative brake option to be exceeded. [Checking method] Call the servo monitor and check the regenerative level. 			<ul style="list-style-type: none"> Connect correctly. Reduce the frequency of positioning. (Call the regenerative level [%] of servo monitor and reduce the frequency of acceleration/deceleration or feed speed.) Use the regenerative brake option of larger capacity. Reduce the load. Review the power supply
2031	Overspeed	<ul style="list-style-type: none"> Power supply voltage is abnormal. MR-J3-□B: 260VAC or more MR-J3-□B1: More than 135VAC MR-J3-□B4: 535VAC or more Built-in regenerative brake resistor or regenerative brake option faulty. Regenerative transistor faulty. [Checking method] <ul style="list-style-type: none"> The regenerative brake option has overheated abnormally. Servo error [2030] occurs even after removal of the built-in regenerative brake resistor or regenerative brake option. 	Any time during operation	Immediate stop	<ul style="list-style-type: none"> Replace the servo amplifier or regenerative brake option. Replace the servo amplifier.
		<ul style="list-style-type: none"> Command speed is too high. (Motor speed has exceeded the instantaneous permissible speed.) Small acceleration/deceleration time constant caused overshoot to be large. Servo system is instable to cause overshoot. Electronic gear ratio is high. Encoder faulty. 			<ul style="list-style-type: none"> Check the servo program or mechanical system program, and set correctly. If an overshoot occurs during acceleration/deceleration, check the acceleration/deceleration time in the fixed parameters. Re-set servo gain to proper value. If servo gain cannot be set to proper value: <ol style="list-style-type: none"> Reduce load inertia moment ratio; or Reexamine acceleration/deceleration time constant. Set correctly.(Check if the number of pulses per revolution and travel value per revolution in the fixed parameters match the machine system. Replace the servomotor.

APPENDICES

Table 2.3 Servo error (2000 to 2899) list (Continued)

Error code	Error cause		Error check	Error processing	Corrective action
	Name	Description			
2032	Overcurrent	<ul style="list-style-type: none"> Short occurred in servomotor power (U, V, W). 			<ul style="list-style-type: none"> Correct the wiring.
		<ul style="list-style-type: none"> Transistor (IPM) of the servo amplifier faulty. 			<ul style="list-style-type: none"> Replace the servo amplifier.
		<p>[Checking method] Servo error [2032] occurs if power is switched on after U, V and W are disconnected.</p>			
		<ul style="list-style-type: none"> Ground fault occurred in servomotor power (U, V, W). External noise caused the overcurrent detection circuit to misoperate. 			<ul style="list-style-type: none"> Correct the wiring. Take noise suppression measures.
2033	Overvoltage	<ul style="list-style-type: none"> Lead of built-in regenerative brake resistor or regenerative brake option is open or disconnected. 	Any time during operation	Immediate stop	<ul style="list-style-type: none"> Replace the lead. Connect correctly.
		<ul style="list-style-type: none"> Regenerative transistor faulty. 			<ul style="list-style-type: none"> Replace the servo amplifier.
		<ul style="list-style-type: none"> Wire breakage of built-in regenerative brake resistor or regenerative brake option. 			<ul style="list-style-type: none"> For wire breakage of built-in regenerative brake resistor, replace the servo amplifier. For wire breakage of regenerative brake option, replace the regenerative brake option.
		<ul style="list-style-type: none"> Capacity of built-in regenerative brake resistor or regenerative brake option is insufficient. 			<ul style="list-style-type: none"> Add regenerative brake option or increase capacity.
		<ul style="list-style-type: none"> Power supply voltage is high. Ground fault occurred in servomotor power (U, V, W). 			<ul style="list-style-type: none"> Review the power supply. Correct the wiring.
2034	Communications error	<ul style="list-style-type: none"> Data received from the Motion CPU faulty. 			<ul style="list-style-type: none"> Check the connection of SSCNETIII cable. Check if there is a disconnection in the SSCNETIII cable.
2035	Command frequency error	<ul style="list-style-type: none"> There is excessive variation in the position commands and command speed is too high from the Motion CPU. 			<ul style="list-style-type: none"> Check the command speed and the number of pulses per revolution/travel value per revolution of the fixed parameters.
		<ul style="list-style-type: none"> Noise entered the commands from the Motion CPU. Motion CPU failure 			<ul style="list-style-type: none"> Check the connection of SSCNETIII cable. Check if there is a disconnection in the SSCNETIII cable. Check if any relays or solenoids are operating in the vicinity. Replace the Motion CPU.
2036	Transmission error	<ul style="list-style-type: none"> Fault in communication with the Motion CPU. 			<ul style="list-style-type: none"> Check the connection of SSCNETIII cable. Check if there is a disconnection in the SSCNETIII cable.

APPENDICES

Table 2.3 Servo error (2000 to 2899) list (Continued)

Error code	Error cause		Error check	Error processing	Corrective action
	Name	Description			
2042	Linear servo control error (Linear servo amplifier)	<ul style="list-style-type: none"> Linear encoder signal resolution differs from the setting value. 	<ul style="list-style-type: none"> Servo amplifier power on. Multiple CPU system power on. 	Immediate stop	<ul style="list-style-type: none"> Review the settings of parameter No.PS02 and PS03 setting (linear encoder resolution). Check the installation of linear encoder.
		<ul style="list-style-type: none"> Initial magnetic pole detection has not been performed. 			<ul style="list-style-type: none"> Perform initial magnetic pole detection.
		<ul style="list-style-type: none"> Mismatch of the linear encoder installation direction. 			<ul style="list-style-type: none"> Check the installation direction of linear encoder. Review the setting of parameter No. PC27 (encoder pulse count polarity).
		<ul style="list-style-type: none"> Wrong wiring of the servomotor wires (U, V, and W). 			<ul style="list-style-type: none"> Correct the wiring.
		<ul style="list-style-type: none"> The position deviation exceeded the detection level. 			<ul style="list-style-type: none"> Review the operation condition. Review the setting of parameter No.PS05 (Linear servo control position deviation error detection level) as required.
		<ul style="list-style-type: none"> The speed deviation exceeded the detection level. 			<ul style="list-style-type: none"> Review the operation condition. Review the setting of parameter No.PS06 (Linear servo control speed deviation error detection level) as required.
		<ul style="list-style-type: none"> The thrust deviation exceeded the detection level. 			<ul style="list-style-type: none"> Review the operation condition. Review the setting of parameter No.PS07 (Linear servo control thrust deviation error detection level) as required.
2042	Fully closed control error (Fully closed loop control servo amplifier)	<ul style="list-style-type: none"> Load side encoder resolution differs from the setting value. 			<ul style="list-style-type: none"> Review the settings of parameter No.PE04 and PE05 (Fully closed loop control feedback pulse electronic gear). Check the installation of load side encoder.
		<ul style="list-style-type: none"> Mismatch of the load side encoder installation direction. 			<ul style="list-style-type: none"> Check the installation direction of load side encoder. Review the setting of parameter No. PC27 (encoder pulse count polarity).
		<ul style="list-style-type: none"> The position deviation exceeded the detection level. 			<ul style="list-style-type: none"> Review the operation condition. Review the setting of parameter No.PE07 (Fully closed loop control position deviation error detection level) as required.
		<ul style="list-style-type: none"> The speed deviation exceeded the detection level. 			<ul style="list-style-type: none"> Review the operation condition. Review the setting of parameter No. PE06 (Fully closed loop control speed deviation error detection level) as required.

APPENDICES

Table 2.3 Servo error (2000 to 2899) list (Continued)

Error code	Error cause		Error check	Error processing	Corrective action
	Name	Description			
2045	Main circuit device overheat	<ul style="list-style-type: none"> Servo amplifier failure The power supply was turned on and off continuously by overloaded status. Ambient temperature of servo amplifier is over 55[°C] (131[°F]). Used beyond the specifications of close mounting of servo amplifier. 			<ul style="list-style-type: none"> Replace the servo amplifier. The drive method is reviewed. Review environment so that ambient temperature is 0 to 55[°C] (32 to 131[°F]). Use within the range of specifications.
2046	Servomotor overheat	<ul style="list-style-type: none"> Ambient temperature of servomotor is over 40[°C] (104[°F]). Servomotor is overloaded. Thermal sensor in encoder is faulty. 			<ul style="list-style-type: none"> Review environment so that ambient temperature is 0 to 40[°C] (32 to 104[°F]). Reduce load. Review operation pattern. Use servomotor that provides larger output. Replace the servomotor.
2047	Cooling fan alarm	<ul style="list-style-type: none"> Cooling fan life expiration Foreign matter caught in the fan stopped rotation. The power supply of the cooling fan failed. 			<ul style="list-style-type: none"> Replace the cooling fan of the servo amplifier. Remove the foreign matter. Replace the servo amplifier.
2050	Overload 1	<ul style="list-style-type: none"> Servo amplifier is used in excess of its continuous output current. Servo system is instable and hunting. Machine struck something. Wrong connection of servo motor. (Servo amplifier's output terminals U, V, W do not match servo motor's input terminals U, V, W.) Encoder faulty. [Checking method] When the servomotor shaft is rotated with the servo off, the cumulative feedback pulses do not vary in proportion to the rotary angle of the shaft but the indication skips or returns midway. 	Any time during operation	Immediate stop	<ul style="list-style-type: none"> Reduce load. Review operation pattern. Use servomotor that provides larger output. Repeat acceleration/ deceleration to execute auto tuning. Change auto tuning response setting. Set auto tuning to OFF and make gain adjustment manually. Review operation pattern. Install limit switches. Connect correctly. Replace the servomotor.

APPENDICES

Table 2.3 Servo error (2000 to 2899) list (Continued)

Error code	Error cause		Error check	Error processing	Corrective action
	Name	Description			
2051	Overload 2	<ul style="list-style-type: none"> Machine struck something. 	Any time during operation	Immediate stop	<ul style="list-style-type: none"> Review operation pattern. Install limit switches. Connect correctly.
		<ul style="list-style-type: none"> Wrong connection of servomotor. (Servo amplifier's output terminals U, V, W do not match servo motor's input terminals U, V, W.) Servo system is instable and hunting. 			<ul style="list-style-type: none"> Repeat acceleration/ deceleration to execute auto tuning. Change auto tuning response setting. Set auto tuning to OFF and make gain adjustment manually.
2052	Error excessive	<ul style="list-style-type: none"> Encoder faulty. [Checking method] When the servomotor shaft is rotated with the servo off, the cumulative feedback pulses do not vary in proportion to the rotary angle of the shaft but the indication skips or returns midway. 			<ul style="list-style-type: none"> Replace the servomotor.
		<ul style="list-style-type: none"> Acceleration/deceleration time constant is too small. Torque limit value is too small. Motor cannot be started due to torque shortage caused by power supply voltage drop. Model loop gain value of servo parameter is small. Servomotor shaft was rotated by external force. 			<ul style="list-style-type: none"> Increase the acceleration/deceleration time. Increase the torque limit value. Review the power supply capacity. Use servomotor which provides larger output. Increase set value and adjust to ensure proper operation. When torque is limited, increase the limit value. Reduce load. Use servomotor that provides larger output.
2060 (AL. 1A)	Motor combination error	<ul style="list-style-type: none"> Machine struck something. Encoder faulty Wrong connection of servomotor. (Servo amplifier's output terminals U, V, W do not match servomotor's input terminals U, V, W.) 	<ul style="list-style-type: none"> Servo amplifier power on. Multiple CPU system power on. 		<ul style="list-style-type: none"> Review operation pattern. Install limit switches. Replace the servomotor. Connect correctly.
		<ul style="list-style-type: none"> Fault in combination with the servo amplifier and servomotor. 			<ul style="list-style-type: none"> Use the correct combination with the servo amplifier and servomotor.

APPENDICES

Table 2.3 Servo error (2000 to 2899) list (Continued)

Error code	Error cause		Error check	Error processing	Corrective action
	Name	Description			
2061 (AL.2A)	Linear encoder error 1	<ul style="list-style-type: none"> The speed of linear encoder has exceeded the range of use. Noise entered. Alarm of the linear encoder. Defective installation positions of the scale and head. 	Any time during operation	Immediate stop	<ul style="list-style-type: none"> Change the speed of linear encoder within the range of use. Take the noise reduction measures. Contact with the linear encoder manufacturer. Adjust the positions of the scale and head.
2070	Load side encoder error 1	<ul style="list-style-type: none"> The connector CN2L is disconnected. Faulty of the load side encoder cable Wrong wiring of the load side encoder cable The load side encoder cable type (2-wire, 4-wire) selection was wrong in the parameter setting. The startup timing is slow. (For the load side encoder with the external power supply input) 	<ul style="list-style-type: none"> Servo amplifier power on. Multiple CPU system power on. 		<ul style="list-style-type: none"> Connect correctly. Repair or change the cable. Review the wiring connection. Correct the setting in the fourth digit of parameter No. PC26 (encoder cable communication system selection). Make the startup timing of the external power supply fast.
2071	Load side encoder error 2	<ul style="list-style-type: none"> Faulty of the load side encoder cable Wrong wiring of the load side encoder cable The power supply voltage dropped. (For the load side encoder with the external power supply input) 			<ul style="list-style-type: none"> Repair or change the cable. Review the wiring connection. Check the power supply capacity and voltage.
2088 (88)	Watchdog	<ul style="list-style-type: none"> CPU, parts faulty 			<ul style="list-style-type: none"> Replace the servo amplifier.
2102 (AL.92)	Open battery cable warning	<ul style="list-style-type: none"> Battery cable for absolute position detection system is open. Voltage of battery for absolute position detection system supplied fell to about 3V or less. (Detected with the encoder.) 		Operation continues	<ul style="list-style-type: none"> Repair the cable or replace the battery. Replace the battery.
2106 (AL.96)	Home position setting warning	<ul style="list-style-type: none"> After home position return, droop pulses remaining are greater than the in-position range setting. Creep speed is high. 	Any time during operation		<ul style="list-style-type: none"> Re-try the home position return. Reduce the creep speed.
2116 (AL.9F)	Battery warning	<ul style="list-style-type: none"> Voltage of battery for absolute position detection system installed to servo amplifier fell to 3.2V or less. (Detected with the servo amplifier.) 			<ul style="list-style-type: none"> Replace the battery.
2140 (AL.E0)	Excessive regenerative warning	<ul style="list-style-type: none"> There is a possibility that regenerative alarm [2030] may occur. (Detected 85[%] regenerative level of the maximum load capacity for the regenerative register.) 			<ul style="list-style-type: none"> Refer to the details on the regenerative alarm [2030].
2141 (AL.E1)	Overload warning 1	<ul style="list-style-type: none"> There is a possibility that overload alarm [2050], [2051] may occur. (Detected 85[%] overload level.) 			<ul style="list-style-type: none"> Refer to the details on the overload alarm [2050], [2051].

APPENDICES

Table 2.3 Servo error (2000 to 2899) list (Continued)

Error code	Error cause		Error check	Error processing	Corrective action
	Name	Description			
2142 (AL.E2)	Servo motor overheat warning	<ul style="list-style-type: none"> Ambient temperature of servomotor is over 40[°C] (104[°F]). Servomotor is overloaded. Thermistor in encoder is faulty. 	Any time during operation	Operation continues	<ul style="list-style-type: none"> Review environment so that ambient temperature is 0 to 49[°C] (32 to 104[°F]). Reduce load. Review operation pattern. Use servomotor that provides larger output. Replace the servomotor.
2143 (AL.E3)	Absolute position counter warning	<ul style="list-style-type: none"> Absolute position encoder pulses faulty. 		Operation continues Home position return request ON	<ul style="list-style-type: none"> Take noise suppression measures. Replace the servomotor. Execute the home position return after measures.
2146 (AL.E6)	Servo forced stop warning	<ul style="list-style-type: none"> Servo amplifier are forced stop state. (Servo amplifier input signal EM1 is OFF.) 		Immediate stop	<ul style="list-style-type: none"> Ensure safety and deactivate forced stop. Ensure safety and deactivate forced stop.
2147 (AL.E7)	Controller forced stop warning	<ul style="list-style-type: none"> A forced stop signal is input from the Motion CPU 			
2148 (AL.E8)	Cooling fan speed reduction warning	<ul style="list-style-type: none"> Cooling fan life expiration The power supply of the cooling fan is broken. 			<ul style="list-style-type: none"> Replace the cooling fan of servo amplifier. Replace the servo amplifier. Replace the cooling fan of servo amplifier.
2149 (AL.E9)	Main circuit off warning	<ul style="list-style-type: none"> Servo-on signal was turned on with main circuit power off. 			<ul style="list-style-type: none"> Switch on the main circuit power.
2152 (AL.EC)	Overload warning 2	<ul style="list-style-type: none"> During a stop, the status in which a current flew intensively in any of the U, V and W phases of the servomotor occurred repeatedly, exceeding the warning level. 			<ul style="list-style-type: none"> Reduce the positioning frequency at the specific positioning address. Reduce the load. Replace the servo amplifier/ servomotor with the one of larger capacity.
2153 (AL.ED)	Output watt excess warning	<ul style="list-style-type: none"> Continuous operation was performed with the output wattage (speed × torque) of the servomotor exceeding 150[%] of the rated output. 			<ul style="list-style-type: none"> Reduce the servomotor speed. Reduce the load.

APPENDICES

Table 2.3 Servo error (2000 to 2899) list (Continued)

Error code	Error cause		Error check	Error processing	Corrective action																																																																																																												
	Name	Description																																																																																																															
2301 to 2599	Parameter error	Parameter error • The servo parameter value is outside the setting range. (Any unauthorized parameter is ignored and the value before setting is held.)	Any time during operation	Operation continues	• Check the setting ranges of the servo parameters.																																																																																																												
		<table border="1"> <thead> <tr> <th>Error code</th> <th>Parameter No.</th> <th>Name</th> </tr> </thead> <tbody> <tr><td>2301</td><td>PA01</td><td>For manufacturer setting</td></tr> <tr><td>2302</td><td>PA02</td><td>Regenerative brake option</td></tr> <tr><td>2303</td><td>PA03</td><td>Absolute position detection system</td></tr> <tr><td>2304</td><td>PA04</td><td>Function selection A-1</td></tr> <tr><td>2305</td><td>PA05</td><td>For manufacturer setting</td></tr> <tr><td>2306</td><td>PA06</td><td>For manufacturer setting</td></tr> <tr><td>2307</td><td>PA07</td><td>For manufacturer setting</td></tr> <tr><td>2308</td><td>PA08</td><td>Auto tuning mode</td></tr> <tr><td>2309</td><td>PA09</td><td>Auto tuning response</td></tr> <tr><td>2310</td><td>PA10</td><td>In-position range</td></tr> <tr><td>2311</td><td>PA11</td><td>For manufacturer setting</td></tr> <tr><td>2312</td><td>PA12</td><td>For manufacturer setting</td></tr> <tr><td>2313</td><td>PA13</td><td>For manufacturer setting</td></tr> <tr><td>2314</td><td>PA14</td><td>Rotation direction selection</td></tr> <tr><td>2315</td><td>PA15</td><td>Encoder output pulse</td></tr> <tr><td>2316</td><td>PA16</td><td>For manufacturer setting</td></tr> <tr><td>2317</td><td>PA17</td><td>For manufacturer setting</td></tr> <tr><td>2318</td><td>PA18</td><td>For manufacturer setting</td></tr> <tr><td>2319</td><td>PA19</td><td>Parameter write inhibit</td></tr> <tr><td>2320</td><td>PB01</td><td>Adaptive tuning mode</td></tr> <tr><td>2321</td><td>PB02</td><td>Vibration suppression control filter tuning mode</td></tr> <tr><td>2322</td><td>PB03</td><td>For manufacturer setting</td></tr> <tr><td>2323</td><td>PB04</td><td>Feed forward gain</td></tr> <tr><td>2324</td><td>PB05</td><td>For manufacturer setting</td></tr> <tr><td>2325</td><td>PB06</td><td>Ratio of load inertia moment to servo motor inertia moment</td></tr> <tr><td>2326</td><td>PB07</td><td>Model loop gain</td></tr> <tr><td>2327</td><td>PB08</td><td>Position loop gain</td></tr> <tr><td>2328</td><td>PB09</td><td>Speed loop gain</td></tr> <tr><td>2329</td><td>PB10</td><td>Speed integral compensation</td></tr> <tr><td>2330</td><td>PB11</td><td>Speed differential compensation</td></tr> <tr><td>2331</td><td>PB12</td><td>For manufacturer setting</td></tr> <tr><td>2332</td><td>PB13</td><td>Machine resonance suppression filter 1</td></tr> <tr><td>2333</td><td>PB14</td><td>Notch form selection 1</td></tr> <tr><td>2334</td><td>PB15</td><td>Machine resonance suppression filter 2</td></tr> <tr><td>2335</td><td>PB16</td><td>Notch form selection 2</td></tr> </tbody> </table>				Error code	Parameter No.	Name	2301	PA01	For manufacturer setting	2302	PA02	Regenerative brake option	2303	PA03	Absolute position detection system	2304	PA04	Function selection A-1	2305	PA05	For manufacturer setting	2306	PA06	For manufacturer setting	2307	PA07	For manufacturer setting	2308	PA08	Auto tuning mode	2309	PA09	Auto tuning response	2310	PA10	In-position range	2311	PA11	For manufacturer setting	2312	PA12	For manufacturer setting	2313	PA13	For manufacturer setting	2314	PA14	Rotation direction selection	2315	PA15	Encoder output pulse	2316	PA16	For manufacturer setting	2317	PA17	For manufacturer setting	2318	PA18	For manufacturer setting	2319	PA19	Parameter write inhibit	2320	PB01	Adaptive tuning mode	2321	PB02	Vibration suppression control filter tuning mode	2322	PB03	For manufacturer setting	2323	PB04	Feed forward gain	2324	PB05	For manufacturer setting	2325	PB06	Ratio of load inertia moment to servo motor inertia moment	2326	PB07	Model loop gain	2327	PB08	Position loop gain	2328	PB09	Speed loop gain	2329	PB10	Speed integral compensation	2330	PB11	Speed differential compensation	2331	PB12	For manufacturer setting	2332	PB13	Machine resonance suppression filter 1	2333	PB14	Notch form selection 1	2334	PB15	Machine resonance suppression filter 2	2335	PB16	Notch form selection 2
		Error code				Parameter No.	Name																																																																																																										
		2301				PA01	For manufacturer setting																																																																																																										
		2302				PA02	Regenerative brake option																																																																																																										
		2303				PA03	Absolute position detection system																																																																																																										
		2304				PA04	Function selection A-1																																																																																																										
		2305				PA05	For manufacturer setting																																																																																																										
		2306				PA06	For manufacturer setting																																																																																																										
		2307				PA07	For manufacturer setting																																																																																																										
		2308				PA08	Auto tuning mode																																																																																																										
		2309				PA09	Auto tuning response																																																																																																										
		2310				PA10	In-position range																																																																																																										
		2311				PA11	For manufacturer setting																																																																																																										
		2312				PA12	For manufacturer setting																																																																																																										
		2313				PA13	For manufacturer setting																																																																																																										
		2314				PA14	Rotation direction selection																																																																																																										
		2315				PA15	Encoder output pulse																																																																																																										
		2316				PA16	For manufacturer setting																																																																																																										
		2317				PA17	For manufacturer setting																																																																																																										
		2318				PA18	For manufacturer setting																																																																																																										
		2319				PA19	Parameter write inhibit																																																																																																										
		2320				PB01	Adaptive tuning mode																																																																																																										
		2321				PB02	Vibration suppression control filter tuning mode																																																																																																										
		2322				PB03	For manufacturer setting																																																																																																										
		2323				PB04	Feed forward gain																																																																																																										
		2324				PB05	For manufacturer setting																																																																																																										
		2325				PB06	Ratio of load inertia moment to servo motor inertia moment																																																																																																										
		2326				PB07	Model loop gain																																																																																																										
		2327				PB08	Position loop gain																																																																																																										
		2328				PB09	Speed loop gain																																																																																																										
		2329				PB10	Speed integral compensation																																																																																																										
		2330				PB11	Speed differential compensation																																																																																																										
		2331				PB12	For manufacturer setting																																																																																																										
		2332				PB13	Machine resonance suppression filter 1																																																																																																										
2333	PB14	Notch form selection 1																																																																																																															
2334	PB15	Machine resonance suppression filter 2																																																																																																															
2335	PB16	Notch form selection 2																																																																																																															

APPENDICES

Table 2.3 Servo error (2000 to 2899) list (Continued)

Error code	Error cause			Error check	Error processing	Corrective action	
	Name	Description					
2301 to 2599	Parameter error	Error code	Parameter No.	Name	Any time during operation	Operation continues	• Check the setting ranges of the servo parameters.
		2336	PB17	For manufacturer setting			
		2337	PB18	Low-pass filter			
		2338	PB19	Vibration suppression control vibration frequency setting			
		2339	PB20	Vibration suppression control resonance frequency setting			
		2340	PB21	For manufacturer setting			
		2341	PB22	For manufacturer setting			
		2342	PB23	Low-pass filter selection			
		2343	PB24	Slight vibration suppression control selection			
		2344	PB25	For manufacturer setting			
		2345	PB26	Gain changing selection			
		2346	PB27	Gain changing condition			
		2347	PB28	Gain changing time constant			
		2348	PB29	Gain changing ratio of load inertia moment to servo motor inertia moment			
		2349	PB30	Gain changing position loop gain			
		2350	PB31	Gain changing speed loop gain			
		2351	PB32	Gain changing speed integral compensation			
		2352	PB33	Gain changing vibration suppression control vibration frequency setting			
		2353	PB34	Gain changing vibration suppression control resonance frequency setting			
		2354	PB35	For manufacturer setting			
		2355	PB36	For manufacturer setting			
		2356	PB37	For manufacturer setting			
		2357	PB38	For manufacturer setting			
		2358	PB39	For manufacturer setting			
		2359	PB40	For manufacturer setting			
		2360	PB41	For manufacturer setting			
		2361	PB42	For manufacturer setting			
2362	PB43	For manufacturer setting					
2363	PB44	For manufacturer setting					
2364	PB45	For manufacturer setting					
2365	PC01	Error excessive alarm level					
2366	PC02	Electromagnetic brake sequence output					

APPENDICES

Table 2.3 Servo error (2000 to 2899) list (Continued)

Error code	Error cause			Error check	Error processing	Corrective action	
	Name	Description					
2301 to 2599	Parameter error	Error code	Parameter No.	Name	Any time during operation	Operation continues	• Check the setting ranges of the servo parameters.
		2367	PC03	Encoder output pulses selection			
		2368	PC04	Function selection C-1			
		2369	PC05	Function selection C-2			
		2370	PC06	For manufacturer setting			
		2371	PC07	Zero speed			
		2372	PC08	For manufacturer setting			
		2373	PC09	Analog monitor output 1			
		2374	PC10	Analog monitor output 2			
		2375	PC11	Analog monitor 1 offset			
		2376	PC12	Analog monitor 2 offset			
		2377	PC13	For manufacturer setting			
		2378	PC14	For manufacturer setting			
		2379	PC15	For manufacturer setting			
		2380	PC16	For manufacturer setting			
		2381	PC17	Function selection C-4			
		2382	PC18	For manufacturer setting			
		2383	PC19	For manufacturer setting			
		2384	PC20	For manufacturer setting			
		2385	PC21	Alarm history clear			
		2386	PC22	For manufacturer setting			
		2387	PC23	For manufacturer setting			
		2388	PC24	For manufacturer setting			
		2389	PC25	For manufacturer setting			
		2390	PC26	For manufacturer setting			
		2391	PC27	For manufacturer setting			
		2392	PC28	For manufacturer setting			
		2393	PC29	For manufacturer setting			
		2394	PC30	For manufacturer setting			
		2395	PC31	For manufacturer setting			
2396	PC32	For manufacturer setting					
2397	PD01	For manufacturer setting					
2398	PD02	For manufacturer setting					
2399	PD03	For manufacturer setting					
2400	PD04	For manufacturer setting					
2401	PD05	For manufacturer setting					
2402	PD06	For manufacturer setting					
2403	PD07	Output signal device selection 1					
2404	PD08	Output signal device selection 2					
2405	PD09	Output signal device selection 3					
2406	PD10	For manufacturer setting					

APPENDICES

Table 2.3 Servo error (2000 to 2899) list (Continued)

Error code	Error cause			Error check	Error processing	Corrective action	
	Name	Description					
2301 to 2599	Parameter error	Error code	Parameter No.	Name	Any time during operation	Operation continues	• Check the setting ranges of the servo parameters.
		2407	PD11	Input filter setting			
		2408	PD12	For manufacturer setting			
		2409	PD13	For manufacturer setting			
		2410	PD14	Function selection D-3			
		2411	PD15	For manufacturer setting			
		2412	PD16	For manufacturer setting			
		2413	PD17	For manufacturer setting			
		2414	PD18	For manufacturer setting			
		2415	PD19	For manufacturer setting			
		2416	PD20	For manufacturer setting			
		2417	PD21	For manufacturer setting			
		2418	PD22	For manufacturer setting			
		2419	PD23	For manufacturer setting			
		2420	PD24	For manufacturer setting			
		2421	PD25	For manufacturer setting			
		2422	PD26	For manufacturer setting			
		2423	PD27	For manufacturer setting			
2424	PD28	For manufacturer setting					
2425	PD29	For manufacturer setting					
2426	PD30	For manufacturer setting					
2427	PD31	For manufacturer setting					
2428	PD32	For manufacturer setting					

APPENDICES

Table 2.3 Servo error (2000 to 2899) list (Continued)

Error code	Error cause		Error check	Error processing	Corrective action																																																																																																												
	Name	Description																																																																																																															
2601 to 2899	Initial parameter error	Initial parameter error																																																																																																															
		<ul style="list-style-type: none"> The parameter setting is wrong. The parameter data was corrupted. 																																																																																																															
		<table border="1"> <thead> <tr> <th>Error code</th> <th>Parameter No.</th> <th>Name</th> </tr> </thead> <tbody> <tr><td>2601</td><td>PA01</td><td>For manufacturer setting</td></tr> <tr><td>2602</td><td>PA02</td><td>Regenerative brake option</td></tr> <tr><td>2603</td><td>PA03</td><td>Absolute position detection system</td></tr> <tr><td>2604</td><td>PA04</td><td>Function selection A-1</td></tr> <tr><td>2605</td><td>PA05</td><td>For manufacturer setting</td></tr> <tr><td>2606</td><td>PA06</td><td>For manufacturer setting</td></tr> <tr><td>2607</td><td>PA07</td><td>For manufacturer setting</td></tr> <tr><td>2608</td><td>PA08</td><td>Auto tuning mode</td></tr> <tr><td>2609</td><td>PA09</td><td>Auto tuning response</td></tr> <tr><td>2610</td><td>PA10</td><td>In-position range</td></tr> <tr><td>2611</td><td>PA11</td><td>For manufacturer setting</td></tr> <tr><td>2612</td><td>PA12</td><td>For manufacturer setting</td></tr> <tr><td>2613</td><td>PA13</td><td>For manufacturer setting</td></tr> <tr><td>2614</td><td>PA14</td><td>Rotation direction selection</td></tr> <tr><td>2615</td><td>PA15</td><td>Encoder output pulse</td></tr> <tr><td>2616</td><td>PA16</td><td>For manufacturer setting</td></tr> <tr><td>2617</td><td>PA17</td><td>For manufacturer setting</td></tr> <tr><td>2618</td><td>PA18</td><td>For manufacturer setting</td></tr> <tr><td>2619</td><td>PA19</td><td>Parameter write inhibit</td></tr> <tr><td>2620</td><td>PB01</td><td>Adaptive tuning mode</td></tr> <tr><td>2621</td><td>PB02</td><td>Vibration suppression control filter tuning mode</td></tr> <tr><td>2622</td><td>PB03</td><td>For manufacturer setting</td></tr> <tr><td>2623</td><td>PB04</td><td>Feed forward gain</td></tr> <tr><td>2624</td><td>PB05</td><td>For manufacturer setting</td></tr> <tr><td>2625</td><td>PB06</td><td>Ratio of load inertia moment to servo motor inertia moment</td></tr> <tr><td>2626</td><td>PB07</td><td>Model loop gain</td></tr> <tr><td>2627</td><td>PB08</td><td>Position loop gain</td></tr> <tr><td>2628</td><td>PB09</td><td>Speed loop gain</td></tr> <tr><td>2629</td><td>PB10</td><td>Speed integral compensation</td></tr> <tr><td>2630</td><td>PB11</td><td>Speed differential compensation</td></tr> <tr><td>2631</td><td>PB12</td><td>For manufacturer setting</td></tr> <tr><td>2632</td><td>PB13</td><td>Machine resonance suppression filter 1</td></tr> <tr><td>2633</td><td>PB14</td><td>Notch form selection 1</td></tr> <tr><td>2634</td><td>PB15</td><td>Machine resonance suppression filter 2</td></tr> <tr><td>2635</td><td>PB16</td><td>Notch form selection 2</td></tr> </tbody> </table>				Error code	Parameter No.	Name	2601	PA01	For manufacturer setting	2602	PA02	Regenerative brake option	2603	PA03	Absolute position detection system	2604	PA04	Function selection A-1	2605	PA05	For manufacturer setting	2606	PA06	For manufacturer setting	2607	PA07	For manufacturer setting	2608	PA08	Auto tuning mode	2609	PA09	Auto tuning response	2610	PA10	In-position range	2611	PA11	For manufacturer setting	2612	PA12	For manufacturer setting	2613	PA13	For manufacturer setting	2614	PA14	Rotation direction selection	2615	PA15	Encoder output pulse	2616	PA16	For manufacturer setting	2617	PA17	For manufacturer setting	2618	PA18	For manufacturer setting	2619	PA19	Parameter write inhibit	2620	PB01	Adaptive tuning mode	2621	PB02	Vibration suppression control filter tuning mode	2622	PB03	For manufacturer setting	2623	PB04	Feed forward gain	2624	PB05	For manufacturer setting	2625	PB06	Ratio of load inertia moment to servo motor inertia moment	2626	PB07	Model loop gain	2627	PB08	Position loop gain	2628	PB09	Speed loop gain	2629	PB10	Speed integral compensation	2630	PB11	Speed differential compensation	2631	PB12	For manufacturer setting	2632	PB13	Machine resonance suppression filter 1	2633	PB14	Notch form selection 1	2634	PB15	Machine resonance suppression filter 2	2635	PB16	Notch form selection 2
		Error code				Parameter No.	Name																																																																																																										
		2601				PA01	For manufacturer setting																																																																																																										
		2602				PA02	Regenerative brake option																																																																																																										
		2603				PA03	Absolute position detection system																																																																																																										
		2604				PA04	Function selection A-1																																																																																																										
		2605				PA05	For manufacturer setting																																																																																																										
		2606				PA06	For manufacturer setting																																																																																																										
		2607				PA07	For manufacturer setting																																																																																																										
		2608				PA08	Auto tuning mode																																																																																																										
		2609				PA09	Auto tuning response																																																																																																										
		2610				PA10	In-position range																																																																																																										
		2611				PA11	For manufacturer setting																																																																																																										
		2612				PA12	For manufacturer setting																																																																																																										
		2613				PA13	For manufacturer setting																																																																																																										
		2614				PA14	Rotation direction selection																																																																																																										
		2615				PA15	Encoder output pulse																																																																																																										
		2616				PA16	For manufacturer setting																																																																																																										
		2617				PA17	For manufacturer setting																																																																																																										
		2618				PA18	For manufacturer setting																																																																																																										
		2619				PA19	Parameter write inhibit																																																																																																										
		2620				PB01	Adaptive tuning mode																																																																																																										
		2621				PB02	Vibration suppression control filter tuning mode																																																																																																										
		2622				PB03	For manufacturer setting																																																																																																										
		2623				PB04	Feed forward gain																																																																																																										
		2624				PB05	For manufacturer setting																																																																																																										
		2625				PB06	Ratio of load inertia moment to servo motor inertia moment																																																																																																										
		2626				PB07	Model loop gain																																																																																																										
		2627				PB08	Position loop gain																																																																																																										
		2628				PB09	Speed loop gain																																																																																																										
		2629				PB10	Speed integral compensation																																																																																																										
		2630				PB11	Speed differential compensation																																																																																																										
		2631				PB12	For manufacturer setting																																																																																																										
2632	PB13	Machine resonance suppression filter 1																																																																																																															
2633	PB14	Notch form selection 1																																																																																																															
2634	PB15	Machine resonance suppression filter 2																																																																																																															
2635	PB16	Notch form selection 2																																																																																																															
		<ul style="list-style-type: none"> Servo amplifier power on. Multiple CPU system power on. 	Immediate stop	<ul style="list-style-type: none"> After checking and correcting of the parameter setting, turn off to on or reset the power of Multiple CPU system. 																																																																																																													

APPENDICES

Table 2.3 Servo error (2000 to 2899) list (Continued)

Error code	Error cause			Error check	Error processing	Corrective action	
	Name	Description					
2601 to 2899	Initial parameter error	Error code	Parameter No.	Name	<ul style="list-style-type: none"> • Servo amplifier power on. • Multiple CPU system power on. 	Immediate stop	<ul style="list-style-type: none"> • After checking and correcting of the parameter setting, turn off to on or reset the power of Multiple CPU system.
		2636	PB17	For manufacturer setting			
		2637	PB18	Low-pass filter			
		2638	PB19	Vibration suppression control vibration frequency setting			
		2639	PB20	Vibration suppression control resonance frequency setting			
		2640	PB21	For manufacturer setting			
		2641	PB22	For manufacturer setting			
		2642	PB23	Low-pass filter selection			
		2643	PB24	Slight vibration suppression control selection			
		2644	PB25	For manufacturer setting			
		2645	PB26	Gain changing selection			
		2646	PB27	Gain changing condition			
		2647	PB28	Gain changing time constant			
		2648	PB29	Gain changing ratio of load inertia moment to servo motor inertia moment			
		2649	PB30	Gain changing position loop gain			
		2650	PB31	Gain changing speed loop gain			
		2651	PB32	Gain changing speed integral compensation			
		2652	PB33	Gain changing vibration suppression control vibration frequency setting			
		2653	PB34	Gain changing vibration suppression control resonance frequency setting			
		2654	PB35	For manufacturer setting			
		2655	PB36	For manufacturer setting			
		2656	PB37	For manufacturer setting			
		2657	PB38	For manufacturer setting			
		2658	PB39	For manufacturer setting			
		2659	PB40	For manufacturer setting			
		2660	PB41	For manufacturer setting			
2661	PB42	For manufacturer setting					
2662	PB43	For manufacturer setting					
2663	PB44	For manufacturer setting					
2664	PB45	For manufacturer setting					
2665	PC01	Error excessive alarm level					
2666	PC02	Electromagnetic brake sequence output					

APPENDICES

Table 2.3 Servo error (2000 to 2899) list (Continued)

Error code	Error cause			Error check	Error processing	Corrective action	
	Name	Description					
2601 to 2899	Initial parameter error	Error code	Parameter No.	Name	<ul style="list-style-type: none"> • Servo amplifier power on. • Multiple CPU system power on. 	Immediate stop	<ul style="list-style-type: none"> • After checking and correcting of the parameter setting, turn off to on or reset the power of Multiple CPU system.
		2667	PC03	Encoder output pulses selection			
		2668	PC04	Function selection C-1			
		2669	PC05	Function selection C-2			
		2670	PC06	For manufacturer setting			
		2671	PC07	Zero speed			
		2672	PC08	For manufacturer setting			
		2673	PC09	Analog monitor output 1			
		2674	PC10	Analog monitor output 2			
		2675	PC11	Analog monitor 1 offset			
		2676	PC12	Analog monitor 2 offset			
		2677	PC13	For manufacturer setting			
		2678	PC14	For manufacturer setting			
		2679	PC15	For manufacturer setting			
		2680	PC16	For manufacturer setting			
		2681	PC17	Function selection C-4			
		2682	PC18	For manufacturer setting			
		2683	PC19	For manufacturer setting			
		2684	PC20	For manufacturer setting			
		2685	PC21	Alarm history clear			
		2686	PC22	For manufacturer setting			
		2687	PC23	For manufacturer setting			
		2688	PC24	For manufacturer setting			
		2689	PC25	For manufacturer setting			
		2690	PC26	For manufacturer setting			
		2691	PC27	For manufacturer setting			
		2692	PC28	For manufacturer setting			
		2693	PC29	For manufacturer setting			
		2694	PC30	For manufacturer setting			
		2695	PC31	For manufacturer setting			
2696	PC32	For manufacturer setting					
2697	PD01	For manufacturer setting					
2698	PD02	For manufacturer setting					
2699	PD03	For manufacturer setting					
2700	PD04	For manufacturer setting					
2701	PD05	For manufacturer setting					
2702	PD06	For manufacturer setting					
2703	PD07	Output signal device selection 1					
2704	PD08	Output signal device selection 2					
2705	PD09	Output signal device selection 3					
2706	PD10	For manufacturer setting					

APPENDICES

Table 2.3 Servo error (2000 to 2899) list (Continued)

Error code	Error cause			Error check	Error processing	Corrective action	
	Name	Description					
2601 to 2899	Initial parameter error	Error code	Parameter No.	Name	<ul style="list-style-type: none"> • Servo amplifier power on. • Multiple CPU system power on. 	Immediate stop	<ul style="list-style-type: none"> • After checking and correcting of the parameter setting, turn off to on or reset the power of Multiple CPU system.
		2707	PD11	Input filter setting			
		2708	PD12	For manufacturer setting			
		2709	PD13	For manufacturer setting			
		2710	PD14	Function selection D-3			
		2711	PD15	For manufacturer setting			
		2712	PD16	For manufacturer setting			
		2713	PD17	For manufacturer setting			
		2714	PD18	For manufacturer setting			
		2715	PD19	For manufacturer setting			
		2716	PD20	For manufacturer setting			
		2717	PD21	For manufacturer setting			
		2718	PD22	For manufacturer setting			
		2719	PD23	For manufacturer setting			
		2720	PD24	For manufacturer setting			
		2721	PD25	For manufacturer setting			
		2722	PD26	For manufacturer setting			
		2723	PD27	For manufacturer setting			
		2724	PD28	For manufacturer setting			
		2725	PD29	For manufacturer setting			
2726	PD30	For manufacturer setting					
2727	PD31	For manufacturer setting					
2728	PD32	For manufacturer setting					

APPENDICES

APPENDIX 2.6 PC link communication errors

Table 2.4 PC link communication error codes list

Error codes stored in D9196	Error description	Corrective action
01	<ul style="list-style-type: none"> A receiving packet for PC link communication does not arrive. The arrival timing of the receiving packet is too late. 	<ul style="list-style-type: none"> Check whether the power of PC has been turned on. Check the connection of the communication cable. Check the communication cable for wire breakage. Check whether the A□0BD-PCF/A30CD-PCF has been installed correctly.
02	<ul style="list-style-type: none"> A receiving packet CRC code is not right. 	<ul style="list-style-type: none"> Check whether there is a noise source near the PC. Check the connection of the communication cable. Check the communication cable for wire breakage.
03	<ul style="list-style-type: none"> A receiving packet data ID is not right. 	<ul style="list-style-type: none"> Check whether the A□0BD-PCF/A30CD-PCF has been installed correctly. Replace the A□0BD-PCF/A30CD-PCF.
04	<ul style="list-style-type: none"> The number of received frames is not right. 	<ul style="list-style-type: none"> Check whether there is a noise source near the PC. Check the connection of the communication cable. Check the communication cable for wire breakage.
05	<ul style="list-style-type: none"> A PC communication task does not start. 	<ul style="list-style-type: none"> Start the communication task for PC side.

APPENDICES

APPENDIX 2.7 Output Module Errors

(1) Output module errors at real/virtual mode switching (4000 to 5990)

Table 2.5 Output Module Error List (4000 to 5990)

Error class	Error code	Output module				Error cause	Processing	Corrective action
		Roller	Ball screw	Rotary table	Cam			
Minor error	4050				○	<ul style="list-style-type: none"> The "lower stroke limit setting device value + stroke amount setting device value" exceeded "2147483647 (setting unit)". (At the two-way cam mode.) 	Related system cannot be started.	<ul style="list-style-type: none"> Since the current value within 1 cam shaft revolution cannot be calculated, return to the real mode and set the correct No. in the device.
	4060	○	○	○	○	<ul style="list-style-type: none"> When the drive module is the synchronous encoder connected to the manual pulse generator inputs, and the connected clutch is the "external input mode", multiple ON/OFF command bit devices are set. Or, the external input mode clutch setting is fault. 		<ul style="list-style-type: none"> Set a one-to-one setting for the external input mode clutch and synchronous encoder. Return to the real mode, turn the PLC ready flag off, then correct and write the clutch setting.
	4070	○	○	○	○	<ul style="list-style-type: none"> The clutch of the external input mode is set at the Q173PX or Q172EX set for high-speed reading. 		<ul style="list-style-type: none"> Do not use the clutch of the external input mode at the Q173PX or Q172EX set for high-speed reading.
	5000		○	○	○	<ul style="list-style-type: none"> The "feed current value" is outside the stroke limit range. For cam, the feed current value is outside the range of "lower stroke limit value to stroke amount". (The current value within 1 cam shaft revolution cannot be calculated at the two-way cam mode.) 		<ul style="list-style-type: none"> Return to the real mode and position within the stroke limit range.
	5060				○	<ul style="list-style-type: none"> The "feed current value" is within the stroke limit range, but the current value within 1 cam shaft revolution cannot be calculated. (Cam table fault) 		<ul style="list-style-type: none"> Correct the cam table. Set the cam table by the stroke ratio "0 to 7FFFH" of lower stroke value and stroke amount.
	5080	○	○	○	○	<ul style="list-style-type: none"> Torque limit value setting outside range error. 	Control with the default value "300[%]".	<ul style="list-style-type: none"> Set the torque limit value within the setting range.
	5200				○	<ul style="list-style-type: none"> The first lower stroke limit value storage device is an odd number. 	Operation is possible, but monitoring is impossible.	<ul style="list-style-type: none"> Set an even number as the first device.
	5210	○	○	○	○	<ul style="list-style-type: none"> The first clutch ON address setting device is an odd number. 	Related system cannot be started.	
	5220	○	○	○	○	<ul style="list-style-type: none"> The first clutch OFF address setting device is an odd number. 		
	5230			○	○	<ul style="list-style-type: none"> The first current value within 1 virtual axis revolution storage device (main shaft side) is an odd number. 	Operation is possible, but monitoring is impossible.	
	5240			○	○	<ul style="list-style-type: none"> The first current value within 1 virtual axis revolution storage device (auxiliary input shaft side) is an odd number. 		
5250	○	○	○	○	<ul style="list-style-type: none"> When the amount of slip is set as the clutch smoothing method, the amount of slip setting device value is outside the range (0 to 2147483647). 	Amount of slip = 0 (control as the direct clutch).	<ul style="list-style-type: none"> Set a value within the range of 0 to 2147483647. 	

APPENDICES

Table 2.5 Output Module Error List (4000 to 5990) (Continued)

Error class	Error code	Output module				Error cause	Processing	Corrective action
		Roller	Ball screw	Rotary table	Cam			
Minor error	5260				<input type="radio"/>	• The device set to "Stroke amount setting device" is outside the range.	Related system cannot be started.	• Correct the device set to "Stroke amount setting device".
	5270				<input type="radio"/>	• The device set to "Cam No. setting device" is outside the range.		• Correct the device set to Cam No..
	5280	<input type="radio"/>	<input type="radio"/>	<input type="radio"/>	<input type="radio"/>	• The device set to "Clutch mode setting device" is outside the range.		• Correct the device set to clutch mode.
	5290	<input type="radio"/>	<input type="radio"/>	<input type="radio"/>	<input type="radio"/>	• The device set to "Clutch ON address setting device" is outside the range.		• Correct the device set to clutch ON address.
	5300	<input type="radio"/>	<input type="radio"/>	<input type="radio"/>	<input type="radio"/>	• The device set to "Clutch OFF address setting device" is outside the range.		• Correct the device set to clutch OFF address.
	5310	<input type="radio"/>	<input type="radio"/>	<input type="radio"/>	<input type="radio"/>	• The device set to "Clutch ON/OFF command setting device" is outside the range.		• Correct the device set to clutch ON/OFF command.
	5320	<input type="radio"/>	<input type="radio"/>	<input type="radio"/>	<input type="radio"/>	• The device set to "Speed change ratio setting device" is outside the range.		• Correct the device set to speed change ratio.
	5330	<input type="radio"/>	<input type="radio"/>	<input type="radio"/>	<input type="radio"/>	• The device set to "Amount of slip setting device" is outside the range.	Amount of slip = 0 (control as the direct clutch).	• Correct the device set to amount of slip.
	5340	<input type="radio"/>	<input type="radio"/>	<input type="radio"/>	<input type="radio"/>	• The device set to "Torque limit value setting device" is outside the range.	Control with the default value "300[%]".	• Correct the device set to torque limit value.
	5350			<input type="radio"/>	<input type="radio"/>	• The device set to "Current value within 1 virtual axis revolution storage device (main shaft side)" is outside the range.	Current value within 1 virtual axis revolution (main shaft side) cannot be monitored.	• Correct the device set to current value within 1 virtual axis revolution (main shaft side).
	5360			<input type="radio"/>	<input type="radio"/>	• The device set to "Current value within 1 virtual axis revolution storage device (auxiliary input axis side) storage device" is outside the range.	Current value within 1 virtual axis revolution (auxiliary input axis side) cannot be monitored.	• Correct the device set to current value within 1 virtual axis revolution (auxiliary input axis side).
	5370				<input type="radio"/>	• The device set to "Lower stroke limit value storage device" is outside the range.	Lower stroke limit value cannot be monitored.	• Correct the device set to lower stroke limit value.
	5380	<input type="radio"/>	<input type="radio"/>	<input type="radio"/>	<input type="radio"/>	• The device set to "Number of input axis side gear tooth count setting device" is outside the range.	Related system cannot be started.	• Correct the device set to number of input axis side gear tooth count.
	5390	<input type="radio"/>	<input type="radio"/>	<input type="radio"/>	<input type="radio"/>	• The device set to "Number of output axis side gear tooth count setting device" is outside the range.		• Correct the device set to number of output axis side gear tooth count.
	5400	<input type="radio"/>	<input type="radio"/>	<input type="radio"/>	<input type="radio"/>	• Number of input axis side gear tooth count setting device is set to "0".		• Correct the number of input axis side gear tooth count.
	5410	<input type="radio"/>	<input type="radio"/>	<input type="radio"/>	<input type="radio"/>	• Number of output axis side gear tooth count setting device is set to "0".		• Correct the number of output axis side gear tooth count.
5420	<input type="radio"/>	<input type="radio"/>	<input type="radio"/>	<input type="radio"/>	• The device set to "Slippage in-position range setting device" is outside the range.	Control with the setting value "0".		• Correct the device set to slippage in-position range setting device.
5430	<input type="radio"/>	<input type="radio"/>	<input type="radio"/>	<input type="radio"/>	• Slippage in-position range setting device is outside the range (0 to 2147483647).			
5440	<input type="radio"/>	<input type="radio"/>	<input type="radio"/>	<input type="radio"/>	• Either of "phase advance time", "phase compensation processing valid flag" or phase compensation time constant" of the phase compensation setting devices is outside the setting range.	Control as the phase compensation processing invalid.	• Correct the phase advance time. • Correct the phase compensation processing valid flag. • Correct the phase compensation time constant.	

APPENDICES

(2) "No-clutch/clutch ON/clutch status ON" output module errors (6000 to 6990)

Table 2.6 Output Module Error List (6000 to 6990)

Error class	Error code	Output module				Error cause	Processing	Corrective action
		Roller	Ball screw	Rotary table	Cam			
Minor error	6000	<input type="radio"/>	<input type="radio"/>	<input type="radio"/>	<input type="radio"/>	<ul style="list-style-type: none"> The servo OFF command (M3215+20n) turned on during operation. 	Operation continues.	<ul style="list-style-type: none"> Servo ON state continues. Execute the servo OFF after clutch OFF command.
	6010	<input type="radio"/>	<input type="radio"/>	<input type="radio"/>		<ul style="list-style-type: none"> The output speed exceeded the speed limit value during operation. (Speed clamp processing by the speed limit value is not executed.) 		<ul style="list-style-type: none"> Correct the speed, gear ratio and speed change ratio of drive module within the speed limit value.
	6020	<input type="radio"/>	<input type="radio"/>	<input type="radio"/>	<input type="radio"/>	<ul style="list-style-type: none"> The deviation counter value exceeded the permissible droop pulse value during operation. 		<ul style="list-style-type: none"> Correct the speed, gear ratio and speed change ratio of drive module within the permissible droop pulse value after stopping the drive module.
	6030		<input type="radio"/>	<input type="radio"/>		<ul style="list-style-type: none"> The feed current value exceeded the stroke limit range during operation. 		<ul style="list-style-type: none"> Control within the stroke limit value.
	6040				<input type="radio"/>	<ul style="list-style-type: none"> The cam No. setting device value is outside the "used cam No." range. (Operation continues with the current cam No.) 		<ul style="list-style-type: none"> Correct the cam No. setting.
	6050				<input type="radio"/>	<ul style="list-style-type: none"> The stroke amount setting device value is outside the range of "1 to 2147483647". "Lower stroke limit value + stroke amount \leq 2147483647" is outside the range. (Operation continues with the current stroke amount.) This error may occur during clutch OFF. 	Operation continues with the current cam No. and stroke amount.	<ul style="list-style-type: none"> Correct the stroke amount setting.
	6060				<input type="radio"/>	<ul style="list-style-type: none"> A control mode (feed/two-way) does not match at the cam No. switching. 		<ul style="list-style-type: none"> Correct the control mode after stopping the drive module.
	6080	<input type="radio"/>	<input type="radio"/>	<input type="radio"/>	<input type="radio"/>	<ul style="list-style-type: none"> The torque limit value setting device is outside the range. 	Control with the default value "300[%]".	<ul style="list-style-type: none"> Set the torque limit value within the setting range.
	6090	<input type="radio"/>	<input type="radio"/>	<input type="radio"/>	<input type="radio"/>	<ul style="list-style-type: none"> Although the servo OFF command (M3215+20n) is executed after the servo amplifier power on, the clutch ON command remains on, or the servo OFF is not executed in order to the no-clutch axis. 	Servo OFF is not executed.	<ul style="list-style-type: none"> Execute the servo OFF after clutch OFF command.
	6120				<input type="radio"/>	<ul style="list-style-type: none"> The current value within 1 cam axis revolution was changed to the outside the range. 	The current value is not changed.	<ul style="list-style-type: none"> Set a value within the range of 1 to "number of pulses 1 cam shaft revolution - 1".
	6130	<input type="radio"/>	<input type="radio"/>	<input type="radio"/>	<input type="radio"/>	<ul style="list-style-type: none"> Number of input axis side gear tooth count is set by indirect device setting, and the current value for the drive module was changed to the device value "0". 	The gear ratio of applicable gear is not changed.	<ul style="list-style-type: none"> Set the value within the range of 1 to 65535.
	6140	<input type="radio"/>	<input type="radio"/>	<input type="radio"/>	<input type="radio"/>	<ul style="list-style-type: none"> Number of output axis side gear tooth count is set by indirect device setting, and the current value for the drive module was changed to the device value "0". 		

APPENDICES

Table 2.6 Output Module Error List (6000 to 6990) (Continued)

Error class	Error code	Output module				Error cause	Processing	Corrective action
		Roller	Ball screw	Rotary table	Cam			
Minor error	6160				○	• Current value was changed for the axis that had not been started. Or, the current value within 1 cam shaft revolution was changed for the servo OFF axis.	Do not change the current value within 1 cam shaft revolution.	• Use the following device as interlock not to change the current value for applicable axis. (Servo READY signal (M2415+20) ON)
	6170	○	○	○	○	• Slippage in-position range setting device value is outside the range (0 to 2147483647).	Control with the setting value "0".	• Set the device value within the range of 0 to 2147483647.
	6020	○	○	○	○	• Phase compensation time constant is outside the range.	Control with the phase compensation time constant "0".	• Set the phase compensation time constant within the range of 0 to 32767 (times).

(3) Clutch OFF and clutch OFF command output module errors (6500 to 6990)

Table 2.7 Output Module Error List (6500 to 6990)

Error class	Error code	Output module				Error cause	Processing	Corrective action
		Roller	Ball screw	Rotary table	Cam			
Minor error	6500	○	○	○	○	• A servo OFF state at a clutch ON command.	Clutch remains OFF.	• Return to the clutch OFF command, and repeat the clutch ON command after executing a servo ON command.
	6530		○	○	○	• The home position return request signal (M2409+20n) is turning on at a clutch ON command. (Incremental axis servo amplifier power from off to ON.)		• Return to the real mode, back to the virtual mode after home position return.
	6540				○	• Although the feed current value is within the stroke limit value, the current value within 1 cam shaft revolution cannot be calculated. (Cam table error)	Servo remains ON.	• Return to the real mode, correct the cam data settings. • Set the cam table by the stroke ratio "0 to 7FFFH" of lower stroke value and stroke amount.

(4) System errors (9000 to 9990)

Table 2.8 Output Module Error List (9000 to 9990)

Error class	Error code	Output module				Error cause	Processing	Corrective action
		Roller	Ball screw	Rotary table	Cam			
Error class	9010	○	○	○	○	• The motor travel value while the power is off exceeded the "System setting mode-allowable travel value during power off" set in the system settings at the turning on of the servo amplifier.	Virtual mode continuation operation disable warning signal turns on. Further operation is possible.	• Check the position. • Check the battery of encoder.

APPENDICES

(5) Output module errors at virtual servomotor axis start (10000 to 10990)

Table 2.9 Output Module Error List (10000 to 10990)

Error class	Error code	Output module				Error cause	Processing	Corrective action
		Roller	Ball screw	Rotary table	Cam			
Major error	10000		○	○	○	• The home position return request signal (M2409+20n) is ON.	Related system cannot be start.	<ul style="list-style-type: none"> Return to the real mode and execute a home position return. If position is not established after executing a home position return at all axes, the virtual mode operation cannot be executed.
	10010	○	○	○	○	• The servo error detection signal (M2408+20n) is ON.		
	10020	○	○	○	○	• A servo OFF (M2415+20n OFF) status exists at an output module where a "clutch ON" or "no clutch" setting is set at either the main shaft or auxiliary input axis.		
	10030	○	○	○	○	• An external input signal (STOP) is turning on at an output module where a "clutch ON" or "no clutch" setting is set at either the main shaft or auxiliary input axis.		

(6) "No-clutch/clutch ON/clutch status ON" output module errors (11000 to 11990)

Table 2.10 Output Module Error List (11000 to 11990)

Error class	Error code	Output module				Error cause	Processing	Corrective action
		Roller	Ball screw	Rotary table	Cam			
Major error	11000	○	○	○	○	• The servo error detection signal (M2408+20n) turned on during operation.	After an immediate stop at the applicable output module, and the servo OFF state.	<ul style="list-style-type: none"> Release the servo error causes. (Refer to APPENDIX 2.5). When the "operation continuation" setting is set, execute the stop processing using the user's Motion SFC program.
	11010	○	○	○	○	<ul style="list-style-type: none"> A servo OFF state (M2415+20n OFF) during operation. Servo amplifier power supply was OFF. 		
	11020	○	○	○	○	• The stop signal (STOP) turned off.		
	11030	○	○	○	○	• The upper limit switch signal (FLS) turned off during forward (address increase direction) travel.		
	11040	○	○	○	○	• The lower limit switch signal (RLS) turned off during reverse (address decrease direction) travel.		

APPENDICES

(7) Errors when using an absolute position system (12000 to 12990)

Table 2.11 Output Module Error List (12000 to 12990)

Error class	Error code	Output module				Error cause	Processing	Corrective action
		Roller	Ball screw	Rotary table	Cam			
Major error	12010	○	○	○	○	<ul style="list-style-type: none"> A sum check error occurred in the back-up data (reference values) at the servo amplifier power supply on in the virtual mode. No home position return. 	Home position return signal turns on.	Executed the home position return in the real mode.
	12020	○	○	○	○	<ul style="list-style-type: none"> A communication error between the servo amplifier and encoder occurred at the servo amplifier power supply on. 		<ul style="list-style-type: none"> Check the motor and encoder cables and executed the home position return in the real mode again.
	12030	○	○	○	○	<ul style="list-style-type: none"> The amount of change in encoder current value during operation holds the following expression : "Amount of change in encoder current value / 3.5[ms] >180° of motor revolution" It is always checked after the servo amplifier power supply on (in both servo ON and OFF states). 	Home position return request ON.	<ul style="list-style-type: none"> Check the motor and encoder cables.
	12040	○	○	○	○	<ul style="list-style-type: none"> During operation, the following expression holds : "Encoder current value [PLS] ≠ feedback current value [PLS] (number of bits in encoder enable range)". It is always checked after the servo amplifier power supply on (in both servo ON and OFF states). 		

APPENDICES

APPENDIX 2.8 Errors at Real/Virtual Mode Switching

Table 2.12 Real/Virtual Mode Switching Error Code List

Error codes stored in D9193		Error description	Corrective action
Decimal display	Hexadecimal display		
1	0001	• Real/virtual mode switching request flag (M2043) turned OFF → ON in the state which all axes has not stopped.	• Turn real/virtual mode switching request flag (M2043) OFF → ON when start accept flag (M2001 to M2032) are all OFF.
256	0100	• Real/virtual mode switching request flag (M2043) turned ON → OFF in the state which all axes has not stopped.	• Turn real/virtual mode switching request flag (M2043) ON → OFF when start accept flag (M2001 to M2032) are all OFF.
512	0200	• Real/virtual mode switching request flag (M2043) turned OFF → ON in the state which mechanical system program has not registered.	• Write the mechanical system program to the Motion CPU.
		• Real/virtual mode switching request flag (M2043) turned OFF → ON in the state which the axis No. set in the system setting does not match the output axis No. set in the mechanical system program.	• Set the same axis No. at both the system settings and mechanical system program, then write the data to the Motion CPU.
513 ^(Note)	0201	• Real/virtual mode switching request flag (M2043) turned OFF → ON in the state which the PLC ready flag (M2000) or PCPU READY flag (M9074) is OFF.	• After turning the PLC ready flag and PCPU READY flags on, turn M2043 OFF → ON.
514 ^(Note)	0202	• Real/virtual mode switching request flag (M2043) turned OFF → ON in the state which the all-axes servo ON command (M2042) is OFF.	• Turn all axes servo ON command (M2042) on, turn the all-axes servo ON accept flag on, then turn real/virtual mode switching request flag (M2043) OFF → ON.
515 ^(Note)	0203	• Real/virtual mode switching request flag (M2043) turned OFF → ON in the state which the external forced stop input signal (EMG) is ON.	• Turn the external forced stop signal off, then turn real/virtual mode switching request flag (M2043) OFF → ON switching.
516 ^(Note)	0204	• Real/virtual mode switching request flag (M2043) turned OFF → ON during the servo start processing by the servo error reset command (M3208+20n).	• When the servo error reset is executed by turning servo error reset command (M3208+20n) on, turn the servo error detection signal (M2408+20n) off, then turn real/virtual mode switching request flag (M2043) OFF → ON.
768	0300	• Real/virtual mode switching request flag (M2043) turned OFF → ON in the state which the home position return signal is turning on for the output module is other than the roller.	• Execute the home position return (execute ZERO in the servo program), and turn real/virtual mode switching request flag (M2043) OFF → ON after home position return request signal (M2409+20n) has turned OFF.
1024	0400	• Real/virtual mode switching request flag (M2043) turned OFF → ON in the state (M2408+20n ON) of the servo error.	• Check the servo amplifier, servomotor and wiring, etc.
1280	0500	• Real/virtual mode switching request flag (M2043) turned OFF → ON in the state which the units set in the fixed parameter and output module are different for the output module is other than the roller.	• Correct the setting unit of the fixed parameter or output module, and write to the Motion CPU.
1536	0600	• Real/virtual mode switching request flag (M2043) turned OFF → ON in the state which cam data has not registered although the cam is set to the output module.	• Write the cam data to the Motion CPU.
2048	0800	• Real/virtual mode switching request flag (M2043) turned OFF → ON without the cam No. setting to the cam No. setting device. (Cam No. setting device is "0").	• Turn real/virtual mode switching request flag (M2043) OFF → ON after writing the cam No. set in the cam No. used of cam parameter to the cam No. setting device.

(Note) : Error axis No. information is not set to D9194, D9195 in this error.

APPENDICES

Table 2.12 Real/Virtual Mode Switching Error Code List (Continued)

Error codes stored in D9193		Error description	Corrective action
Decimal display	Hexadecimal display		
2304	0900	<ul style="list-style-type: none"> The setting value of cam stroke amount setting device is outside the range of 1 to $(2^{31}-1)$. 	<ul style="list-style-type: none"> Turn real/virtual mode switching request flag (M2043) OFF → ON after setting the value within the range of 1 to $(2^{31}-1)$ to the cam stroke amount setting device.
2816	0B00	<ul style="list-style-type: none"> The cam stroke amount setting device is not an even number. 	<ul style="list-style-type: none"> Set an even number to the cam stroke amount setting device.
3072	0C00	<ul style="list-style-type: none"> Setting for real mode axis is not correct. 	<ul style="list-style-type: none"> Execute "conversion and save" after setting real mode axis setting in the mechanical system program editor.
-4094 ^(Note)	F002	<ul style="list-style-type: none"> The PLC ready flag (M2000) turned off, and the system returned to the real mode during virtual mode operation. The Motion CPU stopped during virtual mode operation. 	<ul style="list-style-type: none"> Turn PLC ready flag (M2000) on. Set the Motion CPU "RUN" state.
-4095 ^(Note)	F001	<ul style="list-style-type: none"> The servo error detection signal (M2408+20n) turned off, and the system returned to the real mode during virtual mode operation. 	<ul style="list-style-type: none"> Check the servo error code register to determine the error cause at the axis in question, then release the error cause (Refer to APPENDIX 2.5).
-4096 ^(Note)	F000	<ul style="list-style-type: none"> The forced stop signal (EMG) turned on, and the system returned to the real mode. 	<ul style="list-style-type: none"> Turn the forced stop signal off.

(Note) : Error axis No. information is not set to D9194, D9195 in this error.

APPENDICES

APPENDIX 3 Special Relays/special registers

APPENDIX 3.1 Special relays

Special relays are internal relays whose applications are fixed in the Motion CPU. For this reason, they cannot be used in the same way as the normal internal relays by the Motion SFC programs.

However, they can be turned ON/OFF as needed in order to control the Motion CPU.

The headings in the table that follows have the following meanings.

Item	Explanation
No.	• Indicates the device No. of the special relay.
Name	• Indicates the name of the special relay.
Meaning	• Indicates the nature of the special relay.
Details	• Indicates detailed information about the nature of the special relay.
Set by (When set)	• Indicates whether the relay is set by the system or user, and, if it is set by system, when setting is performed. <Set by> S: Set by system (Motion CPU) U: Set by user (Motion SFC program or test operation using a peripheral device) S/U: Set by both system (Motion CPU) and user <When set> Indicated only if setting is done by system (Motion CPU). Main process: Set during each main processing (free time processing of the CPU) Initial process: Set only during initial processing (when power supply is turned ON, or when executed the reset) Status change : Set only when there is a change in status Error : Set when error is occurred. Request : Set only when there is a user request (Special relay, etc.) Operation cycle : Set during each operation cycle of the Motion CPU.

Table 3.1 Special relay list

No.	Name	Meaning	Details	Set by (When set)	Remark	
M9000	Fuse blown detection	OFF : Normal ON : Fuse blown module detected	• Turn on when there is one or more output modules control of self CPU which fuse has been blown. Remains on if normal status is restored.	S(Occur an error)		
M9005	AC/DC DOWN detection	OFF : AC/DC DOWN not detected ON : AC/DC DOWN detected	• Turn on if a momentary power interruption of less than 20[ms] occurred during use of the AC power supply module, and reset by turning power off to on. • Turn on if a momentary power interruption of less than 10[ms] occurred during use of the DC power supply module, and reset by turning power off to on.			
M9006	Battery low	OFF : Normal ON : Battery low	• Turned on when the voltage of the external battery reduces to less than specified value. Turn off when the voltage of the external battery becomes normal. • Synchronizes with "BAT. LED" • Check the voltage of the external battery, only when it is set with "external battery use" by system setting.			
M9007	Battery low latch	OFF : Normal ON : Battery low	• Turn on when the voltage of the external battery reduces to less than specified value. Remains on if normal status is restored. • Synchronizes with "BAT. LED" • Check the voltage of the external battery, only when it is set with "external battery use" by system setting.			
M9008	Self-diagnostic error	OFF : No error ON : Error	• Turn on when error is found as a result of self-diagnosis. Remains on if normal status is restored.			
M9010	Diagnostic error	OFF : No error ON : Error	• Turn on when error is found as a result of diagnosis. Remains on if normal status is restored.			
M9025	Clock data set request	OFF : Ignored ON : Set request present used	• Write clock data stored in D9025 to D9028 to the clock element when M9025 has changed from off to on.			U
M9026	Clock data error	OFF : No error ON : Error	• Turn on by clock data (D9025 to D9028) error.			S(Request)
M9028	Clock data read request	OFF : Ignored ON : Read request	• Read clock data from D9025 to D9028 in BCD when M9028 is on.	U		
M9036	Always ON	ON _____ OFF	• Turn on without regard to position of RUN/STOP switch on.	S(Main processing)		
M9037	Always OFF	ON _____ OFF _____	• Turn off without regard to position of RUN/STOP switch on.			
M9060	Error reset	OFF → ON : Error reset	• A release of the error is executed.	U		
M9073	PCPU WDT error flag	ON : Abnormal OFF : Normal	• Turn on when a "watchdog timer error" is detected by the Motion CPU self-diagnosis function. When the Motion CPU detects a WDT error, it executes an immediate stop without deceleration of the operating axes. • The error cause is stored in the "Motion CPU WDT error cause (D9184)".	S(Occur an error)		
M9074	PCPU READY complete flag	ON : PCPU READY completion OFF : PCPU READY uncompletion	• When the PLC ready flag (M2000) turn off to on, the fixed parameters, servo parameters and limit switch output data, etc., are checked, and if no error is detected this flag turns on. • Turn off when the PLC ready flag (M2000) turns off.	S(Request)		
M9075	Test mode ON flag	ON : TEST mode is in effect. OFF : TEST mode is not in effect.	• This flag status indicates whether a TEST mode established from a peripheral device is currently in effect. • If the TEST mode is not established in response to a TEST mode request from a peripheral device, the "TEST mode request error flag (M9078)" will turn on.	S(Request)		
M9076	External forced stop input flag	ON : Forced stop OFF OFF : Forced stop ON	• This flag status indicate whether the forced stop.	S(Operation cycle)		

Table 3.1 Special relay list (continued)

No.	Name	Meaning	Details	Set by (When set)	Remark
M9077	Manual pulse generator axis setting error flag	ON : At least one D714 to D719 setting is abnormal. OFF : All D714 to D719 settings are normal.	<ul style="list-style-type: none"> This flag indicates whether the setting designated at the manual pulse generator axis setting register (D714 to D719) is normal or abnormal. When this relay turns on, the error content is stored at the manual pulse generator axis setting error register (D9185 to D9187). 		
M9078	TEST mode request error flag	ON : Abnormal OFF : Normal	<ul style="list-style-type: none"> Turn on if the TEST mode is not established in response to a TEST mode request from a peripheral device. When this relay turns on, the error content is stored at the TEST mode request error register (D9182 to D9183). 	S(Occur an error)	
M9079	Servo program setting error flag	ON : Abnormal OFF : Normal	<ul style="list-style-type: none"> This flag status indicates whether the positioning data of the servo program(K) specified with the Motion SFC program is normal or abnormal, and if error is detected this flag turns on. The content of a servo program setting error is stored at D9189 and D9190. 		
M9216	CPU No.1 MULTR complete flag	OFF to ON : CPU No.1 read completion	<ul style="list-style-type: none"> Turn on when the data read from CPU No.1 is performed normally by MULTR instruction. 		
M9217	CPU No.2 MULTR complete flag	OFF to ON : CPU No.2 read completion	<ul style="list-style-type: none"> Turn on when the data read from CPU No.2 is performed normally by MULTR instruction. 		
M9218	CPU No.3 MULTR complete flag	OFF to ON : CPU No.3 read completion	<ul style="list-style-type: none"> Turn on when the data read from CPU No.3 is performed normally by MULTR instruction. 		S(Read completion)
M9219	CPU No.4 MULTR complete flag	OFF to ON : CPU No.4 read completion	<ul style="list-style-type: none"> Turn on when the data read from CPU No.4 is performed normally by MULTR instruction. 		
M9240	CPU No.1 reset flag	OFF : CPU No.1 reset release ON : CPU No.1 resetting	<ul style="list-style-type: none"> Turn off at reset release of the CPU No.1. Turn on during reset of the CPU No.1. (It also contains when a CPU is removed from the base unit.) The other CPU is also resetting. 		
M9241	CPU No.2 reset flag	OFF : CPU No.2 reset release ON : CPU No.2 resetting	<ul style="list-style-type: none"> Turn off at reset release of the CPU No.2. Turn on during reset of the CPU No.2. (It also contains when a CPU is removed from the base unit.) The error of the "MULTI CPU DOWN" (error code : 7000) occurs in the other CPU. 		
M9242	CPU No.3 reset flag	OFF : CPU No.3 reset release ON : CPU No.3 resetting	<ul style="list-style-type: none"> Turn off at reset release of the CPU No.3. Turn on during reset of the CPU No.3. (It also contains when a CPU is removed from the base unit.) The error of the "MULTI CPU DOWN" (error code : 7000) occurs in the other CPU. 		
M9243	CPU No.4 reset flag	OFF : CPU No.4 reset release ON : CPU No.4 resetting	<ul style="list-style-type: none"> Turn off at reset release of the CPU No.4. Turn on during reset of the CPU No.4. (It also contains when a CPU is removed from the base unit.) The error of the "MULTI CPU DOWN" (error code : 7000) occurs in the other CPU. 		S(Change status)
M9244	CPU No.1 error flag	OFF : CPU No.1 normal ON : On CPU No.1 stop error	<ul style="list-style-type: none"> Turn off when the CPU No.1 is normal. (It contains at continuation error.) Turn on during stop error of the CPU No.1. (Note-1) 		
M9245	CPU No.2 error flag	OFF : CPU No.2 normal ON : On CPU No.2 stop error	<ul style="list-style-type: none"> Turn off when the CPU No.2 is normal. (It contains at continuation error.) Turn on during stop error of the CPU No.2. (Note-1) 		
M9246	CPU No.3 error flag	OFF : CPU No.3 normal ON : On CPU No.3 stop error	<ul style="list-style-type: none"> Turn off when the CPU No.3 is normal. (It contains at continuation error.) Turn on during stop error of the CPU No.3. (Note-1) 		
M9247	CPU No.4 error flag	OFF : CPU No.4 normal ON : On CPU No.4 stop error	<ul style="list-style-type: none"> Turn off when the CPU No.4 is normal. (It contains at continuation error.) Turn on during stop error of the CPU No.4. (Note-1) 		

(Note-1): The CPU No.1 is reset after the factor of the stop error is removed to cancel a stop error. → Resetting is cancelled.

APPENDICES

APPENDIX 3.2 Special registers

Special registers are internal registers whose applications are fixed in the Motion CPU. For this reason, it is not possible to use these registers in Motion SFC programs in the same way that normal registers are used. However, data can be written as needed in order to control the Motion CPU. Data stored in the special registers are stored as BIN values if no special designation has been made to the contrary.

The headings in the table that follows have the following meanings.

Item	Explanation
Number	• Indicates the No. of the special register.
Name	• Indicates the name of the special register.
Meaning	• Indicates the nature of the special register.
Details	• Indicates detailed information about the nature of the special register.
Set by (When set)	<ul style="list-style-type: none"> • Indicates whether the register is set by the system or user, and, if it is set by system, when setting is performed. <Set by> <ul style="list-style-type: none"> S: Set by system (Motion CPU) U: Set by user (Motion SFC program or test operation using a peripheral device) S/U: Set by both system (Motion CPU) and user <When set> Indicated only if setting is done by system (Motion CPU). <ul style="list-style-type: none"> Main process: Set during each main processing (free time processing of the CPU) Initial process: Set only during initial processing (when power supply is turned ON, or when executed the reset) Status change : Set only when there is a change in status Error : Set when error is occurred. Request : Set only when there is a user request (Special relay, etc.) Operation cycle : Set during each operation cycle of the Motion CPU.

APPENDICES

Table 3.2 Special register list

No.	Name	Meaning	Details	Set by (When set)	Remark	
D9000	Fuse blown No.	Module No. with blown fuse	<ul style="list-style-type: none"> When fuse blown modules are detected, the lowest I/O module No. is stored in D9000. 	S(Occur an error)		
D9005	AC/DC DOWN counter No.	Number of times for AC/DC DOWN	<ul style="list-style-type: none"> 1 is added to the stored value each time the input voltage becomes 85[%] (AC power supply/65[%] DC power supply) or less of the rating while the CPU module is performing an operation, and the value is stored in BIN code. 			
D9008	Diagnostic error	Diagnostic error number	<ul style="list-style-type: none"> When error is found as a result of self-diagnosis, error No. is stored in BIN code. Refer to "2.4 Multiple CPU Error Codes" of the "Q173HCPU/Q172HCPU Motion Controller Programming Manual (COMMON)" for details of the error code. 			
D9010	Diagnostic error occurrence time	Diagnostic error occurrence time	<ul style="list-style-type: none"> The age (A.D, the rightmost two digits) when data on D9008 are updated, and the month stored with a BCD code two digits. <p style="text-align: center;"> B15 to B8 B7 to B0 Example : October 1995 Year(0 to 99) Month(1 to 12) H9510 </p>			
D9011			<ul style="list-style-type: none"> The day when data on D9008 are updated, and the hour stored with a BCD code two digits. <p style="text-align: center;"> B15 to B8 B7 to B0 Example : 25st, 10 a.m Day(1 to 31) Hour(0 to 23) H2510 </p>			
D9012			<ul style="list-style-type: none"> The minute when data on D9008 are updated, and the second stored with a BCD code two digits. <p style="text-align: center;"> B15 to B8 B7 to B0 Example : 35 min., 48 sec. Minute(0 to 59) Second(0 to 59) H3548 </p>			
D9013	Error information classification	Error information classification code	<ul style="list-style-type: none"> The classification code to judge the error information stored in the error information (D9014) is stored. The following codes are stored. <p>0: None 1: Module No./CPU No./Base No. 2: Parameter No.</p>			
D9014	Error information	Error information	<ul style="list-style-type: none"> Error information to comply with the diagnostic error (D9008) is stored. There are following two types information to be stored. <p>1) Module No./CPU No./Base No.</p> <ul style="list-style-type: none"> Module No. or CPU No. is stored according to the error which occurred in the case of the Multiple CPU system. (Refer to each error code which is stored.) CPU No.1: 1, CPU No.2: 2, CPU No.3: 3, CPU No.4: 4 <p>2) Parameter No.</p>			
D9015	Operating state of CPU	Operating state of CPU	<ul style="list-style-type: none"> The operation states of CPU as shown below are stored in D9015. <p style="text-align: center;"> B15 B12 B11 B8 B7 B4 B3 B0 </p> <div style="border: 1px solid black; padding: 5px; margin-top: 10px;"> <p>1) Operating state of CPU 0: RUN 2: STOP</p> <p>2) STOP cause 0: RUN/STOP switch 4: Error</p> <p>Note: Priority is earliest first</p> </div>			S(Main processing)
D9017	Scan time	Scan time (1ms units)	<ul style="list-style-type: none"> Main cycle is stored in the unit 1ms. Setting range (0 to 65535[ms]) 			
D9019	Maximum scan time	Maximum scan time (1ms units)	<ul style="list-style-type: none"> The maximum value of the main cycle is stored in the unit 1ms. Setting range (0 to 65535[ms]) 			
D9025	Clock data	Clock data (Year, month)	<ul style="list-style-type: none"> Stores the year (2 lower digits) and month in BCD. <p style="text-align: center;"> B15 to B12 B11 to B8 B7 to B4 B3 to B0 Example : July 1993 Year Month H9307 </p>			S/U(Request)

APPENDICES

Table 3.2 Special register list (continued)

No.	Name	Meaning	Details	Set by (When set)	Remark														
D9026	Clock data	Clock data (Day, hour)	<ul style="list-style-type: none"> Stores the day and hour in BCD. 	S/U(Request)															
D9027	Clock data	Clock data (Minute, second)	<ul style="list-style-type: none"> Stores the minute and second in BCD. 																
D9028	Clock data	Clock data (Day of week)	<ul style="list-style-type: none"> Stores the day of the week in BCD. <table border="1" style="margin-left: auto; margin-right: auto;"> <thead> <tr> <th colspan="2">Day of week</th> </tr> </thead> <tbody> <tr><td>0</td><td>Sunday</td></tr> <tr><td>1</td><td>Monday</td></tr> <tr><td>2</td><td>Tuesday</td></tr> <tr><td>3</td><td>Wednesday</td></tr> <tr><td>4</td><td>Thursday</td></tr> <tr><td>5</td><td>Friday</td></tr> <tr><td>6</td><td>Saturday</td></tr> </tbody> </table>			Day of week		0	Sunday	1	Monday	2	Tuesday	3	Wednesday	4	Thursday	5	Friday
Day of week																			
0	Sunday																		
1	Monday																		
2	Tuesday																		
3	Wednesday																		
4	Thursday																		
5	Friday																		
6	Saturday																		
D9060	Error reset	Error No. of releasing an error	<ul style="list-style-type: none"> Error No. of canceling error is stored. 	U															
D9061	Multiple CPU No.	Multiple CPU No.	<ul style="list-style-type: none"> CPU No. of the self CPU is stored. 	S(Initial processing)															
D9112	Connect/disconnect	Connect/disconnect of SSCNET	<ul style="list-style-type: none"> When the servo amplifier or SSCNET III cable of SSCNET system are exchanged or re-connected, an user side requires connect/disconnect, and a system side stores the states of command accept waiting or execute waiting for connect/disconnect. 	—															
			0 : Connect/disconnect command accept waiting	S (Main processing)															
			-1 : Connect/disconnect execute waiting																
			1 to 32 : Disconnect command	U															
-10 : Re-connect command																			
			-2 : Connect/disconnect execute command																
D9182	Test mode request error	It is operating in requirement error occurrence of the test mode, axis information	<ul style="list-style-type: none"> Each axis is stopping: 0/Operating: 1, information is stored as a bit data. D9182: b0 to b15 (Axis 1 to Axis 16) D9183: b0 to b15 (Axis 17 to Axis 32)	S(Occur an error)															
D9184	Motion CPU WDT error cause	Error meaning of WDT error occurs	The following error codes are stored in D9184. <ul style="list-style-type: none"> 1: S/W fault 1 2: Operation cycle over 3: Q bus WDT error 4: WDT error 30: Information processor H/W error 201 to 215: Q bus H/W fault 250 to 253: Servo amplifier interface H/W fault 300: S/W fault3 301: 15 CPSTART instructions of 8 or more points were started simultaneously. 																
D9185	Manual pulse generator axis setting error	Manual pulse generator axis setting error information	<ul style="list-style-type: none"> Contents of the manual pulse generator axis setting error is stored when the manual pulse generator axis setting error flag (M9077) turn on. (Normal: 0/Setting error: 1) D9185: The manual pulse generator axis setting error is stored in b0 to b2 (P1 to P3). The smoothing magnification setting is stored in b3 to b5 (P1 to P3). D9186: One pulse input magnification setting error is stored in b0 to b15 (axis 1 to axis 16). D9187: One pulse input magnification setting error is stored in b0 to b15 (axis 17 to axis 32).																

APPENDICES

Table 3.2 Special register list (continued)

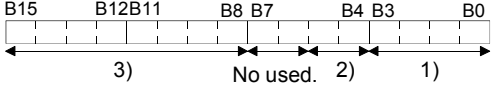
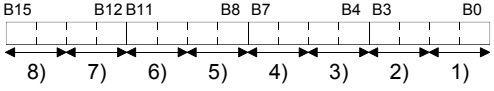
No.	Name	Meaning	Details	Set by (When set)	Remark
D9188	Motion operation cycle	Motion operation cycle	• The time when the motion operation cycle is stored in the [μs] unit.	S(Operation cycle)	
D9189	Error program No.	Error program No. of servo program	When the servo program setting error flag (M9079) turns on, the erroneous servo program No. will be stored.	S(Occur an error)	
D9190	Error item information	Error code of servo program	When the servo program setting error flag (M9079) turns on, the error code corresponding to the erroneous setting item will be stored.		
D9191 D9192	Servo amplifier loading information	Servo amplifier loading information	<ul style="list-style-type: none"> • The loading status (loading: 1/non-loading: 0) of the servo amplifier checked in initial process, and stored as the bit data. D9191: b0 to b15 (axis 1 to axis 16) D9192: b0 to b15 (axis 17 to axis 32) • The axis which turned from non-loading to loading status after power-on is handled as loaded. (However, the axis which turned from loading to non-loading status remains as loaded.) 	S(Initial processing)	
D9193 D9194 D9195	Real/virtual mode switching error information	Real/virtual mode Switching error code	• When a mode switching error occurs in real-to-virtual or virtual-to-real mode switching, or a mode continuation error occurs in the virtual mode, its error information is stored.	S(Occur an error)	
D9196	PC link communication error codes	PC link communication error codes	<ul style="list-style-type: none"> • The following error code is stored. 00: No error 01: Receiving timing error 02: CRC error 03: Communication response code error 04: Received frame error 05: Communication task start error (Each error code is reset to "00" when normal communication is restarted.) 		
D9197	Operation cycle of the Motion CPU setting	Operation cycle of the Motion CPU setting	• The time when the setting operation cycle is stored in the [μs] unit.	S(Initial processing)	
D9200	State of switch	State of CPU switch	<ul style="list-style-type: none"> • The CPU switch status is stored in the following format.  <div style="border: 1px solid black; padding: 5px; margin-top: 10px;"> <p>1) CPU switch status 0: RUN 1: STOP 2: L.CLR</p> <p>2) Memory card switch Always OFF</p> <p>3) Dip switch B8 through B12 correspond to SW1 through SW5 of system setting switch 1. 0: OFF/1: ON B13 through B15 is not used.</p> </div>	S(Main processing)	
D9201	State of LED	State of CPU-LED	<ul style="list-style-type: none"> • Information concerning which of the following states the LEDs on the CPU are in is stored in the following bit patterns. • 0 is off, 1 is on, and 2 is flicker  <p>1): RUN 5): BOOT 2): ERROR 6): No used 3): M.RUN 7): No used 4): BAT.ALARM 8): MODE</p> <p>Bit patterns for MODE 0: OFF 1: Green 2: Orange</p>	S(Change status)	

APPENDICES

APPENDIX 4 Setting Range for Indirect Setting Devices

Positioning address, command speed or M-code, etc. (excluding the axis No.) set in the servo program can be set indirectly by the word.

(1) Device range

The number of device words and device range at indirect setting are shown below.

	Item	Number of device words	Device setting range	Remarks														
Common	Address (travel value)	2	<table border="1"> <thead> <tr> <th>Device</th> <th>Range</th> </tr> </thead> <tbody> <tr> <td>D</td> <td>800 to 8191</td> </tr> <tr> <td>W</td> <td>0000 to 1FFF</td> </tr> <tr> <td>#</td> <td>0000 to 7999</td> </tr> </tbody> </table>	Device	Range	D	800 to 8191	W	0000 to 1FFF	#	0000 to 7999							
	Device	Range																
	D	800 to 8191																
	W	0000 to 1FFF																
	#	0000 to 7999																
	Command speed	2																
Dwell time	1																	
M-code	1																	
Torque limit value	1																	
Parameter block No.	1																	
Arc	Auxiliary point	2																
	Radius	2																
	Central point	2																
	Pitch	1																
Parameter block	Control unit	1																
	Speed limit value	2																
	Acceleration time	1																
	Deceleration time	1																
	Rapid stop deceleration time	1																
	Torque limit value	1																
	STOP input deceleration processing	1																
	Circular interpolation error allowance range	2																
	S-curve ratio	1																
Others	Program No.	1			Simultaneous start													
	Command speed (Constant speed)	2																
	FIN acceleration/deceleration	1																
	Fixed position stop acceleration/deceleration time	1																
	Repetition condition (Number of repetitions)	1																
	Repetition condition (ON/OFF)	Bit	<table border="1"> <thead> <tr> <th>Device</th> <th>Range</th> </tr> </thead> <tbody> <tr> <td>X</td> <td>0000 to 1FFF</td> </tr> <tr> <td>Y</td> <td>0000 to 1FFF</td> </tr> <tr> <td>M/L</td> <td>0 to 8191</td> </tr> <tr> <td>Special relay</td> <td>9000 to 9255</td> </tr> <tr> <td>B</td> <td>0000 to 1FFF</td> </tr> <tr> <td>F</td> <td>0 to 2047</td> </tr> </tbody> </table>	Device	Range	X	0000 to 1FFF	Y	0000 to 1FFF	M/L	0 to 8191	Special relay	9000 to 9255	B	0000 to 1FFF	F	0 to 2047	
	Device			Range														
	X			0000 to 1FFF														
	Y			0000 to 1FFF														
	M/L			0 to 8191														
Special relay	9000 to 9255																	
B	0000 to 1FFF																	
F	0 to 2047																	
Cancel																		
Skip																		
WAIT ON/OFF																		
Fixed position stop																		

(Note): Synchronous encoder axis area cannot be set.

POINT

Be sure to set even-numbered devices for 2-word setting items.

Be sure to set as 32-bit integer type when the data is set in these devices using the Motion SFC programs. (Example : #0L, D0L)

APPENDICES

(2) Inputting device data

Indirect setting device data is inputted by the Motion CPU at the servo program start.

Do not change the applicable device before setting to device and start completion.

The procedures by start method for setting data to devices and cautions are shown below.

Start method	Setting method	Notes
Start by the servo program	Set data in indirect setting devices. ↓ Start the servo program.	Do not change the indirect setting device before the "positioning start complete signal" of the starting axis turns on.
Set the loop (FOR - NEXT) point data for CPSTART instruction indirectly	Set initial command data in the indirect setting device. ↓ Start using the servo program (or turn the cancel command device on). ↓ Read the value of "data set pointer for constant-speed control" of the start axis, and update the data input by Motion CPU.	Refer to the positioning signal data register "Monitoring data area" for details.

APPENDICES

APPENDIX 5 Processing Times of the Motion CPU

The processing time of each signal and each instruction for positioning control in the Multiple CPU system is shown below.

(1) Motion operation cycle [ms] (Default)

	Q173HCPU				Q172HCPU	
	1 to 5	6 to 14	15 to 28	29 to 32	1 to 5	6 to 8
Operation cycle [ms]	0.88	1.77	3.55	7.11	0.88	1.77

(2) CPU processing time [ms]

Operation cycle		Q173HCPU					Q172HCPU		
		0.44	0.88	1.77	3.55	7.11	0.44	0.88	1.77
Servo program start processing time (Note-1)	"WAIT ON/OFF" + Motion control step	0.8 to 1.0	1.1 to 1.6	2.5 to 3.2	4.3 to 6.0	8.1 to 11.1	0.8 to 1.0	1.1 to 1.6	2.5 to 3.2
	Only Motion control step	1.0 to 1.6	1.8 to 2.3	3.0 to 3.9	4.8 to 6.6	9.4 to 11.5	1.0 to 1.6	1.8 to 2.3	3.0 to 3.9
Speed change response		0.9 to 1.2	1.2 to 2.0	2.8 to 3.6	4.5 to 5.9	8.5 to 11.0	0.9 to 1.2	1.2 to 2.0	2.8 to 3.6
Simultaneous start processing time (Note-2)		0.9 to 1.6	1.7 to 2.5	3.5 to 4.2	5.0 to 6.5	8.6 to 12.0	0.9 to 1.6	1.7 to 2.5	3.5 to 4.2
Time from PLC ready flag (M2000) ON to PCPU ready flag (M9074) ON		39 to 433							

(Note-1): FEED instruction varies greatly depending on the condition (whether other axes are operating or being stopped).

(Note-2): This processing time varies depending on the simultaneous start command. Use this time merely for reference.

(Note-3): If the servo amplifiers of 9 axes or more are connected to one SSCNET III system, it does not support an operation cycle of 0.4[ms]. 0.8[ms] is used as the real operation cycle, even if 0.4[ms] is set in the system setting.

(3) Virtual servomotor axis/synchronous encoder axis operation cycle [ms] (Default)

	Q173HCPU				Q172HCPU	
	1 to 5	6 to 14	15 to 28	29 to 32	1 to 5	6 to 8
Virtual servomotor [ms]	0.88	1.77	3.55	7.11	0.88	1.77
Synchronous encoder [ms]	0.88	1.77	3.55	7.11	0.88	1.77

APPENDICES

(4) Axis status list

Axis No.	Device No.	Signal name										
		Signal name	Real	Virtual					Refresh cycle	Fetch cycle	Signal direction	
Roller	Ball screw			Rotary table	Cam	Real Mode axis						
1	M2400 to M2419											
2	M2420 to M2439											
3	M2440 to M2459											
4	M2460 to M2479											
5	M2480 to M2499											
6	M2500 to M2519	0		OFF					Operation cycle	Immediately	Status signal	
7	M2520 to M2539	1		OFF								
8	M2540 to M2559	2		○								
9	M2560 to M2579	3		OFF								
10	M2580 to M2599	4		OFF								
11	M2600 to M2619	5		OFF								
12	M2620 to M2639	6		OFF								
13	M2640 to M2659	7		OFF								
14	M2660 to M2679	8	○									Operation cycle
15	M2680 to M2699	9										Main cycle
16	M2700 to M2719	10		○					Operation cycle			
17	M2720 to M2739	11							Main cycle			
18	M2740 to M2759	12										
19	M2760 to M2779	13										
20	M2780 to M2799	14										
21	M2800 to M2819	15							Operation cycle			
22	M2820 to M2839	16							Operation cycle			
23	M2840 to M2859	17	—	—					—	—	—	
24	M2860 to M2879	18		○					At virtual mode transition	Status signal		
25	M2880 to M2899	19	○	OFF								
26	M2900 to M2919								Operation cycle			
27	M2920 to M2939											
28	M2940 to M2959											
29	M2960 to M2979											
30	M2980 to M2999											
31	M3000 to M3019											
32	M3020 to M3039											

○ : Valid

(Note-1) : It is unusable in the SV22 real mode.

(Note-2) : The range of axis No.1 to 8 is valid in the Q172HCPU.

(Note-3) : Device area of 9 axes or more is unusable in the Q172HCPU.

APPENDICES

(5) Axis command signal list

Axis No.	Device No.	Signal name								
		Signal name	Real	Virtual				Refresh cycle	Fetch cycle	Signal direction
Roller	Ball screw			Rotary table	Cam	Real mode axis				
1	M3200 to M3219									
2	M3220 to M3239									
3	M3240 to M3259									
4	M3260 to M3279									
5	M3280 to M3299									
6	M3300 to M3319	0	Stop command						Operation cycle	Command signal
7	M3320 to M3339	1	Rapid stop command						Main cycle	
8	M3340 to M3359	2	Forward rotation JOG start command					Operation cycle		
9	M3360 to M3379	3	Reverse rotation JOG start command	○		×				
10	M3380 to M3399	4	Complete signal OFF command							
11	M3400 to M3419	5	Speed/position switching enable command							
12	M3420 to M3439	6	Unusable	—		—		—		
13	M3440 to M3459	7	Error reset command							
14	M3460 to M3479	8	Servo error reset command	○		○			Main cycle	Command signal
15	M3480 to M3499	9	External stop input disable at start command			×			At start	
16	M3500 to M3519	10	Unusable	—		—		—		
17	M3520 to M3539	11	Unusable	—		—		—		
18	M3540 to M3559	12	Feed current value update request command	○		×			At start	Command signal
19	M3560 to M3579	13	Address clutch reference setting command (Note-1)		×		○		At virtual mode transition	
20	M3580 to M3599	14	Cam reference position setting command (Note-1)	×		×		○	×	
21	M3600 to M3619	15	Servo OFF command						Operation cycle	
22	M3620 to M3639	16	Gain changing command	○		○		○	Operation cycle (Note-4)	
23	M3640 to M3659	17	Unusable	—		—		—		
24	M3660 to M3679	18	Control loop changing command							
25	M3680 to M3699	19	FIN signal	○		×		○	Operation cycle	Command signal

○ : Valid, × : Invalid

(Note-1) : It is unusable in the SV22 real mode.

(Note-2) : The range of axis No.1 to 8 is valid in the Q172HCPU.

(Note-3) : Device area of 9 axes or more is unusable in the Q172HCPU.

(Note-4) : Operation cycle 7.1[ms] or more: Every 3.5[ms]

APPENDICES

(6) Virtual servomotor axis status list

Axis No.	Device No.	Signal name									
		Signal name	Real	Virtual					Refresh cycle	Fetch cycle	Signal direction
				Roller	Ball screw	Rotary table	Cam	Real mode axis			
1	M4000 to M4019										
2	M4020 to M4039										
3	M4040 to M4059										
4	M4060 to M4079										
5	M4080 to M4099										
6	M4100 to M4119	0 Positioning start complete	Backup		○			×	Operation cycle	/	Status signal
7	M4120 to M4139	1 Positioning complete									
8	M4140 to M4159	2 Unusable	—		—		—	—	—	—	
9	M4160 to M4179	3 Command in-position	Backup		○			×	Operation cycle	/	Status signal
10	M4180 to M4199	4 Speed controlling									
11	M4200 to M4219	5 Unusable	—		—		—	—	—	—	
12	M4220 to M4239	6 Unusable	—		—		—	—	—	—	
13	M4240 to M4259	7 Error detection	Backup		○			×	Immediately	/	Status signal
14	M4260 to M4279	8 Unusable									
15	M4280 to M4299	9 Unusable	—		—		—	—	—	—	
16	M4300 to M4319	10 Unusable	—		—		—	—	—	—	
17	M4320 to M4339	11 Unusable	—		—		—	—	—	—	
18	M4340 to M4359	12 Unusable	—		—		—	—	—	—	
19	M4360 to M4379	13 Unusable	—		—		—	—	—	—	
20	M4380 to M4399	14 Unusable	—		—		—	—	—	—	
21	M4400 to M4419	15 Unusable	—		—		—	—	—	—	
22	M4420 to M4439	16 Unusable	—		—		—	—	—	—	
23	M4440 to M4459	17 Unusable	—		—		—	—	—	—	
24	M4460 to M4479	18 Unusable	—		—		—	—	—	—	
25	M4480 to M4499	19 M-code outputting signal	Backup		○			×	Operation cycle	/	Status signal
26	M4500 to M4519	20 Unusable									
27	M4520 to M4539	21 Unusable	—		—		—	—	—	—	
28	M4540 to M4559	22 Unusable	—		—		—	—	—	—	
29	M4560 to M4579	23 Unusable	—		—		—	—	—	—	
30	M4580 to M4599	24 Unusable	—		—		—	—	—	—	
31	M4600 to M4619	25 Unusable	—		—		—	—	—	—	
32	M4620 to M4639	26 Unusable	—		—		—	—	—	—	

○ : Valid, × : Invalid

(Note-1) : The range of axis No.1 to 8 is valid in the Q172HCPU.

(Note-2) : The unused axis areas in the mechanical system program can be used as an user device.

APPENDICES

(7) Virtual servomotor axis command signal list

Axis No.	Device No.	Signal name									
		Signal name	Real	Virtual				Refresh cycle	Fetch cycle	Signal direction	
				Roller	Ball screw	Rotary table	Cam				Real mode axis
1	M4800 to M4819										
2	M4820 to M4839										
3	M4840 to M4859										
4	M4860 to M4879										
5	M4880 to M4899										
6	M4900 to M4919	0 Stop command	×		○		×	/	Operation cycle		
7	M4920 to M4939	1 Rapid stop command									
8	M4940 to M4959	2 Forward rotation JOG start command									
9	M4960 to M4979	3 Reverse rotation JOG start command									
10	M4980 to M4999	4 Complete signal OFF command									
11	M5000 to M5019	5 Unusable	—	—	—	—	—	—	—	—	
12	M5020 to M5039	6 Unusable	—	—	—	—	—	—	—	—	
13	M5040 to M5059	7 Error reset command	×		○		×	/	Main cycle	Command signal	
14	M5060 to M5079	8 Unusable	—	—	—	—	—	—	—	—	
15	M5080 to M5099	9 External stop input disable at start command	×		○		×	/	At start	Command signal	
16	M5100 to M5119	10 Unusable	—	—	—	—	—	—	—	—	
17	M5120 to M5139	11 Unusable	—	—	—	—	—	—	—	—	
18	M5140 to M5159	12 Unusable	—	—	—	—	—	—	—	—	
19	M5160 to M5179	13 Unusable	—	—	—	—	—	—	—	—	
20	M5180 to M5199	14 Unusable	—	—	—	—	—	—	—	—	
21	M5200 to M5219	15 Unusable	—	—	—	—	—	—	—	—	
22	M5220 to M5239	16 Unusable	—	—	—	—	—	—	—	—	
23	M5240 to M5259	17 Unusable	—	—	—	—	—	—	—	—	
24	M5260 to M5279	18 Unusable	—	—	—	—	—	—	—	—	
25	M5280 to M5299	19 FIN signal	×		○		×	/	Operation cycle	Command signal	
26	M5300 to M5319										
27	M5320 to M5339										
28	M5340 to M5359										
29	M5360 to M5379										
30	M5380 to M5399										
31	M5400 to M5419										
32	M5420 to M5439										

○ : Valid, × : Invalid

(Note-1) : The range of axis No.1 to 8 is valid in the Q172HCPU.

(Note-2) : The unused axis areas in the mechanical system program can be used as an user device.

APPENDICES

(8) Synchronous encoder axis status list

Axis No.	Device No.	Signal name																					
1	M4640 to M4643	<table border="1"> <thead> <tr> <th>Signal name</th> <th>Real</th> <th>Virtual</th> <th>Refresh cycle</th> <th>Fetch cycle</th> <th>Signal direction</th> </tr> </thead> <tbody> <tr> <td>0 Error detection</td> <td rowspan="3">○</td> <td rowspan="3">○</td> <td>Immediately</td> <td rowspan="3">/</td> <td rowspan="3">Status signal</td> </tr> <tr> <td>1 External signal TREN</td> <td rowspan="2">Main cycle</td> </tr> <tr> <td>2 Virtual mode continuation operation disable warning</td> </tr> <tr> <td>3 Unusable</td> <td>—</td> <td>—</td> <td>—</td> <td>—</td> <td>—</td> </tr> </tbody> </table>	Signal name	Real	Virtual	Refresh cycle	Fetch cycle	Signal direction	0 Error detection	○	○	Immediately	/	Status signal	1 External signal TREN	Main cycle	2 Virtual mode continuation operation disable warning	3 Unusable	—	—	—	—	—
Signal name	Real		Virtual	Refresh cycle	Fetch cycle	Signal direction																	
0 Error detection	○		○	Immediately	/	Status signal																	
1 External signal TREN				Main cycle																			
2 Virtual mode continuation operation disable warning																							
3 Unusable	—		—	—	—	—																	
2	M4644 to M4647																						
3	M4648 to M4651																						
4	M4652 to M4655																						
5	M4656 to M4659																						
6	M4660 to M4663																						
7	M4664 to M4667																						
8	M4668 to M4671																						
9	M4672 to M4675																						
10	M4676 to M4679																						
11	M4680 to M4683																						
12	M4684 to M4687																						

○ : Valid

(Note-1) : The range of axis No.1 to 8 is valid in the Q172HCPU.

(Note-2) : Device area of 9 axes or more is unusable in the Q172HCPU.

(9) Synchronous encoder axis command signal list

Axis No.	Device No.	Signal name																				
1	M5440 to M5443	<table border="1"> <thead> <tr> <th>Signal name</th> <th>Real</th> <th>Virtual</th> <th>Refresh cycle</th> <th>Fetch cycle</th> <th>Signal direction</th> </tr> </thead> <tbody> <tr> <td>0 Error reset</td> <td>×</td> <td>○</td> <td>/</td> <td>Main cycle</td> <td>Status signal</td> </tr> <tr> <td>1</td> <td rowspan="3">Unusable</td> <td rowspan="3">—</td> <td rowspan="3">—</td> <td rowspan="3">—</td> <td rowspan="3">—</td> </tr> <tr> <td>2</td> </tr> <tr> <td>3</td> </tr> </tbody> </table>	Signal name	Real	Virtual	Refresh cycle	Fetch cycle	Signal direction	0 Error reset	×	○	/	Main cycle	Status signal	1	Unusable	—	—	—	—	2	3
Signal name	Real		Virtual	Refresh cycle	Fetch cycle	Signal direction																
0 Error reset	×		○	/	Main cycle	Status signal																
1	Unusable		—	—	—	—																
2																						
3																						
2	M5444 to M5447																					
3	M5448 to M5451																					
4	M5452 to M5455																					
5	M5456 to M5459																					
6	M5460 to M5463																					
7	M5464 to M5467																					
8	M5468 to M5471																					
9	M5472 to M5475																					
10	M5476 to M5479																					
11	M5480 to M5483																					
12	M5484 to M5487																					

○ : Valid, × : Invalid

(Note-1) : The range of axis No.1 to 8 is valid in the Q172HCPU.

(Note-2) : Device area of 9 axes or more is unusable in the Q172HCPU.

APPENDICES

(10) Cam axis command signal list

Device No.	Signal name	Refresh cycle	Fetch cycle	Signal direction	Remark
M5488	Axis-1 cam/ball screw switching		Main cycle	Command signal	
M5489	Axis-2 cam/ball screw switching				
M5490	Axis-3 cam/ball screw switching				
M5491	Axis-4 cam/ball screw switching				
M5492	Axis-5 cam/ball screw switching				
M5493	Axis-6 cam/ball screw switching				
M5494	Axis-7 cam/ball screw switching				
M5495	Axis-8 cam/ball screw switching				
M5496	Axis-9 cam/ball screw switching				
M5497	Axis-10 cam/ball screw switching				
M5498	Axis-11 cam/ball screw switching				
M5499	Axis-12 cam/ball screw switching				
M5500	Axis-13 cam/ball screw switching				
M5501	Axis-14 cam/ball screw switching				
M5502	Axis-15 cam/ball screw switching				
M5503	Axis-16 cam/ball screw switching				
M5504	Axis-17 cam/ball screw switching				
M5505	Axis-18 cam/ball screw switching				
M5506	Axis-19 cam/ball screw switching				
M5507	Axis-20 cam/ball screw switching				
M5508	Axis-21 cam/ball screw switching				
M5509	Axis-22 cam/ball screw switching				
M5510	Axis-23 cam/ball screw switching				
M5511	Axis-24 cam/ball screw switching				
M5512	Axis-25 cam/ball screw switching				
M5513	Axis-26 cam/ball screw switching				
M5514	Axis-27 cam/ball screw switching				
M5515	Axis-28 cam/ball screw switching				
M5516	Axis-29 cam/ball screw switching				
M5517	Axis-30 cam/ball screw switching				
M5518	Axis-31 cam/ball screw switching				
M5519	Axis-32 cam/ball screw switching				

(Note-1) : The range of axis No.1 to 8 is valid in the Q172HCPU.

(Note-2) : Device area of 9 axes or more is unusable in the Q172HCPU.

(Note-3) : Unused axis of cam axis command signal can be used as an user device.

APPENDICES

(11) Smoothing clutch complete signal list

Device No.	Signal name	Refresh cycle	Fetch cycle	Signal direction	Remark	
M5520	Output axis 1	Operation cycle		Status signal		
M5521						Main shaft side
M5522	Auxiliary input side					
M5523	Output axis 2					Main shaft side
M5524						Auxiliary input side
M5525	Output axis 3					Main shaft side
M5526						Auxiliary input side
M5527	Output axis 4					Main shaft side
M5528						Auxiliary input side
M5529	Output axis 5					Main shaft side
M5530						Auxiliary input side
M5531	Output axis 6					Main shaft side
M5532						Auxiliary input side
M5533	Output axis 7					Main shaft side
M5534						Auxiliary input side
M5535	Output axis 8					Main shaft side
M5536						Auxiliary input side
M5537	Output axis 9					Main shaft side
M5538						Auxiliary input side
M5539	Output axis 10					Main shaft side
M5540						Auxiliary input side
M5541	Output axis 11					Main shaft side
M5542						Auxiliary input side
M5543	Output axis 12					Main shaft side
M5544						Auxiliary input side
M5545	Output axis 13					Main shaft side
M5546						Auxiliary input side
M5547	Output axis 14					Main shaft side
M5548						Auxiliary input side
M5549	Output axis 15					Main shaft side
M5550						Auxiliary input side
M5551	Output axis 16					Main shaft side
M5552		Auxiliary input side				
M5553	Output axis 17	Main shaft side				
M5554		Auxiliary input side				
M5555	Output axis 18	Main shaft side				
M5556		Auxiliary input side				
M5557	Output axis 19	Main shaft side				
M5558		Auxiliary input side				
M5559	Output axis 20	Main shaft side				
M5560		Auxiliary input side				
M5561	Output axis 21	Main shaft side				
M5562		Auxiliary input side				
M5563	Output axis 22	Main shaft side				
M5564		Auxiliary input side				
M5565	Output axis 23	Main shaft side				
M5566		Auxiliary input side				
M5567	Output axis 24	Main shaft side				
M5568		Auxiliary input side				
M5569	Output axis 25	Main shaft side				
M5570		Auxiliary input side				
M5571	Output axis 26	Main shaft side				
M5572		Auxiliary input side				
M5573	Output axis 27	Main shaft side				
M5574		Auxiliary input side				
M5575	Output axis 28	Main shaft side				
M5576		Auxiliary input side				
M5577	Output axis 29	Main shaft side				
M5578		Auxiliary input side				
M5579	Output axis 30	Main shaft side				
M5580		Auxiliary input side				
M5581	Output axis 31	Main shaft side				
M5582		Auxiliary input side				
M5583	Output axis 32	Main shaft side				
		Auxiliary input side				

(Note-1) : The range of axis No.1 to 8 is valid in the Q172HCPU.

(Note-2) : Device area of 9 axes or more is unusable in the Q172HCPU.

(Note-3) : Unused axis of mechanical system program can be used as an user device.

APPENDICES

(12) Common device list

Device No.	Signal name	Refresh cycle	Fetch cycle	Signal direction	Remark (Note-5)
M2000	PLC ready flag	/	Main cycle	Command signal (Note-4)	M3072
M2001	Axis 1	Operation cycle	/	Status signal (Note-1), (Note-2)	
M2002	Axis 2				
M2003	Axis 3				
M2004	Axis 4				
M2005	Axis 5				
M2006	Axis 6				
M2007	Axis 7				
M2008	Axis 8				
M2009	Axis 9				
M2010	Axis 10				
M2011	Axis 11				
M2012	Axis 12				
M2013	Axis 13				
M2014	Axis 14				
M2015	Axis 15				
M2016	Axis 16				
M2017	Axis 17				
M2018	Axis 18				
M2019	Axis 19				
M2020	Axis 20				
M2021	Axis 21				
M2022	Axis 22				
M2023	Axis 23				
M2024	Axis 24				
M2025	Axis 25				
M2026	Axis 26				
M2027	Axis 27				
M2028	Axis 28				
M2029	Axis 29				
M2030	Axis 30				
M2031	Axis 31				
M2032	Axis 32				
M2033	Unusable	—	—	—	—
M2034	Personal computer link communication error flag	Operation cycle	/	Status signal	
M2035	Motion SFC error history clear request flag (Note-6)	/	Main cycle	Command signal	M3080
M2036	Unusable	—	—	—	—
M2037	(3 points)				
M2038					
M2039	Motion SFC error detection flag	/	Immediate	Status signal	
M2040	Speed switching point specified flag	/	At start	Command signal (Note-4)	M3073
M2041	System setting error flag	Operation cycle	/	Status signal	
M2042	All axes servo ON command	/	Operation cycle	Command signal	M3074
M2043	Real/virtual mode switching request (SV22)	/	At virtual mode transition	Command signal (Note-4)	M3075
M2044	Real/virtual mode switching status (SV22)	At virtual mode transition	/	Status signal	
M2045	Real/virtual mode switching error detection (SV22)				
M2046	Out-of-sync warning (SV22)				
M2047	Motion slot fault detection flag	Operation cycle	/	Status signal	
M2048	JOG operation simultaneous start command	/	Main cycle	Command signal (Note-4)	M3076
M2049	All axes servo ON accept flag	Operation cycle	/	Status signal	
M2050	Start buffer full				
M2051	Manual pulse generator 1 enable flag	/	Main cycle	Command signal (Note-4)	M3077
M2052	Manual pulse generator 2 enable flag				
M2053	Manual pulse generator 3 enable flag	/	Main cycle	Command signal (Note-4)	M3079
M2054	Operation cycle over flag	Operation cycle	/	Status signal	
M2055	Unusable (6 points)	—	—	—	—
M2056					
M2057					
M2058					
M2059					
M2060					
M2061	Axis 1	Operation cycle	/	Status signal (Note-1), (Note-2)	
M2062	Axis 2				
M2063	Axis 3				
M2064	Axis 4				
M2065	Axis 5				
M2066	Axis 6				
M2067	Axis 7				
M2068	Axis 8				
M2069	Axis 9				
M2070	Axis 10				
M2071	Axis 11				
M2072	Axis 12				
M2073	Axis 13				
M2074	Axis 14				
M2075	Axis 15				
M2076	Axis 16				
M2077	Axis 17				
M2078	Axis 18				
M2079	Axis 19				
M2080	Axis 20				
M2081	Axis 21				
M2082	Axis 22				
M2083	Axis 23				
M2084	Axis 24				
M2085	Axis 25				
M2086	Axis 26				
M2087	Axis 27				
M2088	Axis 28				
M2089	Axis 29				
M2090	Axis 30				
M2091	Axis 31				
M2092	Axis 32				
M2093	Unusable (8 points)	—	—	—	—
M2094					
M2095					
M2096					
M2097					
M2098					
M2099					
M2100					
M2101	Axis 1	Synchronous encoder current value changing flag (Note-3) (12 axes)	Operation cycle	/	Status signal (Note-1), (Note-2)
M2102	Axis 2				
M2103	Axis 3				
M2104	Axis 4				
M2105	Axis 5				
M2106	Axis 6				
M2107	Axis 7				
M2108	Axis 8				
M2109	Axis 9				
M2110	Axis 10				
M2111	Axis 11				
M2112	Axis 12				
M2113	Unusable (6 points)	—	—	—	—
M2114					
M2115					
M2116					
M2117					
M2118					

APPENDICES

Common device list (Continued)

Device No.	Signal name	Refresh cycle	Fetch cycle	Signal direction	Remark (Note-5)	Device No.	Signal name	Refresh cycle	Fetch cycle	Signal direction	Remark (Note-5)								
M2119	Unusable (9 points)	—	—	—	—	M2180	Output	Operation cycle			Status signal (Note-1), (Note-2)								
M2120						Main shaft side													
M2121						Auxiliary input side													
M2122						Output													
M2123						Main shaft side													
M2124						Auxiliary input side													
M2125						Output													
M2126						Main shaft side													
M2127						Auxiliary input side													
M2128	Axis 1	Automatic deceleration flag				M2186	Output	Clutch status (SV22) (Note-3)											
M2129	Axis 2																		
M2130	Axis 3																		
M2131	Axis 4																		
M2132	Axis 5																		
M2133	Axis 6																		
M2134	Axis 7																		
M2135	Axis 8																		
M2136	Axis 9																		
M2137	Axis 10																		
M2138	Axis 11																		
M2139	Axis 12																		
M2140	Axis 13																		
M2141	Axis 14																		
M2142	Axis 15																		
M2143	Axis 16																		
M2144	Axis 17																		
M2145	Axis 18																		
M2146	Axis 19																		
M2147	Axis 20																		
M2148	Axis 21																		
M2149	Axis 22																		
M2150	Axis 23																		
M2151	Axis 24																		
M2152	Axis 25																		
M2153	Axis 26																		
M2154	Axis 27																		
M2155	Axis 28																		
M2156	Axis 29																		
M2157	Axis 30																		
M2158	Axis 31																		
M2159	Axis 32																		
M2160	Output	Clutch status (SV22) (Note-3)	Operation cycle		Status signal (Note-1), (Note-2)	M2200	Output	Clutch status (SV22) (Note-3)	Operation cycle										
M2161	axis 1																		
M2162	Output																		
M2163	axis 2																		
M2164	Output																		
M2165	axis 3																		
M2166	Output																		
M2167	axis 4																		
M2168	Output																		
M2169	axis 5																		
M2170	Output																		
M2171	axis 6																		
M2172	Output																		
M2173	axis 7																		
M2174	Output																		
M2175	axis 8																		
M2176	Output																		
M2177	axis 9																		
M2178	Output																		
M2179	axis 10																		
M2200	Output					Clutch status (SV22) (Note-3)	Operation cycle							M2208	Output	Clutch status (SV22) (Note-3)	Operation cycle		
M2201	Output																		
M2202	Output																		
M2203	Output																		
M2204	Output																		
M2205	Output																		
M2206	Output																		
M2207	Output																		
M2208	Output																		
M2209	Output																		
M2210	Output																		
M2211	Output																		
M2212	Output																		
M2213	Output																		
M2214	Output																		
M2215	Output																		
M2216	Output																		
M2217	Output																		
M2218	Output																		
M2219	Output																		
M2220	Output																		
M2221	Output																		
M2222	Output																		
M2223	Output																		
M2224	Output																		
M2225	Output																		
M2226	Output																		
M2227	Output																		
M2228	Output																		
M2229	Output																		
M2230	Output																		
M2231	Output																		
M2232	Output																		
M2233	Output																		
M2234	Output																		
M2235	Output																		
M2236	Output																		
M2237	Output																		
M2238	Output																		
M2239	Output																		
M2240	Output																		
M2241	Output																		
M2242	Output																		
M2243	Output																		
M2244	Output																		
M2245	Output																		
M2246	Output																		
M2247	Output																		
M2248	Output																		
M2249	Output																		
M2250	Output																		
M2251	Output																		
M2252	Output																		
M2253	Output																		
M2254	Output																		
M2255	Output																		
M2256	Output																		
M2257	Output																		
M2258	Output																		
M2259	Output																		
M2260	Output																		
M2261	Output																		
M2262	Output																		
M2263	Output																		
M2264	Output																		
M2265	Output																		
M2266	Output																		
M2267	Output																		
M2268	Output																		
M2269	Output																		
M2270	Output																		
M2271	Output																		
M2272	Output																		
M2273	Output																		
M2274	Output																		
M2275	Output																		
M2276	Output																		
M2277	Output																		
M2278	Output																		
M2279	Output																		
M2280	Output																		
M2281	Output																		
M2282	Output																		
M2283	Output																		
M2284	Output																		
M2285	Output																		
M2286	Output																		
M2287	Output																		
M2288	Output																		
M2289	Output																		
M2290	Output																		
M2291	Output																		
M2292	Output																		
M2293	Output																		
M2294	Output																		
M2295	Output																		
M2296	Output																		
M2297	Output																		
M2298	Output																		
M2299	Output																		
M2300	Output																		
M2301	Output																		
M2302	Output																		
M2303	Output																		
M2304	Output																		
M2305	Output																		
M2306	Output																		
M2307	Output																		
M2308	Output																		
M2309	Output																		
M2310	Output																		
M2311	Output																		
M2312	Output																		
M2313	Output																		
M2314	Output																		
M2315	Output																		
M2316	Output																		
M2317	Output																		
M2318	Output																		
M2319	Output																		
M2320	Output																		
M2321	Output																		
M2322	Output																		
M2323	Output																		
M2324	Output																		
M2325	Output																		
M2326	Output																		
M2327	Output																		
M2328	Output																		
M2329	Output																		
M2330	Output																		
M2331	Output																		
M2332	Output																		
M2333	Output																		
M2334	Output																		
M2335	Output																		
M2336	Output																		
M2337	Output																		
M2338	Output																		
M2339	Output																		
M2340	Output																		
M2341	Output																		
M2342	Output																		
M2343	Output																		
M2344	Output																		
M2345	Output																		
M2346	Output																		
M2347	Output																		
M2348	Output																		
M2349	Output																		
M2350	Output																		
M2351	Output																		
M2352	Output																		
M2353	Output																		
M2354	Output																		
M2355	Output																		
M2356	Output																		
M2357	Output																		
M2358	Output																		
M2359	Output																		
M2360	Output																		
M2361	Output																		
M2362	Output																		
M2363	Output																		
M2364	Output																		
M2365	Output																		
M2366	Output																		
M2367	Output																		
M2368	Output																		
M2369	Output																		
M2370	Output																		
M2371	Output																		
M2372	Output																		
M2373	Output																		
M2374	Output																		
M2375	Output																		
M2376	Output																		
M2377	Output																		
M2378	Output																		
M2379	Output																		
M2380	Output																		
M2381	Output																		
M2382	Output																		
M2383	Output																		
M2384	Output																		
M2385	Output																		
M2386	Output																		
M2387	Output																		
M2388	Output																		
M2389	Output																		
M2390	Output																		
M2391	Output																		
M2392	Output																		
M2393	Output																		
M2394	Output																		
M2395	Output																		
M2396	Output																		
M2397	Output																		
M2398	Output																		
M2399	Output																		
M2400	Output																		
M2401	Output																		
M2402	Output																		
M2403	Output																		
M2404	Output																		
M2405	Output																		
M2406	Output																		
M2407	Output																		
M2408	Output																		
M2409	Output																		
M2410	Output																		
M2411	Output																		
M2412	Output																		
M2413	Output																		
M2414	Output																		
M2415	Output																		
M2416	Output																		
M2417	Output																		
M2418	Output																		
M2419	Output																		
M2420	Output																		
M2421	Output																		
M2422	Output																		
M2423	Output																		
M2424	Output																		
M2425	Output																		
M2426	Output																		
M2427	Output																		
M2428	Output																		
M2429	Output																		
M2430	Output																		
M2431	Output																		
M2432	Output																		
M2433	Output																		
M2434	Output																		
M2435	Output																		
M2436	Output																		
M2437	Output																		
M2438	Output																		
M2439	Output																		
M2440	Output																		
M2441	Output																		
M2442	Output																		
M2443	Output																		
M2444	Output																		
M2445	Output																		
M2446	Output																		
M2447	Output																		
M2448	Output																		
M2449	Output																		
M2450	Output																		
M2451	Output																		
M2452	Output																		
M2453	Output																		
M2454	Output																		
M2455	Output																		
M2456	Output																		
M2457	Output																		
M2458	Output																		
M2459	Output																		
M2460	Output																		
M2461	Output																		
M2462	Output																		
M2463	Output																		
M2464	Output																		
M2465	Output																		
M2466	Output																		
M2467	Output																		
M2468	Output																		
M2469	Output																		
M2470	Output																		
M2471	Output																		
M2472	Output																		
M2473	Output																		
M2474	Output																		
M2475	Output																		
M2476	Output																		
M2477	Output																		
M2478	Output																		
M2479	Output																		
M2480	Output																		
M2481	Output																		
M2482	Output																		
M2483	Output																		
M2484	Output																		
M2485	Output																		
M2486	Output																		
M2487	Output																		
M2488	Output																		
M2489	Output																		
M2490	Output																		
M2491	Output																		
M2492	Output																		
M2493	Output																		
M2494	Output																		
M2495	Output																		
M2496	Output																		
M2497	Output																		
M2498	Output																		
M2499	Output																		
M2500	Output																		
M2501	Output																		
M2502	Output																		
M2503	Output																		
M2504	Output																		
M2505	Output																		
M2506	Output																		
M2507	Output																		
M2508	Output																		
M2509	Output																		
M2510	Output																		
M2511	Output																		
M2512	Output																		
M2513	Output																		
M2514	Output																		
M2515	Output																		
M2516	Output																		
M2517	Output																		
M2518	Output																		
M2519	Output																		
M2520	Output																		
M2521	Output																		
M2522	Output																		
M2523	Output																		
M2524	Output																		
M2525	Output																		
M2526	Output																		
M2527	Output																		
M2528	Output																		
M2529	Output																		
M2530	Output																		
M2531	Output																		
M2532	Output																		
M2533	Output																		
M2534	Output																		
M2535	Output																		
M2536	Output																		
M2537	Output																		
M2538	Output																		
M2539	Output																		
M2540	Output																		
M2541	Output																		
M2542	Output																		
M2543	Output																		
M2544	Output																		
M2545	Output																		
M2546	Output																		
M2547	Output																		
M2548	Output																		
M2549	Output																		
M2550	Output																		
M2551	Output																		
M2552	Output																		
M2553	Output																		
M2554	Output																		
M2555	Output																		
M2556	Output																		
M2557	Output																		
M2558	Output																		
M2559	Output																		
M2560	Output																		
M2561	Output																		
M2562	Output																		
M2563	Output																		
M2564	Output																		
M2565	Output																		
M2566	Output																		
M2567	Output																		
M2568	Output																		
M2569	Output																		
M2570	Output																		
M2571	Output																		
M2572	Output																		
M2573	Output																		
M2574	Output																		
M2575	Output																		
M2576	Output																		
M2577	Output																		
M2578	Output																		
M2579	Output																		
M2580	Output																		
M2581	Output																		
M2582	Output																		
M2583	Output																		
M2584	Output																		
M2585	Output																		
M2586	Output																		
M2587	Output																		
M2588	Output																		
M2589	Output																		
M2590	Output																		
M2591	Output																		
M2592	Output																		
M2593	Output																		
M2594	Output																		
M2595	Output																		
M2596	Output																		
M2597	Output																		
M2598	Output																		
M2599	Output																		
M2600	Output																		
M2601	Output																		
M2602	Output																		
M2603	Output																		
M2604	Output																		
M2605	Output																		
M2606	Output																		
M2607	Output																		
M2608	Output																		
M2609	Output																		
M2610	Output																		
M2611	Output																		
M2612	Output																		
M2613	Output																		
M2614	Output																		
M2615	Output																		
M2616	Output																		
M2617	Output																		
M2618	Output																		
M2619	Output																		

APPENDICES

Common device list (Continued)

Device No.	Signal name	Refresh cycle	Fetch cycle	Signal direction	Remark (Note-5)				
M2229	Unusable (11 points)	—	—	—	—				
M2230									
M2231									
M2232									
M2233									
M2234									
M2235									
M2236									
M2237									
M2238									
M2239									
M2240	Axis 1	Operation cycle		Status signal (Note-1), (Note-2)					
M2241	Axis 2								
M2242	Axis 3								
M2243	Axis 4								
M2244	Axis 5								
M2245	Axis 6								
M2246	Axis 7								
M2247	Axis 8								
M2248	Axis 9								
M2249	Axis 10								
M2250	Axis 11								
M2251	Axis 12								
M2252	Axis 13								
M2253	Axis 14								
M2254	Axis 15								
M2255	Axis 16								
M2256	Axis 17								
M2257	Axis 18								
M2258	Axis 19								
M2259	Axis 20								
M2260	Axis 21								
M2261	Axis 22								
M2262	Axis 23								
M2263	Axis 24								
M2264	Axis 25								
M2265	Axis 26								
M2266	Axis 27								
M2267	Axis 28								
M2268	Axis 29								
M2269	Axis 30								
M2270	Axis 31								
M2271	Axis 32								
M2272	Axis 1	Control loop monitor status	Operation cycle	Status signal (Note-1), (Note-2)					
M2273	Axis 2								
M2274	Axis 3								
M2275	Axis 4								
M2276	Axis 5	Control loop monitor status	Operation cycle	Status signal (Note-1), (Note-2)					
M2277	Axis 6								
M2278	Axis 7								
M2279	Axis 8								
M2280	Axis 9								
M2281	Axis 10								
M2282	Axis 11								
M2283	Axis 12								
M2284	Axis 13								
M2285	Axis 14								
M2286	Axis 15								
M2287	Axis 16								
M2288	Axis 17								
M2289	Axis 18								
M2290	Axis 19								
M2291	Axis 20								
M2292	Axis 21								
M2293	Axis 22								
M2294	Axis 23								
M2295	Axis 24								
M2296	Axis 25								
M2297	Axis 26								
M2298	Axis 27								
M2299	Axis 28								
M2300	Axis 29								
M2301	Axis 30								
M2302	Axis 31								
M2303	Axis 32								
M2304	Unusable (16 points)					—	—	—	—
M2305									
M2306									
M2307									
M2308									
M2309									
M2310									
M2311									
M2312									
M2313									
M2314									
M2315									
M2316									
M2317									
M2318									
M2319									

(Note-1) : The range of axis No.1 to 8 is valid in the Q172HCPU.

(Note-2) : Device area of 9 axes or more is unusable in the Q172HCPU.

(Note-3) : It is unusable in the SV22 real mode.

(Note-4) : It can also be ordered the device of a remark column.

(Note-5) : M3080 does not turn off automatically. Turn it off as a user side.

CAUTION

- The data executed later becomes valid when the same device is executed simultaneously in the Motion SFC and PLC program.

APPENDICES

(13) Special relay allocated device list (Status)

Device No.	Signal name	Refresh cycle	Fetch cycle	Signal direction	Remark ^(Note-1)
M2320	Fuse blown detection	Error occurrence	/	Status signal	M9000
M2321	AC / DC DOWN detection				M9005
M2322	Battery low				M9006
M2323	Battery low latch				M9007
M2324	Self-diagnostic error				M9008
M2325	Diagnostic error				M9010
M2326	Always ON	Main operation			M9036
M2327	Always OFF	M9037			
M2328	Clock data error	Error occurrence			M9026
M2329	PCPU WDT error flag	M9073			
M2330	PCPU READY complete flag	At request			M9074
M2331	Test mode ON flag				M9075
M2332	External forced stop input flag	Operation cycle			M9076
M2333	Manual pulse generator axis setting error flag	Error occurrence			M9077
M2334	TEST mode request error flag				M9078
M2335	Servo program setting error flag				M9079
M2336	CPU No.1 reset flag	At status change			M9240
M2337	CPU No.2 reset flag				M9241
M2338	CPU No.3 reset flag				M9242
M2339	CPU No.4 reset flag				M9243
M2340	CPU No.1 error flag		M9244		
M2341	CPU No.2 error flag		M9245		
M2342	CPU No.3 error flag		M9246		
M2343	CPU No.4 error flag		M9247		
M2344	Unusable	—	—	—	—
M2345	CPU No.1 MULTR complete flag	At instruction completion	/	Status signal	M9216
M2346	CPU No.2 MULTR complete flag				M9217
M2347	CPU No.3 MULTR complete flag				M9218
M2348	CPU No.4 MULTR complete flag				M9219
M2349 to M2399	Unusable (51 points)	—	—	—	—

(Note-1) : The same status as a remark column is output.

APPENDICES

(14) Common device list (Command signal)

Device No.	Signal name	Refresh cycle	Fetch cycle	Signal direction	Remark (Note-1), (Note-2)
M3072	PLC ready flag	/	Main cycle	Command signal	M2000
M3073	Speed switching point specified flag		At start		M2040
M3074	All axes servo ON command		Operation cycle		M2042
M3075	Real/virtual mode switching request (SV22)		At virtual mode transition		M2043
M3076	JOG operation simultaneous start command		Main cycle		M2048
M3077	Manual pulse generator 1 enable flag				M2051
M3078	Manual pulse generator 2 enable flag				M2052
M3079	Manual pulse generator 3 enable flag				M2053
M3080	Motion SFC error history clear request flag (Note-3)				M2035
M3081 to M3135	Unusable (55 points)	—	—	—	—

(Note-1) : The device of a remarks column turns ON by OFF to ON of the above device, and the device of a remarks column turns OFF by ON to OFF of the above device. The state of a device is not in agreement when the device of a remarks column is turned on directly. In addition, when the request from a data register and the request from the above device are performed simultaneously, the request from the above device becomes valid.

(Note-2) : It can also be ordered the device of a remark column.

(Note-3) : M3080 does not turn off automatically. Turn it off as an user side.

(15) Special relay allocated device list (Command signal)

Device No.	Signal name	Refresh cycle	Fetch cycle	Signal direction	Remark (Note-1), (Note-2)
M3136	Clock data set request	/	Main cycle	Command signal	M9025
M3137	Clock data read request				M9028
M3138	Error reset				M9060
M3139 to M3199	Unusable (61 points)	—	—	—	—

(Note-1) : The device of a remarks column turns ON by OFF to ON of the above device, and the device of a remarks column turns OFF by ON to OFF of the above device. The state of a device is not in agreement when the device of a remarks column is turned on directly.

(Note-2) : It can also be ordered the device of a remark column.

APPENDICES

(16) Axis monitor device list

Axis No.	Device No.	Signal name										
		Signal name	Real	Virtual				Real mode axis	Refresh cycle	Fetch cycle	Signal direction	
				Roller	Ball screw	Rotary table	Cam					
1	D0 to D19											
2	D20 to D39											
3	D40 to D59											
4	D60 to D79											
5	D80 to D99											
6	D100 to D119	0	○	Backup	×	○	Backup	○	Operation cycle	Main cycle	Monitor device	
7	D120 to D139	1										value/roller cycle speed
8	D140 to D159	2										Real current value
9	D160 to D179	3										
10	D180 to D199	4										Deviation counter value
11	D200 to D219	5										
12	D220 to D239	6										Minor error code
13	D240 to D259	7										Major error code
14	D260 to D279	8										Servo error code
15	D280 to D299	9										Home position return re-travel value
16	D300 to D319	10										Travel value after proximity dog ON
17	D320 to D339	11										
18	D340 to D359	12										Execute program No.
19	D360 to D379	13										M-code
20	D380 to D399	14										Torque limit value
21	D400 to D419	15										Data set pointer for constant-speed control
22	D420 to D439	16										Travel value change register
23	D440 to D459	17										
24	D460 to D479	18										Real current value at stop input
25	D480 to D499	19										
26	D500 to D519											
27	D520 to D539											
28	D540 to D559											
29	D560 to D579											
30	D580 to D599											
31	D600 to D619											
32	D620 to D639											

○ : Valid, × : Invalid

(Note-1) : The range of axis No.1 to 8 is valid in the Q172HCPU.

(Note-2) : Device area of 9 axes or more is unusable in the Q172HCPU.

APPENDICES

(17) Control change register list

Axis No.	Device No.	Signal name					
1	D640, D641						
2	D642, D643						
3	D644, D645						
4	D646, D647						
5	D648, D649						
6	D650, D651						
7	D652, D653						
8	D654, D655						
9	D656, D657						
10	D658, D659						
11	D660, D661						
12	D662, D663						
13	D664, D665						
14	D666, D667						
15	D668, D669						
16	D670, D671						
17	D672, D673						
18	D674, D675						
19	D676, D677						
20	D678, D679						
21	D680, D681						
22	D682, D683						
23	D684, D685						
24	D686, D687						
25	D688, D689						
26	D690, D691						
27	D692, D693						
28	D694, D695						
29	D696, D697						
30	D698, D699						
31	D700, D701						
32	D702, D703						

	Signal name	Real	Virtual	Refresh cycle	Fetch cycle	Signal direction
0	JOG speed setting	○	○	/	At start	Command device
1						

○ : Valid

(Note-1) : The range of axis No.1 to 8 is valid in the Q172HCPU.

(Note-2) : Device area of 9 axes or more is unusable in the Q172HCPU.

APPENDICES

(18) Virtual servomotor axis monitor device list

Axis No.	Device No.	Signal name										
	Signal name	Real	Virtual					Refresh cycle	Fetch cycle	Signal direction		
			Roller	Ball screw	Rotary table	Cam	Real mode axis					
1	D800 to D809											
2	D810 to D819											
3	D820 to D829											
4	D830 to D839											
5	D840 to D849											
6	D850 to D859	Backup						Operation cycle		Monitor device		
7	D860 to D869										1	Feed current value
8	D870 to D879										2	Minor error code
9	D880 to D889										3	Major error code
10	D890 to D899										4	Execute program No.
11	D900 to D909										5	M-code
12	D910 to D919										6	Current value after virtual
13	D920 to D929										7	servomotor axis main
14	D930 to D939										8	shaft's differential gear
15	D940 to D949										9	Error search output axis No.
16	D950 to D959											
17	D960 to D969											
18	D970 to D979											
19	D980 to D989											
20	D990 to D999											
21	D1000 to D1009											
22	D1010 to D1019											
23	D1020 to D1029											
24	D1030 to D1039											
25	D1040 to D1049											
26	D1050 to D1059											
27	D1060 to D1069											
28	D1070 to D1079											
29	D1080 to D1089											
30	D1090 to D1099											
31	D1100 to D1109											
32	D1100 to D1119											

○ : Valid, × : Invalid

(Note-1) : The range of axis No.1 to 8 is valid in the Q172HCPU.

(Note-2) : The unused axis areas in the mechanical system program can be used as an user side.

APPENDICES

(19) Synchronous encoder axis monitor device list

Axis No.	Device No.	Signal name																																																																																																	
1	D1120 to D1129	<table border="1"> <thead> <tr> <th></th> <th>Signal name</th> <th>Real</th> <th>Virtual</th> <th>Refresh cycle</th> <th>Fetch cycle</th> <th>Signal direction</th> </tr> </thead> <tbody> <tr> <td>0</td> <td>Current value</td> <td rowspan="3">Backup</td> <td rowspan="3">○</td> <td>Operation cycle</td> <td rowspan="3">/</td> <td rowspan="3">Monitor device</td> </tr> <tr> <td>1</td> <td>Minor error code</td> <td>Immediately</td> </tr> <tr> <td>2</td> <td>Major error code</td> <td></td> </tr> <tr> <td>3</td> <td>D1140 to D1149</td> <td>4</td> <td>Unusable</td> <td>—</td> <td>—</td> <td>—</td> <td>—</td> </tr> <tr> <td>4</td> <td>D1150 to D1159</td> <td>5</td> <td>Unusable</td> <td>—</td> <td>—</td> <td>—</td> <td>—</td> </tr> <tr> <td>5</td> <td>D1160 to D1169</td> <td>6</td> <td>Current value after synchronous encoder axis main shaft's differential gear</td> <td rowspan="2">Backup</td> <td rowspan="2">○</td> <td rowspan="2">Operation cycle</td> <td rowspan="2">/</td> <td rowspan="2">Monitor device</td> </tr> <tr> <td>6</td> <td>D1170 to D1179</td> <td>7</td> <td>Error search output axis No.</td> </tr> <tr> <td>7</td> <td>D1180 to D1189</td> <td>8</td> <td>Unusable</td> <td>—</td> <td>—</td> <td>—</td> <td>—</td> </tr> <tr> <td>8</td> <td>D1190 to D1199</td> <td>9</td> <td>Unusable</td> <td>—</td> <td>—</td> <td>—</td> <td>—</td> </tr> <tr> <td>9</td> <td>D1200 to D1209</td> <td></td> <td></td> <td></td> <td></td> <td></td> <td></td> </tr> <tr> <td>10</td> <td>D1210 to D1219</td> <td></td> <td></td> <td></td> <td></td> <td></td> <td></td> </tr> <tr> <td>11</td> <td>D1220 to D1229</td> <td></td> <td></td> <td></td> <td></td> <td></td> <td></td> </tr> <tr> <td>12</td> <td>D1230 to D1239</td> <td></td> <td></td> <td></td> <td></td> <td></td> <td></td> </tr> </tbody> </table>		Signal name	Real	Virtual	Refresh cycle	Fetch cycle	Signal direction	0	Current value	Backup	○	Operation cycle	/	Monitor device	1	Minor error code	Immediately	2	Major error code		3	D1140 to D1149	4	Unusable	—	—	—	—	4	D1150 to D1159	5	Unusable	—	—	—	—	5	D1160 to D1169	6	Current value after synchronous encoder axis main shaft's differential gear	Backup	○	Operation cycle	/	Monitor device	6	D1170 to D1179	7	Error search output axis No.	7	D1180 to D1189	8	Unusable	—	—	—	—	8	D1190 to D1199	9	Unusable	—	—	—	—	9	D1200 to D1209							10	D1210 to D1219							11	D1220 to D1229							12	D1230 to D1239						
	Signal name		Real	Virtual	Refresh cycle	Fetch cycle	Signal direction																																																																																												
0	Current value		Backup	○	Operation cycle	/	Monitor device																																																																																												
1	Minor error code	Immediately																																																																																																	
2	Major error code																																																																																																		
3	D1140 to D1149	4	Unusable	—	—	—	—																																																																																												
4	D1150 to D1159	5	Unusable	—	—	—	—																																																																																												
5	D1160 to D1169	6	Current value after synchronous encoder axis main shaft's differential gear	Backup	○	Operation cycle	/	Monitor device																																																																																											
6	D1170 to D1179	7	Error search output axis No.																																																																																																
7	D1180 to D1189	8	Unusable	—	—	—	—																																																																																												
8	D1190 to D1199	9	Unusable	—	—	—	—																																																																																												
9	D1200 to D1209																																																																																																		
10	D1210 to D1219																																																																																																		
11	D1220 to D1229																																																																																																		
12	D1230 to D1239																																																																																																		

○ : Valid

(Note-1) : It is unusable in the SV22 real mode.

(Note-2) : The range of axis No.1 to 8 is valid in the Q172HCPU.

(Note-3) : Device area of 9 axes or more is unusable in the Q172HCPU.

APPENDICES

(20) Cam axis monitor device list

Axis No.	Device No.	Signal name				
1	D1240 to D1249					
2	D1250 to D1259					
3	D1260 to D1269					
4	D1270 to D1279					
5	D1280 to D1289					
6	D1290 to D1299					
7	D1300 to D1309					
8	D1310 to D1319					
9	D1320 to D1329					
10	D1330 to D1339					
11	D1340 to D1349					
12	D1350 to D1359					
13	D1360 to D1369					
14	D1370 to D1379					
15	D1380 to D1389					
16	D1390 to D1399					
17	D1400 to D1409					
18	D1410 to D1419					
19	D1420 to D1429					
20	D1430 to D1439					
21	D1440 to D1449					
22	D1450 to D1459					
23	D1460 to D1469					
24	D1470 to D1479					
25	D1480 to D1489					
26	D1490 to D1499					
27	D1500 to D1509					
28	D1510 to D1519					
29	D1520 to D1529					
30	D1530 to D1539					
31	D1540 to D1549					
32	D1550 to D1559					

Signal name	Real	Virtual	Refresh cycle	Fetch cycle	Signal direction
0 Unusable	—	—	—	—	—
1 Execute cam No.	Backup	○	Operation cycle	/	Monitor device
2 Execute stroke amount					
3 Execute stroke amount					
4 Current value within 1 cam shaft revolution					
5 Current value within 1 cam shaft revolution	—	—	—	—	—
6 Unusable	—	—	—	—	—
7 Unusable	—	—	—	—	—
8 Unusable	—	—	—	—	—
9 Unusable	—	—	—	—	—

○ : Valid

(Note-1) : The range of axis No.1 to 8 is valid in the Q172HCPU.

(Note-2) : The unused axis areas in the mechanical system program can be used as an user side.

APPENDICES

(21) Common device list

Device No.	Signal name	Refresh cycle	Fetch cycle	Signal direction	Device No.	Signal name	Refresh cycle	Fetch cycle	Signal direction		
D704	PLC ready flag request	/	Main cycle	Command device	D752	Manual pulse generator 1 smoothing magnification setting register	/	At the manual pulse generator enable flag ┌	Command device		
D705	Speed switching point specified flag request				D753	Manual pulse generator 2 smoothing magnification setting register					
D706	All axes servo ON command request				D754	Manual pulse generator 3 smoothing magnification setting register					
D707	Real/virtual mode switching request (SV22)				D755	Manual pulse generator 1 enable flag request					
D708	JOG operation simultaneous start command request				D756	Manual pulse generator 2 enable flag request					
D709	Unusable	—	—	—	D757	Manual pulse generator 3 enable flag request	/	Main cycle	—		
D710	JOG operation simultaneous start axis setting register	/	At start	Command device	D758	Unusable	—	—	—		
D711			/		Main cycle	Monitor device	D759	PCPU ready complete flag status	Main cycle	/	—
D712							Unusable (30 points)	—	—	—	
D713											
D714	Manual pulse generator axis 1 No. setting register										
D715	Manual pulse generator axis 2 No. setting register										
D716	Manual pulse generator axis 3 No. setting register										
D717	Manual pulse generator axis 3 No. setting register										
D718	Manual pulse generator axis 3 No. setting register										
D719	Manual pulse generator axis 3 No. setting register										
D720	Axis 1										
D721	Axis 2										
D722	Axis 3										
D723	Axis 4										
D724	Axis 5										
D725	Axis 6										
D726	Axis 7										
D727	Axis 8										
D728	Axis 9										
D729	Axis 10										
D730	Axis 11										
D731	Axis 12										
D732	Axis 13										
D733	Axis 14										
D734	Axis 15										
D735	Axis 16										
D736	Axis 17										
D737	Axis 18										
D738	Axis 19										
D739	Axis 20										
D740	Axis 21										
D741	Axis 22										
D742	Axis 23										
D743	Axis 24										
D744	Axis 25										
D745	Axis 26										
D746	Axis 27										
D747	Axis 28										
D748	Axis 29										
D749	Axis 30										
D750	Axis 31										
D751	Axis 32										
D770	Manual pulse generators 1 pulse input magnification setting register (Note-2), (Note-3)	/	At the manual pulse generator enable flag ┌	Command device	D780	Real mode axis information register (SV22) (Note-1)	Main cycle	/	Monitor device		
D771					Unusable (8 points)	—	—	—			
D772											
D773											
D774											
D775											
D776											
D777											
D778											
D779											
D781	Unusable (8 points)	—	—	—							
D782											
D783											
D784											
D785											
D786											
D787											
D788											
D789											
D790					Unusable (8 points)	—	—	—			
D791											
D792											
D793											
D794											
D795											
D796											
D797											
D798											
D799											

(Note-1): This signal is unusable in the SV22 real mode.

(Note-2): The range of axis No.1 to 8 is valid in the Q172HCPU.

(Note-3): Device area of 9 axes or more is unusable in the Q172HCPU.

APPENDICES

(22) Motion register list (#)

Axis No.	Device No.	Signal name									
1	#8064 to #8067										
2	#8068 to #8071										
3	#8072 to #8075										
4	#8076 to #8079										
5	#8080 to #8083	+0	Servo amplifier type	0 : Unused 256 : MR-J3-B 257 : MR-J3-B (Fully closed loop control) 258 : MR-J3-B (Linear)	When the servo amplifier power-on	Monitor devise					
6	#8084 to #8087										
7	#8088 to #8091										
8	#8092 to #8095										
9	#8096 to #8099										
10	#8100 to #8103										
11	#8104 to #8107										
12	#8108 to #8111										
13	#8112 to #8115						+1	Motor current	× 0.1[%]	Operation cycle 1.7[ms] or less: Operation cycle Operation cycle 3.5[ms] or more: 3.5[ms]	
14	#8116 to #8119						+2	Motor speed	× 0.1[r/min]		
15	#8120 to #8123	+3									
16	#8124 to #8127										
17	#8128 to #8131										
18	#8132 to #8135										
19	#8136 to #8139										
20	#8140 to #8143										
21	#8144 to #8147										
22	#8148 to #8151										
23	#8152 to #8155										
24	#8156 to #8159										
25	#8160 to #8163										
26	#8164 to #8167										
27	#8168 to #8171										
28	#8172 to #8175										
29	#8176 to #8179										
30	#8180 to #8183										
31	#8184 to #8187										
32	#8188 to #8191										

(Note-1) : The value that the lowest servo monitor device No. was added "+0, +1 ..." on each axis is shown.

APPENDICES

(23) Special relay list

Device No.	Signal name	Refresh cycle	Signal type
M9073	PCPU WDT error flag	Main cycle	Status signal
M9074	PCPU REDAY complete flag		
M9075	TEST mode ON flag		
M9076	External forced stop input flag		
M9077	Manual pulse generator axis setting error flag		
M9078	TEST mode request error flag		
M9079	Servo program setting error flag		

(24) Special register list

Device No.	Signal name	Refresh cycle	Fetch cycle	Signal direction
D9112	Connect/disconnect	Main cycle	Main cycle	Command device/ Monitor device
D9180	Unusable	—	—	—
D9181				
D9182	Test mode request error information	At test mode request	Monitor device	
D9183				
D9184	Motion CPU WDT error cause	At Motion CPU WDT error occurrence		
D9185				
D9186	Manual pulse generator axis setting error information	At the manual pulse generator enable flag \uparrow		
D9187				
D9188	Motion operation cycle	Operation cycle		
D9189	Error program No.	At start		
D9190	Error item information			
D9191	Servo amplifier loading information	At power supply on/ operation cycle		
D9192				
D9193	Real/virtual mode switching error information (SV22)	At virtual mode transition		
D9194				
D9195				
D9196	PC link communication error codes	Operation cycle		
D9197	Operation cycle of the Motion CPU setting	At power supply on		
D9198	Unusable	—		
D9199				
D9200	State of switch	Main cycle	Monitor device	
D9201	State of LED	Immediate		

WARRANTY

Please confirm the following product warranty details before using this product.

1. Gratis Warranty Term and Gratis Warranty Range

If any faults or defects (hereinafter "Failure") found to be the responsibility of Mitsubishi occurs during use of the product within the gratis warranty term, the product shall be repaired at no cost via the sales representative or Mitsubishi Service Company.

However, if repairs are required onsite at domestic or overseas location, expenses to send an engineer will be solely at the customer's discretion. Mitsubishi shall not be held responsible for any re-commissioning, maintenance, or testing on-site that involves replacement of the failed module.

[Gratis Warranty Term]

Note that an installation period of less than one year after installation in your company or your customer's premises or a period of less than 18 months (counted from the date of production) after shipment from our company, whichever is shorter, is selected.

[Gratis Warranty Range]

(1) Diagnosis of failure

As a general rule, diagnosis of failure is done on site by the customer.

However, Mitsubishi or Mitsubishi service network can perform this service for an agreed upon fee upon the customer's request.

There will be no charges if the cause of the breakdown is found to be the fault of Mitsubishi.

(2) Breakdown repairs

There will be a charge for breakdown repairs, exchange replacements and on site visits for the following four conditions, otherwise there will be a charge.

1) Breakdowns due to improper storage, handling, careless accident, software or hardware design by the customer

2) Breakdowns due to modifications of the product without the consent of the manufacturer

3) Breakdowns resulting from using the product outside the specified specifications of the product

4) Breakdowns that are outside the terms of warranty

Since the above services are limited to Japan, diagnosis of failures, etc. are not performed abroad.

If you desire the after service abroad, please register with Mitsubishi. For details, consult us in advance.

2. Exclusion of Loss in Opportunity and Secondary Loss from Warranty Liability

Mitsubishi will not be held liable for damage caused by factors found not to be the cause of Mitsubishi; opportunity loss or lost profits caused by faults in the Mitsubishi products; damage, secondary damage, accident compensation caused by special factors unpredictable by Mitsubishi; damages to products other than Mitsubishi products; and to other duties.

3. Onerous Repair Term after Discontinuation of Production

Mitsubishi shall accept onerous product repairs for seven years after production of the product is discontinued.

4. Delivery Term

In regard to the standard product, Mitsubishi shall deliver the standard product without application settings or adjustments to the customer and Mitsubishi is not liable for on site adjustment or test run of the product.

5. Precautions for Choosing the Products

(1) These products have been manufactured as a general-purpose part for general industries, and have not been designed or manufactured to be incorporated in a device or system used in purposes related to human life.

(2) Before using the products for special purposes such as nuclear power, electric power, aerospace, medicine, passenger movement vehicles or under water relays, contact Mitsubishi.

(3) These products have been manufactured under strict quality control. However, when installing the product where major accidents or losses could occur if the product fails, install appropriate backup or failsafe functions in the system.

(4) When exporting any of the products or related technologies described in this catalogue, you must obtain an export license if it is subject to Japanese Export Control Law.

IB(NA)-0300114-B(0609)MEE

MODEL: Q173H-P-SV22-KASO-E

MODEL CODE: 1XB914

MITSUBISHI ELECTRIC CORPORATION

HEAD OFFICE : TOKYO BUILDING, 2-7-3 MARUNOUCHI, CHIYODA-KU, TOKYO 100-8310, JAPAN
NAGOYA WORKS : 1-14, YADA-MINAMI 5-CHOME, HIGASHI-KU, NAGOYA, JAPAN

When exported from Japan, this manual does not require application to the
Ministry of Economy, Trade and Industry for service transaction permission.

Specifications subject to change without notice.