

C Controller Interface Module

MELSEC **Q** series

Q173SCCF

C Controller Interface Module

User's Manual (Details)

-Q173SCCF

● SAFETY PRECAUTIONS ●

(Please read these instructions before using this equipment.)

Before using this product, please read this manual and the relevant manuals introduced in this manual carefully and pay full attention to safety to handle the product correctly.

These precautions apply only to this product. Refer to the Users manual of the QCPU module to use for a description of the PLC system safety precautions.

In this manual, the safety instructions are ranked as "DANGER" and "CAUTION".

 **DANGER**

Indicates that incorrect handling may cause hazardous conditions, resulting in death or severe injury.

 **CAUTION**

Indicates that incorrect handling may cause hazardous conditions, resulting in medium or slight personal injury or physical damage.

Depending on circumstances, procedures indicated by  CAUTION may also be linked to serious results.

In any case, it is important to follow the directions for usage.

Please save this manual to make it accessible when required and always forward it to the end user.

For Safe Operations

1. Prevention of electric shocks

DANGER

- Never open the front case or terminal covers while the power is ON or the unit is running, as this may lead to electric shocks.
- Never run the unit with the front case or terminal cover removed. The high voltage terminal and charged sections will be exposed and may lead to electric shocks.
- Never open the front case or terminal cover at times other than wiring work or periodic inspections even if the power is OFF. The insides of the module and servo amplifier are charged and may lead to electric shocks.
- Completely turn off the externally supplied power used in the system before mounting or removing the module, performing wiring work, or inspections. Failing to do so may lead to electric shocks.
- When performing wiring work or inspections, turn the power OFF, wait at least ten minutes, and then check the voltage with a tester, etc. Failing to do so may lead to electric shocks.
- Be sure to ground the module, servo amplifier and servo motor. (Ground resistance : 100 Ω or less) Do not ground commonly with other devices.
- The wiring work and inspections must be done by a qualified technician.
- Wire the units after installing the module, servo amplifier and servo motor. Failing to do so may lead to electric shocks or damage.
- Never operate the switches with wet hands, as this may lead to electric shocks.
- Do not damage, apply excessive stress, place heavy things on or sandwich the cables, as this may lead to electric shocks.
- Do not touch the module, servo amplifier or servo motor terminal blocks while the power is ON, as this may lead to electric shocks.
- Do not touch the built-in power supply, built-in grounding or signal wires of the module and servo amplifier, as this may lead to electric shocks.

2. For fire prevention

CAUTION

- Install the module, servo amplifier, servo motor and regenerative resistor on incombustible. Installing them directly or close to combustibles will lead to fire.
- If a fault occurs in the module or servo amplifier, shut the power OFF at the servo amplifier's power source. If a large current continues to flow, fire may occur.
- When using a regenerative resistor, shut the power OFF with an error signal. The regenerative resistor may abnormally overheat due to a fault in the regenerative transistor, etc., and may lead to fire.
- Always take heat measures such as flame proofing for the inside of the control panel where the servo amplifier or regenerative resistor is installed and for the wires used. Failing to do so may lead to fire.
- Do not damage, apply excessive stress, place heavy things on or sandwich the cables, as this may lead to fire.

3. For injury prevention

CAUTION

- Do not apply a voltage other than that specified in the instruction manual on any terminal. Doing so may lead to destruction or damage.
- Do not mistake the terminal connections, as this may lead to destruction or damage.
- Do not mistake the polarity (+ / -), as this may lead to destruction or damage.
- Do not touch the heat radiating fins of module or servo amplifier, regenerative resistor and servo motor, etc., while the power is ON and for a short time after the power is turned OFF. In this timing, these parts become very hot and may lead to burns.
- Always turn the power OFF before touching the servo motor shaft or coupled machines, as these parts may lead to injuries.
- Do not go near the machine during test operations or during operations such as teaching. Doing so may lead to injuries.

4. Various precautions

Strictly observe the following precautions.

Mistaken handling of the unit may lead to faults, injuries or electric shocks.

(1) System structure

CAUTION

- Always install a leakage breaker on the module and servo amplifier power source.
- If installation of an electromagnetic contactor for power shut off during an error, etc., is specified in the instruction manual for the servo amplifier, etc., always install the electromagnetic contactor.
- Install the emergency stop circuit externally so that the operation can be stopped immediately and the power shut off.
- Use the module, servo amplifier, servo motor and regenerative resistor with the correct combinations listed in the instruction manual. Other combinations may lead to fire or faults.
- Use the CPU module, base unit and C Controller interface module with the correct combinations listed in the instruction manual. Other combinations may lead to faults.
- If safety standards (ex., robot safety rules, etc.) apply to the system using the module, servo amplifier and servo motor, make sure that the safety standards are satisfied.
- Construct a safety circuit externally of the module or servo amplifier if the abnormal operation of the module or servo amplifier differ from the safety directive operation in the system.
- In systems where coasting of the servo motor will be a problem during the forced stop, emergency stop, servo OFF or power supply OFF, use dynamic brakes.
- Make sure that the system considers the coasting amount even when using dynamic brakes.
- In systems where perpendicular shaft dropping may be a problem during the forced stop, emergency stop, servo OFF or power supply OFF, use both dynamic brakes and electromagnetic brakes.

CAUTION

- The dynamic brakes must be used only on errors that cause the forced stop, emergency stop, or servo OFF. These brakes must not be used for normal braking.
- The brakes (electromagnetic brakes) assembled into the servo motor are for holding applications, and must not be used for normal braking.
- The system must have a mechanical allowance so that the machine itself can stop even if the stroke limits switch is passed through at the max. speed.
- Use wires and cables that have a wire diameter, heat resistance and bending resistance compatible with the system.
- Use wires and cables within the length of the range described in the instruction manual.
- The ratings and characteristics of the parts (other than module, servo amplifier and servo motor) used in a system must be compatible with the module, servo amplifier and servo motor.
- Install a cover on the shaft so that the rotary parts of the servo motor are not touched during operation.
- There may be some cases where holding by the electromagnetic brakes is not possible due to the life or mechanical structure (when the ball screw and servomotor are connected with a timing belt, etc.). Install a stopping device to ensure safety on the machine side.

(2) Parameter settings and programming

CAUTION

- Set the parameter values to those that are compatible with the module, servo amplifier, servo motor and regenerative resistor model and the system application. The protective functions may not function if the settings are incorrect.
- The regenerative resistor model and capacity parameters must be set to values that conform to the operation mode, servo amplifier and servo power supply module. The protective functions may not function if the settings are incorrect.
- Set the mechanical brake output and dynamic brake output validity parameters to values that are compatible with the system application. The protective functions may not function if the settings are incorrect.
- Set the stroke limit input validity parameter to a value that is compatible with the system application. The protective functions may not function if the setting is incorrect.
- Set the servo motor encoder type (increment, absolute position type, etc.) parameter to a value that is compatible with the system application. The protective functions may not function if the setting is incorrect.
- Set the servo motor capacity and type (standard, low-inertia, flat, etc.) parameter to values that are compatible with the system application. The protective functions may not function if the settings are incorrect.
- Set the servo amplifier capacity and type parameters to values that are compatible with the system application. The protective functions may not function if the settings are incorrect.
- Use the program commands for the program with the conditions specified in the instruction manual.

CAUTION

- Set the sequence function program capacity setting, device capacity, latch validity range, I/O assignment setting, and validity of continuous operation during error detection to values that are compatible with the system application. The protective functions may not function if the settings are incorrect.
- Some devices used in the program have fixed applications, so use these with the conditions specified in the instruction manual.
- The input devices and data registers assigned to the link will hold the data previous to when communication is terminated by an error, etc. Thus, an error correspondence interlock program specified in the instruction manual must be used.
- Use the interlock program specified in the intelligent function module's instruction manual for the program corresponding to the intelligent function module.

(3) Transportation and installation

CAUTION

- Transport the product with the correct method according to the mass.
- Use the servo motor suspension bolts only for the transportation of the servo motor. Do not transport the servo motor with machine installed on it.
- Do not stack products past the limit.
- When transporting the module or servo amplifier, never hold the connected wires or cables.
- When transporting the servo motor, never hold the cables, shaft or detector.
- When transporting the module or servo amplifier, never hold the front case as it may fall off.
- When transporting, installing or removing the module or servo amplifier, never hold the edges.
- Install the unit according to the instruction manual in a place where the mass can be withstood.
- Do not get on or place heavy objects on the product.
- Always observe the installation direction.
- Keep the designated clearance between the module or servo amplifier and control panel inner surface or the module and servo amplifier, module or servo amplifier and other devices.
- Do not install or operate module, servo amplifiers or servo motors that are damaged or that have missing parts.
- Do not block the intake/outtake ports of the module, servo amplifier and servo motor with cooling fan.
- Do not allow conductive matter such as screw or cutting chips or combustible matter such as oil enter the module, servo amplifier or servo motor.
- The module, servo amplifier and servo motor are precision machines, so do not drop or apply strong impacts on them.
- Securely fix the module, servo amplifier and servo motor to the machine according to the instruction manual. If the fixing is insufficient, these may come off during operation.

⚠ CAUTION

- Always install the servo motor with reduction gears in the designated direction. Failing to do so may lead to oil leaks.
- Store and use the unit in the following environmental conditions.

Environment	Conditions	
	Module/Servo amplifier	Servomotor
Ambient temperature	According to each instruction manual.	0°C to +40°C (With no freezing) (32°F to +104°F)
Ambient humidity	According to each instruction manual.	80% RH or less (With no dew condensation)
Storage temperature	According to each instruction manual.	-20°C to +65°C (-4°F to +149°F)
Atmosphere	Indoors (where not subject to direct sunlight). No corrosive gases, flammable gases, oil mist or dust must exist	
Altitude	According to each instruction manual	
Vibration	According to each instruction manual	

- When coupling with the synchronous encoder or servo motor shaft end, do not apply impact such as by hitting with a hammer. Doing so may lead to detector damage.
- Do not apply a load larger than the tolerable load onto the synchronous encoder and servo motor shaft. Doing so may lead to shaft breakage.
- When not using the module for a long time, disconnect the power line from the module or servo amplifier.
- Place the module and servo amplifier in static electricity preventing vinyl bags and store.
- When storing for a long time, please contact with our sales representative.
Also, execute a trial operation.
- When fumigants that contain halogen materials such as fluorine, chlorine, bromine, and iodine are used for disinfecting and protecting wooden packaging from insects, they cause malfunction when entering our products.
Please take necessary precautions to ensure that remaining materials from fumigant do not enter our products, or treat packaging with methods other than fumigation (heat method).
Additionally, disinfect and protect wood from insects before packing products.

(4) Wiring

⚠ CAUTION

- Correctly and securely wire the wires. Reconfirm the connections for mistakes and the terminal screws for tightness after wiring. Failing to do so may lead to run away of the servo motor.
- After wiring, install the protective covers such as the terminal covers to the original positions.
- Do not install a phase advancing capacitor, surge absorber or radio noise filter (option FR-BIF) on the output side of the servo amplifier.
- Correctly connect the output side (terminal U, V, W) and ground. Incorrect connections will lead the servo motor to operate abnormally.
- Do not connect a commercial power supply to the servo motor, as this may lead to trouble.
- Do not mistake the direction of the surge absorbing diode installed on the DC relay for the control signal output of brake signals, etc. Incorrect installation may lead to signals not being output when trouble occurs or the protective functions not functioning.

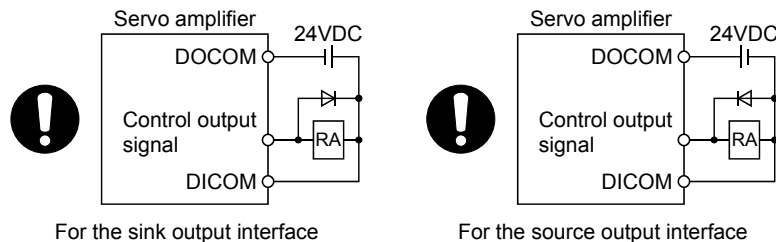

- Do not connect or disconnect the connection cables between each unit, the encoder cable or PLC expansion cable while the power is ON.
- Securely tighten the cable connector fixing screws and fixing mechanisms. Insufficient fixing may lead to the cables coming off during operation.
- Do not bundle the power line or cables.

(5) Trial operation and adjustment

⚠ CAUTION

- Confirm and adjust the program and each parameter before operation. Unpredictable movements may occur depending on the machine.
- Extreme adjustments and changes may lead to unstable operation, so never make them.
- When using the absolute position system function, on starting up, and when the module or absolute position motor has been replaced, always perform a home position return.
- Before starting test operation, set the parameter speed limit value to the slowest value, and make sure that operation can be stopped immediately by the forced stop, etc. if a hazardous state occurs.

(6) Usage methods

⚠ CAUTION

- Immediately turn OFF the power if smoke, abnormal sounds or odors are emitted from the module, servo amplifier or servo motor.
- Always execute a test operation before starting actual operations after the program or parameters have been changed or after maintenance and inspection.
- Do not attempt to disassemble and repair the units excluding a qualified technician whom our company recognized.
- Do not make any modifications to the unit.
- Keep the effect or electromagnetic obstacles to a minimum by installing a noise filter or by using wire shields, etc. Electromagnetic obstacles may affect the electronic devices used near the module or servo amplifier.
- When using the CE Mark-compliant equipment, refer to this manual for the C Controller interface modules and refer to the corresponding EMC guideline information for the servo amplifiers, inverters and other equipment.
- Use the units with the following conditions.

Item	Conditions
Input power	According to each instruction manual.
Input frequency	According to each instruction manual.
Tolerable momentary power failure	According to each instruction manual.

(7) Corrective actions for errors

⚠ CAUTION

- If an error occurs in the self diagnosis of the module or servo amplifier, confirm the check details according to the instruction manual, and restore the operation.
- If a dangerous state is predicted in case of a power failure or product failure, use a servo motor with electromagnetic brakes or install a brake mechanism externally.
- Use a double circuit construction so that the electromagnetic brake operation circuit can be operated by emergency stop signals set externally.

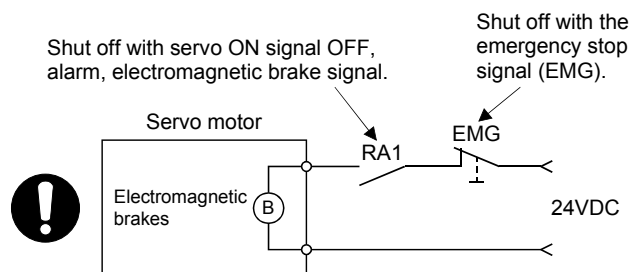

- If an error occurs, remove the cause, secure the safety and then resume operation after alarm release.
- The unit may suddenly resume operation after a power failure is restored, so do not go near the machine. (Design the machine so that personal safety can be ensured even if the machine restarts suddenly.)

(8) Maintenance, inspection and part replacement

CAUTION

- Perform the daily and periodic inspections according to the instruction manual.
- Perform maintenance and inspection after backing up the program and parameters for the module and servo amplifier.
- Do not place fingers or hands in the clearance when opening or closing any opening.
- Periodically replace consumable parts such as batteries according to the instruction manual.
- Do not touch the lead sections such as ICs or the connector contacts.
- Before touching the module, always touch grounded metal, etc. to discharge static electricity from human body. Failure to do so may cause the module to fail or malfunction.
- Do not directly touch the module's conductive parts and electronic components.
Touching them could cause an operation failure or give damage to the module.
- Do not place the module or servo amplifier on metal that may cause a power leakage or wood, plastic or vinyl that may cause static electricity buildup.
- Do not perform a megger test (insulation resistance measurement) during inspection.
- When replacing the module or servo amplifier, always set the new module settings correctly.
- When the module or absolute value motor has been replaced, carry out a home position return operation from the user program. Failing to do so may cause position displacement.
- After maintenance and inspections are completed, confirm that the position detection of the absolute position detector function is correct.
- Do not drop or impact the battery installed to the module.
Doing so may damage the battery, causing battery liquid to leak in the battery. Do not use the dropped or impacted battery, but dispose of it.
- Do not short circuit, charge, overheat, incinerate or disassemble the batteries.
- The electrolytic capacitor will generate gas during a fault, so do not place your face near the module or servo amplifier.
- The electrolytic capacitor and fan will deteriorate. Periodically replace these to prevent secondary damage from faults. Replacements can be made by our sales representative.
- Lock the control panel and prevent access to those who are not certified to handle or install electric equipment.
- Do not burn or break a module and servo amplifier. Doing so may cause a toxic gas.

(9) About processing of waste

When you discard module, servo amplifier, a battery (primary battery) and other option articles, please follow the law of each country (area).

CAUTION

- This product is not designed or manufactured to be used in equipment or systems in situations that can affect or endanger human life.
- When considering this product for operation in special applications such as machinery or systems used in passenger transportation, medical, aerospace, atomic power, electric power, or submarine repeating applications, please contact your nearest Mitsubishi Electric sales representative.
- Although this product was manufactured under conditions of strict quality control, you are strongly advised to install safety devices to forestall serious accidents when it is used in facilities where a breakdown in the product is likely to cause a serious accident.

(10) General cautions

- All drawings provided in the instruction manual show the state with the covers and safety partitions removed to explain detailed sections. When operating the product, always return the covers and partitions to the designated positions, and operate according to the instruction manual.

REVISIONS

* The manual number is given on the bottom left of the back cover.

Print Date	* Manual Number	Revision
Dec., 2013	IB(NA)-0300217-A	First edition
Dec., 2014	IB(NA)-0300217-B	[Additional function] Speed-torque control, Mark detection, Continuous operation to torque control, External forced stop disabled [Additional correction] Alarm history, Home position return method change while system is running, High speed monitor position droop, Table map, Log data (event code list, information for each event), Parameters (servo parameters, control parameters), Monitor number (operation information), Alarm number (system alarm, operation alarm), Supplementary explanation for the use of linear servo system
Aug., 2015	IB(NA)-0300217-C	[Additional model] MR-JE-□B [Additional function] SSCNETⅢ/H head module connection, transient transmit, hot line forced stop function, event detection function [Additional correction] About manuals, Summary, System configuration, Restriction's by the software's version, I/O table setting, Point table loop method, I/O device, Log data (event code list, information for each event), Table map, Parameters (system parameters, servo parameters, control parameters, RIO control parameters), Monitor number (servo information (1), RIO information, RIO control information, system information), Alarm number (RIO module alarm, operation alarm, RIO control alarm, system error), Supplementary explanation for the use of servo amplifier (MR-JE-□B)
Apr., 2017	IB(NA)-0300217-D	[Additional function] SSCNETⅢ/H head module connection [Additional correction] For safe operations, Summary, General specifications, List of specifications of Q173SCCF, System configuration, Restrictions by the software's version, Linear interpolation, Command change, Other axes start, Number of connectable stations of SSCNETⅢ/H head module, Transient commands for servo amplifier, Table map (interpolation group No. being executed table), Parameters (system parameters, control parameters, RIO module parameters, RIO control parameters), Monitor number (servo information (2), RIO information), Alarm number (servo alarm, RIO module alarm, operation alarm), Warranty

Japanese Manual Number IB(NA)-0300216

This manual confers no industrial property rights or any rights of any other kind, nor does it confer any patent licenses. Mitsubishi Electric Corporation cannot be held responsible for any problems involving industrial property rights which may occur as a result of using the contents noted in this manual.

INTRODUCTION

Thank you for choosing the Mitsubishi Electric C Controller interface module Q173SCCF.
Before using the equipment, please read this manual carefully to develop full familiarity with the functions and performance of the C Controller interface module you have purchased, so as to ensure correct use.

CONTENTS

Safety Precautions	A- 1
Revisions	A-11
Contents	A-12
About Manuals.....	A-22

1. SUMMARY	1- 1 to 1-20
-------------------	---------------------

1.1 Summary	1- 1
1.2 Features of Q173SCCF	1- 4
1.3 Specifications	1- 7
1.3.1 General specifications	1- 7
1.3.2 List of specifications of Q173SCCF	1- 8
1.4 Name of each section	1-11
1.5 Bus interface	1-13
1.5.1 Configuration register	1-13
1.5.2 Dual port memory map.....	1-14
1.5.3 Module information.....	1-15
1.6 SSCNETIII cables	1-17
1.7 Forced stop input terminal	1-18
1.8 PCIe cable	1-19

2. SYSTEM CONFIGURATION	2- 1 to 2- 6
--------------------------------	---------------------

2.1 Equipment configuration of system	2- 1
2.2 Q173SCCF system overall configuration	2- 2
2.3 System configuration equipment	2- 3
2.4 Checking serial number and operating system software version	2- 5
2.4.1 Checking serial number	2- 5
2.4.2 Checking software version.....	2- 5
2.5 Software version.....	2- 6
2.6 Restrictions by the software's version	2- 6

3. INSTALLATION AND WIRING	3- 1 to 3-16
-----------------------------------	---------------------

3.1 Module installation	3- 1
3.1.1 Instructions for handling	3- 1
3.1.2 Mounting position	3- 2
3.1.3 Installation and removal of module.....	3- 3
3.2 Connection and disconnection of cable	3- 6
3.2.1 SSCNETIII cable	3- 6
3.2.2 Forced stop input cable.....	3-11

3.2.3 PCIe cable	3-12
3.3 Wiring.....	3-14
3.3.1 Instructions for wiring	3-14
3.3.2 Wiring of connector	3-15

4. SYSTEM STARTUP	4- 1 to 4-20
--------------------------	---------------------

4.1 Startup procedures.....	4- 1
4.2 Check of wiring and ambient environment.....	4- 2
4.3 Servo amplifier setting.....	4- 3
4.4 Parameter setting	4- 5
4.4.1 Parameter initialization	4- 5
4.4.2 System option 1 setting.....	4- 6
4.4.3 System option 2 setting.....	4- 8
4.4.4 I/O table setting	4- 9
4.4.5 Control option 1 setting	4-10
4.4.6 Axis No. assignment	4-11
4.4.7 Sensor input option setting	4-13
4.4.8 Vendor ID and type code setting	4-17
4.5 System startup processing	4-18

5. OPERATIONAL FUNCTIONS	5- 1 to 5-48
---------------------------------	---------------------

5.1 JOG operation	5- 2
5.1.1 Summary	5- 2
5.1.2 Start operation method.....	5- 2
5.1.3 Resuming operation	5- 3
5.2 Incremental feed.....	5- 4
5.2.1 Summary	5- 4
5.2.2 Start operation method.....	5- 5
5.3 Automatic operation	5- 6
5.3.1 Summary	5- 6
5.3.2 Start operation method.....	5- 7
5.3.3 Auxiliary command.....	5- 8
5.3.4 Other axes start specification.....	5-15
5.3.5 S-curve ratio	5-15
5.3.6 Point table loop method	5-16
5.4 Linear interpolation.....	5-20
5.4.1 Summary	5-20
5.4.2 Settings.....	5-22
5.4.3 Start operation method.....	5-24
5.4.4 Processing for exceeding speed limit for each axis.....	5-26
5.4.5 Restrictions	5-28
5.5 Home position return.....	5-29
5.5.1 Summary	5-29
5.5.2 Home position return method	5-31
5.5.3 Start operation method.....	5-32
5.5.4 Home position return using a dog method	5-34
5.5.5 Home position return using a data set method	5-36
5.5.6 Home position return using a stopper method	5-36

5.5.7 Home position return using a dog cradle method	5-37
5.5.8 Home position return using a limit switch combined method.....	5-39
5.5.9 Home position return using a limit switch front end method	5-39
5.5.10 Home position return using a dog front end method.....	5-40
5.5.11 Home position return using a Z-phase detection method.....	5-42
5.5.12 Home position return using a scale home position signal detection method	5-45
5.5.13 Home position return using a scale home position signal detection method 2.....	5-46
5.6 Home position reset function (data set function).....	5-47

6. APPLICATION FUNCTIONS

6- 1 to 6-206

6.1 Command units	6- 1
6.1.1 Position command unit - electronic gear	6- 1
6.1.2 Settings	6- 3
6.1.3 Setting example of electronic gears	6- 3
6.1.4 Restrictions	6- 4
6.2 Speed unit	6- 5
6.2.1 Settings	6- 5
6.2.2 Setting example of speed units.....	6- 6
6.2.3 Speed limit	6- 6
6.3 Acceleration/deceleration.....	6- 7
6.3.1 Linear acceleration/deceleration	6- 7
6.3.2 Smoothing filter.....	6- 8
6.3.3 Start up speed validity	6- 8
6.3.4 S-curve acceleration/deceleration (Sine acceleration/deceleration)	6- 9
6.4 Servo off	6-13
6.5 Forced stop.....	6-14
6.6 Stop operation	6-15
6.7 Rapid stop operation	6-16
6.8 Limit switch (stroke end)	6-17
6.9 Software limit.....	6-18
6.10 Interlock	6-20
6.11 Rough match output.....	6-22
6.12 Torque limit.....	6-23
6.13 Command change.....	6-24
6.13.1 Speed change	6-24
6.13.2 Change of time constants	6-25
6.13.3 Position change.....	6-26
6.14 Backlash	6-33
6.15 Position switch.....	6-34
6.16 Completion of operation signal	6-35
6.17 Interference check function.....	6-41
6.17.1 Interface	6-43
6.17.2 Interference check operation image diagram.....	6-44
6.17.3 Checks prior to start up	6-45
6.17.4 Operation check	6-46
6.18 Home position search limit.....	6-49
6.18.1 Summary	6-49
6.18.2 Set items.....	6-49

6.18.3 Home position search limit operation example	6-50
6.19 Gain changing	6-51
6.20 PI-PID switching	6-53
6.21 Absolute position detection system	6-54
6.21.1 Parameters	6-54
6.21.2 Processing procedure	6-55
6.21.3 Sequence example	6-57
6.22 Home position return request	6-59
6.23 Other axes start	6-61
6.23.1 Summary	6-61
6.23.2 Settings	6-61
6.23.3 Interface	6-69
6.23.4 Operation example	6-72
6.24 High response I/F	6-76
6.24.1 Summary	6-76
6.24.2 Interface	6-77
6.24.3 Fast start operation	6-78
6.24.4 Interrupt processing high speed completion	6-79
6.25 In-position signal	6-80
6.26 Digital I/O	6-81
6.26.1 Summary	6-81
6.26.2 Interface	6-82
6.27 I/O device	6-83
6.27.1 Summary	6-83
6.27.2 Interface	6-84
6.28 Servo amplifier general I/O	6-87
6.28.1 Summary	6-87
6.28.2 Settings	6-89
6.29 Dual port memory exclusive control	6-92
6.29.1 Summary	6-92
6.29.2 Exclusive control of output signals	6-92
6.30 Pass position interrupt	6-94
6.30.1 Summary	6-94
6.30.2 Pass position interrupt setting method	6-95
6.30.3 Interface	6-96
6.30.4 Operation example	6-107
6.31 Mark detection	6-111
6.31.1 Summary	6-111
6.31.2 Interface	6-115
6.31.3 Function details	6-123
6.31.4 Operation example	6-125
6.32 Continuous operation to torque control	6-128
6.32.1 Summary	6-128
6.32.2 Interface	6-130
6.32.3 Control mode switch	6-140
6.32.4 Operation timing	6-142
6.32.5 Operation during continuous operation to torque control mode	6-146
6.32.6 Stop factors during continuous operation to torque control	6-147
6.32.7 Combinations of continuous operation to torque control and other functions	6-149

6.32.8 Restrictions on servo amplifier functions	6-151
6.33 SSCNET III/H head module connection	6-152
6.33.1 Summary	6-152
6.33.2 Supported functions	6-153
6.33.3 System startup	6-154
6.33.4 Interface	6-156
6.33.5 Example of setting procedure	6-163
6.33.6 SSCNET III/H head module disconnect	6-165
6.34 Sensing module connection	6-166
6.34.1 Summary	6-166
6.34.2 Supported functions	6-168
6.34.3 System startup	6-170
6.34.4 Interface	6-172
6.34.5 Example of setting procedure	6-203
6.34.6 SSCNET III/H head module disconnect	6-205

7. AUXILIARY FUNCTION

7- 1 to 7-122

7.1 Reading/writing parameters	7- 1
7.1.1 Writing parameters	7- 1
7.1.2 Reading parameters	7- 3
7.2 Changing parameters at the servo	7- 4
7.3 Alarm and system error	7- 6
7.4 Monitor function	7- 9
7.4.1 Summary	7- 9
7.4.2 Monitor latch function	7-11
7.5 High speed monitor function	7-12
7.5.1 Summary	7-12
7.5.2 Monitor latch function	7-13
7.6 Interrupt	7-14
7.6.1 Interrupt sequence	7-14
7.6.2 Interrupt conditions	7-16
7.6.3 Factor of interrupt	7-18
7.6.4 Interrupt processing example	7-27
7.7 User watchdog function	7-28
7.8 Software reboot function	7-29
7.9 Parameter backup	7-30
7.10 Test mode	7-34
7.10.1 Structural diagram	7-34
7.10.2 Test operation mode	7-35
7.11 Reconnect/disconnect function	7-36
7.11.1 Disconnection function summary	7-36
7.11.2 Reconnect function summary	7-37
7.11.3 Interface	7-39
7.11.4 Disconnection method	7-40
7.11.5 Reconnection method	7-41
7.11.6 Restrictions	7-42
7.12 Sampling	7-43
7.12.1 Summary	7-43

7.12.2 Command/status bit	7-44
7.12.3 Command/status data	7-47
7.12.4 Sampling setting write/read.....	7-50
7.12.5 Details for sampling function settings	7-51
7.12.6 Number of sampled points	7-57
7.12.7 Sampling items	7-58
7.12.8 Sampling trigger	7-64
7.12.9 Sampling data read	7-67
7.12.10 Timing chart for sampling function.....	7-69
7.13 Log	7-78
7.13.1 Summary	7-78
7.13.2 Log data details	7-79
7.13.3 Event code list	7-80
7.13.4 Information for each event	7-82
7.13.5 Log function interface.....	7-92
7.13.6 Timing chart for reading of log data	7-95
7.13.7 Log acquiring selection	7-95
7.14 Operation cycle monitor function.....	7-96
7.14.1 Summary	7-96
7.14.2 Interface.....	7-96
7.14.3 Operation timing	7-97
7.15 External forced stop disabled	7-99
7.15.1 Summary	7-99
7.15.2 Interface.....	7-99
7.15.3 Setting method	7-99
7.16 Amplifier-less axis function	7-100
7.16.1 Summary	7-100
7.16.2 Interface.....	7-100
7.16.3 Control details.....	7-101
7.17 Alarm history function	7-102
7.17.1 Summary	7-102
7.17.2 Alarm history data details.....	7-103
7.17.3 Interface.....	7-108
7.17.4 Timing chart for alarm history read.....	7-111
7.17.5 Alarm history initialization procedure.....	7-112
7.17.6 List of system errors that do not apply to alarm history storage.....	7-112
7.18 Transient transmit	7-113
7.18.1 Summary	7-113
7.18.2 Interface.....	7-113
7.18.3 Transient commands for servo amplifier	7-115
7.18.4 Example of using transient commands	7-118
7.18.5 Transient commands for SSCNETⅢ/H head module	7-119
7.19 Hot line forced stop function	7-120
7.19.1 Summary	7-120
7.19.2 Control details.....	7-121
7.19.3 Timing for alarm occurrences	7-122

8. TANDEM DRIVE

8- 1 to 8-34

8.1 Drive modes	8- 1
8.1.1 Synchronous mode	8- 2
8.1.2 Non-synchronous micro-adjustment control mode	8- 2
8.1.3 Changing of drive mode	8- 3
8.2 Parameter settings	8- 4
8.2.1 Designation of tandem drive axes	8- 4
8.2.2 Servo parameters	8- 4
8.2.3 Control parameters	8- 4
8.3 Axis data classifications	8- 5
8.3.1 Only data from master axis is valid	8- 5
8.3.2 Individual data for master axis/slave axis	8- 5
8.4 Tandem drive axis operation	8- 6
8.4.1 Home position return during tandem drive	8- 6
8.4.2 JOG operation during tandem drive	8-25
8.4.3 Incremental feed while using tandem drive	8-26
8.4.4 Automatic operation during tandem drive	8-27
8.4.5 Linear interpolation during tandem drive	8-28
8.5 Servo on and servo off during tandem drive axis operation	8-30
8.6 Tandem drive axis limit switch	8-31
8.7 Tandem drive axis software limit	8-32
8.8 Tandem drive interference check	8-32
8.9 Tandem drive axis servo alarms	8-33
8.10 Deviation monitoring function	8-33

9. INTERFACE MODE

9- 1 to 9-44

9.1 Summary	9- 1
9.2 Combinations with functions	9- 2
9.3 Parameters	9- 4
9.4 Interface	9- 6
9.5 Control method	9-11
9.5.1 Control mode	9-11
9.5.2 Position control mode	9-12
9.5.3 Speed control mode	9-14
9.5.4 Torque control mode	9-16
9.5.5 Control method for interrupt output invalid	9-18
9.5.6 Control method for interrupt output valid	9-21
9.5.7 Procedure for switching control mode	9-26
9.5.8 Examples of switching control mode	9-28
9.6 Interrupt output cycle	9-31
9.7 Command data update cycle	9-32
9.8 Event detection function	9-33
9.9 Servo off	9-36
9.10 Home position return	9-37
9.11 Coordinate management	9-39
9.11.1 Incremental system	9-39
9.11.2 Absolute position system	9-41
9.12 Precautions	9-43

10. TABLE MAP	10- 1 to 10-62
----------------------	-----------------------

10.1 Table list	10- 1
10.2 System information	10- 3
10.3 System command/status table	10- 5
10.4 Factor of interrupt.....	10-17
10.5 Factor of event	10-26
10.6 System configuration information table	10-28
10.7 Axis data.....	10-29
10.7.1 Axis data command table.....	10-29
10.7.2 Axis data status table.....	10-36
10.8 Remote I/O data.....	10-44
10.8.1 RIO data command table	10-44
10.8.2 RIO data status table	10-47
10.9 Servo parameter change number.....	10-50
10.10 Transient transmit command/status table	10-53
10.11 Point number offset.....	10-54
10.12 Command buffers	10-55
10.13 Digital I/O table.....	10-57
10.14 I/O device table	10-58
10.15 Mark detection command/status table	10-59
10.16 Mark detection data tables.....	10-60
10.17 Continuous operation to torque control data table.....	10-61
10.18 Interpolation group No. being executed table	10-61

11. PARAMETERS	11- 1 to 11-54
-----------------------	-----------------------

11.1 System parameters	11- 2
11.2 Servo parameters.....	11- 5
11.2.1 Servo amplifier MR-J4(W□)-□B	11- 5
11.3 Control parameters	11-22
11.4 RIO module parameters	11-39
11.4.1 SSCNET III/H head module	11-39
11.4.2 Sensing module.....	11-39
11.5 RIO control parameters.....	11-51

12. MONITOR NUMBER	12- 1 to 12-24
---------------------------	-----------------------

12.1 Servo information (1)	12- 1
12.2 Servo information (2)	12- 3
12.3 RIO information	12- 8
12.4 Operation information	12-11
12.5 Operation information (double word).....	12-14
12.6 RIO control information	12-15
12.7 System information	12-17
12.8 Servo parameter information	12-19

13. ALARM NUMBER	13- 1 to 13-14
-------------------------	-----------------------

13.1 System alarm	13- 1
13.2 Servo alarm	13- 2
13.2.1 Servo amplifier MR-J4(W□)-□B	13- 2

13.3 RIO module alarm	13- 4
13.3.1 SSCNETⅢ/H head module	13- 4
13.3.2 Sensing module.....	13- 4
13.4 Operation alarm	13- 5
13.5 RIO control alarm	13-12
13.6 System error.....	13-13

14. EMC DIRECTIVE	14- 1 to 14- 6
--------------------------	-----------------------

14.1 Requirements for compliance with the EMC directive	14- 1
14.1.1 Standards relevant to the EMC directive.....	14- 2
14.1.2 Installation instructions for EMC directive	14- 3
14.1.3 Parts of measure against noise	14- 4
14.1.4 Example of measure against noise	14- 5

APPENDIX	App.- 1 to App.-52
-----------------	---------------------------

App. 1 Supplementary explanation for the use of linear servo system	App.- 1
App. 1.1 Q173SCCF	App.- 1
App. 1.2 Utility software.....	App.- 1
App. 1.3 Servo amplifier	App.- 1
App. 1.4 Operations and functions of the linear servo system	App.- 2
App. 2 Supplementary explanation for the use of fully closed loop system	App.-13
App. 2.1 Q173SCCF	App.-13
App. 2.2 Utility software.....	App.-13
App. 2.3 Servo amplifier	App.-13
App. 2.4 Operations and functions of the fully closed loop control.....	App.-14
App. 3 Supplementary explanation for the use of direct drive servo system	App.-21
App. 3.1 Q173SCCF	App.-21
App. 3.2 Utility software.....	App.-21
App. 3.3 Servo amplifier	App.-21
App. 3.4 Operations and functions of the direct drive servo system	App.-22
App. 4 Supplementary explanation for the use of multiple-axis servo amplifier (MR-J4W□-□B)	App.-28
App. 4.1 Q173SCCF	App.-28
App. 4.2 Utility software.....	App.-28
App. 4.3 Servo amplifier	App.-28
App. 4.4 Operations and functions of the servo amplifier	App.-28
App. 5 Supplementary explanation for the use of (MR-JE-□B).....	App.-30
App. 5.1 Q173SCCF	App.-30
App. 5.2 Utility software.....	App.-30
App. 5.3 Servo amplifier	App.-30
App. 5.4 System configuration	App.-31
App. 5.4.1 System configuration diagram	App.-31
App. 5.5 Axis No. setting	App.-32
App. 5.5.1 Servo amplifier setting.....	App.-32
App. 5.6 Parameter setting	App.-33
App. 5.6.1 System option 1 setting.....	App.-33
App. 5.7 Axis No. assignment.....	App.-35
App. 5.8 Sensor input option setting.....	App.-36
App. 5.9 Vendor ID and type code setting.....	App.-37

App. 5.10 Supported functions.....	App.-38
App. 5.10.1 Application functions	App.-40
App. 5.10.2 Auxiliary function	App.-40
App. 5.11 Table map	App.-41
App. 5.12 Parameters	App.-41
App. 5.12.1 System parameters	App.-41
App. 5.12.2 Servo parameters.....	App.-42
App. 5.12.3 Control parameters	App.-42
App. 5.13 Monitor	App.-43
App. 5.14 System alarm	App.-43
App. 5.14.1 Servo alarm	App.-43
App. 6 Cables	App.-45
App. 6.1 SSCNETIII cables	App.-45
App. 6.2 Forced stop input cable	App.-48
App. 6.3 SSCNETIII cables (SC-J3BUS□M-C) manufactured by Mitsubishi Electric System & Service Co., Ltd.....	App.-49
App. 7 Exterior dimensions	App.-50
App. 7.1 C Controller interface module (Q173SCCF).....	App.-50
App. 7.2 Connectors.....	App.-51

About Manuals

The following manuals are also related to this product.

In necessary, order them by quoting the details in the tables below.

Related Manuals

(1) C Controller interface module

Manual Name	Manual Number (Model Code)
Q173SCCF C Controller Interface Module User's Manual (Details) This manual explains specifications of the Q173SCCF, information on how to establish a system, maintenance/inspection, trouble shooting, functions for the positioning control of the Q173SCCF, programming, dual port memory and others.	IB-0300217 (1XB964)
Q173SCCF C Controller Interface Module User's Manual (API Library) This manual explains the library of functions and others that the C Controller module uses to control the Q173SCCF.	IB-0300219 (1XB966)

(2) CPU module

Manual Name	Manual Number (Model Code)
C Controller Module User's Manual (Q24DHCCPU-V) This manual explains the system configuration, specifications, functions, handling, wiring, trouble shooting, as well as the functions, programming and others for C Controller module.	SH-081130ENG (13JZ75)
QCPU User's Manual (Hardware Design, Maintenance and Inspection) This manual explains the specifications of the QCPU modules, power supply modules, base units, extension cables, memory card battery, and the maintenance/inspection for the system, trouble shooting, error codes and others.	SH-080483ENG (13JR73)
QnUCPU User's Manual (Function Explanation, Program Fundamentals) This manual explains the functions, programming methods and devices and others to create programs with the QCPU.	SH-080807ENG (13JZ27)

(3) Programming tool

Manual Name	Manual Number (Model Code)
Setting/Monitoring Tools for the C Controller Module Operating Manual This manual explains the system configuration, operation method and others for setting/monitoring tool for the C Controller module.	SH-081131ENG (13JU76)
CW Workbench Operating Manual This manual explains the system configuration, specifications, functions, troubleshooting and others for CW Workbench.	SH-080982ENG (13JU71)

(4) Servo amplifier

Manual Name	Manual Number (Model Code)
SSCNETⅢ/H interface AC Servo MR-J4_B(-RJ)/MR-J4_B4(-RJ)/MR-J4_B1(-RJ) Servo amplifier Instruction Manual This manual explains the I/O signals, parts names, parameters, start-up procedure and others for AC Servo MR-J4_B(-RJ)/MR-J4_B4(-RJ)/MR-J4_B1(-RJ) Servo amplifier.	SH-030106 (1CW805)
SSCNETⅢ/H interface Multi-axis AC Servo MR-J4W2-_B/MR-J4W3-_B Servo amplifier Instruction Manual This manual explains the I/O signals, parts names, parameters, start-up procedure and others for Multi-axis AC Servo MR-J4W2-_B/MR-J4W3-_B Servo amplifier.	SH-030105 (1CW806)
SSCNETⅢ/H interface AC Servo MR-JE-_B Servo amplifier Instruction Manual This manual explains the I/O signals, parts names, parameters, start-up procedure and others for AC Servo MR-JE-_B Servo amplifier.	SH-030152 (1CW750)

MEMO

1. SUMMARY

1. SUMMARY

1.1 Summary

This manual describes the specifications and handling of SSCNETⅢ/H compatible C Controller interface module (Q173SCCF).

In this manual, the following abbreviations are used.

Generic term/Abbreviation	Description
Q173SCCF or C Controller interface module	Q173SCCF C Controller interface module.
Q24DHCCPU-V or C Controller module	General name for C Controller module (Q24DHCCPU-V).
MR-J4(W□)-□B	Servo amplifier model MR-J4-□B/MR-J4W□-□B.
MR-JE-□B	Servo amplifier model MR-JE-□B.
Servo amplifier	General name for SSCNETⅢ/H compatible servo amplifier.
Utility software	General name for the C Controller interface module utility (SW1DNC-QSCCF-B) which includes test tool for start-up and examination, and the API library for Q173SCCF.
Test tool	Abbreviation for start-up and examination tool for Q173SCCF.
API library	General name for the library of functions for VxWorks that the C Controller module uses to control the Q173SCCF.
Setting/monitoring tool for the C Controller module	General name for the Setting/monitoring tool for the C Controller module (SW4PVC-CCPU-E).
CW Workbench	General name for CW Workbench (SW1DND-CWWLQ24-E), the engineering tool for the C Controller module.
Wind River Workbench	General name for Wind River Workbench 3.2 made by Wind River Systems.
MR Configurator2	Abbreviation for the Servo set-up software MR Configurator2 version 1.10L or later.
User program	Program created by the user that operates on the C Controller module.
System program	Internal program that controls the Q173SCCF.
VxWorks	Product name for the real-time OS made by Wind River Systems.
SSCNETⅢ/H(Note)	High-speed synchronized network between the Q173SCCF and the servo amplifier.
PCIe	Notation for PCI Express.
Board Ver.	System version of Q173SCCF.
API Ver.	Software version of the API library for Q173SCCF.
Remote I/O module	General name for modules that connect I/O modules and intelligent function modules to SSCNETⅢ/H, including the sensing module and SSCNETⅢ/H head module.
SSCNETⅢ/H head module	General name for MELSEC L series SSCNETⅢ/H head module (LJ72MS15).
Sensing module	General name for SSCNETⅢ/H compatible sensing module MR-MT2000 series
Sensing SSCNETⅢ/H head module or MR-MT2010	Abbreviation for SSCNETⅢ/H head module (MR-MT2010)
Sensing extension module	General name for I/O module (MR-MT2100), pulse I/O module (MR-MT2200), analog I/O module (MR-MT2300), encoder I/F module (MR-MT2400)
Sensing I/O module or MR-MT2100	Abbreviation for I/O module (MR-MT2100)
Sensing pulse I/O module or MR-MT2200	Abbreviation for pulse I/O module (MR-MT2200)
Sensing analog I/O module or MR-MT2300	Abbreviation for analog I/O module (MR-MT2300)
Sensing encoder I/F module or MR-MT2400	Abbreviation for encoder I/F module (MR-MT2400)
Remote register (RW _r)	Information for inputting to the Q173SCCF from the sensing module, and SSCNETⅢ/H head module in a 16-bit (1 word) basis.
Remote register (RW _w)	Information for outputting to the sensing module, and SSCNETⅢ/H head module from the Q173SCCF in a 16-bit (1 word) basis.

1. SUMMARY

Generic term/Abbreviation	Description
Remote input (RX)	Information input from the sensing module, and SSCNET III/H head module to the Q173SCCF in a 1-bit basis.
Remote output (RY)	Information output from the Q173SCCF to the sensing module, and SSCNET III/H head module in a 1-bit basis.
Link device	Internal devices (RX/Ry/RW _r /RW _w) of the Q173SCCF, sensing module, and SSCNET III/H head module.

Note. SSCNET: Servo System Controller NETwork

1. SUMMARY

(1) C Controller interface module

The C Controller interface module (Q173SCCF) is an SSCNET interface positioning controller connected to the C Controller module (Q24DHCCPU-V) system via PCIe and controls our servo amplifiers (MR-J4(W□)-□B) and remote I/O modules (sensing module (MR-MT2000 series) and SSCNETⅢ/H head module (LJ72MS15)). The Q173SCCF and the servo amplifiers are connected with SSCNETⅢ/H, which is a high speed synchronous network.

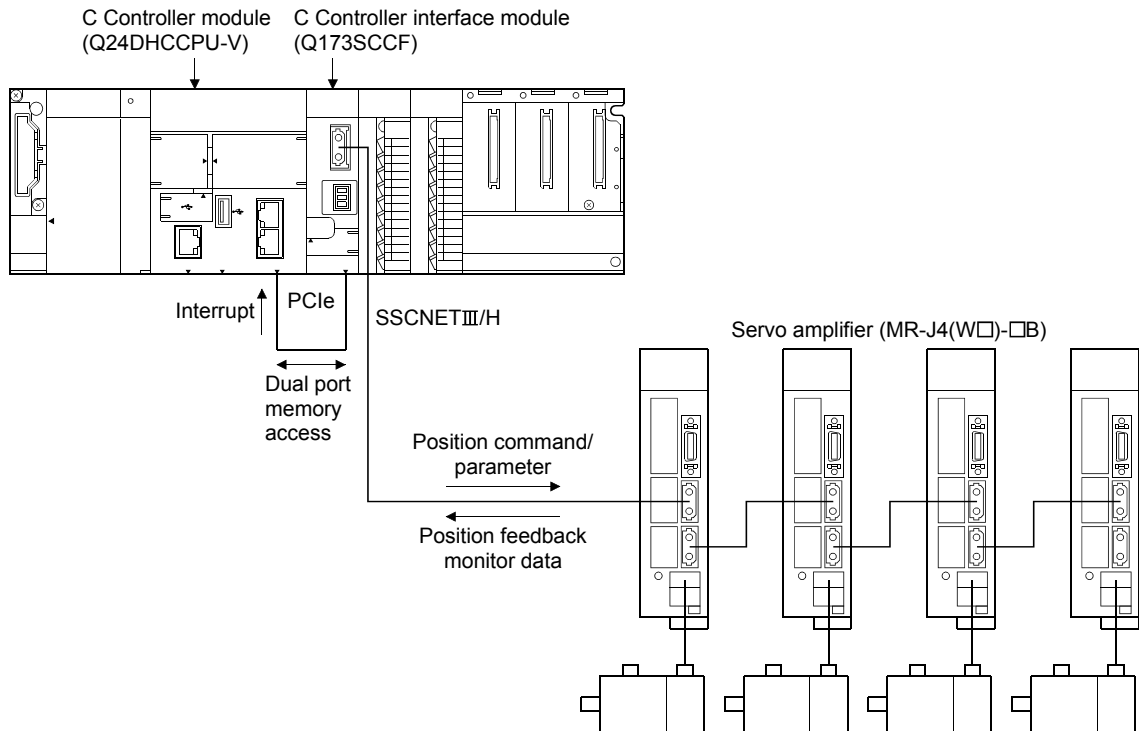

The Q173SCCF has one SSCNET control channel (hereinafter: CH) and one SSCNET line (hereinafter: line), and can control positioning for up to 20 axes and remote I/O control for up to 4 stations. By reading and writing the dual port memory mapped to the memory space of the PCIe bus, the C Controller module can command Q173SCCF to start operation, and get servo amplifier status. The C Controller module can also receive position pass and positioning complete interruptions via PCIe bus.

The Q173SCCF is equipped with standard mode and interface mode for positioning control. The positioning control mode that corresponds with the application can be selected by parameter. The mode cannot be changed during SSCNET communication (while system is running). Positioning in standard mode is performed using a point table mapped on the dual port memory of the Q173SCCF. Arbitrary positioning is possible by writing data to this point table from the C Controller module.

Also, startup of JOG operation and home position return, etc. as well as parameters changing and monitoring are possible through accessing this dual port memory on the Q173SCCF from the C Controller module.

Interface mode is a sequential positioning command method that uses a user program on the C Controller module. The user program controls the servo amplifier with an arbitrary acceleration/deceleration pattern by writing the position command to the position command buffer of the Q173SCCF every communication cycle (control cycle). Some functions from standard mode cannot be used, or are restricted when in interface mode.

1. SUMMARY

1.2 Features of Q173SCCF

The Q173SCCF has the following features.

(1) Direct connection to C Controller module by PCIe bus

Direct access to the dual port memory of the Q173SCCF from the C Controller module enables the structuring of a high-speed, flexible system that utilizes the performance of the C Controller module.

(2) Programming in C programming language with the API library

Positioning control for the servo in C programming language is enabled with the API library included with the C Controller interface module utility (SW1DNC-QSCCF-B). Creating a device driver for the PCIe bus is not required.

(3) Supports event-driven programming

The C Controller module is notified by interrupt via PCIe bus when the conditions for an interrupt such as passing through a preset point or positioning complete are met. The user program can create event-driven programs according to interrupt factors.

(4) High-speed operation starting time

High-speed operation starting time within the control cycle (0.22ms fastest) is achieved for the maximum number of synchronous startup axes or less.

(5) Wide variety of positioning control functions

The main functions (such as home position return control, standard mode, and interface mode (sequential positioning command method)) which are required for any positioning system and the sub functions which limit and add functions to those controls are supported.

(a) Enhanced home position return control

Additional features of home position return control

Ten home position return methods are provided: dog cradle method, dog method, data set method, continuous operation to torque method, limit switch combined method, scale home position signal detection method, limit switch front end method, dog front end method, Z-phase detection method, and scale home position signal detection method 2. Select an applicable method according to the system.

(b) Wide variety of control methods

Positioning control methods such as positioning control are provided.

1) Independent control of each axis

Position control can be performed independently for each axis at any given timing.

2) Interpolation control

Interpolation controls using multiple axes can be performed.

(2-axis to 4-axis linear interpolation control)

3) Tandem drive

Tandem drive for 2 axes can be performed. In scale home position signal detection method and scale home position signal detection method 2, the deviation between the 2 axes at home position return can be compensated.

4) Interface mode

The user program controls the servo amplifier with an arbitrary acceleration/deceleration pattern that is not supported in standard mode by writing the position command to the position command buffer of the Q173SCCF every communication cycle (control cycle).

1. SUMMARY

(c) Continuous processing of multiple positioning data

Multiple positioning data can be processed continuously within one operation start.

(d) Acceleration/deceleration processing

Four acceleration/deceleration processing methods are provided: Linear acceleration/deceleration, S-curve acceleration/deceleration, start up speed, and smoothing filter.

The acceleration/deceleration curve can be selected according to the machine characteristic.

(6) Supports other axes start function

With the other axes start function, the Q173SCCF can determine the conditions and automatically start other axes, and turn on/off output signals. The Q173SCCF does not go through user program processing so there are no delays or dispersions. This also lessens the load on the user program.

(7) High maintainability

Maintainability is enhanced in the Q173SCCF.

(a) Data retention without battery

Parameter data can be stored in the flash ROM inside the Q173SCCF. This feature allows the module retain the data without a battery.

(b) Alarm collection function

The alarm details when an alarm occurs are automatically stored in the flash ROM inside the Q173SCCF.

Storing the alarm information allows the user to check the alarm from the user program or test tool even after the module is powered off or reset.

(8) Setting, monitoring, and testing through test tool

Using the test tool of C Controller interface module utility (SW1DNC-QSCCF-B), users can check the validity of the preset parameters and point table by performing test operation of the Q173SCCF before creating a user program.

The control monitor/graph function allows users to debug programs efficiently.

(9) Forced stop function

The batch forced stop is available for connected servo amplifiers by the forced stop input signal of the external input.

(10) Connection between the Q173SCCF and servo amplifier with high speed synchronous network by SSCNETⅢ/H

The Q173SCCF can be directly connected to the Mitsubishi Electric servo amplifiers of MR-J4(W□)-□B series using the SSCNETⅢ/H.

(a) Because the high speed synchronous network by SSCNETⅢ/H is used to connect the Q173SCCF and the servo amplifier, or servo amplifiers, saving wiring can be achieved. The maximum distance between the Q173SCCF and servo amplifier, or servo amplifier and servo amplifier for the SSCNETⅢ cable on the same bus is 100(328.08)[m(ft.)]. This increases flexibility at system design.

(b) By using SSCNETⅢ cable (optical communication), the influence of electromagnetic noise etc. from servo amplifiers and such are reduced.

(c) The servo parameters can be set on the Q173SCCF side to write or read them to/from the servo amplifier using the SSCNET communication.

1. SUMMARY

- (d) The current feedback position and error description contained in the servo can be checked by the dual port memory of the Q173SCCF.
 - (e) The communication between the MR Configurator2 and servo amplifiers is possible via the Q173SCCF USB.
- (11) Easy application to the absolute position system
- (a) The MR-J4(W□)-□B series servo amplifiers and servo motors support the absolute position system. Absolute position system can be used by connecting the battery for absolute position system to the servo amplifier.
 - (b) Once the home position has been established, the home position return operation is unnecessary at the system's power supply ON.
 - (c) With the absolute position system, the data set method home position return is used to establish the home position. The wiring of proximity dog, etc. is unnecessary.

1. SUMMARY

1.3 Specifications

1.3.1 General specifications

General specifications of the Q173SCCF are shown below.

Item	Specification					
Operating ambient temperature	0 to 55°C (32 to 131°F)					
Storage ambient temperature	-25 to 75°C (-13 to 167°F)					
Operating ambient humidity	5 to 95% RH, non-condensing					
Storage ambient humidity	5 to 95% RH, non-condensing					
Vibration resistance	Compliant with JIS B 3502 and IEC 61131-2	Under intermittent vibration	Frequency	Constant acceleration	Half amplitude	Sweep count
			5 to 8.4Hz	—	3.5mm (0.14inch)	
		Under continuous vibration	8.4 to 150Hz	9.8m/s ²	—	10 times each in X, Y, Z directions
			5 to 8.4Hz	—	1.75mm (0.07inch)	
		8.4 to 150Hz	4.9m/s ²	—	—	
Shock resistance	Compliant with JIS B 3502 and IEC 61131-2 (147m/s ² , 3 times in each of 3 directions X, Y, Z)					
Operating ambience	No corrosive gases					
Operating altitude (Note 1)	2000m(6561.68ft.) or less					
Mounting location	Inside control panel					
Overvoltage category (Note 2)	II or less					
Pollution level (Note 3)	2 or less					

Note 1. Do not use or store the Q173SCCF under pressure higher than the atmospheric pressure of altitude 0m. Doing so can cause an operation failure. When using the module under pressure, please contact with our sales representative.

2. This indicates the section of the power supply to which the equipment is assumed to be connected between the public electrical power distribution network and the machinery within premises.

Category II applies to equipment for which electrical power is supplied from fixed facilities.

The surge voltage withstand level for up to the rated voltage of 300V is 2500V.

3. This index indicates the degree to which conductive material is generated in terms of the environment in which the equipment is used.

Pollution level 2 is when only non-conductive pollution occurs. A temporary conductivity caused by condensing must be expected occasionally.

⚠ CAUTION

- The Q173SCCF must be stored and used under the conditions listed in the table of specifications above.
- When not using the module for a long time, disconnect the power line from the module or servo amplifier.
- Place the module and servo amplifier in static electricity preventing vinyl bags and store.
- When storing for a long time, please contact with our sales representative.
Also, execute a trial operation.

1. SUMMARY

1.3.2 List of specifications of Q173SCCF

(1) Basic specifications of Q173SCCF

Item	Specification
Internal current consumption (5VDC) [A]	0.7
Mass [kg]	0.17
Exterior dimensions [mm(inch)]	98 (3.86)(H) × 27.4 (1.08)(W) × 115 (4.53)(D)

(2) Q173SCCF control specifications

Function	Contents	Remarks	
System function	Control cycle	0.88ms/0.44ms/0.22ms(Select using parameters.)	
	Control axes	Max 20(0.88ms)/Max 16(0.44ms)/Max 8(0.22ms)	
	Control mode	Standard mode: Position controlling method by Q173SCCF Interface mode: Sequential positioning command method by user program	
	SSCNET communication	SSCNET III/H	
Operation function (Note 1, 2)	JOG operation	Provided	
	Incremental feed	Provided	
	Automatic operation	Point table method, 1 axis control, Continuous operation to torque control	
	Linear interpolation	Point table method, MAX 4 axes interpolation is available	Unavailable when the control cycle is 0.22ms
	Home position return	Dog cradle method, Dog method, Data set method, Stopper method, Limit switch combined method, Scale home position signal detection method, Limit switch front end method, Dog front end method, Z-phase detection method, Scale home position signal detection method 2	Can indicate direction for home position return Proximity dog is for level detection Can change home position return method while system is running
	Home position reset (data set)	The current position can be reset to the home position	
Application function	Electronic gear	Electronic gear numerator : 1 to 5242879 Electronic gear denominator : 1 to 589823	
	Speed units	Command unit/min, command unit/s, and r/min can be selected.	
	Acceleration/deceleration	Command speed limits: 1 to speed limit Limits of start speed: 1 to speed limit Time constant limits: 0 to 20000 ms/speed limit Separate setting of constants for deceleration and acceleration: provided Setting of constants for separate points: provided Acceleration/deceleration method: Linear acceleration/deceleration, smoothing filter, start up speed, S-curve acceleration/deceleration (sine acceleration/deceleration)	
	Stop function	Forced stop, Stop operation, Rapid stop operation	
	Limit switch	Provided (Hardware stroke limit)	
	Software limit	Provided (Software stroke limit)	
	Interlock	Provided	
	Rough match output	Provided	
	Torque limit	Provided	
	Command change	Location, speed, time constant	
	Backlash	Provided	
Position switch	Provided		
Completion of operation signal	Provided		

Note 1. The Q173SCCF can move within the limits of -2147483648 to 2147483647. Movement outside the limits is not covered with warranty. If software limits have been disabled, be careful not to move it outside of the physical limits.

2. For the absolute position detection system, the command limits of the position after calculation using the electronic gear are also -2147483648 to 2147483647. It is possible for the moveable limits to be narrower than -2147483648 to 2147483647, depending on the electronic gear.

1. SUMMARY

	Function	Contents	Remarks
Application function	Interference check	Provided	Unavailable when the control cycle is 0.22ms
	Home position search limit	Provided	
	Gain switching	Provided	
	PI-PID switching	Provided	
	Absolute position detection system	Provided	
	Home position return request	Provided	
	Other axes start	Provided	
	High response I/F	Provided	
	In-position signal	Provided	
	Digital I/O	Provided	
	I/O device	Provided	
	Servo amplifier general I/O	Provided	
	Dual port memory exclusive control	Provided	
	Pass position interrupt	Provided	
	Mark detection	Provided	
	Continuous operation to torque control	Provided	
	SSCNET III/H head module connection	Provided	
	Sensing module connection	Provided	
Help function	Reading/writing parameters	Provided	
	Changing parameters at the servo	Provided	
	Alarm and system error	Provided	
	Monitor	Current command position, Current feedback position, Speed command, Position droop, Electrical current command, Servo alarm number, External signal status, etc.	Can be latched
	High speed monitor	Current command position, Current feedback position, Moving speed, Feedback moving speed, External signal, Electrical current feedback, Position droop (interface mode only)	Updated per control cycle Can be latched
	Interrupt	During start operation, Operation stoppage (During operation, in-position, during smoothing of stopping, rough match, etc.) When alarm goes off (servo alarm/operation alarm), etc.	Interrupt generation conditions can be selected.
	User watchdog function	Provided (Check for the watchdog of the of the user program)	Processed by software.(Note 3)
	Software reboot function	Provided	
	Parameter backup	Parameters can be saved to the flash ROM.	
	Test mode	By connecting MR Configurator2 via the Q173SCCF, the servo amplifier can be simply tested.	
	Reconnect/disconnect function	Provided	
	Sampling	The maximum sampling point: 65536. (Ring buffer of 8192 points)	
	Log	History of start operation, alarms, etc, can be recorded.	
	Operation cycle monitor function	Provided	
	External forced stop disabled	Provided	
	Amplifier-less axis function	Provided	
	Alarm history function	Alarm history is saved to the flash ROM.	
	Transient transmit	Provided	
Tandem drive	Up to 2 axes × 8 groups		
Interface mode	Positioning control, Speed-torque control, event detection function		

Note 3. This is not the watch dog for the CPU on the Q173SCCF.

1. SUMMARY

	Function	Contents	Remarks
DI	Limit switch+	None	DI signals are input from the servo amplifier or the dual port memory, etc. by the parameter setting.
	Limit switch—	None	
	Proximity dog	None	
	Forced stop	1 point	
DO		None	

(3) PCIe bus specification

Items	Specification
Link width	× 1
Transfer rate	2.5Gbps(Gen1)

1. SUMMARY

1.4 Name of each section

(1) Name of each section of Q173SCCF

The following explains the names and settings for each section of Q173SCCF.

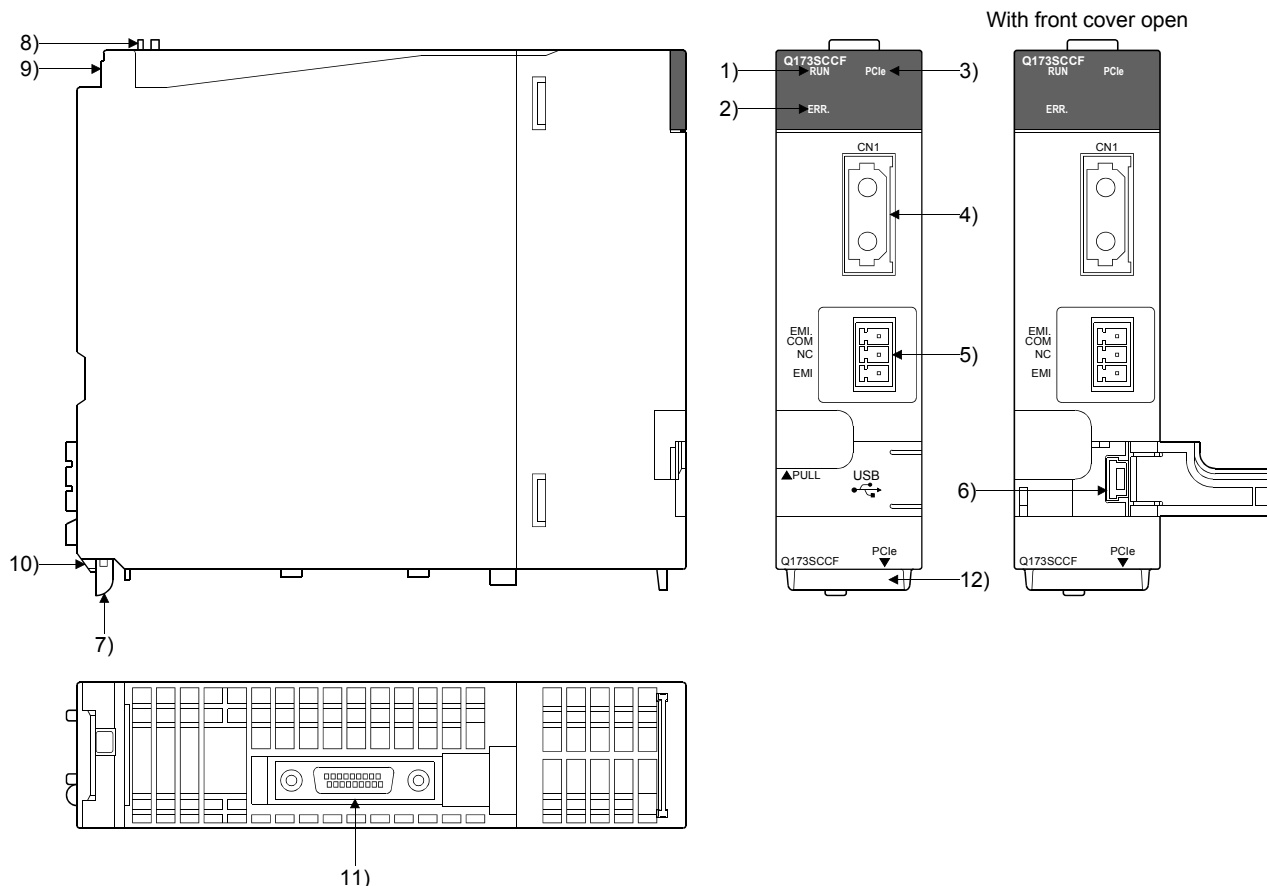

No.	Section	Application
1)	RUN LED (Note 1)	<ul style="list-style-type: none"> • LED ON : Power ON • LED OFF : Power OFF
2)	ERR. LED (Note 1)	<ul style="list-style-type: none"> • LED OFF : Normal • LED ON : System error has occurred (E001 to E302)
3)	PCIe LED	<ul style="list-style-type: none"> • LED ON : Communicating via PCIe
4)	SSCNETIII CN1 connector (Note 2)	Connector for connecting to the servo amplifier.
5)	Forced stop input connector (Note 3)	Input that forces the stop of all axes of a servo amplifier at once. EMI ON(Open) : Forced stop EMI OFF(DC24V input) : Forced stop reset
6)	USB connector	<ul style="list-style-type: none"> • Connector for connecting to USB compatible peripheral equipment.(miniB connector type) • Can be connected with the dedicated USB cable(MR-J3USBCBL3M)
7)	Module mounting lever	Used to install the module to the base unit.
8)	Module fixing hook	Hook used to fix the module to the base unit. (Auxiliary use for installation)
9)	Module fixing screw	Screw used to fix module to the base unit.
10)	Module fixing projection	Hook used to fix module to the base unit.

1. SUMMARY

No.	Section	Application
11)	PCIe connector	<ul style="list-style-type: none"> • Connector for communicating with the C Controller module. • Can be connected with the dedicated PCIe cable (Q173PCIECBL05M)
12)	Serial number display	Displays the serial number on the rating plate.

Note 1. During the hardware initialization immediately after turning power ON or software reboot, both the "RUN LED" and "ERR LED" are ON.

2. Put the SSCNETIII cable in the duct or fix the cable at the closest part to the Q173SCCF with bundle material in order to prevent SSCNETIII cable from putting its own weight on SSCNETIII connector.
3. Be sure to use the cable for forced stop input. The forced stop cannot be released without using it. If the cable for forced stop input is made by the user, make it within 30m(98.43ft).

(2) Forced stop input connector

The following is the pin layout and connections of the forced stop input connector as viewed from the front.

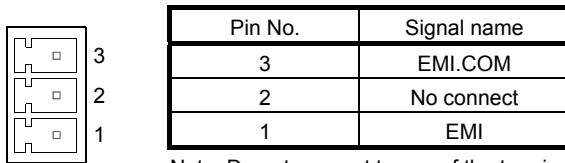

Note. Do not connect to any of the terminals explained as "No connect".

- Applicable connector model name
FK-MCP1.5/3-ST-3.81 connector (PHOENIX CONTACT make) (included)
- Wire
0.12 to 1.3mm² (AWG16 to AWG26)

1. SUMMARY

1.5 Bus interface

1.5.1 Configuration register

The following shows the configuration register of Q173SCCF.

Address	31 to 24	23 to 16	15 to 8	7 to 0	Remarks
00	Device ID 0624		Vendor ID 10BA		Vender ID: Mitsubishi Electric 10BA Device ID: 0624
04	Status		Command		
08	Class Code 118000			Revision ID 01	Revision ID: 01 Class Code: 118000 (data processing controller)
0C	BIST (Note)	Header Type (Note)	Latency Timer (Note)	Cache Line Size (Note)	
10	Base Address Register 0				
14	Base Address Register 1				
18	Base Address Register 2				Dual port memory (including board ID) leading address Memory Space Indicator (bit0): 0 (Memory space) Type (bit1 to 2): 00 (32 bits, arbitrary position of address space) Prefetchable (bit3): 0 (Prefetch prohibited)
1C	Base Address Register 3 (Note)				
20	Base Address Register 4 (Note)				
24	Base Address Register 5 (Note)				
28	Cardbus CIS Pointer (Note)				
2C	Subsystem ID 0601		Subsystem Vendor ID 10BA		Subsystem Vender ID: Mitsubishi Electric 10BA Subsystem ID: 0601
30	Expansion ROM Base Address (Note)				
34	(Reserved) (Note)			CAP_PTR (Note)	
38	(Reserved) (Note)				
3C	Max_Lat (Note)	Min_Gnt (Note)	Interrupt Pin 01	Interrupt Line	Interrupt Pin: 01(INTA use)
40	PM Capability		NxtCap	PM Cap	
44	Data	BSE	PMCSR		
48	MSI Control		NxtCap	MSI Cap	MSI Control(bit0): 0 INTA interrupt
4C	Message Address (Lower)				
50	Message Address (Upper)				
54	Reserved		Message Data		
58	PE Capability		NxtCap	PE Cap	
5C	PCI Express Device Capabilities				
60	Device Status		Device Control		
64	PCI Express Link Capabilities				
68	Link Status		Link Control		
6C to FF	Reserved Legacy Configuration Space (Returns 0x00000000)				
100	Next Cap	Capability Version	PCI Express Extended Capability - DSN		
104	PCI Express Device Serial Number (1st)				
108	PCI Express Device Serial Number (2nd)				
10C to FFF	Reserved Extended Configuration Space (Returns Completion with 0x00000000)				

Note. Has not been implemented, therefore, if read an indefinite value will be returned.

1. SUMMARY

1.5.2 Dual port memory map

The bus width of dual port memory is 32 bits. For the address map of the dual port memory on the Q173SCCF side, refer to Chapter 10.

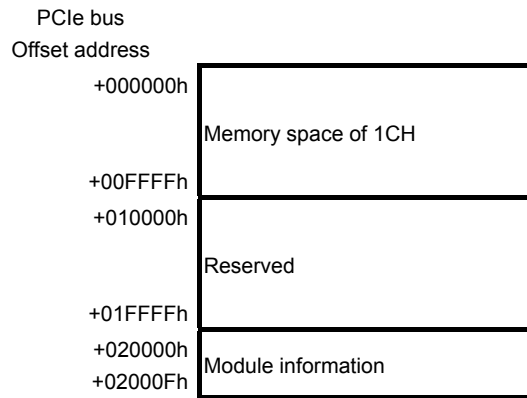

1. SUMMARY

1.5.3 Module information

The (R)s in the table designate read only, while the (W)s designate write only capability.

Address	bit7	bit6	bit5	bit4	bit3	bit2	bit1	bit0
020000	Bus type (R)		Implemented CH information (R)		Reserved		Board ID information (R)	
020001	Reserved						Number of SSCNET lines (R)	
020002	Reserved							
020003								
020004	Reserved						Signal during interrupt output (R)	
020005	Reserved							
020006								
020007								
020008	Reserved						Interrupt signal clear register (1CH) (W)	
020009	Reserved							
02000A								
02000B								
02000C								
02000D	Reserved							
02000E								
02000F								

(1) Board ID information (address 020000h)

Board ID is fixed at 0.

bit1	bit0	Content
0	0	0

(2) Implemented ch information (address 020000h)

bit5	bit4	Content
0	0	1CH
0	1	Reserved
1	0	Reserved
1	1	Reserved

(3) Bus type (address 020000h)

bit7	bit6	Content
0	0	PCI bus
0	1	Reserved
1	0	PCIe bus
1	1	Reserved

(4) Number of SSCNET lines (address 020001h)

bit1	bit0	Content
0	0	1 line
0	1	Reserved
1	0	Reserved
1	1	Reserved

1. SUMMARY

(5) Signal during interrupt output (address 020004h)

bit1	bit0	Content
0	0	Interrupts are not generated
0	1	During interrupt output

(6) Interrupt signal clear register (1CH) (address 020008h)

bit1	bit0	Content
0	0	0: Invalid
0	1	1: 1CH interrupt signal is cleared

1. SUMMARY

1.6 SSCNETIII cables

Connect the Q173SCCF and servo amplifiers, or servo amplifier and servo amplifier by SSCNETIII cable. Up to 20 servo amplifiers can be connected.

(1) SSCNETIII cable specifications

Model name	Cable length [m.(ft.)]	Description
MR-J3BUS□M	MR-J3BUS015M	0.15 (0.49)
	MR-J3BUS03M	0.3 (0.98)
	MR-J3BUS05M	0.5 (1.64)
	MR-J3BUS1M	1 (3.28)
	MR-J3BUS3M	3 (9.84)
MR-J3BUS□M-A	MR-J3BUS5M-A	5 (16.40)
	MR-J3BUS10M-A	10 (32.81)
	MR-J3BUS20M-A	20 (65.62)
MR-J3BUS□M-B	MR-J3BUS30M-B	30 (98.43)
	MR-J3BUS40M-B	40 (131.23)
	MR-J3BUS50M-B	50 (164.04)

• Q173SCCF ↔ Servo amplifier
• Servo amplifier ↔ Servo amplifier

(2) Connection between the Q173SCCF and servo amplifiers

Connect the SSCNETIII cables to the following connectors.

Refer to Section 3.2.1 for the connection and disconnection of SSCNETIII cable.

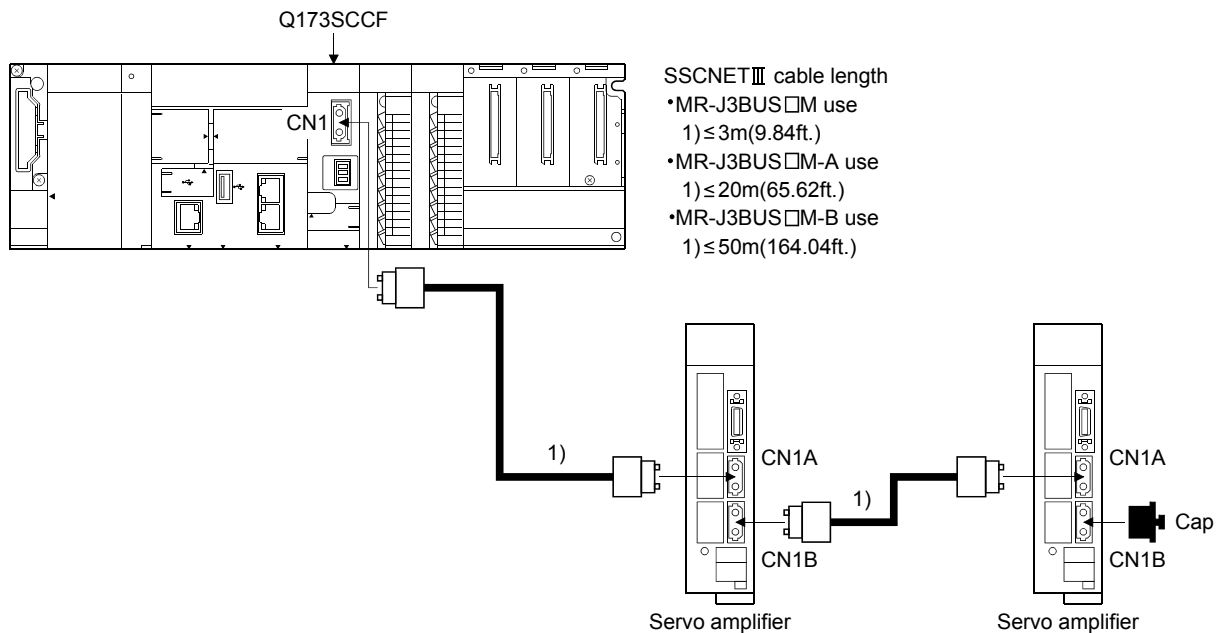

(Note): It cannot communicate if the connection of CN1A and CN1B is mistaken.

1. SUMMARY

1.7 Forced stop input terminal

(1) Table of the forced stop input terminal specifications

Item		Specifications
Number of input points		Forced stop signal : 1 point
Input method		Positive common/Negative common shared type
Rated input current		2.4mA
Isolation method		Photocoupler
Operating voltage range		20.4 to 26.4VDC (+10/ -15%, ripple ratio 5% or less)
ON voltage/current		17.5VDC or more/2.0mA or more
OFF voltage/current		1.8VDC or less/0.18mA or less
Input resistance		Approx. 10k Ω
Response time	OFF to ON	1ms or less
	ON to OFF	
External connector type		3 pin connector
Recommended wire size		0.12 to 1.3mm ² (AWG16 to AWG26)

(2) Forced stop circuit

(a) Positive common

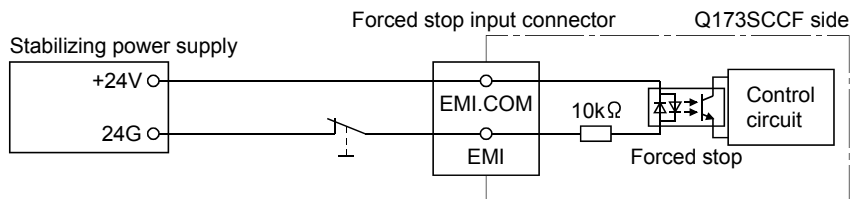

(b) Negative common

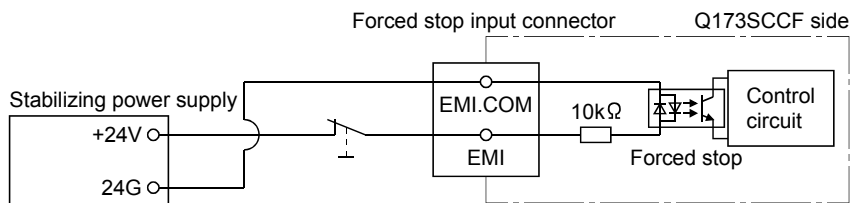

1. SUMMARY

1.8 PCIe cable

A PCIe cable connects the Q173SCCF with the C Controller module. One Q173SCCF can be connected to one C Controller module.

(1) PCIe cable specifications

Manufacturer	Model name	Cable length [m.(ft.)]	Details
Mitsubishi Electric	Q173PCIECBL05M	0.5(1.64)	For connecting the Q173SCCF and C Controller module
Molex Incorporated	74576-0000		

(2) Connection with the Q173SCCF

Connect the PCIe cable to the following connectors.

Refer to Section 3.2.3 for the connection and disconnection of PCIe cable.

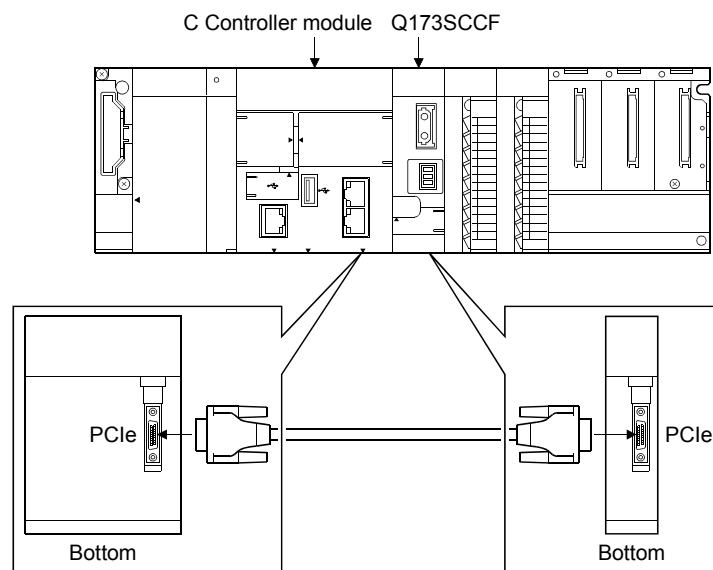

2. SYSTEM CONFIGURATION

2. SYSTEM CONFIGURATION

This section describes the system configuration and equipment settings.

2.1 Equipment configuration of system

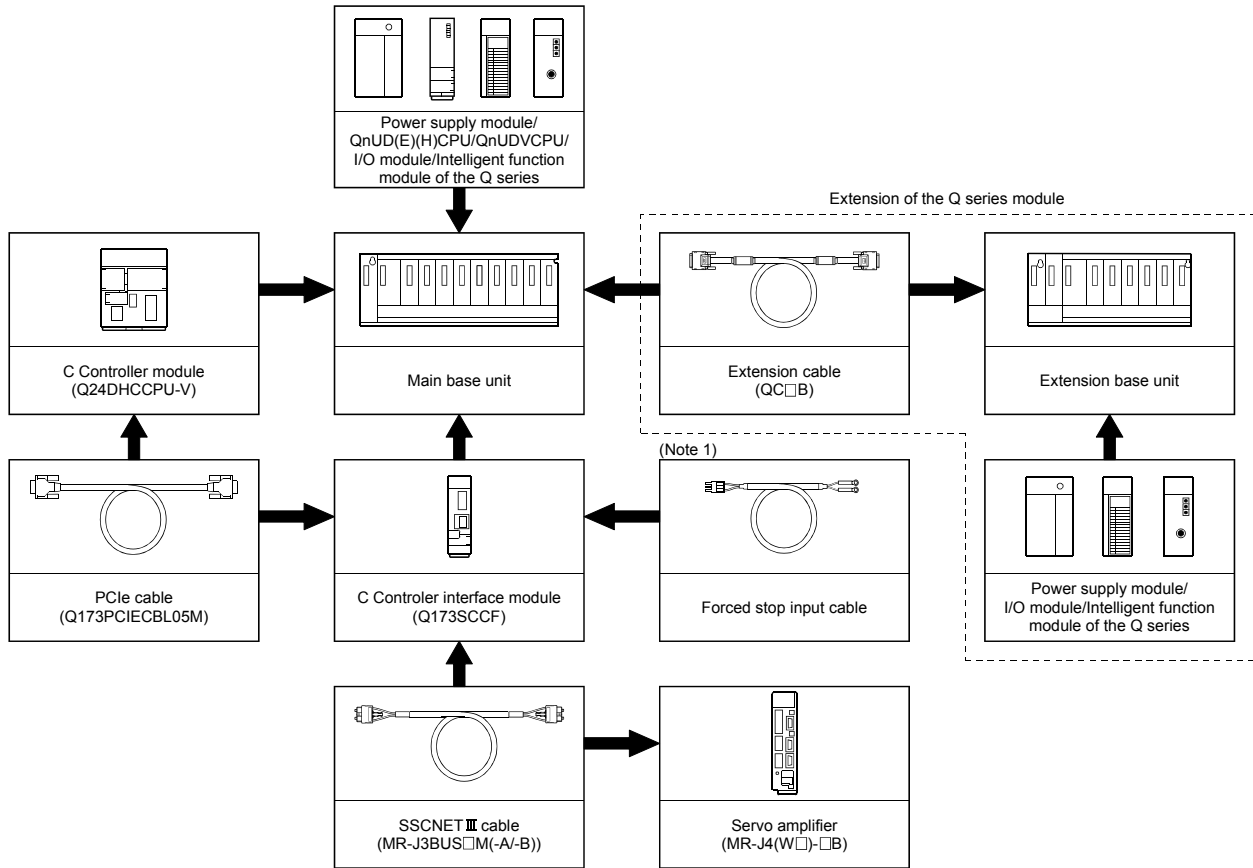

□ Depending on the system, this equipment is optional.

Note 1. Fabricate the forced stop input cable on the customer side.

2. SYSTEM CONFIGURATION

2.2 Q173SCCF system overall configuration

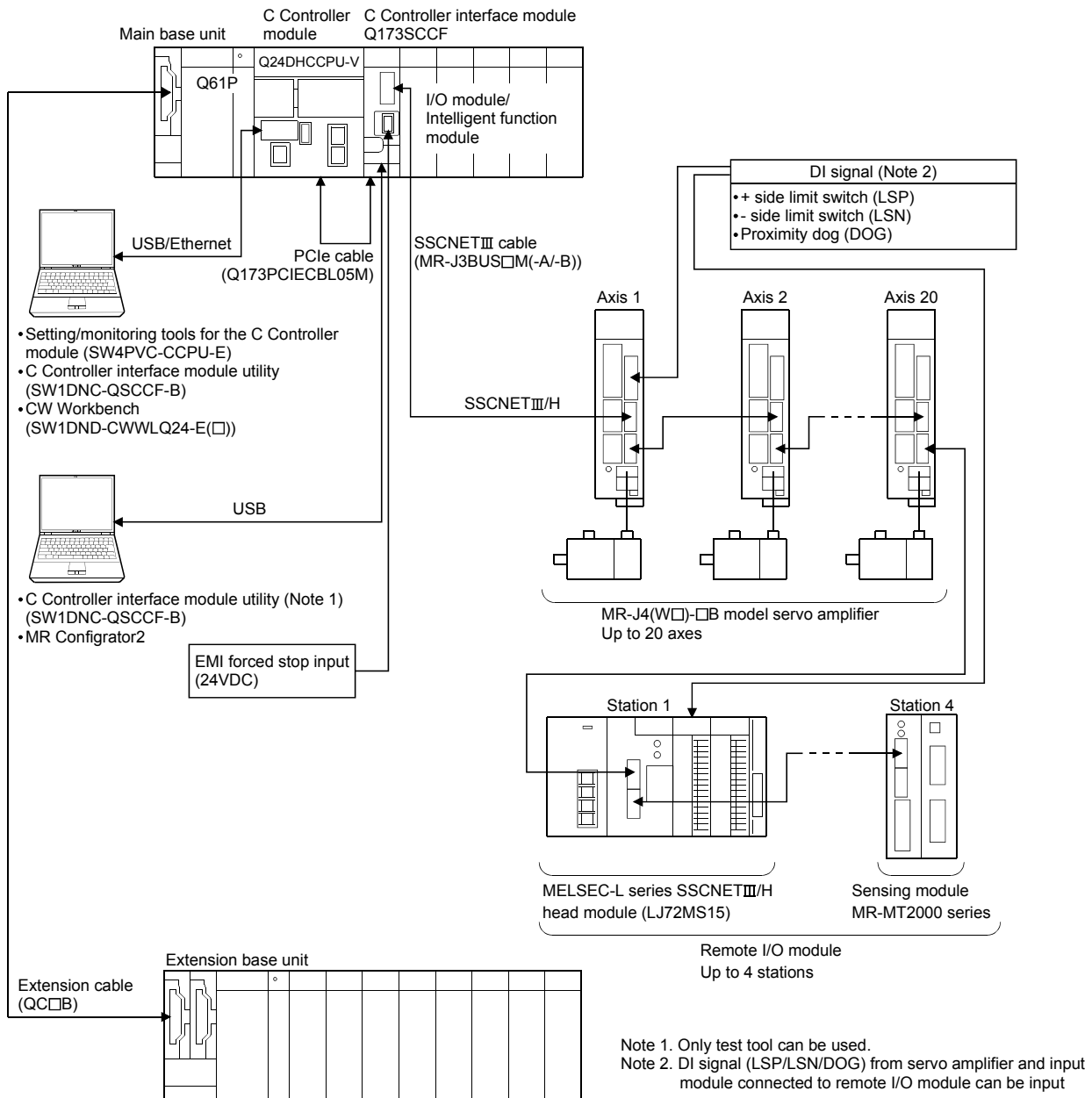

POINT

- One Q173SCCF per C Controller module can be connected via a PCIe bus.
- Install the Q173SCCF to the slot at the right side of the C Controller module.
- Refer to "C Controller Module User's Manual (Q24DHCCPU-V)" for details on power supply modules, base units, I/O modules, intelligent function modules that can be used.

2. SYSTEM CONFIGURATION

2.3 System configuration equipment

(1) Q173SCCF related module

Part name	Model name (Note 1)	Description	Current consumption 5VDC[A]	Remark
C Controller interface module	Q173SCCF	Up to 20 axes control, Operation cycle 0.22[ms], 0.44[ms], 0.88[ms] (connector for forced stop input cable is attached) (Note 2)	0.70	
C Controller module (Note 3)	Q24DHCCPU-V	CPU: SH4A, Endian format: Little endian, OS: VxWorks 6.8.1	2.80	
PCIe cable	Q173PCIECBL05M	C Controller interface module Q173SCCF ↔ C Controller module Q24DHCCPU-V 0.5m (1.64ft.)	—	
USB cable	MR-J3USBCBL3M	C Controller interface module Q173SCCF/C Controller module Q24DHCCPU-V ↔ personal computer	—	
SSCNET III cable	MR-J3BUS□M	<ul style="list-style-type: none"> Q173SCCF ↔ MR-J4(W□)-□B/MR-J4(W□)-□B ↔ MR-J4(W□)-□B Standard cord for inside panel 0.15m(0.49ft.), 0.3m(0.98ft.), 0.5m(1.64ft.), 1m(3.28ft.), 3m(9.84ft.) 	—	
	MR-J3BUS□M-A	<ul style="list-style-type: none"> Q173SCCF ↔ MR-J4(W□)-□B/MR-J4(W□)-□B ↔ MR-J4(W□)-□B Standard cable for outside panel 5m(16.40ft.), 10m(32.81ft.), 20m(65.62ft.) 	—	
	MR-J3BUS□M-B (Note 4)	<ul style="list-style-type: none"> Q173SCCF ↔ MR-J4(W□)-□B/MR-J4(W□)-□B ↔ MR-J4(W□)-□B Long distance cable 30m(98.43ft.), 40m(131.23ft.), 50m(164.04ft.) 	—	

Note 1. □=Cable length (015: 0.15m(0.49ft.), 03: 0.3m(0.98ft.), 05: 0.5m(1.64ft.), 1: 1m(3.28ft.), 2: 2m(6.56ft.), 3: 3m(9.84ft.), 5: 5m(16.40ft.), 10: 10m(32.81ft.), 20: 20m(65.62ft.), 25: 25m(82.02ft.), 30: 30m(98.43ft.), 40: 40m(131.23ft.), 50: 50m(164.04ft.)

2. Cable for forced stop input is not attached to the Q173SCCF. The cable should be made by the customer.

3. 5VDC internal current consumption of shared equipment with PLC might be changed.

Be sure to refer to the MELSEC-Q series PLC Manuals.

4. Please contact your nearest Mitsubishi Electric sales representative for the cable of less than 30m(98.43ft.).

(2) Equipment with SSCNET III/H connection

Part name	Model name	Description	Remarks
MR-J4 series servo amplifier	MR-J4-□B		Refer to the servo amplifier instruction manuals.
	MR-J4-□B-RJ		
	MR-J4W-□B	For 2-axis type, 3 axis type	
MR-JE series servo amplifier	MR-JE-□B		
SSCNET III/H head module	LJ72MS15	Maximum link points input 64 bytes, output 64 bytes	Refer to MELSEC-L SSCNET III/H Head Module User's manual.
Sensing module	MR-MT2010	Sensing SSCNET III/H module	Refer to the sensing module instruction manuals.
	MR-MT2100	Sensing I/O module	
	MR-MT2200	Sensing pulse I/O module	
	MR-MT2300	Sensing analog I/O module	
	MR-MT2400	Sensing encoder I/F module	

2. SYSTEM CONFIGURATION

(3) Software packages

(a) Utility software

Model name	Software package
C Controller interface module utility	SW1DNC-QSCCF-B

(b) Setting/monitoring tool for the C Controller module

Model name	Software package
Setting/monitoring tool for the C Controller module	SW4PVC-CCPU-E

(c) Engineering tool for the C Controller module

Model name	Software package
CW Workbench	SW1DND-CWWLQ24-E
Wind River Workbench	Wind River Workbench 3.2

(d) Servo set-up software package

Model name	Software package
MR Configurator2	SW1DNC-MRC2-E

2. SYSTEM CONFIGURATION

2.4 Checking serial number and operating system software version

Checking for the serial number of Q173SCCF and software version are shown below.

2.4.1 Checking serial number

(1) Rating plate

The rating plate is situated on the side face of the Q173SCCF.

(2) Front of Q173SCCF

The serial number is printed on the lower part of the front of the Q173SCCF.

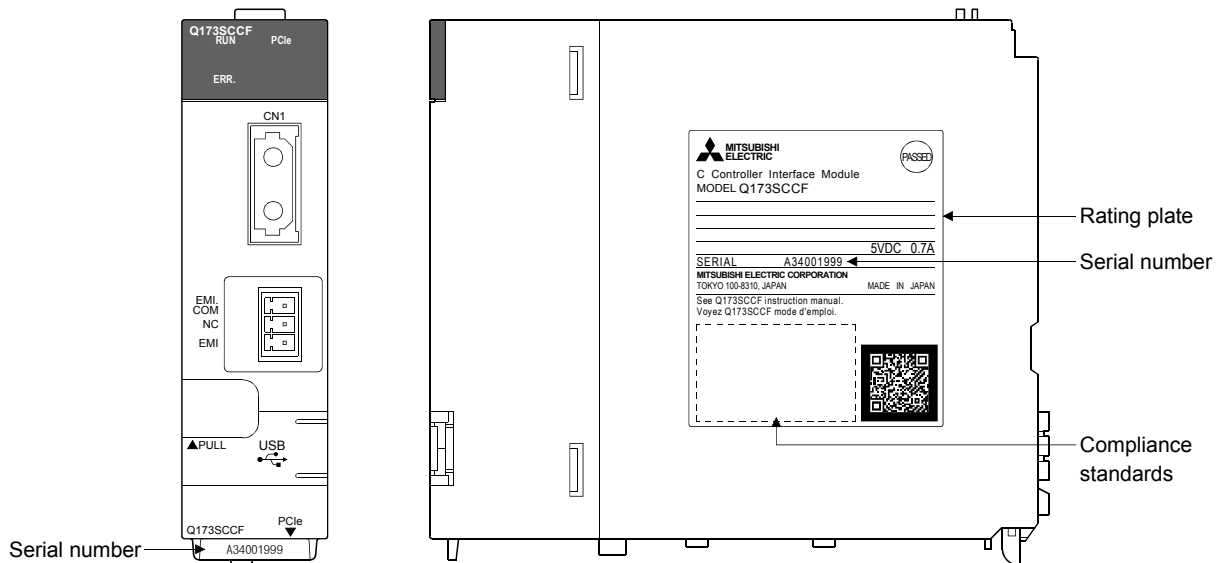

2.4.2 Checking software version

The software version of the Q173SCCF can be checked on the system program software version (0030h to 003Fh) of system information. System program software version is stored as ASCII code.

	0030h	0031h	0032h	0033h	0034h	0035h	0036h	0037h	0038h	0039h	003Ah	003Bh	003Ch	003Dh	003Eh	003Fh
System program software version	B (42h)	C (43h)	D (44h)	- (2Dh)	B (42h)	5 (35h)	2 (32h)	W (57h)	1 (31h)	0 (30h)	1 (31h)	- (2Dh)	A (41h)	3 (33h)	␣ (20h)	␣ (00h)
	Software type name								Type name		Version					
									101: Q173SCCF							

Note. In (): ASCII code
␣ : Space

API LIBRARY

- To check the software version, use the sscGetBoardVersion function.

2. SYSTEM CONFIGURATION

2.5 Software version

The software versions that support Q173SCCF are shown below.

Software	Version
C Controller interface module utility (SW1DNC-QSCCF-B)	1.50 or later
Setting/monitoring tool for the C Controller module (SW4PVC-CCPU-E)	4.01B or later
CW Workbench (SW1DND-CWWLQ24-E)	1.00A or later
Wind River Workbench	3.2
MR Configurator2	1.10L or later

2.6 Restrictions by the software's version

There are restrictions in the function that can be used by the version of the software.

Function/Item name	Change details	Software version	
		Q173SCCF	SW1DNC-QSCCF-B
Speed-torque control (interface mode only)	Addition	A4 or later	1.60 or later
Addition of operation cycle alarm to system alarms	Addition	A4 or later	1.60 or later
Addition of position droop to high speed monitor (interface mode only)	Addition	A4 or later	1.60 or later
Mark detection function compatible	Addition	A5 or later	1.70 or later
Change home position return method while system is running.	Addition	A5 or later	1.70 or later
Continuous operation to torque control (automatic operation in standard mode only)	Addition	A5 or later	1.70 or later
External forced stop disabled function	Addition	A5 or later	1.70 or later
Point table loop method	Addition	A6 or later	1.70 or later
Servo amplifier (MR-JE-□B) compatible	Addition	A7 or later	1.70 or later
Addition of forced stop to system interrupt factor	Addition	A7 or later	1.70 or later
SSCNET III/H head module connection	Addition	A8 or later	1.80 or later
Transient transmit compatible	Addition	A8 or later	1.80 or later
Addition of station No. in order of connection to monitor	Addition	A8 or later	1.80 or later
I/O device compatible	Addition	A8 or later	1.80 or later
Changeable interpolation group	Addition	A9 or later	1.90 or later
Position change during deceleration	Addition	A9 or later	1.00 or later
Sensing module connection	Addition	B1 or later	1.90 or later
SSCNET III/H head module 0.22ms connection	Addition	B1 or later	1.80 or later

3. INSTALLATION AND WIRING

3. INSTALLATION AND WIRING

3.1 Module installation

3.1.1 Instructions for handling

⚠ CAUTION

- Use the Q173SCCF in an environment that meets the general specifications contained in this manual. Using this Q173SCCF in an environment outside the range of the general specifications could result in electric shock, fire, operation failure, and damage to or deterioration of the product.
- When the modules are installed to the base unit while pressing the module mounting lever located at the bottom of module, insert the module fixing projection into the fixing hole in the base unit until it stops. Then, securely install the module with the fixing hole as a supporting point. Incorrect installation of the module can cause an operation failure, damage or drop.
When using the Q173SCCF in the environment of much vibration, tighten the module with a screw. Tighten the screw in the specified torque range. Under tightening may cause a drop, short circuit or operation failure. Over tightening may cause a drop, short circuit or operation failure due to damage to the screw or module.
- Be sure to connect the extension cable to connectors of the base unit correctly. After connecting, check them for looseness. Poor connections could cause an input or output failure.
- Completely turn off the externally supplied power used in the system before installation or removing the module. Not doing so could result in electric shock or damage to the product.
- Do not install/remove the module onto/from base unit or terminal block more than 50 times, after the first use of the product. Failure to do so may cause the module to malfunction due to poor contact of connector.
- Do not directly touch the module's conductive parts and electronic components. Doing so may cause an operation failure or give damage to the module.
- Lock the control panel and prevent access to those who are not certified to handle or install electric equipment.
- Do not mistake the direction when connecting the PCIe cable. Connecting the cable in the incorrect direction will damage the module and cable.

Refer to "QCPU User's Manual (Hardware Design, Maintenance and Inspection)" for handling precautions.

3. INSTALLATION AND WIRING

3.1.2 Mounting position

When mounting the Q173SCCF to an enclosure or similar, fully consider its operability, maintainability and environmental resistance.

Refer to "QCPU User's Manual (Hardware Design, Maintenance and Inspection)" for mounting precautions such as module mounting orientation.

(1) Module mounting position

Keep the clearances shown below between the top/bottom faces of the module and other structures or parts to ensure good ventilation and facilitate module replacement. This product complies with PCI Express External Cabling Specifications.

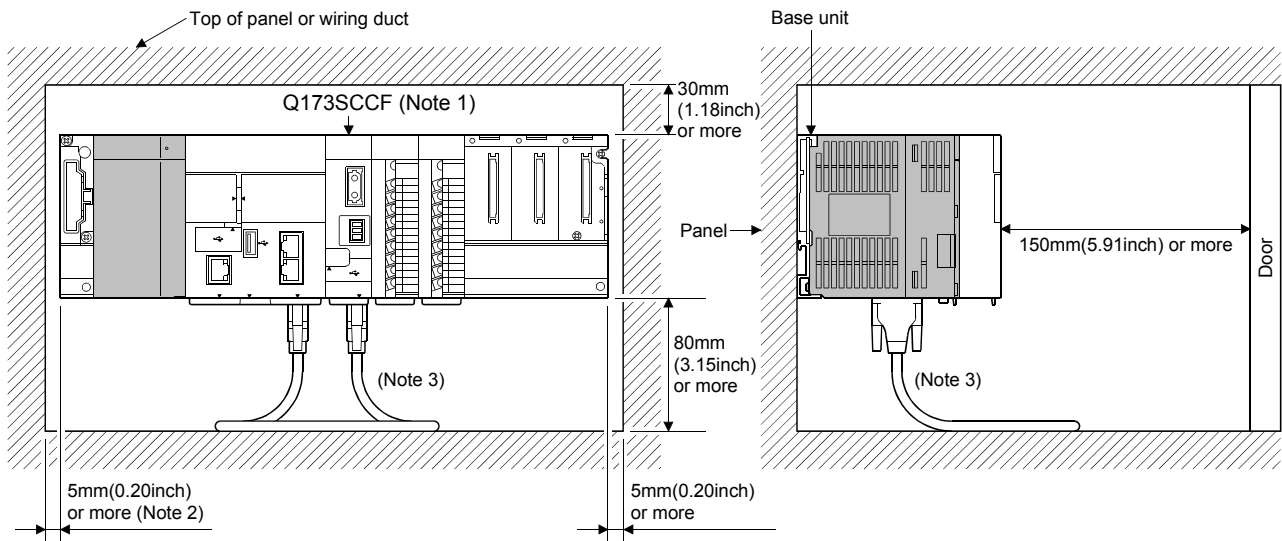

- Note 1. Fit the Q173SCCF at the right side of the C Controller module.
2. 20mm (0.79inch) or more when the adjacent module is not removed and the extension cable is connected.
3. The bend radius of the cable is 30mm(1.18inch) or more.

3. INSTALLATION AND WIRING

3.1.3 Installation and removal of module

This section describes how to install and remove the Q173SCCF to and from the base unit.

For how to install and remove a C Controller module, I/O module, intelligent function module, or power supply module, refer to the following manuals.

- QCPU User's Manual (Hardware Design, Maintenance and Inspection)
- C Controller Module User's Manual (Q24DHCCPU-V)

(1) Installation and removal of the Q173SCCF from base unit

(a) Installation

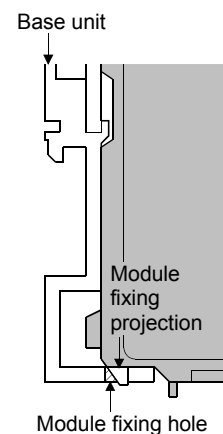
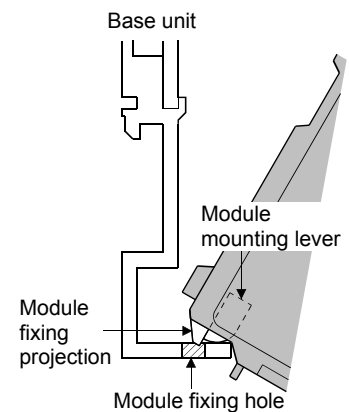
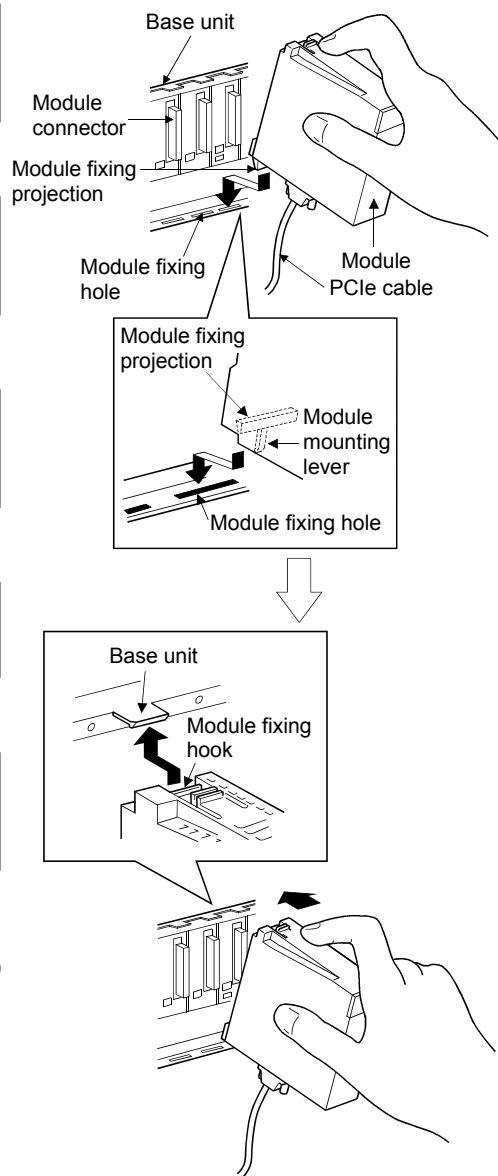
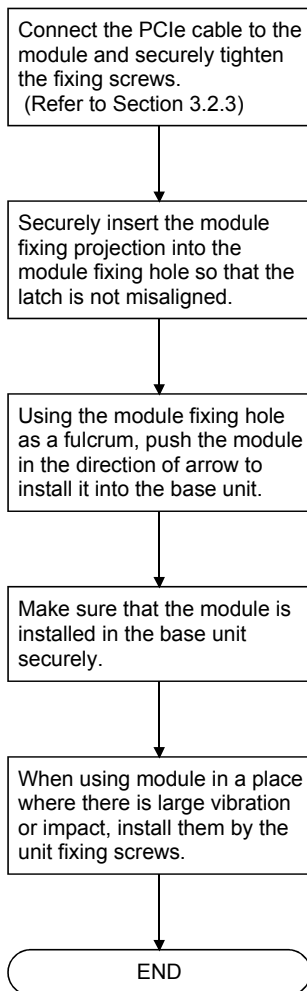

3. INSTALLATION AND WIRING

POINT	
	<ul style="list-style-type: none"><li data-bbox="464 309 1406 524">▪ When installing the module, always insert the module fixing projection into the module fixing hole of the base unit. At that time, securely insert the module fixing projection so that it does not come off from the module fixing hole. If the module is forcibly installed without the latch being inserted, the module connector and module will be damaged.<li data-bbox="464 544 1378 685">▪ When using the modules in a place where there is large vibration or impact, screw the module to the base unit. Module fixing screw : M3×12 (user-prepared) Screw the module to the main base unit using supplied fixing screws.<li data-bbox="464 705 1385 808">▪ Do not install/remove the module onto/from base unit or terminal block more than 50 times, after the first use of the product. Failure to do so may cause the module to malfunction due to poor contact of connector.<li data-bbox="464 828 1353 891">▪ Be sure to connect the PCIe cable to the Q173SCCF before installing the Q173SCCF to the base unit.<li data-bbox="464 911 1378 1014">▪ When installing the Q173SCCF, be sure to secure the PCIe cable minimum bend radius of 30mm(1.18inch) or more. Also, be sure that a haul, sudden bending or twist is not applied to the cable.

3. INSTALLATION AND WIRING

(b) Removal

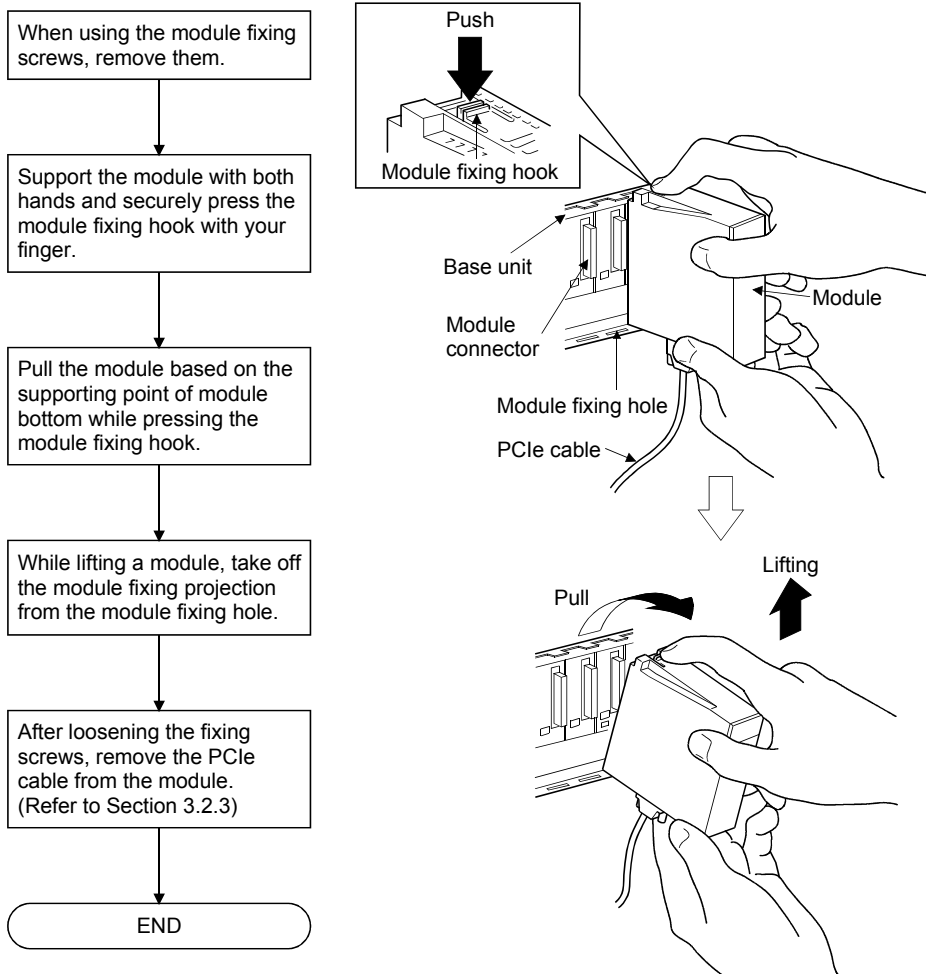

POINT

- When the module fixing screw is used, always remove the module by removing the module fixing screw and then taking the module fixing projection off the module fixing hole of the base unit. Attempting to remove the module by force may damage the module fixing projection.
- When removing the Q173SCCF, be sure that a haul, sudden bending or twist is not applied to the cable.

3. INSTALLATION AND WIRING

3.2 Connection and disconnection of cable

3.2.1 SSCNETIII cable

(1) Precautions for handling the SSCNETIII cable

- Do not stamp the SSCNETIII cable.
- When laying the SSCNETIII cable, be sure to secure the minimum cable bend radius or more. If the bend radius is less than the minimum cable bend radius, it may cause malfunctions due to characteristic deterioration, wire breakage, etc.
- For connection and disconnection of SSCNETIII cable, hold surely a tab of cable connector.

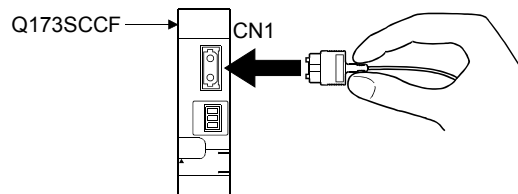

(2) Connection of SSCNETIII cable

- For connection of SSCNETIII cable to the Q173SCCF, connect it to the SSCNETIII connector CN1 or CN2 of Q173SCCF while holding a tab of SSCNETIII cable connector. Be sure to insert it until it clicks.
- If the cord tip for the SSCNETIII cable is dirty, optical transmission is interrupted and it may cause malfunctions. If it becomes dirty, wipe with a bonded textile, etc. Do not use solvent such as alcohol.

(3) Disconnection of SSCNETIII cable

- For disconnection of SSCNETIII cable, pull out it while holding a tab of SSCNETIII cable connector or the connector.
- After disconnection of SSCNETIII cable, be sure to put a cap (attached to Q173SCCF for servo amplifier) to the Q173SCCF and servo amplifier.
- For SSCNETIII cable, attach the tube for protection optical cord's end face on the end of connector.

3. INSTALLATION AND WIRING

(4) Precautions of SSCNETⅢ cable wiring

SSCNETⅢ cable is made from optical fiber. If optical fiber is added a power such as a major shock, lateral pressure, haul, sudden bending or twist, its inside distorts or breaks, and optical transmission will not be available. Especially, as optical fiber for MR-J3BUS□M and MR-J3BUS□M-A is made of synthetic resin, it melts down if being left near the fire or high temperature. Therefore, do not make it touched the part, which becomes high temperature, such as radiator or regenerative option of servo amplifier, or servo motor. Be sure to use optical fiber within the range of operating temperature described in this manual. Read described item of this section carefully and handle it with caution.

(a) Minimum bend radius

Make sure to lay the cable with greater radius than the minimum bend radius. Do not press the cable to edges of equipment or others. For SSCNETⅢ cable, the appropriate length should be selected with due consideration for the dimensions and arrangement of Q173SCCF and servo amplifier. When closing the door of control panel, pay careful attention for avoiding the case that SSCNETⅢ cable is hold down by the door and the cable bend becomes smaller than the minimum bend radius.

Model name of SSCNETⅢ cable	Minimum bend radius[mm(inch)]
MR-J3BUS□M	25(0.98)
MR-J3BUS□M-A	Enforced covering cord : 50 (1.97) Cord : 25 (0.98)
MR-J3BUS□M-B	Enforced covering cord : 50 (1.97) Cord : 30 (1.18)

(b) Tension

If tension is added on the SSCNETⅢ cable, the increase of transmission loss occurs because of external force which concentrates on the fixing part of SSCNETⅢ cable or the connecting part of SSCNETⅢ connector. At worst, the breakage of SSCNETⅢ cable or damage of SSCNETⅢ connector may occur. For cable laying, handle without putting forced tension.

Model name of SSCNETⅢ cable	Tension strength [N]	
MR-J3BUS□M	□=015	70
	□=03 to 3	140
MR-J3BUS□M-A	420 (Enforced covering cord)	
MR-J3BUS□M-B	980 (Enforced covering cord)	

(c) Lateral pressure

If lateral pressure is added on the SSCNETⅢ cable, the cable itself distorts, internal optical fiber gets stressed, and then transmission loss will increase. At worst, the breakage of SSCNETⅢ cable may occur. As the same condition also occurs at cable laying, do not tighten up SSCNETⅢ cable with a thing such as nylon band (TY-RAP). Do not trample it down or tuck it down with the door of control panel or others.

(d) Twisting

If SSCNETⅢ cable is twisted, it will become the same stress added condition as when local lateral pressure or bend is added. Consequently, transmission loss increases, and the breakage of SSCNETⅢ cable may occur at worst.

(e) Disposal

When incinerating optical cable (cord) used for SSCNETⅢ cable, hydrogen fluoride gas or hydrogen chloride gas which is corrosive and harmful may be generated. For disposal of SSCNETⅢ cable, request for specialized industrial waste disposal services who has incineration facility for disposing hydrogen fluoride gas or hydrogen chloride gas.

3. INSTALLATION AND WIRING

(f) Wiring process of SSCNETⅢ cable

Put the SSCNETⅢ cable in the duct or fix the cable at the closest part to the Q173SCCF with bundle material in order to prevent SSCNETⅢ cable from putting its own weight on SSCNETⅢ connector. Leave the following space for wiring.

• Putting in the duct

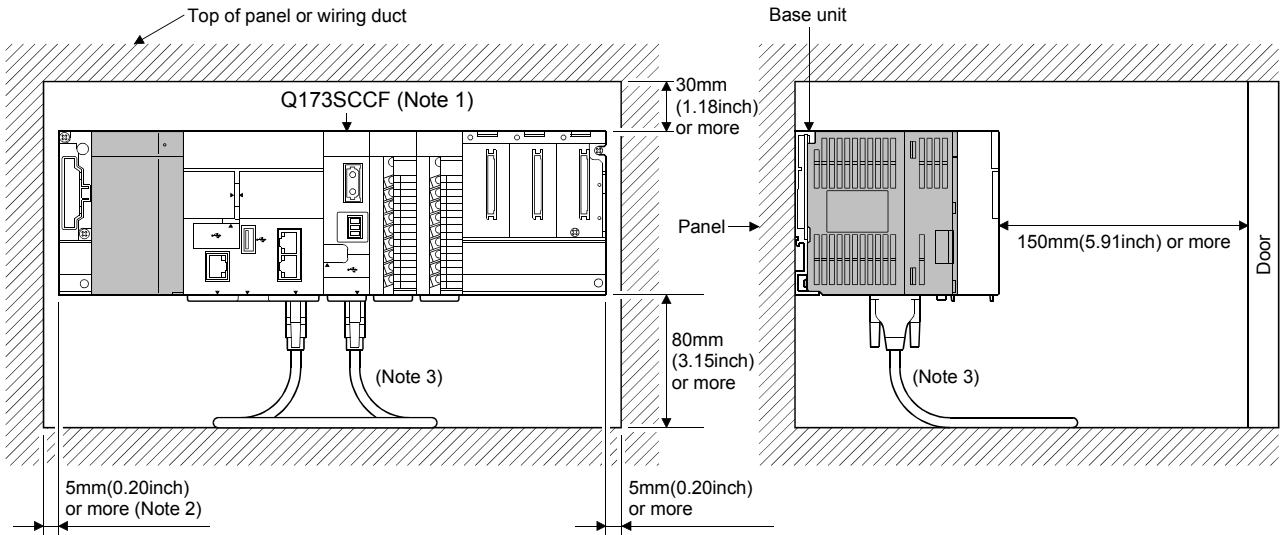

- Note 1. Fit the Q173SCCF at the right side of the C Controller module.
 Note 2. 20mm (0.79inch) or more when the adjacent module is not removed and the extension cable is connected.
 Note 3. The bend radius of the cable is 30mm(1.18inch) or more.

• Bundle fixing

Optical cord should be given loose slack to avoid from becoming smaller than the minimum bend radius, and it should not be twisted. When bundling the cable, fix and hold it in position by using cushioning such as sponge or rubber which does not contain migratable plasticizing. If using adhesive tape for bundling the cable, fire resistant acetate cloth adhesive tape 570F (Teraoka Seisakusho Co., Ltd) is recommended.

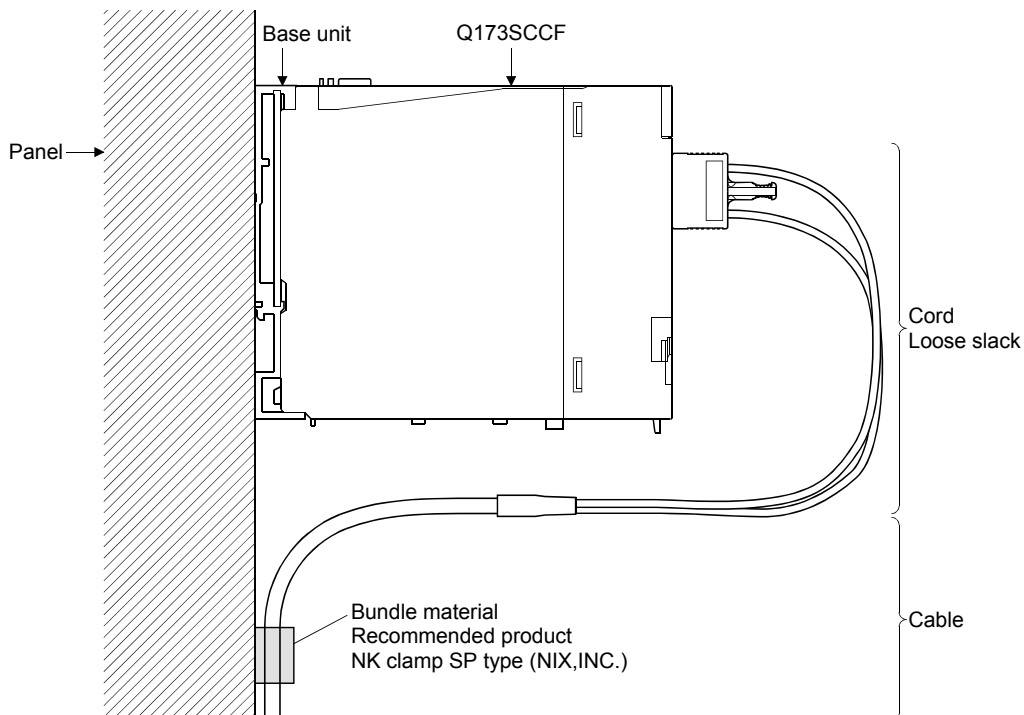

3. INSTALLATION AND WIRING

POINT	
	<ul style="list-style-type: none">▪ Be sure to connect SSCNETIII cable with the above connector. If the connection is mistaken, between the Q173SCCF and servo amplifier cannot be communicated.▪ Forced removal of the SSCNETIII cable from the Q173SCCF will damage the Q173SCCF and SSCNETIII cables.▪ After removal of the SSCNETIII cable, be sure to put a cap on the SSCNETIII connector. Otherwise, adhesion of dirt deteriorates in characteristic and it may cause malfunctions.▪ Do not remove the SSCNETIII cable while turning on the power supply of Q173SCCF and servo amplifier. Do not see directly the light generated from SSCNETIII connector of Q173SCCF or servo amplifier and the end of SSCNETIII cable. When the light gets into eye, may feel something is wrong for eye. (The light source of SSCNETIII cable complies with class1 defined in JISC6802 or IEC60825-1.)▪ If the SSCNETIII cable is added a power such as a major shock, lateral pressure, haul, sudden bending or twist, its inside distorts or brakes, and optical transmission will not be available. Be sure to take care enough so that the short SSCNETIII cable is added a twist easily.▪ Be sure to use the SSCNETIII cable within the range of operating temperature described in this manual. Especially, as optical fiber for MR-J3BUS□M and MR-J3BUS□M-A are made of synthetic resin, it melts down if being left near the fire or high temperature. Therefore, do not make it touched the part which becomes high temperature, such as radiator or regenerative option of servo amplifier, or servomotor.▪ When laying the SSCNETIII cable, be sure to secure the minimum cable bend radius or more.▪ Put the SSCNETIII cable in the duct or fix the cable at the closest part to the Q173SCCF with bundle material in order to prevent SSCNETIII cable from putting its own weight on SSCNETIII connector. When laying cable, the optical cord should be given loose slack to avoid from becoming smaller than the minimum bend radius, and it should not be twisted. When bundling the cable, fix and hold it in position by using cushioning such as sponge or rubber which does not contain migratable plasticizing. If using adhesive tape for bundling the cable, fire resistant acetate cloth adhesive tape 570F (Teraoka Seisakusho Co., Ltd) is recommended.

3. INSTALLATION AND WIRING

POINT

- Migratable plasticizer is used for vinyl tape. Keep the MR-J3BUS□M, and MR-J3BUS□M-A cables away from vinyl tape because the optical characteristic may be affected.

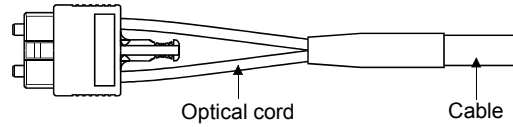

SSCNETⅢ cable	Cord	Cable
MR-J3BUS□M	△	—
MR-J3BUS□M-A	△	△
MR-J3BUS□M-B	○	○

○: Normally, cable is not affected by plasticizer.

△: Phthalate ester plasticizer such as DBP and DOP may affect optical characteristic of cable.

Generally, soft polyvinyl chloride (PVC), polyethylene resin (PE) and fluorine resin contain non-migratable plasticizer and they do not affect the optical characteristic of SSCNETⅢ cable. However, some wire sheaths and cable ties, which contain migratable plasticizer (phthalate ester), may affect MR-J3BUS□M and MR-J3BUS□M-A cables (made of plastic). In addition, MR-J3BUS□M-B cable (made of quartz glass) is not affected by plasticizer.

- If the adhesion of solvent and oil to the cord part of SSCNETⅢ cable may lower the optical characteristic and machine characteristic. If it is used such an environment, be sure to do the protection measures to the cord part.
- When keeping the module or servo amplifier, be sure to put on a cap to connector part so that a dirt should not adhere to the end of SSCNETⅢ connector.
- SSCNETⅢ connector to connect the SSCNETⅢ cable is put a cap to protect light device inside connector from dust. For this reason, do not remove a cap until just before connecting SSCNETⅢ cable. Then, when removing SSCNETⅢ cable, make sure to put a cap.
- Keep the cap and the tube for protecting light cord end of SSCNETⅢ cable in a plastic bag with a zipper of SSCNETⅢ cable to prevent them from becoming dirty.
- When exchanging the Q173SCCF or servo amplifier, make sure to put a cap on SSCNETⅢ connector. When asking repair of Q173SCCF or servo amplifier for some troubles, make also sure to put a cap on SSCNETⅢ connector. When the connector is not put a cap, the light device may be damaged at the transit. In this case, exchange and repair of light device is required.

3. INSTALLATION AND WIRING

3.2.2 Forced stop input cable

(1) Precautions for handling the forced stop input cable

- For connection or removal of the forced stop input cable, do it surely while holding a connector of forced stop input cable.

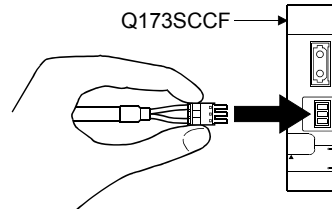

(2) Connection of the forced stop input cable

- For connection of a forced stop input cable to the Q173SCCF, connect it surely to an EMI connector of Q173SCCF while holding a connector. Be sure to insert it until it clicks.

(3) Removal of the forced stop input cable

- For removal of the forced stop input cable, push a tab and pull out the cable while holding a connector.

POINT
The following handling will damage the Q173SCCF or forced stop input cable. <ul style="list-style-type: none">• Forced removal of the forced stop input cable from the Q173SCCF.• The forced stop input cable is twined other cables.• Excessive power is applied at cable laying. Wire the cable correctly.

3. INSTALLATION AND WIRING

3.2.3 PCIe cable

(1) Precautions for handling the PCIe cable

- For connection or removal of the PCIe cable, do it surely while holding a connector.

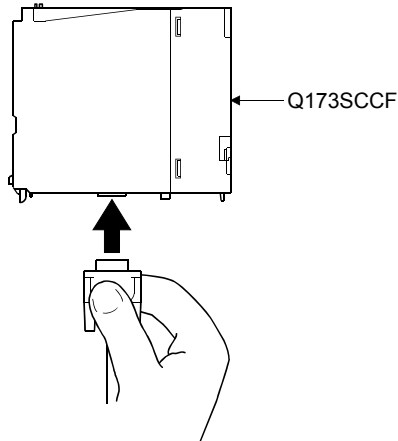

(2) Connection of the PCIe cable

- For connection of a PCIe cable to the Q173SCCF, connect it surely to the PCIe connector on the bottom of the Q173SCCF while holding a connector. Be sure to insert the PCIe cable all the way in, and tighten the fixing screws.

(3) Removal of the PCIe cable

- For removal of the PCIe cable, pull out the connector after loosening the fixing screws.

3. INSTALLATION AND WIRING

POINT

- The following handling will damage the Q173SCCF or PCIe cable.

- 1) Forced removal of the PCIe cable from the Q173SCCF.
- 2) The PCIe cable is twined other cables.
- 3) Excessive power is applied at cable laying.

Wire the cable correctly.

- Do not mistake the direction when connecting the PCIe cable. Connecting the cable in the incorrect direction will damage the cable.
- When inserting the connector be sure to screw to the module. Loose screws may cause the connector to fall out, a short circuit, or a malfunction.
- When connecting the PCIe cable, secure the minimum bend radius of 30mm(1.18inch) or more as shown below.

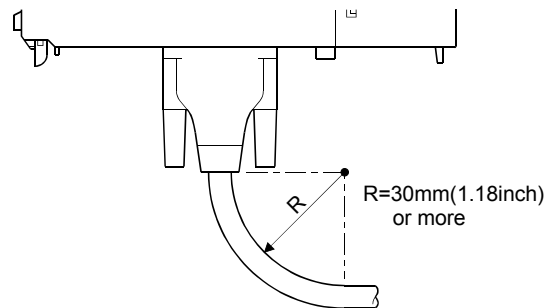

- When connecting and removing the PCIe cable, be sure that a haul, sudden bending or twist is not applied to the cable.
- When connecting and removing the PCIe cable to a C Controller module, pay attention to the contents of this section.

3. INSTALLATION AND WIRING

3.3 Wiring

This section explains instructions for wiring.

Refer to "QCPU User's Manual (Hardware Design, Maintenance and Inspection)" for the wiring of the power supply, and precautions for wiring.

Refer to "14 EMC Directives" for grounding method and measure against noise.

3.3.1 Instructions for wiring

DANGER

- Completely turn off the externally supplied power used in the system before installation or placing wiring. Not doing so could result in electric shock or damage to the product.
- When turning on the power supply or operating the module after wiring, be sure that the module's terminal covers are correctly attached. Not attaching the terminal cover could result in electric shock.

CAUTION

- Be sure to ground of the earth terminal FG and LG. Not doing so could result in electric shock or operation failure. (Ground resistance: 100Ω or less)
- When wiring in the module, be sure that it is done correctly by checking the product's rated voltage and the terminal layout. Connecting a power supply that is different from the rating or incorrectly wiring the product could result in fire or damage.
- Tighten the terminal screws within the specified torque range. If the terminal screws are loose, it could result in short circuit, fire, or operation failure. Tightening the terminal screws too far may cause damages to the screws and/or the module, resulting in drop, short circuit, or operation failure.
- Be sure there are no foreign matters such as sawdust or wiring debris inside the module. Such debris could cause fire, damage, or operation failure.
- The module has an ingress prevention label on its top to prevent foreign matter, such as wiring debris, from entering the module during wiring.
Do not remove this label during wiring.
Before starting system operation, be sure to remove this label because of heat dissipation.

3. INSTALLATION AND WIRING

3.3.2 Wiring of connector

Specialised tools are not required for wiring the forced stop input connector because plugs with spring connection are used.

(1) Applicable wire size and wire fabrication

(a) Applicable wire size

The applicable wire size for forced stop input connector are shown below.

Connector	Type	Applicable wire size
Forced stop input connector	FK-MCP1.5/3-ST-3.81	0.12 to 1.3mm ² (AWG16 to AWG26)

(b) Wire fabrication

Strip the wire according to stripped length indicated in the figure below.

Slide the sheath off the wire and gently twist and straighten the strands.

When using the wire, be careful not to short with stray strands entering the neighbouring poles. Do not use solder on the wire's core as this may lead to insufficient contact.

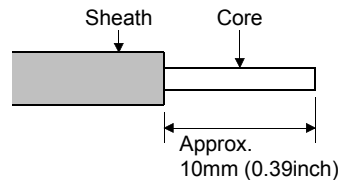

1) Using a ferrule

A ferrule can also be used to connect with the connector.

Use the ferrules in the table below for the forced stop input connector.

Connector	Wire size	Ferrule model		Crimping tool	Manufacturer
		For 1 wire	For 2 wires		
Forced stop input connector	AWG21	AI0.5-10 WH	—	CRIMPFOX-ZA3	PHOENIX CONTACT

- Cut the wire sticking out from the end of the ferrule to 0.5mm (0.02inch) or less.

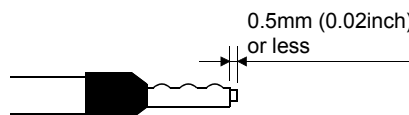

3. INSTALLATION AND WIRING

(2) Inserting wire

- 1) Press the connector release with a tool such as a flathead screwdriver.
- 2) While holding the release down, insert the wire all the way in.

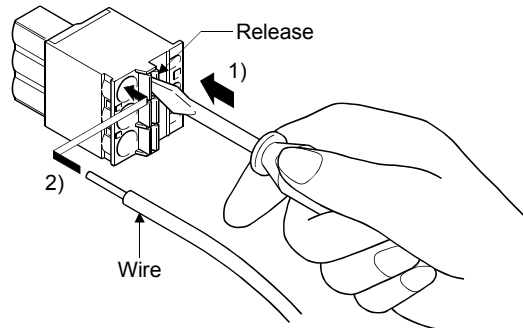

(Note): When using a ferrule, make sure the bumpy side is facing towards the release.
When inserting 2 wires into one terminal, use a twin ferrule.

Insert the wire with the bumpy side facing the release.

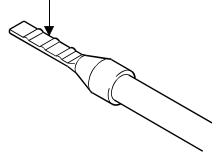

4. SYSTEM STARTUP

4. SYSTEM STARTUP

The following explains the preparations and settings for system startup.

When using an SSCNETⅢ/H head module, refer to Section 6.33.

When using a sensing module, refer to Section 6.34.

4.1 Startup procedures

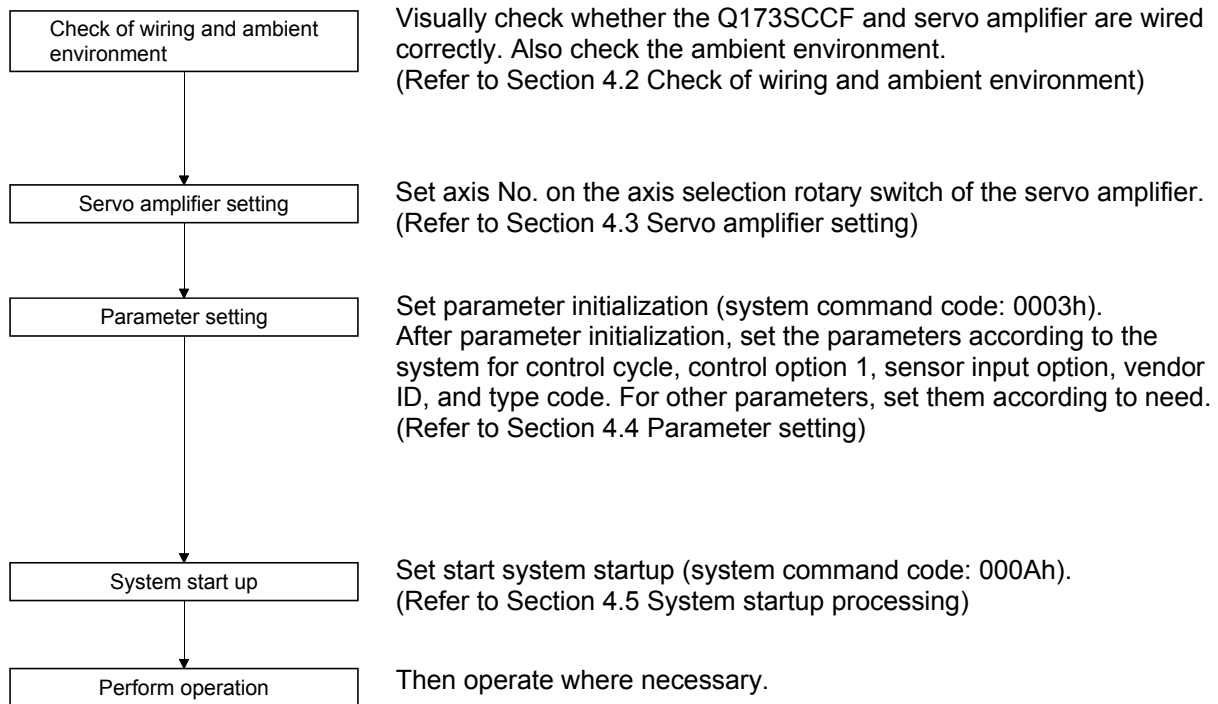

POINT
<ul style="list-style-type: none">▪ The Q173SCCF cannot monitor parameter settings and alarms from the setting/monitoring tool for the C Controller module. Set the slot for which the Q173SCCF is installed to "Empty" in setting/monitoring tool for the C Controller module. Checking parameter settings, alarms, and controlling the Q173SCCF is all done from the user program on the C Controller module.▪ When a test operation is necessary before creating a user program, parameter settings, system startup, operation and such can be performed using the test tool attached to the utility software.

4. SYSTEM STARTUP

4.2 Check of wiring and ambient environment

(1) Wiring

Refer to "Chapter 3 INSTALLATION AND WIRING".

(2) Cable treatment

The wiring cables should not be strained.

The connector part should not be strained.

(3) Environment

Signal cables and bus of C Controller module are not shorted by wire offcuts and metallic dust.

4. SYSTEM STARTUP

4.3 Servo amplifier setting

(1) MR-J4(W□)-□B

Axis No. of MR-J4(W□)-□B is set by the axis selection rotary switch (SW1) and the axis No. auxiliary setting (SW2) on the servo amplifier.

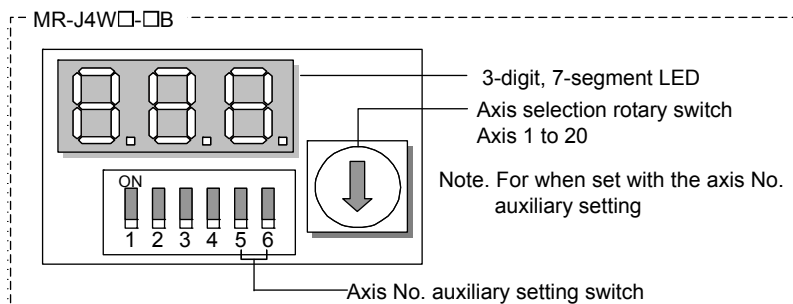
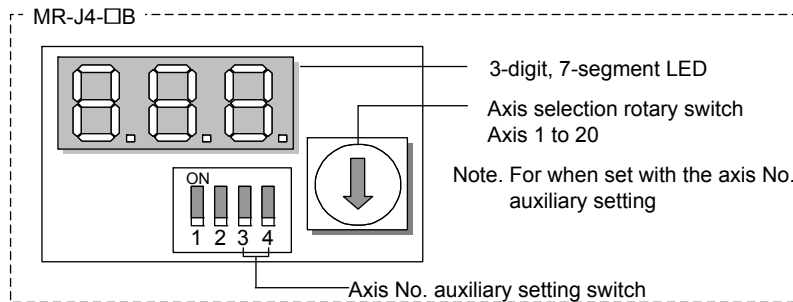

Servo amplifier axis No.	Axis selection rotary switch	Axis No. auxiliary setting switch	Servo amplifier display (3-digit, 7-segment LED)
d1	0	ON  OFF 	01
d2	1		02
d3	2		03
d4	3		04
d5	4		05
d6	5		06
d7	6		07
d8	7		08
d9	8		09
d10	9		10
d11	A		11
d12	B		12
d13	C		13
d14	D		14
d15	E		15
d16	F		16
d17	0	ON  OFF 	17
d18	1		18
d19	2		19
d20	3		20

4. SYSTEM STARTUP

POINT
<ul style="list-style-type: none"> ▪ For each switch setting, refer to the Servo Amplifier Instruction Manual for your servo amplifier. ▪ If the "An axis that has not been mounted exists" (system error E400) occurred, the axis with wrong axis No. set can be confirmed with "information concerning axis that is not mounted" (monitor No.0480 to 0482). ▪ The servo amplifier axis No. and the axis No. to be managed on the Q173SCCF are different. For details, refer to Section 4.4.6.

The following is a setting example for controlling eight axes (MR-J4-□B) by control cycle 0.88ms.

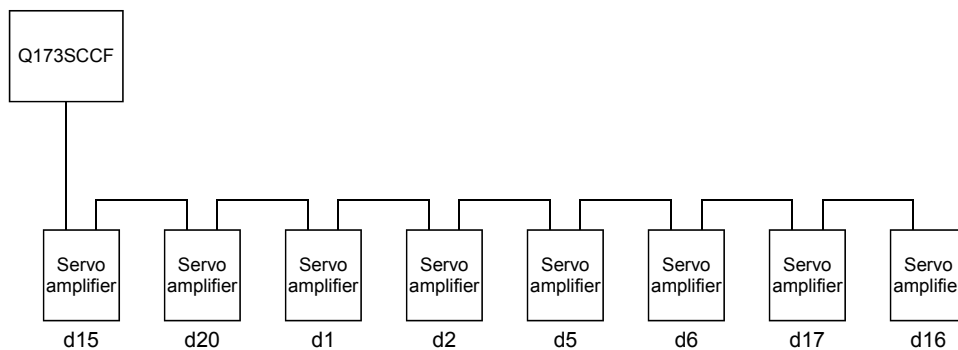

Servo amplifier axis No.	Axis selection rotary switch	Axis No. auxiliary setting switch	
		3	4
d15	E	OFF	OFF
d20	3	OFF	ON
d1	0	OFF	OFF
d2	1	OFF	OFF
d5	4	OFF	OFF
d6	5	OFF	OFF
d17	0	OFF	ON
d16	F	OFF	OFF

POINT
<ul style="list-style-type: none"> ▪ The axis No. may be in no particular order, and can be arbitrarily selected between 1 to 20. ▪ No. of connectable servo amplifiers vary by control cycle.

4. SYSTEM STARTUP

4.4 Parameter setting

After parameter initialization, set the parameters according to the system such as for control cycle and external signal (sensor) input option.

4.4.1 Parameter initialization

After turning on the Q173SCCF power, initialize parameter and set before system startup starts.

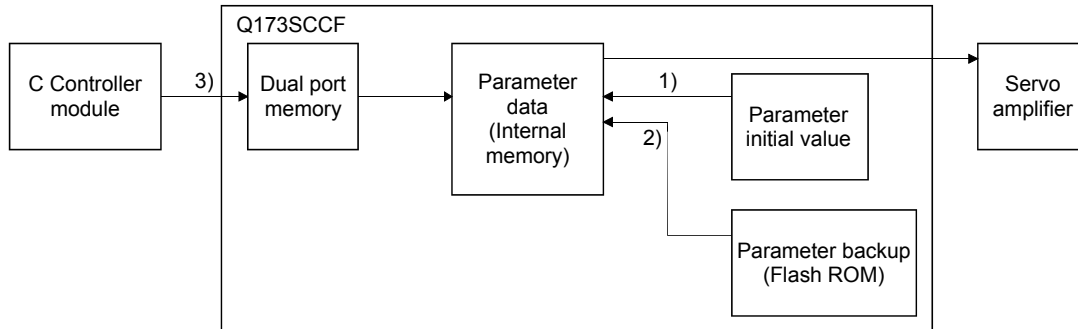

Figure 4.1 Parameter data flow during parameter initialization

Procedure	Description		Remarks
1	Confirm system preparation completion (system status code 0001h)		Confirmation of system preparation completion uses sscGetSystemStatusCode.
2	To read parameter initial values, perform the parameter initialization (system command code: 0003h).	To read parameters from the flash ROM, perform the flash ROM parameter read (system command code: 0004h).	1) and 2) in Fig. 4.1 Always initialize parameter or read parameter from the flash ROM. Procedure 2 and procedure 3 of parameter initialization uses the sscResetAllParameter function.
3	Check the parameter initialization completion (system status code: 0003h).	Check the flash ROM parameter read completion (system command code: 0004h).	
4	Write parameter from user program if required		3) in Fig. 4.1 Parameter writing uses sscChangeParameter/sscChange2Parameter.

4. SYSTEM STARTUP

4.4.2 System option 1 setting

SSCNET communication method and control cycle is set by System option 1 (parameter No.0001).

SSCNET communication method is used for communication between a Q173SCCF and connected units such as servo amplifiers and SSCNETⅢ/H method is available.

Control cycle is a cycle in which the Q173SCCF controls command import, position control, status output, and communication with servo amplifier and 0.88ms, 0.44ms and 0.22ms are available.

Number of servo amplifier axes which a Q173SCCF can control is shown below for each control cycle.

- When SSCNET communication method is SSCNETⅢ/H

Control cycle	Max. No. of axes connected	Controllable axis No.
0.88ms	20 axes	Axis 1 to 20
0.44ms	16 axes	Axis 1 to 16
0.22ms	8 axes	Axis 1 to 8

Note 1. Do not connect more servo amplifiers than the max. No. of axes connected. When more servo amplifiers are connected than the max. No. of axes connected, system setting error (alarm No.38, detail 01) will occur.

2. Use servo amplifier software version A3 or later when the control cycle is 0.22ms, and the 3-axis servo amplifier MR-J4W3-□B is used.

4. SYSTEM STARTUP

Control cycle settings are imported during system startup (system command code: 000Ah), and cannot be changed during system running (system status code: 000Ah).

(1) System parameter

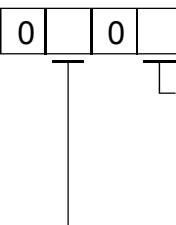
Parameter No.	Abbreviation	Name	Function
0001	*SYSOP1	System option 1	 <p>Control cycle setting Set the control cycle. 0: 0.88ms 1: 0.44ms 2: 0.22ms</p> <p>SSCNET communication method Set the SSCNET communication method. 0: SSCNET III/H</p>

(2) System information

Address	Name	Description
0004h	Control cycle status	0001h: 0.88ms
0005h		0002h: 0.44ms
0006h	Reserved	0003h: 0.22ms
0007h		

4. SYSTEM STARTUP

4.4.3 System option 2 setting

Set control mode (standard mode or interface mode) by System option 2 (parameter No.0002).

When using interface mode, select "1: Interface mode".

When interface mode is assigned and system is startup, the in interface mode signal (IFMO) turns ON.

Control mode setting is imported during system startup (system command code: 000Ah), and cannot be changed during system running (system status code: 000Ah).

(1) System parameter

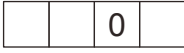
Parameter No.	Abbreviation	Name	Initial value	Units	Setting range	Function
0002	*SYSOP2	System option 2	0000h		0000h to 1101h	 <p>Axis/station No. assignment Set 1 when validating axis/station No. assignment. When axis/station No. assignment is invalid, axis/station No. is automatically assigned. 0: Invalid 1: Valid</p> <p>Consistency check selection at system startup Set whether to perform consistency check for controlled axes setting at system startup. 0: Valid 1: Invalid</p> <p>Control mode selection Set the control mode. 0: Standard mode 1: Interface mode</p>

4. SYSTEM STARTUP

4.4.4 I/O table setting

Set the I/O table to be used (digital I/O table or I/O device table) by I/O table (parameter No.004A).

When using I/O device table, select "1: Use I/O device table".

I/O table setting is imported during system startup (system command code: 000Ah), and cannot be changed during system running (system status code: 000Ah).

(1) System parameter

Parameter No.	Abbreviation	Name	Initial value	Units	Setting range	Function
004A	*IOTBL	I/O table	0000h		0000h to 0001h	<div style="display: flex; align-items: center;"> <div style="border: 1px solid black; padding: 2px; margin-right: 5px;">0</div> <div style="border: 1px solid black; padding: 2px; margin-right: 5px;">0</div> <div style="border: 1px solid black; padding: 2px; margin-right: 5px;">0</div> <div style="border: 1px solid black; padding: 2px; margin-right: 5px;"> </div> </div> <p style="margin-left: 20px;">└ I/O table selection Set the I/O table to be used. 0: Use digital I/O table 1: Use I/O device table</p>

POINT

- In relation to the digital I/O function, the following functions are expanded for the I/O device function. We recommend using the I/O device function.
 - Expansion of I/O points used
 - Supports control of I/O word devices

4. SYSTEM STARTUP

4.4.5 Control option 1 setting

When controlling servo amplifier, set "1: control" for control axis of control option 1 (parameter No.0200). When the axis No. is set out of the controllable range, the corresponding axis will be system setting error (alarm No.38) and cannot be controlled. If the servo amplifier set is in a state where communication cannot be made, such as not connected or control circuit power is off, the "An axis that has not been mounted exists" (system error E400) will occur during system startup (system command code: 000Ah).

POINT
<ul style="list-style-type: none"> If the "An axis that has not been mounted exists" (system error E400) occurred, the axis with wrong No. set can be confirmed with "information concerning axis that is not mounted" (monitor No.0402).

Control axis settings are imported during system startup (system command code: 000Ah), and cannot be changed during system running (system status code: 000Ah).

(1) Control parameter

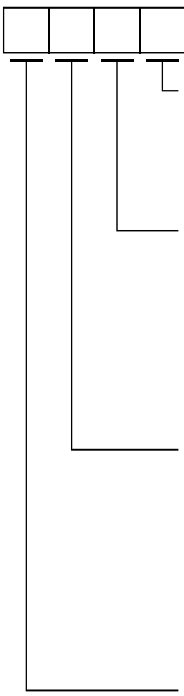
Parameter No.	Abbreviation	Name	Initial value	Units	Setting range	Function
0200	*OPC1	Control option 1	0000h		0000h to 2111h	 <p>Control axis Set 1 when controlling servo amplifier. 0: Do not control 1: Control</p> <p>Amplifier-less axis function Set 1 when not communicating with servo amplifier. When setting 1 with control axis, operation without servo amplifier (simulation) is available. 0: Invalid 1: Valid</p> <p>No home position Set 1 when setting the position at the time of power on as the home position. After returning to home position, the home position will be the position where home position return is complete. 0: Invalid 1: Valid</p> <p>Speed unit Set the speed command unit. 0: Position command unit / min 1: Position command unit / s 2: r/min</p>

POINT
<ul style="list-style-type: none"> When the amplifier-less axis function is valid, the Q173SCCF simulates the operations of servo amplifier and operates as if it is connected. Operation can be checked without connecting the servo amplifier. When the setting is valid, the Q173SCCF do not communicate with the servo amplifier.

4. SYSTEM STARTUP

4.4.6 Axis No. assignment

With Axis No. assignment, the axis No. (on the Q173SCCF) can be assigned by the axis No. on the servo amplifier.

(1) When Axis No. assignment is invalid

When Axis No. assignment is invalid, correspondence between the axis No. on a Q173SCCF and the axis No. on a servo amplifier is shown in the following table.

(a) When SSCNET communication method is SSCNETⅢ/H

Servo amplifier axis No.		d1	d2	d3	d4	d5	d6	d7	d8	d9	d10	d11	d12	d13	d14	d15	d16	d17	d18	d19	d20
Axis No.	0.88ms	1	2	3	4	5	6	7	8	9	10	11	12	13	14	15	16	17	18	19	20
	0.44ms	1	2	3	4	5	6	7	8	9	10	11	12	13	14	15	16	-	-	-	-
	0.22ms	1	2	3	4	5	6	7	8	-	-	-	-	-	-	-	-	-	-	-	-

(2) When Axis No. assignment is valid

When Axis No. assignment is valid, the axis Nos. 1 to 20 (on the Q173SCCF) can be assigned by the servo amplifier axis Nos. d1 to d20 arbitrarily.

To assign the axis Nos., set the following parameters.

POINT								
<ul style="list-style-type: none"> To set servo amplifier axis Nos., use the axis No. assignment (parameter No.0203). <p>Valid servo amplifier axis Nos. differ depending on the control cycle. Up to 20 axes can be set.</p> <table border="1" style="margin-left: auto; margin-right: auto;"> <thead> <tr> <th>Control cycle</th> <th>SSCNETⅢ/H</th> </tr> </thead> <tbody> <tr> <td>0.88ms</td> <td>1 to 20</td> </tr> <tr> <td>0.44ms</td> <td>1 to 16</td> </tr> <tr> <td>0.22ms</td> <td>1 to 8</td> </tr> </tbody> </table>	Control cycle	SSCNETⅢ/H	0.88ms	1 to 20	0.44ms	1 to 16	0.22ms	1 to 8
Control cycle	SSCNETⅢ/H							
0.88ms	1 to 20							
0.44ms	1 to 16							
0.22ms	1 to 8							

(a) System parameter

Parameter No.	Abbreviation	Name	Function
0002	*SYSOP2	System option 2	<div style="display: flex; align-items: center;"> <div style="border: 1px solid black; padding: 2px; margin-right: 5px;">0</div> <div style="border: 1px solid black; padding: 2px; margin-right: 5px;">0</div> <div style="border: 1px solid black; padding: 2px; margin-right: 5px;">0</div> <div style="border: 1px solid black; padding: 2px; margin-right: 5px;"> </div> </div> <p>Axis/station No. assignment selection Set 1 when validating axis/station No. assignment. When axis/station No. assignment is invalid, axis/station No. is automatically assigned. 0: Invalid 1: Valid</p>

4. SYSTEM STARTUP

(b) Control parameter

Parameter No.	Abbreviation	Name	Initial value	Units	Setting range	Function
0203	*AXALC	Axis No. assignment	0000h		0000h to 001Fh	<div style="display: flex; align-items: center;"> <div style="border: 1px solid black; padding: 2px; margin-right: 5px;">0</div> <div style="border: 1px solid black; padding: 2px; margin-right: 5px;">0</div> <div style="border: 1px solid black; padding: 2px; margin-right: 5px;"> </div> <div style="border: 1px solid black; padding: 2px;"> </div> </div> <p>Servo amplifier axis No. Set the servo amplifier axis No. to be assigned to the axis Nos. on the Q173SCCF. (Note 1, 2 and 3) 00h: No axis No. assignment 01h to 14h: Axis No. Example) 0Ah: Axis No.10</p>

Note 1. An axis No. out of the valid range causes the system setting error (alarm No.38, detail 03).

2. Regardless of the control axis setting (parameter No.0200), set the axis No. so that the axis No. assignment is not duplicated. (Except for 00: No axis No. assignment) Duplicated axis Nos. cause the system setting error (alarm No.38, detail 04).
3. When Control is set in the control axis setting (parameter No.0200), always set the axis Nos. (1 to 20). When 0 is set, system setting error (alarm No.38, detail 02) will occur.

The following is a setting example for controlling six axes.

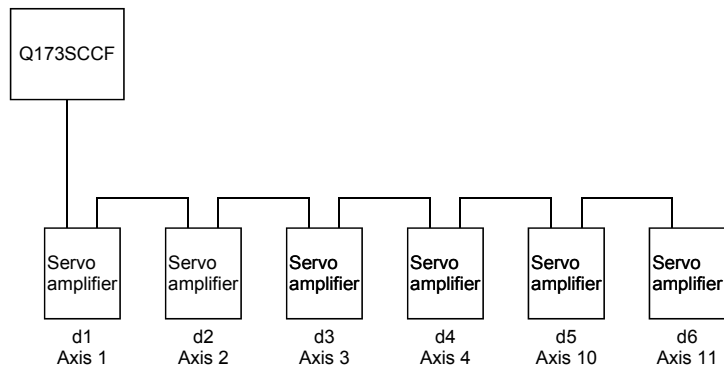



Axis No.	1	2	3	4	10	11
Control parameter No.0203 setting value	0001h	0002h	0003h	0004h	0005h	0006h
Servo amplifier axis No.	d1	d2	d3	d4	d5	d6

4. SYSTEM STARTUP

4.4.7 Sensor input option setting

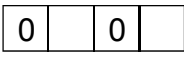
External signal (sensor) is connected by setting sensor input options (parameter No.0219).

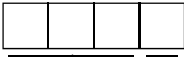
Parameter No.	Abbreviation	Name	Initial Value	Units	Setting range	Function
0219	*SOP	Sensor input options	0000h		0000h to 0304h	 <p>Sensor input system Set the input system of the sensor (LSP, LSN, DOG). 0: Not use 1: Driver input 2: Digital or input device input 3: Not connected (does not detect LSP, LSN, DOG) 4: Dual port memory input Limit switch signal selection Set valid / invalid of limit switch. 0: LSP/LSN are valid 1: LSP is valid, LSN is invalid 2: LSP is invalid, LSN is valid 3: LSP/LSN are invalid</p>
021A	*SLSP	Sensor signal (LSP) connection specification	0000h		0000 to FFF1h	<p>The setting target differs depending on the I/O table (parameter No.004A) setting.</p> <p>[When using a digital I/O table]</p>  <p>Digital input assignment Set valid/invalid for the digital input assignment where LSP is connected. 0: Not assigned 1: Assigned</p> <p>Digital input number assignment Set the digital input number where the LSP is connected. 000h to 3FFh: DI_000 to DI_3FF</p> <p>[When using a I/O device table]</p>  <p>Input device assignment Set valid/invalid for the input device assignment where LSP is connected. 0: Not assigned 1: Assigned</p> <p>Input device number assignment Set the input device number where the LSP is connected. 000h to FFFh: DVI_000 to DVI_FFF</p>

4. SYSTEM STARTUP

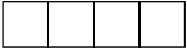
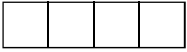
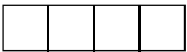
Parameter No.	Abbreviation	Name	Initial Value	Units	Setting range	Function
021B	*SLSN	Sensor signal (LSN) connection specification	0000h		0000 to FFF1h	<p>The setting target differs depending on the I/O table (parameter No.004A) setting.</p> <p>[When using a digital I/O table]</p>  <p>Digital input assignment Set valid/invalid for the digital input assignment where LSN is connected. 0: Not assigned 1: Assigned</p> <p>Digital input number assignment Set the digital input number where LSN is connected. 000h to 3FFh: DI_000 to DI_3FF</p> <p>[When using a I/O device table]</p>  <p>Input device assignment Set valid/invalid for the input device assignment where LSN is connected. 0: Not assigned 1: Assigned</p> <p>Input device number assignment Set the input device number where LSN is connected. 000h to FFFh: DVI_000 to DVI_FFF</p>
021C	*SDOG	Sensor signal (DOG) connection specification	0000h		0000 to FFF1h	<p>The setting target differs depending on the I/O table (parameter No.004A) setting.</p> <p>[When using a digital I/O table]</p>  <p>Digital input assignment Set valid/invalid for the digital input assignment where DOG is connected. 0: Not assigned 1: Assigned</p> <p>Digital input number assignment Set the digital input number where DOG is connected. 000h to 3FFh: DI_000 to DI_3FF</p> <p>[When using a I/O device table]</p>  <p>Input device assignment Set valid/invalid for the input device assignment where DOG is connected. 0: Not assigned 1: Assigned</p> <p>Input device number assignment Set the input device number where DOG is connected. 000h to FFFh: DVI_000 to DVI_FFF</p>

4. SYSTEM STARTUP

(1) When selecting the driver input

When 1 (driver input) is selected as the sensor destination, the sensor (LSP, LSN, DOG) status connected to the driver (such as a servo amplifier) is imported via SSCNET.

(a) MR-J4(W□)-□B is used as a servo amplifier

1) MR-J4-□B

Signal Name	Destination connector pin No.	Abbreviation
LSP	CN3-2	D11
LSN	CN3-12	D12
DOG	CN3-19	D13

2) MR-J4W2-□B

Signal Name	Destination connector pin No.		Abbreviation (□: A, B)
	A-axis	B-axis	
LSP	CN3-7	CN3-20	DI1□
LSN	CN3-8	CN3-21	DI2□
DOG	CN3-9	CN3-22	DI3□

3) MR-J4W3-□B

Signal Name	Destination connector pin No.			Abbreviation (□: A, B, C)
	A-axis	B-axis	C-axis	
LSP	CN3-7	CN3-20	CN3-1	DI1□
LSN	CN3-8	CN3-21	CN3-2	DI2□
DOG	CN3-9	CN3-22	CN3-15	DI3□

POINT
<ul style="list-style-type: none"> ▪ For sensor connection to the driver, refer to the instruction manual of the driver. ▪ If communication error (system error E401 to E407) occurs, sensor (LSP, LSN, DOG) input status turns off. ▪ If communication error (system error E400) occurs, the input status of the corresponding axis turns off.

(2) When selecting the digital input/input device

When 2 (digital or input device input) is selected as the sensor destination, the setting target differs depending on the I/O table (parameter No.004A) setting.

(a) When 0 (use digital I/O table) is set

The digital input signal (DI_□□□) is used as the sensor (LSP, LSN, DOG). Specify the digital input signal (DI_□□□) in the sensor signal connection specification (parameter No.021A to 021C).

(b) When 1 (use I/O device table) is set

The input device signal (DVI_□□□) is used as the sensor (LSP, LSN, DOG). Specify the input device signal (DVI_□□□) in the sensor signal connection specification (parameter No.021A to 021C).

Refer to Section 6.26 to 6.28, 6.33, and 6.34.

4. SYSTEM STARTUP

(3) When selecting not connected

When 3 (not connected) is selected as the sensor destination, the sensor (LSP/LSN/DOG) is not detected. Limit switch functions are always invalid. In the home position return using the proximity dog, the Q173SCCF operates without detected proximity dog.

(4) When selecting dual port memory

When 4 (dual port memory input) is selected as the sensor destination, + side limit switch input signal (LSPC), – side limit switch input signal (LSNC) and proximity dog input signal (DOGC) are imported as substitutes for sensors.

Address	Bit	Abbreviation	Signal Name	When tandem drive is being used
1004	0	ITL	Interlock	Master
	1	RMONR	High speed monitor latch command	Each axis
	2		Reserved	
	3			
	4	LSPC	+ side limit switch input	Each axis
	5	LSNC	– side limit switch input	Each axis
	6	DOGC	Proximity dog input	Each axis
	7		Reserved	

Note 1: The above address is the address for the axis 1. For the axis 2 and above, add C0h for each axis.

POINT
<ul style="list-style-type: none"> When the sensor input command (LSPC, LSNC, DOGC) is turned on, a normally-open contact turns on (a normally-closed contact turns off). The polarity of the limit switch input command is the normally closed contact. The polarity of the proximity dog input command can be changed by proximity dog input polarity (parameter No.0240).

⚠ CAUTION

- When "1: driver input" and "2: digital or input device input" are selected as sensor destinations, a delay occurs due to the communication to detect the signal status. Take the delay time due to communication into consideration when installing each sensor.
 - Communication delay when control cycle is 0.88ms: approx. 2ms
 - Communication delay when control cycle is 0.44ms: approx. 1.5ms
 - Communication delay when control cycle is 0.22ms: approx. 1.3ms

4. SYSTEM STARTUP

4.4.8 Vendor ID and type code setting

Available functions, parameter settings and ranges will vary by servo amplifier type. At the time the communication with the servo amplifier has started, the Q173SCCF will perform consistency check between vendor ID and type code of the servo amplifier connected and the parameter set. If a consistency check error occurs, driver type code error (system error E405) will be output, therefore set correct vendor ID and type code.

POINT
▪ If driver type code error (system error E405) occurred, the axis that has set an incorrect type code can be confirmed with "type code erroneous axis information" (monitor No.0484 to 0485).

(1) Control parameters

Parameter No.	Abbreviation	Name	Function
021D	*VEND	Vendor ID	Set the vendor ID. 0000h: Mitsubishi Electric
021E	*CODE	Type code	Set the type code. 1000h: MR-J4(W□)-□B 1200h: MR-JE-□B

4. SYSTEM STARTUP

4.5 System startup processing

(1) System startup procedure

After parameter initialization, start system startup before performing operations.

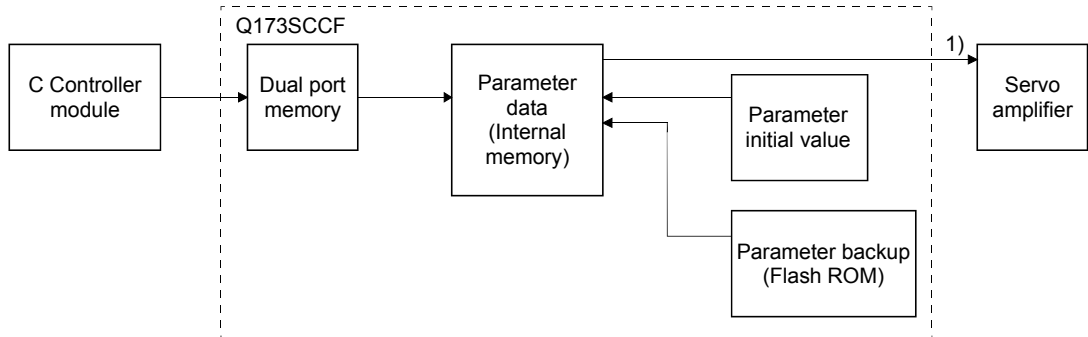

Figure 4.2 Parameter data flow during system startup

Procedure	Description	Remarks
1	The number of seconds passed since 0000hrs, January 1, 1970 is stored in system startup time.	The time is used to create data for alarm history function. When using the API library for Q173SCCF, the time is automatically set in the <code>sscSystemStart</code> API function.
2	Set the time synchronization information.	When using the API library, the time is automatically set in the <code>sscSystemStart</code> API function.
3	Perform the start system startup command (system command code 000Ah)	1) of Figure 4.2 The Q173SCCF will start communicating with the servo amplifier and write the servo parameters according to the parameters set (refer to Section 4.4.1), and system running will be in process (system status code: 000Ah). Start of system startup uses the <code>sscSetSystemCommandCode</code> function.
4	Confirm the during system running (system status code 000Ah).	Confirmation of during system running uses the <code>sscSetSystemCommandCode</code> function.

API LIBRARY

- Use the `sscSystemStart` function to start system startup.
- For a detailed procedure for system startup, refer to the sample programs (InterruptDrive/AllParamWrite) contained on the utility software.

4. SYSTEM STARTUP

(2) Sequence example

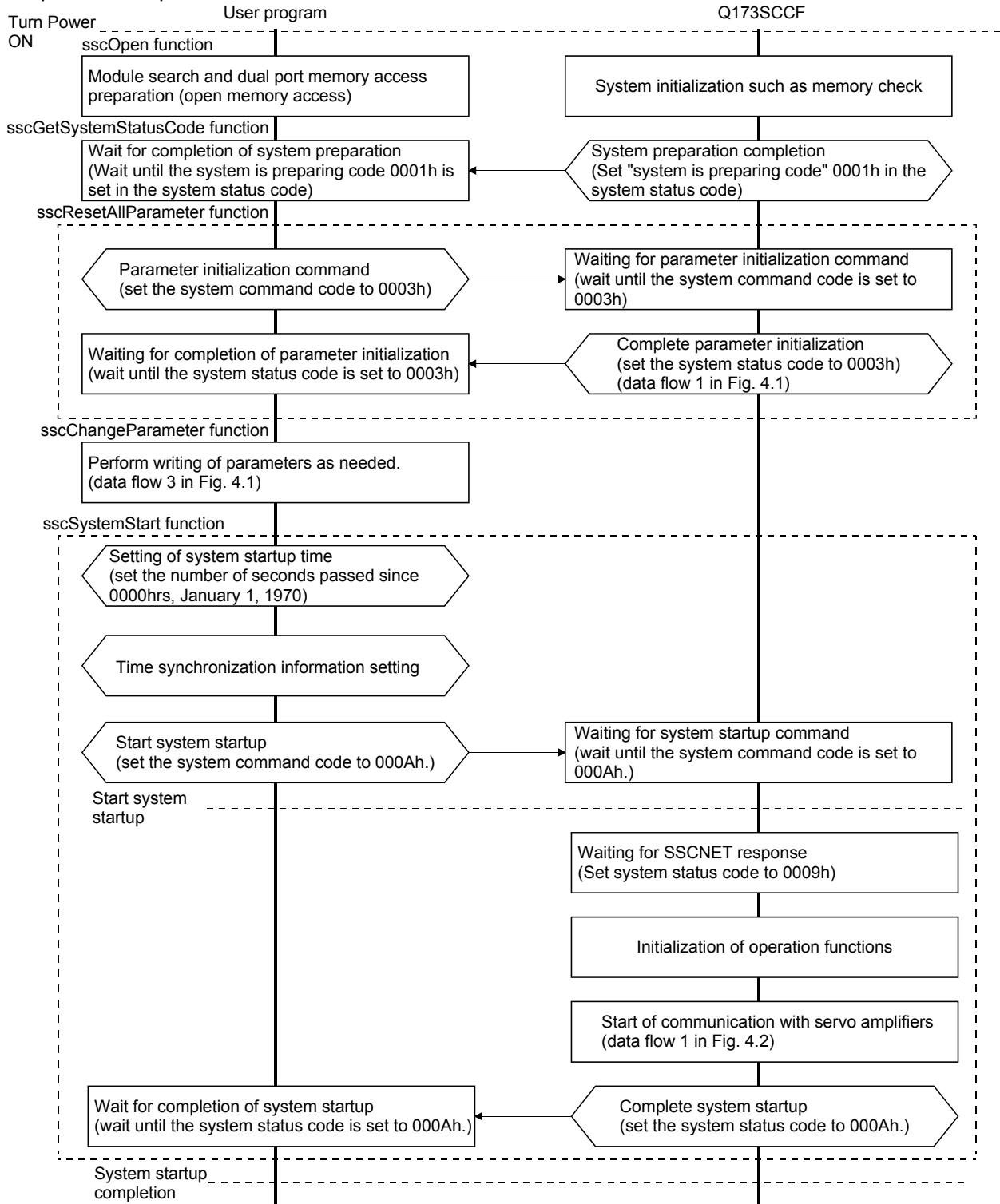

Note 1. If an error occurs during system startup, an error code is set in the system status code.

Refer to Section "13.6 System Error" concerning error codes.

- When the system status code does not become 000Ah (an error code is not stored either.), the following is possible: the SSCNET communication cable is disconnected, the connected equipment is turned off, the SSCNET communication method (parameter No.0001) is incorrect. The set communication method can be confirmed in SSCNET communication method (address 0008h).
- Communication with the axes for which parameter No.0200 control axis is set to "1: control performed" will be implemented, therefore be sure to set the control axis parameters.

MEMO

5. OPERATIONAL FUNCTIONS

5. OPERATIONAL FUNCTIONS

POINT
<ul style="list-style-type: none"> Refer to Chapter 10 for the table bit for each signal.

There are restrictions for the number of axes which can start simultaneously in each operation function and in start operation using other axes start. When the number of started axes exceeds the maximum number of simultaneous start axes, start operation will be performed for the rest of axes in the next control cycle or later.

Control cycle	Max. No. of simultaneous start axes
0.88ms	16
0.44ms	6
0.22ms	2

POINT
<ul style="list-style-type: none"> For the start operation of linear interpolation, one group is regarded to consist of four axes, irrespective of the number of axes in the group. For the start operation of tandem drive, one group is regarded to consist of one axis. Start operation by other axes start takes priority, the other axes start in order. When the number of axes which is set in start axis designation of the other axes start table exceeds the maximum number of simultaneous start axes, other axes start error occurs when the other axes start conditions are fulfilled.

5

The following shows the operation when axes 9 to 14 are started by other axes start by control cycle of 0.44ms, the other 14 axes are started in normal start operation.

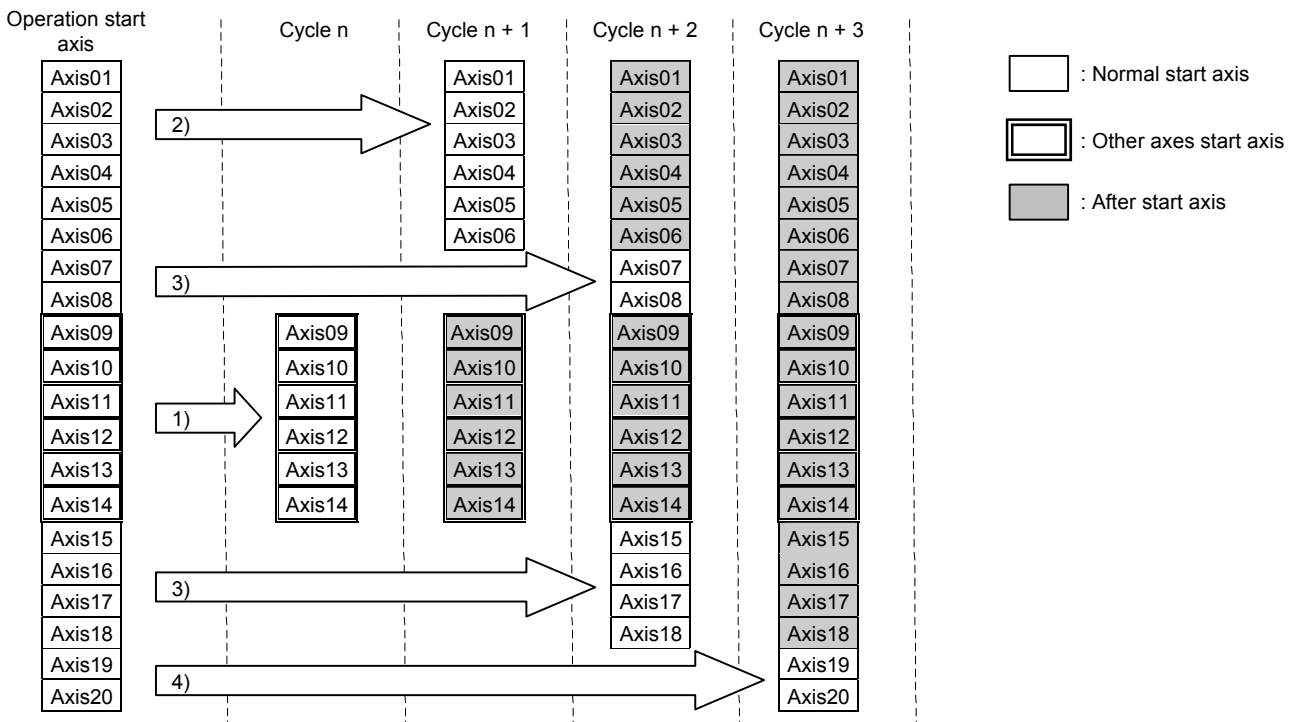

5. OPERATIONAL FUNCTIONS

5.1 JOG operation

5.1.1 Summary

When the movement direction is specified and the start operation signal (ST) input, it starts in the designated direction and movement continues until the start operation signal (ST) is turned OFF. When the start operation signal (ST) is turned off, it slows and comes to a stop. JOG operation can be used without completing home position return. JOG operation can be used without completing home position return (home position return request (ZREQ) is ON).

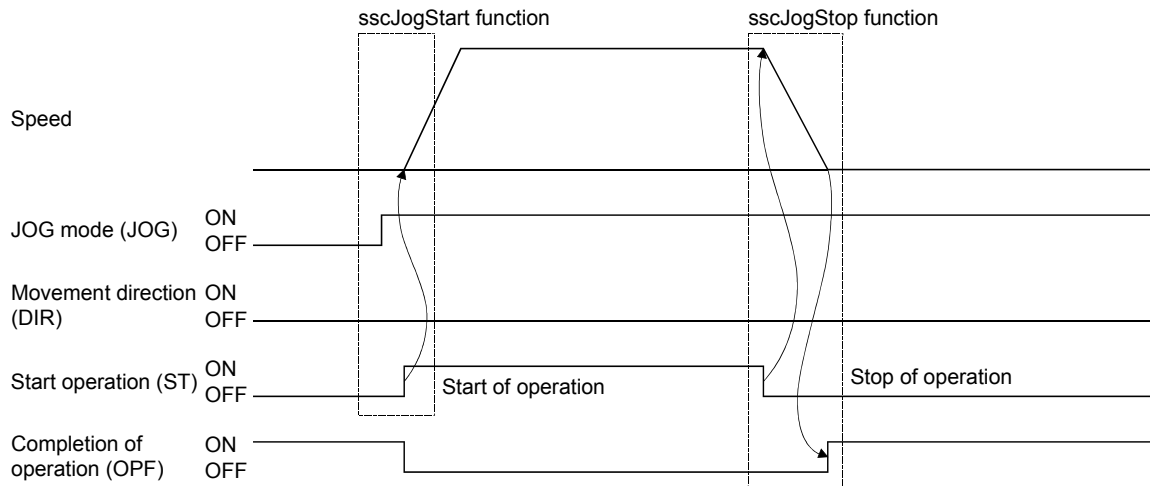

5.1.2 Start operation method

Start operation is performed according to the following procedure.

- (1) Turn on the JOG operation mode signal (JOG).
- (2) Set the manual feed speed, manual feed acceleration constant, and manual feed deceleration constant.
- (3) Use the movement direction signal (DIR) to set the movement direction of the axis.
When the movement direction signal (DIR) is OFF, the axis moves in the + direction. And when it is ON, the axis moves in the - direction.
- (4) Turn on the start operation signal (ST).

POINT
<ul style="list-style-type: none"> ▪ The manual feed speed, manual feed acceleration constant, manual feed deceleration constant, and movement direction signal (DIR) are read at the leading edge of the start operation signal (ST). It follows that after start operation, even if there are changes to the data or signal, they are ignored.

API LIBRARY
<ul style="list-style-type: none"> ▪ Use the sscJogStart function to perform procedures (1) to (4) above. ▪ Use the sscJogStop or sscJogStopNoWait functions to perform stop operation.

5. OPERATIONAL FUNCTIONS

5.1.3 Resuming operation

When the start operation signal (ST) is turned off, deceleration is started; however, if the start operation signal (ST) is turned back on while decelerating, it does not completely stop but reaccelerates.

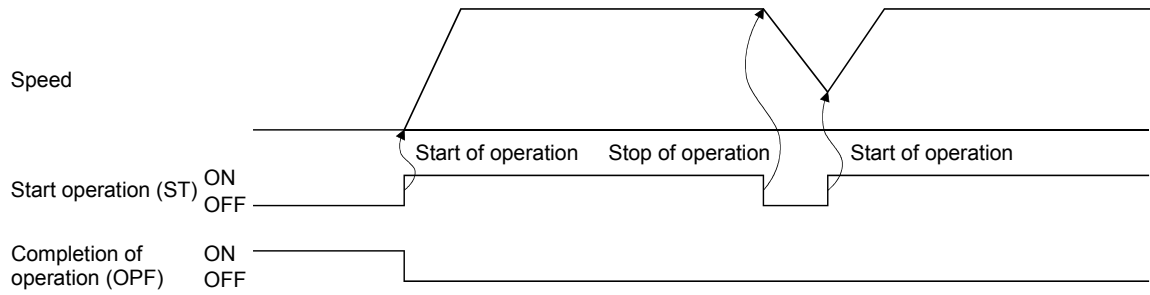

5. OPERATIONAL FUNCTIONS

5.2 Incremental feed

5.2.1 Summary

A prescribed feed amount is implemented for each fast start operation signal (FST). The feed amount is defined using the incremental feed movement amount.

Incremental feed can be used without completing home position return (home position return request (ZREQ) is ON).

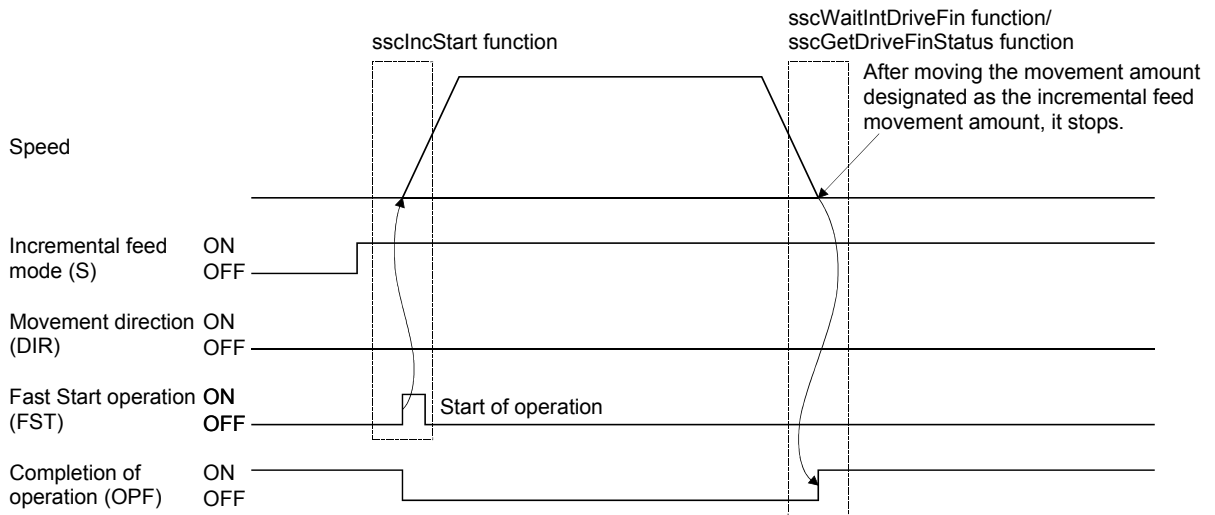

5. OPERATIONAL FUNCTIONS

5.2.2 Start operation method

Start operation is performed according to the following procedure.

- (1) Turn on the incremental feed mode signal (S).
- (2) Set the manual feed speed, manual feed acceleration constant, and manual feed deceleration constant.
- (3) Set the incremental feed movement amount.
- (4) Use the movement direction signal (DIR) to set the movement direction of the axis.
When the movement direction signal (DIR) is OFF, the axis moves in the + direction and when it is ON, the axis moves in the – direction.
- (5) Turn on the fast start operation signal (FST).

POINT

- The manual feed speed, manual feed acceleration constant, manual feed deceleration constant, movement direction signal (DIR), and incremental feed movement are read at the leading edge of the fast start operation signal (FST). It follows that after start operation, even if there are changes to the data or signal, they are ignored.
- Only positive numbers are valid for the incremental feed movement amount. Movement direction is designated by the movement direction signal (DIR).

API LIBRARY

- Use the `sscIncStart` function to perform procedures (1) to (5) above.
- Use the `sscGetDriveFinStatus` or `sscWaitIntDriveFin` functions to check completion of operation.
- Use the `sscDriveStop` or `sscDriveStopNoWait` functions to perform stop operation.

5. OPERATIONAL FUNCTIONS

5.3 Automatic operation

5.3.1 Summary

Automatic operation (positioning) uses the point table for operation. Position data and feed speed designation is set in the point table. When the fast start operation signal (FST) is turned on, instructions are executed in order from the instruction set at the start point No. to the end point No. If automatic operation is started prior to completion of home position return (home position return request (ZREQ) is ON), a home position return not complete error (operation alarm 90, detail 01) occurs upon starting operation and the operation stops.

POINT
<ul style="list-style-type: none"> The first point number for each of the axis point tables is 0000h. The first point number for each of the axis point tables can be designated using point number offset. Refer to Section 10.11 concerning point number offset.

Point table

Point	Position data [Command units]	Feed speed [Speed units]	(Note) Acceleration time constant [ms]	(Note) Deceleration time constant [ms]	(Note) Dwell/pre dwell [ms]	Auxiliary command	Other axes start specification	S-curve ratio [%]	Reserved
	4 bytes	4 bytes	2 bytes	2 bytes	2 bytes	2 bytes	4 bytes	1 byte	11 bytes
0000	2000	2000	20	30	0	0000h	00000000h	0	0
0001	5000	2000	30	50	0	0000h	00000000h	0	0
:	:	:	:	:	:	:	:	:	:

Note. Time specified by the acceleration constant, the deceleration constant and the dwell are rounded off based on the control cycle.
(The value is rounded to the nearest integer.)

For example, the dwell is specified to 10ms with the control cycle of 0.88ms, the time until executing point is completed after the completion of the point movement is 11 control cycles (approx. 9.778ms).

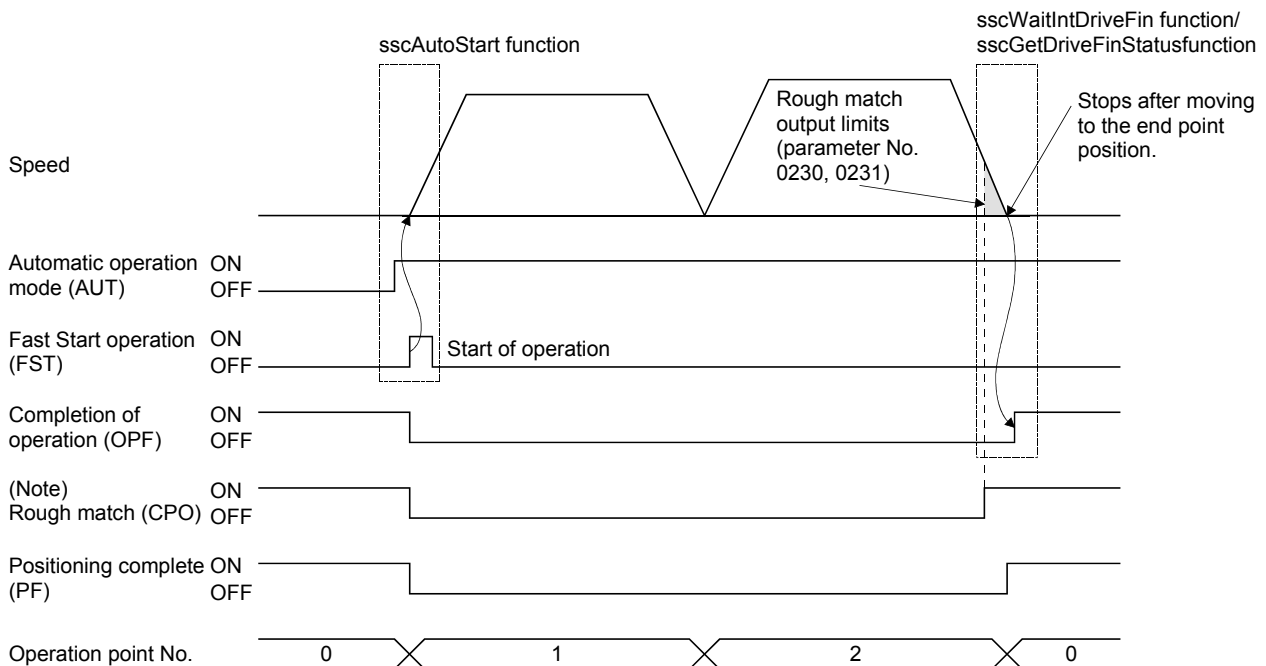

Note. The rough match signal (CPO) is determined when the end point is executed. Therefore, it does not turn on when passing points on the way.

5. OPERATIONAL FUNCTIONS

5.3.2 Start operation method

Start operation is performed according to the following procedure.

- (1) Set up the point table.
- (2) Set the start point No. and the end point No.
- (3) Turn on the automatic operation mode signal (AUT).
- (4) Turn on the fast start operation signal (FST).

POINT

- For stoppage of operation mid way, turn on the stop operation signal (STP).
- The operation point No. can be checked in the operation point No. of the axis status table (same as monitor No.030A).
- The point number starts from 0.
- The point table is a total of 320 points for all axes. The number of points distributed to each axis can be adjusted using the point number offset. For details, refer to Section 10.11.

API LIBRARY

- Use the `sscSetPointDataEx` function to set up point table in (1) above.
- Use the `sscAutoStart` function to perform procedures (2) to (4) above.
- Use the `sscGetDriveFinStatus` or `sscWaitIntDriveFin` functions to check completion of operation.
- Use the `sscDriveStop` or `sscDriveStopNoWait` functions to perform stop operation.
- Use the `sscSetPointOffset/sscCheckPointOffset` functions to set/get point number offset.
- For a detailed procedure from startup of automatic operation to check completion of operation, refer to the sample programs (InterruptDrive/PollingDrive) contained on the utility software.

5. OPERATIONAL FUNCTIONS

5.3.3 Auxiliary command

The auxiliary command can be set in the following procedure.

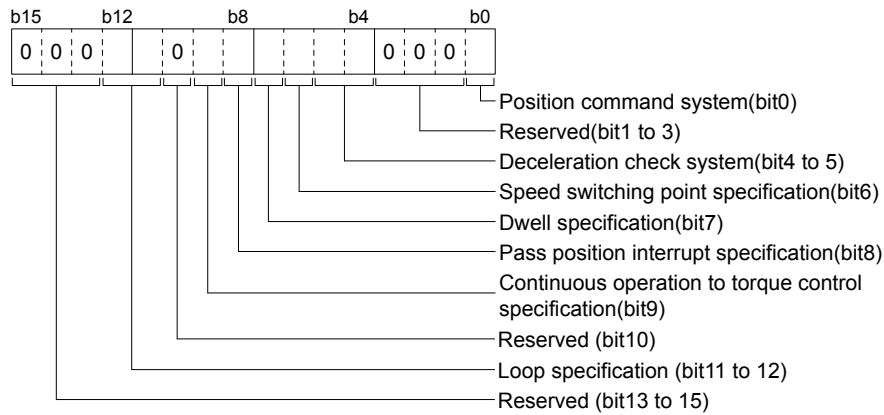

(Example) For designation of position command system as 1 (relative position command) and the deceleration check system as 2 (continue operation), set to "0021h".

(1) Position command system

Select the position data command system.

- 0: Absolute position command
- 1: Relative position command

POINT
<ul style="list-style-type: none"> ▪ If the setting of the position command system is incorrect, it causes a point table setting error (operation alarm 25, detail 01) and operation is stopped.

(a) Absolute position command

Position data is position from the home position.

(b) Relative position command

Position data is the movement distance from the current command position.

(2) Deceleration check system

Designates the point movement completion conditions.

- 0: In-position stop
- 1: Smoothing stop
- 2: Continue operation

POINT
<ul style="list-style-type: none"> ▪ If the setting of the deceleration check system is incorrect, it causes a point table setting error (operation alarm 25, detail 02) and operation is stopped.

5. OPERATIONAL FUNCTIONS

(a) In-position stop

After completion of the command pulse output, if it is in-position, the point movement is completed.

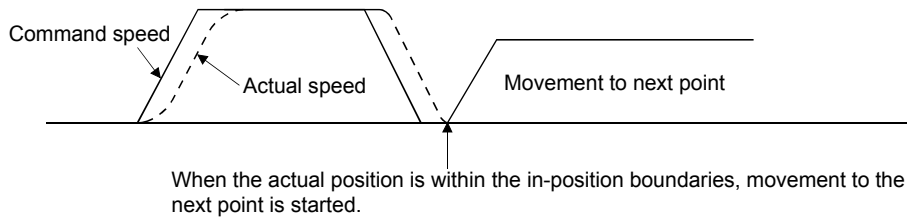

(b) Smoothing stop

After completion of the command pulse output, point movement is complete.

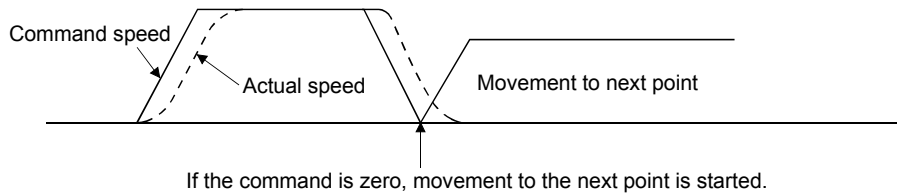

(c) Continue operation

After arriving at the position commanded to go to, the speed is changed to the speed commanded for the next point and movement to the next point is started. The acceleration and deceleration time constants for changing speeds are set to the acceleration and deceleration time constants of the next point.

However, continuous operation is not performed under the following conditions.

- When a dwell is set

If there is a dwell defined, after coming to a smoothing stop and completion of the dwell time setting, movement to the next point is started.

- When there is end point

Operation that is the same as a smoothing stop is performed.

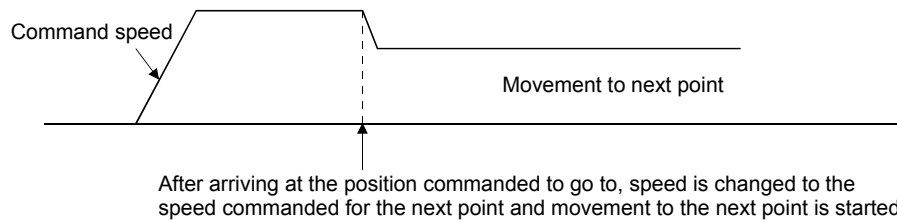

5. OPERATIONAL FUNCTIONS

For the end point of continuous operation, if the position after deceleration stop exceeds the command position. A selection can be made from the following control option 2 (parameter No.0201).

- 1) Stop by the alarm
- 2) After completion of the deceleration stop, return to the command position
- 3) Stop at the command position

For selection 2), the stop position over-bound signal (POV) is turned on. The stop position over-bound signal (POV) is turned off at the next start up.

- 2) After completion of the deceleration stop, return to the command position

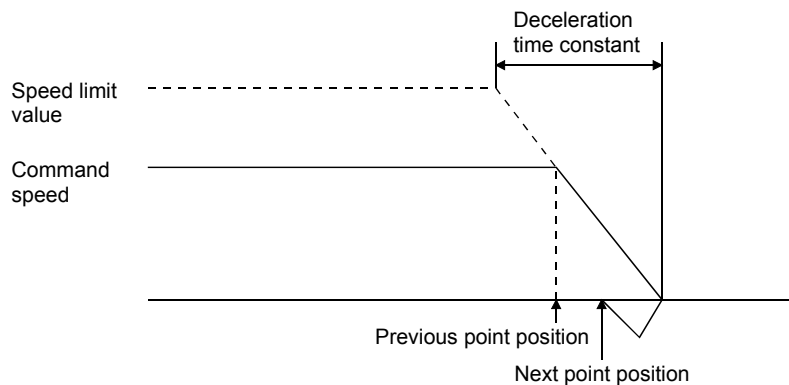

- 3) Stop at the command position

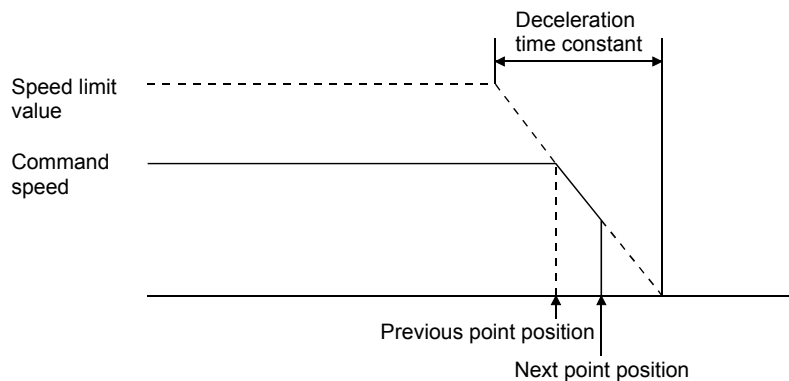

POINT
<ul style="list-style-type: none"> ▪ There are times, such as that shown below, where the deceleration position exceeds the command position. This causes a position exceeded during positioning (operation alarm 24, detail 01) and operation is stopped. ▪ For when the movement direction is reversed when position of the next point from the point designated by the deceleration check system under continuous operation. ▪ For the case where deceleration check system goes from continuous operation (point n) to smoothing stop (point n+1) or in-position stop and then goes to reverse direction (point n+2) even when the point table is in this order, if point n+1 positioning distance is not satisfied by the necessary deceleration distance from the point n command speed.

5. OPERATIONAL FUNCTIONS

(3) Speed switching point specification

If "2: Continue operation" is selected in the deceleration check system, a point where speed change is completed can be specified.

0: After point switching

1: Before point switching

(a) After point switching

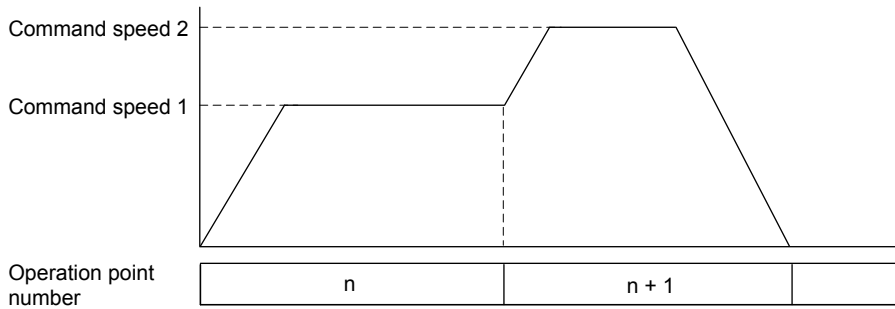

(b) Before point switching

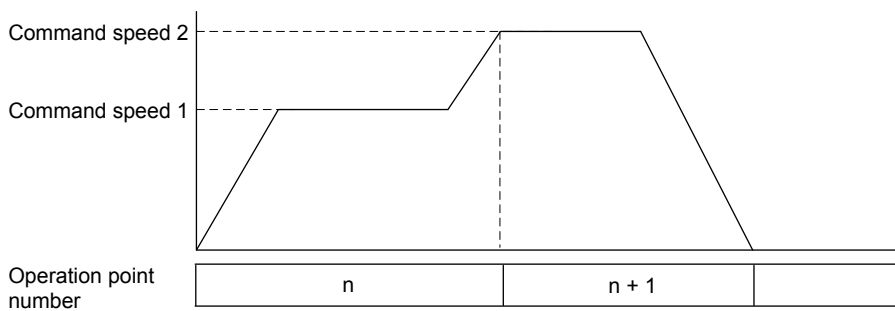

POINT

- If "1: Before point switching" is specified, the point table (feed speed) of the next point is imported (read) at start operation or timing when the point switches next point. If the setting of the point table of the next point is incorrect, it causes a point table setting error (operation alarm 25, detail 01) and operation is stopped.

5. OPERATIONAL FUNCTIONS

(4) Dwell specification

Specify the system of dwell.

0: Dwell

1: Predwell

(a) Dwell

Specify the time until executing point is completed after the point movement is completed. For the pass point, after the time specified with dwell has elapsed, the next point starts moving. For the end point, after the time specified with dwell has elapsed, the completion of operation signal (OPF) turns on.

POINT
<ul style="list-style-type: none"> The setting range of dwell is 0 to 65535ms.

1) When the deceleration check system is Smoothing stop

Time is counted after the during smoothing of stopping signal (SMZ) turns on. The following shows the case for the pass point.

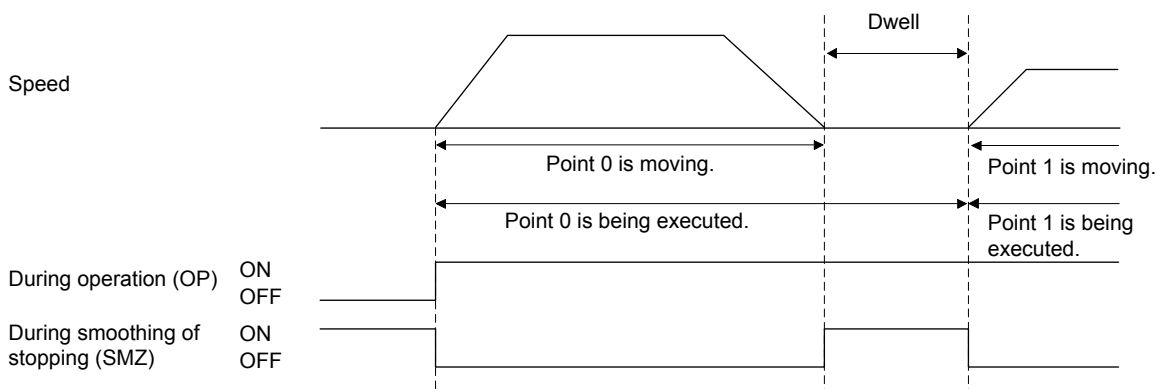

2) When the deceleration check system is In-position stop

Time is counted after the in-position signal (INP) turns on after the during smoothing of stopping signal (SMZ) turns on. The following shows the case for the end point.

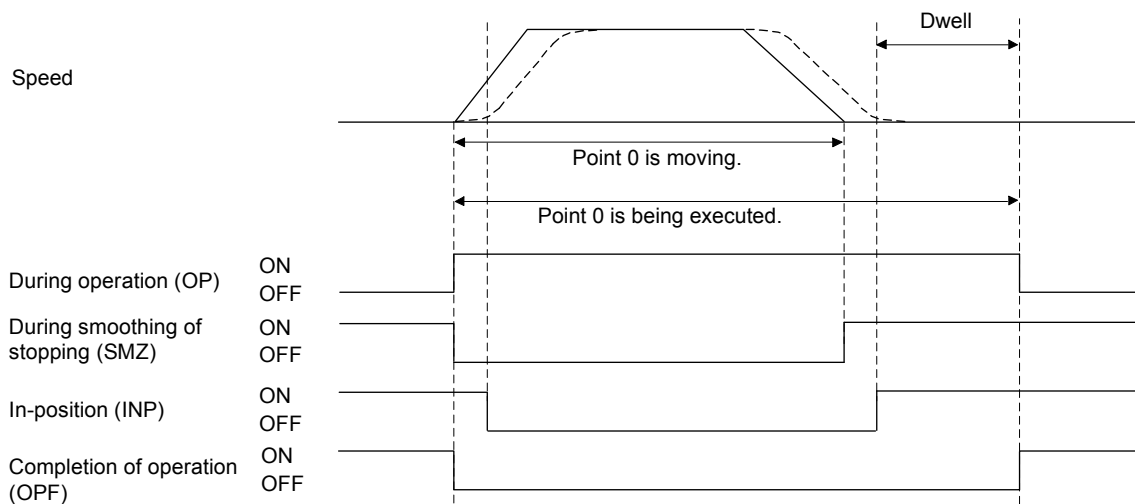

5. OPERATIONAL FUNCTIONS

3) When the deceleration check system is Continue operation

When dwell is set, the condition of point movement completion is a smoothing stop. Therefore, the control is the same as when Smoothing stop is set to the decelerate check system.

(b) Predwell

Point starts moving after the time specified with predwell has elapsed.

POINT
<ul style="list-style-type: none"> ▪ The setting of predwell is valid only in the start point. If predwell is set in the other points, it causes a point table setting error (operation alarm 25, detail 0A) and operation is stopped. ▪ In the initial setting, the setting range of predwell is 0 to 3000ms. If the value which is out of the range is set, it causes a point table setting error (operation alarm 25, detail 0A) and operation is stopped. To remove the limit of the setting range, set 1: 0 to 65535ms to predwell setting range (parameter No.0206).

⚠ CAUTION

- If large value is set by mistake, the wait time of axis is long and it may look as if axes did not operate. In that case, it is dangerous to approach the moving part because axes operate unexpectedly. Do not approach the moving parts even when axes do not operate while during operation signal (OP) is on because the axes may operate.

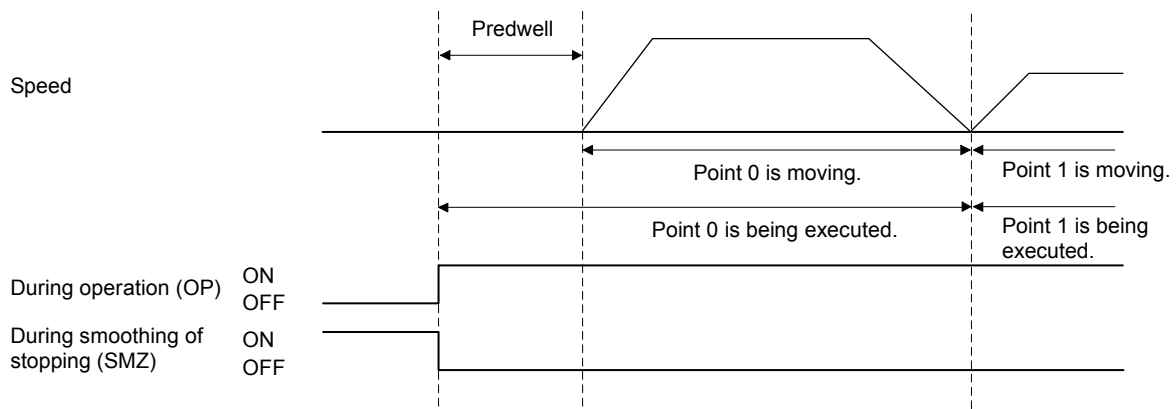

5. OPERATIONAL FUNCTIONS

(5) Pass position interrupt specification

Select valid or invalid for the pass position interrupt.

0: Pass position interrupt invalid

1: Pass position interrupt valid

POINT	
	<ul style="list-style-type: none">▪ This setting in the point data of the start point No. is valid only. If the point data after the start number are set, it causes a point table setting error (operation alarm 25, detail 0C) and the operation is stopped.

(6) Continuous operation to torque control specification

Select valid or invalid for continuous operation to torque control.

0: Continuous operation to torque control invalid

1: Continuous operation to torque control valid

POINT	
	<ul style="list-style-type: none">• Refer to Section 6.32 for continuous operation to torque control.

(7) Loop specification

Specify the start and end when using the point table in loop method.

0: Not using point table method

1: Loop start point

2: Loop end point

POINT	
	<ul style="list-style-type: none">• Refer to Section 5.3.6 for loop specification.

5. OPERATIONAL FUNCTIONS

5.3.4 Other axes start specification

Set other axes start data number (1 to 32). When the other axes start data number is set, the Q173SCCF starts the other axes according to other axes start conditions and operation details of their start data. Up to 2 other axes start data number can be set. For details of other axes start function, refer to Section 6.23.

POINT	
	<ul style="list-style-type: none">▪ If the setting of the other axes start specification is incorrect, it causes a point table setting error (operation alarm 25, detail 09) and operation is stopped.

5.3.5 S-curve ratio

Perform S-curve acceleration/deceleration for acceleration/deceleration selected in speed options (parameter No.0220). For automatic operation, this setting is valid regardless of the setting of S-curve ratio (parameter No.0221).

0: S-curve acceleration/deceleration invalid

1 to 100: S-curve acceleration/deceleration

5. OPERATIONAL FUNCTIONS

5.3.6 Point table loop method

Point table loop method can be used by setting the loop specification of auxiliary command. When using the point table in loop method, refer to/set the following data.

(1) Axis data command/status table

Axis data command table

Address	Content	Setting range
102C	Start point No.	0 to 319
102D		
102E	End point No.	0 to 319
102F		
103A	Latest command point No.	1 to 320
103B		

Axis data status table

Address	Content	Output range
108C	Operation point No.	0 to 320
108D		

Note 1. The above address is the address for the axis 1. For the axis 2 and above, increase in units of C0h for each axis.

Note 2. Set the latest command point No. to the value of the point number + 1.

(2) Axis status bit

Address	Bit	Abbreviation	Signal name	When tandem drive is being used
1067	0	PPIOP	Pass position interrupt	Master
	1	PPIFIN	Pass position interrupt complete	Master
	2	PPIERR	Pass position interrupt incomplete	Master
	3	Reserved	Reserved	Reserved
	4			
	5			
	6			
	7	AUTLO	In point table loop	Master

(a) Details on axis command bit

Abbreviation	Signal name	Function details
AUTLO	In point table loop	<p>[Function] Indicates that the point table is being used in loop method.</p> <p>[Operation] <Conditions for turning ON> The operation of loop start point set by the auxiliary command loop specification of the operation start point has started.</p> <p><Conditions for turning OFF> One of the following conditions is not satisfied.</p> <ul style="list-style-type: none"> • The operation of loop end point set by auxiliary command loop specification is completed. • During the operation of a point set by auxiliary command loop specification, an alarm or stop caused the operation to complete.

5. OPERATIONAL FUNCTIONS

(3) Controlling method for using the point table in loop method

The controlling method for using the point table in loop method is as follows.

- 1) Set the point table and latest command point No.
- 2) Set the start point No. and end point No. to the start point No. and end point No. of the loop.
- 3) Turn ON the automatic operation mode signal (AUT).
- 4) Turn ON the fast start operation signal (FST).
- 5) After the completion of operation for each point, update (overwrite) the point table, and set the latest command point No.
- 6) At the completion of operation, set the loop end point to the auxiliary command loop specification, and set the latest command point No.

5. OPERATIONAL FUNCTIONS

POINT
<ul style="list-style-type: none">• When operation point No. matches the latest command point No., operation waits until the latest command point No. is updated. (Operation is not completed, and remains in a stopped state.)• When a speed change is conducted during standby, speed change error signal (SCE) turns ON, and speed cannot be changed.• When a time constant change is conducted during standby, acceleration time constant change error signal (TACE), or deceleration time constant change error signal (TDCE) turns ON, and time constant cannot be changed.• When the loop start point is specified but the latest command point No. is 0, a point table loop error (operation alarm 5F, detail 01) occurs, and operation does not start.• When the loop start point is set in one-point operation (start point No. and end point No. are matching), a point table loop error (operation alarm 5F, detail 02) occurs, and operation does not start.• When a value smaller than start point No. + 1, or a value larger than end point No. + 1 is input to the latest command point No., a point table loop error (operation alarm 5F, detail 03) occurs, followed by a deceleration stop.• Only the point data for the start point No. is valid for the loop start point of this setting. Point data after the loop start point that is set to the loop start point is invalid.• After the operation of a point which specifies continuous operation, when the next point has not been updated, a point table loop error (operation alarm 5F, detail 04) occurs, and operation is cancelled with a deceleration stop.• During an operation that does not use loop method, when the loop end point is specified, a point table loop error (operation alarm 5F, detail 05) occurs, and operation is cancelled with a deceleration stop.• When specifying switch before point in speed switching point specification, use more three or more points.• When specifying switch before point in speed switching point specification, update the next point before the start of operation for the specified point. When the next point is not updated before start of operation of the specified point, a point table loop error (operation alarm 5F, detail 06) occurs, and operation is cancelled with a deceleration stop.• The settings for which only the point of the start point No. is valid (pass position interrupt specification, etc.) are only valid for the start operation point. When setting to a point other than the start operation point, the operation is the same as when setting point data after the start point No.

5. OPERATIONAL FUNCTIONS

API LIBRARY

- Use the sscSetPointDataEx function for setting of the point table.
- Use the sscSetLatestPointNumber function for setting of the latest command point No.
- Use the sscAutoStart function to perform the procedures in (3) 2) to 4) of this section.
- Use the sscGetDriveFinStatus or sscWaitIntDriveFin functions to check completion of operation.
- Use the sscDriveStop or sscDriveStopNoWait functions to perform stop operation.
- Use the sscSetPointOffset/sscCheckPointOffset functions to set/get point number offset.
- For a detailed procedure from startup of automatic operation to check completion of operation, refer to the sample program "DrivePointLoop" contained on the utility software.

(4) Operation example

The following is an operation example of using point number 0 to 7.

(a) Before start of operation

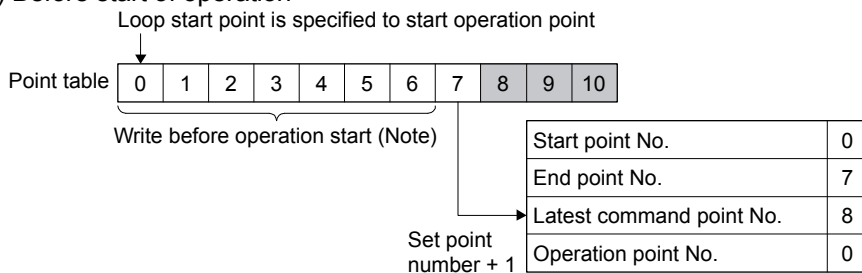

Note. Writing point data for the entire area used in the loop before operation start is not necessary.

(b) During operation

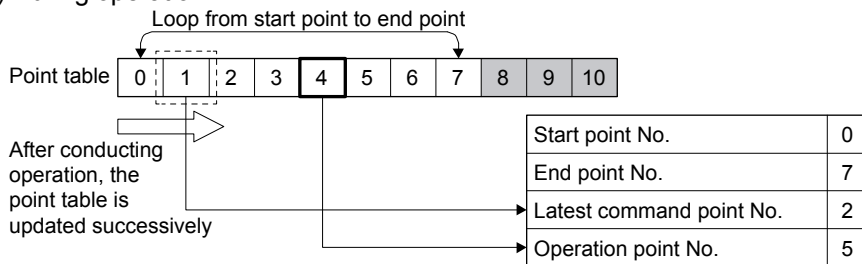

Note. Do not update the point table of operation point No.

(c) At operation completion

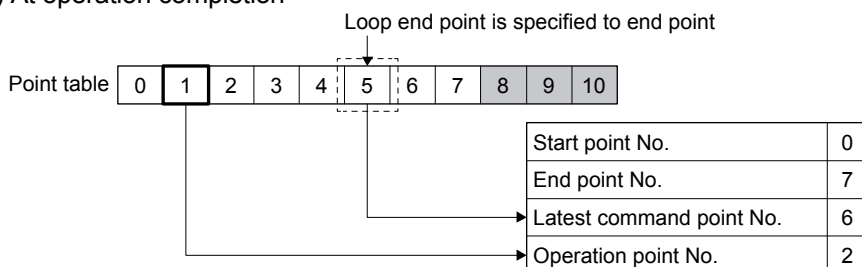

5. OPERATIONAL FUNCTIONS

5.4 Linear interpolation

5.4.1 Summary

Linear interpolation operation has interpolation control performed for the axes set up as a group. This system enables a maximum of 4 axis interpolation control. When the feed speed and position data are defined in the point table and the fast start operation signal (FST) is input, all of the axes setup in the group perform linear interpolation operation. If linear interpolation operation is started prior to completion of home position return (home position return request (ZREQ) is ON), a home position return not complete error (operation alarm 90, detail 01) occurs upon starting operation and the operation stops.

Afterwards, the fast start operation signal (FST) is input on a primary axis and other axes are referred to as auxiliary axes.

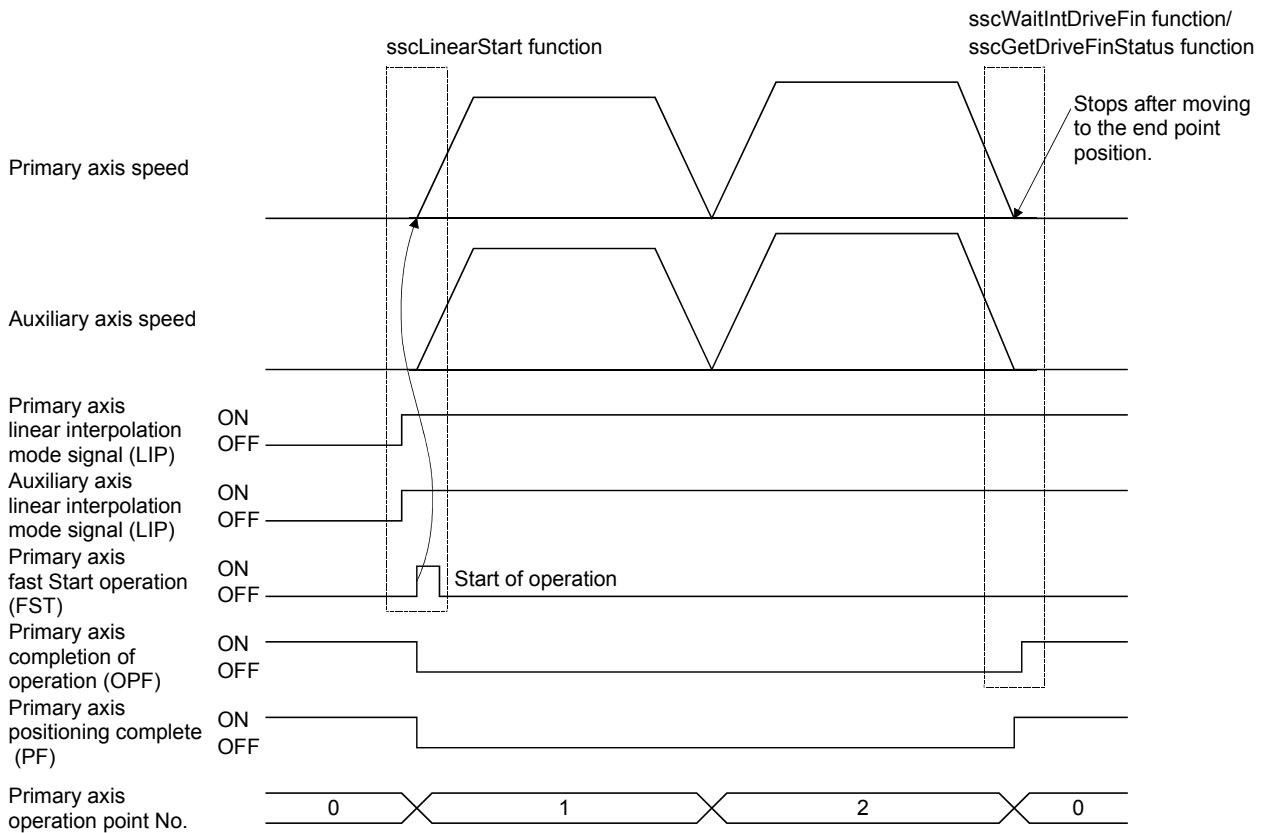

POINT	
<ul style="list-style-type: none"> The group setting is set using the linear interpolation group (parameter No.0260). If the group number is set to 0, the axis becomes an independent axis, making it so linear interpolation operation can not be performed. The number of groups that can be defined differs with the control cycle and the maximum number of groups is 8. 	
Control cycle	Valid group number
0.88 ms	1 to 8
0.44 ms	1 to 4
0.22 ms	0
<ul style="list-style-type: none"> The fast start operation signal (FST) is only to be input on a primary axis. 	

5. OPERATIONAL FUNCTIONS

An example of the feed speed and speed of axis 1 and 2 when each axis is interpolated is shown below.

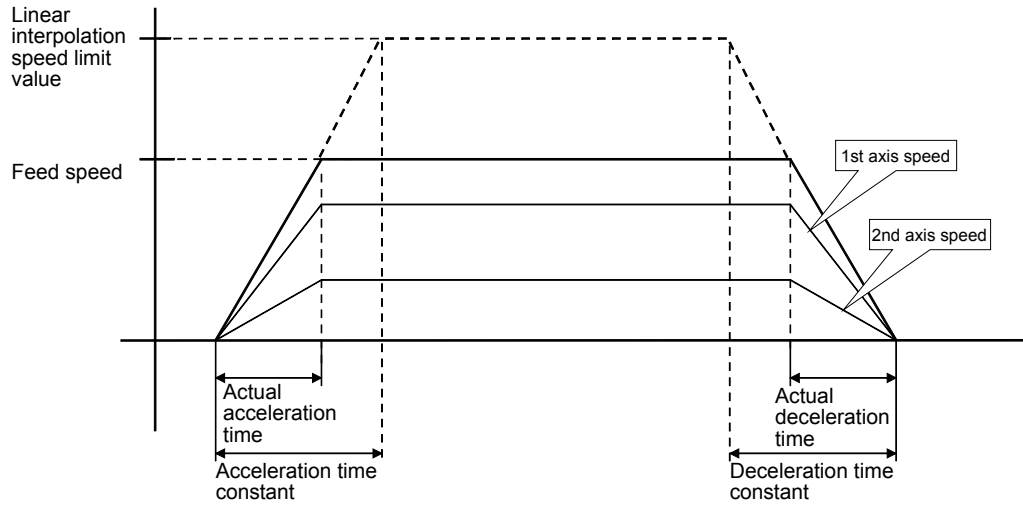

Speed for each axis is figured out by dividing feed speed by distance ratio.

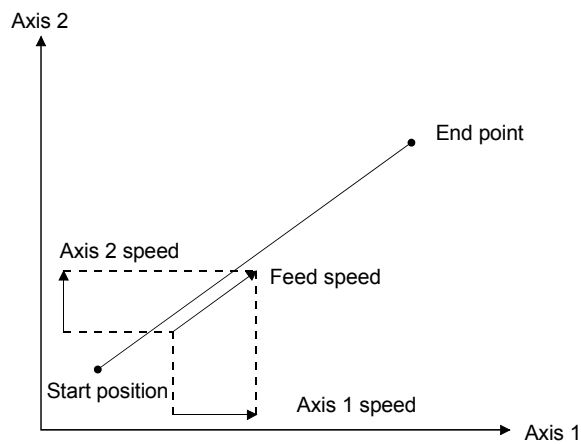

5. OPERATIONAL FUNCTIONS

5.4.2 Settings

The following items are defined for performing linear interpolation. Refer to Section 5.3 concerning details for the point table.

(1) Setting 1: Items set for system parameter

Items	Content	Remarks
System parameter	System option 5 (parameter No.004C)	Set the input method of the interpolation axis No. for linear interpolation. (0: Control parameter, 1: Point table)

(2) Setting 2: Items set for all axes to be interpolated.

Items	Content	Remarks
Point table	Position data	Define setting within maximum moveable limits. (Maximum moveable limit = 999999999)
	Other axes start specification	Define the setting when using the other axes start.
	Pass position interrupt specification	Define the setting when using the pass position interrupt.
Axis data	Start point No. End point No.	Define the settings such that the number of points between start and finish is the same for all axes in the group configuration.
Axis data (command bit)	Linear interpolation mode signal (LIP)	Turn on this bin.
Control parameter	Linear interpolation group (parameter No.0260)	Define the valid group number. The maximum number of axes that can be defined for a group is 4. For tandem drive axes, only the master axis must be set.
	Speed limit value (parameter No.0222, 0223)	Defines the speed limit for each axis. Used when selecting "speed clamp" or "alarm stop" as control options for excessive speed processing.

(3) Setting 3: Items defined for the primary axis (axis where start operation signal (ST) is input) (When system parameter is "0: Control parameter")

Items	Content	Remarks
Point table for primary axis	Feed speed Acceleration time constant (ms) Deceleration time constant (ms) Dwell (ms) Auxiliary command S-curve ratio [%]	
Control parameters for the primary axis	Speed units (parameter No.0200) Linear interpolation options (parameter No.0261) Linear interpolation speed limit value (parameter No.0262, 0263) Start up speed (parameter No.0224, 0225) Speed units multiplication factor (parameter No.020E, 020F)	The r/min of the units for speed can not be set.
Command data for the primary axis	Latest command point No.	Set when using the point table loop method.

5. OPERATIONAL FUNCTIONS

(4) Setting 4: Items defined for the primary axis (axis where start operation signal (ST) is input) (When system parameter is "1: Point table")

Items	Content	Remarks
Point table for primary axis	Feed speed Acceleration time constant (ms) Deceleration time constant (ms) Dwell (ms) Auxiliary command S-curve ratio [%] Interpolation axis No.	
Control parameters for the primary axis	Speed units (parameter No.0200) Linear interpolation options (parameter No.0261) Linear interpolation speed limit value (parameter No.0262, 0263) Start up speed (parameter No.0224, 0225) Speed units multiplication factor (parameter No.020E, 020F)	The r/min of the units for speed cannot be set. Linear interpolation group (parameter No.0260) setting is not necessary.
Command data for the primary axis	Latest command point No.	Set when using the point table loop method.

Point table (when system parameter is "1: Point table")

POINT	Position data [Command unit]	Feed speed [Speed unit]	Acceleration time constant [ms]	Deceleration time constant [ms]	Dwell [ms]	Auxiliary command	Other axes start specification	S-curve ratio [%]	Reserved	Interpolation axis No.	Reserved
	4 bytes	4 bytes	2 bytes	2 bytes	2 bytes	2 bytes	4 bytes	1 byte	3 bytes	4 bytes	4 bytes
0000	2000	2000	20	30	0	0000h	00000000h	0	0	00040302h	0
:	:	:	:	:	:	:	:	:	:	:	:
0020	5000	1000	30	50	0	0000h	00000000h	0	0	00080706h	0
:	:	:	:	:	:	:	:	:	:	:	:

(a) Interpolation axis No.

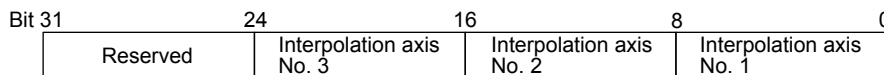

- Interpolation axis No. 1 to 3

Specify the axis Nos. of auxiliary axes set to the same group during linear interpolation

Example) Set 00040302h when setting axis 2, 3, and 4 to interpolation axes No. 1 to 3 respectively which have axis 1 as primary axis.

1) Cause of alarm

- When an axis No. exceeding 32 is set to interpolation axis No. 1 to 3, interpolation axis No. incorrect (operation alarm 41, detail 03) occurs and operation is stopped.
- When the number of linear interpolation groups operating simultaneously exceeds the number of valid groups, number of valid interpolation groups exceeded (operation alarm 41, detail 04) occurs and operation is stopped.

5. OPERATIONAL FUNCTIONS

5.4.3 Start operation method

Start operation is performed according to the following procedure.

- (1) Define the linear interpolation group, the linear interpolation speed limit, and the linear interpolation options in the control parameters. The group number is valid during system startup. Other than that it is valid during writing of parameters.
- (2) Set up the point table. At this time, all items are set up for the primary axis and only position data is set up for auxiliary axes. Settings for other items are invalid.
- (3) Set the start point No. and end point No. for all of the axes in the group configuration. Define the setting so that the numbers of points for all of the axes are the same.
- (4) Turn on the linear interpolation mode signal (LIP) for all of the axes in the group.
- (5) Turn on the fast start operation signal (FST) for the primary axis.

POINT
<ul style="list-style-type: none">▪ To stop the operation, turn on stop operation signal (STP) of any axis in the linear interpolation group.▪ The operation point No. can be checked in the operation point No. of the axis status table (same as monitor No.030A).▪ The point number starts from 0.▪ The point table is a total of 320 points for all axes. The number of points distributed to each axis can be adjusted using the point number offset. For details, refer to Section 10.11.▪ When using the point table in loop method, the primary axis setting values are valid for the latest command point No., and the start point No. and end point No. of the loop. Update the latest command point No. after writing the point tables of all axes of the group.▪ The specifications when using "1: Use point table" as the interpolation axis setting method of system option 5 (parameter No.004C) are shown below.<ul style="list-style-type: none">▪ Specification of interpolation axis No. is only valid for starting point.▪ Linear interpolation group (parameter No.0260) is invalid even when specified.▪ The startup method does not change.▪ Changeable interpolation group signal (IPCH) turns ON.▪ Linear interpolation outputs the interpolation group number being executed to the primary axis and auxiliary axis being executed.▪ The interpolation group number for the primary axis and auxiliary axis for which linear interpolation has ended is cleared and becomes 0.

5. OPERATIONAL FUNCTIONS

API LIBRARY

- Use the sscSetPointDataEx function to set up point data in (2) above.
- Use the sscLinearStart function to perform procedures (3) to (5) above.
- Use the sscDriveStop or sscDriveStopNoWait functions to perform stop operation.
- Use the sscGetDriveFinStatus or sscWaitIntDriveFin functions to check completion of operation.
- Use the sscSetPointOffset/sscCheckPointOffset functions to set/get point number offset.

5. OPERATIONAL FUNCTIONS

5.4.4 Processing for exceeding speed limit for each axis

Processing is different concerning exceeding speed limit for each axis depending on the setting for excessive speed processing (parameter No.0261).

(1) Using a speed clamp

When parameter No.0261 is set to 0, if there is an axis that exceeds the speed limit, other axes grouped with the axis are also clamped.

The actual acceleration time is the time until the feed speed after clamping is reached.

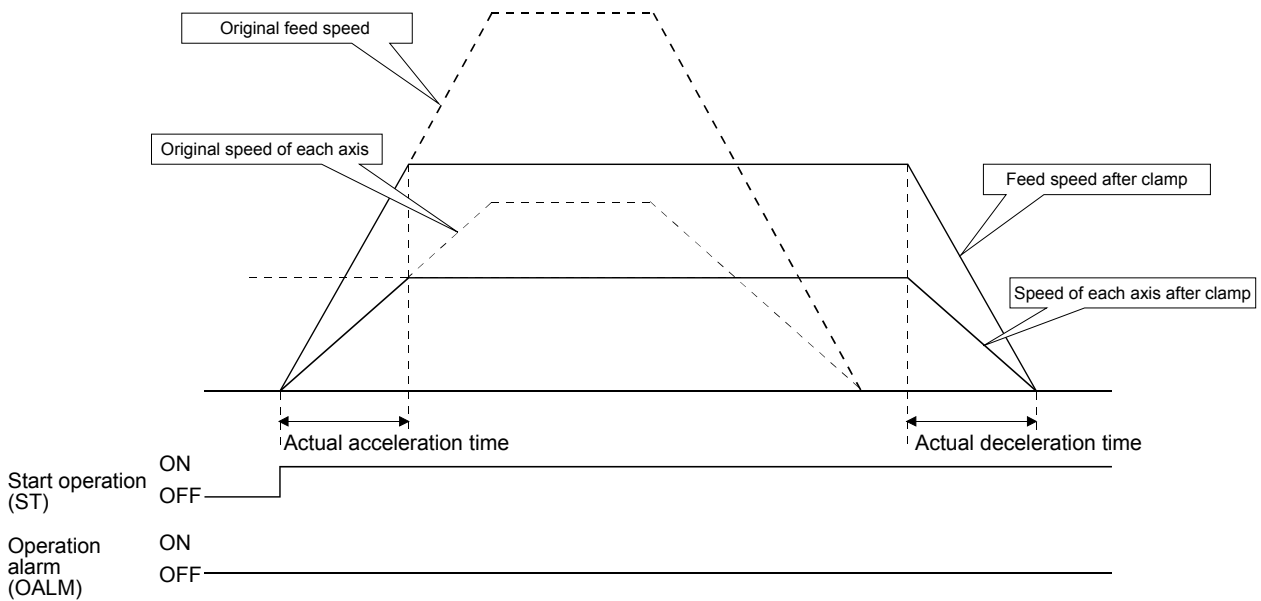

(2) For using alarm stop (example for continuous operation point change)

When parameter No.0261 is set to 1, if there is an axis that exceeds the speed limit for point toggling other than start up or continuous operation, an alarm is set and start up can not be performed.

During continuous operation, if there is an axis that exceeds the speed limit, an alarm is set and deceleration to a stop is performed.

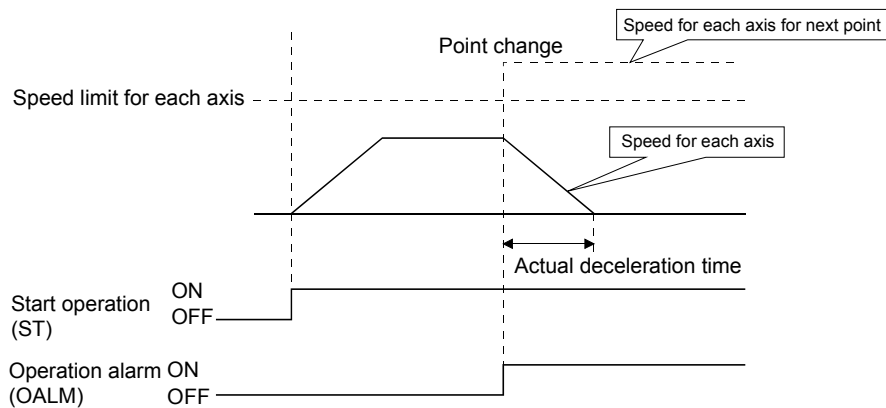

5. OPERATIONAL FUNCTIONS

(3) No processing

When parameter No.0261 is set to 2, normal operation is continued even if the speed limit is exceeded.

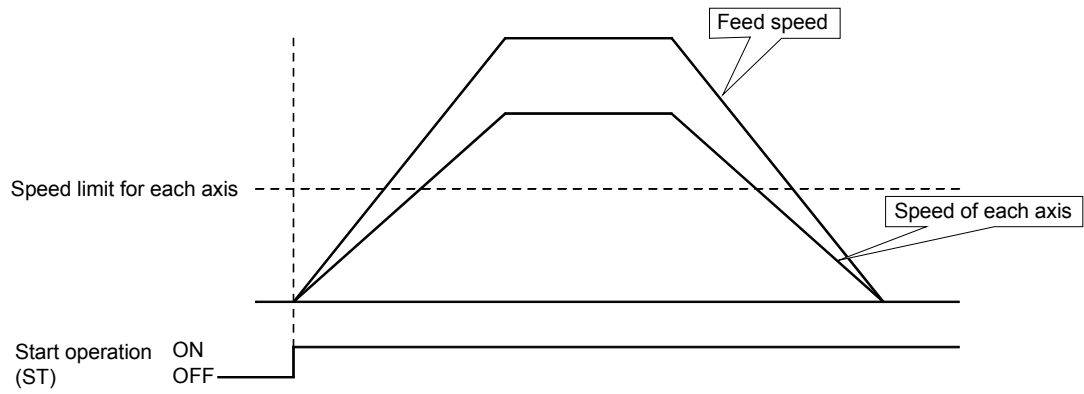

Note. This enables operation at the limits of the motor; however, there is the possibility of setting overload or over speed alarms.

5. OPERATIONAL FUNCTIONS

5.4.5 Restrictions

The following restrictions apply concerning use of linear interpolation.

- (1) A primary axis linear interpolation start up error (operation alarm 40) occurs for the following.
 - If axes that have been set to something besides linear interpolation mode (LIP) are included in the same group. (operation alarm 40, detail 01)
 - If a single group is defined with 5 or more axes. (operation alarm 40, detail 02)
 - If a group number that exceeds the valid group number is defined when performing start operation for linear interpolation. (operation alarm 40, detail 03)
 - If the numbers of points defined for axes in the group are different. (operation alarm 40, detail 04)
 - If the speed unit (parameter No.0200) is defined to be "2: r/min". (operation alarm 40, detail 05)
- (2) A primary axis linear interpolation point data error (operation alarm 41) and an auxiliary axis group error (operation alarm 16, detail 01) occur for the following.
 - If there is an axis within the group whose movement amount exceeds the maximum of 999999999. (operation alarm 41, detail 01)
 - If the speed limit for the group configured axis is exceeded. (operation alarm 41, detail 02)
(If excessive speed processing (parameter No.0261) is defined to be "1: alarm stop".)
- (3) If there is an auxiliary axis in operation or has an alarm set upon starting linear interpolation mode, "can't start linear interpolation auxiliary axis error" (operation alarm 42) occurs on the primary axis.
- (4) If an alarm occurs during operation, the axis that caused the error occurs to the particular alarm and the other axes in the group are set to "group error" (operation alarm 16, detail 01).
- (5) If there is an axis such as the axes defined below within the group, a "software limit error" occurs.
 - If there is movement from within Software limits to outside the limits. (operation alarm A1, detail 01)
 - If there is movement from outside Software limits in the direction of outside the limits. (operation alarm A2, detail 01)
- (6) The command change signal is input to the primary axis. Input of the signal to auxiliary axes is invalid.
 - When changing speeds.
 - When changing time constants.
 - When changing position.

5. OPERATIONAL FUNCTIONS

5.5 Home position return

5.5.1 Summary

The home position return enables the establishment of a start position (home position) in positioning control. By performing a home position return, instructed coordinates and machine coordinates will be consistent. When the incremental system method is used, a home position return is required for each power supply. On the other hand, when the absolute positioning detection system is used, performing a home position return restores the current command position even after power supply is turned off. This makes a home position return unnecessary after power is supplied again. Refer to Section 6.21 concerning absolute position detection systems.

The following table shows the methods of home position return. Select the optimum method according to the configuration and application of the machine with the home position return option 1 (parameter No.0240). For any home position return method, when a home position return is completed, the current command position is a position set in the home position coordinates (parameter No.0246, 0247).

Method	Description
Dog method	A method that uses the first Z-phase after the proximity dog rear end as the home position.
Data set method	A method that uses a current position as the home position. No proximity dog or Z-phase is necessary.
Stopper method	A method that uses the position of the collision stop caused by JOG operation or something similar as the home position. No proximity dog or Z-phase is necessary.
Dog cradle method	A method that uses the first Z-phase after the proximity dog front end as the home position.
Limit switch combined method	A method that uses the Z-phase prior to the limit switch of the opposite direction to the home position return direction as the home position.
Limit switch front end method	A method that uses the limit switch front end of the opposite direction to the home position return direction as the home position. No proximity dog or Z-phase is necessary.
Dog front end method	A method that uses the proximity dog front end as the home position. No Z-phase is necessary.
Z-phase detection method	A method that uses the nearest Z-phase as the home position. No proximity dog is necessary.
Scale home position signal detection method	A method that uses the linear scale home position signal as the home position.
Scale home position signal detection method 2	A method that uses the nearest linear scale home position signal as the home position for home return direction. No proximity dog is necessary.

5. OPERATIONAL FUNCTIONS

POINT	
	<ul style="list-style-type: none">▪ When using the following home position return methods, set proximity dog signal and limit switch signal so that the Z-phase can be passed during home position return.<ul style="list-style-type: none">▪ Dog method▪ Dog cradle method▪ Limit switch combined method▪ When performing Z-phase detection method home position return, the Z-phase is required to be passed through with the JOG operation etc. When the Z-phase is not passed, not passing Z-phase (operation alarm 91, detail 01) occurs. However, when "1: Not need to pass motor Z phase after the power supply is switched on" is selected in the home position setting condition selection of parameter No.1190 (servo parameter PC17 function selection C-4), the home position return can be executed even when the Z-phase is not passed, and the restriction above is removed.▪ Set 1 (valid) in No home position of the control option 1 (parameter No.0200) when setting the position at the time of power on as the home position. Once a home position return is performed, a position determined by the home position return is set to the home position.▪ In the home position return, smoothing filter is invalid.▪ In the Z-phase detection method, shortcut direction can be selected for home position return direction (parameter No.0240). When shortcut direction is selected in other home position return methods than Z-phase detection method, home position return parameter setting error (operation alarm 9D, detail 03) occurs when the operation starts.

5. OPERATIONAL FUNCTIONS

5.5.2 Home position return method

Home position return method is set with the home position return option 1 (parameter No.0240).

(1) Software version A4 or before

Set the home position return method with home position return method (parameter No.0240). The value at system startup is effective. Therefore, the system needs to be restarted if the parameters are changed.

(2) Software version A5 or later

The home position return method (parameter No.0240) can be changed while system is running.

POINT
<ul style="list-style-type: none">• When home position return method is changed during home position return, the new home position return method becomes valid at the startup of the next home position return.• Home position return direction and proximity dog input polarity cannot be changed while system is running.• When Z-phase detection is set to home position return method and shortcut direction is set for home position return direction, the home position return method cannot be changed while system is running. If the home position return is changed, a home position return parameter setting error (operation alarm 9D, detail No.03) occurs at the next home position return startup.• When a home position return method that does not exist in the home position return setting range is selected, a home position return parameter setting error (operation alarm 9D, detail No.04) occurs at the home position return startup.

5. OPERATIONAL FUNCTIONS

5.5.3 Start operation method

Start operation is performed according to the following procedure.

- (1) Set parameters "home position return to speed" (parameter No.0242, 0243), "home position return acceleration time constant" (parameter No.0244), "home position return deceleration time constant" (parameter No.0245), "home position coordinates" (parameter No.0246, 0247), "creep speed" (parameter No.024C), and "home position return direction" (parameter No.0240).
- (2) Turn on the "home position return mode signal" (ZRN).
- (3) Turn on the "fast start operation signal" (FST).
- (4) When the home position return is completed, the home position return request (ZREQ) turns off and the home position return complete signal (ZP) turns on.

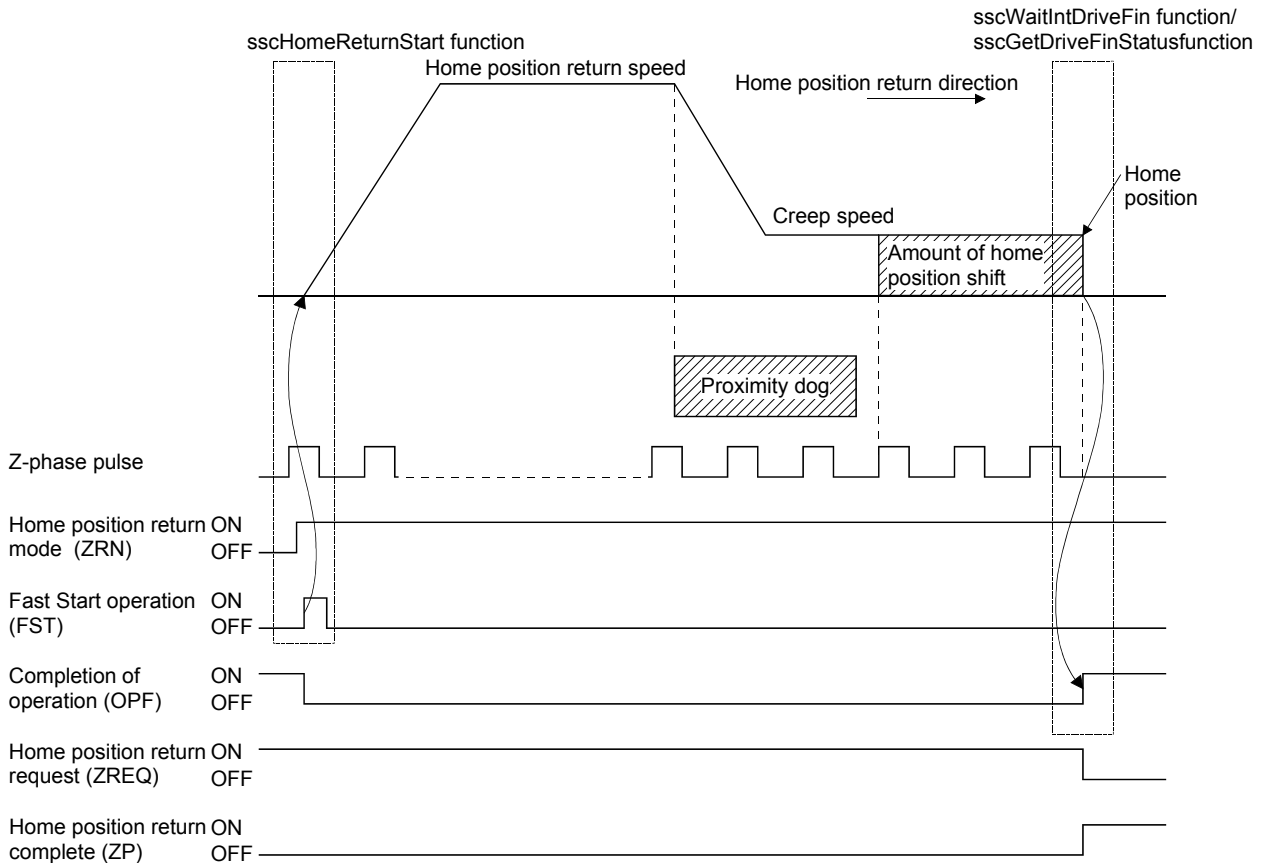

5. OPERATIONAL FUNCTIONS

POINT

- Set the "amount of home position shift" (parameter No.0248, 0249) and "home position search limit" (parameter No.024A, 024B) if required.
- When a home position return is complete, the home position return complete signal (ZP) turns on. The home position return complete signal (ZP) turns off at the next start operation or at an operation mode change.
- The home position return request (ZREQ) turns on when a home position return starts.

API LIBRARY

- Use the sscHomeReturnStart function to perform procedures (2) to (3) above.
- Use the sscGetDriveFinStatus or sscWaitIntDriveFin functions to check completion of operation.
- Use the sscDriveStop or sscDriveStopNoWait functions to perform stop operation.
- For a detailed procedure from startup of home position return to check completion of operation, refer to the sample programs (InterruptDrive/PollingDrive) contained on the utility software.

5. OPERATIONAL FUNCTIONS

5.5.4 Home position return using a dog method

The deceleration is started at the front end of the dog, and the first Z-phase after passing the rear end of the dog is defined as the home position.

(1) When there is a proximity dog in the direction of home position return

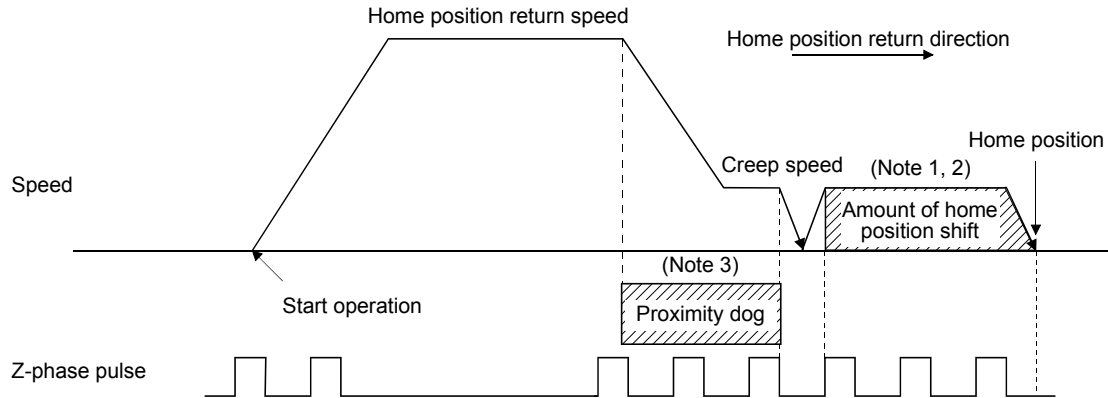

- Note 1. The amount of home position offset is set to the amount of shift in the home position (parameter No.0248, 0249).
 Note 2. If the amount of shift in the home position is zero, the servo stops above the Z-phase.
 Note 3. The polarity of the proximity dog input signal can be changed using home position return option 1 (parameter No.0240). (The above figure shows the case of the normally closed contact.)

(2) When the dog is on at start operation

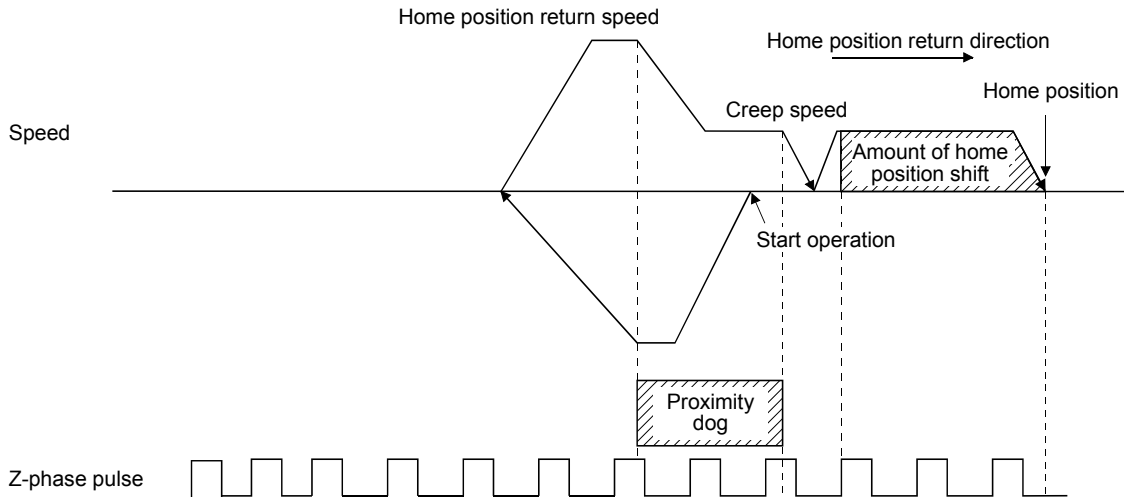

5. OPERATIONAL FUNCTIONS

(3) When the proximity dog is in the opposite direction against the direction of home position return

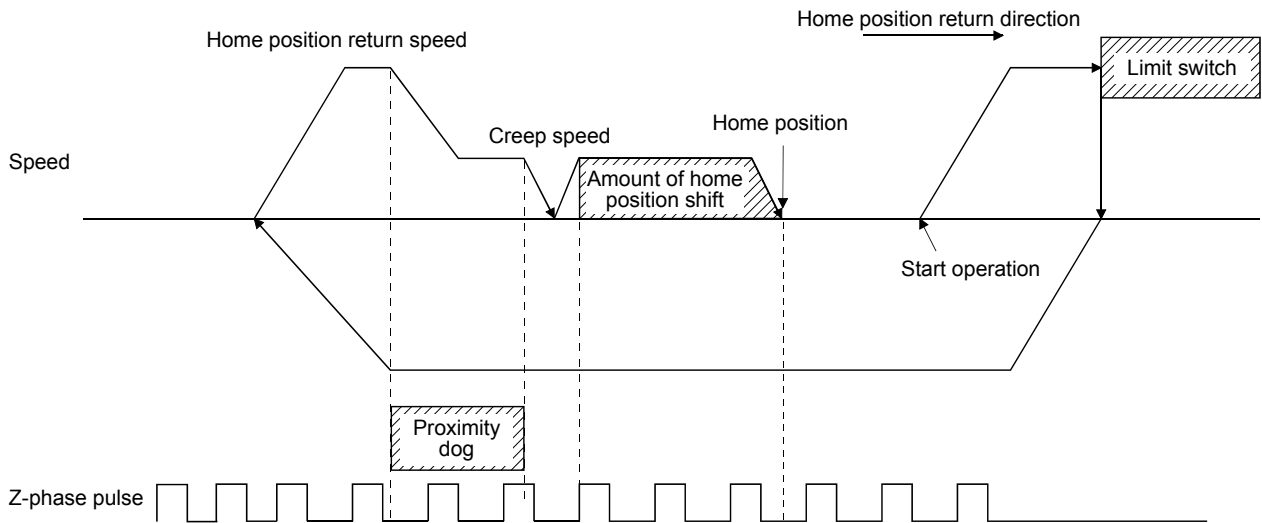

(4) If a limit switch is detected at the start operation position

If a limit switch in the direction of home position return is detected, the home position return should be executed by the (3) pattern. Also, if the limit switch is in the opposite direction against the direction of home position return, the home position return should be executed by the (1) pattern.

(5) When the start operation position is on a dog and when moving in the opposite direction the Z-phase was not traveled through until the dog is turned off

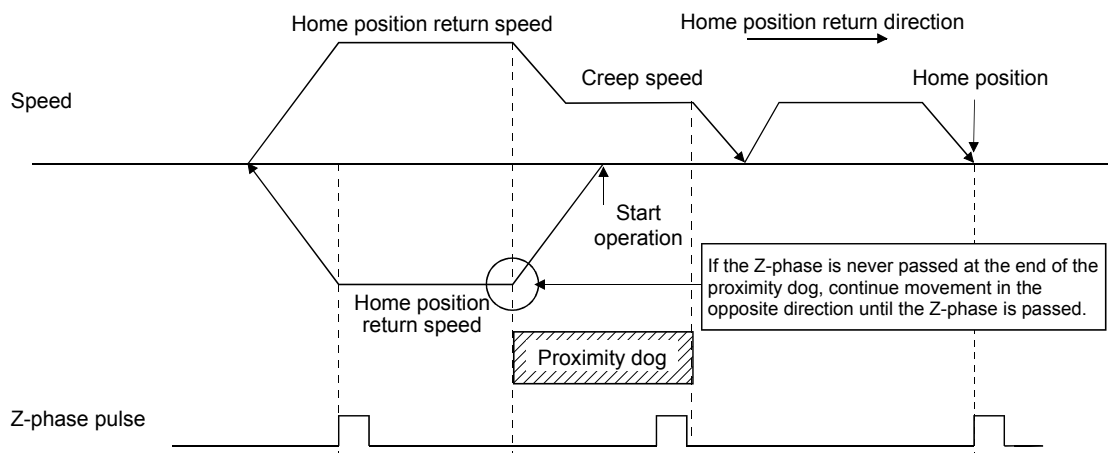

5. OPERATIONAL FUNCTIONS

5.5.5 Home position return using a data set method

The command position at the start operation of the home position return is defined as the home position. It is necessary to move to home position using JOG operation or something similar in advance.

(1) When the home position is the current command position

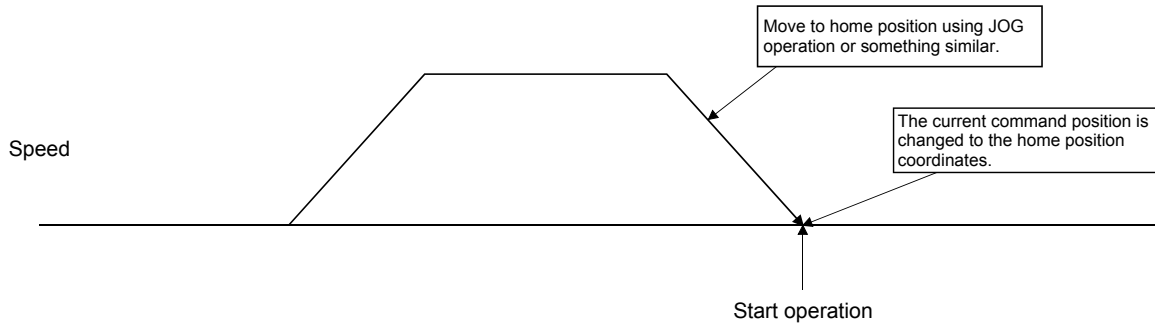

Note. If limit switch signal is turned off when operation is started, a limit switch (operation alarm A0, detail 01) occurs and home position return cannot be executed.

5.5.6 Home position return using a stopper method

When start operation is performed for home position return using stopper method, droop pulse is cleared and current feedback position is defined as the home position.

It is necessary to move using JOG operation or something similar in advance and to execute the collision stop from the stopper using torque limit functions. For the torque limit, refer to Section 6.12.

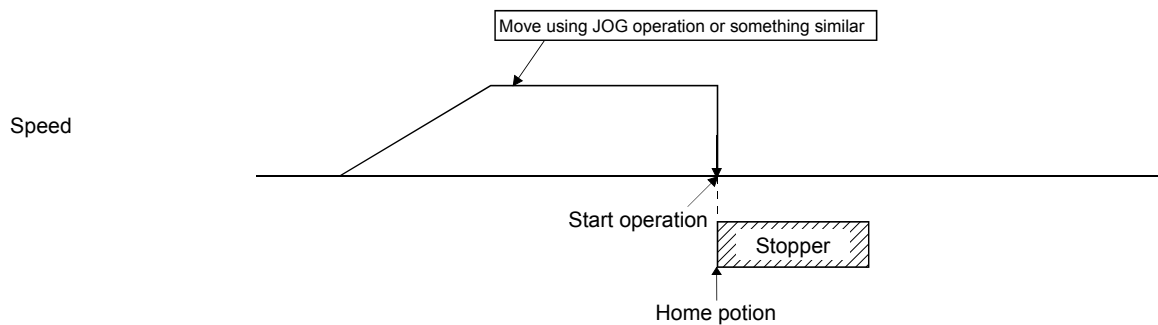

Note1. If torque limit effective signal (TLC) is turned off when operation is started, "Not limiting torque" (operation alarm 95, detail 01) occurs and home position return cannot be executed.

2. If the home position return direction and the stopper method direction are opposite, a home position return direction error (operation alarm 94, detail 01) occurs and the home position return cannot be executed.

5. OPERATIONAL FUNCTIONS

5.5.7 Home position return using a dog cradle method

A method where deceleration is started at the front end of the dog, then return briefly to the front end of the dog, and start moving again at a creep, and that uses the first Z-phase after the dog front end passes as the home position.

(1) When there is a proximity dog in the direction of home position return

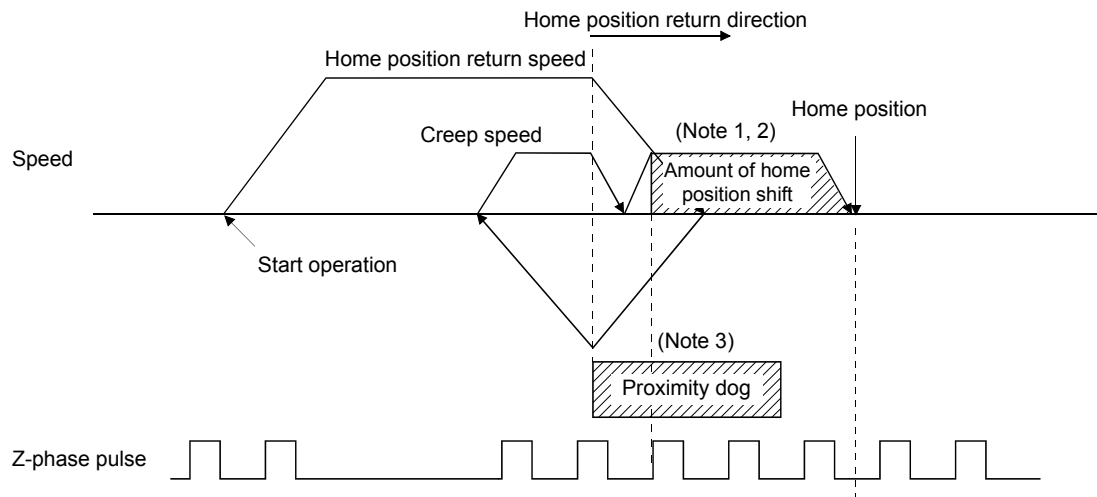

- Note 1. The amount of home position offset is set to the amount of shift in the home position (parameter No.0248, 0249).
 Note 2. If the amount of shift in the home position is zero, the servo stops above the Z-phase.
 Note 3. The polarity of the proximity dog input signal can be changed using home position return option 1 (parameter No.0240).
 (The above figure shows the case of the normally closed contact.)

(2) When the proximity dog is in the opposite direction against the direction of home position return.

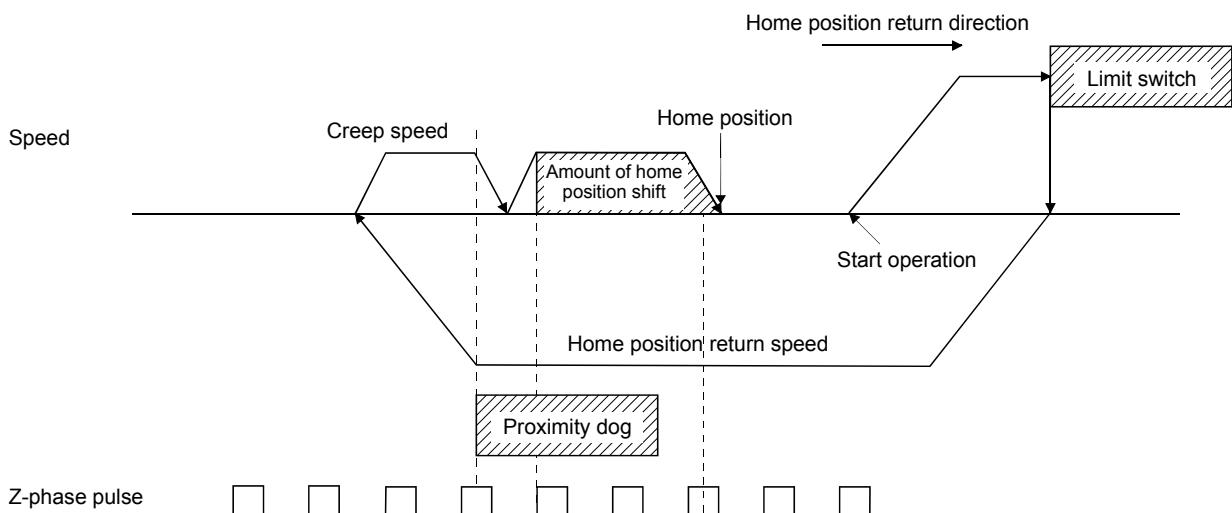

5. OPERATIONAL FUNCTIONS

(3) When the start operation position is on the dog

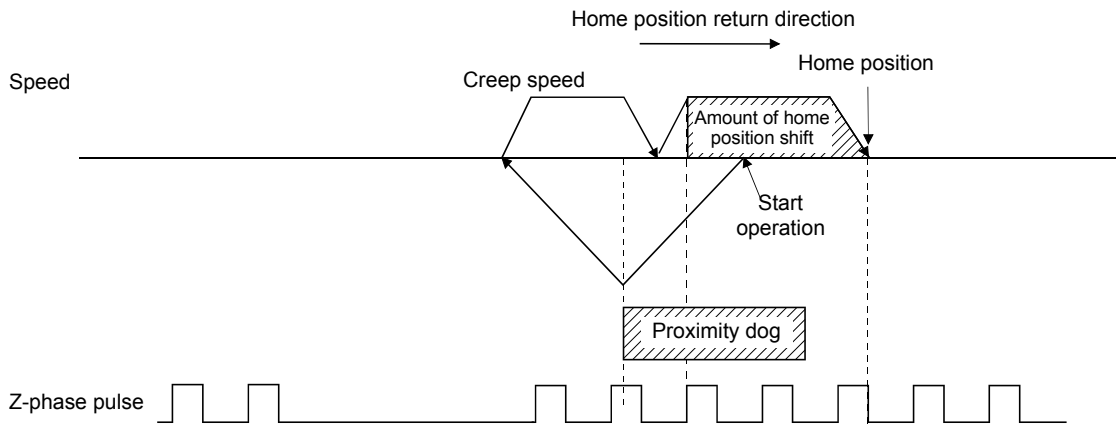

(4) If a limit switch is on at the start operation position

If the limit switch in the direction of home position return is on, the home position return should be executed by the (2) pattern. Also, if the limit switch in the opposite direction against the direction of home position return is on, the home position return should be executed by the (1) pattern.

(5) When the start operation position is on a dog and when moving in the opposite direction the Z-phase is not traveled through until the dog is turned off

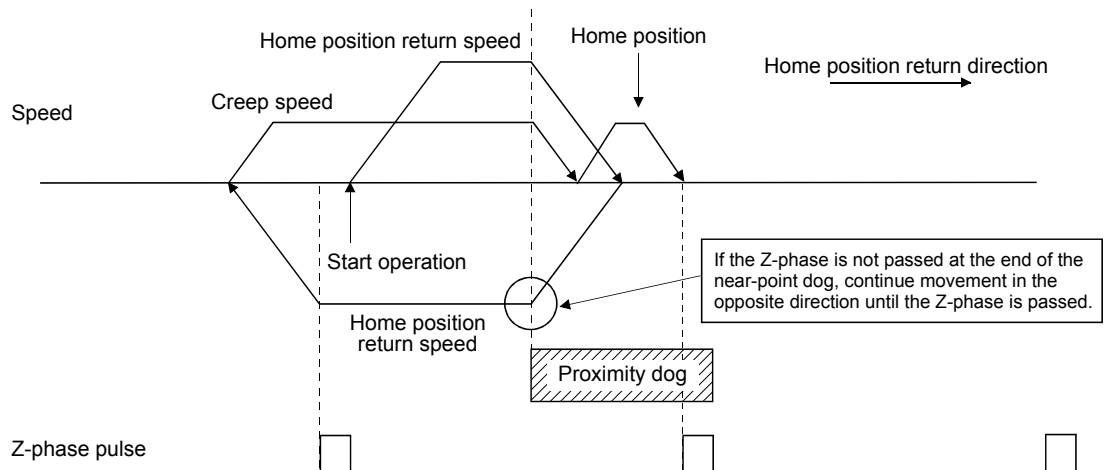

(6) When the start operation position is on a dog and when moving in the opposite direction the Z-phase is not traveled through until the dog is turned off

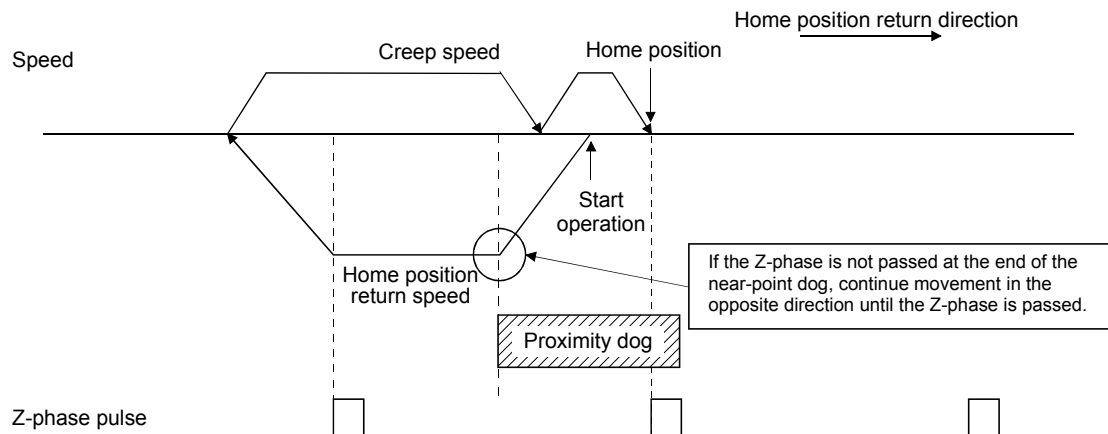

5. OPERATIONAL FUNCTIONS

5.5.8 Home position return using a limit switch combined method

The Z-phase pulse prior to the limit switch of the opposite direction to the home position return direction is defined as the home position.

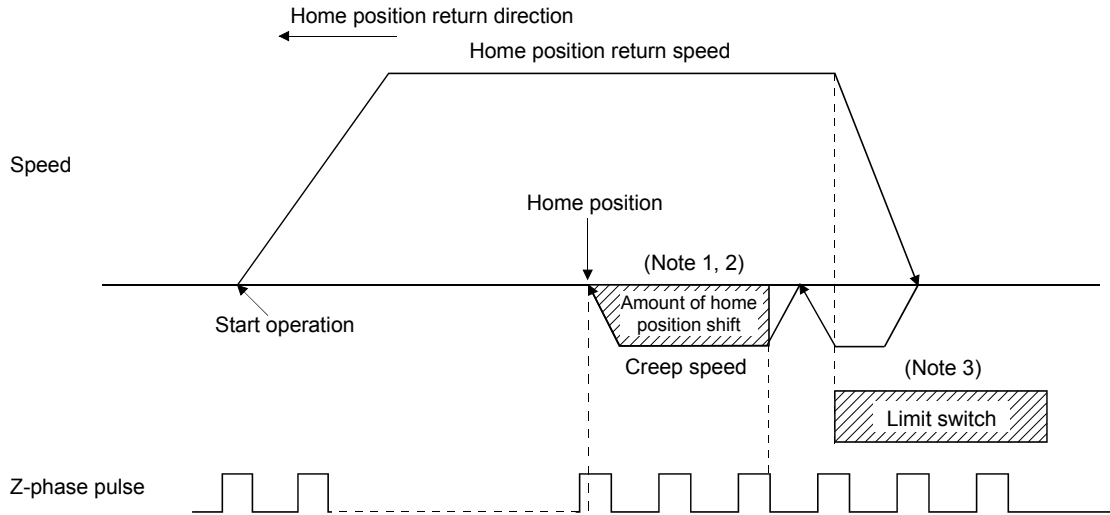

- Note 1. The amount of home position offset is set to the amount of shift in the home position (parameter No.0248, 0249).
 Note 2. If the amount of shift in the home position is zero, the servo stops above the Z-phase.
 Note 3. Polarity of the limit switch signal is only defined for normally-closed contact.

5.5.9 Home position return using a limit switch front end method

In the home position return using a limit switch front end method, the limit switch front end that is opposite to the home position direction is defined as the home position.

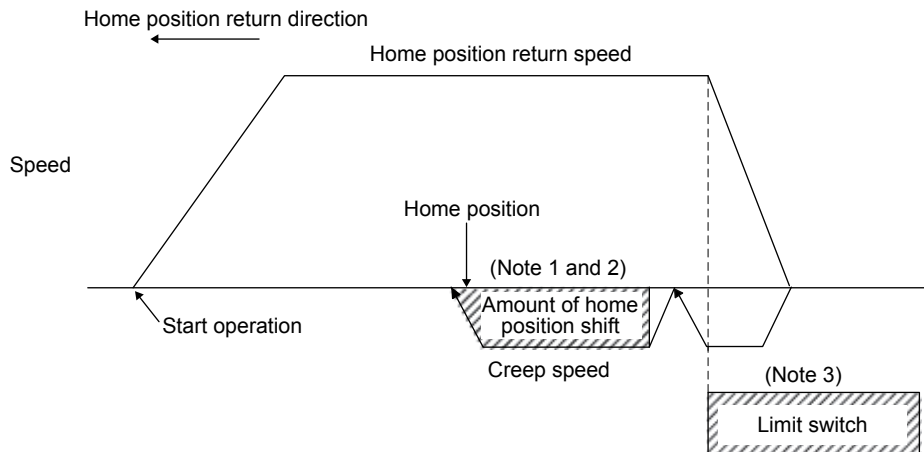

- Note 1. The amount of home position offset is set to the amount of shift in the home position (parameter No.0248, 0249).
 Note 2. If the amount of shift in the home position is zero, the servo stops at the limit switch front end.
 Note 3. Polarity of the limit switch signal is only defined for normally-closed contact.

POINT
<ul style="list-style-type: none"> A dispersion of the home position occurs depending on the detection timing of the limit switch front end. When this dispersion is a problem, the dispersion can be smaller by reducing the creep speed.

5. OPERATIONAL FUNCTIONS

5.5.10 Home position return using a dog front end method

In the home position return using a dog front end method, the motion detected by the proximity dog slows down to stop, and return to the proximity dog front end, setting there to the home position.

(1) When there is a proximity dog in the direction of home position return

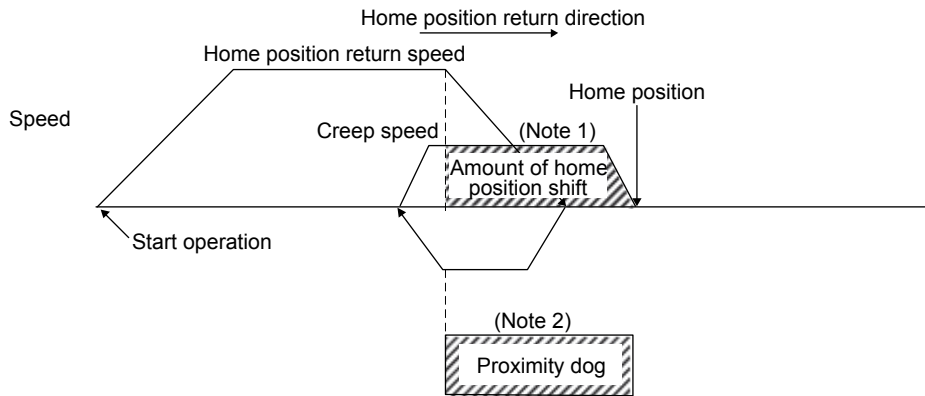

- Note 1. The amount of home position offset is set to the amount of shift in the home position (parameter No.0248, 0249).
 2. If the amount of shift in the home position is zero, the servo stops at the proximity dog front end.

POINT
<ul style="list-style-type: none"> A dispersion of the home position occurs depending on the detection timing of the dog front end. When this dispersion is a problem, the dispersion can be smaller by reducing the creep speed.

(2) When the proximity dog is in the opposite direction against the direction of home position return

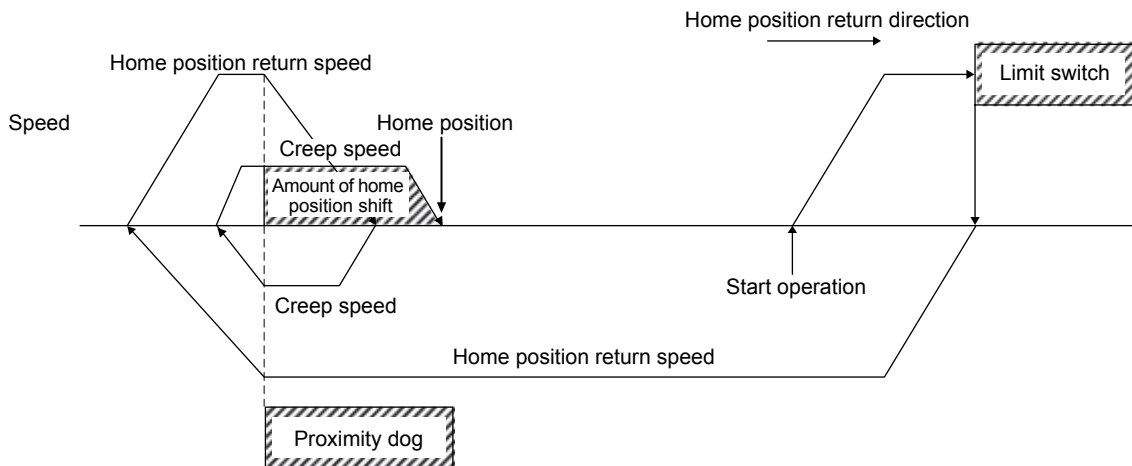

5. OPERATIONAL FUNCTIONS

(3) When the start operation position is on the proximity dog

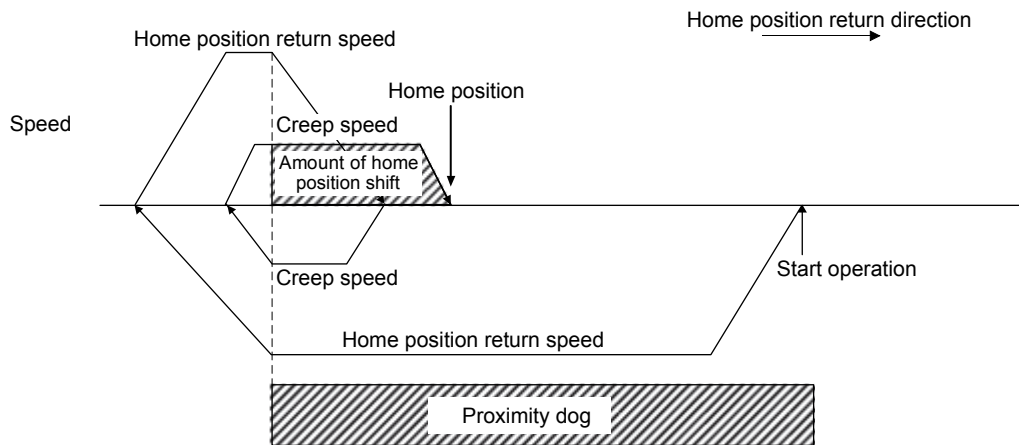

(4) If a limit switch is on at the start operation position

When the limit switch on the same side as the home position return direction is on, the home position return should be executed by the (3) pattern. Also, when the limit switch on the opposite side of the home position return direction is on, the home position return should be executed by the (1) pattern.

5. OPERATIONAL FUNCTIONS

5.5.11 Home position return using a Z-phase detection method

After moving from the position where home position return has started to the nearest Z-phase (in addition, after moving by shift amount when home position shift amount is set), home position return is completed. It is necessary to move to around home position using JOG operation or something similar in advance.

For home position return direction (parameter No.0240), in addition to - direction and + direction, shortcut direction can be selected.

For the shortcut direction, home position return operation is started in the direction where the travel distance to the Z-phase is small. At this time, code of the home position shift amount is consistent with the movement direction from the Z-phase. (Example: If home position shift amount is -100 [command unit], home position is the position moved from Z-phase by -100 [command unit].)

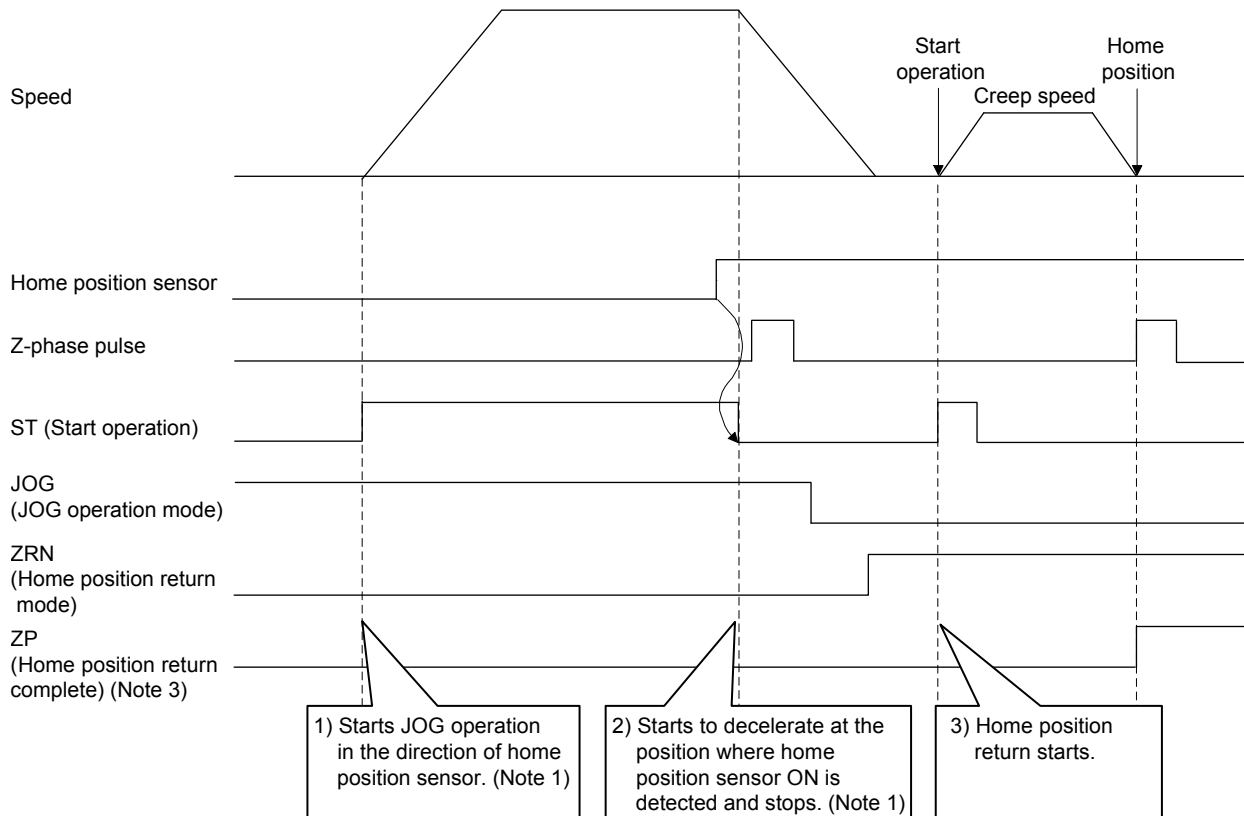

- Note 1. Home position sensor signal is an externally installed signal and monitored by a user program. Execute the movement to around home position by this signal.
2. When limit switch signal of home position return direction is turned off, limit switch (operation alarm A0, detail 01 to 02) occurs when the operation starts and home position return cannot be executed.
 3. When not passing Z-phase (ZPASS) is turned off, Z-phase not passed (operation alarm 91, detail 01) occurs when the operation starts and home position return cannot be executed. Execute home position return after passing through Z-phase by JOG operation or something similar.
 4. When setting of the home position signal re-search (parameter No.0240) is set to "Search again", home position return parameter setting error (operation alarm 9D, detail 02) occurs when the operation starts and home position return cannot be executed. Always set to "Do not search again".

5. OPERATIONAL FUNCTIONS

[Cautions]

In the sequence 2) above, stop processing by response delay to the home position sensor signal and deceleration occurs during the time until the axis stops.

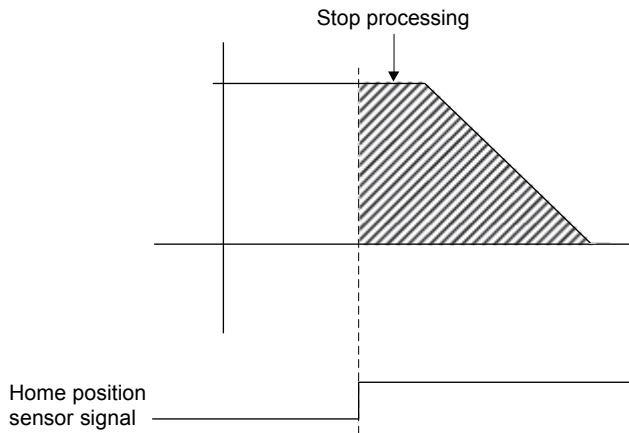

$$\text{Stop processing} = L_a + L_b + L_c + L_{dc}$$

- L_a: Travel distance associated with delay time (T_a) from sensor-on to JOG operation stop command issued = (Moving speed) × T_a (Note 1)
- L_b: Travel distance associated with delay time (T_b) of Q173SCCF = (Moving speed) × T_b (Note 2)
- L_c: Travel distance associated with delay of servo = (distance equivalent to drop pulse) (Note 3)
- L_{dc}: Distance which deceleration takes = (Moving speed) × (Deceleration time) ÷ 2

Note 1. Depending on the specification of user program side

2. T_b ≈ Control cycle × 2
3. (Drop pulse) ≈ (N × Pt) ÷ (60 × PG1)
N: Motor speed (r/min)
Pt: Number of pulses per revolution
PG1: Position loop gain 1
4. The unit of drop pulse calculated here is equivalent to the motor end encoder resolution.

This stop processing changes depending on dispersion of the response delay of the sensor signal. Therefore, reference encoder Z-phase of sequence 3) above may change by one revolution of the motor when stop position is near the encoder Z-phase by the relationship between home sensor position signal and encoder Z-phase.

1) When stop position is before the encoder Z-phase

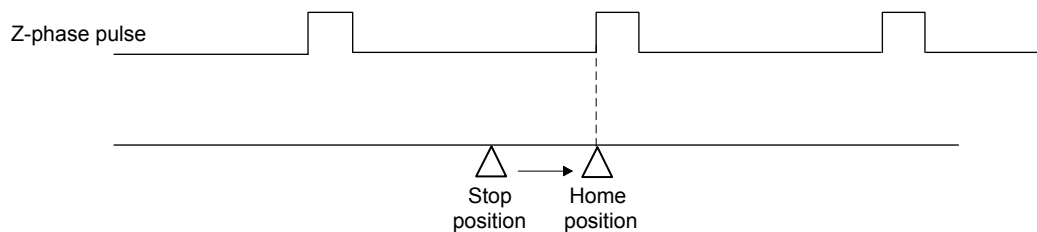

2) When stop position is after the encoder Z-phase

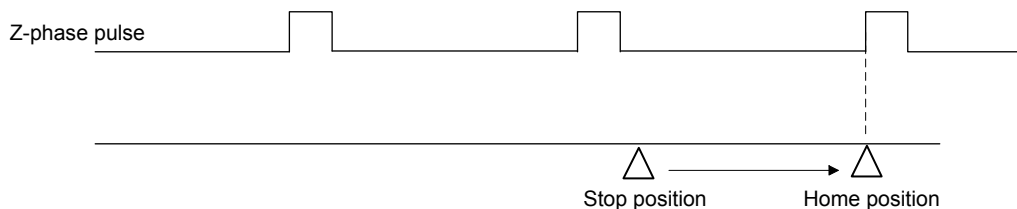

To avoid this event, adjust position relationship between home position sensor signal and encoder Z-phase, adjust the command speed of JOG operation or set correct value to Z-phase mask amount (parameter No.0250, 0251).

5. OPERATIONAL FUNCTIONS

[Encoder Z-phase mask amount]

When the stop position is near the encoder Z-phase by the dispersion, the Z-phase position to be the home position can be fixed by setting encoder Z-phase mask amount.

1) When stop position is before the encoder Z-phase

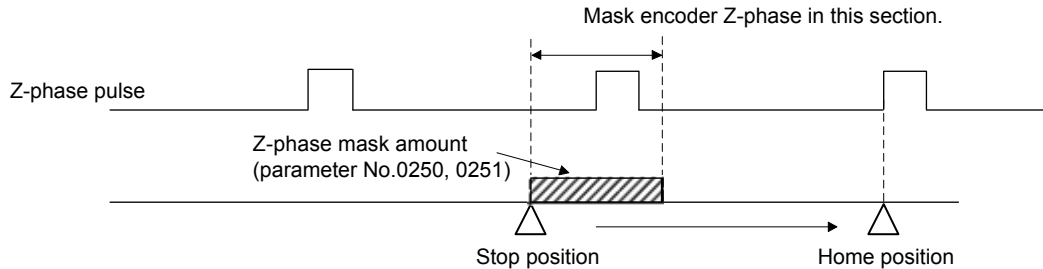

2) When stop position is after the encoder Z-phase

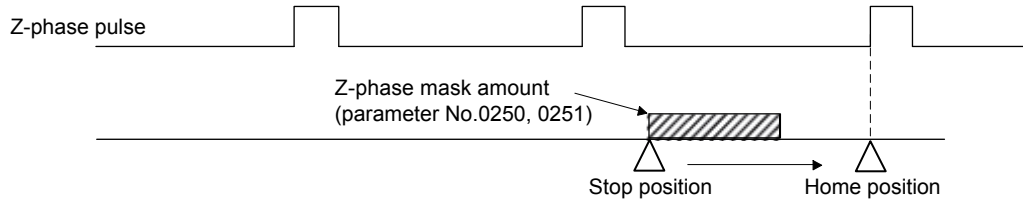

- Note1. When the stop position disperses largely, the home position may change by one revolution of the motor even when encoder Z-phase mask amount is set. In this case, adjust command speed to reduce the dispersion.
2. When the following conditions are satisfied in the calculation of Z-phase mask amount, Z-phase mask amount setting error (operation alarm 9C, detail 01) occurs when the operation starts and home position return cannot be executed. Reexamine the setting value of the Z-phase mask amount.
- (a) The value calculated by $Z\text{-phase mask amount} \times \text{electronic gear numerator (CMX)} \div \text{electronic gear denominator (CDV)}$ exceeds 32 bits.
 - (b) The value calculated by the $Z\text{-phase mask amount} + \text{the travel distance to the Z-phase}$ exceeds 32 bits.

5. OPERATIONAL FUNCTIONS

5.5.12 Home position return using a scale home position signal detection method

Home position return is performed using a home position signal (Z-phase) on a linear scale. After detecting the proximity dog, move in the opposite direction of the home position and the position where a home position signal is detected is defined to be the home position. When multiple home position signals on the linear scale, the nearest home position signal to the proximity dog is defined as the home position.

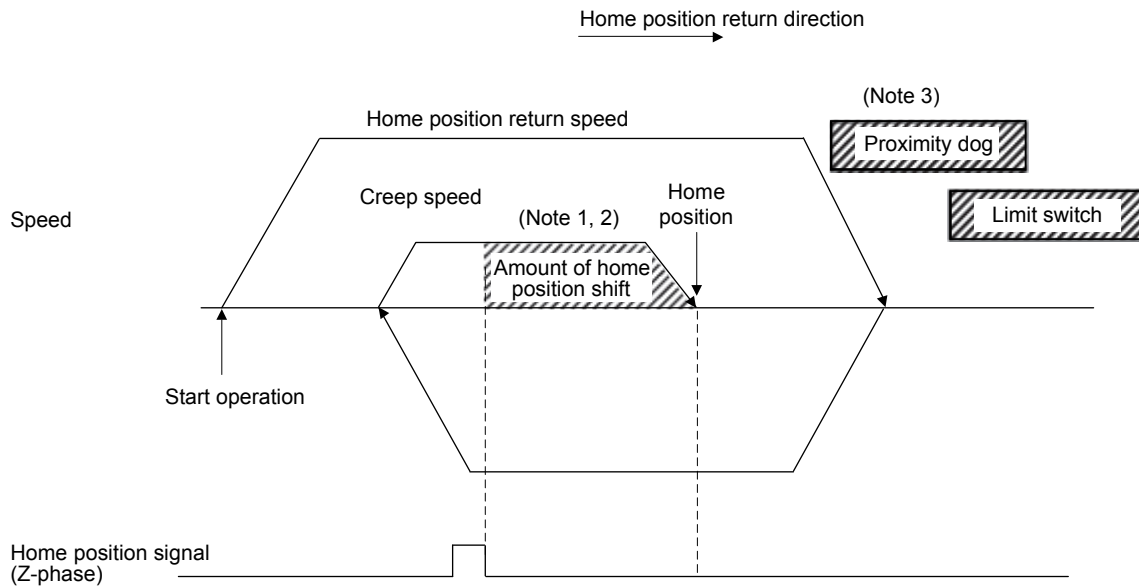

- Note 1. The amount of home position offset is set to the amount of shift in the home position (parameter No.0248, 0249).
 2. If the amount of shift in the home position is 0, the servo stops on the Z-phase.
 3. When a limit switch signal is detected, an alarm occurs and execution of return to home position is terminated.
 Set the proximity dog signal before the limit switch signal.
 Set the proximity dog signal to overlap with the limit switch signal as shown above.

5. OPERATIONAL FUNCTIONS

5.5.13 Home position return using a scale home position signal detection method 2

Home position return is performed using a home position signal (Z-phase) on a linear scale. Move in the opposite direction of the home position and the position where a home position signal is detected is defined to be the home position. When multiple home position signals in the linear scale, the nearest home position signal in the opposite direction of home position return direction is defined as the home position.

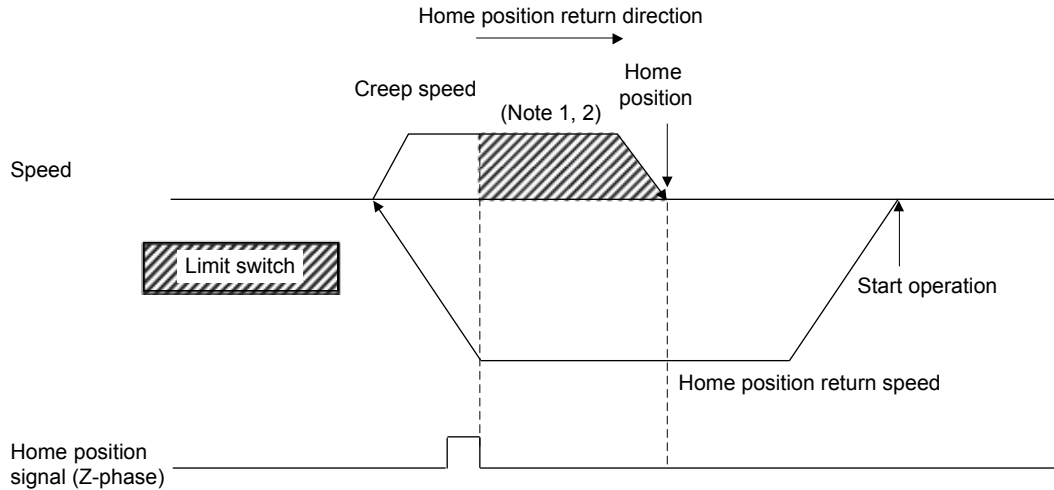

- Note 1. The amount of home position offset is set to the amount of shift in the home position (parameter No.0248, 0249).
- Note 2. If the amount of shift in the home position is 0, the servo stops on the Z-phase.
- Note 3. When a limit switch signal is detected, an alarm occurs and execution of return to home position is terminated. Set the home position signal before the limit switch signal.
- Note 4. Start position is needed to be adjusted with a user program so that the Z-phase is passed.
- Note 5. When there are multiple Z-phase, start position is needed to be adjusted with a user program so that the reference Z-phase is passed first.
- Note 6. Z-phase mask function cannot be used.
- Note 7. The servo returns to Z-phase after detecting the Z-phase, movement direction is reversed, which is different from home position return using a Z-phase detection method.

5. OPERATIONAL FUNCTIONS

5.6 Home position reset function (data set function)

The home position reset function (data set function) is a function that resets the current position to the home position. Prior to executing the home position reset function, set the home position coordinates (parameter No.0246, 0247). The movement is the same as the data set method return to home position, where the current position is changed to the home position coordinates (parameter No.0246, 0247). This function can be used independent of the method for returning to home position. If absolute position detection system is used, whether or not data for absolute position detection system (home position multiple revolution data (parameter No.024D), home position within 1 revolution position (parameter No.024E, 024F)) are changed can be selected using return to home position option 2 (parameter No.0241).

The home position reset function is valid after home position return complete. If the home position reset function is used prior to home position return finish (home position return request (ZREQ) is ON), a home position return not complete error (operation alarm 90, detail 01) occurs.

Start operation is performed according to the following procedure.

- (1) Move to an arbitrary position using JOG operation or something similar.
- (2) Set home position coordinates for resetting.
- (3) Turn on the home position reset mode (DST).
- (4) Turn on the start fast operation signal (FST).

API LIBRARY

- | |
|---|
| <ul style="list-style-type: none">▪ Use the sscDataSetStart function to perform procedures (3) to (4) above.▪ Use the sscGetDriveFinStatus or sscWaitIntDriveFin functions to check completion of operation. |
|---|

5. OPERATIONAL FUNCTIONS

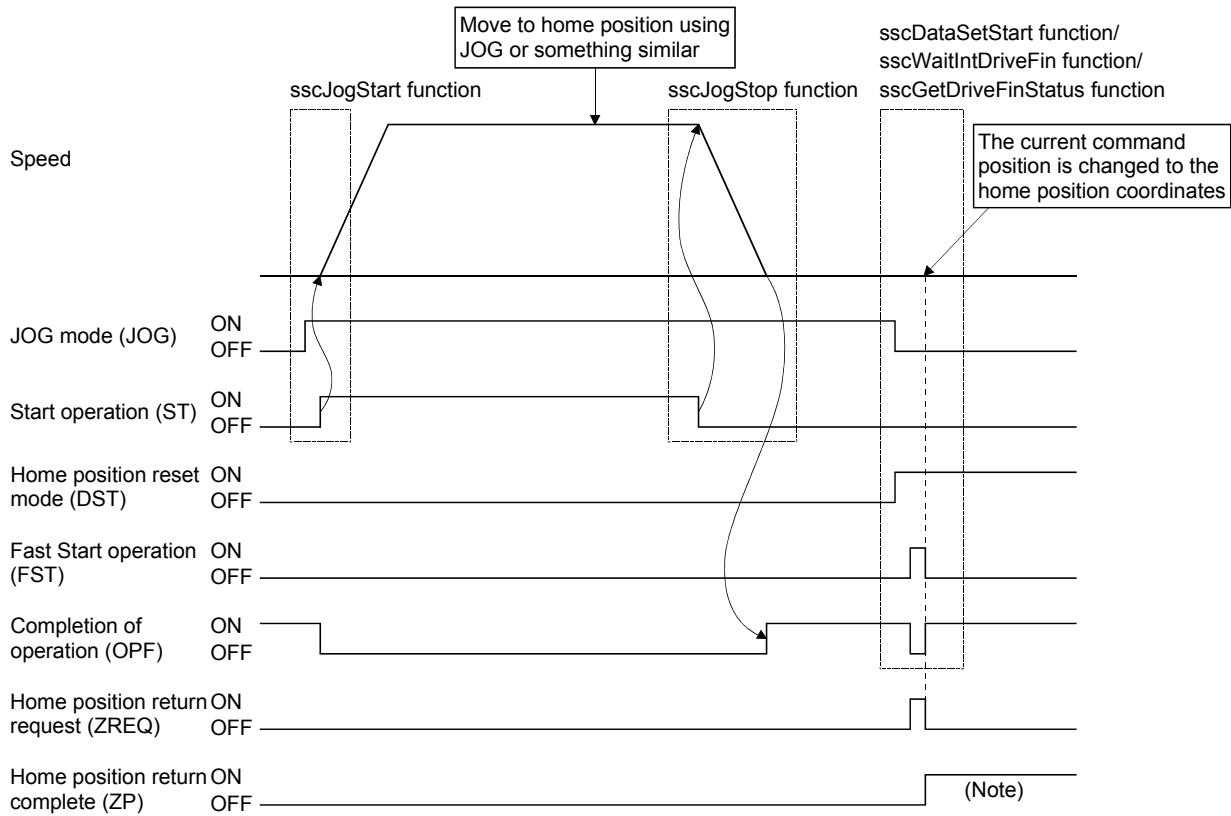

Note. The home position return complete signal (ZP) is turned off when next start of operation for the following is performed.

6. APPLICATION FUNCTIONS

6. APPLICATION FUNCTIONS

6.1 Command units

6.1.1 Position command unit - electronic gear

Set position command (such as position data of point table and the incremental movement amount) by position command unit. Electronic gears (parameter No.020A, 020B, 020C, 020D) are used to adjust position command unit. Through making changes to the electronic gears, it is possible to move the equipment using an arbitrary multiplication constant for the movement amount.

$$\text{Electronic gear} = \frac{\text{Electronic gear numerator (CMX)}}{\text{Electronic gear denominator (CDV)}}$$

The number of encoder pulses per revolution is 4194304 or less (normal servo motor, linear servo motor etc.).

Item		Setting range	Number of encoder pulses per revolution [pulse] (Note 1)	Maximum speed [r/min] (Note 2,3)
Electronic gear	CMX	1≤CMX≤5242879 (When the speed unit is position command unit/s or position command unit/min)	To 67108864 (The resolution of up to 26 bit is supported.)	Limits the speed to 2160000 × (262144/number of encoder pulses per revolution) × (CMX/CDV) or less, and to 4893355 × (262144/number of encoder pulses per revolution) or less
		1≤CMX≤477218 (When the speed unit is r/min)		
	CDV	1≤CDV≤589823		
	CMX/CDV	1/16≤CMX/CDV≤100000		

Note 1. When a linear servo motor is used, this becomes the value which is set in "Stop interval setting for home position return" of the linear/direct drive motor function selection 1 (parameter No.1300).

2. When the command speed output to the servo amplifier from the Q173SCCF exceeds the motor maximum revolution speed, the speed is limited to the motor maximum revolution speed (monitor No.0114).

3. When a linear servo motor is used, this is converted into maximum speed [r/min] by the following formula.

$$\text{Maximum speed [r/min]} = \frac{\text{Motor maximum speed[m/s]} \times 1000 \times 1000 \times 60}{\text{Linear encoder resolution}[\mu\text{m/pulse}] \times \text{Stop interval setting for home position return[pulse]}}$$

However,

$$\text{Linear encoder resolution} [\mu\text{m/pulse}] = \frac{\text{Linear encoder resolution setting Numerator (Parameter No.1301)}}{\text{Linear encoder resolution setting Denominator (Parameter No.1302)}}$$

API LIBRARY

- Use the sscChange2Parameter/sscCheck2Parameter functions to set/get electronic gear.

6. APPLICATION FUNCTIONS

Example: Relationship between setting range of electronic gear and corresponding maximum revolution speed

Number of encoder pulses per revolution [pulse]	Electronic gear (CMX/CDV)	Maximum speed (limited) [r/min]
262144	1/16	135000
	1/1	2160000
	10/1	4893355
	10000/1	4893355
1048576	1/16	33750
	1/1	540000
	10/1	1223338
	10000/1	1223338
4194304	1/16	8437
	1/1	135000
	10/1	305834
	10000/1	305834
16777216	1/16	2109
	1/1	33750
	10/1	76458
	10000/1	76458
67108864	1/16	527
	1/1	8437
	10/1	19114
	10000/1	19114

Note. The smaller the setting value of the electronic gear (CMX/CDV) is, the more the maximum revolution speed is limited. If the maximum revolution speed is limited and the enough speed cannot be output, reexamine the command unit of the user program and make sure the setting value of the electronic gear (CMX/CDV) becomes larger. (The command unit becomes rough.)

6. APPLICATION FUNCTIONS

6.1.2 Settings

Control parameters

Parameter No.	(Note) Abbreviation	Name	Initial Value	Unit	Setting range	Function
020A	*CMXL	Electronic gear numerator (lower)	0001h		1 to 5242879 (32 bits)	Set the numerator for electronic gears.
020B	*CMXH	Electronic gear numerator (upper)	0000h			
020C	*CDVL	Electronic gear denominator (lower)	0001h		1 to 589823 (32 bits)	Set the denominator of the electronic gear.
020D	*CDVH	Electronic gear denominator (upper)	0000h			

Note. The settings for the parameters with a * mark at the front of the abbreviation are validated when the system is started.

6.1.3 Setting example of electronic gears

The following is a setup example for use of μm as a command unit for a piece of equipment that uses ball screws.

(1) Equipment specification

Item	Symbol	Value	Unit	Remarks
Ball screw lead	Pb	10	mm	=10000 μm
Deceleration ratio	n	1/2		
Number of encoder pulses per revolution	Pt	4194304	pulse/rev	

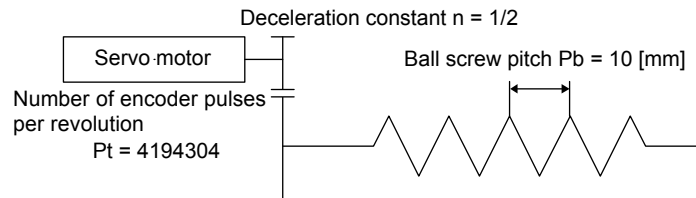

(2) Calculation of electronic gears

$$\frac{CMX}{CDV} = \frac{Pt}{\Delta S} = \frac{Pt}{n \cdot Pb} = \frac{4194304}{1/2 \cdot 10000} = \frac{4194304}{5000} = \frac{400000h}{1388h}$$

Note. ΔS is the movement amount for 1 revolution of the servo motor.

(3) Parameter settings

Because the value obtained by calculating the electronic gear is within the setting range, the value can be set without reducing.

Parameter No.	(Note) Abbreviation	Name	Setting value
020A	*CMXL	Electronic gear numerator (lower)	0000h
020B	*CMXH	Electronic gear numerator (upper)	0040h
020C	*CDVL	Electronic gear denominator (lower)	1388h
020D	*CDVH	Electronic gear denominator (upper)	0000h

Note. The settings for the parameters with a * mark at the front of the abbreviation are validated when the system is started.

6. APPLICATION FUNCTIONS

6.1.4 Restrictions

The restrictions on electronic gears are shown below.

- (1) When the setting of an electronic gear (CMX, CDV, CMX/CDV) is incorrect, an electronic gear setting error (system error E500) occurs at system startup and the electronic gear setting is treated as CMX: CDV = 1: 1. The operation cannot be performed since the electronic gear is in forced stop status at this time. Reexamine the setting of an electronic gear and start the system again.
- (2) When an electronic gear setting error occurs while using the absolute position detection system, the absolute position erased signal (ABSE) and the home position return request (ZREQ) turn on. For the absolute position detection system, refer to Absolute position detection system (Section 6.21).
- (3) When an electronic gear setting error occurs, the axis with wrong electronic gear set can be confirmed with "electronic gear setting error axis information" (monitor No.0488 to 0489).

6. APPLICATION FUNCTIONS

6.2 Speed unit

The speed command (feed speed of point table, manual feed speed, etc) is set by the speed unit. Speed units are adjusted using the speed units and the speed units multiplication factor (parameter No.020E, 020F) of the control option 1 (parameter No.0200). Through changing the speed units, movement can be performed at an arbitrary unit and multiplication of speed.

API LIBRARY

- Use the sscChange2Parameter/sscCheck2Parameter functions to set/get speed unit.

6.2.1 Settings

Control parameters

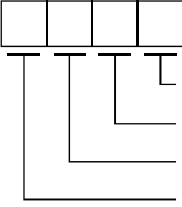
Parameter No.	(Note) Abbreviation	Name	Initial Value	Unit	Setting range	Function
0200	*OPC1	Control option 1	0001h		0000h to 2111h	 <p>Control axis Amplifier-less axis function No home position Speed unit Set the speed command unit. 0: Position command unit/min 1: Position command unit/s 2: r/min</p>
020E	SUML	Speed units multiplication factor (lower)	2000h		1 to 32768 (32 bit)	Set the speed command multiplication.
020F	SUMH	Speed units multiplication factor (upper)	0000h			

Note. The settings for the parameters with a * mark at the front of the abbreviation are validated when the system is started.

6. APPLICATION FUNCTIONS

6.2.2 Setting example of speed units

The following is a setup example for use of mm/min as a speed unit for a piece of equipment that uses ball screws.

(1) Equipment specification

The equipment specification is same as that of Section 6.1.

(2) Parameter setting for the speed unit

As the position command unit is μm , set 1000 to the speed units multiplication factor to use mm/min as a speed unit.

$$1000\mu\text{m}/\text{min} = 1\text{mm}/\text{min}$$

Parameter No.	(Note) Abbreviation	Name	Setting value
0200	*OPC1	Control option 1	0 ■■■ h
020E	SUML	Speed units multiplication factor (lower)	03E8h
020F	SUMH	Speed units multiplication factor (upper)	0000h

Note. The settings for the parameters with a * mark at the front of the abbreviation are validated when the system is started.

6.2.3 Speed limit

The following restrictions apply to the command speed. Reexamine the command speed according to the following.

- (1) When the speed command exceeds the speed limit (parameter No.0222, 0223), the speed is limited to the speed limit.

Control parameters

Parameter No.	Abbreviation	Name	Initial Value	Unit	Setting range	Function
0222	SPLL	Speed limit value (lower)	0BB8h	Speed units	0000h to FFFFh	Set the value for the moving speed limit.
0223	SPLH	Speed limit value (upper)	0000h		0000h to 7FFFh	

- (2) When the command speed output to the servo amplifier exceeds the motor maximum revolution speed, the speed is limited to the motor maximum revolution speed. The motor maximum revolution speed can be checked in the motor maximum revolution speed (monitor No.0114) and the motor permissible pulse rate (monitor No.0120, 0121).
- (3) The Q173SCCF calculates the command speed of the servo amplifiers using the speed setting, speed units multiplication factor and electronic gears; however, if an overflow occurs in the calculation process due to high command speed etc., the speed is limited to the calculable maximum value. The calculable maximum value is checked in the maximum output pulse rate (monitor No.0122, 0123) of the servo information.

6. APPLICATION FUNCTIONS

6.3 Acceleration/deceleration

The method of acceleration/deceleration can be set by Speed options (parameter No.0220).

POINT	<ul style="list-style-type: none">▪ The setting at starting operation is valid for the method of acceleration/deceleration. If the method of acceleration/deceleration is changed during operation, the change is not made. It is validated (changed) the next time operation is started.
-------	---

API LIBRARY	<ul style="list-style-type: none">▪ Use the sscChange2Parameter/sscCheck2Parameter functions to set/get speed unit.
-------------	---

6.3.1 Linear acceleration/deceleration

Linear acceleration/deceleration is as shown in the following drawing. The acceleration time constant and deceleration time constant are set the time through where the speed limit value (parameter No.0222, 0223) is reached.

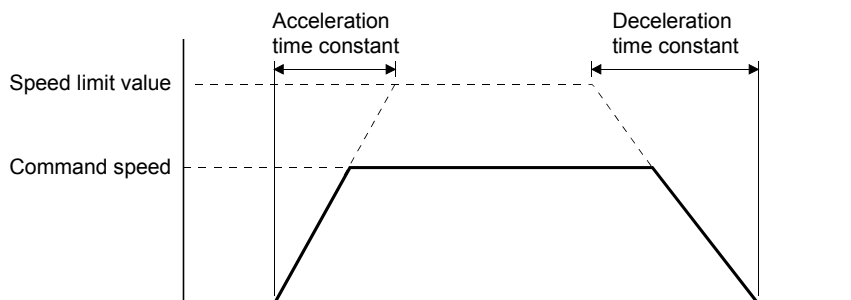

6. APPLICATION FUNCTIONS

6.3.2 Smoothing filter

Setting smoothing filter makes smooth acceleration/deceleration. The smoothing time constants are set using parameter No.0226. The acceleration time and deceleration time make the profile be longer.

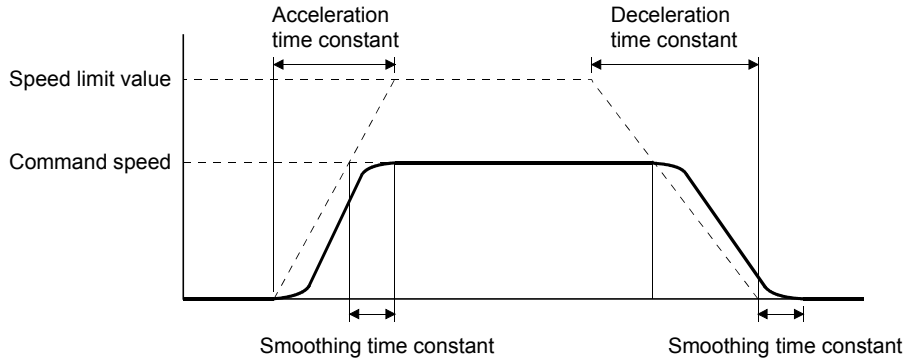

POINT

- The setting at starting operation is valid for the smoothing time constants. If the smoothing time constants are changed during operation, the change is not made. It is validated (changed) the next time operation is started.

6.3.3 Start up speed validity

Through setting start up speed validity, the start speed is stepped up to start up speed, it steps to stop from start up speed. The start up speed is set using parameter No.0224, 0225. However, a shock may be transmitted to the mechanical system during acceleration or deceleration.

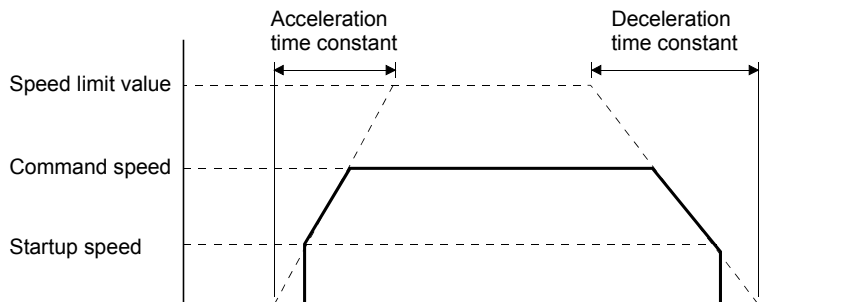

POINT

- Cannot be used together with smoothing filter.

6. APPLICATION FUNCTIONS

6.3.4 S-curve acceleration/deceleration (Sine acceleration/deceleration)

This is a method where acceleration/deceleration is performed gradually based on the Sin-curve. To make the S-curve acceleration/deceleration valid, set the S-curve ratio (1 to 100%). At this time, the acceleration time and deceleration time is the same as in the case of the linear acceleration/deceleration.

POINT

- When using the S-curve acceleration/deceleration for JOG operation, incremental feed operation and home position return, set the S-curve ratio in S-curve ratio (parameter No.0221). For automatic operation and linear interpolation operation, set the S-curve ratio in the point table.

API LIBRARY

- When using the S-curve acceleration/deceleration for JOG operation, incremental feed operation and home position return, use the sscChange2Parameter/sscCheck2Parameter functions to set the S-curve ratio (Parameter No.0221).
- When using the S-curve acceleration/deceleration for automatic operation and linear interpolation operation, set the S-curve ratio in the point table using the sscSetPointDataEx function.

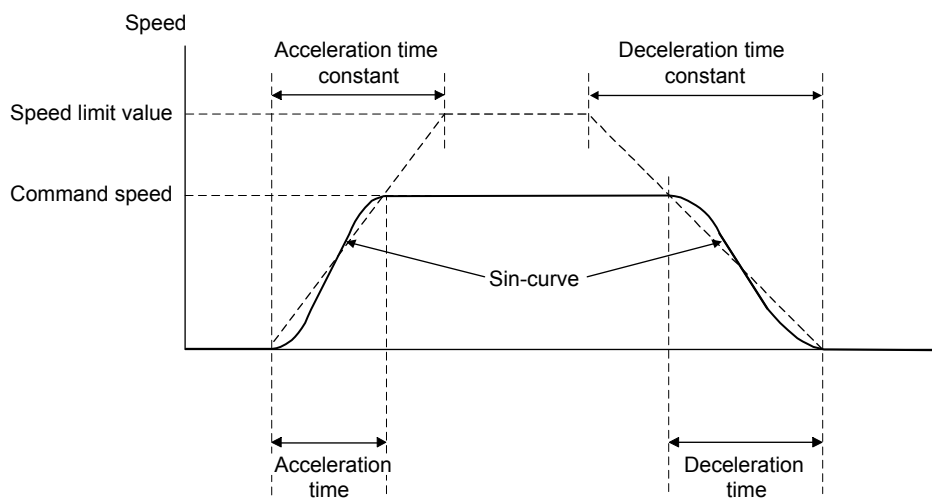

Control parameters

Parameter No.	Abbreviation	Name	Initial Value	Unit	Setting range	Function
0221	SRATE	S-curve ratio	0	%	0 to 100	Set the S-curve ratio of the S-curve acceleration/deceleration (Sine acceleration/deceleration). 0: S-curve acceleration/deceleration invalid 1 to 100: S-curve acceleration/deceleration (Note 1) (Note 2)

Note 1. S-curve acceleration/deceleration is performed for the acceleration/deceleration selected in acceleration/deceleration method (parameter No.0220).

2. The S-curve ratio set by this parameter is used in JOG operation, incremental feed operation and home position return. For automatic operation and linear interpolation operation, set the S-curve ratio in the point table.

6. APPLICATION FUNCTIONS

The S-curve ratio indicates which part of the Sin-curve is used to draw the acceleration/deceleration curve as shown in the figure below.

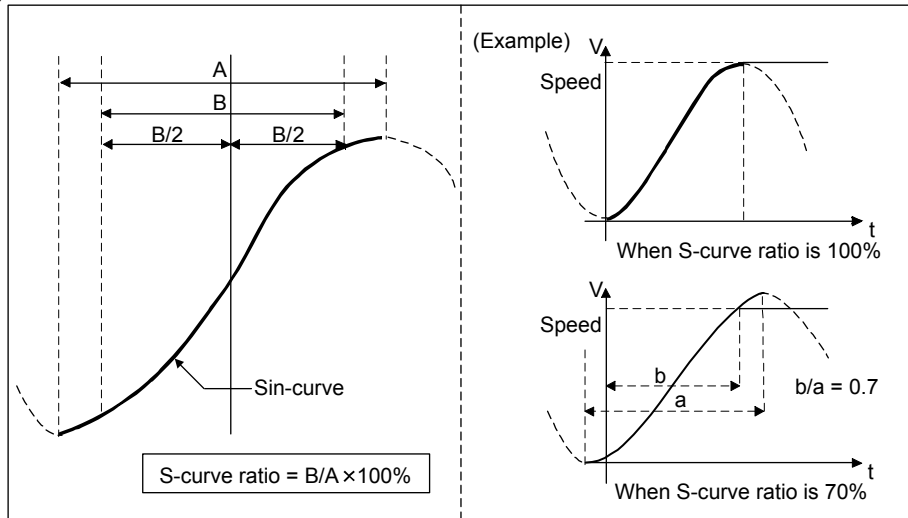

POINT
<ul style="list-style-type: none"> The valid limits of S-curve ratio are 30 to 100%. When less than 30% is set, the command waveform is the same as the one of the setting of 0%. The setting at starting operation is valid for the S-curve ratio. If the S-curve ratio is changed during operation, the change is not made. It is validated (changed) the next time operation is started.

When the change speed is performed, the acceleration/deceleration based on the Sin-curve to the set speed is performed again from the time of the completion of preparation for changing speed.

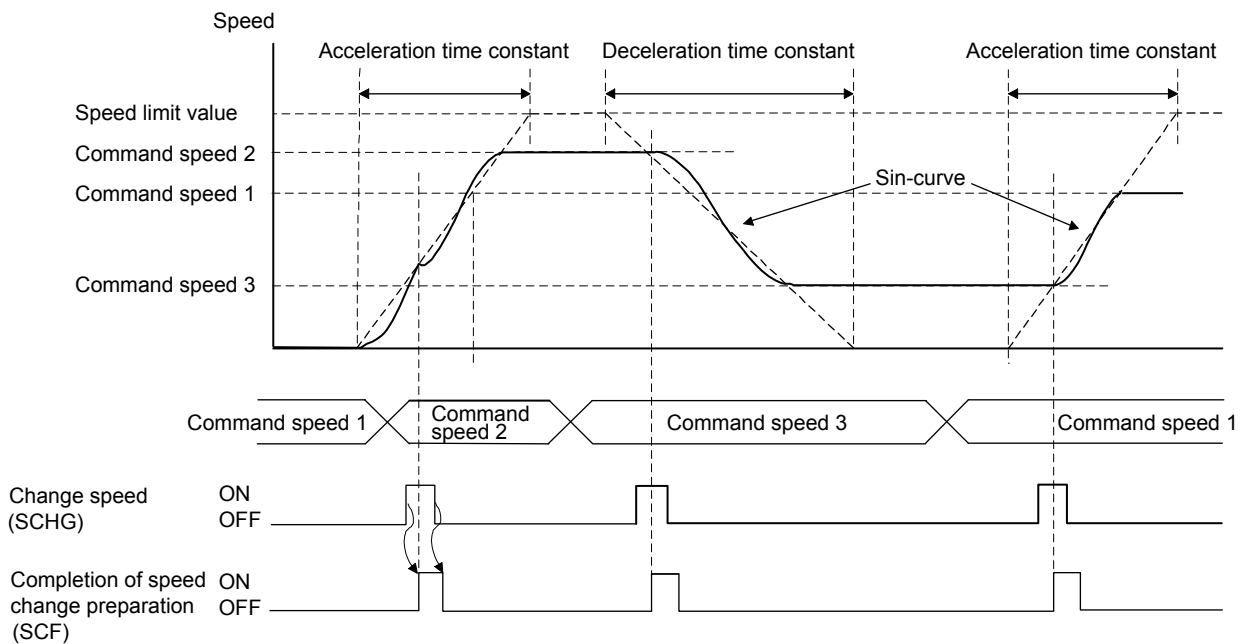

6. APPLICATION FUNCTIONS

When the acceleration time constant is changed during the acceleration, acceleration based on the Sin-curve is performed again from the time of the completion of acceleration time constant change preparation.

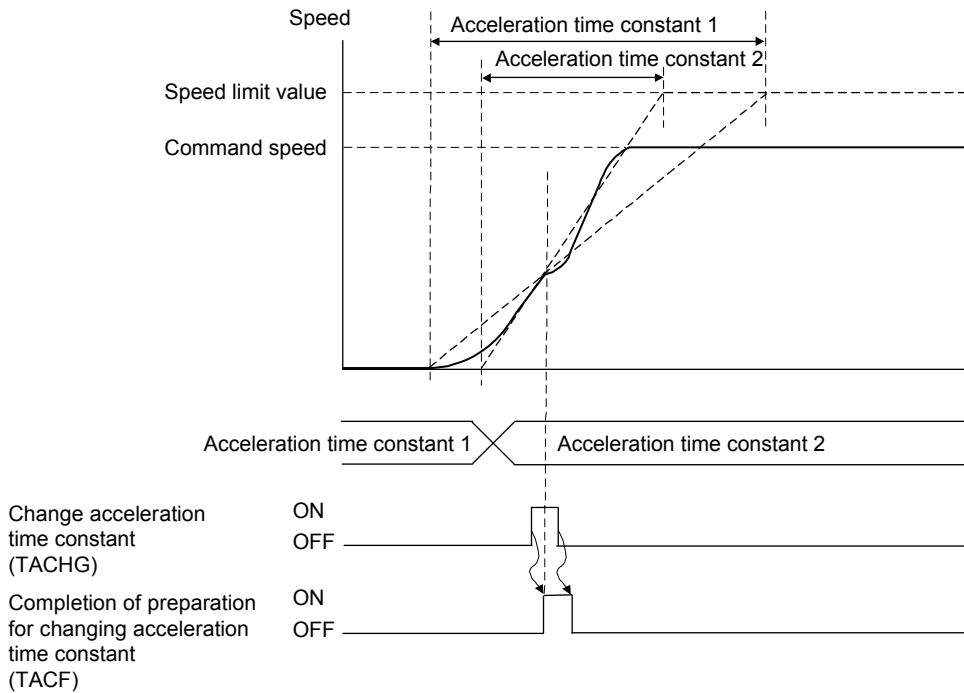

When deceleration to a stop is performed with rapid stop time constants such as rapid stop (RSTP) and interlock (ITL), the S-curve acceleration/deceleration is canceled and linear deceleration is performed. When deceleration to a stop is performed with deceleration time constants such as operation alarms, the S-curve acceleration/deceleration is performed.

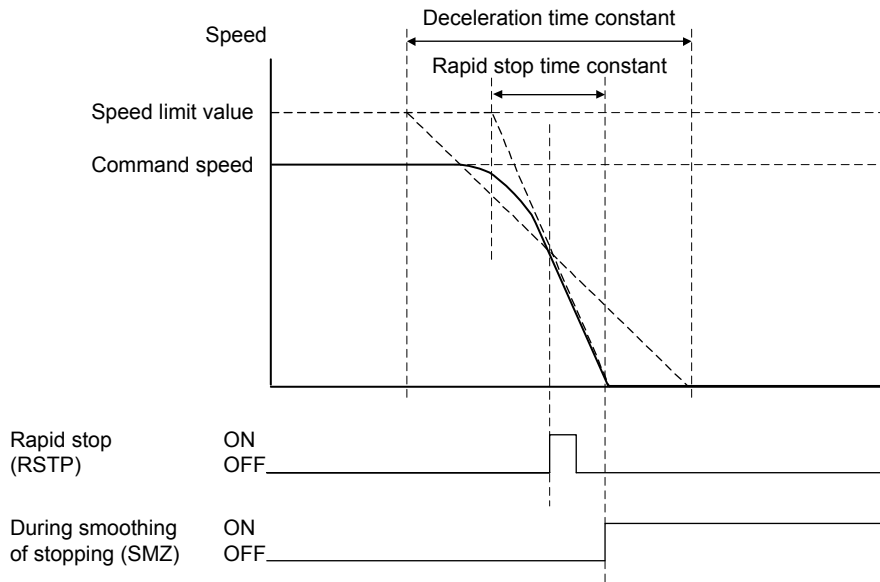

However, when overrun occurs (for example, rapid stop time constant is longer than deceleration time constant.), the S-curve acceleration/deceleration is kept to a stop.

6. APPLICATION FUNCTIONS

When the original command shape is not in a trapezoid but in a triangle (for example, the travel distance is small.), acceleration/deceleration is performed based on the Sin-curve that peaks at the maximum command speed for triangle command.

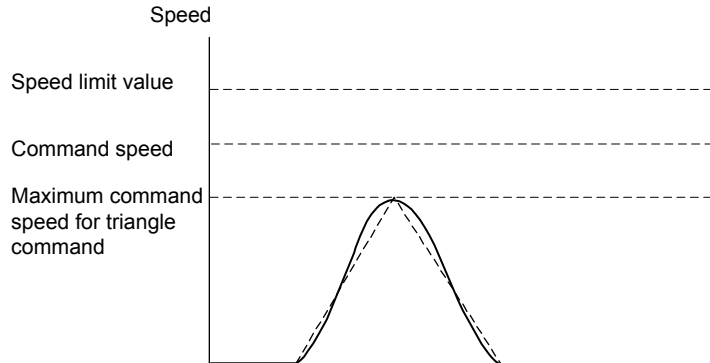

Smoothing filter and S-curve acceleration/deceleration can be used together. In addition, S-curve acceleration/deceleration and start up speed can be used together. When S-curve acceleration/deceleration and start up speed is used together, the acceleration/deceleration as shown in the figure below is performed.

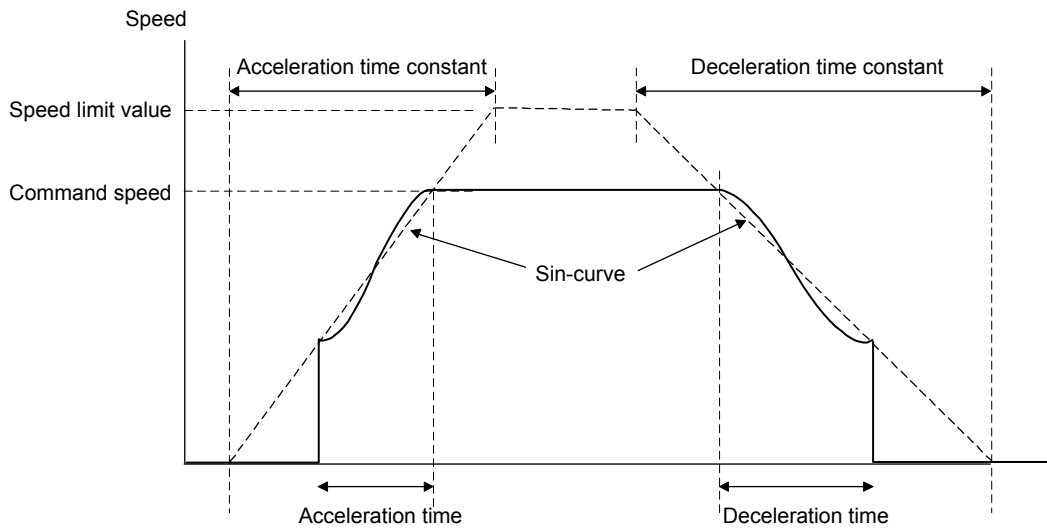

6. APPLICATION FUNCTIONS

6.4 Servo off

If an axis has moved due to an external force while the servo was off, the current command position is updated in accordance with the movement amount (Current feedback position). After the servo has been off, coordinate return processing such as return to home position is not necessary.

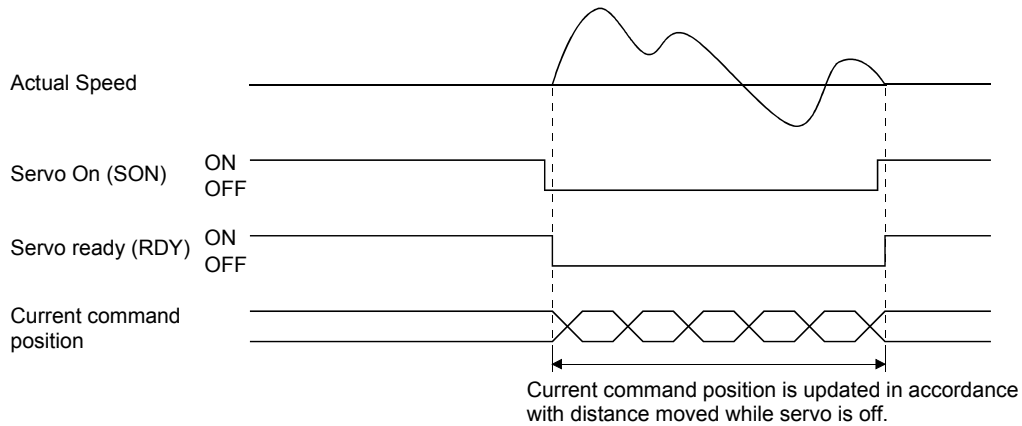

If the servo on signal (SON) is turned off during operation, an alarm occurs, movement is rapid stopped, and the servo is turned off. Even if the servo on signal (SON) is turned back on, operation does not resume.

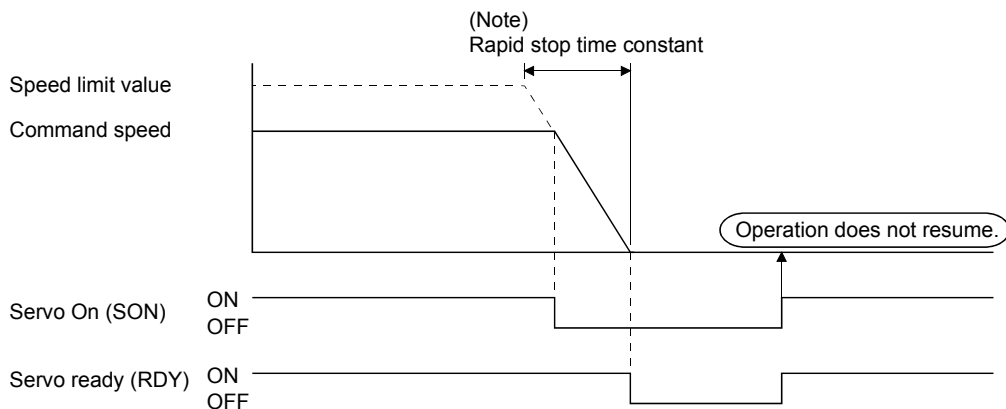

Note. If 1: Smoothing filter is set in Speed options (parameter No.0220), the smoothing time constant is always valid. Therefore, rapid stop as well will use smoothing filter.

API LIBRARY

- To turn ON/OFF the servo ON command (SON), set SSC_CMDBIT_AX_SON to the command bit number of the sscSetCommandBitSignalEx function.
- To check if servo ready (RDY) is ON/OFF, set SSC_STSBIT_AX_RDY to the status bit number with the sscGetStatusBitSignalEx or sscWaitStatusBitSignalEx functions.

6. APPLICATION FUNCTIONS

6.5 Forced stop

Commands are turned to " ϕ " at forced stop. Servo amplifiers become free from the control of the Q173SCCF and stops according to their specifications or settings such as dynamic brake stop and deceleration to a stop. For details, refer to the Servo Amplifier Instruction Manual on your servo amplifier.

During forced stopping, the current command position is updated according to movement (Current feedback position) therefore, after resetting the forced stop, origin coordinate processing such as home position return is not necessary.

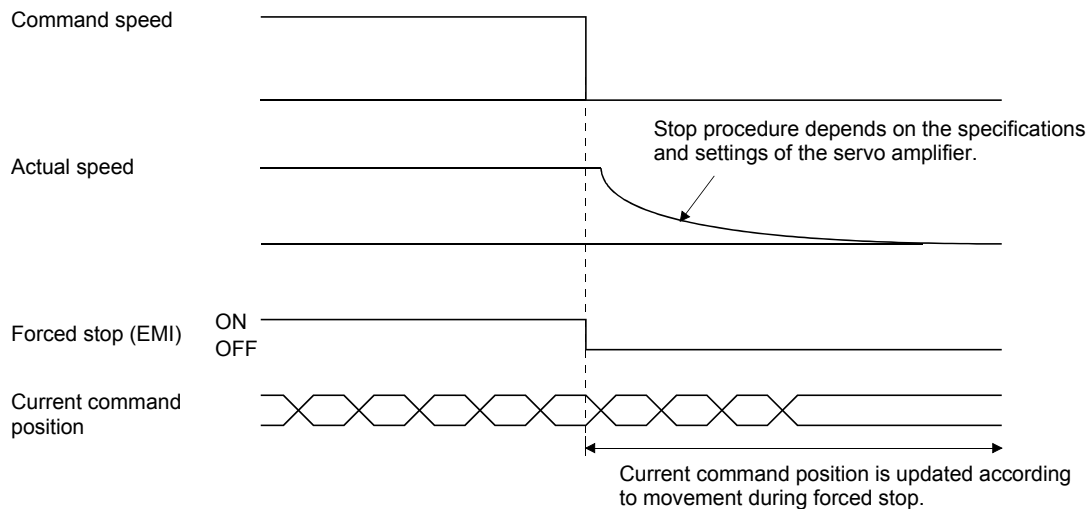

For forced stops, there are an external forced stop using an input signal through the forced stop input connector and a software forced stop signal (SEMI) from a system command bit.

Also, a system error (system status code E□□□h) such as an SSCNET communication error activates the forced stop. The cause of the forced stop can be confirmed using monitor number 0401.

API LIBRARY

- To turn ON/OFF the software forced stop command (SEMI), set SSC_CMDBIT_SYS_SEMI to the command bit number of the sscSetCommandBitSignalEx function.
- To check if during forced stop (EMIO) is ON/OFF, set SSC_STSBIT_SYS_EMIO with the sscGetStatusBitSignalEx or sscWaitStatusBitSignalEx function.

6. APPLICATION FUNCTIONS

6.6 Stop operation

When the stop operation signal (STP) is turned on, movement is stopped. (Alarms and warnings are not set.) Even if the stop operation signal (STP) is turned back off, operation is not resumed. The time constant used for stopping for stop operation is the deceleration time constant. If operation is stopped during linear interpolation operation or automatic operation, they do not turn on positioning complete signal (PF).

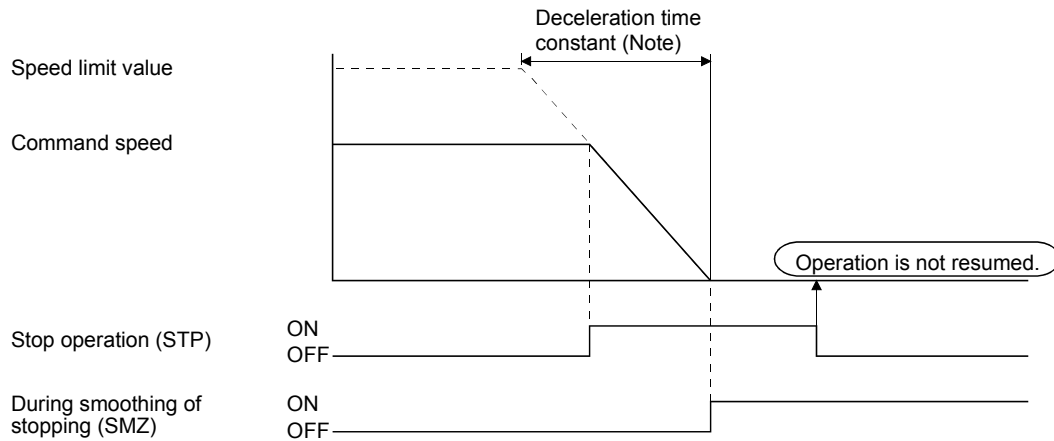

Note. If smoothing filter is set, the smoothing time constant is always valid. Therefore, deceleration stop as well will use smoothing filter.

API LIBRARY

- Use the `sscDriveStop` or `sscDriveStopNoWait` functions to perform a stop operation.

6. APPLICATION FUNCTIONS

6.7 Rapid stop operation

When the rapid stop signal (RSTP) is turned on, movement is stopped abruptly. (Alarms and warnings are not set.) Even if the rapid stop signal (RSTP) is turned back off, operation is not resumed. The deceleration time constant used for stopping for rapid stop operation is the rapid stop time constant (parameter No.0227). If operation is abruptly stopped during linear interpolation operation or automatic operation, they do not turn on positioning complete signal (PF).

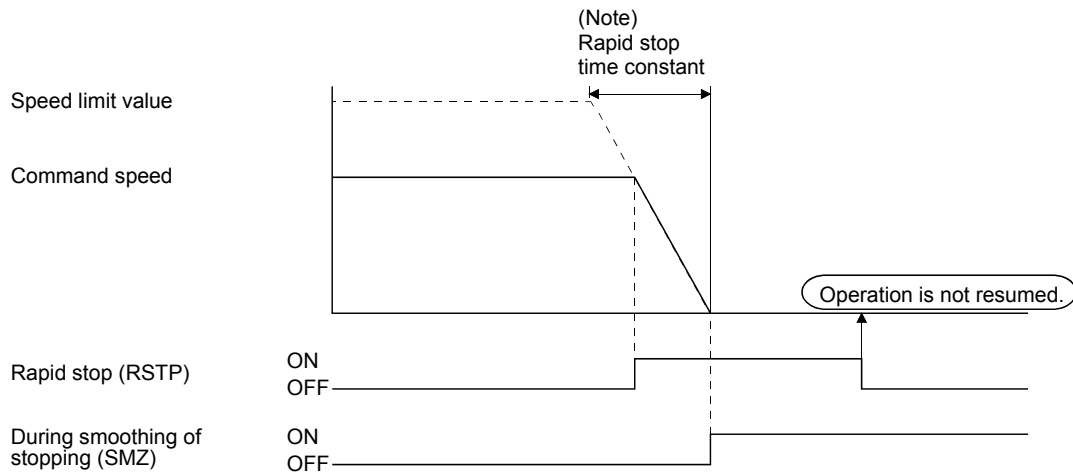

Note. If smoothing filter is set, the smoothing time constant is always valid. Therefore, rapid stop as well will use smoothing filter.

API LIBRARY

- Use the `sscDriveRapidStop` or `sscDriveRapidStopNoWait` functions to perform a rapid stop operation.

6. APPLICATION FUNCTIONS

6.8 Limit switch (stroke end)

When the limit switch signal corresponding to the movement direction is turned off, an alarm occurs and movement is stopped.

The deceleration time constant used for stopping by the limit switch is the rapid stop time constant.

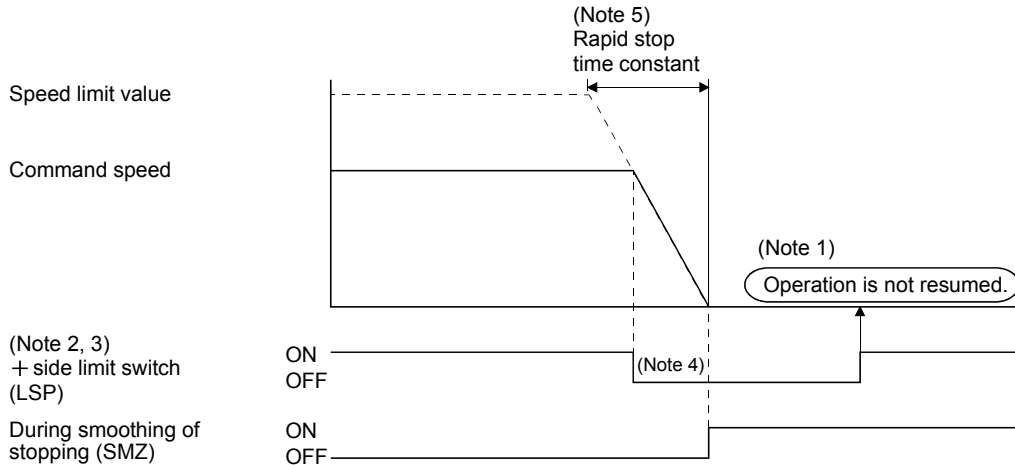

Note 1. Even if the limit switch signal is turned back on, operation does not resume.

2. The limit switch signal is a signal that is input through the servo amplifier or something similar. The method for inputting an external signal can be set up using sensor input options (parameter No.0219).
3. The limit switch signal is a normally-closed contact.
4. If operation stopped by the limit switch during linear interpolation operation or automatic operation, they do not turn on the positioning complete signal (PF).
5. If smoothing filter is set, the smoothing filter time constant is always valid. Therefore, rapid stop as well will use smoothing filter.

If the servo is stopped with the limit switch in the off position (prohibited area), the servo can be moved in the movement allowed area. However, execute start operation, after resetting the alarm that has been set.

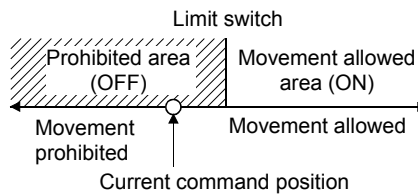

API LIBRARY

- Use the sscGetIoStatusFast function to check if limit switch (LSP or LSN) is ON/OFF.

6. APPLICATION FUNCTIONS

6.9 Software limit

(1) Using a JOG operation

During JOG operation, if the software limit is reached, a reached software limit (operation alarm A2, detail 01) occurs, the deceleration of the servo is started, and the servo is stopped not to exceed the software limit.

(2) Using incremental feed

If the movement amount designated by an incremental feed exceeds the software limit, an out of software limit boundaries (operation alarm A1, detail 01) occurs and the start operation is not performed.

(3) Using automatic operation

If the point designated by a position command exceeds the software limit, an out of software limit boundaries (operation alarm A1, detail 01) occurs and the start operation is not performed. Also, if the point is designated during operation, an out of software limit boundaries (operation alarm A1, detail 01) occurs when the point is designated and servo is decelerated and stopped.

(4) Using linear interpolation

If the point designated by a position command for an axis within the group exceeds the software limit, an out of software limit boundaries (operation alarm A1, detail 01) occurs and the start operation is not performed. Also, if the point is designated during operation, an alarm occurs when the point is designated and servo is decelerated and stopped.

POINT

- If the deceleration check method is in continuous operation and the position command after point switching exceeds the software limit, it will output the out of software limit boundaries (operation alarm A1, detail 01) and will come to a decelerated stop. In this case, if the distance to the software limit is shorter than the distance necessary to make a decelerated stop, it may stop outside the software limit.
- The software limit boundaries are set using parameters No.0228, 0229, 022A, 022B.
- If an alarm set due to exceeding the software limit, the servo is stopped using the deceleration time constant.

API LIBRARY

- Use the sscChange2Parameter/sscCheck2Parameter function to set/get the software limit.

6. APPLICATION FUNCTIONS

If the current command position is outside the software limit boundaries (prohibited area), the servo can be moved in the direction of the movement allowed area. However, execute the start operation after resetting the alarm that has been set.

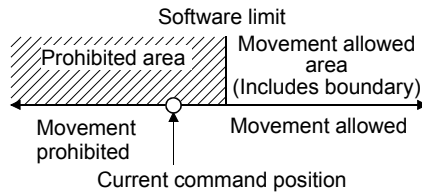

POINT

- If the upper boundary and lower boundary of the software limit are the same value, the software limit are invalid.
- If the lower boundary of the software limit is a higher value than the upper limit, a software limit parameter error (operation alarm A4, detail 01) occurs upon start of operation.
- Software limits are invalid when home position return has not been completed.

Note. By the Q173SCCF, the range of movement is -2147483648 to 2147483647. Movement outside the limits is not covered with a guarantee. If software limits have been disabled, be careful not to move it outside of the physical limits.

6. APPLICATION FUNCTIONS

6.10 Interlock

When the interlock signal (ITL) is turned on, movement is temporarily stopped. During stoppage of movement the interlock stop signal (ISTP) is turned on. When the interlock signal (ITL) is turned off, operation is resumed. The interlock signal (ITL) for normally-open contact or normally-closed contact can be selected using control option 3 (parameter No.0202). (The explanation in this section is for a normally-open contact.)

When using interlock to stop the servo, deceleration uses the rapid stop time constant.

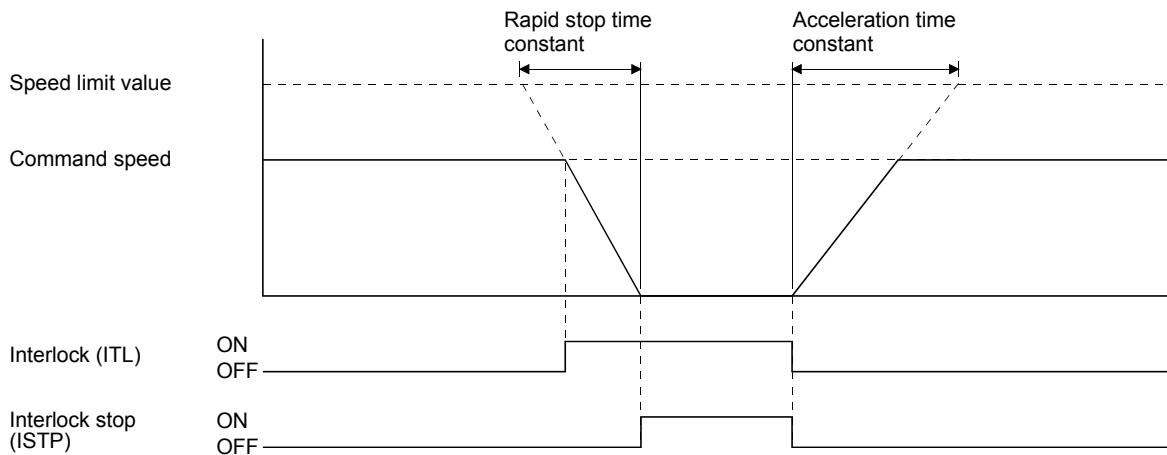

If the interlock signal is cancelled during deceleration, operation is re-started after the command speed decreases to 0. For this case, the interlock stop signal (ISTP) does not turn on.

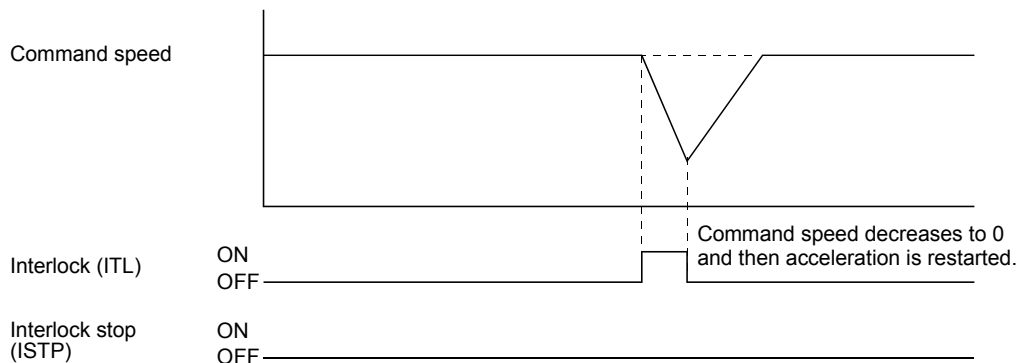

6. APPLICATION FUNCTIONS

POINT

- If the stop operation signal (STP) or rapid stop signal (RSTP) is turned on during interlock stop, operation is not resumed even if the interlock signal is turned off.
- If smoothing filter is set, the smoothing time constant is always valid. Therefore, rapid stop as well will use smoothing filter.
- If start up is executed while the interlock signal is on, the interlock is on alarm (operation alarm 13, detail 01) occurs and the start operation is not performed. Execute the start operation after canceling the interlock.
- During linear interpolation, if the interlock signal for any of the axes in the linear interpolation group is turned on, all of the axes in the group are stopped. Also, when the interlock signal (ITL) for all of the axes within a group is cancelled, operation is resumed.

API LIBRARY

- To turn ON/OFF the interlock command (ITL), set SSC_CMDBIT_AX_ITL to the command bit number of the sscSetCommandBitSignalEx function.
- To check if interlock stop (ISTP) is ON/OFF, set SSC_STSBIT_AX_ISTP to the status bit number with the sscGetStatusBitSignalEx or sscWaitStatusBitSignalEx function.

6. APPLICATION FUNCTIONS

6.11 Rough match output

When the command remaining distance (difference between the command position and the current command position) is less than the rough match output limit (parameter No.0230, 0231), the rough match signal (CPO) is output. Rough match output is only valid at the end points while operating using automatic operation or linear interpolation operation. Therefore, it does not turn on when passing points on the way.

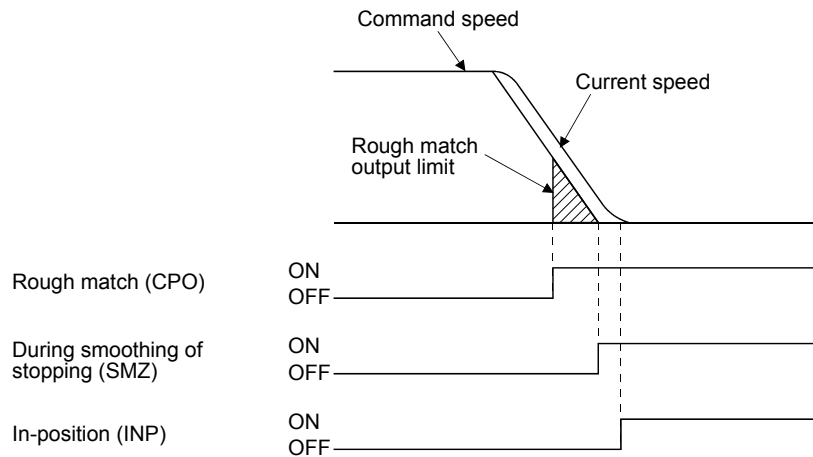

API LIBRARY

- Use the `sscChange2Parameter/sscCheck2Parameter` function to set/get the rough match output limit.

6. APPLICATION FUNCTIONS

6.12 Torque limit

When the torque limit signal (TL) is turned on, the torque is limited by the torque limit values set in the normal revolution torque limit (parameter No.0210) and the reverse revolution torque limit (parameter No.0211). When torque is limited by the torque limit values, the torque limit effective signal (TLC) is turned on. Even if the torque limit signal (TL) is on, if the actual torque is smaller than the torque limit value, the torque limit effective signal (TLC) is not turned on.

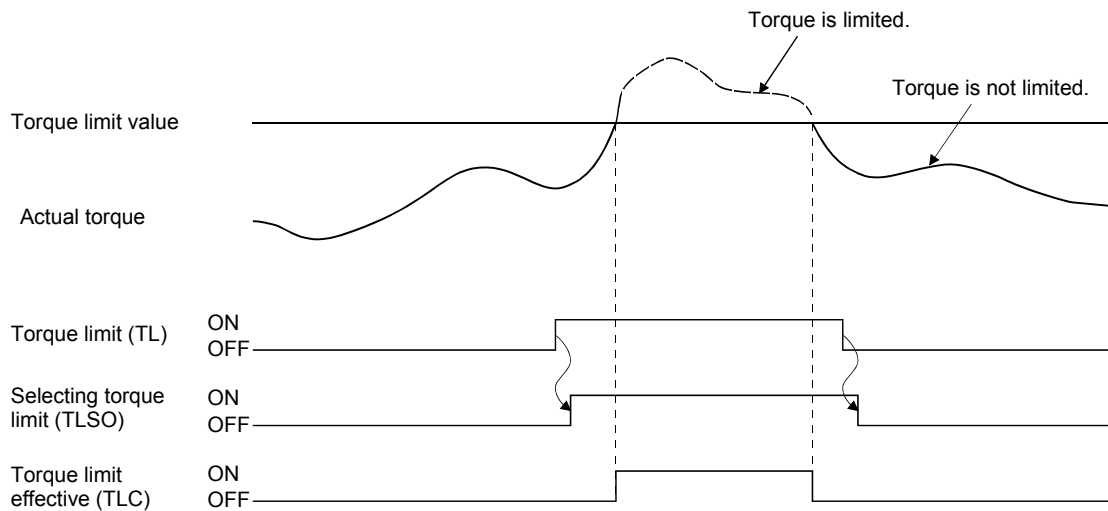

API LIBRARY

- To turn ON/OFF the torque limit command (TL), set SSC_CMDBIT_AX_TL to the command bit number of the sscSetCommandBitSignalEx function.
- To check if selecting torque limit (TLSO) and torque limit effective (TLC) are ON/OFF, set SSC_STSBIT_AX_TLSO, SSC_STSBIT_AX_TLC to the status bit number with the sscGetStatusBitSignalEx or sscWaitStatusBitSignalEx function.

6. APPLICATION FUNCTIONS

6.13 Command change

6.13.1 Speed change

Rewriting the command speed followed by turning on the change speed signal (SCHG) changes the speed. For automatic operation and linear interpolation operation, rewrite the feed speed in the operating point table and for JOG operation and incremental feed, rewrite the manual feed speed. Speed change can also be implemented during acceleration or deceleration.

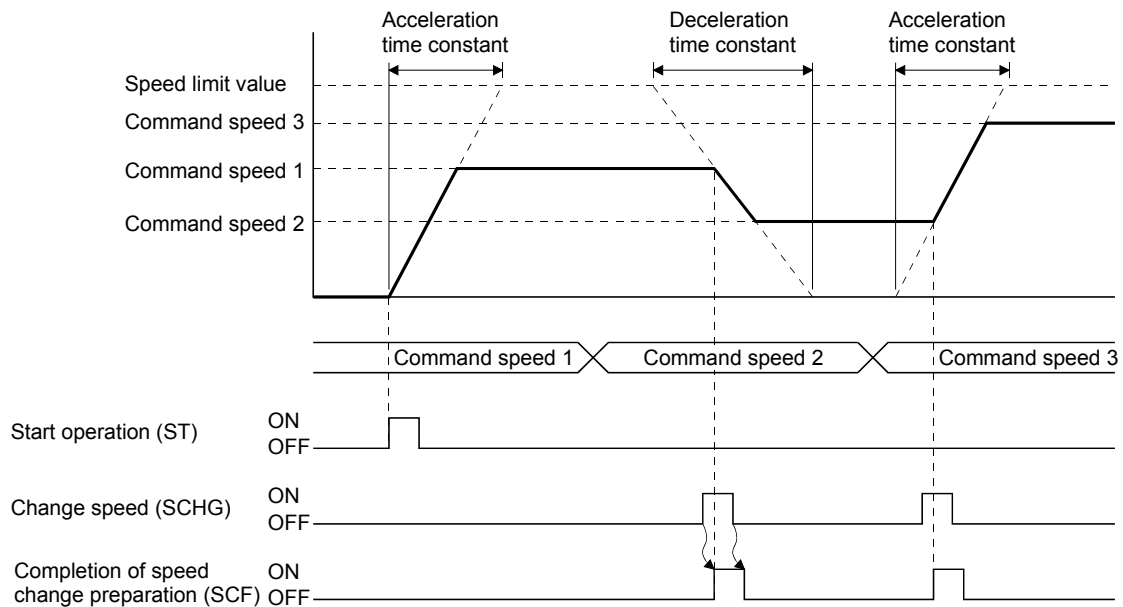

During the following cases, the "speed change error signal" (SCE) turns ON, and speed will not change.

- Operation stop
- Deceleration due to stop command, rapid stop command, alarm etc
- Home position return
- Home position reset
- The command speed after change is zero or below

API LIBRARY

- Use the `sscChangeAutoSpeed` function to perform a speed change for automatic operation and linear interpolation operation.
- Use the `sscChangeManualSpeed` function to perform a speed change for JOG operation and incremental feed.

6. APPLICATION FUNCTIONS

6.13.2 Change of time constants

After rewriting the time constant, turning the change time constant signal (TACHG, TDCHG) on causes the time constant to change. Time constants can be designated separately as the acceleration time constant and the deceleration time constant.

For automatic operation and linear interpolation operation rewrite the time constant in the operating point table and for JOG operation and incremental feed, rewrite the manual feed time constant.

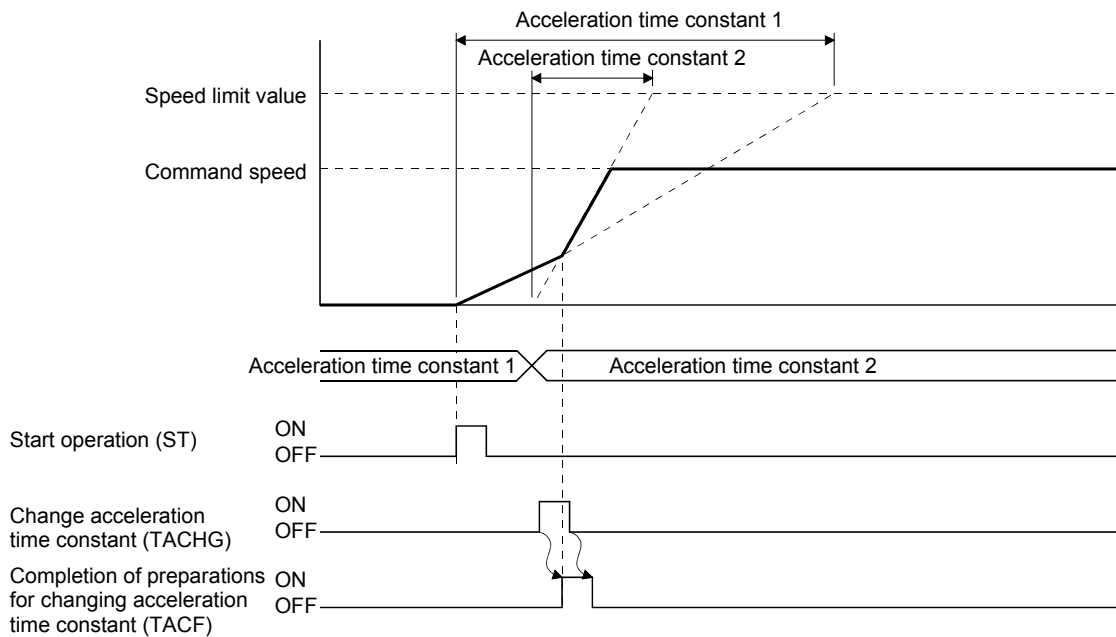

During the following cases, the "acceleration time constant change error signal" (TACE) or the "deceleration time constant change error signal" (TDCE) turns on, and time constant will not change.

- Operation stop
- Deceleration
- Home position return
- Home position reset

API LIBRARY

- Use the `sscChangeAutoAccTime` or `sscChangeAutoDecTime` functions to perform a change of time constants for automatic operation and linear interpolation operation.
- Use the `sscChangeManualAccTime` or `sscChangeManualDecTime` functions to perform a change of time constants for JOG operation and incremental feed.

6. APPLICATION FUNCTIONS

6.13.3 Position change

After rewriting the command position, turning the position change signal (PCHG) on causes the command position to be changed. For automatic operation rewrite position data in the operating point table and for incremental feed, rewrite the feed movement amount.

During linear interpolation operation, rewrite the position data in each point table of the axes in the group.

(1) To change the command position to the position which is not yet passed

(a) For automatic operation and incremental feed

An example of the position change from the command position 1 to the command position 2 is shown below.

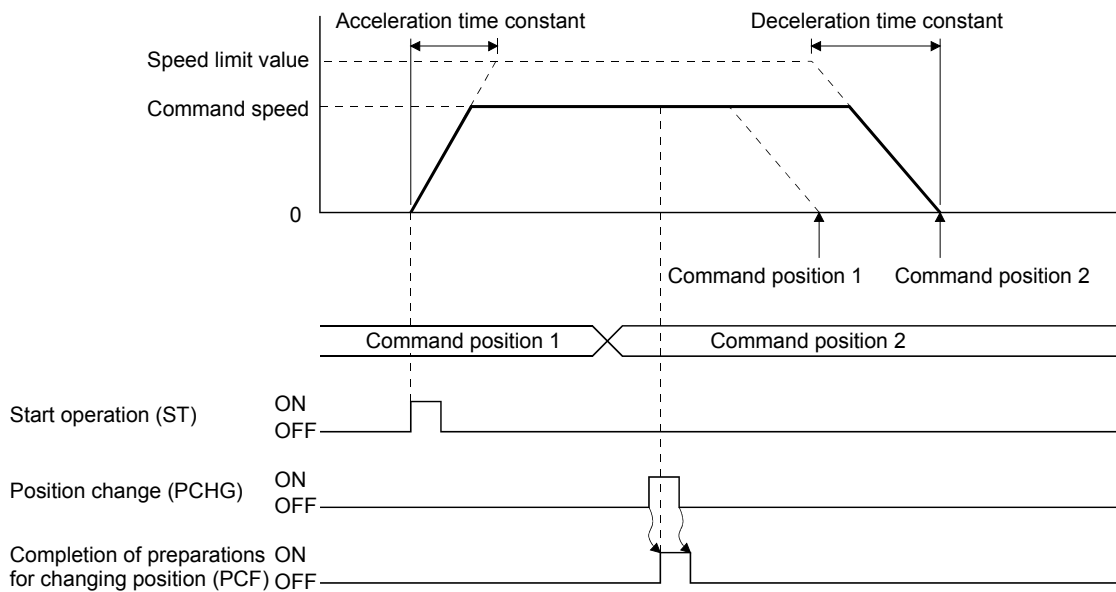

API LIBRARY

- Use the `sscChangeAutoPosition` function to perform a position change for automatic operation.
- Use the `sscChangeLinearPosition` function to perform a position change for linear interpolation operation.
- Use the `sscChangeManualPosition` function to perform a position change for incremental feed.

6. APPLICATION FUNCTIONS

(b) For linear interpolation operation

An example of the position change when axis 1 and 2 are linearly interpolated is shown below.

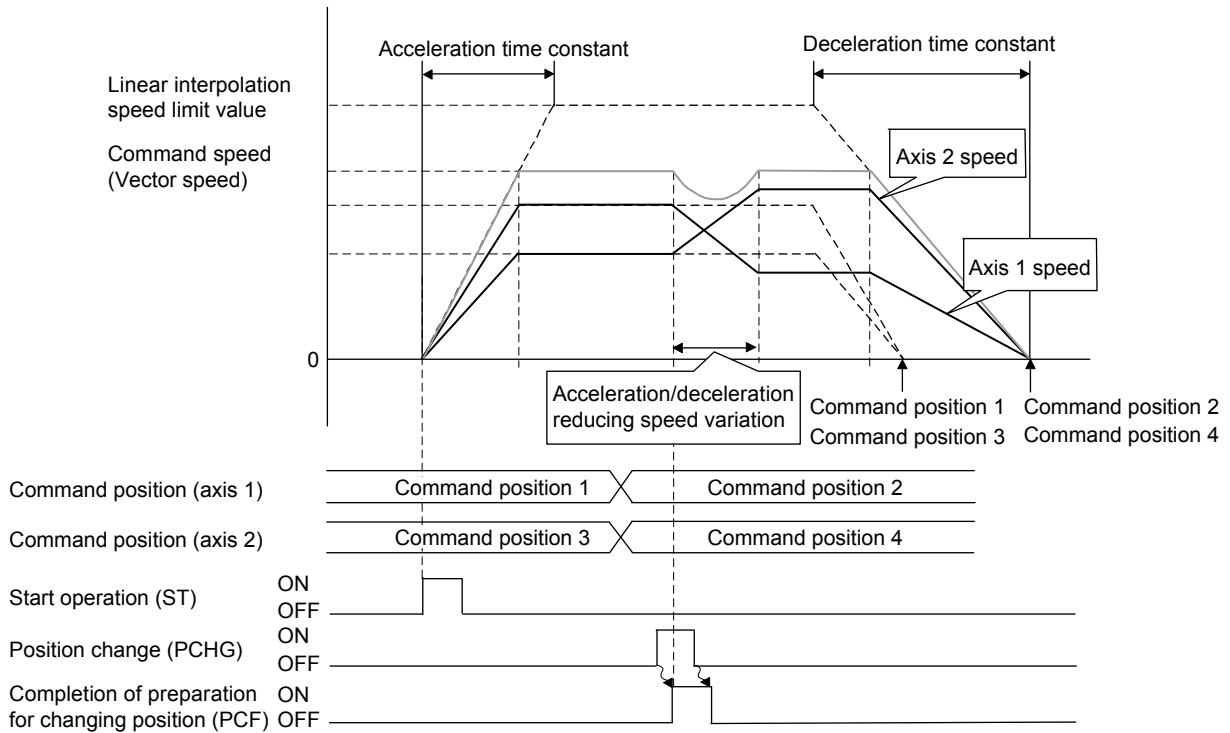

POINT

- Acceleration/deceleration of each axis from the current command speed to the command speed after position change is determined by distributing acceleration amount, which is determined by the acceleration time constant, to each axis according to speed variation ratio of the axes. During this time, S-curve acceleration/deceleration and start up speed are invalid, and acceleration/deceleration reducing the speed variation at position change is performed. (That acceleration/deceleration is similar to the linear acceleration/deceleration. However, smoothing filter is valid.)

6. APPLICATION FUNCTIONS

The tracks of axis 1 and 2 to each current command position when the position P1 is changed to the position P2 are shown below. At this time, the tracks move to the end position, forming a curve from the position where the position change is performed, to keep the speed continuity.

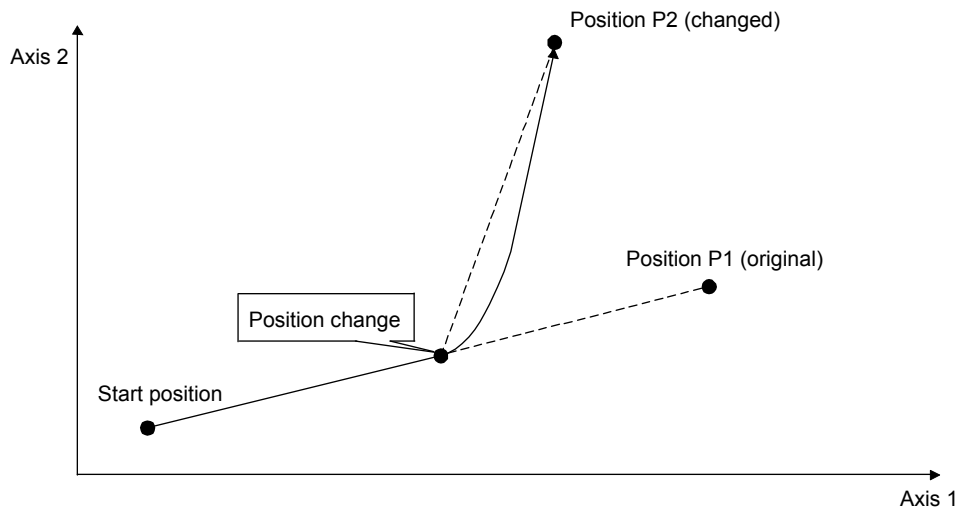

6. APPLICATION FUNCTIONS

(2) When position change is performed during deceleration

When re-acceleration setting for position change during deceleration for control option 4 (parameter No.0206) is disabled and position change is performed during deceleration, the deceleration continues. After the axis stops, the positioning to the new position is performed.

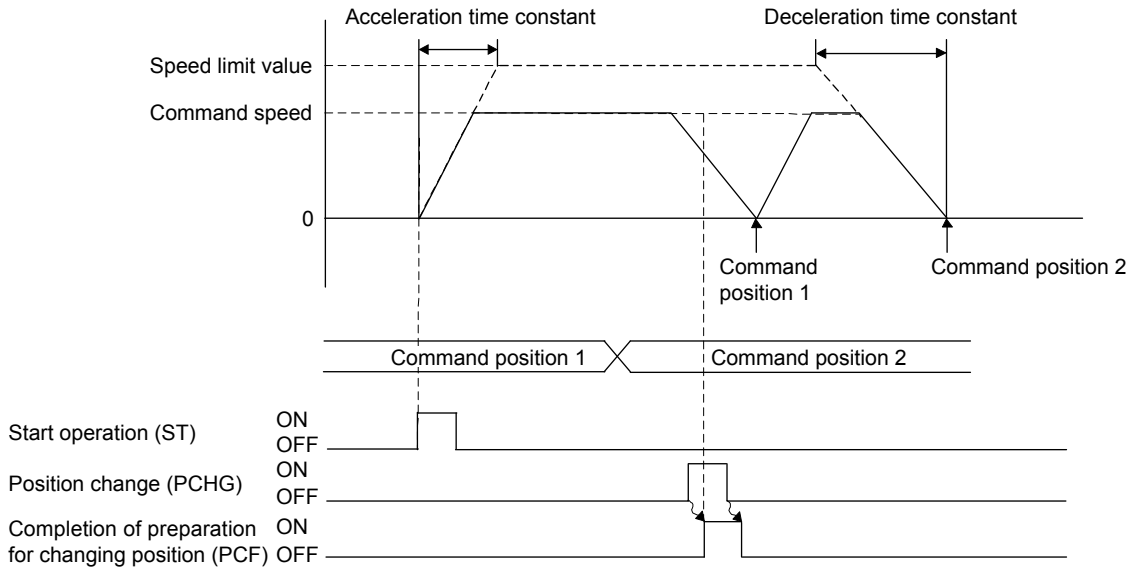

When re-acceleration setting for position change during deceleration for control option 4 (parameter No.0206) is enabled and position change is performed during deceleration, the axis re-accelerates before stopping, and stops after reaching the new position.

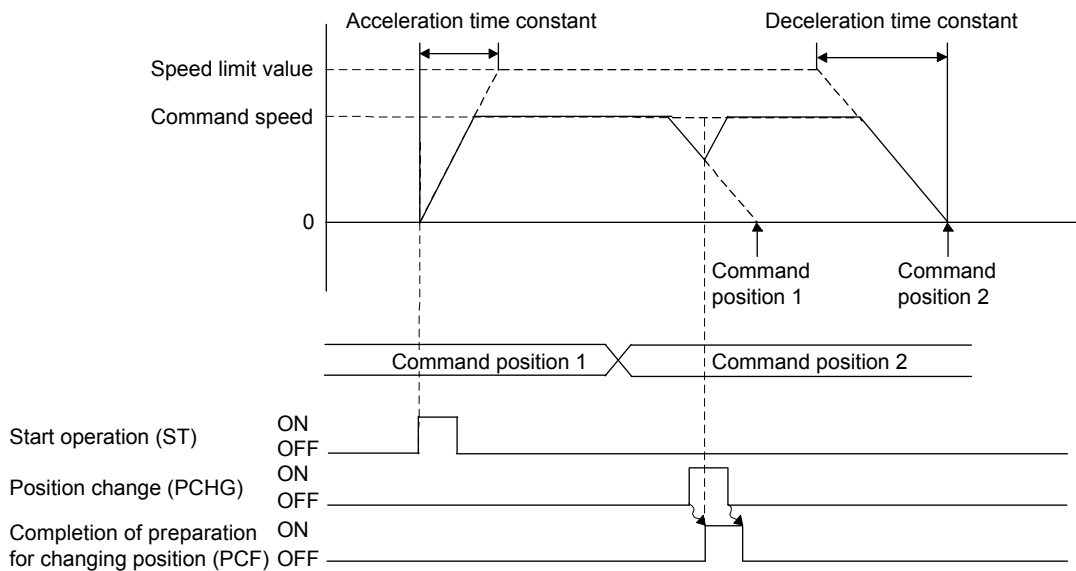

POINT

- Linear interpolation does not support re-acceleration setting for position change during deceleration.

6. APPLICATION FUNCTIONS

⚠ CAUTION

- When conducting position change during deceleration with the S-curve enabled and there is only a minor difference between the end points before and after the change, an overrun may occur. In this case, operation is performed according to control option 2 (parameter No.0201) change of position over-bound processing.

(3) When the new position is already passed

For cases of the new position has already been passed or if the stop position after deceleration will pass the new position, operation depends on operation modes.

(a) For automatic operation and incremental feed

For cases of changing position where the new position has already been passed or if the stop position after deceleration will pass the new position, operation can be selected from "stop with an alarm" or "after deceleration and stop return to new position" using control option 2 (parameter No.0201).

The case for returning to the new position after deceleration and stop is shown in the next diagram. At this time the stop position over-bound signal (POV) is turned on (the stop position over-bound signal (POV) is turned off at the next start up).

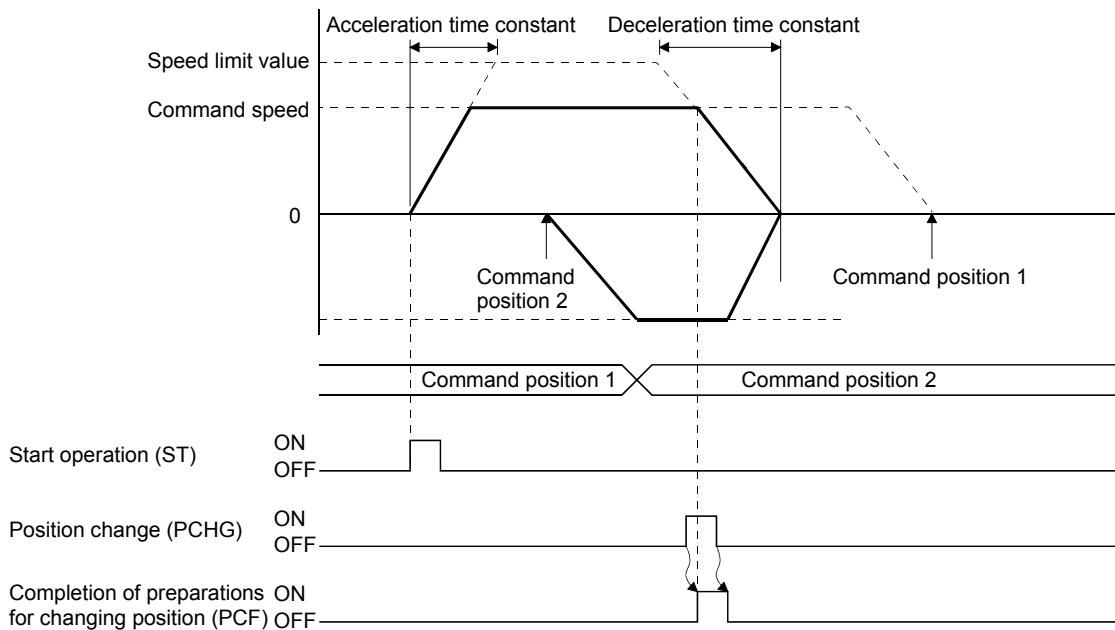

6. APPLICATION FUNCTIONS

(b) For linear interpolation operation

When one or more axes in a linear interpolation group reverse the movement direction because of the position change, all axes in the group automatically decelerate and stop. After the stop, the axes return to the new position. The setting of control option 2 (parameter No.0201) is invalid. At this time, the stop position over-bound signal (POV) remains off.

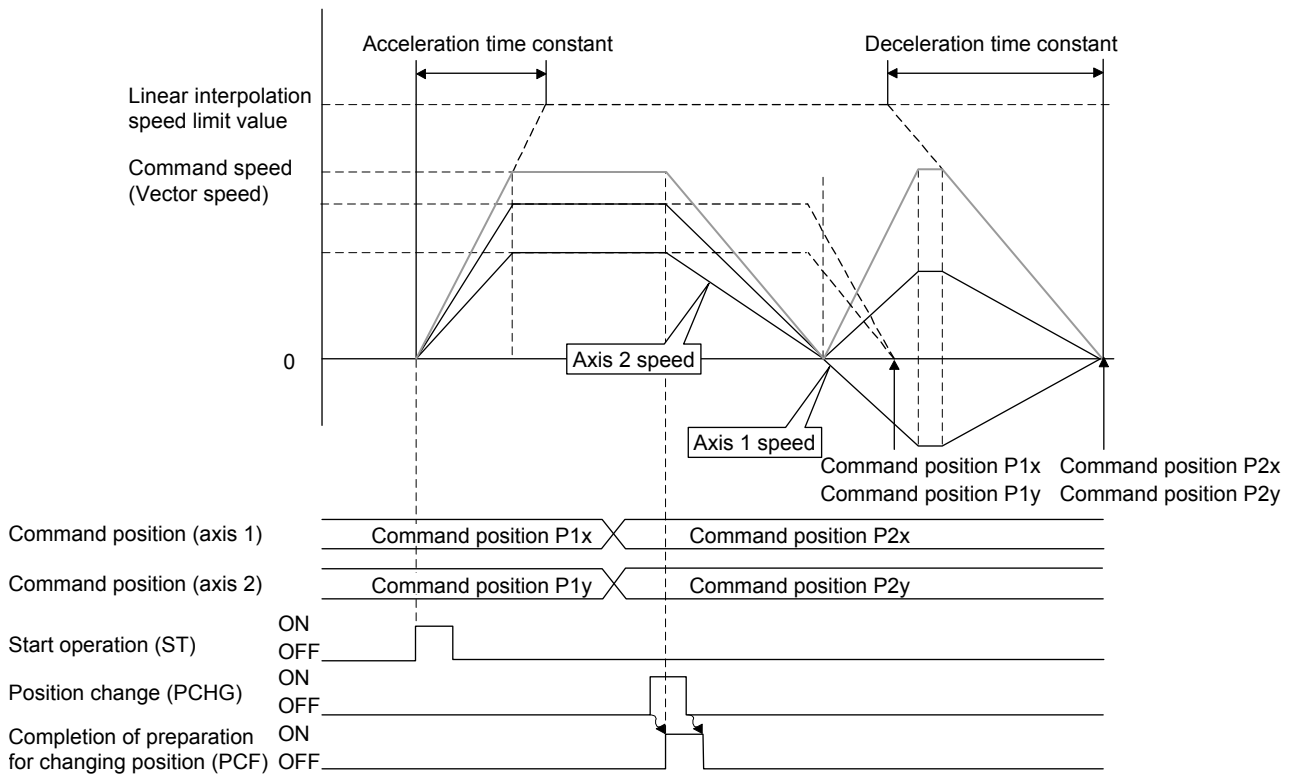
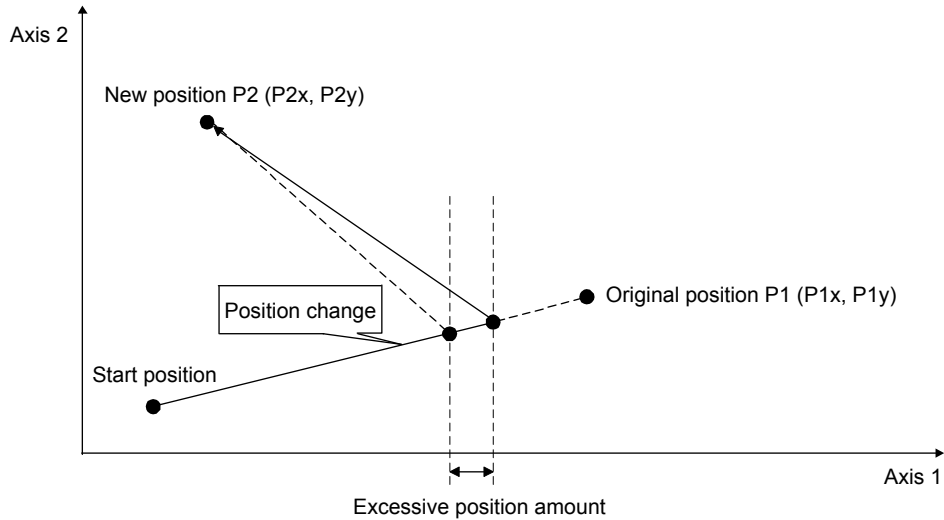

6. APPLICATION FUNCTIONS

In the example above, the current command position of the axis 1 exceeds the new position. The following formulas provide the approximate calculation of the excessive travel distance (excessive position amount).

$$\text{Deceleration quantity [speed unit/s]} = \frac{\text{Linear interpolation speed limit [speed unit]}}{\div \text{Deceleration time constant [ms]} \div 1000}$$

$$\text{Deceleration time [s]} = \text{Vector speed [speed unit]} \div \text{Deceleration quantity}$$

$$\text{Vector travel distance [command unit]} =$$

$$\sqrt{(\text{Axis 1 travel distance[command unit]})^2 + (\text{Axis 2 travel distance[command unit]})^2}$$

$$\text{Axis 1 moving speed [speed unit]} = \frac{\text{Axis 1 travel distance [command unit]} \div \text{Vector travel distance} \times \text{Vector speed [speed unit]}}$$

$$\begin{aligned} \text{Axis 1 excessive position amount [command unit]} = & \text{Axis 1 moving speed} \\ & \times \text{Axis 1 speed units multiplication factor} \\ & \times \text{Deceleration time} \div 2 \end{aligned}$$

Note. The same feature is applied to linear interpolation for more than 3 axes.

(4) When position change error occurs

During the following cases, the "position change error signal" (PCE) turns on, and the position will not change.

- Operation stop
- JOG operation, home position return, home position reset
- Deceleration due to stop command, rapid stop command, alarm etc.
- The specified value is out of the software limit setting value.
- A position change command is input to an auxiliary axis in linear interpolation.

6. APPLICATION FUNCTIONS

6.14 Backlash

A function that corrects the mechanical error (backlash) when the movement direction is reverse.
The compensation amount for backlash is set in backlash compensation amount (Parameter No.0208).

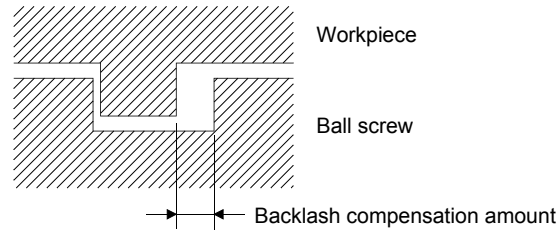

Condition	Processing details
Normal	The compensation amount is added at the timing of switching movement direction.
Home position return	Backlash compensation is performed as well as normal.

API LIBRARY

- Use the sscChange2Parameter/sscCheck2Parameter function to set/get the backlash compensation amount.

6. APPLICATION FUNCTIONS

6.15 Position switch

Position switch is turned on when the axis is within setting range (including the boundary line) which set by position switch upper limit (parameter No.022C, 022D), position switch lower limit: parameter No.022E, 022F).

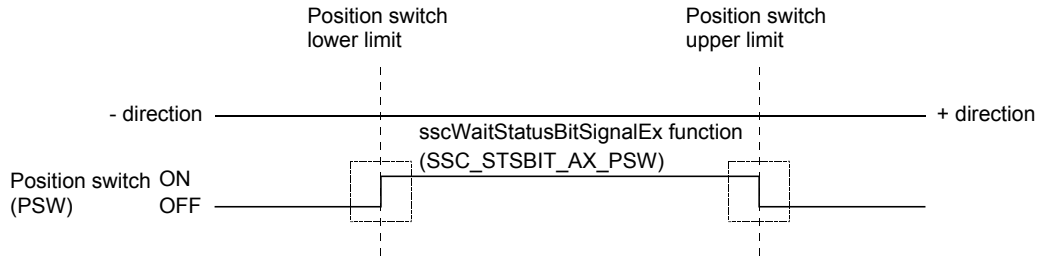

Two options of current command position or current feedback position can be selected for judgement the condition for the position switch using control option 2 (parameter No.0201).

POINT

- If the upper limit and lower limit of the position switch are the same value, the position switch is invalid.
- If the lower limit of the position switch is a higher value than the upper limit, a position switch parameter error (operation alarm A5, detail 01) occurs upon start of operation.
- The position will be valid after completion of home position return.

API LIBRARY

- Use the `sscChange2Parameter/sscCheck2Parameter` function to set/get the upper limit or lower limit of the position switch.
- To check if position switch (PSW) is ON/OFF, set `SSC_STSBIT_AX_PSW` to the status bit number with the `sscGetStatusBitSignalEx` or `sscWaitStatusBitSignalEx` function.

6. APPLICATION FUNCTIONS

6.16 Completion of operation signal

The completion of operation signal (OPF) shows a completion of operation status. At the startup, the "completion of operation signal" (OPF) turns off, and the "completion of operation signal" (OPF) turns on when positioning operation is complete.

Interruption of operation due to an alarm also turns on the completion of operation signal (OPF).

A summary of operation for each operation mode is shown.

API LIBRARY

- Use the `sscWaitIntDriveFin/sscGetDriveFinStatus` function to check the completion of operation.

(1) Using a JOG operation

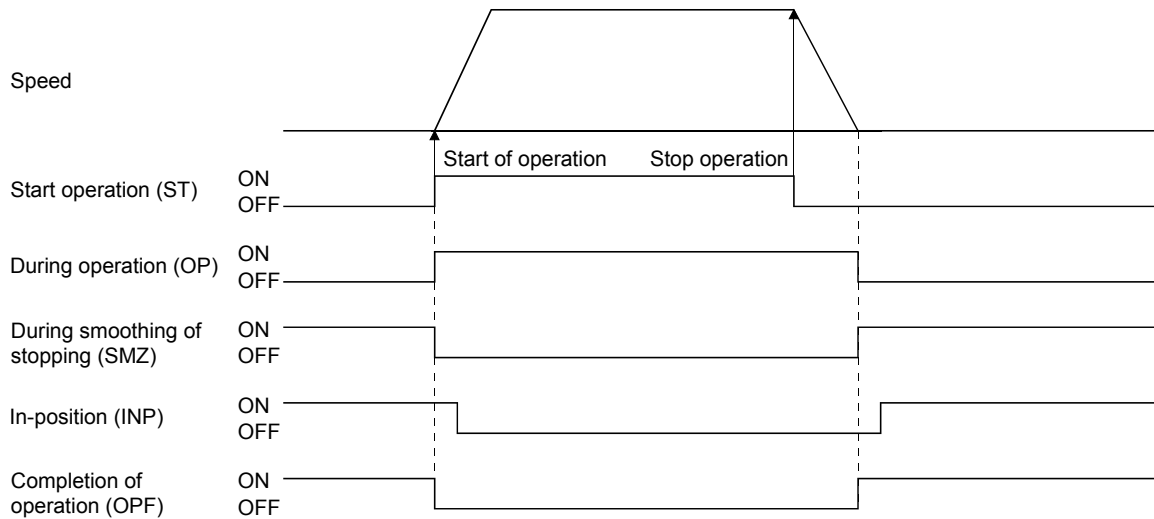

(2) Using incremental feed

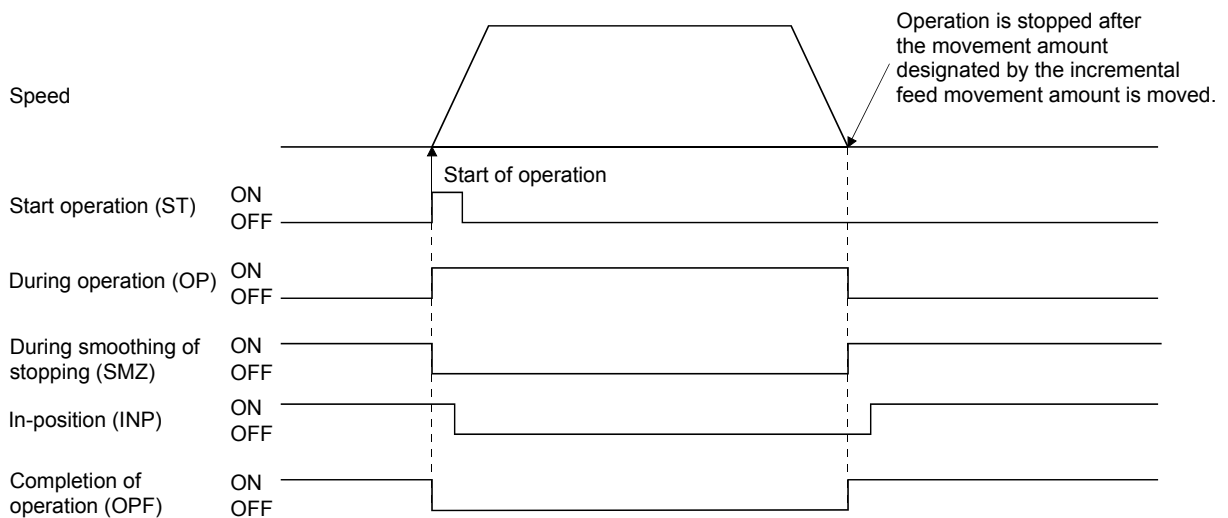

6. APPLICATION FUNCTIONS

(3) Using an automatic operation

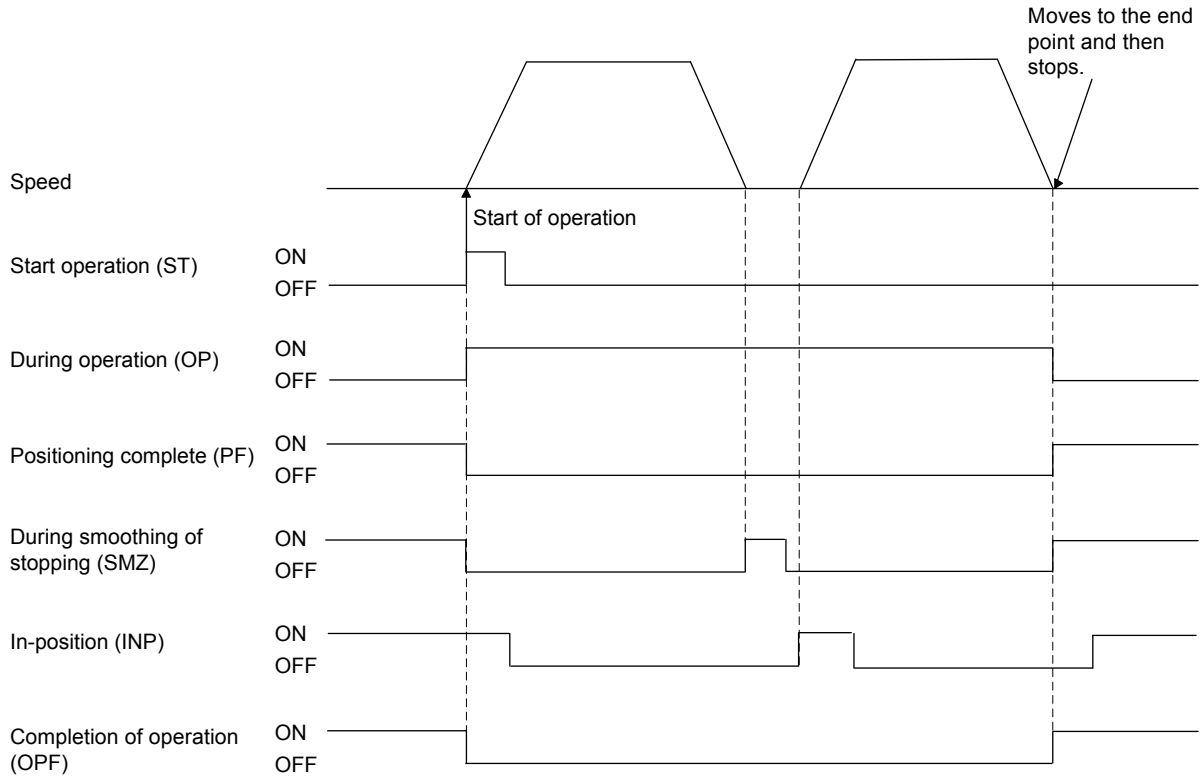

(4) Stop by the stop operation signal

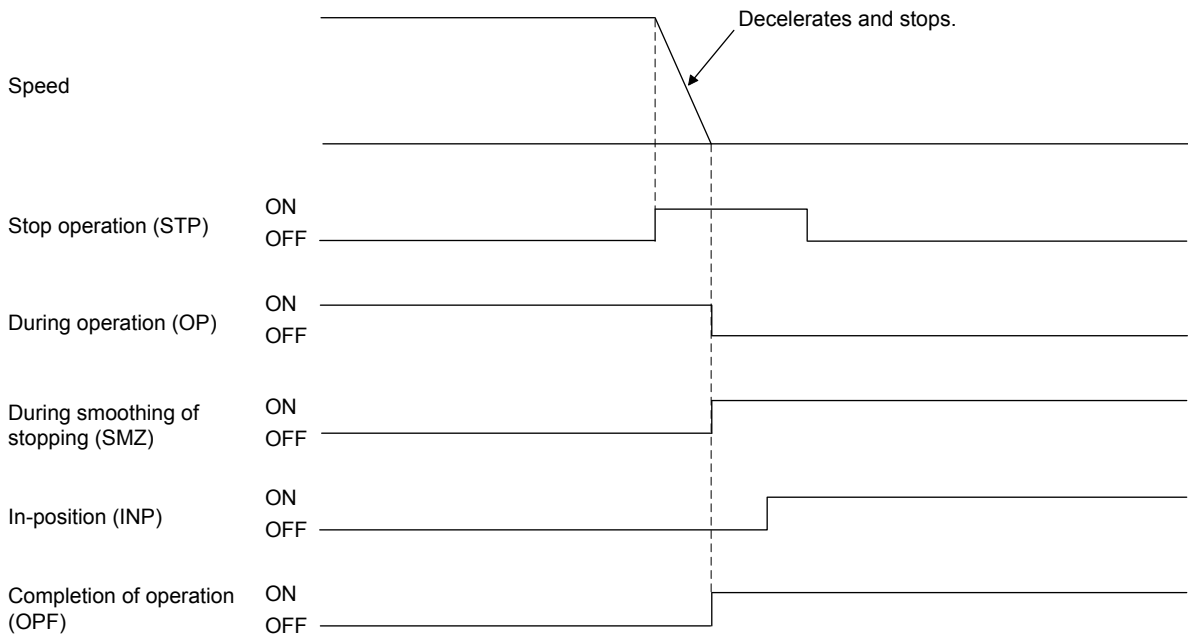

6. APPLICATION FUNCTIONS

(5) Stop by the rapid stop signal

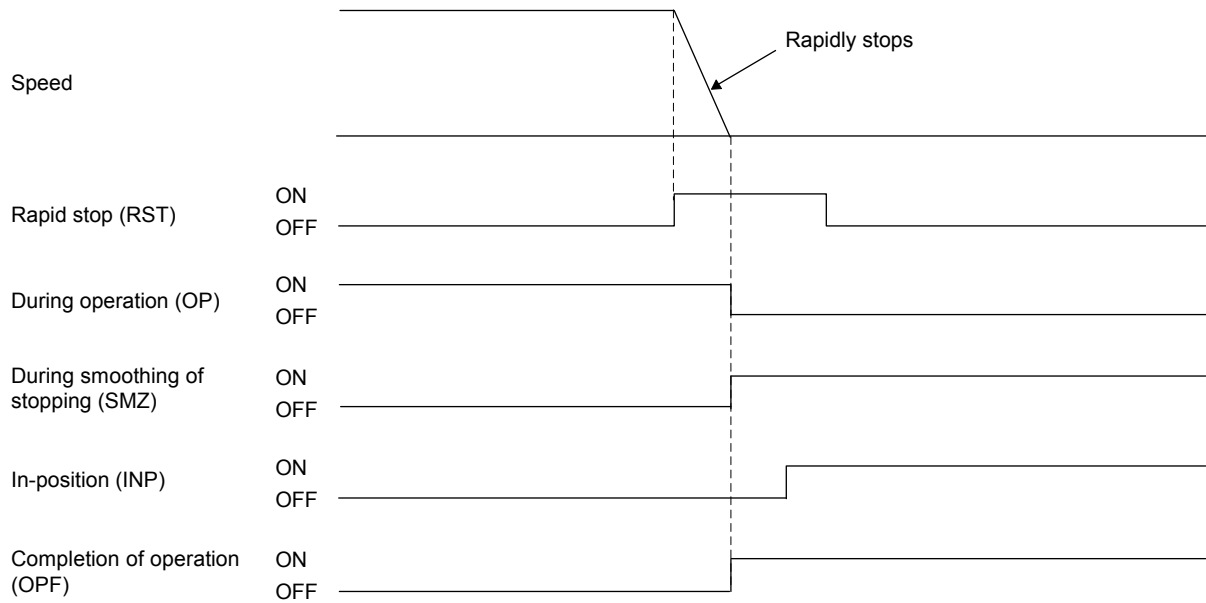

(6) Stop by the limit switch

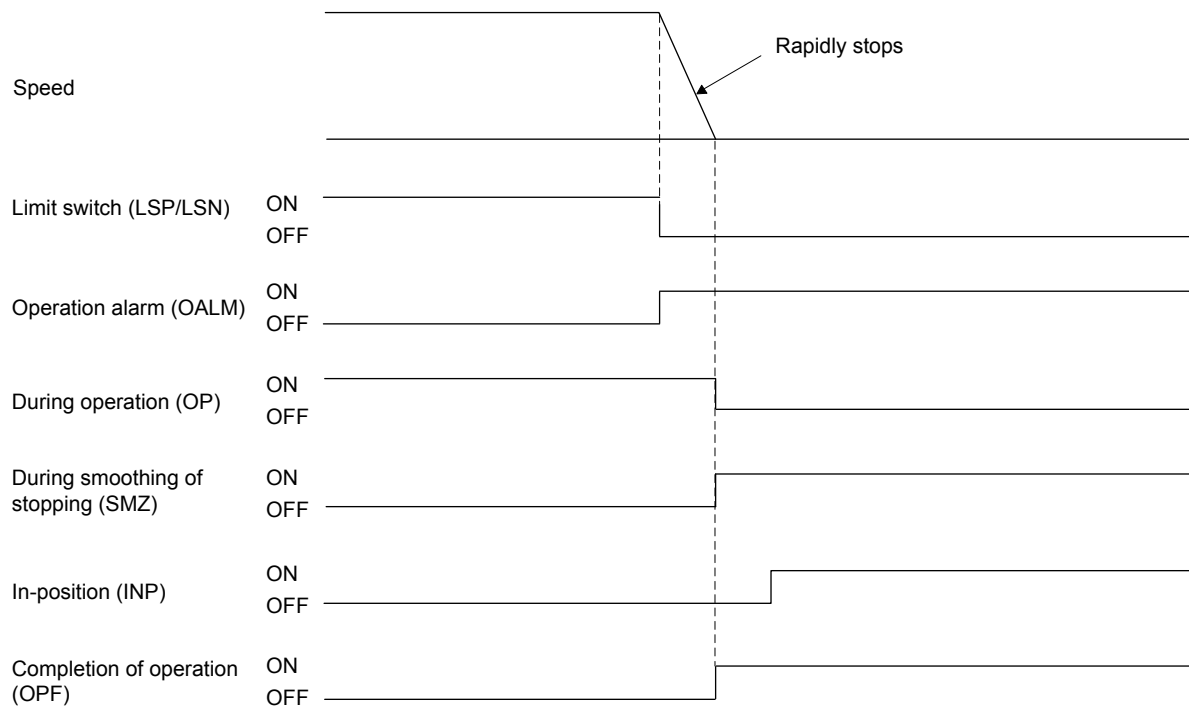

6. APPLICATION FUNCTIONS

(7) Stop by servo alarm occurrence

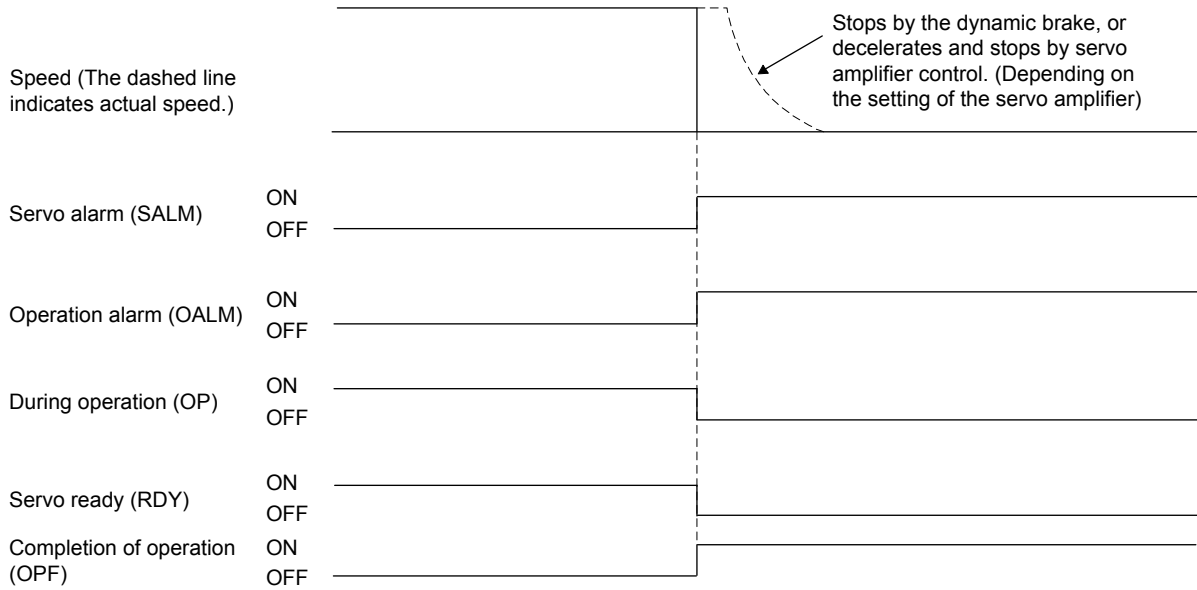

(8) Stop by operation alarm occurrence

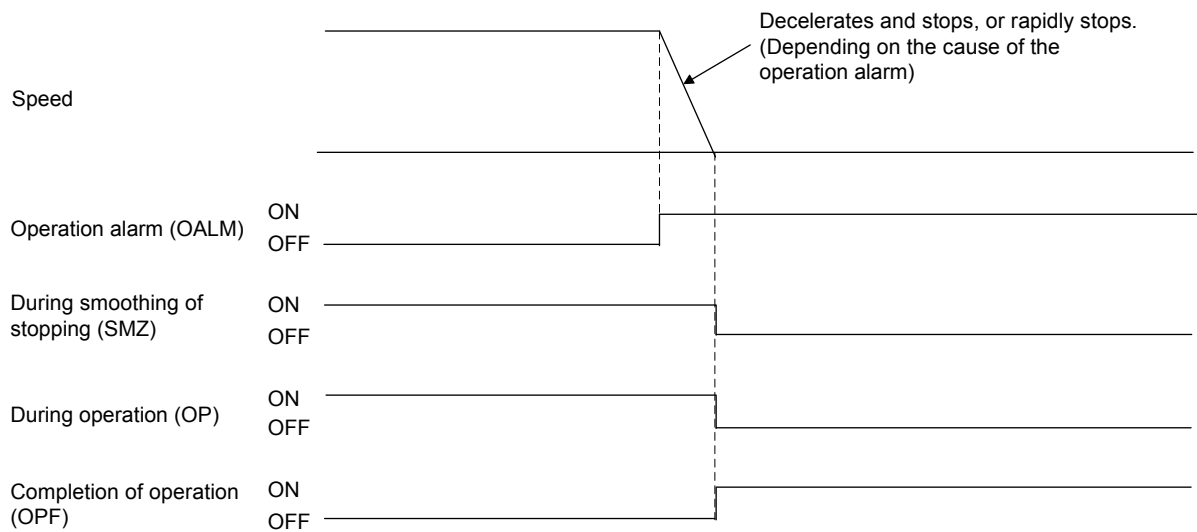

6. APPLICATION FUNCTIONS

(9) Stop by servo off

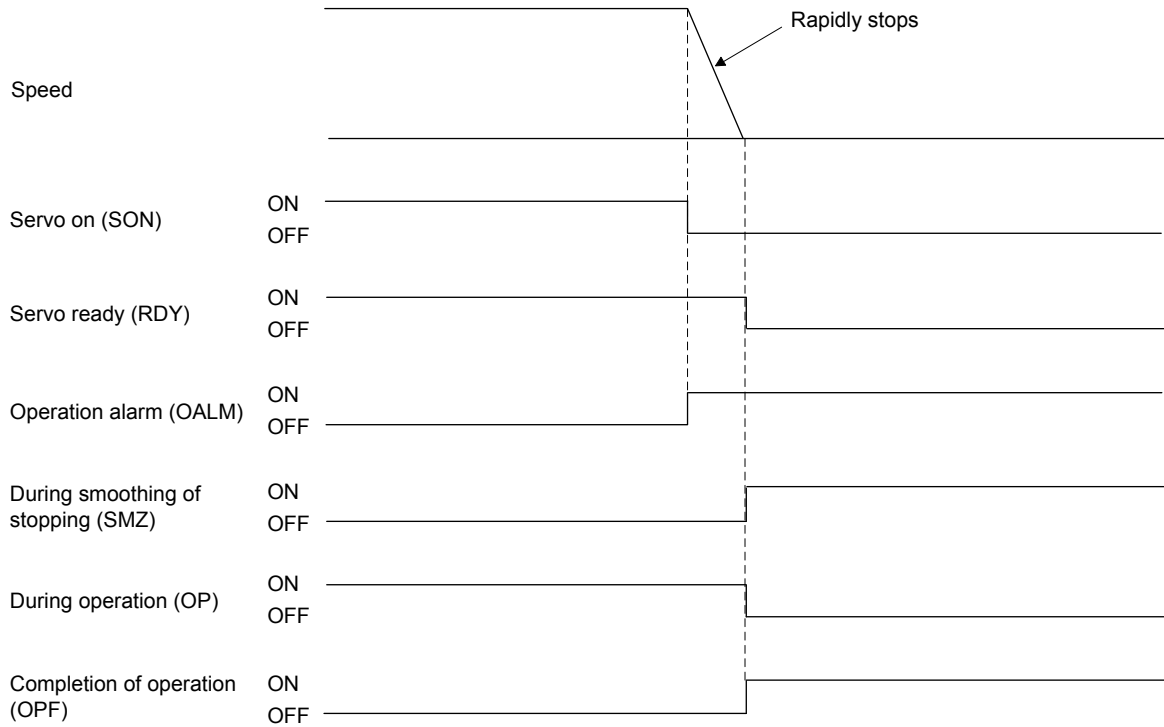

(10) Stop by a software limit (Example: In JOG operation)

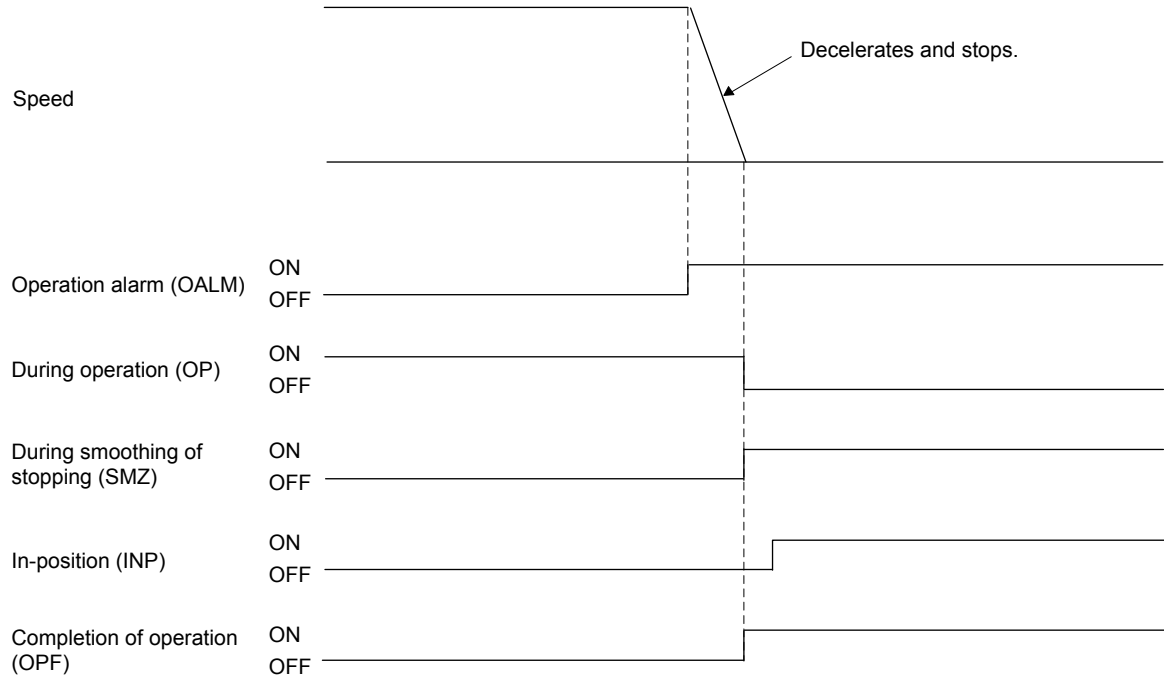

6. APPLICATION FUNCTIONS

(11) Stop by forced stop occurrence

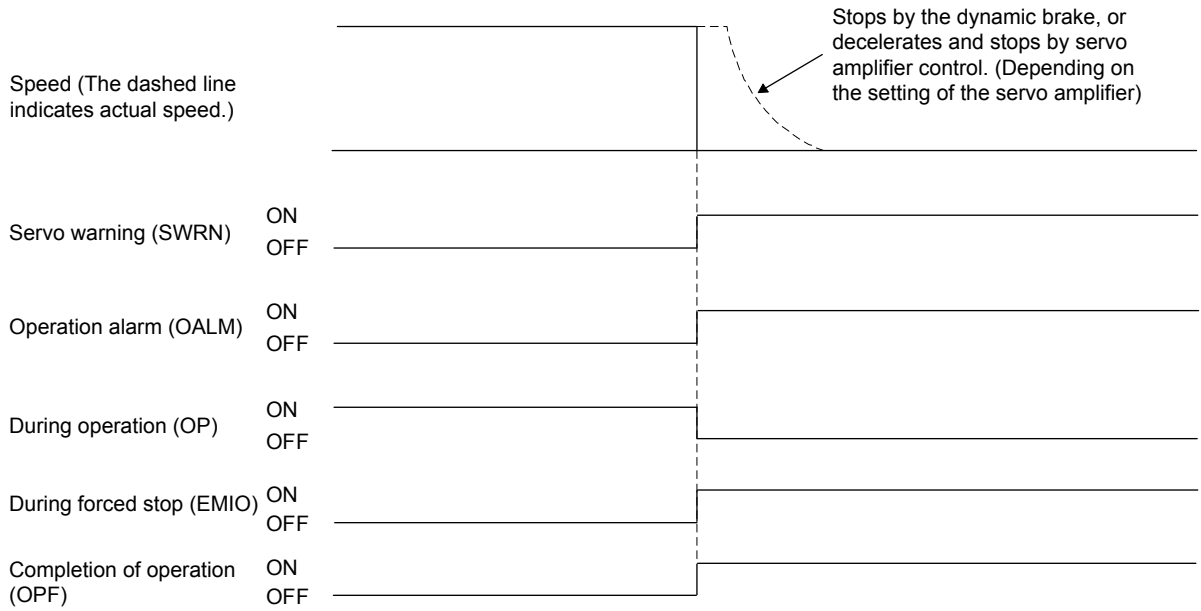

6. APPLICATION FUNCTIONS

6.17 Interference check function

Through setting the standard coordinate system for the interference check function, the current command position of all of the axes and movement direction is changed to the standard coordinate system and interference check using relative position is implemented. Therefore, for data used for change of coordinates, the position and direction of the coordinate system with respect to the home position (where the current command position is 0) standard coordinate system can be set using parameters.

Interference checks are performed when operation is started as well as changing of points and if the target position of positioning of the axis is within the interference check area, a command error in interference area (operation alarm 44, detail 01) is output and start of operation is interrupted.

And, for prevention of collision, the current command position is monitored at all times and if the difference of the current command position of the axis and the interference check axis (relative distance) is less than the width for interference checking, an interference standby error (if moving in the same direction) or an entering to interference area error (operation alarm 45, detail 01) occurs and rapid stop is performed.

POINT

- To validate or invalidate the interference check, use the interference check Options (parameter No.0281). The number of axes for which the interference check can be validated differs depending on the control cycle. Up to 8 axes can be set. When the number is set exceeding the maximum number of axes for which the interference check is valid, the parameter error (operation alarm 37, detail 01) occurs on all the axes for which the interference check is valid.

Control cycle	Maximum number of axes for which the interference check is valid
0.88ms	8
0.44ms	4
0.22ms	0

- Interference check is valid after home position return complete for the axis and interference check.
- Interference standby is only valid for automatic operation, linear interpolation operation and incremental feed. If while in other operation modes, the difference of the current command position of between the axis and the interference check axis is less than the width of interference checking, an entering interference area error (operation alarm 45, detail 01) occurs and rapid stop is performed.
- Interference check is valid only when the travel direction is the same as the interference check direction.

API LIBRARY

- Use the sscChange2Parameter/sscCheck2Parameter function to set/get anything relating to interference check.

6. APPLICATION FUNCTIONS

CAUTION

- When the axis or the interference check axis is free from the control of the Q173SCCF, such as in the following cases, this function may not prevent axes from collision.
 - A servo alarm occurs.
 - In torque limit status
 - The power line is disconnected.
 - In inoperable status due to mechanical factors, etc

6. APPLICATION FUNCTIONS

6.17.1 Interface

(1) Parameter

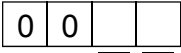
Parameter No.	(Note 1) Abbreviation	Name	Initial Value	Units	Setting range	Function
0281	*IOP	Interference check Options	0000h		0000h to 1FF1h	 <p>Interference check Set validity/invalidity of interference check 0: invalid 1: valid</p> <p>Interference check axis (Note 2, 3, 4) Set the other axis for which interference check is performed 00 to 13h: Interference check axis -1 Example: 0: axis No. 1</p> <p>Interference check coordinate direction Set the direction of the coordinate system for the axis from the perspective of the standard coordinate system 0: Same direction 1: Opposite direction</p>
0282	*IOP2	Interference check Options 2	0000h		0000h to 0011h	 <p>Interference check direction Set the direction for which interference check is performed. 0: + direction of coordinate system for the axis 1: - direction of coordinate system for the axis</p> <p>Interference check standby Set validity/invalidity of interference check standby. 0: Invalid 1: Valid</p>
0284	IOFL	Interference check Offset (lower)	0000h	Command Units	0000h to FFFFh	Set the position on the home position standard coordinate system.
0285	IOFH	Interference check Offset (upper)	0000h		0000h to FFFFh	
0286	IWL	Interference check width (lower)	0000h	Command Units	0000h to FFFFh	Set the width from the interference check axis target position of the area where interference check is performed.
0287	IWH	Interference check width (upper)	0000h		0000h to 7FFFh	

- Note 1. The settings for the parameters with a * mark at the front of the abbreviation are validated when the system is started.
- If the axis No. is set, an interference check axis setting error (operation alarm 43, detail 01) occurs.
 - If an axis in the same linear interpolation group as the axis is set, an interference check axis setting error (operation alarm 43, detail 02) occurs.
 - If axes are designated as tandem drive interference check axes, set up a master axis.

6. APPLICATION FUNCTIONS

6.17.2 Interference check operation image diagram

The following example shows where the direction of the interference check coordinate (the direction of the coordinate system for each axis against the standard coordinate system) is the same direction.

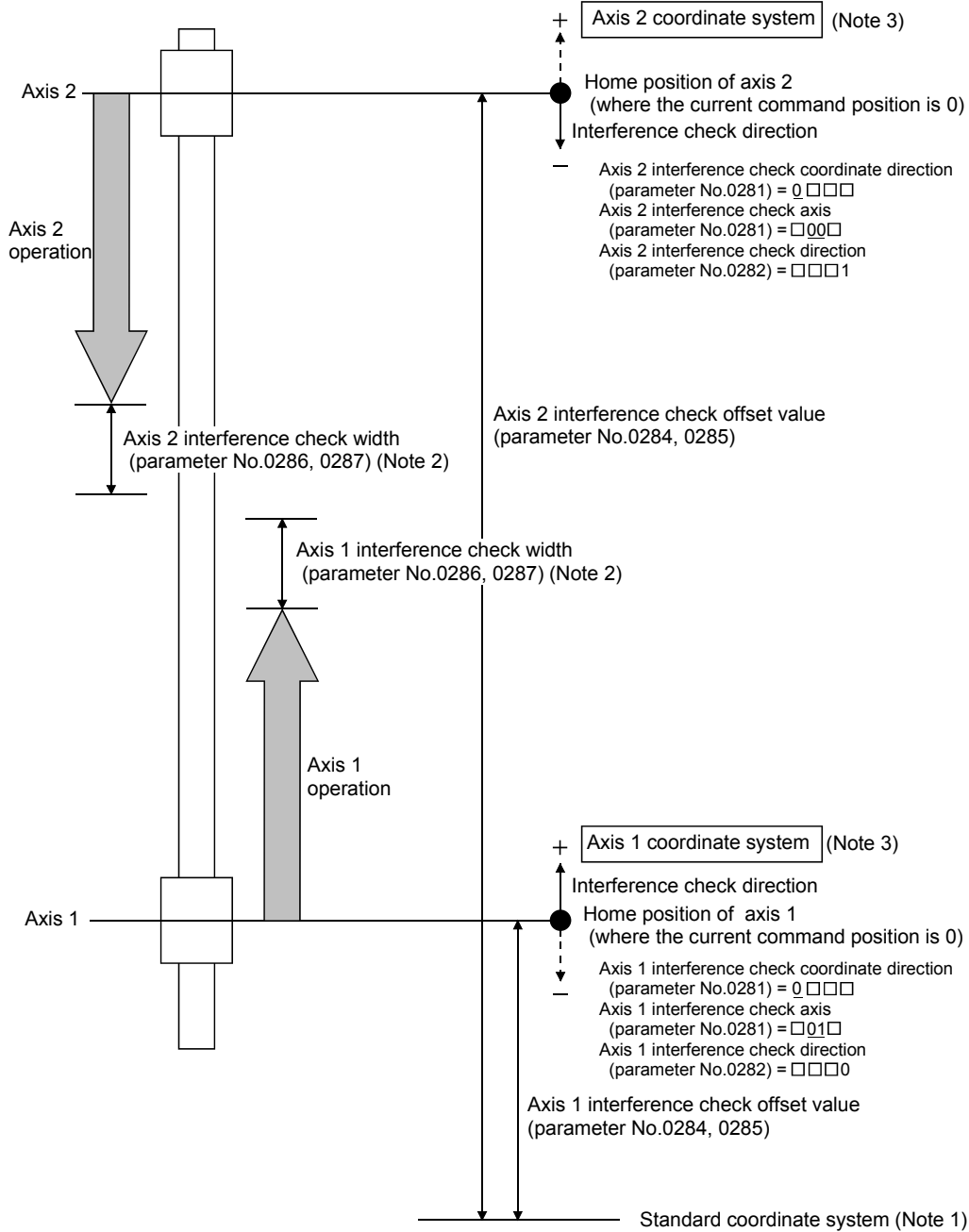

- Note 1. The standard coordinate system is virtual, therefore there are not any parameter settings for the standard coordinate system itself.
2. Make sure to set the interference check width. Normally, the same value occurs for independent axes and for interference check axes.
3. The coordinate system direction is positive (direction to which the coordinate values increase).

POINT
<ul style="list-style-type: none"> Interference check is valid when the travel direction is the same as the interference check direction.

6. APPLICATION FUNCTIONS

6.17.3 Checks prior to start up

The interference check area is the relative distance from the target position of the interference check axis positioning. Interference checks are performed when operation is started as well as changing of points and if the target position of positioning of the axis is not within the interference check area, a command error in interference area (operation alarm 44, detail 01) is output and start of operation is interrupted.

POINT
<ul style="list-style-type: none"> ▪ For the next, check prior to start up is not performed. ▪ When the operation mode is JOG operation, Home position return and data set. ▪ When the axis is stopping for the interference check.

(1) If the interference check axis is moving in the direction such that it is getting closer to the axis.

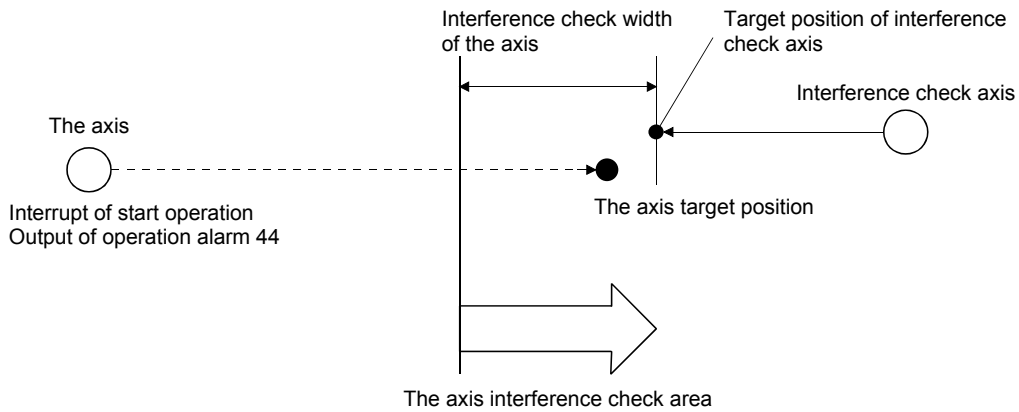

(2) If the interference check axis is moving in the direction such that it is moving away from the axis.

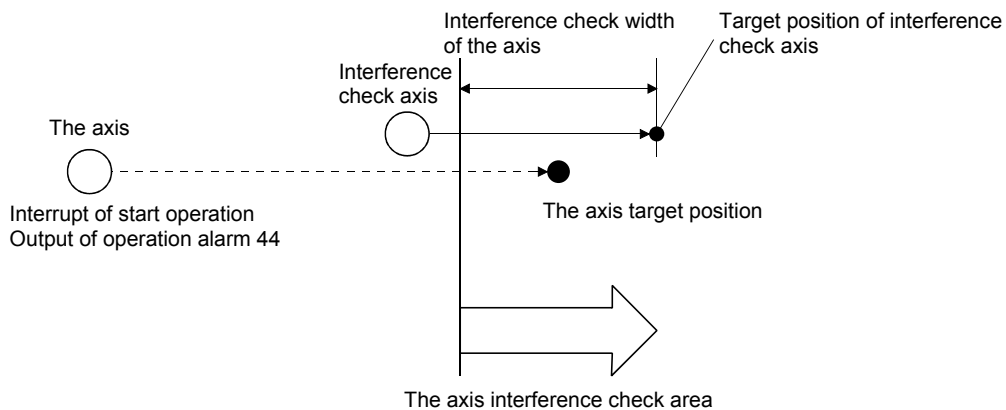

6. APPLICATION FUNCTIONS

6.17.4 Operation check

In order to prevent collision, the current command position is monitored at all times and if the difference between the relative distance of the axis and the interference check axis is judged to be less than the interference check width, rapid stop is executed. The monitored current command position stops, with the travel distance during the rapid stop allowed, so that the distance from the interference check axis does not fall below the interference check width.

(1) If the interference check axis is moving in the relative distance such that it is getting closer to the axis.

If the distance between the axis and the interference check axis is judged to drop below the interference check width, an entering interference area error (operation alarm 45, detail 01) is output and rapid stop is executed. At the same time, an entering interference area error (operation alarm 45, detail 01) also occurs in the interference check axis and rapid stop is executed.

For the interference check width set the settings so that the following equation is true.

$$\text{Interference check width (Lc)} > (\text{Offset from axis one coordinate point to load side}) + (\text{Offset from axis two coordinate point to load side})$$

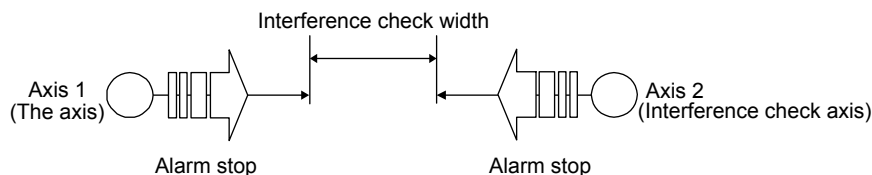

(2) If the interference check axis is moving in the direction such that it is moving away from the axis.

(a) For automatic operation, linear interpolation operation and for using incremental feed

If the distance between the axis and interference check axis is judged to drop below the interference check width while the interference check axis is moving away from the axis and rapid stop is executed. Then, whether to cancel the operation or to restart the operation automatically by conditions can be selected in Interference check standby (parameter No.0282).

1) When Interference check standby is invalid

If the distance between the axis and interference check axis is judged to drop below the interference check width while the interference check axis is moving away from the axis, output an extending to interference area error (operation alarm 45, detail 01) and execute and rapid stop is executed. At the same time, an entering interference area error (operation alarm 45, detail 01) also occurs in the interference check axis and rapid stop is executed.

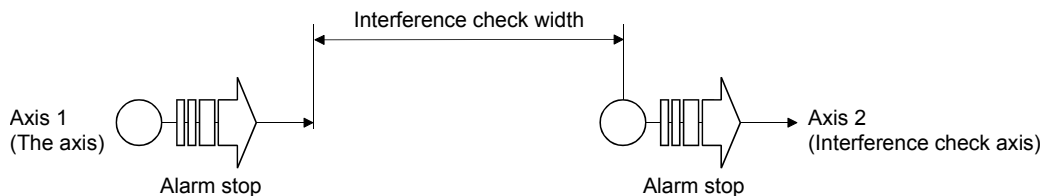

6. APPLICATION FUNCTIONS

2) When Interference check standby is valid

If the distance between the axis and interference check axis is judged to drop below the interference check width while the interference check axis is moving away from the axis, turn the during interference check standby signal (IWT) for the axis on and rapid stop is executed. When the distance between the axis and the interference check axis exceeds the interference check width, operation is automatically resumed and the machine resumes moving to the target position.

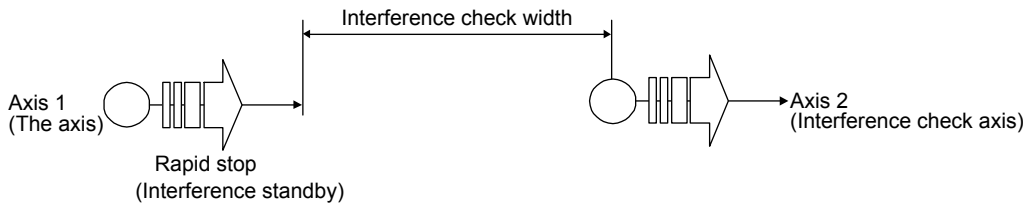

POINT

- If the interference check axis stops due to an alarm etc. during interference standby, an entering interference area error (operation alarm 45, detail 01) occurs and operation is terminated.

(b) For other than automatic operation, linear interpolation operation and incremental feed

If the distance between the axis and interference check axis is judged to drop below the interference check width while the interference check axis is moving away from the axis, an extending to interference area error (operation alarm 45, detail 01) is output and rapid stop is executed. At the same time, an entering interference area error (operation alarm 45, detail 01) also occurs in the interference check axis and rapid stop is executed.

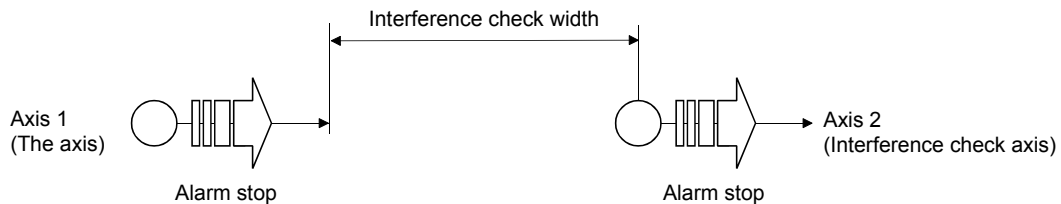

6. APPLICATION FUNCTIONS

(3) While the interference check axis is stopped

If the distance between the axis and the interference check axis is judged to drop below the interference check width, an entering interference area error (operation alarm 45, detail 01) is output and rapid stop is executed. At the same time, an entering interference area error (operation alarm 45, detail 01) also occurs in the interference check axis.

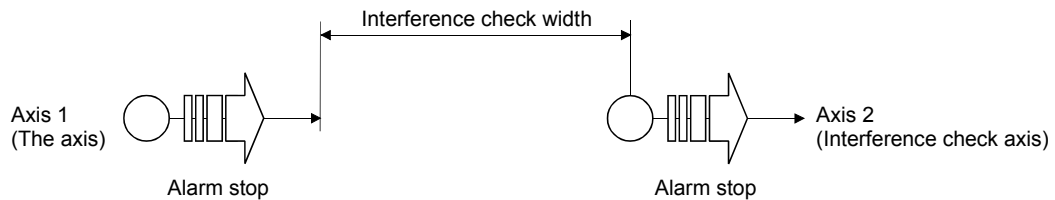

The position information for the interference check axis used for making judgement to prevent collision is the following.

- (a) If the interference check axis is getting closer to the axis
Perform the check using current command position.
- (b) If the interference check axis is getting further away from the axis
Perform the check using current feedback position.
- (c) While the interference check axis is stopped
Perform the check using current feedback position.

6. APPLICATION FUNCTIONS

6.18 Home position search limit

6.18.1 Summary

The home position search limit function is that while returning to home position, through movement operation in the opposite direction of home position return, if the movement exceeds the parameter set for the home position search limit (parameter No.024A, 024B), a home position search limit error (operation alarm 98, detail 01) occurs and home position return operation is terminated. It is a function used to prevent unexpected operation in case the dog signal and limit switch cannot detect correctly due to a failure. The home position search limit function is valid for the following home position return methods.

- (1) Home position return using a dog method
- (2) Home position return using the dog cradle method
- (3) Home position return using a limit switch combined method
- (4) Home position return using a limit switch front end method
- (5) Home position return using a dog front end method
- (6) Home position return using a scale home position signal detection method
- (7) Home position return using a scale home position signal detection method 2

6.18.2 Set items

The following items are set for using the home position search limit function.

Parameter No.	Name	Abbreviation	Units	Setting range	Initial Value	Remarks
024A	Home position search limit (lower)	ZLL	Command Units	0000h to FFFFh	0000h	Set a limit on the movement amount when searching for the home position. If the setting for the home position search limit is 0, this function does not operate.
024B	Home position search limit (upper)	ZLH		0000h to 7FFFh	0000h	

API LIBRARY

- Use the sscChange2Parameter/sscCheck2Parameter function to set/get the home position search limit.

6. APPLICATION FUNCTIONS

6.18.3 Home position search limit operation example

- (1) For home position return using a dog cradle method (example: when the turning off of the proximity dog can not be detected)

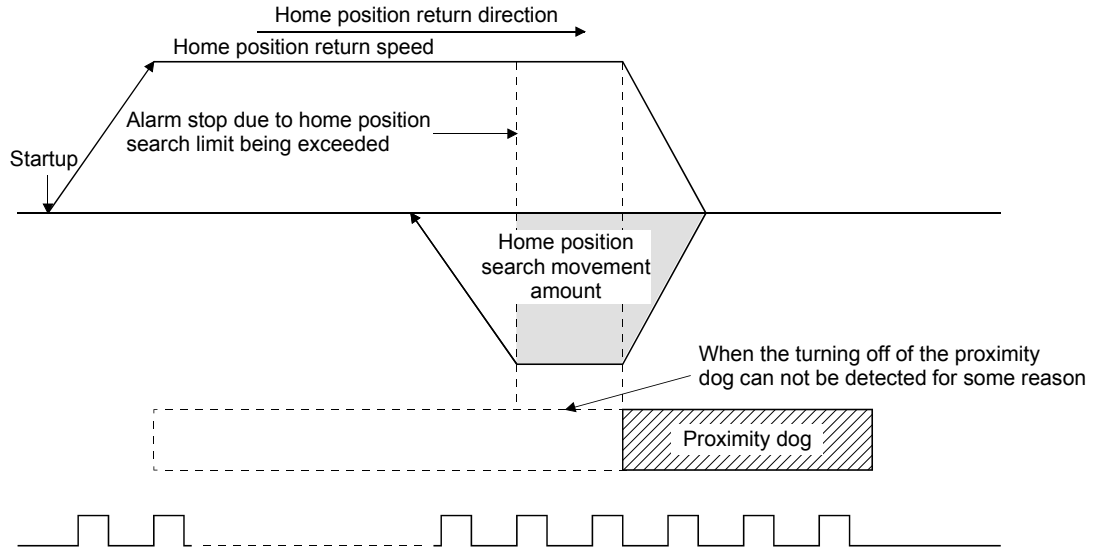

- (2) For home position return using a limit switch combined method (example: when the limit switch is not released)

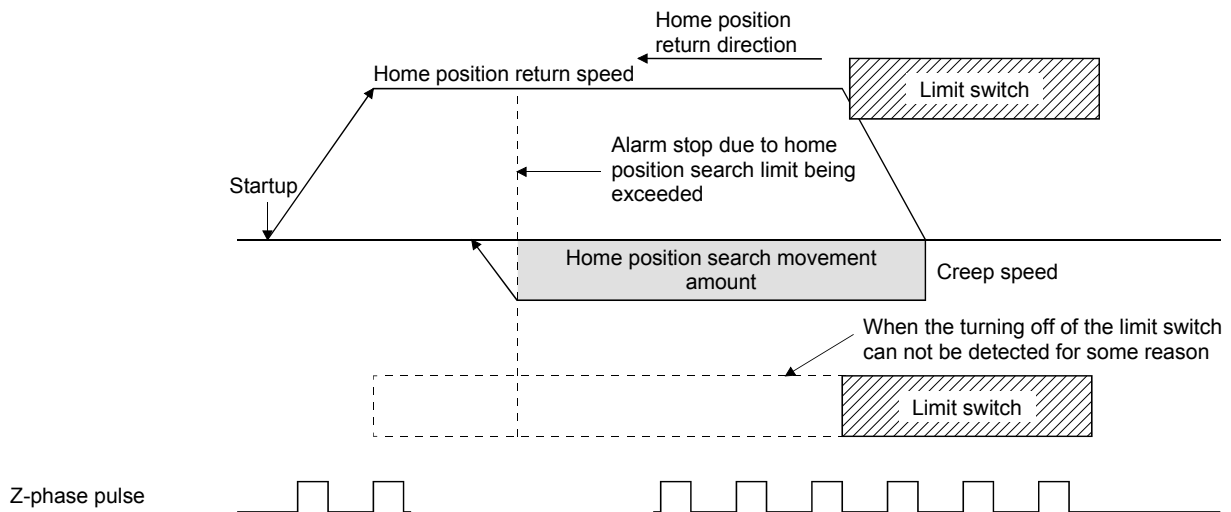

6. APPLICATION FUNCTIONS

6.19 Gain changing

Through turning on the gain changing command signal (GAIN), the gain for the servo amplifier can be changed. This is used to change the gain during revolution and while stopped, as well as changing gain proportional to amount of movement or speed. When the gain changing function is used, set the following servo parameters.

For servo parameters (MR-J4(W□)-□B)

Parameter No.	MR-J4-B Parameter No.	Abbreviation	Name	Setting value
1159	PB26	*CDP	Gain switching function	Arbitrary within setting range
115A	PB27	CDL	Gain switching condition	Arbitrary within setting range
115B	PB28	CDT	Gain switching time constant	Arbitrary within setting range
115C	PB29	GD2B	Gain switching ratio of load inertia moment/load mass ratio	Arbitrary within setting range
115D	PB30	PG2B	Gain switching position control gain	Arbitrary within setting range
115E	PB31	VG2B	Gain switching speed control gain	Arbitrary within setting range
115F	PB32	VICB	Gain switching speed integral compensation	Arbitrary within setting range
1160	PB33	VRF11B	Gain switching vibration suppression control 1 vibration frequency setting	Arbitrary within setting range
1161	PB34	VRF12B	Gain switching vibration suppression control 1 resonance frequency setting	Arbitrary within setting range
1162	PB35	VRF13B	Gain switching vibration suppression control 1 vibration frequency dumping setting	Arbitrary within setting range
1163	PB36	VRF14B	Gain switching vibration suppression control 1 resonance frequency setting	Arbitrary within setting range
1177	PB56	VRF21B	Gain switching vibration suppression control 2 vibration frequency setting	Arbitrary within setting range
1178	PB57	VRF22B	Gain switching vibration suppression control 2 resonance frequency setting	Arbitrary within setting range
1179	PB58	VRF23B	Gain switching vibration suppression control 2 vibration frequency dumping setting	Arbitrary within setting range
117A	PB59	VRF24B	Gain switching vibration suppression control 2 resonance frequency setting	Arbitrary within setting range
117B	PB60	PG1B	Gain switching model loop gain	Arbitrary within setting range

POINT

- Refer to the Servo Amplifier Instruction Manual on your servo amplifier concerning details for the servo parameters.
- To use the gain switching function, first set the gain adjustment mode to a manual mode by changing an auto-tuning mode (parameter No.1107) to 3 (manual mode). If the gain adjustment mode is in an auto-tuning mode, the gain changing function cannot be used.

API LIBRARY

- To turn ON/OFF the gain changing command (GAIN), set SSC_CMDBIT_AX_GAIN to the command bit number of the sscSetCommandBitSignalEx function.
- To check if during gain switching (GAINO) is ON/OFF, set SSC_STSBIT_AX_GAINO to the status bit number with the sscGetStatusBitSignalEx or sscWaitStatusBitSignalEx function.

6. APPLICATION FUNCTIONS

A timing chart using for gain changing is shown below.

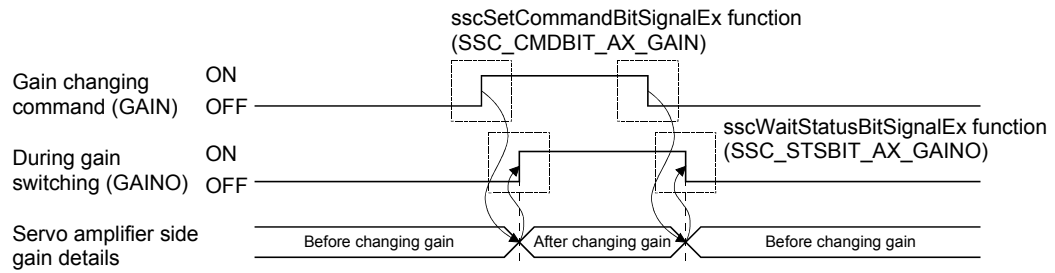

6. APPLICATION FUNCTIONS

6.20 PI-PID switching

By turning on the PID control command signal (CPC), control of the servo amplifier is changed to PID control from PI control. Use this function, for example, to remove any interference (torsion) between tandem drive axes by operating an axis (slave axis) under PID control. When using the PI-PID switching function, set the following servo parameters.

For servo parameter (MR-J4(W□)-□B)

Parameter No.	MR-J4-B Parameter No.	Abbreviation	Name	Setting value
1157	PB24	*MVS	Slight vibration suppression control	<input type="checkbox"/> <input type="checkbox"/> <input type="checkbox"/> (PI control is valid (can be switched to PID control by the command from controller).)

POINT

- Refer to the Servo Amplifier Instruction Manual on your servo amplifier concerning details for the servo parameters.
- To use the PI-PID switching function, first set the gain adjustment mode to a manual mode by changing an auto-tuning mode (parameter No.1107) to 3 (manual mode). If the gain adjustment mode is in an auto-tuning mode, the PI-PID switching function cannot be used.

API LIBRARY

- To turn ON/OFF the PI-PID switching command (CPC), set SSC_CMDBIT_AX_CPC to the command bit number of the sscSetCommandBitSignalEx function.
- To check if during PID control (SPC) is ON/OFF, set SSC_STSBIT_AX_PID to the status bit number with the sscGetStatusBitSignalEx or sscWaitStatusBitSignalEx function.

A timing chart using for PI-PID switching is shown below.

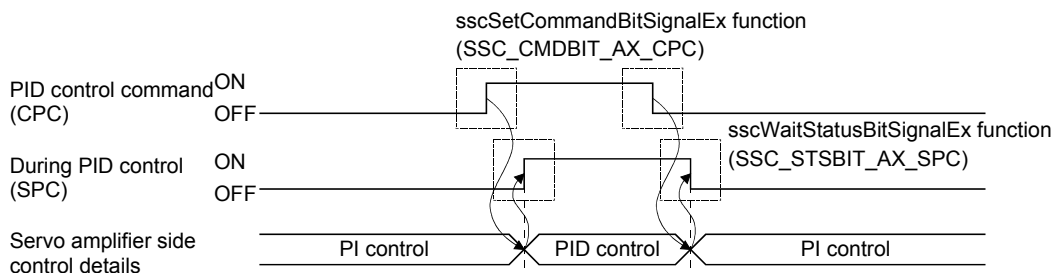

6. APPLICATION FUNCTIONS

6.21 Absolute position detection system

By using a servo motor compatible with the absolute position detection system, the positioning control can be made by the absolute position detection system.

In the absolute position detection system, if machinery position is determined at the system startup, there is no need to execute the home position return because the absolute position is restored at system startup.

Determination of machinery position is made by the home position return. At home position return and power on, be sure to execute the operation referring to the procedures described in Section 6.21.2.

API LIBRARY

- Use the sscChange2Parameter/sscCheck2Parameter function to set/get the absolute position detection system.

6.21.1 Parameters

The parameters related to the absolute position detection system are shown below.

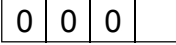
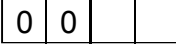
Parameter No.	(Note) Abbreviation	Name	Initial value	Unit	Setting range	Function
1102	*ABS	Absolute position detection system	0000h		0000h to 0001h	 <p>Absolute position detection system selection 0: Used in incremental system 1: Used in absolute position detection system</p>
0241	*OPZ2	Home position return option 2	0000h		0000h to 0011h	 <p>Absolute position data Set the validity/invalidity of restoring the absolute position. 0: Invalid 1: Valid When 1 is set, the absolute position is restored at system startup, based on the home position multiple revolution data and the home position within 1 revolution position. When 0 is set, the position at system startup is defined to be 0. Perform the home position return prior to automatic operation and linear interpolation. Change of absolute position data on home position reset</p>
024D	*LS0	Home position multiple revolution data	0000h	rev	0000h to FFFFh	Set the home position multiple revolution data.
024E	*CY0L	Home position within 1 revolution position (lower)	0000h	pulse	0000h to FFFFh	Set the within 1 revolution home position.
024F	*CY0H	Home position within 1 revolution position (upper)	0000h		0000h to FFFFh	

Note. The settings for the parameters with a * mark at the front of the abbreviation are validated when the system is started.

6. APPLICATION FUNCTIONS

6.21.2 Processing procedure

Be sure to execute the operation referring to the following procedures at home position return and power on.

(1) Processing procedure for returning to home position

- (a) Set the absolute position detection system (parameter No.1102) to 1 (Use in absolute position detection system).
- (b) If setting the parameter in (a) for the first time, "absolute position erased" (servo alarm 25) occurs. After turning OFF the power supply of servo amplifier, turn power supply ON again and start the system again.
- (c) Execute home position return.
- (d) When the home position return is completed, the home position return request (ZREQ) turns off and the home position return complete signal (ZP) turns on. Then the home position multiple revolution data (parameter No.024D) and the home position within 1 revolution position (parameter No.024E, 024F) are updated, and the absolute position data of the home position return option 2 (parameter No.0241) is changed to 1 (valid).
- (e) After confirming the home position return complete signal (ZP) is on, read the home position multiple revolution data (parameter No.024D) and home position within 1 revolution position (parameter No.024E, 024F) and store a backup copy.

(2) Processing procedure for turning on the power

After executing backup of the position of the home position at (1), execute the following processing before system startup (before setting the system directive code to 000Ah). Performing of this process restores the system to absolute positioning at system startup.

- (a) Set the home position multiple revolution data and home position within 1 revolution position stored during backup of (1) to the home position multiple revolution data (parameter No.024D) and home position within 1 revolution position (parameter No.024E, 024F).
- (b) Set the absolute position data of the home position return option 2 (parameter No.0241) to 1 (valid).

6. APPLICATION FUNCTIONS

(3) Cautions for use of absolute position detection system

In the case of the following (a) to (f), the absolute position erased signal (ABSE) is turned on and the absolute position data of the home position return option 2 (parameter No.0241) is changed to 0 (invalid). Furthermore, the servo is not yet finished with home position return, and the home position return request (ZREQ) turns on. Therefore when performing automatic operation, execute home position return again. (In cases other than (a))

POINT
<ul style="list-style-type: none"> ▪ If the absolute position erased signal (ABSE) is turned on, re-execute home position return and read the home position multiple revolution data and home position within one-revolution position.

- (a) When parameters related to the home position return (parameter No.0240, 0246 to 0249, and 024D to 024F), electronic gear (parameter No.020A to 020D), and rotation direction selection (parameter No.110D) are changed. (For software version A5 or later, absolute position erased signal (ABSE) does not turn ON when parameter No.0240 is changed.)
- (b) If "absolute position erased " (servo alarm 25) or "absolute position counter warning" (servo alarm E3) occurs, note that these alarms will be cleared by servo amplifier power OFF/ON.
- (c) Parameter error (servo alarm 37) occurs.
- (d) The setting value for "home position multiple revolution data" (parameter No.024D) or "home position within 1 revolution position" (parameter No.024E, 024F) is incorrect and overflow in calculating absolute position restoration occurs.
- (e) "Tandem drive synchronous valid width error" (operation alarm No.54, detail 01) or "Tandem drive synchronous alignment error" (operation alarm 58, detail 01) occurs.
- (f) Electronic gear setting error (system error E500) occurs. This error causes a forced stop status to prevent operation. Reexamine the setting of an electronic gear and start the system again.

POINT
<ul style="list-style-type: none"> ▪ The position after startup (restoration of absolute position) is determined using the following. $\begin{aligned} \text{Restoration absolute position (pulse)} = & \text{(within 1 revolution position at system startup} \\ & - \text{home position within 1 revolution position)} \\ & + \text{(multiple revolution data at system startup} \\ & - \text{home position multiple revolution data)} \\ & \times \text{number of encoder pulses per revolution} \end{aligned}$ $\begin{aligned} \text{Restoration absolute position (command unit)} = & \text{restoration absolute position (pulse)} \\ & \times \text{reciprocal of number of electronic gears (Note)} \\ & + \text{home position coordinate} \end{aligned}$ <p>Note. reciprocal of number of electronic gears = electronic gear denominator (CDV)/electronic gear numerator (CMX)</p>

6. APPLICATION FUNCTIONS

6.21.3 Sequence example

Prepare a home position return complete memo showing that the home position has been established on the user program. Turn the home position return complete memo on when home position return is complete. When the home position return complete memo is turned on, execution of home position return is not necessary. If the absolute position erased signal (ABSE) is turned on, turn the home position return complete memo off, and re-execute home position return.

(1) Startup procedure

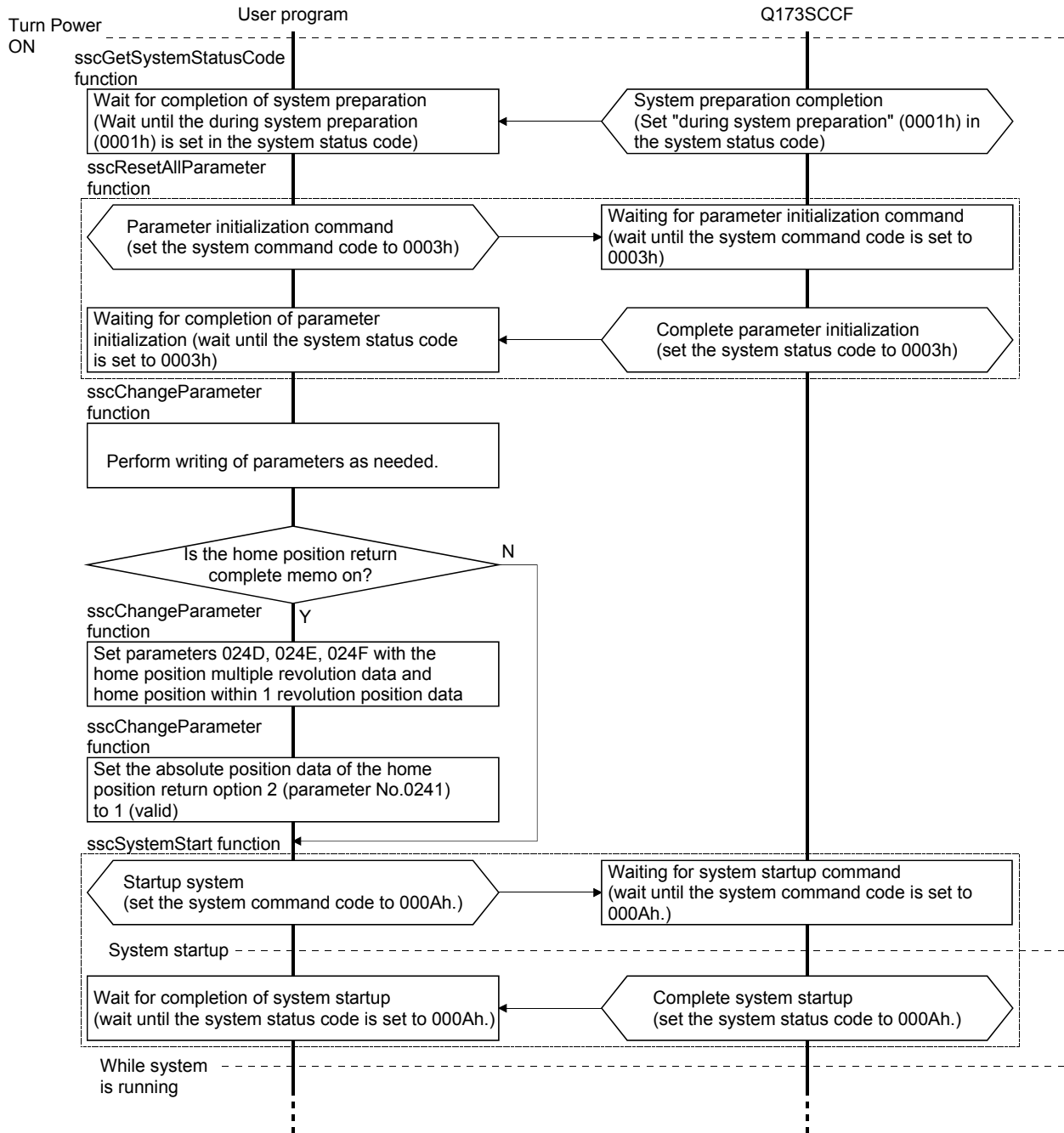

6. APPLICATION FUNCTIONS

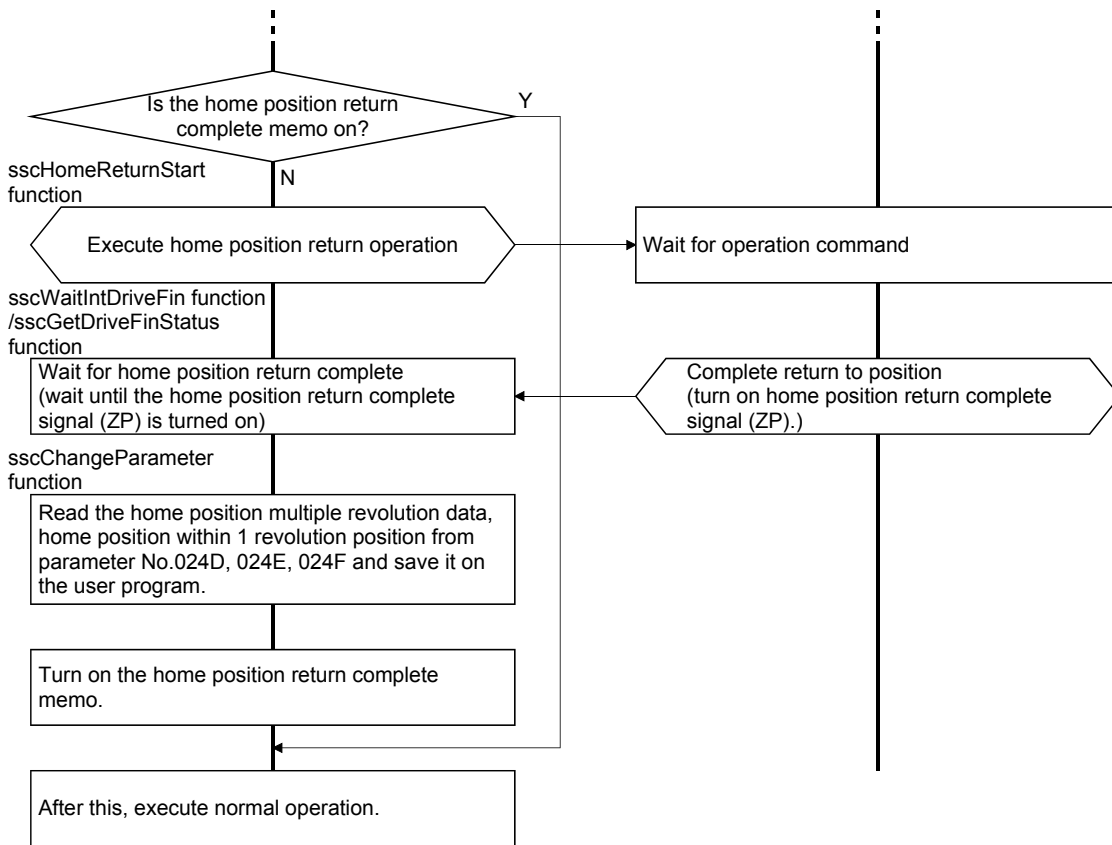

(2) Procedure for when absolute position disappears.

If the absolute position erased signal (ABSE) is turned on, turn off the home position return complete memo being held at the user program.

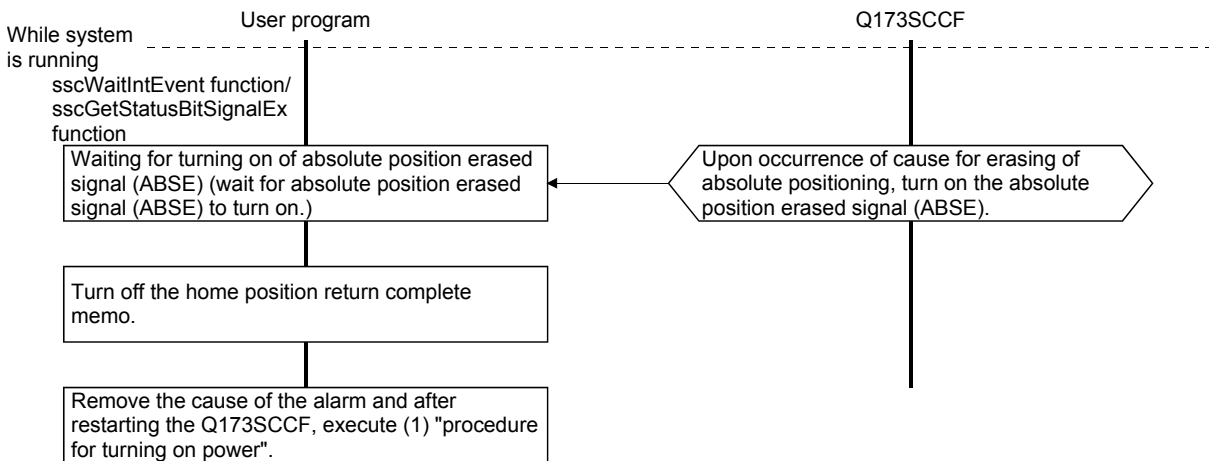

6. APPLICATION FUNCTIONS

6.22 Home position return request

The home position return request (ZREQ) shows the home position return incomplete status. In the home position return incomplete status, the home position return request (ZREQ) turns on. When it is necessary to determine the home position, perform the home position return. When the home position return is completed properly and the home position is determined, the home position return request (ZREQ) turns off.

(1) Axis status bit

Address (Note)	Bit	Abbreviation	Signal name	When tandem drive is being used
1064	0	ISTP	Interlock stop	Master
	1	RMRCH	High speed monitor is latched	Each axis
	2	POV	Stop position over-bound	Master
	3	STO	Start up acceptance complete	Master
	4		Reserved	
	5			
	6	ZREQ	Home position return request	Master
7		Reserved		

Note: The address is for the axis 1. For the axis 2 and above, increase in units of C0h for each axis.

Example: Dog method home position return

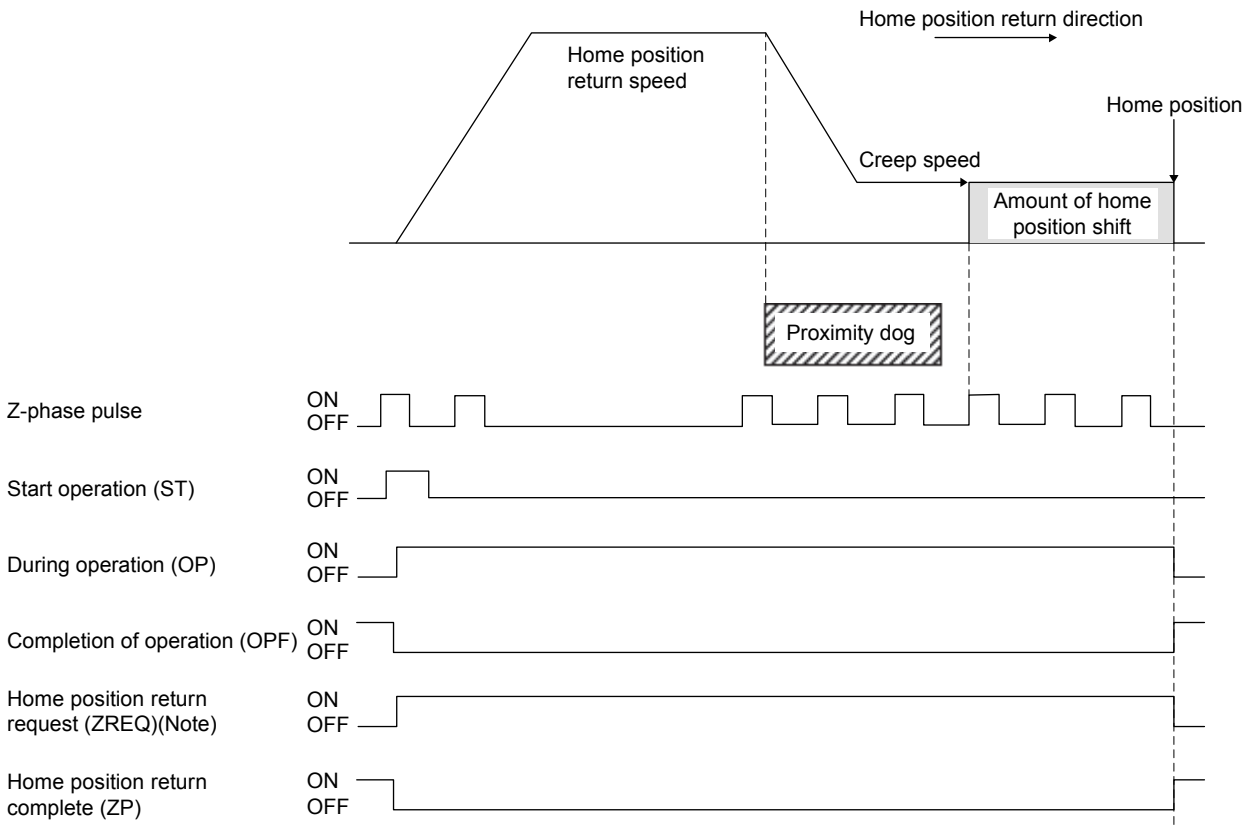

Note. The home position return request (ZREQ) turns on when a home position return starts.

API LIBRARY

- To check if home position return request (ZREQ) is ON/OFF, set SSC_STSBIT_AX_ZREQ to the status bit number with the sscGetStatusBitSignalEx or sscWaitStatusBitSignalEx function.

6. APPLICATION FUNCTIONS

(2) The following shows the conditions for the home position return request (ZREQ) to turns on/off.

(a) At system startup

1) Condition of turning on

- a) When the axis is a tandem drive axis and does not have home position (parameter No.0200).
- b) When "absolute position erased" (servo alarm 25) or "absolute position counter warning" (servo alarm E3) occurs
- c) The setting value for "home position multiple revolution data" (parameter No.024D) or "home position within 1 revolution position" (parameter No.024E, 024F) is incorrect and overflow in calculating absolute position restoration occurs
- d) When parameter error (servo alarm 37) occurs
- e) When electronic gear setting error (system error E500) occurs
- f) When setting of absolute position data (parameter No.0241) is invalid and system is startup

2) Condition of turning off

- a) When the absolute position is restored properly at the use of the absolute position detection system
- b) When the axis is a monopodium (not a tandem drive axis) and does not have home position (parameter No.0200)

(b) While system is running

1) Condition of turning on

- a) When home position return is started
- b) "Tandem drive synchronous valid width error" (operation alarm No.54, detail 01) or "Tandem drive synchronous alignment error" (operation alarm 58, detail 01) occurs
- c) When "Condition of turning ON at system startup" ((a) 1)) is satisfied at SSCNET reconnection

2) Condition of turning off

- a) When home position return is completed properly

(3) The following shows the restrictions at home position return incomplete status (home position return request (ZREQ): ON).

(a) Operational functions

Automatic operation, linear Interpolation and home position reset are unavailable. At start operation, home position return not complete (operation alarm 90, detail 01) occurs and start operation is canceled.

(b) Application functions

Software limit, rough match output, backlash, position switch and interference check function are invalid.

(c) Tandem drive

Synchronization for turning servo on is not performed.

6. APPLICATION FUNCTIONS

6.23 Other axes start

6.23.1 Summary

The other axes start function is a function that automatically performs the start operation for other axes, and turns on/off the digital output signal or output device signal according to the conditions for starting other axes (start conditions) and other axes start data consisting of operation (operation content) that is performed when the conditions are satisfied. When using the other axes start, set the other axes start data No. (1 to 32) to the other axes start specification of the point table.

The start operation for other axes internally turns on the start operation signal (ST). Therefore, before the start operation, set the operation mode and the point table for an axis for which the other axes start is performed.

This function can only be used in automatic operation and linear interpolation operation.

⚠ CAUTION

- If the digital output signal is updated from the user program during controlling of the digital output signal by the other axes start function, the consistency of the data may not be kept. This condition is applied to the case when the C Controller module and Q173SCCF update the data at the same time to the same digital output area number. In this case, read/write the digital output signal after controlling the possessory right of the digital output signal using the exclusive control function. For the output device signal, use the exclusive control function to perform exclusive control in the same way.

6.23.2 Settings

When using the other axes start function, set the following data.

POINT
<ul style="list-style-type: none">▪ <u>When "1: Specified position pass specification" is set to the axis judgment condition, a specified position opposite from the movement direction is judged to be already passed, and therefore the condition is satisfied at the start operation.</u>▪ For tandem drive axes, set this function for the master axes. This function does not operate when set to the slave axis. However, the slave axis can be set as a observed axis.

6. APPLICATION FUNCTIONS

(1) Point table

Set the other axes start data No. for the other axes start specification.

POINT	
<ul style="list-style-type: none"> The setting range of the other axes start data No. differs depending on the control cycle. A maximum of 1 to 32 can be set. When the setting is out of the range of the valid other axes start data No., it causes a point table setting error (operation alarm 25, detail 09). 	
Control cycle	Valid other axes start data No.
0.88ms	1 to 32
0.44ms	1 to 16
0.22ms	1 to 8

API LIBRARY	
<ul style="list-style-type: none"> Use the sscSetPointDataEx/sscCheckPointDataEx functions to set/get point table. For a detailed procedure for other axes start, refer to the sample programs (InterruptOas/PollingOas/OasDigitalOutput) contained on the utility software. 	

POINT	Position data [Command unit]	Feed speed [Speed unit]	Acceleration time constant [ms]	Deceleration time constant [ms]	Dwell/predwell [ms]	Auxiliary command	Other axes start specification	S-curve ratio [%]	Reserved
	4 bytes	4 bytes	2 bytes	2 bytes	2 bytes	2 bytes	4 bytes	1 byte	11 bytes
0000	2000	2000	20	30	0	0000h	00000000h	100	0
0001	2000	3000	30	50	0	0000h	00000000h	100	0
0002	1000	1000	20	30	0	0000h	00000000h	100	0
:	:	:	:	:	:	:	:	:	:

(a) Other axes start specification

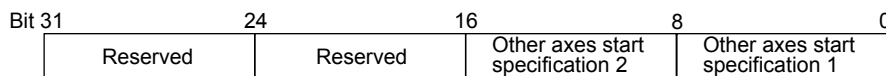

• Other axes start specification 1 and 2

- 0 : Other axes start specification invalid
- 1 to 32: Other axes start data No.

Example) Set 00000401h to set 1 and 4 for the other axes start specification 1 and 2, respectively.

1) Cause of alarm

- When the other axes start data set in the other axes start specification at point switching or the start of operation is being used (when the other axes start notice signal (OSOP□) is on), using other axes start data (operation alarm 5B, detail 01) occurs and operation is terminated.
- If the setting of the other axes start specification is incorrect, it causes a point table setting error (operation alarm 25, detail 09) and operation is stopped.

6. APPLICATION FUNCTIONS

(2) Other axes start data

For the other axes start data (1 to 32), set the conditions for starting other axes (start conditions) and the operation (operation content) performed when the condition is satisfied. When the other axes start No. (1 to 32) is set to the other axes start specification (other axes start specification 1 and 2) of the point table, other axes are started according to the settings of the corresponding other axes start data.

Other axes start data table

E100	Other axes start data 1	Start condition	E780	Other axes start data 17	Start condition
		Operation content			Operation content
E168	Other axes start data 2	Start condition	E7E8	Other axes start data 18	Start condition
		Operation content			Operation content
E1D0	Other axes start data 3	Start condition	E850	Other axes start data 19	Start condition
		Operation content			Operation content
E238	Other axes start data 4	Start condition	E8B8	Other axes start data 20	Start condition
		Operation content			Operation content
E2A0	Other axes start data 5	Start condition	E920	Other axes start data 21	Start condition
		Operation content			Operation content
E308	Other axes start data 6	Start condition	E988	Other axes start data 22	Start condition
		Operation content			Operation content
E370	Other axes start data 7	Start condition	E9F0	Other axes start data 23	Start condition
		Operation content			Operation content
E3D8	Other axes start data 8	Start condition	EA58	Other axes start data 24	Start condition
		Operation content			Operation content
E440	Other axes start data 9	Start condition	EAC0	Other axes start data 25	Start condition
		Operation content			Operation content
E4A8	Other axes start data 10	Start condition	EB28	Other axes start data 26	Start condition
		Operation content			Operation content
E510	Other axes start data 11	Start condition	EB90	Other axes start data 27	Start condition
		Operation content			Operation content
E578	Other axes start data 12	Start condition	EBF8	Other axes start data 28	Start condition
		Operation content			Operation content
E5E0	Other axes start data 13	Start condition	EC60	Other axes start data 29	Start condition
		Operation content			Operation content
E648	Other axes start data 14	Start condition	ECC8	Other axes start data 30	Start condition
		Operation content			Operation content
E6B0	Other axes start data 15	Start condition	ED30	Other axes start data 31	Start condition
		Operation content			Operation content
E718	Other axes start data 16	Start condition	ED98	Other axes start data 32	Start condition
		Operation content			Operation content

POINT

- All axes start data specified in the other axes start specification of the point table upon start of operation are imported. When the other axes start data is changed after the start operation (after the other axes start notice signal (OSOP□) is turned on) the changes will be invalid.

API LIBRARY

- Use the `sscSetOtherAxisStartData/sscGetOtherAxisStartData` functions to set/get other axes start data.

6. APPLICATION FUNCTIONS

(a) Start condition

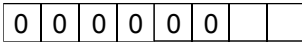
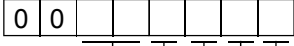
Address	Abbreviation	Name	Initial Value	Unit	Setting range	Function
E100	OSOPN1	Axis option (4 bytes)	00000000h		00000000h to 00000011h	 <p>Axis judgment condition Set the judgment condition for the axis. 0: Remaining distance specification (The condition is satisfied when the axis remaining distance is equal to or shorter than the axis remaining distance data.) 1: Specified position pass specification (The condition is satisfied when the axis position exceeds the axis pass position data.) Axis judgment coordinate Set the judgment coordinate for the axis. 0: Current feedback position 1: Current command position</p>
E104	OSOPN2	Observed axis option (4 bytes)	00000000h		00000000h to 00FF1111h	<p>Set here to monitor axes.</p>  <p>Observed axis specification Validates the observed axis. 0: Invalid 1: Valid Observed axis judgment condition Set the judgment condition for the observed axis. 0: Not use 1: Observed axis specified position pass specification Observed axis judgment coordinate Set the judgment coordinate for the observed axis. 0: Current feedback Observed axis specified position pass judgment condition Set the specified position pass judgment condition for the observed axis. 0: Condition is satisfied when observed axis position is less than or equal to observed axis specified position data 1: Condition is satisfied when observed axis position is more than or equal to observed axis specified position data Observed axis No. Set the observed axis No. 00h to 1Fh: Axis No. -1 Example) 0Ah: Axis No. 11</p>
E108	OSPP	Axis remaining distance data (4 bytes)	0	Command Units	0 to 2147483647	Set the remaining distance data for the axis. (When "0: Remaining distance specification" is set to the axis judgment condition.)
		Axis pass position data (4 bytes)	0	Command Units	-2147483648 to 2147483647	Set the pass position data for the axis. (When "1: Specified position pass specification" is set to the axis judgment condition)

6. APPLICATION FUNCTIONS

Address	Abbreviation	Name	Initial Value	Unit	Setting range	Function
E10C	OSMP	Observed axis specified position data (4 bytes)	0	Command Units	-2147483648 to 2147483647	Set the specified position data of the observed axis set in the observed axis option.
E110 to E117		Reserved (8 bytes)				

Note. The addresses in the table are the addresses for the other axes start data 1. For the other axes data 2 and above, increase in units of 68h for each axis.

1) Cause of alarm

An incorrect setting of the other axes start condition causes an other axes start setting error (operation alarm 4D, detail 01) at the start operation or point switching.

- The setting of the axis option, observed axis option, or axis remaining distance data is outside limits.
- The position specified in the axis pass position data cannot be passed.

(When "1: Specified position pass specification" is set to the axis judgment condition)

However, the condition above does not cause the error when the specified position is in the opposite direction from the movement direction.

In this case, the specified position is judged to be already passed, which satisfies the condition.

- When the observed axis specification is valid, a non-existent axis (Note) is set in the observed axis No.

(b) Operation content

Address	Abbreviation	Name	Unit	Setting range	Function
E118	OSAX1	Start axis designation 1 (4 bytes)		00000000h to FFFFFFFFh	Set the axis for which the start operation is performed when the other axes start condition is satisfied. Axis 1 (bit 0) to axis 20 (bit 19) 0: Start operation invalid 1: Start operation valid
E11C to E11F		Reserved (4 bytes)			
E120	OSPS	Start axis start point No. (2 bytes)		0 to 319	Set the start point No. of the other axes start axis.
E122	OSPE	Start axis end point No. (2 bytes)		0 to 319	Set the end point No. of the other axes start axis.
E124 to E157		Reserved (52 bytes)			

6. APPLICATION FUNCTIONS

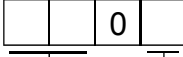
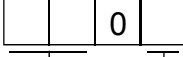
Address	Abbreviation	Name	Unit	Setting range	Function
E158	OSDOS	Digital output signal specification (2 bytes)		0000h to 3F01h	<p>Select the digital output signal (DO_□□□) to control output in units of 16 points when the other axes start conditions are satisfied.</p>  <p>Digital output signal control Set valid/invalid for the digital output signal control. 0: Invalid 1: Valid</p> <p>Digital output signal number Set the digital output signal (DO_□□□) in units of 16 points. 00 to 3Fh Example. 00h: DO_000 to DO_00F 3Fh: DO_3F0 to DO_3FF</p> <p>(When "0: Use digital I/O table" is selected in I/O table (parameter No.004A))</p>
		Output device signal specification (2 bytes)		0000h to FF01h	<p>Select the output device signal (DVO_□□□) to control output in units of 16 points when the other axes start conditions are satisfied.</p>  <p>Output device signal control Set valid/invalid for the output device signal control. 0: Invalid 1: Valid</p> <p>Output device signal number Set the output device signal (DVO_□□□) in units of 16 points. 00 to FFh Example. 00h: DVO_000 to DVO_00F FFh: DVO_FF0 to DVO_FFF</p> <p>(When "1: Use I/O device table" is selected in I/O table (parameter No.004A))</p>
E15A	OSDOE	Digital output signal enable selection (2 bytes)		0000h to FFFFh	<p>Set valid/invalid for the digital output signal (DO_□□□) selected in the digital output signal specification. DO_□□0 (bit 0) to DO_□□F (bit 15) Note. □□ is set in the digital output signal specification. 0: Invalid 1: Valid (When "0: Use digital I/O table" is selected in I/O table (parameter No.004A))</p>
		Output device signal enable selection (2 bytes)		<p>Set valid/invalid for the output device signal (DVO_□□□) selected in the output device signal specification. DVO_□□0 (bit 0) to DVO_□□F (bit 15) Note. □□ is set in the output device signal specification. 0: Invalid 1: Valid (When "1: Use I/O device table" is selected in I/O table (parameter No.004A))</p>	

6. APPLICATION FUNCTIONS

Address	Abbreviation	Name	Unit	Setting range	Function
E15C	OSDOP	Digital output signal command (2 bytes)		0000h to FFFFh	Set the digital output signal command (ON/OFF) of the digital output signal (DO_□□□) selected in the digital output signal enable selection. DO_□□0 (bit 0) to DO_□□F (bit 15) Note. □□ is set in the digital output signal specification. 0: OFF 1: ON (When "0: Use digital I/O table" is selected in I/O table (parameter No.004A))
		Output device signal command (2 bytes)			Set the digital output signal command (ON/OFF) of the output device signal (DVO_□□□) selected in the output device signal enable selection. DVO_□□0 (bit 0) to DVO_□□F (bit 15) Note. □□ is set in the output device signal specification. 0: OFF 1: ON (When "1: Use I/O device table" is selected in I/O table (parameter No.004A))
E15E to E167		Reserved (10 bytes)			

Note 1. The addresses in the table are the addresses for the other axes start data 1. For the other axes data 2 and above, increase in units of 68h for each axis.

6. APPLICATION FUNCTIONS

[Setting example of output signal]

The following is the setting example for when the digital output signals DO_1F0 to DO_1F3 are turned on after the other axes start conditions are satisfied.

Address	Abbreviation	Name	Setting value	Setting contents
E158	OSDOS	Digital output signal specification	1F01h	Digital output signal control: valid, digital output signal number: 1Fh
E15A	OSDOE	Digital output signal enable selection	000Fh	bit0 to bit3: valid, bit4 to bit15: invalid
E15C	OSDOP	Digital output signal command	000Fh	bit0 to bit3: ON

1) Cause of alarm

An incorrect setting of the other axes operation content causes an other axes start setting error (operation alarm 4D, detail 02) at the start operation or point switching.

- The axis is specified in the start axis designation.
- A non-existent axis (Note) is set in the start axis designation.
- The setting of the start axis start point No. or the start axis end point No. is outside limits.
- The setting of the output signal specification is out of the range.
- The general output of the servo amplifier or output of remote I/O module is not assigned to the digital output signal or output device signal specified in the output signal selection.

Note. A non-existent axis means an axis for which "0: Not controlled" is set to the control axis of the control option 1 (parameter No.0200), or a temporarily uncontrollable axis due to, for example, the power off of the control power supply of the servo amplifier.

The settings required for the main uses of other axes start are as follows.

Name	Main uses		
	Starting operation of other axis at specified position	Turning ON/OFF digital output signal or output device signal	Using observed axis
Axis option	○	○	○
Observed axis option	—	—	○
Axis remaining distance data/Axis pass position data	○	○	○
Observed axis specified position data	—	—	○
Start axis designation 1	○	—	○
Start axis start point No.	○	—	○
Start axis end point No.	○	—	○
Output signal specification	—	○	—
Output signal enable selection	—	○	—

○: Required —: Optional

6. APPLICATION FUNCTIONS

6.23.3 Interface

(1) Other axes start command/other axes start status bit

The other axes start commands/other axes start statuses related to the other axes start function are shown below.

Other axes start command/status table

E080	Other axes start command/status table 1	Other axes start command	E0C0	Other axes start command/status table 17	Other axes start command
		Other axes start status			Other axes start status
E084	Other axes start command/status table 2	Other axes start command	E0C4	Other axes start command/status table 18	Other axes start command
		Other axes start status			Other axes start status
E088	Other axes start command/status table 3	Other axes start command	E0C8	Other axes start command/status table 19	Other axes start command
		Other axes start status			Other axes start status
E08C	Other axes start command/status table 4	Other axes start command	E0CC	Other axes start command/status table 20	Other axes start command
		Other axes start status			Other axes start status
E090	Other axes start command/status table 5	Other axes start command	E0D0	Other axes start command/status table 21	Other axes start command
		Other axes start status			Other axes start status
E094	Other axes start command/status table 6	Other axes start command	E0D4	Other axes start command/status table 22	Other axes start command
		Other axes start status			Other axes start status
E098	Other axes start command/status table 7	Other axes start command	E0D8	Other axes start command/status table 23	Other axes start command
		Other axes start status			Other axes start status
E09C	Other axes start command/status table 8	Other axes start command	E0DC	Other axes start command/status table 24	Other axes start command
		Other axes start status			Other axes start status
E0A0	Other axes start command/status table 9	Other axes start command	E0E0	Other axes start command/status table 25	Other axes start command
		Other axes start status			Other axes start status
E0A4	Other axes start command/status table 10	Other axes start command	E0E4	Other axes start command/status table 26	Other axes start command
		Other axes start status			Other axes start status
E0A8	Other axes start command/status table 11	Other axes start command	E0E8	Other axes start command/status table 27	Other axes start command
		Other axes start status			Other axes start status
E0AC	Other axes start command/status table 12	Other axes start command	E0EC	Other axes start command/status table 28	Other axes start command
		Other axes start status			Other axes start status
E0B0	Other axes start command/status table 13	Other axes start command	E0F0	Other axes start command/status table 29	Other axes start command
		Other axes start status			Other axes start status
E0B4	Other axes start command/status table 14	Other axes start command	E0F4	Other axes start command/status table 30	Other axes start command
		Other axes start status			Other axes start status
E0B8	Other axes start command/status table 15	Other axes start command	E0F8	Other axes start command/status table 31	Other axes start command
		Other axes start status			Other axes start status
E0BC	Other axes start command/status table 16	Other axes start command	E0FC	Other axes start command/status table 32	Other axes start command
		Other axes start status			Other axes start status

6. APPLICATION FUNCTIONS

Other axes start command

Address	Bit	Abbreviation	Signal name
E080	0	OSSTP <input type="checkbox"/>	Other axes start cancel
	1	Reserved	
	2		
	3		
	4		
	5		
	6		
	7		
	8		
	9		
	10		
	11		
	12		
	13		
	14		
15			

Other axes start status

Address	Bit	Abbreviation	Signal name
E082	0	OSOP <input type="checkbox"/>	Other axes start notice
	1	OSFIN <input type="checkbox"/>	Other axes start complete
	2	OSERR <input type="checkbox"/>	Other axes start incomplete
	3	Reserved	
	4		
	5		
	6		
	7		
	8		
	9		
	10		
	11		
	12		
	13		
	14		
15			

Note 1. The addresses in the table above are the addresses for the other axes start command/status table 1. For the other axes data 2 and above, increase in units of 4h for each axis.

Note 2. : Other axes start No.

API LIBRARY

- Use the `sscOtherAxisStartAbortOn` or `sscOtherAxisStartAbortOff` functions to turn ON/OFF the other axes start cancel command (OSSTP).
- Use the `sscGetOtherAxisStartStatus` function to check if the following other axes start statuses are ON/OFF.
 - Other axes start notice (OSOP)
 - Other axes start complete (OSFIN)
 - Other axes start incomplete (OSERR)

(a) Details concerning other axes start command bits

Abbreviation	Signal name	Function details
OSSTP <input type="checkbox"/>	Other axes start cancel	[Function] Cancels the other axes start. [Operation] Turn on this signal to cancel the other axes start when the other axes start notice signal (OSOP <input type="checkbox"/>) is on for waiting for the other axes start condition satisfaction.

6. APPLICATION FUNCTIONS

(b) Details concerning other axes start status bits

Abbreviation	Signal name	Function details
OSOP □	Other axes start notice	<p>[Function] Notifies the monitoring for the other axes start condition.</p> <p>[Operation] <Conditions for turning on> The other axis start data is specified in the other axes start specification of the point table for automatic operation and linear interpolation operation, and the axis is monitored for the other axes start condition.</p> <p><Conditions for turning off> <ul style="list-style-type: none"> • The other axes start condition is satisfied. • During monitoring for the other axes start condition (when OSOP □ is on), the other axes start cancel signal (OSSTP □) is turned on. </p>
OSFIN □	Other axes start complete	<p>[Function] Notifies that the other axes start operation content is executed.</p> <p>[Operation] <Conditions for turning on> The other axes start condition is satisfied, and the other axes start operation content is executed.</p> <p><Conditions for turning off> The other axes start data is specified in the other axes start specification in the point table for automatic operation or linear interpolation operation.</p>
OSERR □	Other axes start incomplete	<p>[Function] Notifies that the other axes start has failed.</p> <p>[Operation] <Conditions for turning on> <ul style="list-style-type: none"> • The axis specified in the start axis designation is being operated when the other axes start operation content should be executed. • The operation mode of the axis specified in the start axis designation is other than automatic operation and linear interpolation operation when the other axes start operation content should be executed. • During monitoring for the other axes start condition (when OSOP □ is on), operation is canceled due to an operation alarm on the axis or the (rapid) stop operation signal ((R)STP) turned on. • During monitoring for the other axes start condition (when OSOP □ is on), the other axes start cancel signal (OSSTP □) is turned on. • The number of axes set in the start axis designation exceeds the maximum number of simultaneous start axes. </p> <p><Conditions for turning off> The other axes start data is specified in the other axes start specification in the point table for automatic operation or linear interpolation operation.</p>

Note. □ : Other axes start No.

6. APPLICATION FUNCTIONS

6.23.4 Operation example

(1) When other axes start is complete

The other axes start notice (OSOP) turns on between the axis start and the completion of the other axis start. The other axes start complete (OSFIN) turns on when the other axes start notice (OSOP) is turned off on completion of the other axes start.

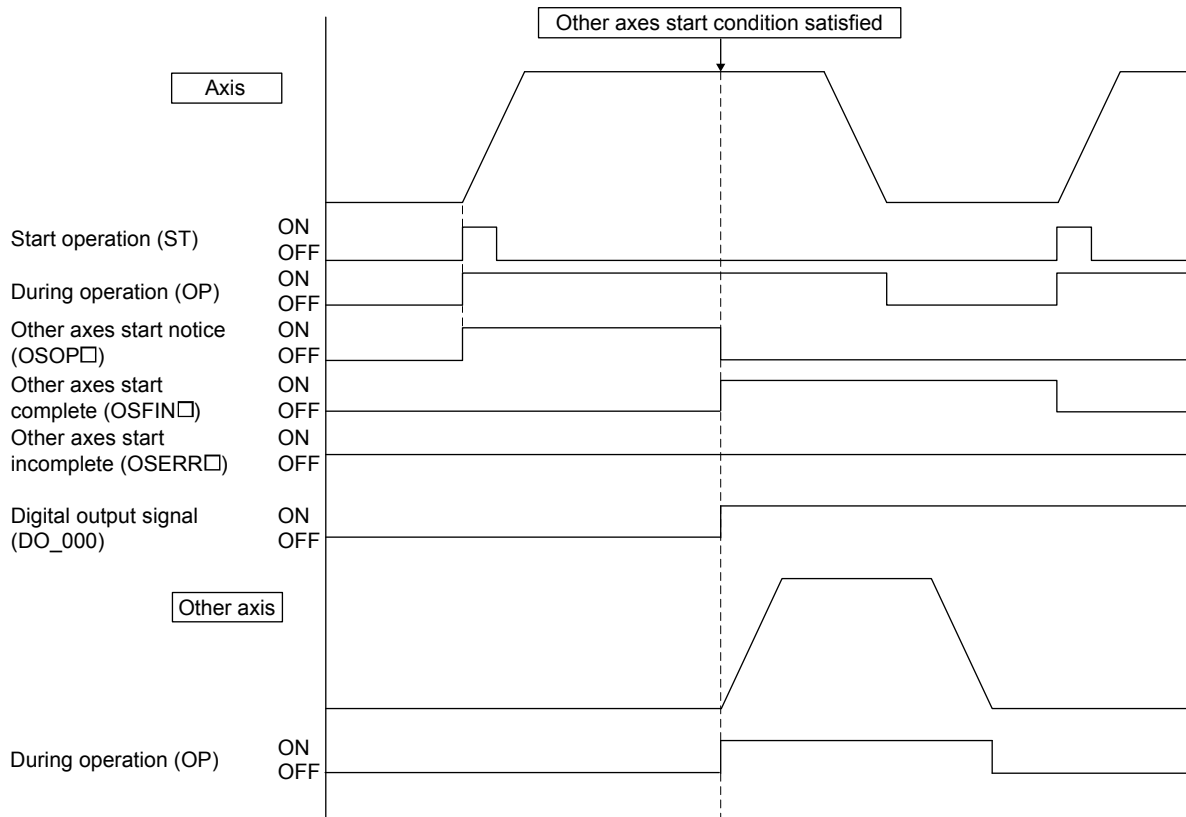

[Digital output signal setting example]

Address	Abbreviation	Name	Setting value	Setting contents
E158	OSDOS	Digital output signal specification	0001h	Digital output signal control: valid, digital output signal number: 00h
E15A	OSDOE	Digital output signal enable selection	0001h	bit0: valid, bit1 to bit15: invalid
E15C	OSDOP	Digital output signal command	0001h	bit0: ON

6. APPLICATION FUNCTIONS

(2) When the observed axis is valid

When "1: Valid" is set to the observed axis specification (in the observed axis option of the other axes start condition), the other axes content is not operated until both the axis judgment condition and the observed axis judgment condition are satisfied.

(a) Example of when the monitor axis judgment condition are satisfied after the axis judgment condition is satisfied

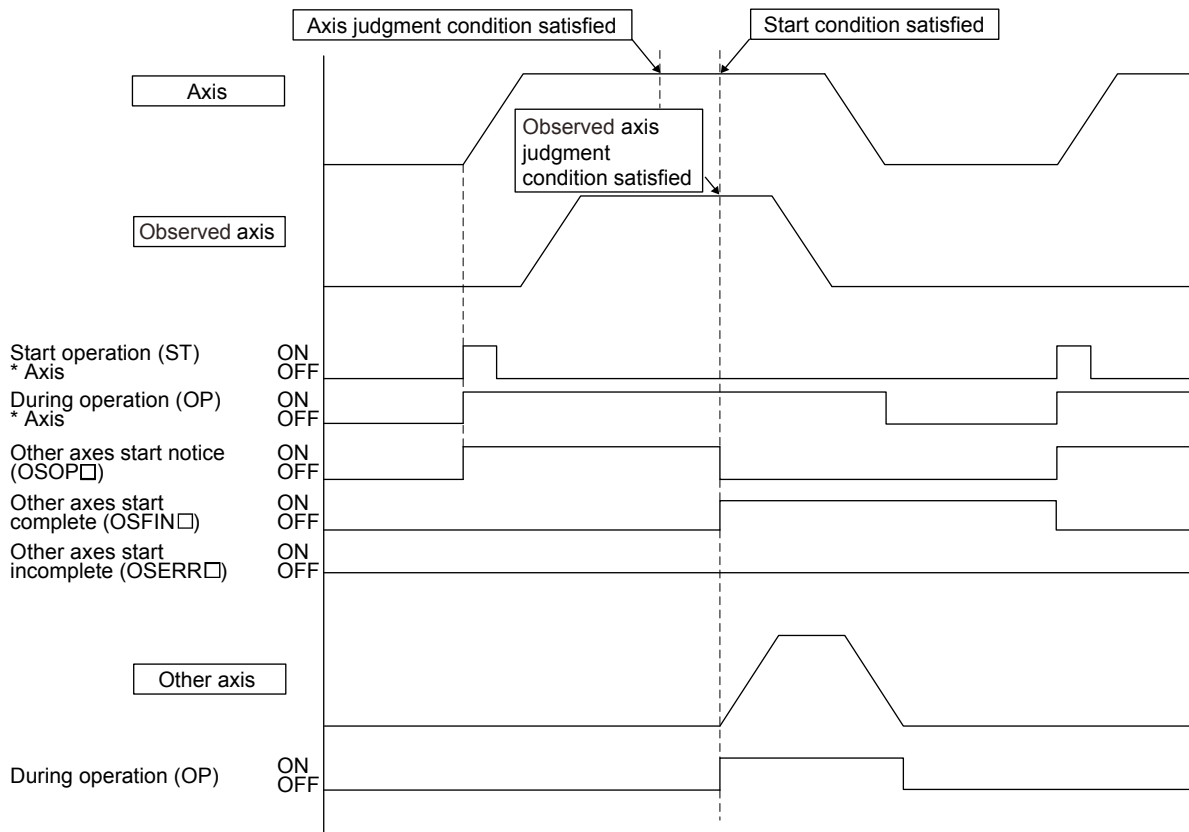

6. APPLICATION FUNCTIONS

(3) When other axes start fails

When the other axes start fails due to, for example, an operation alarm on the axis preceding the satisfaction of other axes start condition, the other axes start incomplete (OSERR) turns on. The other axes start incomplete (OSERR) turns on when:

- (a) The axis set in the start axis designation 1 is being operated when the other axes start condition is satisfied.
- (b) The operation mode of the axis set in the start axis designation 1 is other than automatic operation and linear interpolation operation when the other axes start condition is satisfied.
- (c) Operation is canceled by turning on the stop operation signal (STP) or the rapid stop signal (RSTP) before the other axes start condition is satisfied.
- (d) Operation is canceled by an operation alarm, etc. before the other axis start condition is satisfied.
- (e) Operation of the axis is completed and the in-position signal is turned on before the other axes start condition is satisfied.

[Example of when an operation alarm occurs]

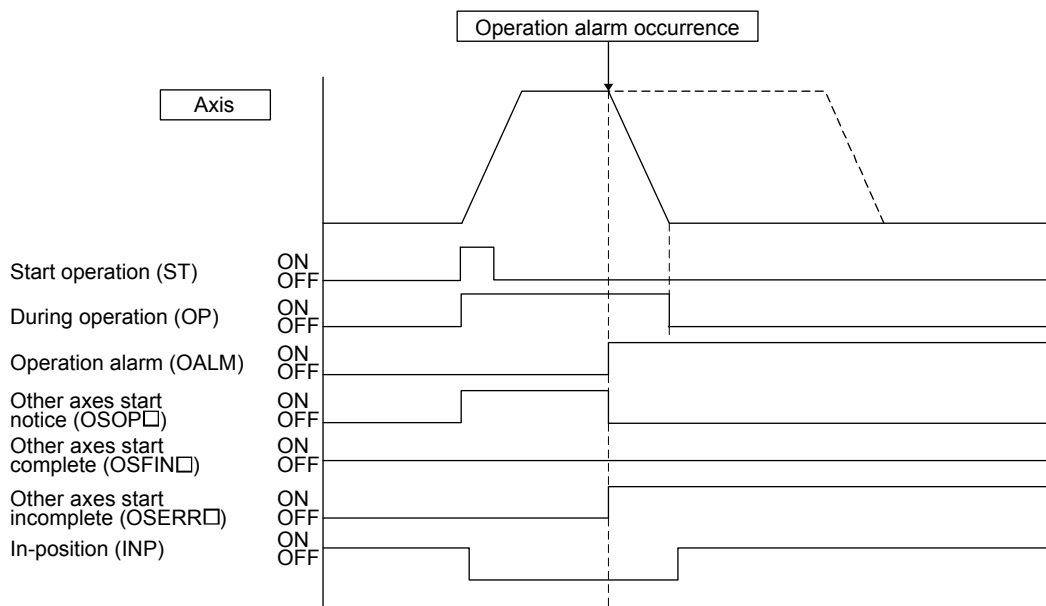

6. APPLICATION FUNCTIONS

[Example of when operation of the axis is completed]

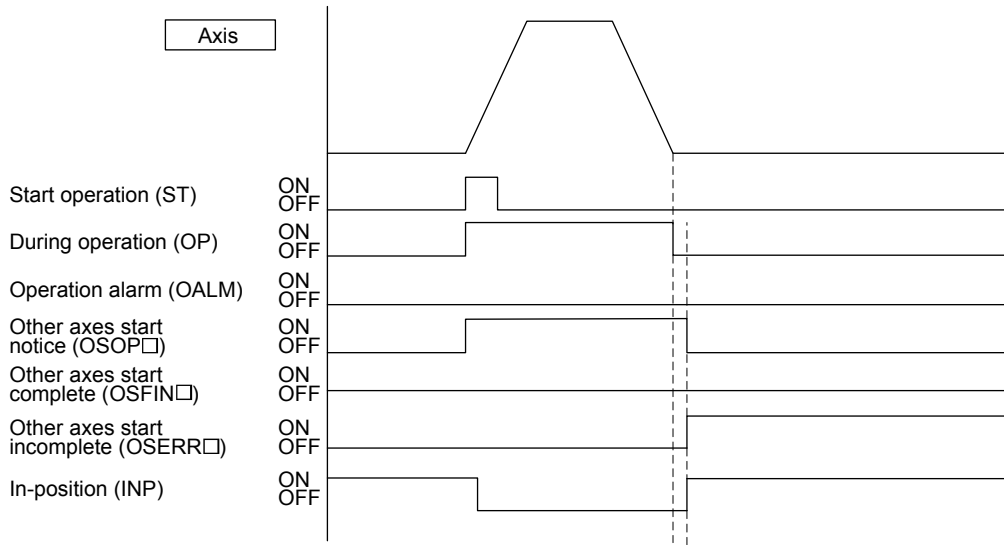

(4) When other axes start is canceled

When the other axes start cancel (OSSTP) is turned on before the other axes start condition is satisfied, the other axes start incomplete (OSERR) turns on.

[Example of when the other axes start is canceled]

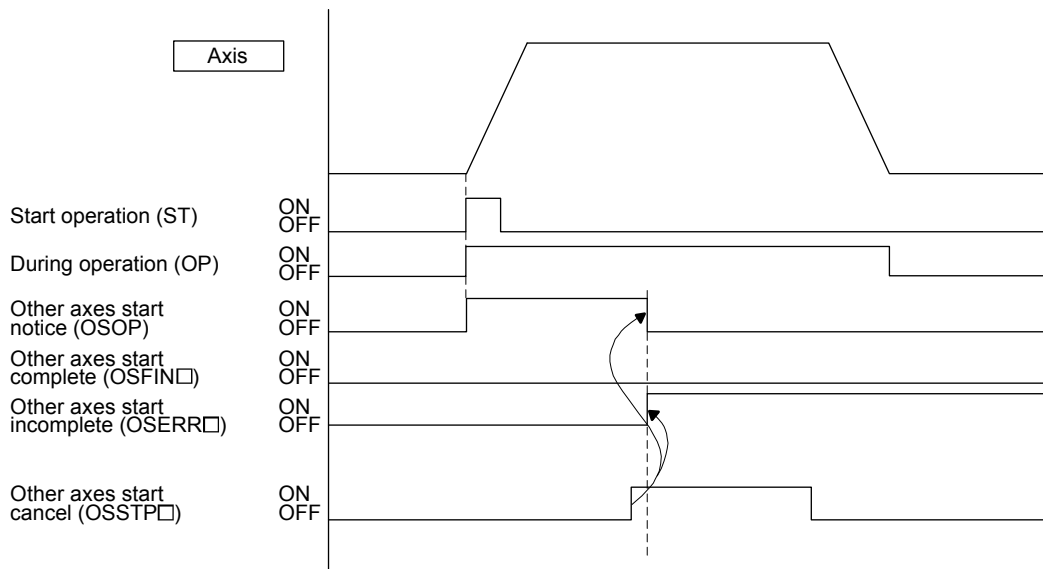

6. APPLICATION FUNCTIONS

6.24 High response I/F

6.24.1 Summary

The high response I/F function is a function for shortening time required to check commands and statuses by simplifying the process between the Q173SCCF and the C Controller module. The high response I/F function is always valid.

This function simplifies the following processes.

- (1) Start operation signal (ST)
- (2) Interrupt processing complete signal (ITE)

POINT

- | |
|--|
| <ul style="list-style-type: none">▪ The conventional I/F function which uses the start operation signal (ST) and the interrupt processing complete signal (ITE) can also be used. However, use either of the high response I/F function or the conventional I/F function to unify the process between the Q173SCCF and the C Controller module.▪ The API library uses the high response I/F (except for JOG operation). |
|--|

API LIBRARY

- | |
|--|
| <ul style="list-style-type: none">▪ High response I/F is implemented by the internal processing of each start operation function (sscAutoStart functions etc.) thus processing by user program is unnecessary. |
|--|

6. APPLICATION FUNCTIONS

6.24.2 Interface

(1) System command bits

Address	Bit	Abbreviation	Signal name
03E4	0	ITFE	Interrupt processing high speed complete
	1	/	Reserved
	2		
	3		
	4		
	5		
	6		
	7		

(2) System status bits

Address	Bit	Abbreviation	Signal name
0450	0	ITO	Outputting with factor of interrupt
	1	IITO	During interface mode interrupt valid
	2	EVDO	Event detection enabled
	3	HRIF	During highly response I/F valid
	4	BMA	During system program memory access
	5	PRINF	Continuous operation to torque control compatible information
	6	/	Reserved
	7		IFMO

(3) Axis command bits

Address	Bit	Abbreviation	Signal name
1006	0	FST	Fast start operation
	1	/	Reserved
	2		
	3		
	4		
	5		
	6		
	7		

Note: The above address is the address for the axis 1. For the axis 2 and above, increase in units of C0h for each axis.

6. APPLICATION FUNCTIONS

6.24.3 Fast start operation

Using the fast start operation signal (FST) as a substitute of the start operation signal (ST) shortens the time required for the second and subsequent start operations.

POINT
<ul style="list-style-type: none"> The fast start operation cannot be used in JOG operation. Use the start operation signal (ST).

(1) High response start operation using the fast start operation signal (FST)

In the start operation, the user program turns on the fast start operation signal (FST) as a substitute of the start operation signal (ST). On receiving the fast start operation signal (FST), the Q173SCCF turns off the signal (FST), and operation is started.

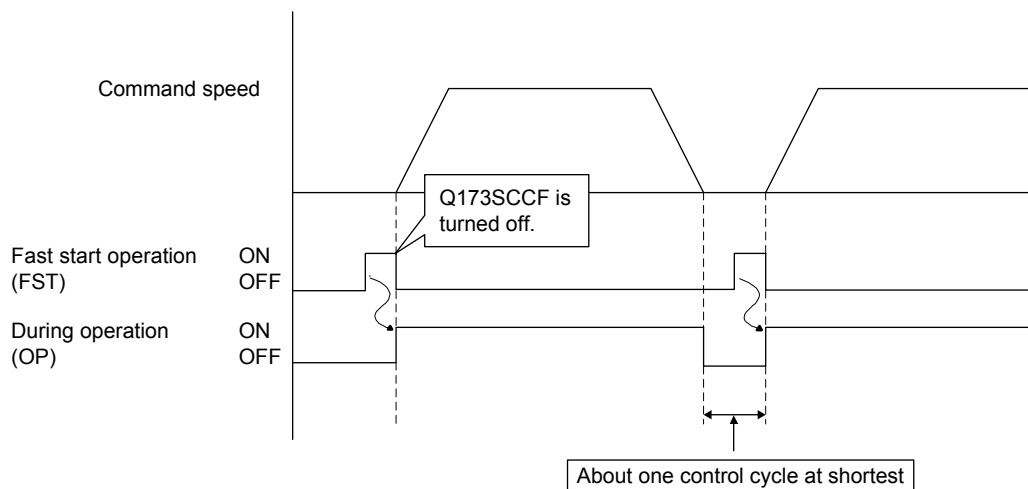

(2) Conventional start operation using the start operation signal (ST)

In the conventional start operation, the next start operation cannot be performed until the start up acceptance complete signal (STO) is turned off by turning off the start operation signal (ST). Therefore, the start operation signal (ST) must be turned off before the next start operation. This procedure, when performed after operation is completed, delays the start operation by about one control cycle until the start up acceptance complete signal (STO) is turned off. In addition, when the start operation signal (ST) is turned off in operation, the start up acceptance complete signal (STO) is off after operation is completed, which provides the same responsiveness as in the start operation using the fast start operation signal (FST).

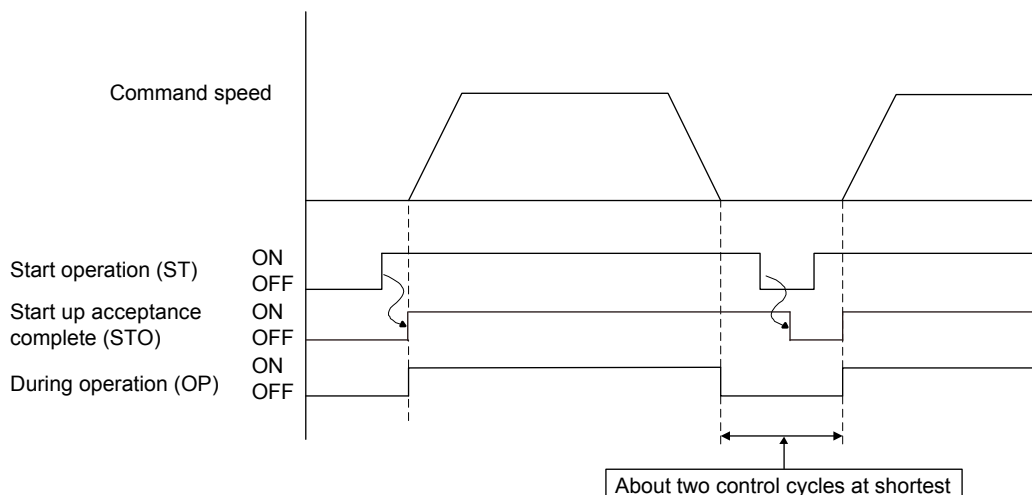

6. APPLICATION FUNCTIONS

6.24.4 Interrupt processing high speed completion

Using the interrupt processing high speed complete signal (ITFE) as a substitute of the interrupt processing complete signal (ITE) shortens the time for interrupt processing completion.

(1) High response interrupt processing completion using the interrupt processing high speed complete signal (ITFE)

For interrupt processing completion, the interrupt thread or device driver turns on the interrupt processing high speed complete signal (ITFE) as a substitute of the interrupt processing complete signal (ITE). On receiving the interrupt processing high speed complete signal (ITFE), the Q173SCCF turns off the signal (ITFE), and the interrupt processing is completed. The interrupt thread or device driver does not need to wait until the outputting with factor of interrupt (ITO) is turned off, and the next operation can be performed.

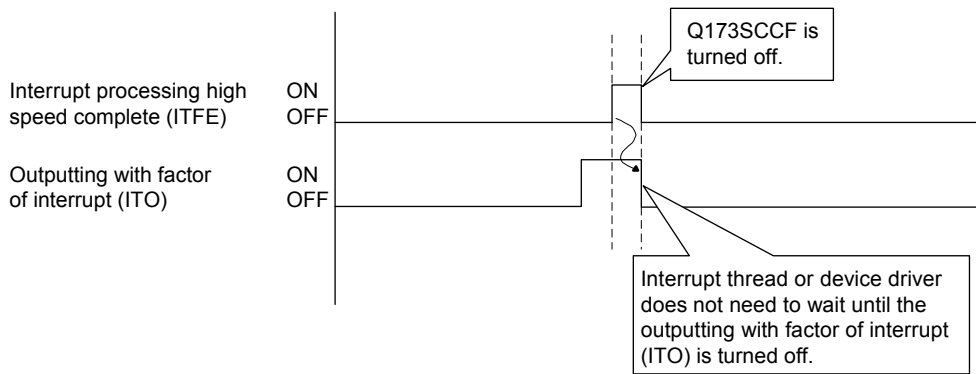

(2) Conventional interrupt processing completion using the interrupt processing complete signal (ITE)

The conventional interrupt processing requires the interrupt processing complete signal (ITE) to be on, then waiting until the outputting with factor of interrupt (ITO) is turned off, and then the interrupt processing complete signal (ITE) to be off. Therefore, interrupt processing completion is delayed by about one control cycle until the outputting with factor of interrupt (ITO) is turned off.

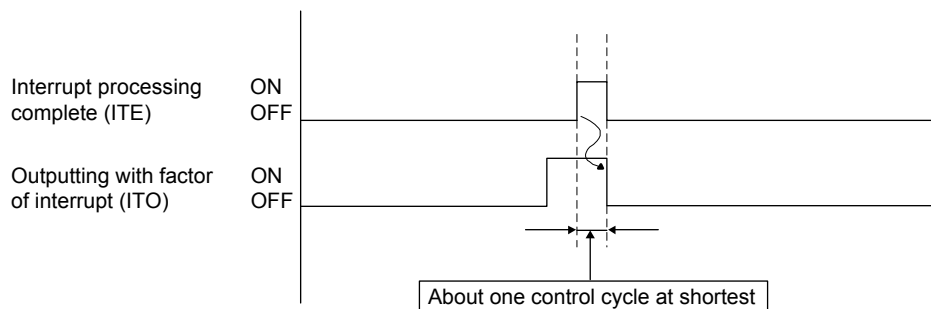

6. APPLICATION FUNCTIONS

6.25 In-position signal

For the in-position signal (INP), the Q173SCCF checks the in-position range and controls turning on or off the signal.

The in-position signal controlled by the servo amplifier is displayed as the servo amplifier in-position signal (SINP).

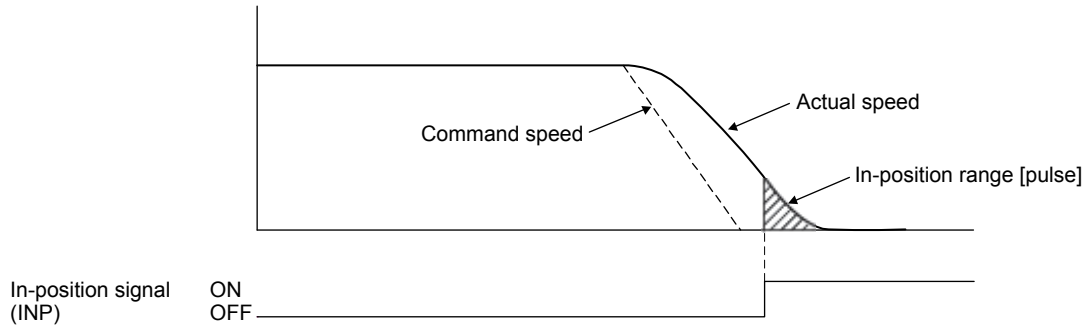

API LIBRARY

- To check if in-position (INP) is ON/OFF, check whether SSC_STSBIT_AX_INP is ON/OFF with the `sscGetStatusBitSignalEx` or `sscWaitStatusBitSignalEx` functions.

(1) Parameter

For servo parameter (MR-J4(W□)-□B)

Parameter No.	MR-J4B Parameter No.	Abbreviation	Name	Initial Value	Unit
1109	PA10	INP	In-position range	1600	pulse

(2) Axis data status bit

Address	Bit	Abbreviation	Signal name	When tandem drive is being used
1060	0	RDY	Servo ready	Each axis
	1	INP	In-position	Each axis
	2	ZSP	Zero speed	Each axis
	3	ZPAS	Passed Z-phase	Each axis
	4	TLC	Torque limit effective	Each axis
	5	SALM	Servo alarm	Each axis
	6	SWRN	Servo warning	Each axis
7	ABSE	Absolute position erased	Each axis	

Address	Bit	Abbreviation	Signal name	When tandem drive is being used
1069	0	IWT	Interference check standby	Each axis
	1	SINP	Servo amplifier in-position	Each axis
	2		Reserved	
	3			
	4			
	5			
	6			
7				

Note: The above address is the address for the axis 1. For the axis 2 and above, increase in units of C0h for each axis.

6. APPLICATION FUNCTIONS

6.26 Digital I/O

6.26.1 Summary

The digital I/O function is a function that controls the general I/O signal of the servo amplifier assigned to the digital I/O table. The user program can check whether the digital I/O signals are on/off by using the digital I/O table. The points for the each I/O signal can be assigned up to 1024.

When using the digital I/O function, set "0: Use digital I/O table" in I/O table (parameter No.004A).

CAUTION

- If the digital output signal is updated from the user program during controlling of the digital output signal by the other axes start function, the consistency of the data may not be kept. This condition is applied to the case when the C Controller module and Q173SCCF update the data at the same time to the same digital output area number. In this case, read/write the digital output signal after controlling the possessory right of the digital output signal using the exclusive control function.

POINT

- For detailed specifications and how to assign the I/O signal to the digital I/O table, refer to Section 6.28.
 - When using the digital I/O function, the I/O device function cannot be used.
 - In relation to the digital I/O function, the following functions are expanded for the I/O device function. We recommend using the I/O device function.
 - Expansion of I/O points used
 - Supports control of I/O word devices
- Refer to Section 6.27 for details of the I/O device function.

API LIBRARY

- Use the `sscGetDigitalInputDataBit` or `sscGetDigitalInputDataWord` functions to get digital input.
- Use the `sscSetDigitalOutputDataBit` or `sscSetDigitalOutputDataWord` functions to set digital output.
- Use the `sscGetDigitalOutputDataBit` or `sscGetDigitalOutputDataWord` functions to get digital output.

6. APPLICATION FUNCTIONS

6.26.2 Interface

The following shows the interfaces related to the digital I/O.

(1) Digital input table

Address	Digital input area number	Digital input number	Abbreviation	Remarks
B000	Digital input area 0 (2 bytes)	Digital input 0 to digital input 15	DI_000 to DI_00F	Notifies the status of the digital input signal. The bits are DI_000 (bit0) to DI_00F (bit15).
B002	Digital input area 1 (2 bytes)	Digital input 16 to digital input 31	DI_010 to DI_01F	Notifies the status of the digital input signal. The bits are DI_010 (bit0) to DI_01F (bit15).
B004	Digital input area 2 (2 bytes)	Digital input 32 to digital input 47	DI_020 to DI_02F	Notifies the status of the digital input signal. The bits are DI_020 (bit0) to DI_02F (bit15).
B006	Digital input area 3 (2 bytes)	Digital input 48 to digital input 63	DI_030 to DI_03F	Notifies the status of the digital input signal. The bits are DI_030 (bit0) to DI_03F (bit15).
B008	Digital input area 4 (2 bytes)	Digital input 64 to digital input 79	DI_040 to DI_04F	Notifies the status of the digital input signal. The bits are DI_040 (bit0) to DI_04F (bit15).
B00A	Digital input area 5 (2 bytes)	Digital input 80 to digital input 95	DI_050 to DI_05F	Notifies the status of the digital input signal. The bits are DI_050 (bit0) to DI_05F (bit15).
B00C	Digital input area 6 (2 bytes)	Digital input 96 to digital input 111	DI_060 to DI_06F	Notifies the status of the digital input signal. The bits are DI_060 (bit0) to DI_06F (bit15).
B00E	Digital input area 7 (2 bytes)	Digital input 112 to digital input 127	DI_070 to DI_07F	Notifies the status of the digital input signal. The bits are DI_070 (bit0) to DI_07F (bit15).
:	:	:	:	:
B07E	Digital input area 63 (2 bytes)	Digital input 1008 to digital input 1023	DI_3F0 to DI_3FF	Notifies the status of the digital input signal. The bits are DI_3F0 (bit0) to DI_3FF (bit15).

(2) Digital output table

Address	Digital output area number	Digital output number	Abbreviation	Remarks
B080	Digital output area 0 (2 bytes)	Digital output 0 to digital output 15	DO_000 to DO_00F	Turns on/off the digital output signal. The bits are DO_000 (bit0) to DO_00F (bit15).
B082	Digital output area 1 (2 bytes)	Digital output 16 to digital output 31	DO_010 to DO_01F	Turns on/off the digital output signal. The bits are DO_010 (bit0) to DO_01F (bit15).
B084	Digital output area 2 (2 bytes)	Digital output 32 to digital output 47	DO_020 to DO_02F	Turns on/off the digital output signal. The bits are DO_020 (bit0) to DO_02F (bit15).
B086	Digital output area 3 (2 bytes)	Digital output 48 to digital output 63	DO_030 to DO_03F	Turns on/off the digital output signal. The bits are DO_030 (bit0) to DO_03F (bit15).
B088	Digital output area 4 (2 bytes)	Digital output 64 to digital output 79	DO_040 to DO_04F	Turns on/off the digital output signal. The bits are DO_040 (bit0) to DO_04F (bit15).
B08A	Digital output area 5 (2 bytes)	Digital output 80 to digital output 95	DO_050 to DO_05F	Turns on/off the digital output signal. The bits are DO_050 (bit0) to DO_05F (bit15).
B08C	Digital output area 6 (2 bytes)	Digital output 96 to digital output 111	DO_060 to DO_06F	Turns on/off the digital output signal. The bits are DO_060 (bit0) to DO_06F (bit15).
B08E	Digital output area 7 (2 bytes)	Digital output 112 to digital output 127	DO_070 to DO_07F	Turns on/off the digital output signal. The bits are DO_070 (bit0) to DO_07F (bit15).
:	:	:	:	:
B0FE	Digital output area 63 (2 bytes)	Digital output 1008 to digital output 1023	DO_3F0 to DO_3FF	Turns on/off the digital output signal. The bits are DO_3F0 (bit0) to DO_3FF (bit15).

6. APPLICATION FUNCTIONS

6.27 I/O device

6.27.1 Summary

The I/O device function controls the general I/O signals of the servo amplifier and I/O devices of the remote I/O module assigned to the I/O device table. When using the I/O device function, set "1: Use I/O device table" in I/O table (parameter No.004A). The user program can check the output of output bit devices and output word devices, and check the status of input bit devices and input word devices using the I/O device table. Up to 4096 points for I/O signals can be assigned in bit units, and up to 256 points for I/O signals can be assigned in word units.

CAUTION

- If the output device signal is updated from the user program during controlling of the output device signal by the other axes start function, the consistency of the data may not be kept. This condition is applied to the case when the C Controller module and Q173SCCF update the data at the same time to the same output device area number. In this case, read/write the output device signal after controlling the possessory right of the output device signal using the exclusive control function.

POINT

- When using the I/O device function, the digital I/O function cannot be used.
- Refer to Section 6.28, 6.33, and 6.34 for how to assign I/O signals to the I/O device table and detailed specifications.

API LIBRARY

- Use the `sscGetInputDeviceBit` function to get input bit device.
- Use the `sscGetInputDeviceWord` function to get input word device.
- Use the `sscSetOutputDeviceBit` function to set output bit device.
- Use the `sscSetOutputDeviceWord` function to set output word device.
- Use the `sscGetOutputDeviceBit` function to get output bit device.
- Use the `sscGetOutputDeviceWord` function to get output word device.

6. APPLICATION FUNCTIONS

6.27.2 Interface

The following shows the interfaces related to the I/O device.

(1) System parameter

Parameter No.	Abbreviation	Name	Initial value	Units	Setting range	Function				
004A	*IOTBL	I/O table	0000h		0000h to 0001h	<table border="1"><tr><td>0</td><td>0</td><td>0</td><td></td></tr></table> <p>I/O table selection Set the I/O table to be used. 0: Use digital I/O table 1: Use I/O device table</p>	0	0	0	
0	0	0								

6. APPLICATION FUNCTIONS

(2) Input device table

Address	Input word device number	Input bit device number	Abbreviation	Remarks
DB00	Input word device 00 (2 bytes)	Input word device 000 to Input word device 00F	DVI_000 to DVI_00F	[When bit device is assigned] Notifies the status of the bit device input signal. The bits are DVI_000 (bit0) to DVI_00F (bit15). [When word device is assigned] Notifies the status of the word device input signal.
DB02	Input word device 01 (2 bytes)	Input word device 010 to Input word device 01F	DVI_010 to DVI_01F	[When bit device is assigned] Notifies the status of the bit device input signal. The bits are DVI_010 (bit0) to DVI_01F (bit15). [When word device is assigned] Notifies the status of the word device input signal.
DB04	Input word device 02 (2 bytes)	Input word device 020 to Input word device 02F	DVI_020 to DVI_02F	[When bit device is assigned] Notifies the status of the bit device input signal. The bits are DVI_020 (bit0) to DVI_02F (bit15). [When word device is assigned] Notifies the status of the word device input signal.
DB06	Input word device 03 (2 bytes)	Input word device 030 to Input word device 03F	DVI_030 to DVI_03F	[When bit device is assigned] Notifies the status of the bit device input signal. The bits are DVI_030 (bit0) to DVI_03F (bit15). [When word device is assigned] Notifies the status of the word device input signal.
DB08	Input word device 04 (2 bytes)	Input word device 040 to Input word device 04F	DVI_040 to DVI_04F	[When bit device is assigned] Notifies the status of the bit device input signal. The bits are DVI_040 (bit0) to DVI_04F (bit15). [When word device is assigned] Notifies the status of the word device input signal.
DB0A	Input word device 05 (2 bytes)	Input word device 050 to Input word device 05F	DVI_050 to DVI_05F	[When bit device is assigned] Notifies the status of the bit device input signal. The bits are DVI_050 (bit0) to DVI_05F (bit15). [When word device is assigned] Notifies the status of the word device input signal.
DB0C	Input word device 06 (2 bytes)	Input word device 060 to Input word device 06F	DVI_060 to DVI_06F	[When bit device is assigned] Notifies the status of the bit device input signal. The bits are DVI_060 (bit0) to DVI_06F (bit15). [When word device is assigned] Notifies the status of the word device input signal.
DB0E	Input word device 07 (2 bytes)	Input word device 070 to Input word device 07F	DVI_070 to DVI_07F	[When bit device is assigned] Notifies the status of the bit device input signal. The bits are DVI_070 (bit0) to DVI_07F (bit15). [When word device is assigned] Notifies the status of the word device input signal.
:	:	:	:	:
B0FE	Input word device FF (2 bytes)	Input word device FF0 to Input word device FFF	DVI_FF0 to DVI_FFF	[When bit device is assigned] Notifies the status of the bit device input signal. The bits are DVI_FF0 (bit0) to DVI_FFF (bit15). [When word device is assigned] Notifies the status of the word device input signal.

6. APPLICATION FUNCTIONS

(3) Output device table

Address	Output word device number	Output bit device number	Abbreviation	Remarks
DB00	Output word device 00 (2 bytes)	Output word device 000 to Output word device 00F	DVO_000 to DVO_00F	[When bit device is assigned] Turns ON/OFF the bit device output signal. The bits are DVO_000 (bit0) to DVO_00F (bit15). [When word device is assigned] Turns ON/OFF the word device output signal.
DB02	Output word device 01 (2 bytes)	Output word device 010 to Output word device 01F	DVO_010 to DVO_01F	[When bit device is assigned] Turns ON/OFF the bit device output signal. The bits are DVO_010 (bit0) to DVO_01F (bit15). [When word device is assigned] Turns ON/OFF the word device output signal.
DB04	Output word device 02 (2 bytes)	Output word device 020 to Output word device 02F	DVO_020 to DVO_02F	[When bit device is assigned] Turns ON/OFF the bit device output signal. The bits are DVO_020 (bit0) to DVO_02F (bit15). [When word device is assigned] Turns ON/OFF the word device output signal.
DB06	Output word device 03 (2 bytes)	Output word device 030 to Output word device 03F	DVO_030 to DVO_03F	[When bit device is assigned] Turns ON/OFF the bit device output signal. The bits are DVO_030 (bit0) to DVO_03F (bit15). [When word device is assigned] Turns ON/OFF the word device output signal.
DB08	Output word device 04 (2 bytes)	Output word device 040 to Output word device 04F	DVO_040 to DVO_04F	[When bit device is assigned] Turns ON/OFF the bit device output signal. The bits are DVO_040 (bit0) to DVO_04F (bit15). [When word device is assigned] Turns ON/OFF the word device output signal.
DB0A	Output word device 05 (2 bytes)	Output word device 050 to Output word device 05F	DVO_050 to DVO_05F	[When bit device is assigned] Turns ON/OFF the bit device output signal. The bits are DVO_050 (bit0) to DVO_05F (bit15). [When word device is assigned] Turns ON/OFF the word device output signal.
DB0C	Output word device 06 (2 bytes)	Output word device 060 to Output word device 06F	DVO_060 to DVO_06F	[When bit device is assigned] Turns ON/OFF the bit device output signal. The bits are DVO_060 (bit0) to DVO_06F (bit15). [When word device is assigned] Turns ON/OFF the word device output signal.
DB0E	Output word device 07 (2 bytes)	Output word device 070 to Output word device 07F	DVO_070 to DVO_07F	[When bit device is assigned] Turns ON/OFF the bit device output signal. The bits are DVO_070 (bit0) to DVO_07F (bit15). [When word device is assigned] Turns ON/OFF the word device output signal.
:	:	:	:	:
B0FE	Output word device FF (2 bytes)	Output word device FF0 to Output word device FFF	DVO_FF0 to DVO_FFF	[When bit device is assigned] Turns ON/OFF the bit device output signal. The bits are DVO_FF0 (bit0) to DVO_FFF (bit15). [When word device is assigned] Turns ON/OFF the word device output signal.

6. APPLICATION FUNCTIONS

6.28 Servo amplifier general I/O

6.28.1 Summary

The servo amplifier general I/O function is a function that controls the I/O signal connected to the servo amplifier via SSCNET. The user program can control the I/O signal with the digital I/O table or I/O device table, by assigning the servo amplifier general I/O signal to the digital I/O table or I/O device table. The points of the I/O signal differ depending on the servo amplifier model.

POINT
<ul style="list-style-type: none"> ▪ When a communication error (system error E401 to E407) occurs or SSCNET is disconnected, all the general I/O signals of the servo amplifier turn off. ▪ The general input signal of the servo amplifier shares the connector pin with the sensor signal (LSP, LSN, DOG). Therefore, the sensor signal cannot be input if general input signal of the servo amplifier is used as other than the sensor signal. In this case, set the sensor input option (parameter No.0219) to "2: Digital or input device input" and assign a digital input signal or input device signal as a sensor signal in the sensor signal connection specification (parameter No.021A to 021C). The sensor signal can be controlled by a command from the user program (writing of the dual port memory) when the sensor input method (parameter No.0219) is set to "4: Dual port memory". ▪ The delay time from an input of the general I/O signal of the servo amplifier to the update of the digital input table is "approx. $0.88\text{ms} + (\text{control cycle} \times 2)$" (approx. 2.7ms when the control cycle is 0.88ms). The delay time is also the same for when using an input device table. ▪ The delay time from the update of the digital output table by the user program to the output of the general output signal of the servo amplifier is "approx. $0.88\text{ms} + (\text{control cycle} \times 3)$" (approx. 3.5ms when the control cycle is 0.88ms). In the case of the digital output signal using in the other axes start function, the delay time from other axes start condition satisfaction to the output is "approx. $0.88\text{ms} + (\text{control cycle} \times 2)$" (approx. 2.7ms when the control cycle is 0.88ms). The delay time is also the same for when using an output device table.

API LIBRARY

- Use the sscChangeParameter function to set servo amplifier general I/O.

[Compatible servo amplifier]

Model	Remarks
Servo amplifier MR-J4-□B	Input: 3 points/axis Output: 3 points/axis
Servo amplifier MR-J4W□-□B	Input: 3 points/axis Output: 1 point/axis + 2 points (common in each axis)

6. APPLICATION FUNCTIONS

The following shows the connectors of the servo amplifier to be connected to the general I/O signals. Each general I/O signal is assigned to the digital input signal (DI_□□□) and digital output signal (DO_□□□). For details, refer to Section 6.28.2.

(1) For servo amplifier MR-J4-□□B

(a) General input

Signal name	Destination connector pin No.	Abbreviation
DI_□□0	CN3-2	DI1
DI_□□1	CN3-12	DI2
DI_□□2	CN3-19	DI3

(b) General output

Signal name	Destination connector pin No.	Abbreviation
DO_□□0	CN3-13	MBR
DO_□□1	CN3-9	INP
DO_□□2	CN3-15	ALM

(2) For servo amplifier MR-J4W□-□□B

(a) General input

Signal name	Destination connector pin No.			Abbreviation (□: A, B, C)
	Axis A	Axis B	Axis C (Note)	
DI_□□0	CN3-7	CN3-20	CN3-1	DI1-□
DI_□□1	CN3-8	CN3-21	CN3-2	DI2-□
DI_□□2	CN3-9	CN3-22	CN3-15	DI3-□

Note: Only MR-J4W3-□□B is available.

(b) General output

Signal name	Destination connector pin No.			Abbreviation (□: A, B, C)
	Axis A	Axis B	Axis C (Note1)	
DO_□□0	CN3-12	CN3-25	CN3-13	MBR-□
DO_□□1	CN3-11 (Note2)			CALM
DO_□□2	CN3-24 (Note2)			CINP

Note 1. Only MR-J4W3-□□B is available.

2. The pin is common for each axis. The axis to be used can be selected by the parameter setting. For details, refer to Section 6.28.2.

6. APPLICATION FUNCTIONS

6.28.2 Settings

(1) Servo parameters

When using the general output function of the servo amplifier, set the parameter of the output device selection as shown below.

(a) For servo amplifier MR-J4-□B

Parameter No.	MR-J4-B parameter No.	Abbreviation	Name	Setting value
11C6	PD07	*DO1	Output device selection 1	0021h
11C7	PD08	*DO2	Output device selection 2	0022h
11C8	PD09	*DO3	Output device selection 3	0023h

(b) For servo amplifier MR-J4W-□-□B

Parameter No.	MR-J4W-B parameter No.	Abbreviation	Name	Setting value
11C6	PD07	*DO1	Output device selection 1	0021h
11C7	PD08	*DO2	Output device selection 2 (Note1, 2)	1022h (when using axis A) 2022h (when using axis B) 3022h (when using axis C)
11C8	PD09	*DO3	Output device selection 3 (Note1, 2)	1023h (when using axis A) 2023h (when using axis B) 3023h (when using axis C)



Note 1. The parameter is shared with the three axes of axis A, B, and C. Always set the same value to all the axes. When the setting value differs, the value of the axis A is valid.

2. Since the pin is shared by each axis, only one axis can be assigned.

6. APPLICATION FUNCTIONS

(2) Control parameter

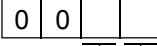
The control parameters are used to set the general I/O and to assign to the digital I/O number. When the sensor input method (parameter No.0219) is "Driver input", the input signal of the servo amplifier is used for the sensor (LSP/LSN/DOG). Therefore, the input signal cannot be used as the general input. To use the general input signal of the servo amplifier, set other than "Driver input" to the sensor input method (parameter No.0219).

Parameter No.	Abbreviation	Name	Initial value	Setting range	Function
0213	*GIOO	General I/O option	0000h	0000h to 0011h	 <p>Servo amplifier general input setting Set whether to use the general input of the servo amplifier. 0: Not used 1: Used Note: When the general input is used, the limit switch signal and the dog signal cannot be input from the servo amplifier. Set other than "Driver input" to the sensor input method (parameter No.0219).</p> <p>Servo amplifier general output setting Set whether to use the general output of the servo amplifier. 0: Not used 1: Used</p>
0214	*GDNA	General I/O number assignment	0000h	0000h to FFFFh	<p>Set assignment of the general I/O number. The setting target differs depending on the I/O table (parameter No.004A) setting. [When using a digital I/O table]</p>  <p>General input assignment Specify the first digital input area number to assign the general input. 00h to 3Fh: Digital input area 0 to 63 Example: When the digital input area number 1 is specified, 16 points are assigned from DI_010 to DI_01F. However, DI_013 to DI_01F are unavailable.</p> <p>General output assignment Specify the first digital output area number to assign the general output. 00h to 3Fh: Digital output area 0 to 63 Example: When the digital output area number 2 is specified, 16 points are assigned from DO_020 to DO_02F. However, DO_023 to DO_02F are unavailable.</p> <p>[When using a I/O device table]</p>  <p>General input assignment Specify the first input word device number that corresponds with the input bit device number to assign the general input. 00h to FFh: Input word device number 0 to FF Example: When the input word device number 01 is specified, 16 points are assigned from DVI_010 to DVI_01F. However, DVI_013 to DVI_01F are unavailable.</p> <p>General output assignment Specify the first output word device number that corresponds with the output bit device number to assign the general input. 00h to FFh: Output word device number 00 to FF Example: When the output word device number 2 is specified, 16 points are assigned from DVO_020 to DVO_02F.</p>

6. APPLICATION FUNCTIONS

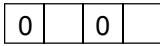
Parameter No.	Abbreviation	Name	Initial value	Setting range	Function
0219	*SOP	Sensor input option	0000h	0000h to 0304h	 <p>Sensor input system Set the input system of the sensor (LSP, LSN, DOG). 0: Not use 1: Driver input 2: Digital or input device input 3: Not connected (does not detect LSP, LSN, DOG) 4: Dual port memory input</p> <p>Limit switch signal selection Set valid/invalid of limit switch. 0: LSP/LSN are valid 1: LSP is valid, LSN is invalid 2: LSP is invalid, LSN is valid</p>

POINT

- Assign the digital I/O table not to overlap other settings. If the assignment is overlapped or exceeds the maximum points of the digital I/O table, the I/O number assignment error (system error E510) and I/O number assignment setting error (operation alarm 39, detail 01 and 02) occur.
- Assign the I/O device table not to overlap other settings. If the assignment is overlapped or exceeds the maximum points of the I/O device table, the I/O No. assignment error (system error E510) and I/O No. assignment setting error (operation alarm 39, detail 01 and 02) occur.

6. APPLICATION FUNCTIONS

6.29 Dual port memory exclusive control

6.29.1 Summary

The dual port memory exclusive control function is a function that keeps the consistency of the memory data by temporarily limiting the system program and user program to read/write data to the limited area of the dual port memory.

The output signals in this section refer to digital output signals or output device signals. The target output signal is selected in I/O table (parameter No.004A).

6.29.2 Exclusive control of output signals

If the output signal is updated from the user program during controlling of the output signal by the other axes start function, the consistency of the data may not be kept. Read/write the output signal using the exclusive control function after controlling the possessory right of the output signal.

API LIBRARY

- The sscSetDigitalOutputDataBit and sscSetDigitalOutputDataWord functions of the API library perform exclusive control of digital output within the function.
- The sscSetOutputDeviceBit function of the API library performs exclusive control of output device within the function.

(1) Interface

Address	Abbreviation	Description	Detail (Note 1)	User program data writing
EF80	DORH	Output signal host occupy request	0: No request 1: Request	○
EF82	DORB	During output signal board occupy request (Note 2)	0: No request 1: Request	×
EF84	DOCS	Output signal occupy selection	0: System program 1: User program	○
EF86 to EF8F		Reserved		

Note 1. When the data out of the range is written, the exclusive control error (system error E503) occurs, which stops the import of the output signal and the control of the output signal by the other axes start function.

2. This is the area where the data can be written only from the system program. When the data is written from the user program to this area, the exclusive control operates incorrectly.

6. APPLICATION FUNCTIONS

(2) Exclusive control procedure on user program side

The following shows the procedure to control the output signal exclusively.

(a) Exclusive control procedure

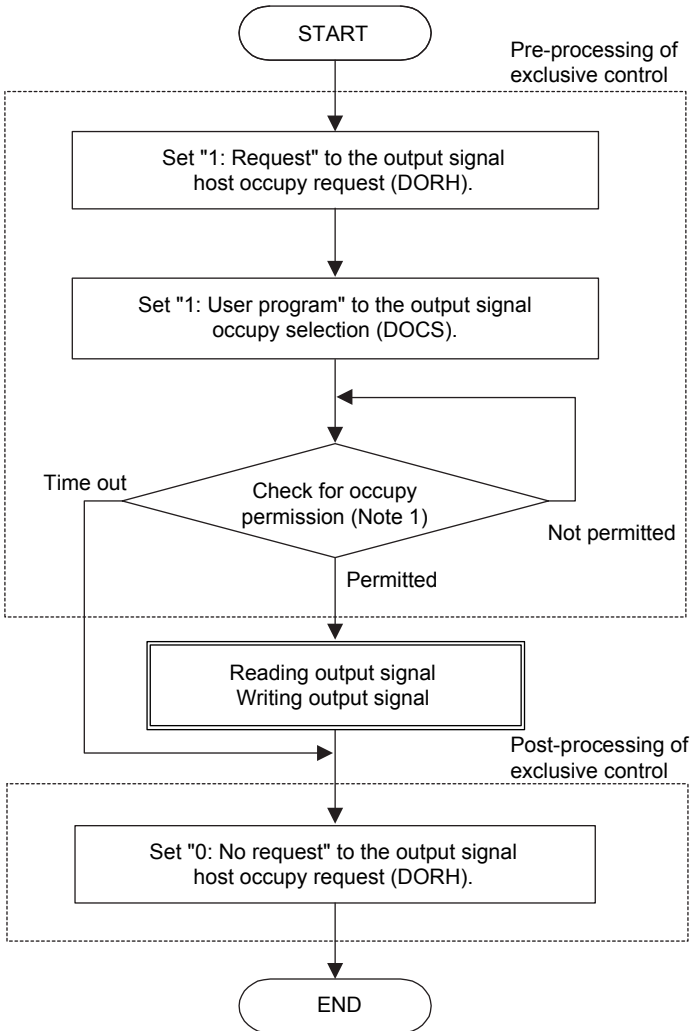

Note 1: Check for occupy permission

(1) Condition for occupy permission

When the during output signal board occupy request (DORB) is "0: No request" or the output signal occupy selection (DOCS) is "0: System program"

(2) Condition for occupy non-permission

When the during output signal board occupy request (DORB) is "1: Request" and the output signal occupy selection (DOCS) is "1: User program"

(b) Condition for occupy permission of output signal

DORH	DORB	DOCS	Occupy status of output signal	Occupy permitted/not permitted
0	0	0	No occupy	No occupy request from user program.
0	0	1	No occupy	
0	1	0	Occupied by system program.	
0	1	1	Occupied by system program.	
1	0	0	Occupied by user program.	Occupy permitted
1	0	1	Occupied by user program.	
1	1	0	Occupied by user program. (Waiting for permission from system program)	
1	1	1	Occupied by system program. (Waiting for permission from user program)	Occupy not permitted

(3) Restrictions

Perform the exclusive control so that the occupy time on the user program side is 5µs or less. If the possessory right is not shifted to the system program even after 5µs at the timing in which the system program accesses the output signal, the access to the output signal is stopped. When the access to the output signal is stopped, the access put on hold until the next control cycle.

6. APPLICATION FUNCTIONS

6.30 Pass position interrupt

6.30.1 Summary

The pass position interrupt function is a function that outputs an interrupt at when the pass position condition set in the interrupt table is satisfied. The pass position condition can be specified up to 64 conditions (total for all axes) per operation.

To use this function, set the pass position interrupt valid to the auxiliary command of the point table. The pass position condition start and end numbers are imported when the operation is started. The pass position condition is imported and the pass position is judged for each condition from the pass position condition start number.

When the pass position condition is satisfied, the factor of an interrupt corresponding to the pass position condition number is output. Then, the next pass position condition is imported and judged.

The pass position condition is judged until the in-position signal (INP) turns on.

To output the interrupt, set the pass position interrupt to the system interrupt condition (system parameter No.0004) and turn on the interrupt output valid (ITS).

POINT
<ul style="list-style-type: none">▪ This function can be used only in the automatic operation and linear interpolation operation. For the linear interpolation operation, the pass position condition can be set per axis.▪ During the pass position interrupt, the pass position interrupt condition numbers from the start to the end are in use. When the pass position condition is in use in other axes, a pass position interrupt error (operation alarm 5C, detail 05) occurs and the start operation is stopped.▪ When the operation is started again before all the interrupts by the pass position interrupt are output, a pass position interrupt error (operation alarm 5C, detail 06) occurs and the start operation is stopped.▪ In the synchronous mode of the tandem drive, only the setting of the master axis is valid and this function outputs the interrupt based on the operation of the master axis.

6. APPLICATION FUNCTIONS

6.30.2 Pass position interrupt setting method

The pass position interrupt setting procedure is as follows.

- (1) Set the pass position conditions.
- (2) Validate the pass position interrupt specifications of the point data.
- (3) Set the pass position condition start number and end number.
- (4) Start automatic operation or linear interpolation operation..
- (5) Wait until the conditions of the pass position interrupt are fulfilled.

API LIBRARY

- Use the `sscSetIntPassPositionData` function for setting of pass position interrupt in (1) above.
- Use the `sscSetPointDataEx` function for setting of the point table in (2) above.
- Use the `sscSetStartingPassNumber` function to set pass position condition start number and end number in (3) above.
- Use the `sscAutoStart/sscLinearStart` functions for starting operations in (4) above.
- Use the `sscWaitIntPassPosition` function for wait for pass position interrupt in (5) above.
- For a detailed procedure for pass position interrupt, refer to the sample program (`InterruptPassPosition`) contained on the utility software.

6. APPLICATION FUNCTIONS

6.30.3 Interface

(1) Pass position interrupt table

The pass position condition (pass position option and pass position data) is set to the pass position interrupt table.

The pass position condition is imported when the corresponding pass position condition number is started to be judged.

POINT	
	<ul style="list-style-type: none"> When the pass position condition setting is incorrect, a pass position interrupt error (operation alarm 5C, detail 04) occurs and the operation is stopped.

API LIBRARY	
	<ul style="list-style-type: none"> Use the sscSetIntPassPositionData/sscCheckIntPassPositionData functions to set/get pass position interrupt data.

Pass position interrupt table

A640h	Pass position condition 1 (8 bytes)	Pass position option
		Pass position data
A648h	Pass position condition 2 (8 bytes)	Pass position option
		Pass position data
A650h	Pass position condition 3 (8 bytes)	Pass position option
		Pass position data
A658h	Pass position condition 4 (8 bytes)	Pass position option
		Pass position data
A660h	Pass position condition 5 (8 bytes)	Pass position option
		Pass position data
A668h	Pass position condition 6 (8 bytes)	Pass position option
		Pass position data
A670h	Pass position condition 7 (8 bytes)	Pass position option
		Pass position data
A678h	Pass position condition 8 (8 bytes)	Pass position option
		Pass position data
A680h	Pass position condition 9 (8 bytes)	Pass position option
		Pass position data
A688h	Pass position condition 10 (8 bytes)	Pass position option
		Pass position data
A690h	Pass position condition 11 (8 bytes)	Pass position option
		Pass position data
A698h	Pass position condition 12 (8 bytes)	Pass position option
		Pass position data
A6A0h	Pass position condition 13 (8 bytes)	Pass position option
		Pass position data
	:	:
A838h	Pass position condition 64	Pass position option
A83Fh	(8 bytes)	Pass position data

6. APPLICATION FUNCTIONS

(a) Details on pass position option

Address	Name	Unit	Setting range	Initial value	Remarks
A640	Pass position option (4 bytes)		00000000h to 00000011h	00000000h	<div style="display: flex; align-items: center;"> <div style="border: 1px solid black; padding: 2px; margin-right: 10px;"> 0 0 0 0 0 0 </div> <div style="border-left: 1px solid black; border-right: 1px solid black; border-bottom: 1px solid black; padding: 2px; margin-right: 10px;"> </div> <div style="border-left: 1px solid black; border-right: 1px solid black; border-bottom: 1px solid black; padding: 2px;"> </div> </div> <p>Pass direction Set the pass direction for the pass position data. 0: + direction pass position interrupt output 1: - direction pass position interrupt output</p> <p>Judgment condition Set the judgment condition for the pass position data. 0: Current command position 1: Current feedback position Note. Only the setting for the pass position condition start number is valid.</p>

Note. The above address is the address for the pass position condition 1. For the pass position condition 2 and above, increase in units of 8h for each number.

(b) Details on the pass position data

Address	Name	Unit	Setting range	Initial value	Remarks
A644	Pass position data (4 bytes)	Command unit	-2147483648 to 2147483647	0	Set the pass position data at the pass position interrupt output.

Note. The above address is the address for the pass position condition 1. For the pass position condition 2 and above, increase in units of 8h for each number.

POINT
<ul style="list-style-type: none"> ▪ Set the pass position condition in passing order since the pass position conditions are judged one by one in ascending order of the pass position condition number. ▪ The interrupt is output only once for each pass position condition. ▪ When a passed position is the pass position condition, the interrupt is not output until the position is passed again. ▪ Ensure one control cycle or longer between two pass position conditions. ▪ Only the judgment condition for the pass position condition start number is valid only for the pass position option. The judgment condition is used for each pass position data as the common setting. (The judgment condition cannot be set individually for each pass position condition.) ▪ When the current feedback position is selected as the judgment condition for the pass position data, do not set the pass position data within the in-position range. The pass position interrupt may not be output since the pass position judgment ends when the in-position signal (INP) turns on.

6. APPLICATION FUNCTIONS

(2) Point table and auxiliary command

To use the pass position interrupt, set the pass position interrupt valid to the auxiliary command of the point table.

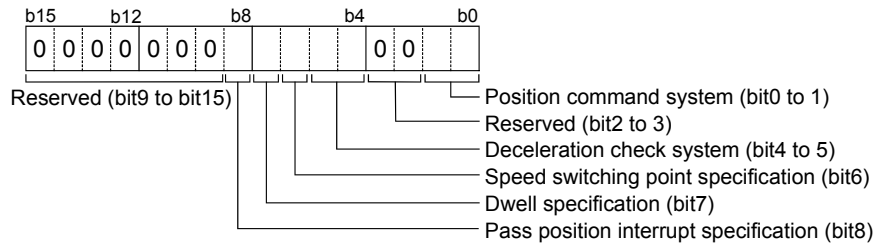

(a) Pass position interrupt specification

Select valid/invalid for the pass position interrupt.

0: Pass position interrupt invalid

1: Pass position interrupt valid

POINT
<ul style="list-style-type: none"> This setting in the point data of the start point No. is valid only. If the point data after the start number are set, it causes a point table setting error (operation alarm 25, detail 0C) and the operation is stopped.

API LIBRARY
<ul style="list-style-type: none"> Use the sscSetPointDataEx/sscCheckPointDataEx functions to set/get point data.

6. APPLICATION FUNCTIONS

(3) Axis command data/axis status data

The pass position is judged according to the pass position condition specified in the start number and end number of the pass position condition.

(a) Axis command data

Address	Name	Setting range	Remarks
1034	Pass position condition start number (2 bytes)	1 to 64	Set the start number of the pass position condition for the pass position interrupt.
1036	Pass position condition end number (2 bytes)	1 to 64	Set the end number for the pass position condition for the pass position interrupt.

Note 1. The above addresses are the addresses for the axis 1. For the axis 2 and above, increase in units of C0h for each axis.

2. When using only one pass position condition, set the same number for the start number and end number.

POINT
<ul style="list-style-type: none"> ▪ When the pass position condition used in other axis is imported, a pass position interrupt error (operation alarm 5C, detail 05) occurs and the operation is stopped. Do not use the same pass position condition number for multiple axes. ▪ When the pass position condition start number is out of range, a pass position interrupt error (operation alarm 5C, detail 01) occurs and the operation is stopped. ▪ When the pass position condition end number is out of range, a pass position interrupt error (operation alarm 5C, detail 02) occurs and the operation is stopped. ▪ When the pass position condition start number is smaller than the pass position condition end number, a pass position interrupt error (operation alarm 5C, detail 03) occurs and the operation is stopped.

API LIBRARY
<ul style="list-style-type: none"> ▪ Use the <code>sscSetStartingPassNumber</code> function to set the pass condition start and end numbers.

(b) Axis status data

Address	Name	Output limits	Remarks
1094	Executing pass position condition number (2 bytes)	0 to 64	Outputs the running pass position condition number. After the pass position condition completion, the last pass position condition number is displayed. When the pass position interrupt processing is canceled due to the pass position condition setting error, an operation alarm, or other factors, the pass position condition number where an error occurs is displayed. When the operation is started with the pass position interrupt invalid, 0 is output.

Note. The above address is the address for the axis 1. For the axis 2 and above, increase in units of C0h for each axis.

6. APPLICATION FUNCTIONS

(4) Axis command/axis status bit

The axis status bits related to the pass position interrupt function are shown below.

(a) Axis command bit

Address	Bit	Abbreviation	Signal name
1007	0	PPISTP	Pass position interrupt cancel
	1	\	Reserved
	2		
	3		
	4		
	5		
	6		
	7		

Note. The above address is the address for the axis 1. For the axis 2 and above, increase in units of C0h for each axis.

(b) Axis status bit

Address	Bit	Abbreviation	Signal name
1067	0	PPIOP	Pass position interrupt
	1	PPIFIN	Pass position interrupt complete
	2	PPIERR	Pass position interrupt incomplete
	3	\	Reserved
	4		
	5		
	6		
	7	AUTLO	In point table loop

Note. The above address is the address for the axis 1. For the axis 2 and above, increase in units of C0h for each axis.

(c) Details on axis command bit

Abbreviation	Signal name	Function details
PPISTP	Pass position interrupt cancel	<p>[Function] Cancels the pass position interrupt.</p> <p>[Operation] Turn on this signal to cancel the pass position interrupt when the pass position interrupt signal (PPIOP) is on.</p>

6. APPLICATION FUNCTIONS

(d) Details on axis status bit

Abbreviation	Signal name	Function details
PPIOP	Pass position interrupt	<p>[Function] Notifies the pass position interrupt is being performed.</p> <p>[Operation] <Conditions for turning on> The start and end number of the pass position interrupt are specified and the pass position interrupt is performed. <Conditions for turning off> The pass position interrupt complete signal (PPIFIN) is turned on or the pass position interrupt incomplete signal (PPIERR) is turned on.</p>
PPIFIN	Pass position interrupt complete	<p>[Function] Notifies the pass position interrupt is completed.</p> <p>[Operation] <Conditions for turning on> All interrupt outputs are completed in the pass position interrupt. <Conditions for turning off> The start and end number of the pass position interrupt are specified and the pass position interrupt is performed.</p>
PPIERR	Pass position interrupt incomplete	<p>[Function] Notifies the pass position interrupt is canceled.</p> <p>[Operation] <Conditions for turning on></p> <ul style="list-style-type: none"> • The operation is canceled due to an operation alarm, servo alarm, or an operation stop command while the pass position interrupt signal (PPIOP) is on. • Not all pass position interrupt outputs are completed even when the in-position signal (INP) is turned on after the operation completion while the pass position interrupting signal (PPIOP) is on. • The pass position interrupt cancel signal (PPISTP) is turned on while the pass position interrupt (PPIOP) is on. <p><Conditions for turning off> The start and end number of the pass position interrupt are specified and the pass position interrupt is performed.</p>

API LIBRARY

- To turn the pass position interrupt cancel command (PPISTP) ON/OFF, set SSC_CMDBIT_AX_PPISTP to the command bit number of the sscSetCommandBitSignalEx function.
- For the pass position interrupt start statuses below, set the following to the status bit number with the sscGetStatusBitSignalEx or sscWaitStatusBitSignalEx function to check if the statuses are ON/OFF.
 - Pass position interrupt (PPIOP) : SSC_STSBIT_AX_PPIOP
 - Pass position interrupt complete (PPIFIN) : SSC_STSBIT_AX_PPIFIN
 - Pass position interrupt incomplete (PPIERR): SSC_STSBIT_AX_PPIERR

6. APPLICATION FUNCTIONS

(5) Interrupt conditions (system parameters)

Set the values that designate ON for the bits that correspond to the factor of pass position interrupt outputting to the parameter interrupt conditions (parameter No.0004) to validate the interrupt output of the pass position interrupt.

Parameter No.0004 Interrupt conditions

Bit	Abbreviation	Name
0	SYSE	Current system error
1	CALM	Current system alarm
2	EMIO	During forced stop
3	/	Reserved
4		
5		
6		
7	OCME	Operation cycle alarm

Bit	Abbreviation	Name
8	OASF	Outputting with factor of other axes start interrupt
9	PPI	Outputting with factor of pass position interrupt
10	/	Reserved
11		
12		
13		
14		
15		

API LIBRARY

- Use the sscChange2Parameter/sscCheck2Parameter functions to set/get interrupt conditions.

6. APPLICATION FUNCTIONS

(6) Factor of system interrupt

API LIBRARY

- Use the `sscResetIntPassPosition/sscSetIntPassPosition/sscWaitIntPassPosition` functions for reset/set/wait of pass position interrupt events.

(a) Factor of system interrupt

Address	Content
0590	Factor of system interrupt
0591	
0592	Reserved
0593	
0594	Factor of other axes start interrupt
0595	
0596	
0597	
0598	Factor of pass position interrupt
0599	
059A	
059B	
059C	
059D	
059E	
059F	
05A0	Reserved
:	
05AF	

6. APPLICATION FUNCTIONS

(b) Details on factor of system interrupt

When the pass position data is passed, the factor of outputting with factor of pass position interrupt (iPPI) of the details on factor of system interrupt is turned on. For details on the factor of interrupt according to the pass position condition, refer to Section 6.30.3 (7).

Address	Bit	Abbreviation (Note)	Signal name
0590 to 0591	0	iSYSE	System error (interrupt)
	1	iCALM	System alarm (interrupt)
	2	iEMIO	During forced stop (interrupt)
	3	\	Reserved
	4		
	5		
	6		
	7	iOCME	Operation cycle alarm (interrupt)
	8	iOASF	Outputting with factor of other axes start interrupt (interrupt)
	9	iPPI	Outputting with factor of pass position interrupt (interrupt)
	10	\	Reserved
	11		
	12		
	13		
	14		
	15		

Note. OFF: No factor of interrupt exists.

ON: A factor of interrupt exists.

6. APPLICATION FUNCTIONS

(7) Factor of pass position interrupt

When the outputting with factor of pass position interrupt (iPPI) is on, the bit corresponding to the pass position condition number of the factor of the pass position interrupt turns on.

Address	Bit	Abbreviation	Signal name
0598 to 059B	0	iPPI1	Pass position data 1 (interrupt)
	1	iPPI2	Pass position data 2 (interrupt)
	2	iPPI3	Pass position data 3 (interrupt)
	3	iPPI4	Pass position data 4 (interrupt)
	4	iPPI5	Pass position data 5 (interrupt)
	5	iPPI6	Pass position data 6 (interrupt)
	6	iPPI7	Pass position data 7 (interrupt)
	7	iPPI8	Pass position data 8 (interrupt)
	8	iPPI9	Pass position data 9 (interrupt)
	9	iPPI10	Pass position data 10 (interrupt)
	10	iPPI11	Pass position data 11 (interrupt)
	11	iPPI12	Pass position data 12 (interrupt)
	12	iPPI13	Pass position data 13 (interrupt)
	13	iPPI14	Pass position data 14 (interrupt)
	14	iPPI15	Pass position data 15 (interrupt)
	15	iPPI16	Pass position data 16 (interrupt)
	16	iPPI17	Pass position data 17 (interrupt)
	17	iPPI18	Pass position data 18 (interrupt)
	18	iPPI19	Pass position data 19 (interrupt)
	19	iPPI20	Pass position data 20 (interrupt)
	20	iPPI21	Pass position data 21 (interrupt)
	21	iPPI22	Pass position data 22 (interrupt)
	22	iPPI23	Pass position data 23 (interrupt)
	23	iPPI24	Pass position data 24 (interrupt)
	24	iPPI25	Pass position data 25 (interrupt)
	25	iPPI26	Pass position data 26 (interrupt)
	26	iPPI27	Pass position data 27 (interrupt)
	27	iPPI28	Pass position data 28 (interrupt)
	28	iPPI29	Pass position data 29 (interrupt)
	29	iPPI30	Pass position data 30 (interrupt)
	30	iPPI31	Pass position data 31 (interrupt)
	31	iPPI32	Pass position data 32 (interrupt)

Address	Bit	Abbreviation	Signal name
059C to 059F	0	iPPI33	Pass position data 33 (interrupt)
	1	iPPI34	Pass position data 34 (interrupt)
	2	iPPI35	Pass position data 35 (interrupt)
	3	iPPI36	Pass position data 36 (interrupt)
	4	iPPI37	Pass position data 37 (interrupt)
	5	iPPI38	Pass position data 38 (interrupt)
	6	iPPI39	Pass position data 39 (interrupt)
	7	iPPI40	Pass position data 40 (interrupt)
	8	iPPI41	Pass position data 41 (interrupt)
	9	iPPI42	Pass position data 42 (interrupt)
	10	iPPI43	Pass position data 43 (interrupt)
	11	iPPI44	Pass position data 44 (interrupt)
	12	iPPI45	Pass position data 45 (interrupt)
	13	iPPI46	Pass position data 46 (interrupt)
	14	iPPI47	Pass position data 47 (interrupt)
	15	iPPI48	Pass position data 48 (interrupt)
	16	iPPI49	Pass position data 49 (interrupt)
	17	iPPI50	Pass position data 50 (interrupt)
	18	iPPI51	Pass position data 51 (interrupt)
	19	iPPI52	Pass position data 52 (interrupt)
	20	iPPI53	Pass position data 53 (interrupt)
	21	iPPI54	Pass position data 54 (interrupt)
	22	iPPI55	Pass position data 55 (interrupt)
	23	iPPI56	Pass position data 56 (interrupt)
	24	iPPI57	Pass position data 57 (interrupt)
	25	iPPI58	Pass position data 58 (interrupt)
	26	iPPI59	Pass position data 59 (interrupt)
	27	iPPI60	Pass position data 60 (interrupt)
	28	iPPI61	Pass position data 61 (interrupt)
	29	iPPI62	Pass position data 62 (interrupt)
	30	iPPI63	Pass position data 63 (interrupt)
	31	iPPI64	Pass position data 64 (interrupt)

6. APPLICATION FUNCTIONS

(8) Details on factor of pass position interrupt

When the outputting with factor of pass position interrupt (iPPI□) is on, the pass position status bit corresponding to the pass position condition number (1 to 64) turns on.

(a) Details on factor of pass position interrupt

Address	Content	
0FA0	Details on factor of pass position interrupt (64 bytes)	Details on factor of pass position interrupt 1
0FA1		Details on factor of pass position interrupt 2
0FA2		Details on factor of pass position interrupt 3
0FA3		Details on factor of pass position interrupt 4
:		:
0FDF		Details on factor of pass position interrupt 64

(b) Details on factor of pass position interrupt □

Address	Bit	Abbreviation	Signal name
0FA0	0	iPPIF□	Pass position interrupt complete □ (interrupt)
	1	iPPIE□	Pass position interrupt incomplete □ (interrupt)
	2	\	Reserved
	3		
	4		
	5		
	6		
	7		

- Note 1. The above address is the address for the pass position condition number 1. For the pass position condition number 2 and above, increase in units of 01h for each number.
2. □ indicates the pass position condition number (1 to 64).

6. APPLICATION FUNCTIONS

6.30.4 Operation example

(1) When the pass position interrupt is complete

The pass position interrupt (PPIOP) turns on between the operation start and the completion of all pass position interrupt outputs. When the pass position condition is satisfied, the factor of interrupt of the "pass position interrupt complete □" (□: pass position condition number) turns on and the interrupts are output. The pass position interrupt (PPIOP) turns off and the pass position interrupt complete (PPIFIN) turns on when all of pass position interrupts are output.

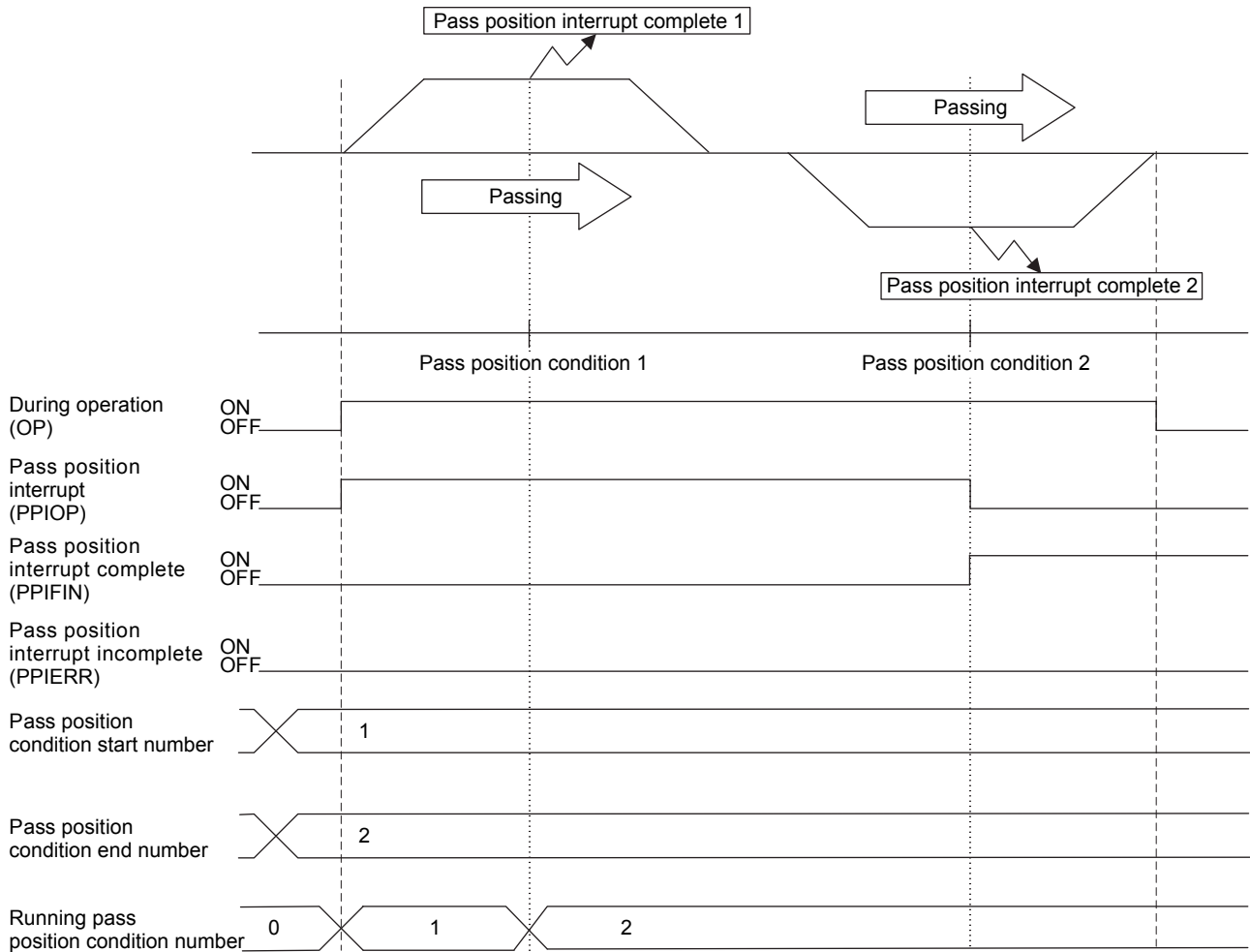

6. APPLICATION FUNCTIONS

(2) When the pass position interrupt fails

When the operation is canceled due to an operation alarm preceding the satisfaction of the pass position condition, the pass position interrupt incomplete (PPIERR) turns on. The pass position interrupt incomplete (PPIERR) turns on under the following conditions.

At this time, the factor of interrupt of the "pass position interrupt error condition □" (□: pass position condition number) turns on to the running and unexecuted pass position interrupt conditions and the interrupt is output.

- (a) The setting of the pass position condition is incorrect.
- (b) Operation is canceled by turning on the stop operation signal (STP) or the rapid stop signal (RSTP) before the pass position condition is satisfied.
- (c) Operation is canceled by an operation alarm, etc. before the pass position condition is satisfied.
- (d) Operation is completed and the in-position signal is turned on before the pass position condition is satisfied.

[Example of when an operation alarm occurs]

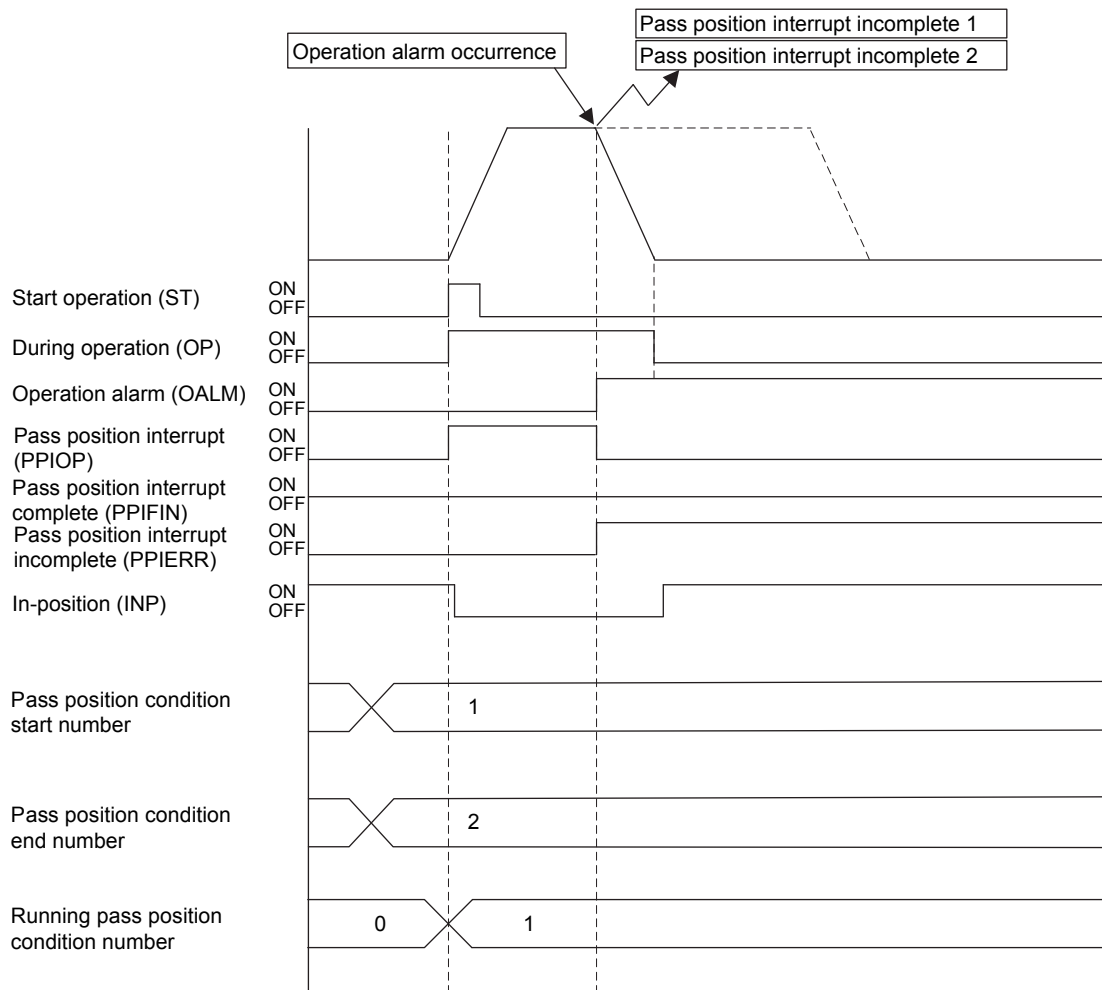

6. APPLICATION FUNCTIONS

[Example of when operation is completed]

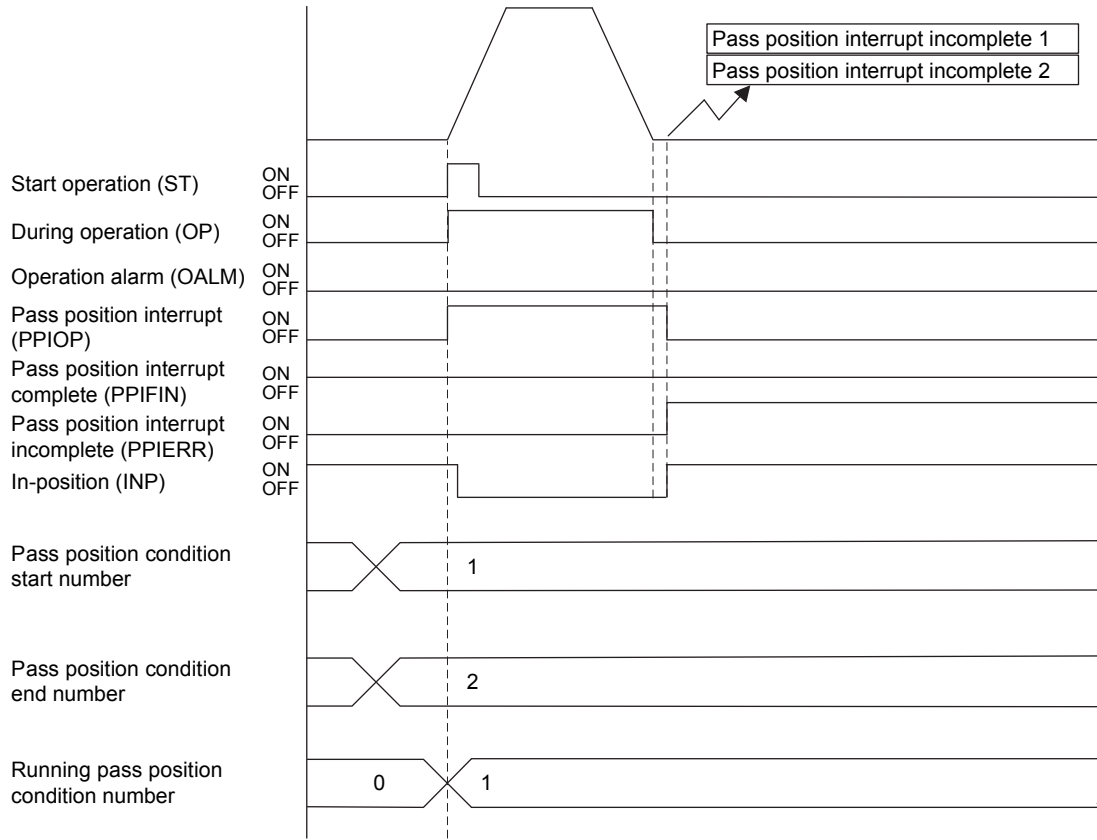

6. APPLICATION FUNCTIONS

(3) When the pass position interrupt is canceled

When the pass position interrupt cancel (PPISTP) is turned on preceding the satisfaction of the pass position condition, the pass position interrupt incomplete (PPIERR) turns on. At this time, the factor of interrupt of the "pass position interrupt error condition □" (□: pass position condition number) turns on to the running and unexecuted pass position interrupt conditions and the interrupt is output.

[Example of when the pass position interrupt is canceled]

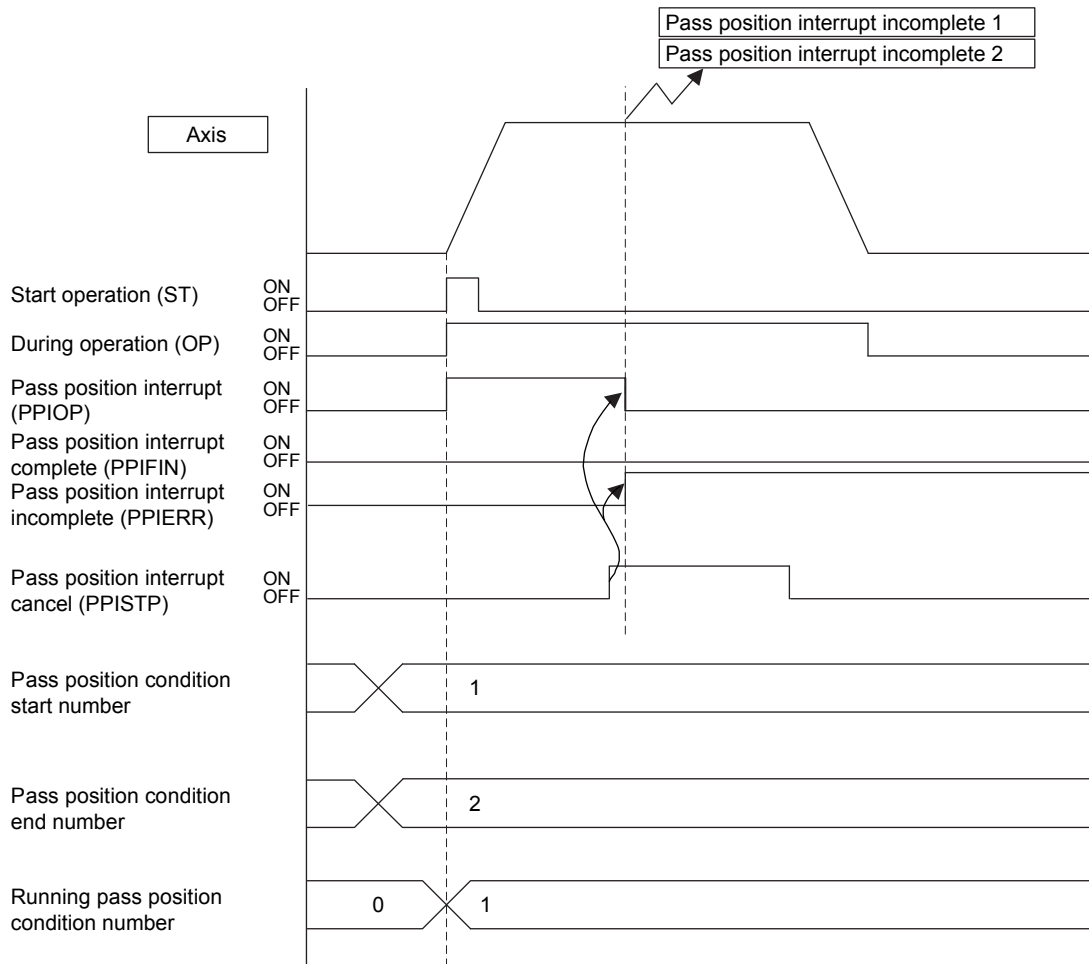

POINT
<ul style="list-style-type: none"> When the operation is started with the pass position specification of the point table and auxiliary command valid while the pass position interrupt cancel signal (PPISTP) is on, a pass position interrupt error (operation alarm 5C, detail 07) occurs and the start operation is canceled. At this time, the pass position interrupt incomplete signal (PPIERR) turns on.

6. APPLICATION FUNCTIONS

6.31 Mark detection

6.31.1 Summary

Mark detection is a function that gets the positioning data at the timing of when a mark detection signal is input to the servo amplifier, and outputs to the dual port memory. This function is compatible with SSCNET III/H communication method only.

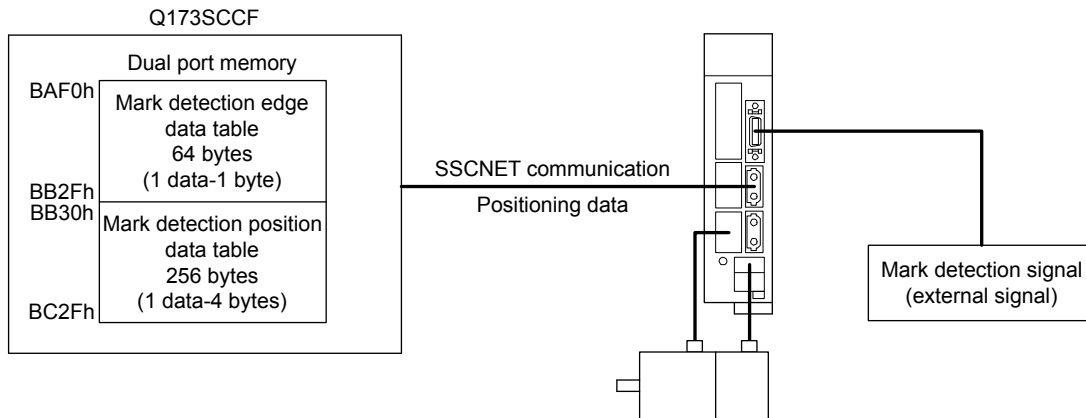

Three methods for mark detection modes can be selected.

- Continuous detection mode
- Specified number of detection mode
- Ring buffer mode

Additionally, the range of the mark detection positioning data can be specified, so only data within the specified range is latched.

When interrupt conditions 2 (parameter No.0205) is enabled and mark detection signal is detected, an interrupt can be generated. However, when not using the interrupt, or in interface mode, the mark detection counter must be monitored at all times.

Item	Performance specifications
Number of mark detection settings	Up to 2 settings for each axis
Input signal	External input signal (within DI1 to DI3, 2 points) of each servo amplifier
Input signal detection direction	Leading edge/trailing edge detection in logic setting (ON edge detection setting, OFF edge detection setting) of external input signal can be selected
Detection accuracy	55 μ s (input signal filter (0 to 444 μ s) can be selected in parameter setting)
Detection delay	0.3ms or less + filter setting value (0 to 0.444ms) Note. Sensor delay time is not included
Input signal minimum width	0.88ms (make ON/OFF width 0.88ms or more)
Latch data	2 types (current feedback position [command units], current feedback position [pulse])
Number of continuous latch data storages	Up to 64 (the whole system)
Latch data range	Within the range of -2147483648 to 2147483647 can be specified

6. APPLICATION FUNCTIONS

The following shows the update timing of mark detection positioning data and mark detection edge data when a mark detection signal is detected and both ON/OFF edges are enabled in the mark detection data settings.

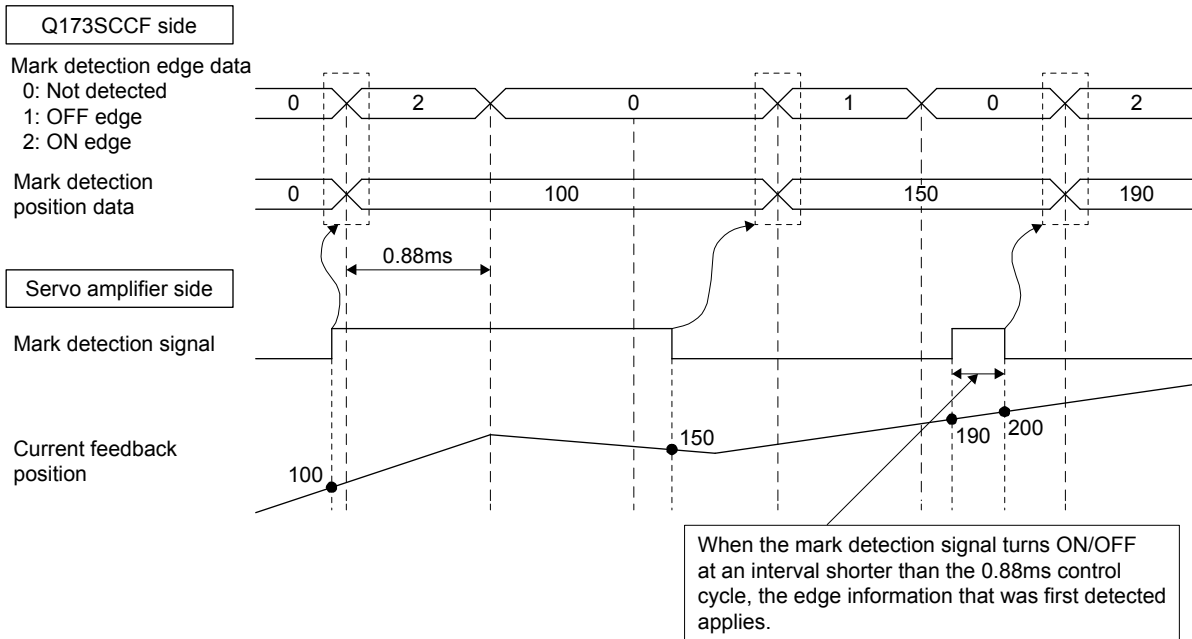

Use a software version that supports mark detection for the servo amplifier. Mark detection is compatible with SSCNET III/H communication method only. Servo amplifier software versions that support mark detection are shown in the table below.

Servo amplifier model	Software version
MR-J4-□B□(-RJ)	B4 or later
MR-J4W2-□B	Not supported
MR-J4W3-□B	Not supported

6. APPLICATION FUNCTIONS

POINT	
	<ul style="list-style-type: none">• For communication methods other than SSCNETⅢ/H, a mark detection setting error (operation alarm 3B, detail No.01) occurs.• When a servo amplifier that does not support mark detection is used, a mark detection setting error (operation alarm 3B, detail No.02) occurs.• Check that the user program does not omit any detections to avoid cases where mark detection signals are not properly detected, and communication errors occurrences etc.• In the following cases, depending on the specifications of the servo amplifier, the correct positioning data may not be got.<ol style="list-style-type: none">1) The ON/OFF width of mark detection signals is shorter than the control cycle of 0.88ms.2) Servo alarm has occurred.• When an input other than driver input is set to sensor input method (parameter No.0219), and general input setting is set to "Used" for general I/O option (parameter No.0213), the current status of mark detection signals can be checked with servo amplifier general input.• When driver input is set to sensor input method (parameter No.0219), the current status of mark detection signals can be checked with sensors (LSP/LSN/DOG).

6. APPLICATION FUNCTIONS

(1) Continuous detection mode

Mark detection data is stored in the mark detection data storage area (one buffer) for every mark detection.

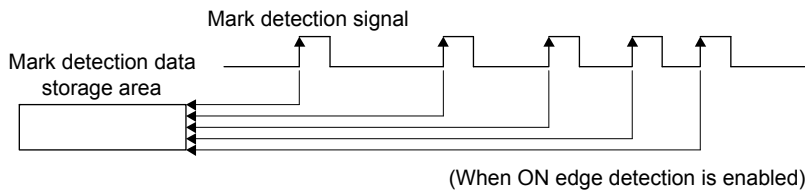

(2) Specified number of detection mode

Only the mark detection data for a set number of detections is stored. When the mark detection signal is continuously input at a high frequency, positions for a set number of mark detections can be collected.

Example: When the number of detections is 4

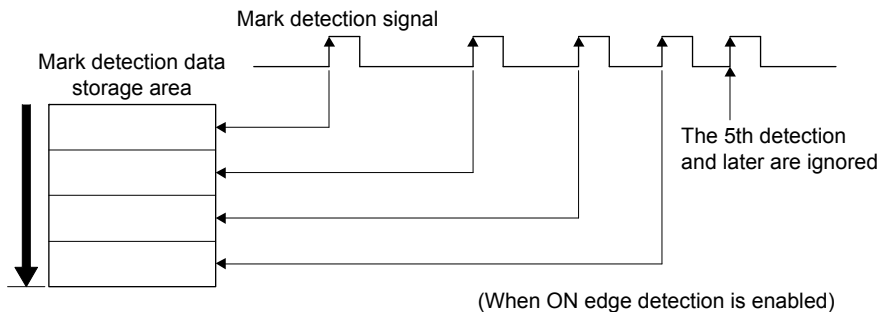

(3) Ring buffer mode

Latched data is stored in a ring buffer for the specified number of detections (number of continuous latch data storages in parameter settings).

Example: When the number of detections is 4

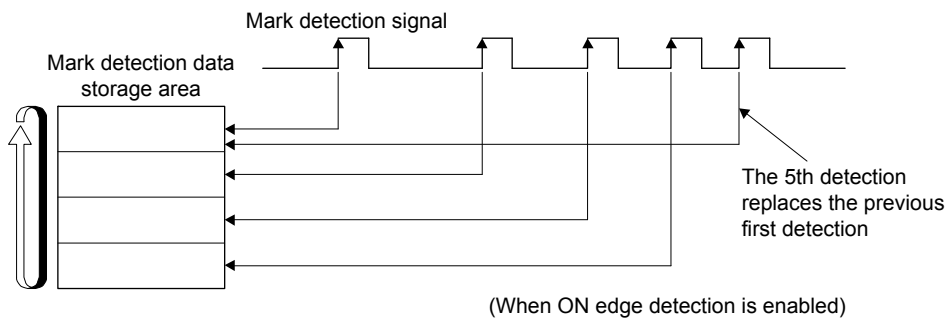

POINT

- Because of the time taken to get latch data by SSCNET communication, the delay time for the data to reach the user program side is approximately $0.88\text{ms} + (\text{control cycle} \times 2)$.
(Approximately 2.7ms when control cycle is 0.88ms.)



6. APPLICATION FUNCTIONS

6.31.2 Interface

(1) Servo parameter (MR-J4-□B□(-RJ))

Parameter No.	MR-J4-B Parameter No.	Abbreviation	Name	Setting value
11CA	PD11	*DIF	Input filter setting	 <p>Mark detection input signal filter selection Set the mark detection input signal filter selection.</p> <p>0: No setting 1: 0.111[ms] 2: 0.222[ms] 3: 0.444[ms]</p>

(2) Control parameter

Parameter No.	Abbreviation	Name	Initial value	Units	Setting range	Function
02B0	*MKOP1	Mark detection option 1	0000h		0000h to 3F23h	 <p>Mark detection signal number specification 1 Set the mark detection signal number to be used.</p> <p>0 : Invalid 1 to 3: Mark detection signal number (DI1 to DI3)</p> <p>Mark detection mode Set the mark detection mode</p> <p>0: Continuous detection mode 1: Specified number of detection mode 2: Ring buffer</p> <p>Number of continuous latch data storages (Note) Set the number of data that can be latched continuously.</p> <p>00h to 3Fh: Number of continuous latch data storages-1 Note. Up to 64 can be set in the whole system.</p>
02B1	MKDS1	Mark detection data setting 1	0000h		0000h to 0111h	 <p>ON edge detection setting Set enable/disable for detection at ON edge.</p> <p>0: Disable 1: Enable</p> <p>OFF edge detection setting Set enable/disable for detection at OFF edge.</p> <p>0: Disable 1: Enable</p> <p>Mark detection data type Set the type of data to be stored as mark detection data.</p> <p>0: Current feedback position [command units] 1: Current feedback position[pulse]</p>
02B2	*MKOP2	Mark detection option 2	0000h		0000h to 3F23h	Same as mark detection option 1.
02B3	MKDS2	Mark detection data setting 2	0000h		0000h to 0111h	Same as mark detection data setting 1.

6. APPLICATION FUNCTIONS

Parameter No.	Abbreviation	Name	Initial value	Units	Setting range	Function
02B4	MKNL1	Latch data range lower limit 1 (lower)	0000h		0000h to FFFFh	Specify the range (lower limit) of data to be latched at detection of the mark detection signal of mark detection signal number specification 1. (Note1), (Note 2)
02B5	MKNH1	Latch data range lower limit 1 (upper)	0000h		0000h to FFFFh	
02B6	MKXL1	Latch data range upper limit 1 (lower)	0000h		0000h to FFFFh	Specify the range (upper limit) of data to be latched at detection of the mark detection signal of mark detection signal number specification 1. (Note1), (Note 2)
02B7	MKXH1	Latch data range upper limit 1 (upper)	0000h		0000h to FFFFh	
02B8	MKNL2	Latch data range lower limit 2 (lower)	0000h		0000h to FFFFh	Same as latch data range lower limit 1.
02B9	MKNH2	Latch data range lower limit 2 (upper)	0000h		0000h to FFFFh	
02BA	MKXL2	Latch data range upper limit 2 (lower)	0000h		0000h to FFFFh	Same as latch data range upper limit 1.
02BB	MKXH2	Latch data range upper limit 2 (upper)	0000h		0000h to FFFFh	

Note 1. When changed while system is running, changes are enabled when a mark detection settings enable command is input.

2. The set units are regarded as command units, or pulse units (the unit set in mark detection data type (parameter No.02B1)).

API LIBRARY

- Use the sscChange2Parameter/sscCheck2Parameter functions to set/get mark detection.

6. APPLICATION FUNCTIONS

(3) Mark detection command/status data

(a) Mark detection command table

Address	Name	Setting range	Remarks	When in tandem drive
B4F0	Read complete buffer number 1	0 to 255	Set the mark detection data table number that was read after reading the mark detection edge data and mark detection positioning data of mark detection 1.	Each axis
B4F1	Read complete buffer number 2	0 to 255	Same as read complete buffer number 1.	Each axis
B4F2 to B4FF	Reserved			

Note. The addresses above are the addresses for the first axis. For the second axis and after, increase by 20h for each axis.

(b) Mark detection status table

Address	Name	Output limits	Remarks	When in tandem drive
B500	Start data storage area 1	0 to 63	Stores the start number of latch data storage for the mark detection signal set in mark detection signal number specification 1 (parameter No.02B0).	Each axis
B501	Number of continuous latch data storages 1	0 to 64	Stores the number of continuous latch data storages set in mark detection signal number specification 1 (parameter No.02B0). (Stores 0 for axes not using the mark detection function.)	Each axis
B502	Mark detection counter 1	Continuous detection: 0 to 255 Specified No. of detection, Ring buffer: 0 to 64	Counter that is incremented when latch data for the mark detection signal set in mark detection signal number specification 1 (parameter No.02B0) is stored. In continuous detection mode, the count starts again from 1 after the 255th count. In ring buffer mode, the count starts again from 1 after the number of continuous latch data storages has been reached. In specified number of detection mode, and ring buffer mode use a "clear command" to clear to 0.	Each axis
B503	Mark detection mode 1	0 to 2	Stores the mark detection mode for mark detection set in mark detection signal number specification 1 (parameter No.02B0). • 0: Continuous detection mode • 1: Specified number of detection mode • 2: Ring buffer mode	Each axis

Note. The addresses above are the addresses for the first axis. For the second axis and after, increase by 20h for each axis.

6. APPLICATION FUNCTIONS

Address	Name	Output limits	Remarks	When in tandem drive
B504	Start data storage area 2	0 to 63	Same as start data storage area 1.	Each axis
B505	Number of continuous latch data storages 2	0 to 64	Same as number of continuous latch data storages 1.	Each axis
B506	Mark detection counter 2	Continuous detection: 0 to 255 Specified No. of detection, Ring buffer: 0 to 64	Same as mark detection counter 1.	Each axis
B507	Mark detection mode 2	0 to 2	Same as mark detection mode 1.	Each axis
B50C to B50F	Reserved			

Note. The addresses above are the addresses for the first axis. For the second axis and after, increase by 20h for each axis.

6. APPLICATION FUNCTIONS

(4) Mark detection data table

(a) Mark detection edge data table

Address	Content
BAF0	Mark detection edge data 0 0: Not detected 1: OFF edge 2: ON edge
BAF1	Mark detection edge data 1
BAF2	Mark detection edge data 2
BAF3	Mark detection edge data 3
BAF4	Mark detection edge data 4
BAF5	Mark detection edge data 5
BAF6	Mark detection edge data 6
BAF7	Mark detection edge data 7

Address	Content
BAF8	Mark detection edge data 8
BAF9	Mark detection edge data 9
BAFA	Mark detection edge data 10
:	:
BB2C	Mark detection edge data 60
BB2D	Mark detection edge data 61
BB2E	Mark detection edge data 62
BB2F	Mark detection edge data 63

(b) Mark detection positioning data table

Address	Content
BB30	Mark detection positioning data 0
BB31	
BB32	
BB33	Mark detection positioning data 1
BB34	
BB35	
BB36	Mark detection positioning data 2
BB37	
BB38	
BB39	Mark detection positioning data 3
BB3A	
BB3B	
BB3C	Mark detection positioning data 4
BB3D	
BB3E	
BB3F	Mark detection positioning data 5
BB40	
BB41	
BB42	Mark detection positioning data 6
BB43	
BB44	
BB45	Mark detection positioning data 7
BB46	
BB47	
BB48	Mark detection positioning data 8
BB49	
BB4A	
BB4B	Mark detection positioning data 9
BB4C	
BB4D	
BB4E	Mark detection positioning data 10
BB4F	

Address	Content
BB50	Mark detection positioning data 8
BB51	
BB52	
BB53	Mark detection positioning data 9
BB54	
BB55	
BB56	Mark detection positioning data 10
BB57	
BB58	
BB59	Mark detection positioning data 60
BB5A	
BB5B	
BB5C	Mark detection positioning data 61
:	
:	
BC1F	Mark detection positioning data 62
BC20	
BC21	
BC22	Mark detection positioning data 63
BC23	
BC24	
BC25	Mark detection positioning data 64
BC26	
BC27	
BC28	Mark detection positioning data 65
BC29	
BC2A	
BC2B	Mark detection positioning data 66
BC2C	
BC2D	
BC2E	Mark detection positioning data 67
BC2F	

6. APPLICATION FUNCTIONS

POINT
<ul style="list-style-type: none"> • The mark detection data table allocates continuous latch data storage area automatically from the lowest axis to the highest axis. • When the current feedback position set in mark detection data settings is specified in command units, the fraction that comes about when converting from pulse units is round down then stored. • The lower 32 bits of data are latched for data in pulse units that exceeds 32 bits.

API LIBRARY
<ul style="list-style-type: none"> • Use the sscGetMarkDetectionData function to get mark detection data (mark detection edge data□, mark detection positioning data□).

(5) Axis command/status bit

Address	Bit	Symbol	Signal name	When in tandem drive
100B	0		Reserved	
	1	MKC1	Mark detection clear command 1	Each axis
	2	MKD1	Mark detection disable command 1	Each axis
	3	MKSEN1	Mark detection setting enable command 1	Each axis
	4		Reserved	
	5	MKC2	Mark detection clear command 2	Each axis
	6	MKD2	Mark detection disable command 2	Each axis
	7	MKSEN2	Mark detection setting enable command 2	Each axis

Address	Bit	Symbol	Signal name	When in tandem drive
106B	0	MKIF1	Mark detection compatible information 1	Each axis
	1	MKCF1	Mark detection clear complete 1	Each axis
	2	MKDO1	Mark detection disabled 1	Each axis
	3	MKSEF1	Mark detection setting enable complete 1	Each axis
	4	MKIF2	Mark detection compatible information 2	Each axis
	5	MKCF2	Mark detection clear complete 2	Each axis
	6	MKD02	Mark detection disabled 2	Each axis
	7	MKSEF2	Mark detection setting enable complete 2	Each axis

Note. The addresses above are the addresses for the first axis. For the second axis and after, increase by C0h for each axis.

6. APPLICATION FUNCTIONS

(a) Details on axis command bit

Abbreviation	Signal name	Remarks
MKC□	Mark detection clear command□	<p>[Function] Clears the mark detection positioning data table, mark detection edge data table, and mark detection counter.</p> <p>[Operation] When the mark detection clear signal is turned ON, the following data is cleared.</p> <ul style="list-style-type: none"> • Mark detection positioning data table • Mark detection edge data table • Mark detection counter
MKD□	Mark detection disable command□	<p>[Function] Disables data latch at the time of mark detection.</p> <p>[Operation] When the mark detection disable command is turned ON, data is not latched regardless of the latch data range settings.</p>
MKSEN□	Mark detection setting enable command□	<p>[Function] Reflects the settings for mark detection.</p> <p>[Operation] Reflects the following settings.</p> <ul style="list-style-type: none"> • Mark detection edge settings • Mark detection data type • Latch data range

POINT

- Mark detection data that is received while the mark detection clear command is ON is discarded.

6. APPLICATION FUNCTIONS

(b) Details on axis status bit

Abbreviation	Signal name	Remarks
MKIF□	Mark detection compatible information□	<p>[Function] Notifies that mark detection function can be used.</p> <p>[Operation] <Conditions for turning on> The following conditions are satisfied.</p> <ul style="list-style-type: none"> • Servo amplifier supports mark detection function. • Mark detections settings are enabled. <p><Conditions for turning off> One of the following conditions is satisfied.</p> <ul style="list-style-type: none"> • Servo amplifier does not support mark detection function. • Mark detections settings are disabled. • Mark detection compatible axis is disconnected.
MKCF□	Mark detection clear complete□	<p>[Function] Notifies that clearing of mark detection information was completed.</p> <p>[Operation] <Conditions for turning on> Clearing of mark detection information is complete.</p> <p><Conditions for turning off> The mark detection clear command signal (MKC□) was turned OFF.</p>
MKD0□	Mark detection disabled□	<p>[Function] Notifies that data latch at the time of mark detection is disabled.</p> <p>[Operation] <Conditions for turning on> The mark detection disable command signal (MKD□) was turned ON.</p> <p><Conditions for turning off> The mark detection disable command signal (MKD□) was turned OFF.</p>
MKSEF□	Mark detection setting enable complete□	<p>[Function] Notifies that the mark detection settings have been applied.</p> <p>[Operation] <Conditions for turning on> The mark detection setting enable command signal (MKSEN□) was turned ON.</p> <p><Conditions for turning off> The mark detection setting enable command signal (MKSEN□) was turned OFF.</p>

API LIBRARY

- Use the `sscClearMarkDetectionData` function for clearing mark detection data.
- To turn ON/OFF the following axis command bits, set the command bit numbers of the `sscSetCommandBitSignalEx` function to the following.
 - Mark detection disable (MKD□): `SSC_CMDBIT_AX_MKD□`
 - Mark detection setting enable (MKSEN□): `SSC_CMDBIT_AX_MKSEN□`
- To turn ON/OFF the following axis status bits, set the status bit numbers of the `sscGetStatusBitSignalEx` function or `sscWaitStatusBitSignalEx` function to the following.
 - Mark detection compatible information (MKIF□): `SSC_STSBIT_AX_MKIF□`
 - Mark detection disabled (MKDO□): `SSC_STSBIT_AX_MKDO□`
 - Mark detection setting enable complete (MKSEF□): `SSC_STSBIT_AX_MKSEF□`

6. APPLICATION FUNCTIONS

6.31.3 Function details

(1) Combinations with sensor input method

By setting the sensor input method to driver input, and setting the mark detection signal numbers (DI1 to DI3), sensors (LSP/LSN/DOG) can be used in combination with the mark detection function.

Example 1: When sensor input method is set to driver input and mark detection signal number specification 1 is set to DI3

Name	Signal allocation
DI1	LSP
DI2	LSN
DI3	DOG(mark detection 1)

Example 2: When sensor input method is set to a setting other than driver input and mark detection signal number specification 2 is set to DI1

Name	Signal allocation
DI1	General input 1 (mark detection 2)
DI2	General input 2
DI3	General input 2

(2) Continuous latch data storage allocation

The mark detection data table (the table where the current feedback position data at the input of the mark detection signal is stored) used by each axis allocates according to the number of continuous latch data storages (parameter No.02B0) automatically from the lowest axis to the highest axis.

The following is an example for when continuous latch data storages is 4 points for axis 1, 1 point for axis 2, and 2 points for axis 3.

Mark detection data table	Allocation
Mark detection data table 0	Axis 1
Mark detection data table 1	
Mark detection data table 2	
Mark detection data table 3	
Mark detection data table 4	Axis 2
Mark detection data table 5	Axis 3
Mark detection data table 6	
:	:

6. APPLICATION FUNCTIONS

(3) Latch data range

When data at mark detection is within the latch data range, the data is stored in the mark detection storage device and the mark detection counter increases by one. When the data is outside of the range the mark detection is not processed. The following explains the upper limit value and lower limit value.

(a) Upper limit value > lower limit value

When the mark detection data is more than the lower limit value and also less than or equal to the upper limit value, the mark detection is processed.

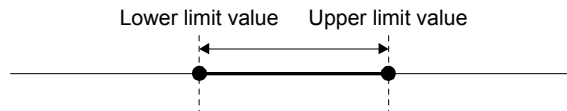

(b) Upper limit value < lower limit value

When the mark detection data is less than the upper limit value or more than the lower limit value, the mark detection is processed.

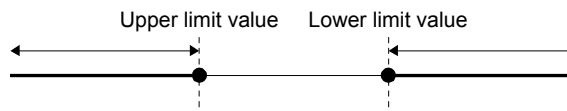

(c) Upper limit value = lower limit value

The range of the mark detection data is not checked. Mark detection is processed for all ranges.

(4) Mark detection clear command

When a mark detection clear command is input the mark detection counter becomes 0, and mark detection edge data and mark detection positioning data is cleared.

6. APPLICATION FUNCTIONS

6.31.4 Operation example

(1) Continuous detection mode

The mark detection counter is incremented at mark detection. After mark detection, read the mark detection data and update the read complete buffer number. When mark detection data is not read before the next mark detection, a mark detection write/read error (operation alarm A6, detail No.01) occurs, followed by a rapid stop.

Example: When both ON/OFF edges are enabled.

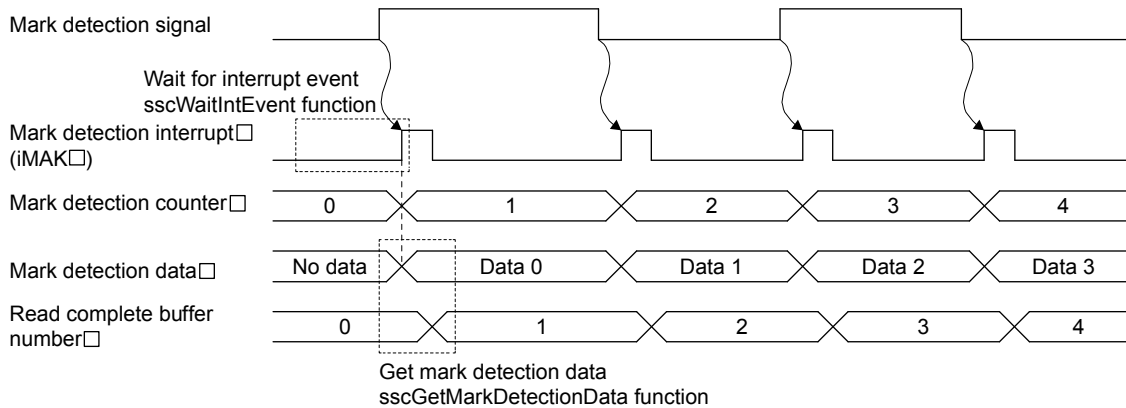

POINT

- Mark detection interrupt cannot be used for interface mode. The mark detection counter can be continuously monitored by polling.

API LIBRARY

- Use the `sscGetMarkDetectionData` function to get mark detection data.
- The read number setting for the read complete buffer number is conducted within the `sscGetMarkDetectionData` function therefore user program processing is not required.
- Use the `sscGetMarkDetectionCounter` function to get the mark detection counter.
- When using mark detection interrupt, use the `sscWaitIntEvent` function and wait until interrupt is output. If not using mark detection interrupt, use polling. When using polling, use the `sscGetMarkDetectionCounter` function to periodically check that the mark detection counter is updated.

6. APPLICATION FUNCTIONS

(2) Specified number of detection mode

The mark detection counter is incremented at mark detection. After mark detection, read the mark detection data and update the read complete buffer number. If performing mark detection again after the specified number of mark detections, conduct a mark detection clear. The mark detection data that is detected after the mark detection clear is latched.

Example: When both ON/OFF edges are enabled and specified number of mark detections is three.

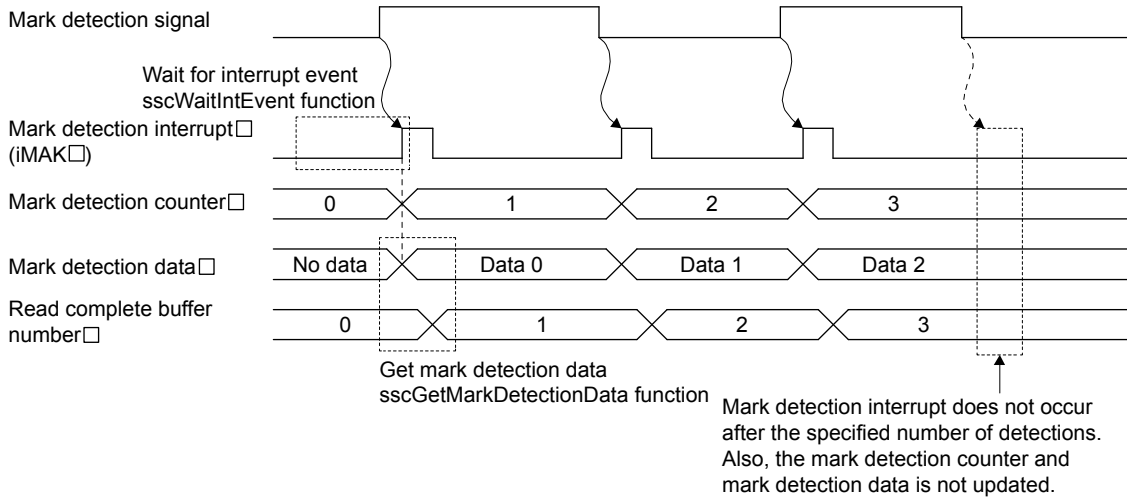

POINT

- Data for mark detections after the specified number of detections is not latched.

API LIBRARY

- Use the `sscGetMarkDetectionData` function to get mark detection data.
- The read number setting for the read complete buffer number is conducted within the `sscGetMarkDetectionData` function therefore user program processing is not required.
- Use the `sscGetMarkDetectionCounter` function to get the mark detection counter.
- When using mark detection interrupt, use the `sscWaitIntEvent` function and wait until interrupt is output. If not using mark detection interrupt, use polling. When using polling, use the `sscGetMarkDetectionCounter` function to periodically check that the mark detection counter is updated.

6. APPLICATION FUNCTIONS

(3) Ring buffer mode

When using ring buffer mode, the mark detection count is started again from 1 if the number of mark detections exceeds the number of continuous latch data storages. When mark detection data is not read before the next mark detection, a mark detection write/read error (operation alarm A6, detail No.01) occurs with a rapid stop.

Example: When both ON/OFF edges are enabled.

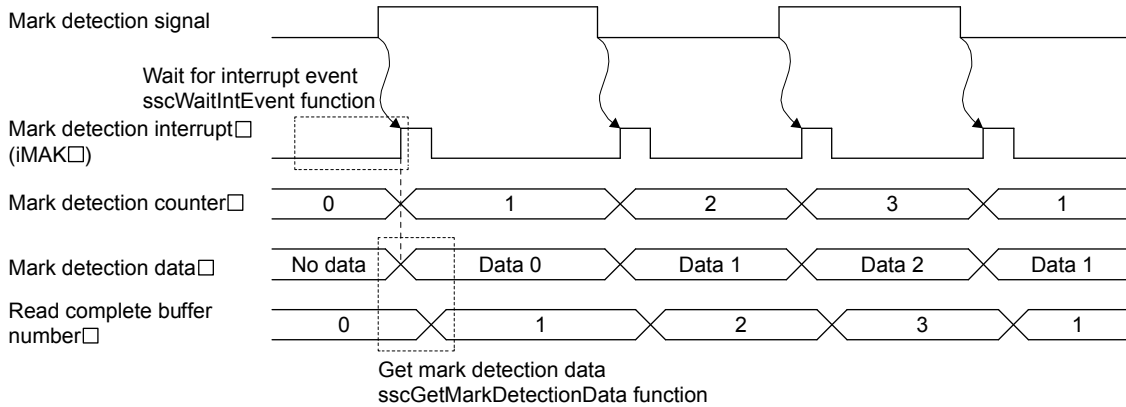

API LIBRARY

- Use the `sscGetMarkDetectionData` function to get mark detection data.
- The read number setting for the read complete buffer number is conducted within the `sscGetMarkDetectionData` function therefore user program processing is not required.
- Use the `sscGetMarkDetectionCounter` function to get the mark detection counter.
- When using mark detection interrupt, use the `sscWaitIntEvent` function and wait until interrupt is output. If not using mark detection interrupt, use the `sscGetMarkDetectionCounter` function to periodically check that the mark detection counter is updated.

6. APPLICATION FUNCTIONS

6.32 Continuous operation to torque control

6.32.1 Summary

Continuous operation to torque control is a control method that achieves torque control during positioning control without stopping.

To perform continuous operation to torque control, the servo amplifier control mode must be switched to "continuous operation to torque control mode". By setting the "continuous operation to torque control specification" auxiliary command in the point table to "continuous operation to torque control valid", torque control is performed from the position (command position or current feedback position) set in the switch conditions without stopping operation. Continuous operation to torque control is completed based on the continuous operation to torque control data, then returned to position control.

Also, when the continuous operation to torque control operation condition "start switch to continuous operation to torque control condition" is set to "manual switch", a switch to continuous operation to torque control can be made at any given time.

The continuous operation to torque control data becomes valid at the start of operation for the points set to continuous operation to torque control valid (hereinafter referred to as continuous operation to torque control points).

POINT
<ul style="list-style-type: none">• Continuous operation to torque control data that is changed during the operation of a continuous operation to torque control point becomes valid at the operation of the next continuous operation to torque control point.

6. APPLICATION FUNCTIONS

(1) Operation example

Two-point operation (deceleration check system: In-position stop) including continuous operation to torque control point.

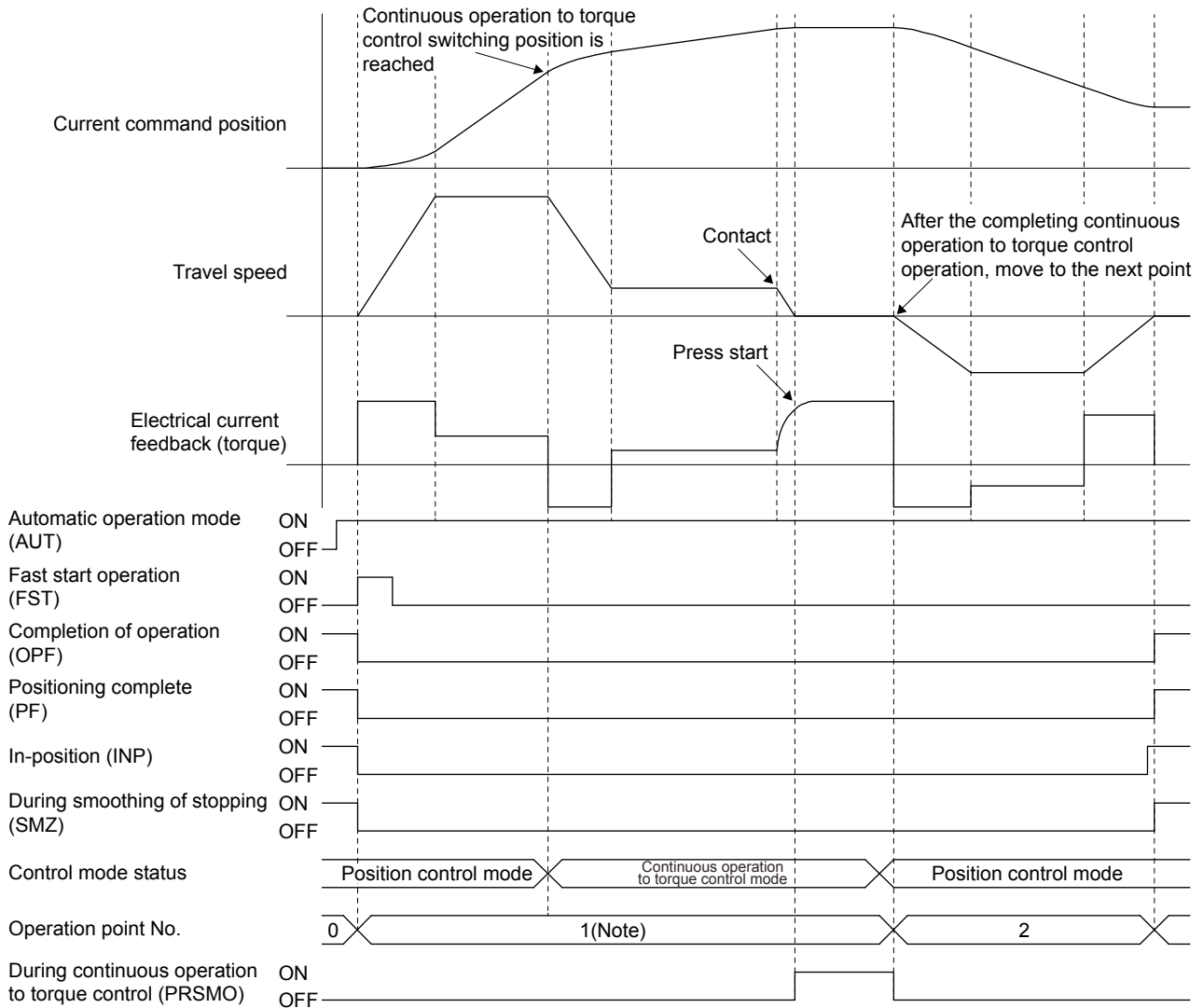

Note. Returning to position control mode after the completion of continuous operation to torque control operation is part of the continuous operation to torque control point, and is performed as a one-point operation.

POINT
<ul style="list-style-type: none"> When continuous operation to torque control specification is set to valid and automatic operation is started for a servo amplifier that is not supported, continuous operation to torque control error (operation alarm 5D, detail No.06) occurs, and operation does not start.

API LIBRARY
<ul style="list-style-type: none"> Refer to the sample program "InterruptPressDrive" contained in the utility software for a more specific procedure on continuous operation to torque control.

6. APPLICATION FUNCTIONS

6.32.2 Interface

Set the following data when using continuous operation to torque control.

(1) Parameter

(a) Servo parameter

Parameter No.	Abbreviation	Name	Initial value	Units	Setting range	Function
110D	*POL	Rotation direction selection/travel direction selection	0		0 to 1	Select the rotation direction or travel direction for the command input pulse.
1142	TFBGN	Torque feedback loop gain	18000	rad/s	0 to 18000	Set the torque feedback gain for continuous operation to torque control. By setting a smaller value, the contact load at continuous operation to torque control can be reduced. When setting value is less than 6[rad/s], a setting value of 6[rad/s] is set.

(b) Control parameter

Parameter No.	Abbreviation	Name	Initial value	Units	Setting range	Function
0205	ITM2	Interrupt condition 2	0000h		0000h to FFFFh	Set interrupt condition 2.
0222	SPLL	Speed limit value (lower)	0BB8h	Speed units	0000h to FFFFh	Set the value for the moving speed limit.
0223	SPLH	Speed limit value (upper)	0000h		0000h to 7FFFh	

API LIBRARY

- Use the sscChange2Parameter/sscCheck2Parameter functions to set/get parameters.

6. APPLICATION FUNCTIONS

(2) Point table

Set the points where continuous operation to torque control is performed in "continuous operation to torque control specification" in the auxiliary command.

Point	Position data [Command units]	Feed speed [Speed units]	Acceleration constant [ms]	Deceleration constant [ms]	Dwell/pre dwell [ms]	Auxiliary command	Other axes start specification	S-curve ratio [%]	Reserved
	4 bytes	4 bytes	2 bytes	2 bytes	2 bytes	2 bytes	4 bytes	1 byte	11 bytes
0000	-2000	3000	20	30	0	0000h	00000000h	0	0
0001	-3000	1000	30	50	0	0000h	00000000h	0	0
0002	-2000	1000	30	50	0	0000h	00000000h	0	0
0003	0	3000	20	30	0	0000h	00000000h	0	0
:	:	:	:	:	:	:	:	:	:

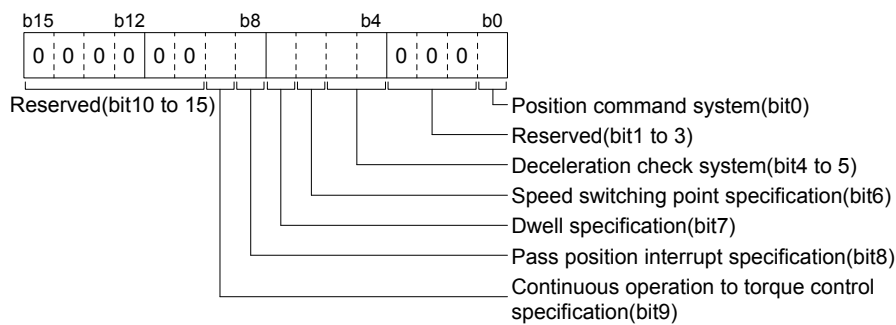

(a) Position command method

- 0: Absolute position command
- 1: Relative position command

(b) Deceleration check system

Operation is complete at the completion of continuous operation to torque control. Continuous operation is invalid.

(c) Speed switching point specification

Speed switching point specification is invalid.

(d) Dwell specification

- 0: Dwell (Specify the time for after switching to position control mode)
- 1: Predwell (point movement starts when the time specified by predwell has passed.)

(e) Pass position interrupt specification

- 0: Pass position interrupt invalid
- 1: Pass position interrupt valid

(f) Continuous operation to torque control specification

- 0: Continuous operation to torque control invalid
- 1: Continuous operation to torque control valid

API LIBRARY

- Use the sscSetPointDataEx/sscCheckPointDataEx functions to set/get point data.

6. APPLICATION FUNCTIONS

POINT
<ul style="list-style-type: none"> • Position data is the stopping position when switching to continuous operation to torque control could not be made. Set the position data after the continuous operation to torque control switching position (PRCPS) and before the pressing position in continuous operation to torque control. • When switching to continuous operation to torque control could not be made, a continuous operation to torque control error (operation alarm 5D, detail No.02) occurs at the completion of position control. It is determined that switching to continuous operation to torque control could not be made under the following conditions. <ul style="list-style-type: none"> • When position data is before the continuous operation to torque control switching position. • When switching is not performed when manual switch is selected. • When the control mode switch command (CTLMC) turns ON during the time specified by predwell, control mode switch error (CTLMCE) turns ON, and control mode cannot be switched.

[Setting image]

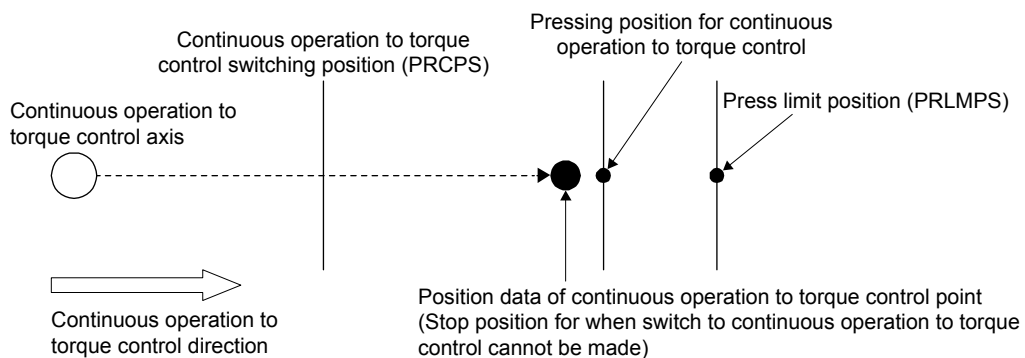

6. APPLICATION FUNCTIONS

(3) Continuous operation to torque control data

Set the conditions for performing continuous operation to torque control in the continuous operation to torque control data.

(a) Continuous operation to torque control data

Address	Abbreviation	Name	Units	Setting range	Function	At manual switch selection
A840	PRCPS	Continuous operation to torque control switching position (4 bytes)	Command units	-2147483648 to 2147483647	Set the position for switching to continuous operation to torque control. The position command system depends on the setting of the auxiliary command of the point table.	Invalid
A844	PRLMPS	Press limit position (4 bytes)	Command units	-2147483648 to 2147483647	Set the limit position for which continuous operation to torque control can operate. It is determined by the feedback position. The position command system depends on the setting of the auxiliary command of the point table.	Valid
A848	PRCTSP	Continuous operation to torque control speed limit value (4 bytes)	Speed units	1 to 2147483647	Set the speed limit value during continuous operation to torque control.	Valid
A84C	PRTGTR	Target torque (2 bytes)	0.1%	0 to 32767	Set the target torque during continuous operation to torque control.	Valid
A84E	PRTM	Press time (2 bytes)	ms	0 to 65535	Set the press time during continuous operation to torque control.	Invalid
A850	PRTRW	Torque settle width (2 bytes)	0.1%	0 to 65535	Set the range (difference from the target torque) at which it is regarded that the target torque has been reached during continuous operation to torque control.	Valid
A852	PRWTM	Torque settle waiting time (2 bytes)	ms	0 to 65535	Set the time where it is determined that press is occurring (from when entering the torque settle width until during continuous operation to torque control (PRSMO) is output.)	Valid
A854	PRCA	Continuous operation to torque control acceleration time constant (2 bytes)	ms	0 to 20000	Set the acceleration time constant for during continuous operation to torque control.	Valid
A856	PRCD	Continuous operation to torque control deceleration time constant (2 bytes)	ms	0 to 20000	Set the deceleration time constant for during continuous operation to torque control.	Valid

6. APPLICATION FUNCTIONS

Address	Abbreviation	Name	Units	Setting range	Function	At manual switch selection
A858	PRCOP	Continuous operation to torque control operating conditions (2 bytes)		0000h to 0012h	<div style="display: flex; align-items: center;"> <div style="border: 1px solid black; padding: 2px; margin-right: 5px;">0</div> <div style="border: 1px solid black; padding: 2px; margin-right: 5px;">0</div> <div style="border: 1px solid black; padding: 2px; margin-right: 5px;"> </div> <div style="border: 1px solid black; padding: 2px;"> </div> </div> <p>Start switch to continuous operation to torque control condition Set the condition for determining the continuous operation to torque control switching position. 0: Automatic switch (command position) 1: Automatic switch (current feedback position) 2: Manual switch</p> <p>End switch to continuous operation to torque control condition Set the condition for determining the control mode switch from continuous operation to torque control. 0: Automatic switch 1: Manual switch</p>	Valid
A85A to A85F		Reserved				

Note. The addresses above are the addresses for the first axis. For the second axis and after, increase by 20h for each axis.

API LIBRARY

- Use the sscSetPressDataEx/sscGetPressDataEx functions to set/get continuous operation to torque control data.

- 1) When the continuous operation to torque control switching position has not be reached at the start of operation

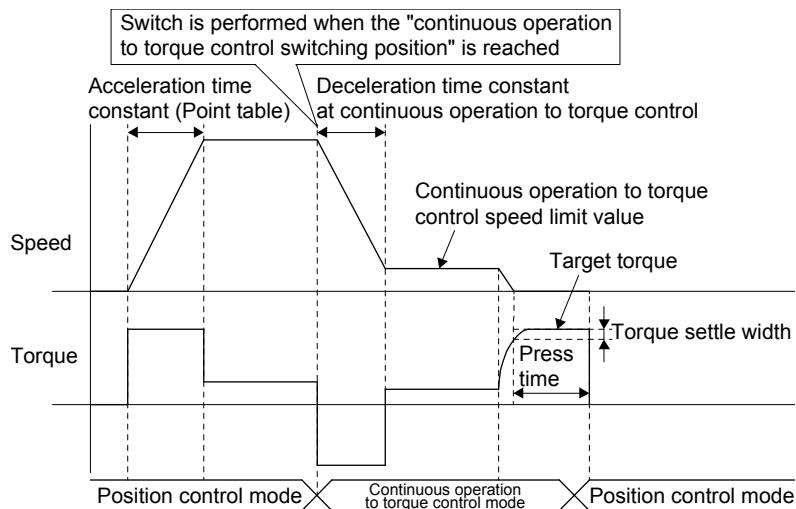

6. APPLICATION FUNCTIONS

2) When the continuous operation to torque control switching position has been passed at the start of operation

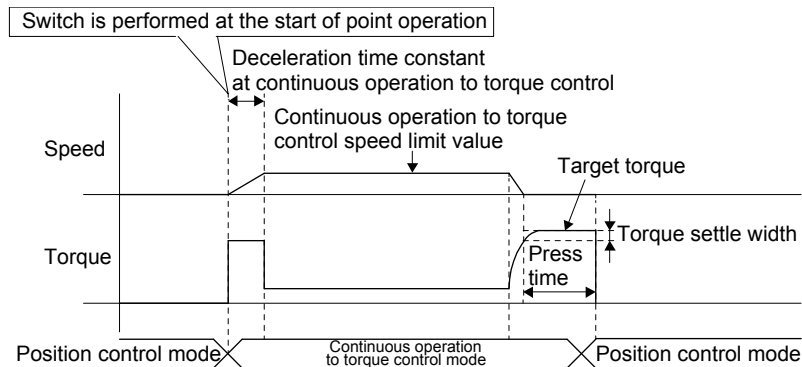

POINT

- The value for continuous operation to control data at the start of operation at the continuous operation to torque control point is valid.
- Continuous operation to torque control data that is changed during the operation of a continuous operation to torque control point becomes valid at the operation of the next continuous operation to torque control point.
- The press time is the time passed since torque within the torque settle width is continuously output during the torque settle waiting time. (The press time continues even if a value outside the torque settle width occurs part of the way through.)
- When a value outside of the range is set to continuous operation to torque control data and automatic operation is startup, a continuous operation to torque control setting error (operation alarm 5E, detail No.01 to 05) occurs, and the operation is not started.
- When a press limit position is set in the opposite direction of the position control travel direction, a continuous operation to torque control error (operation alarm 5D, detail No.05) occurs, and the operation is not started.
- When a press limit position is set before the positioning data, a continuous operation to torque control error (operation alarm 5D, detail No.08) occurs, and the operation is not started. (A press limit position is not reached during position control mode)
- The press limit position is determined by the current feedback position. When the press limit position is reached during continuous operation to torque control, a continuous operation to torque control error (operation alarm 5D, detail No.03) occurs, and stops at the position where the press limit position was exceeded.
- When target torque is reached during acceleration, it is determined that press has started and the press time measurement begins.
- When the continuous operation to torque control switching position is in the opposite direction of the movement direction, the continuous operation to torque control switching position is judged to be passed.

6. APPLICATION FUNCTIONS

(4) System status bit

Address	Bit	Symbol	Signal name
0450	0	ITO	Outputting with factor of interrupt
	1	IITO	During interface mode interrupt invalid
	2	EVDO	Event detection enabled
	3	HRIF	During highly response I/F valid
	4	BMA	During system program memory access
	5	PRINF	Continuous operation to torque control compatible information
	6		Reserved
	7	IFMO	In interface mode

(a) Details on system status bits

Abbreviation	Signal name	Function details
PRINF	Continuous operation to torque control compatible information	<p>[Function] Notifies that continuous operation to torque control is compatible.</p> <p>[Operation] <Conditions for turning on> Continuous operation to torque control is compatible. <Conditions for turning off> Continuous operation to torque control is not compatible.</p>

API LIBRARY

- To check if the following system status bits are ON/OFF, set the status bit numbers of the `sscGetStatusBitSignalEx` function or `sscWaitStatusBitSignalEx` function to the following.
- Continuous operation to torque control compatible information (PRINF):
`SSC_STSBIT_AX_PRINF`

6. APPLICATION FUNCTIONS

(5) Axis command/status bit

The axis command/status bits for continuous operation to torque control are shown below.

Address	Bit	Symbol	Signal name	When in tandem drive
1008	0	GAIN	Gain switching command	Each axis
	1	FCLS	Fully closed loop control change command	Each axis
	2		Reserved	
	3	CPC	PID control command	Each axis
	4		Reserved	
	5			
	6			
7				

Address	Bit	Symbol	Signal name	When in tandem drive
1068	0	GAINO	During gain switching	Each axis
	1	FCLSO	Fully closed loop control changing	Each axis
	2	TLSO	Selecting torque limit	Each axis
	3	SPC	During PID control	Each axis
	4		Reserved	
	5			
	6			
7	PRSMO	During continuous operation to torque control	Not supported	

Address	Bit	Symbol	Signal name	When in tandem drive
100C	0		Reserved	
	1			
	2			
	3			
	4	CTLMC	Control mode switch command	Not supported
	5		Reserved	
	6			
7				

Address	Bit	Symbol	Signal name	When in tandem drive
106C	0		Reserved	
	1			
	2			
	3			
	4	CTLMCF	Control mode switch complete	Not supported
	5	CTLMCE	Control mode switch error	Not supported
	6		Reserved	
7				

Note. The addresses above are the addresses for the first axis. For the second axis and after, increase by C0h for each axis.

(a) Details on axis command bit

Abbreviation	Signal name	Remarks
CTLMC	Control mode switch command	<p>[Function] Switch the control mode of the servo amplifier based on the control mode command.</p> <p>[Operation] When all of the following conditions are satisfied, the control mode is switched to the specified control mode.</p> <ul style="list-style-type: none"> • "Continuous operation to torque control specification" within the "auxiliary command" of the point in operation is set to "continuous operation to torque control valid". • Control mode switch condition is set to "2: Manual switch". • "Control mode command" is set to "Position control mode" or "continuous operation to torque control mode".

6. APPLICATION FUNCTIONS

(b) Details on axis status bit

Abbreviation	Signal name	Remarks
PRSMO	During continuous operation to torque control	<p>[Function] Notifies that torque within the torque settle width of the target torque has been output during the torque settle waiting time of continuous operation to torque control.</p> <p>[Operation] <Conditions for turning on> Torque within the torque settle width of the target torque has been output during the torque settle waiting time of continuous operation to torque control.</p> <p><Conditions for turning off> Control mode was changed to position control mode.</p>
CTLMCF	Control mode switch complete	<p>[Function] Notifies that switching of control mode of the servo amplifier was completed.</p> <p>[Operation] <Conditions for turning on> The switching of the control mode of the servo amplifier was completed normally. (Turns ON even when switching to a control mode the same as the current control mode)</p> <p><Conditions for turning off> The control mode switch command signal (CTLMC) was turned OFF.</p>
CTLMCE	Control mode switch error	<p>[Function] Notifies that switching of control mode of the servo amplifier could not be performed.</p> <p>[Operation] <Conditions for turning on> When one of the following conditions below is satisfied and the control mode switch command is turned ON.</p> <ul style="list-style-type: none"> • Switch command is input during automatic operation during an operation other than continuous operation to torque control points. • A mode other than position control mode and continuous operation to torque control mode, or a mode outside of the range is specified. • A control mode switch command set to other than manual switch was input during operation. <p><Conditions for turning off> The control mode switch command signal (CTLMC) was turned OFF.</p>

API LIBRARY

- Use the `sscChangeControlMode` function for switching the control mode of the servo amplifier.
- To check if the following system status bits are ON/OFF, set the status bit numbers of the `sscGetStatusBitSignalEx` function or `sscWaitStatusBitSignalEx` function to the following.
- During continuous operation to torque control (PRSMO):
`SSC_STSBIT_AX_PRSMO`

6. APPLICATION FUNCTIONS

(6) Axis command/status data

The axis command/status data for continuous operation to torque control are shown below.

(a) Axis command table

Address	Name	Setting range	Remarks	When in tandem drive
1032	Control mode command	Refer to remarks	Set the mode to switch to. 0000h: Position control mode 0001h: Speed control mode (interface mode only) 0002h: Torque control mode (interface mode only) 0010h: Continuous operation to torque control mode (standard mode only)	Not supported
1033				

Note. The addresses above are the addresses for the first axis. For the second axis and after, increase by C0h for each axis.

(b) Axis status table

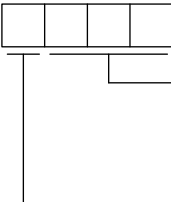
Address	Name	Output limits	Remarks	When in tandem drive
1092	Control mode status	Refer to remarks	The current control mode is shown below. 	Not supported
1093				

Note 1. When the control mode switch error (CTLMCE) is ON, the status is control mode switch error.

2. The addresses above are the addresses for the first axis. For the second axis and after, increase by C0h for each axis.

POINT

- When a selection other than manual switch is selected for the continuous operation to torque control operating conditions, control mode switch is automatically performed by the Q173SCCF.

API LIBRARY

- Use the sscChangeControlMode function for switching the control mode of the servo amplifier.

6. APPLICATION FUNCTIONS

6.32.3 Control mode switch

For control mode switch, there are the two following methods that can be selected for both "switching from position control mode to continuous operation to torque control mode" and "switching from continuous operation to torque control to position control mode"

- Automatic switch
- Manual switch

(1) Control mode switch setting

The setting contents and setting values required for each switch pattern are shown in the following table.

Switch pattern	Switch method	Setting items	Setting values
Switching from position control mode to continuous operation to torque control mode	Automatic switch	Continuous operation to torque control switching position	Position to switch to continuous operation to torque control mode [command units]
		Start switch to continuous operation to torque control condition	0000h, 0001h: Automatic switch (position command) 0010h, 0011h: Automatic switch (current feedback position)
	Manual switch	Start switch to continuous operation to torque control condition	0002h, 0012h: Manual switch
Switching from continuous operation to torque control mode to position control mode	Automatic switch	End switch to continuous operation to torque control condition	0000h to 0002h: Automatic switch
	Manual switch	End switch to continuous operation to torque control condition	0010h to 0012h: Manual switch

(2) Procedure for switching from position control mode to continuous operation to torque control mode

(a) Switch method: Automatic switch

- 1) The Q173SCCF automatically switches the control mode thus processing by user program is not required.
(The Q173SCCF determines the continuous operation to torque control switching position, and automatically switches to continuous operation to torque control mode once the position is reached.)

(b) Switch method: Manual switch

- 1) Set the control mode command to "3: Continuous operation to torque control mode".
- 2) Turn ON control mode switch command (CTLMC). (Have the switch timing determined by user program)
- 3) After confirming control mode switch complete (CTLMCF) is ON, turn OFF control mode switch command (CTLMC).

(3) Procedure for switching from continuous operation to torque control mode to position control mode

(a) Switch method: Automatic switch

- 1) The Q173SCCF automatically switches the control mode thus processing by user program is not required.
(Control mode is automatically returned to position control mode after the press time has passed since the starting of torque output within the torque settle width of the target torque.)

(b) Switch method: Manual switch

- 1) Set the control mode command to "0: Position control mode".
- 2) Turn ON control mode switch command (CTLMC). (Have the switch timing determined by user program)
- 3) After confirming control mode switch complete (CTLMCF) is ON, turn OFF control mode switch command (CTLMC).

6. APPLICATION FUNCTIONS

POINT

- Operation is completed with the switching completion to position control mode.
- When operation is stopped by forced stop, operation alarms etc., the Q173SCCF automatically switches to position control mode regardless of "start continuous operation to torque control switch conditions".
- When a control mode that cannot be switched to is input to the control mode command and control mode switch command (CTLMC) is turned ON, control mode switch error (operation alarm 2E, detail No.02 or 04) occurs, followed by a deceleration stop.

API LIBRARY

- Use the sscChangeControlMode function for switching the control mode of the servo amplifier.

6. APPLICATION FUNCTIONS

6.32.4 Operation timing

(1) Automatic switch (Start switch and end switch)

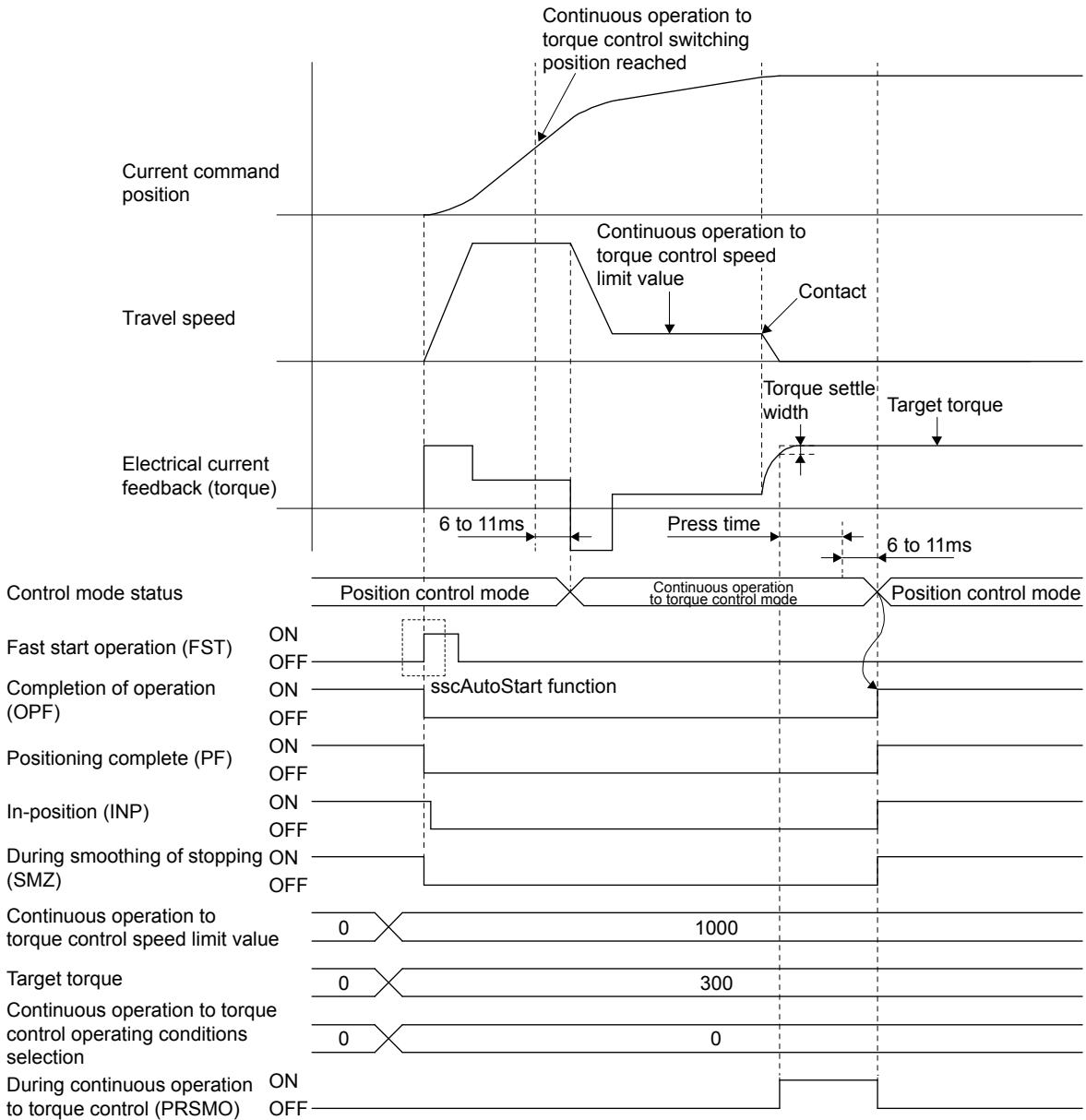

6. APPLICATION FUNCTIONS

POINT

- It takes approximately 6 to 11ms for the servo amplifier to switch modes after reaching the continuous operation to torque control switching position and press time has passed.
- The rough match (CPO) turns ON based on the distance remaining to the position data of the point table.
- Positioning complete (PF), during smoothing of stopping (SMZ), turn ON at completion of operation.
- The current command position is matched with the current feedback position at the timing of switch to continuous operation to torque control.
- When operation is completed without reaching the continuous operation to torque control switching position, a continuous operation to torque control error (operation alarm 5D, detail No.02) occurs.

API LIBRARY

- Use the sscAutoStart function for operation startup.
- Refer to the sample program "InterruptPressDrive" contained in the utility software for a more specific procedure on continuous operation to torque control.
Operate by automatic switch by setting chg_ctrl_mode_condition to CHG_CTRL_MODE_AUTO.

6. APPLICATION FUNCTIONS

(2) Manual switch (Start switch and end switch)

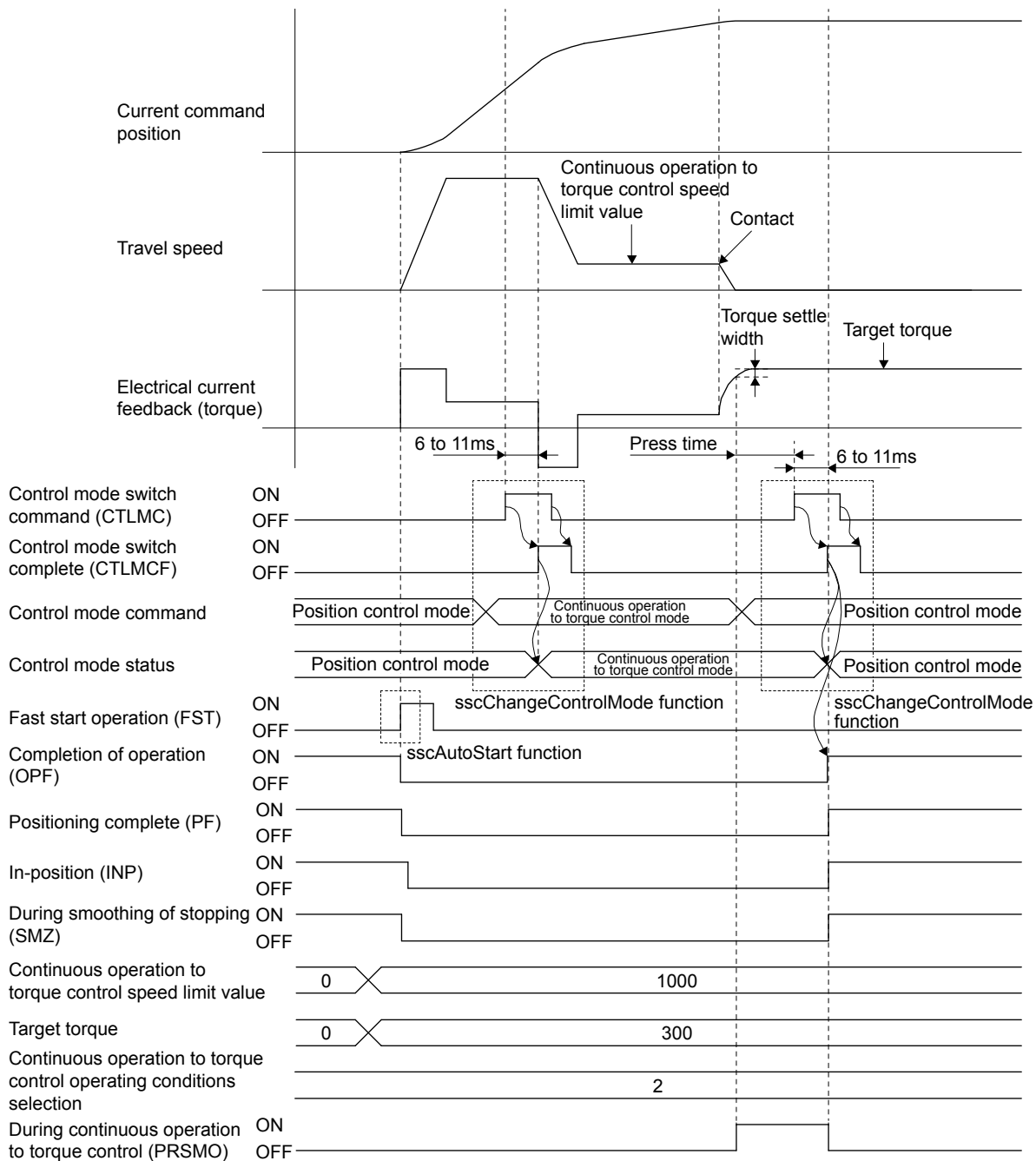

POINT

- After confirming the leading edge of control mode switch complete (CTLMCF), turn OFF the control mode switch command (CTLMC).
- Switch the control mode command to position control mode before input of control mode switch command (CTLMC). Turn ON the control mode switch command (CTLMC) after continuous operation to torque control switching conditions are satisfied (manage press conditions with user program).
- Operation is complete at the completion of switching to position control mode.

6. APPLICATION FUNCTIONS

API LIBRARY

- Use the sscAutoStart function for operation startup.
- Refer to the sample program "InterruptPressDrive" contained in the utility software for a more specific procedure on continuous operation to torque control.
Operate by manual switch by setting chg_ctrl_mode_condition to CHG_CTRL_MODE_MANUAL.
- Use the sscChangeControlMode function for switching the control mode of the servo amplifier.

(3) Timing of during continuous operation to torque control determination

The misjudgment of continuous operation to torque control when the torque fluctuation range is large can be managed by setting the torque settle waiting time. When torque within the torque settle width is continuously output during the torque settle waiting time, during continuous operation to torque control (PRSMO) is turned ON.

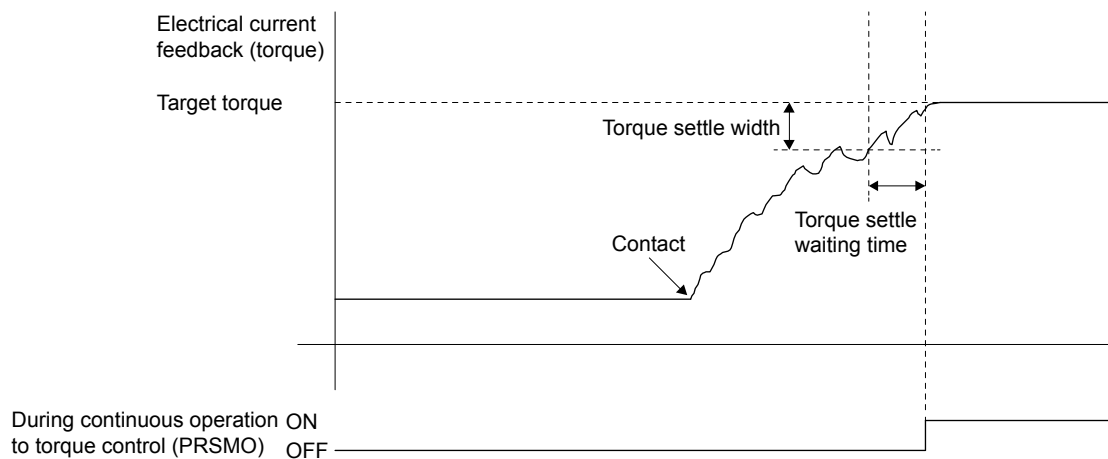

POINT

- When a value outside the torque settle width occurs part of the way through torque settle waiting time, the torque settle waiting time is measured again from the beginning.

6. APPLICATION FUNCTIONS

6.32.5 Operation during continuous operation to torque control mode

When switching to continuous operation to torque control mode, torque is controlled so that it becomes the torque set as "target torque", while speed is accelerated/decelerated from the current speed to the speed set in "continuous operation to torque control speed limit value". During this time, the command speed immediately after the switch is a value converted from the position command.

While a positive value is set for the "continuous operation to torque control speed limit value", the motor rotation direction of the motor conforms to the travel direction specified by the point table.

For the current torque value, check the electrical current feedback of the high speed monitor.

The acceleration/deceleration processes are trapezoidal acceleration/deceleration.

The "continuous operation to torque control speed limit value" is restricted by the speed limit value (parameter No.0222, No.0223). When a speed that exceeds the speed limit value is commanded, and a continuous operation to torque control point operation is conducted, speed is restricted to the speed limit value.

For the command speed to the servo amplifier, check "movement speed" (monitor No.0304, No.0305 or No.1304).

6. APPLICATION FUNCTIONS

6.32.6 Stop factors during continuous operation to torque control

Stop factor	Operation	
	Stop method	Alarm/Error
The press limit position was reached.	Immediate stop	Operation alarm 5D, detail No.03
Control mode was changed to position control mode during travel in continuous operation to torque control mode (before target torque is reached).	Deceleration stop	Operation alarm 5D, detail No.07
Interference check conditions were satisfied. (Including interference check standby)	Immediate stop	Operation alarm 45, detail No.01
A control mode that cannot be switched to was input to the control mode command, and control mode switch was conducted.	Deceleration stop	Operation alarm 2E, detail No.02 or 04
Operation mode was changed.	Deceleration stop	Operation alarm 23, detail No.01
Servo off was performed.	Rapid stop	Operation alarm B3, detail No.01
Forced stop (external forced stop or software forced stop) was turned ON.	Immediate stop	Operation alarm 12, detail No.01
Stop operation (STP) was turned ON.	Deceleration stop	—
Rapid stop (RSTP) was turned ON.	Rapid stop	—
Limit switch was turned ON.	Immediate stop	Operation alarm A0, detail No.01 or 02
Interlock was turned ON.	Rapid stop	Operation alarm 5D, detail No.04
Control of servo amplifier is no longer possible. (disconnected)	Immediate stop	System error E400 Operation alarm B0, detail No.02
A servo alarm occurred.	Immediate stop	Operation alarm B1, detail No.01

6. APPLICATION FUNCTIONS

POINT	
	<ul style="list-style-type: none">• For all patterns, the control mode is automatically changed to position control by the Q173SCCF after zero speed (ZSP) turns ON.• The stopping process for each stop factor is a deceleration process in continuous operation to torque control mode. (For immediate stops, control mode switches to position control mode at the current position and stops immediately.)• The time constant at a rapid stop is that of rapid stop time constant (control parameter No.0227).• The press limit position is determined by the current feedback position. The position after a stop is a position exceeding the press limit position. Therefore, a position that takes into account the operation after exceeding the press limit position should be set.• The software limit is determined by the current feedback position during continuous operation to torque control. As there is a possibility of stopping at a position that exceeds the software limit, set the press limit position before the software limit. When the software limit is set before the press limit position, continuous operation to torque control error (operation alarm 5D, detail No.05) occurs, and operation does not start.• If interlock (ITL) turns ON during position control mode for points with continuous operation to torque control set to valid, continuous operation to torque control error (operation alarm 5D, detail No.04) occurs.• The interference check standby is invalid during position control mode in continuous operation to torque control points.• The above also applies when a stop factor occurs during switching to continuous operation to torque control mode.• An immediate stop occurs when a stop factor occurs during switching to position control mode from continuous operation to torque control mode.

6. APPLICATION FUNCTIONS

6.32.7 Combinations of continuous operation to torque control and other functions

The following shows the combinations of continuous operation to torque control with each function.

Classification	Function		Compatibility	Remarks	
System function	SSCNET communication method	SSCNETⅢ/H	○		
		SSCNETⅢ	○		
	Control mode	Standard mode	○		
		Interface mode	×		
Operation function	JOG operation		—		
	Incremental feed		—		
	Automatic operation		○	Automatic switch/Manual switch can be selected.	
	Linear interpolation		×	Linear interpolation ×. When starting up a continuous operation to torque control point, "continuous operation to torque control error (operation alarm 5D, detail No.0A)" occurs.	
	Home position return		—		
	Home position reset function		—		
Application function	Command unit	Electronic gear	○		
	Speed unit	Speed unit	○	Set the continuous operation to torque control speed limit value in speed units.	
		Speed units multiplication factor	○		
		Speed limit	○	The continuous operation to torque control speed limit value is restricted by speed limit value (control parameter No.0222, No.0223)	
	Acceleration/ deceleration	Linear acceleration/deceleration		○	
		Smoothing filter		△	Invalid during continuous operation to torque control.
		Start up speed validity		△	Valid when starting up operation point. However, it is invalid during continuous operation to torque control.
		S-curve acceleration/deceleration (Sine acceleration/deceleration)		△	Invalid during continuous operation to torque control.
	Servo off		○	Control mode is automatically changed to position control mode after an operation alarm occurrence.	
	Forced stop		○	Control mode is automatically changed to position control mode after an operation alarm occurrence.	
	Stop operation		○	Control mode is automatically changed to position control mode after an operation alarm occurrence.	
	Rapid stop operation		○	Control mode is automatically changed to position control mode after an operation alarm occurrence.	
	Limit switch (stroke end)		○	Control mode is automatically changed to position control mode after an operation alarm occurrence.	
	Software limit		○	Control mode is automatically changed to position control mode after an operation alarm occurrence.	
	Interlock		×	Control mode is automatically changed to position control mode after an operation alarm occurrence.	
	Rough match output		△	At continuous operation to torque control points the rough match turns ON when the distance remaining based on the position data of the point table is within the rough match output range.	
	Torque limit		×	During continuous operation to torque control and torque limit, torque limit stays OFF.	

○: Usable ×: Unusable △: Restriction —: Not applicable

6. APPLICATION FUNCTIONS

Classification	Function	Compatibility	Remarks	
Application function	Command change	Speed change	×	Speed change error signal (SCE) turns ON.
		Change of time constants	×	Acceleration time constant change error signal (TACE), or deceleration time constant change error signal (TDCE) turns ON.
		Position change	×	Position change error signal turns ON.
	Backlash		○	When following up by current feedback position, a position that takes into account the backlash is followed up.
	Position switch		△	Determined by the current feedback position.
	Completion of operation signal		○	Output after position control switch.
	Interference check function		△	Interference check function is invalid.
	Home position search limit		—	
	Gain switching		○	
	PI-PID switching		○	
	Home position set		—	
	Absolute position detection system		○	
	Home position return request		○	
	High response I/F		○	
	Other axes start		△	When current command position is set to the axis judgment coordinate of start condition, a current command position matching the current feedback position is determined.
	Digital I/O		—	
	I/O device		—	
	Servo amplifier general I/O		—	
	Dual port memory exclusive control		—	
	Pass position interrupt		△	When current command position is set to the axis judgment coordinate of start condition, a current command position matching the current feedback position is determined. Therefore when a current command position is specified, it may not be correctly determined.
	Mark detection		○	
SSCNET III/H head module connection		—		
Sensing module connection		—		
Auxiliary function	Reading/writing parameters		—	
	Changing parameters at the servo		—	
	Alarm and system error		○	
	Monitor function		○	The speed limit value output to the servo amplifier is output for the "travel speed" during continuous operation to torque control mode.
	High speed monitor function		○	The speed limit value output to the servo amplifier is output for the "travel speed" during continuous operation to torque control mode.
	Interrupt		○	During continuous operation to torque control is notified from when the output torque reaches the torque settle width and press time passes, until return to position control mode.
	Interrupt output cycle		—	
	Command data update cycle		—	
	User watchdog function		—	
Software reboot function		—		

○: Usable ×: Unusable △: Restriction —: Not applicable

6. APPLICATION FUNCTIONS

Classification	Function	Compatibility	Remarks
Auxiliary function	Parameter backup	—	
	Test mode	—	
	Reconnect/disconnect function	○	When reconnecting, startup is in position control mode.
	Sampling	—	
	Log	○	
	Operation cycle monitor function	—	
	Amplifier-less axis function	○	After reaching the continuous operation to torque control speed limit value, it is regarded that the torque settle width has been reached, and operation is completed after the continuous operation to torque control time has passed. For electrical current feedback, torque 0% occurs before reaching the speed limit value, and target torque occurs after reaching the speed limit value.
	Alarm history function	○	
	External forced stop disable	○	
Transient transmit	—		
Tandem drive	Tandem drive	×	When continuous operation to torque control is startup "continuous operation to torque control error (operation alarm 5D, detail No.01)" occurs.

○: Usable ×: Unusable △: Restriction —: Not applicable

6.32.8 Restrictions on servo amplifier functions

The following servo amplifier functions cannot be used during continuous operation to torque control mode.

- Base cut delay time function
- Forced stop deceleration function
- Vertical axis freefall prevention function

6. APPLICATION FUNCTIONS

6.33 SSCNET III/H head module connection

6.33.1 Summary

The SSCNET III/H head module can connect MELSEC-L series I/O modules and intelligent function modules on SSCNET III/H. The SSCNET III/H head module controls input and output of I/O modules and intelligent function modules using link devices.

By assigning inputs and outputs of modules mounted to the SSCNET III/H head module to the I/O device table, they can be used as Q173SCCF inputs and outputs.

Additionally, by using the transient transmit function, the SSCNET III/H head module can access the buffer memory of intelligent function modules.

Settings for the SSCNET III/H head module and modules mounted to the SSCNET III/H head module are made in GX Works2.

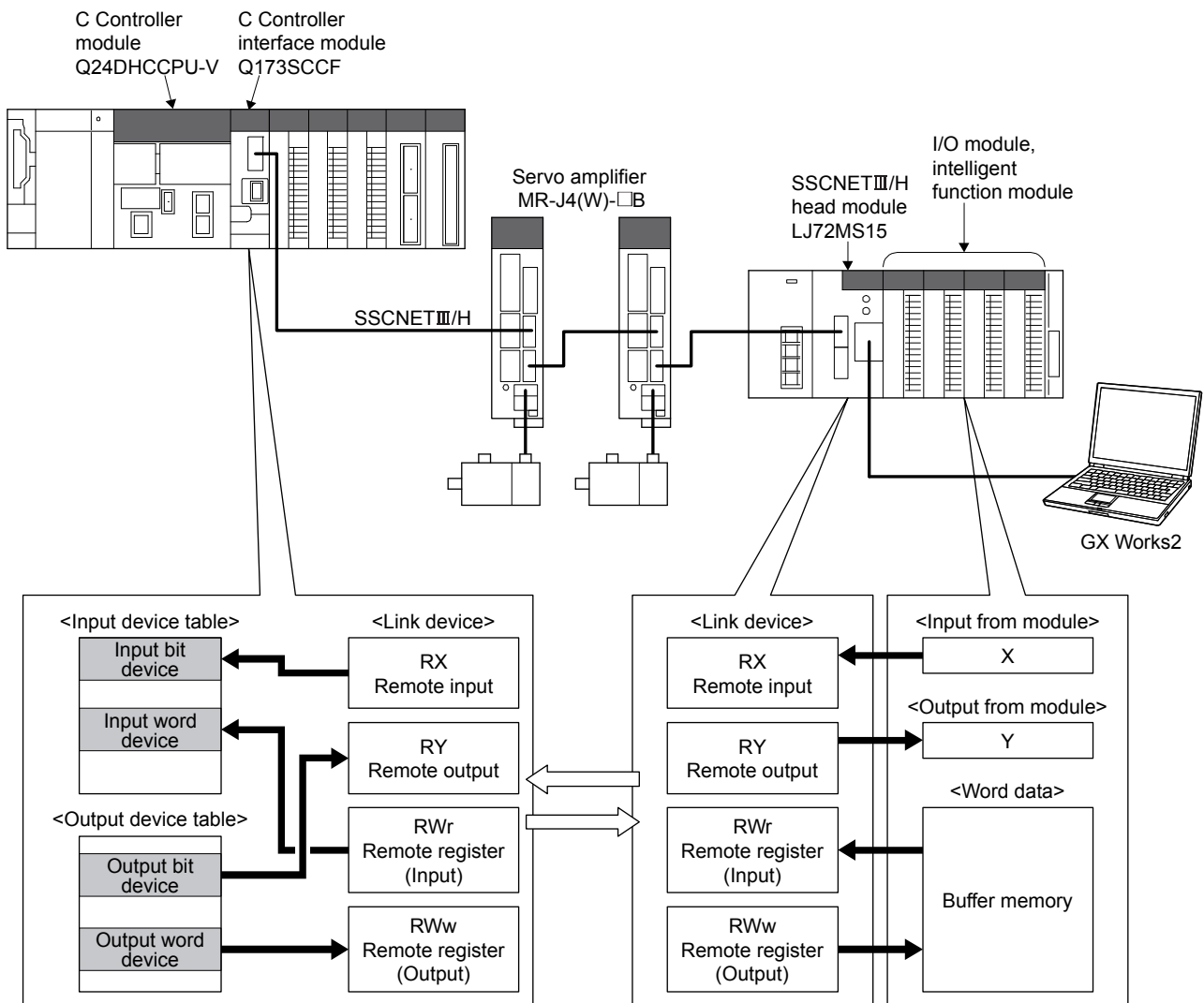

6. APPLICATION FUNCTIONS

(1) Number of connectable stations

The SSCNET III/H head module can use up to 4 stations.

The following shows the number of stations that can be controlled depending on the control cycle.

Control cycle	Maximum number of stations connected	Maximum number of stations connected per line	Recommended number of control axes
0.88ms	4 stations	4 stations	20 axes
0.44ms	2 stations	2 stations	12 axes
0.22ms	1 station	1 station	4 axes

Note. Processing times vary depending on the number of axes and functions used.

When operation cycle alarm (OCME), and operation cycle warning (OCMW) turn ON, review the following:

- Make the control cycle longer. (Example: When control cycle is 0.44ms, change it to 0.88ms)
- Reduce the number of control axes.
- Review the operation pattern so that the operation startup times of each axis do not overlap.

6.33.2 Supported functions

Classification	Function	Compatibility	Remarks
Application function	Forced stop	×	Inputting a forced stop has no affect on the I/O status of bit devices.
	Other axes start	○	Can turn ON/OFF output bit devices in line with other axes start conditions.
Auxiliary function	Reading/writing parameters	△	Supports RIO control parameters only (Cannot read/write parameters for the SSCNET III/H head module).
	Alarm and system error	○	Detail RIO module alarm No. are fixed at 0.
	Remote I/O disconnect	○	
	Monitor function	○	
	Interrupt	○	
	Parameter backup	△	Supports RIO control parameters only (Cannot backup RIO module parameters).
	Test mode	×	
	Reconnect/disconnect function	○	
	Sampling	△	Sampling of I/O devices is supported in the test tool only.
	Log	○	
	Alarm history function	○	When a RIO module alarm occurs, the RIO module alarm No. (upper/lower) is stored in alarm history data. (Detail RIO module alarm No. are not stored)
Transient transmit	○		

Note. ○: Usable △: Restriction ×: Unusable

6. APPLICATION FUNCTIONS

6.33.3 System startup

(1) Station No. setting parameter

Station No. settings are made with the station No. setting switch.

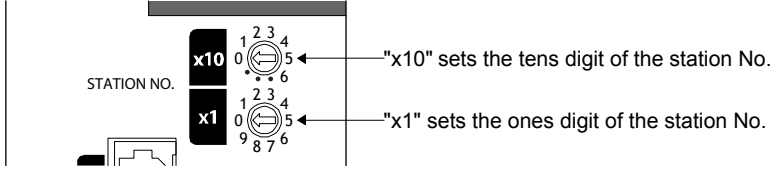

The station No. and station No. setting switch number are correlated as shown on the table below. Set the station No. so that it will not duplicate in the same line. If it is duplicated, the "An axis that has not been mounted exists" (system error E400) will occur at the time of system startup (system command code: 000Ah).

Station No. on remote I/O module	Station No. setting switch	Available/unavailable
Station 1	1	Unavailable
Station 2	2	
Station 3	3	
Station 4	4	
Station 5	5	
Station 6	6	
Station 7	7	
Station 8	8	
Station 9	9	
Station 10	10	
Station 11	11	
Station 12	12	
Station 13	13	
Station 14	14	
Station 15	15	
Station 16	16	
Station 17	17	
Station 18	18	
Station 19	19	
Station 20	20	
Station 21	21	Available
Station 22	22	
Station 23	23	
Station 24	24	

6. APPLICATION FUNCTIONS

(2) Station No. assignment

With station No. assignment, station No. (station No. on the Q173SCCF) are assigned to station No. on remote I/O modules.

Also refer to axis No. assignment (Section 4.4.6) for station No. assignment.

When station No. assignment is invalid, correspondence between the station No. on a remote I/O module and the station No. is shown in the following table.

Station No. on remote I/O module		Line 1			
		21	22	23	24
Station No.	0.88ms	1	2	3	4
	0.44ms	1	2	-	-
	0.22ms	1	-	-	-

API LIBRARY

- When setting the API function argument "Axis No." to a station No., set a negative value. (Station 1: -1, station 2: -2, station 3: -3, station 4: -4)

(3) Remote I/O module I/O setting

When using remote I/O modules, set the I/O table selection of I/O table (parameter No.004A) to "1: Use I/O device table".

Also, set the points of the I/O devices controller by the Q173SCCF, and the start No. to be assigned to the I/O device table.

(4) Vendor ID and type code setting

Available functions, parameter settings and ranges will vary by remote I/O module type. At the time the communication with the remote I/O module has started, the Q173SCCF will perform consistency check between vendor ID and type code of the module connected and the parameter set. If a consistency check error occurs, driver type code error (system error E405) will be output, therefore set correct vendor ID and type code.

POINT

- If driver type code error (system error E405) occurred, the station that has set an incorrect type code can be confirmed with "type code erroneous station information" (system information monitor No.04C1).

(a) RIO control parameter

Parameter No.	Abbreviation	Name	Function
021D	*VEND	Vendor ID	Set the vendor ID. 0000h: Mitsubishi Electric
021E	*CODE	Type code	Set the type code. 3000h: SSCNETⅢ/H head module

6. APPLICATION FUNCTIONS

6.33.4 Interface

(1) Parameter

(a) System parameter

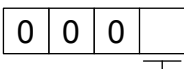
Parameter No.	Abbreviation	Name	Initial value	Units	Setting range	Function
004A	*IOTBL	I/O table	0000h		0000h to 0001h	 <p>I/O table selection Set the I/O table to be used. 0: Use digital I/O table 1: Use I/O device table</p> <p>Note. For SSCNETⅢ/H head module, set "1: Use I/O device table"</p>

(b) RIO control parameter

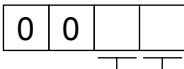
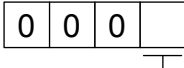
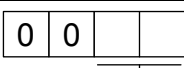
Parameter No.	Abbreviation	Name	Initial value	Units	Setting range	Function
0200	*OPC1	Control option 1	0000h		0000h to 0011h	 <p>Control station Set to 1 for implementing control of a remote I/O module. 0: Not controlled 1: Controlled</p> <p>Remote I/O disconnect Set to 1 when remote I/O communication is not implemented. When set to 1 together with the control station, it is possible to run without a remote I/O (simulate). 0: Invalid 1: Valid</p>
0201	OPC2	Control option 2	0000h		0000h to 0001h	 <p>RI control at communication error Set input device control at communication error(system error E401 to E407) 0: All points OFF 1: Maintain status</p>
0202	*UTALC	Station No. assignment	0000h		0000h to 001Fh	 <p>Remote I/O station No. Set the remote I/O station No. to be assigned to the station No. on the Q173SCCF. 00h : No station No. assignment 15h to 18h : Station No. Example) 16h: Remote I/O station No. 22</p>
0203	ITM	Interrupt condition	0000h		0000h to FFFFh	Set interrupt condition.

6. APPLICATION FUNCTIONS

Parameter No.	Abbreviation	Name	Initial value	Units	Setting range	Function
0210	*BDIO	Input bit device points	0000h		0000h to 0200h	Set the points used for input bit device. 0000h to 0200h: 0 to 512 Note. Only a multiple of 16 can be selected.
0211	*BDINA	Input bit device start number	0000h		0000h to 0FF0h	Set the start of the input bit device number assigned to RX. 0000h to 0FF0h: 0 to 4080 Note. Only a multiple of 16 can be selected. Example: When the input points are 64, and input bit device 020 is specified as the start, assign the 64 points of DVI_020 to DVI_05F.
0212	*WDIO	Input word device points	0000h		0000h to 0020h	Set the points used for input word device. 0000h to 0020h: 0 to 32 Note. The size used is 1 word × set value.
0213	*WDINA	Input word device start number	0000h		0000h to 00FFh	Set the start of the input word device number assigned to RWr. 0000h to 00FFh: 0 to 255 Example: When the input points are 2, and input word device 06 is specified as the start, assign input word devices 06 to 07.
0214	*BDOO	Output bit device points	0000h		0000h to 0200h	Set the points used for output bit device. 0000h to 0200h: 0 to 512 Note. Only a multiple of 16 can be selected.
0215	*BDONA	Output bit device start number	0000h		0000h to 0FF0h	Set the start of the output bit device number assigned to RY. 0000h to 0FF0h: 0 to 4080 Note. Only a multiple of 16 can be selected. Example: When the output points are 64, and output bit device 040 is specified as the start, assign the 64 points of DVO_040 to DVO_07F.
0216	*WDOO	Output word device points	0000h		0000h to 0020h	Set the points used for output word device. 0000h to 0020h: 0 to 32 Note. The size used is 1 word × set value.
0217	*WDONA	Output word device start number	0000h		0000h to 00FFh	Set the start of the output word device number assigned to RWw. 0000h to 00FFh: 0 to 255 Example: When the output points are 2, and output word device 08 is specified as the start, assign output word devices 08 to 09.
021D	*VEND	Vendor ID	0000h		0000h to FFFFh	Set the vendor ID. 0000h: Mitsubishi Electric
021E	*CODE	Type code	3000h		0000h to FFFFh	Set the type code. 3000h: SSCNETⅢ/H head module

POINT
<ul style="list-style-type: none"> • Set "1: Use I/O device table" for the I/O table setting. When "0: Use digital I/O table" is set, system setting error (operation alarm No. 38, detail 05 to 06) will occur. • Assign the I/O device table not to overlap other settings. If the assignment is overlapped or exceeds the maximum points of the I/O device table, the I/O No. assignment error (system error E510) and I/O No. assignment setting error (RIO control alarm 39, detail 01 and 02) occur.

6. APPLICATION FUNCTIONS

(3) RIO data command/status table

(a) RIO status bit

Address	Bit	Abbreviation	Signal name
3440	0	RURDY	Receiving controller ready on
	1	RUA	Outputting DO
	2		Reserved
	3		
	4		
	5	RUALM	RIO module alarm
	6	RUWRN	RIO module warning
	7		Reserved

Note 1. The addresses above are the addresses for the first station. For the second station and after, increase by 80h for each station.

1) Details on RIO status bit

Abbreviation	Signal name	Remarks
RURDY	Receiving controller ready on	[Function] Shows the operating status of remote I/O module.
RUA	Outputting DO	RURDY: OFF, RUA: OFFNo communication RURDY: ON, RUA: OFFStop RURDY: ON, RUA: ONRun RURDY: OFF, RUA: ONError

6. APPLICATION FUNCTIONS

(4) I/O device table

(a) Input device table

Address	Input word device number	Input bit device number	Abbreviation	Remarks
DB00	Input word device 00 (2 bytes)	Input word device 000 to Input word device 00F	DVI_000 to DVI_00F	[When bit device is assigned] Notifies the status of the bit device input signal. The bits are DVI_000 (bit0) to DVI_00F (bit15). [When word device is assigned] Notifies the status of the word device input signal.
DB02	Input word device 01 (2 bytes)	Input word device 010 to Input word device 01F	DVI_010 to DVI_01F	[When bit device is assigned] Notifies the status of the bit device input signal. The bits are DVI_010 (bit0) to DVI_01F (bit15). [When word device is assigned] Notifies the status of the word device input signal.
DB04	Input word device 02 (2 bytes)	Input word device 020 to Input word device 02F	DVI_020 to DVI_02F	[When bit device is assigned] Notifies the status of the bit device input signal. The bits are DVI_020 (bit0) to DVI_02F (bit15). [When word device is assigned] Notifies the status of the word device input signal.
DB06	Input word device 03 (2 bytes)	Input word device 030 to Input word device 03F	DVI_030 to DVI_03F	[When bit device is assigned] Notifies the status of the bit device input signal. The bits are DVI_030 (bit0) to DVI_03F (bit15). [When word device is assigned] Notifies the status of the word device input signal.
DB08	Input word device 04 (2 bytes)	Input word device 040 to Input word device 04F	DVI_040 to DVI_04F	[When bit device is assigned] Notifies the status of the bit device input signal. The bits are DVI_040 (bit0) to DVI_04F (bit15). [When word device is assigned] Notifies the status of the word device input signal.
DB0A	Input word device 05 (2 bytes)	Input word device 050 to Input word device 05F	DVI_050 to DVI_05F	[When bit device is assigned] Notifies the status of the bit device input signal. The bits are DVI_050 (bit0) to DVI_05F (bit15). [When word device is assigned] Notifies the status of the word device input signal.
DB0C	Input word device 06 (2 bytes)	Input word device 060 to Input word device 06F	DVI_060 to DVI_06F	[When bit device is assigned] Notifies the status of the bit device input signal. The bits are DVI_060 (bit0) to DVI_06F (bit15). [When word device is assigned] Notifies the status of the word device input signal.
DB0E	Input word device 07 (2 bytes)	Input word device 070 to Input word device 07F	DVI_070 to DVI_07F	[When bit device is assigned] Notifies the status of the bit device input signal. The bits are DVI_070 (bit0) to DVI_07F (bit15). [When word device is assigned] Notifies the status of the word device input signal.
:	:	:	:	:
DCFE	Input word device FF (2 bytes)	Input word device FF0 to Input word device FFF	DVI_FF0 to DVI_FFF	[When bit device is assigned] Notifies the status of the bit device input signal. The bits are DVI_FF0 (bit0) to DVI_FFF (bit15). [When word device is assigned] Notifies the status of the word device input signal.

6. APPLICATION FUNCTIONS

(b) Output device table

Address	Output word device number	Output bit device number	Abbreviation	Remarks
DD00	Output word device 00 (2 bytes)	Output word device 000 to Output word device 00F	DVO_000 to DVO_00F	[When bit device is assigned] Turns ON/OFF the bit device output signal. The bits are DVO_000 (bit0) to DVO_00F (bit15). [When word device is assigned] Turns ON/OFF the word device output signal.
DD02	Output word device 01 (2 bytes)	Output word device 010 to Output word device 01F	DVO_010 to DVO_01F	[When bit device is assigned] Turns ON/OFF the bit device output signal. The bits are DVO_010 (bit0) to DVO_01F (bit15). [When word device is assigned] Turns ON/OFF the word device output signal.
DD04	Output word device 02 (2 bytes)	Output word device 020 to Output word device 02F	DVO_020 to DVO_02F	[When bit device is assigned] Turns ON/OFF the bit device output signal. The bits are DVO_020 (bit0) to DVO_02F (bit15). [When word device is assigned] Turns ON/OFF the word device output signal.
DD06	Output word device 03 (2 bytes)	Output word device 030 to Output word device 03F	DVO_030 to DVO_03F	[When bit device is assigned] Turns ON/OFF the bit device output signal. The bits are DVO_030 (bit0) to DVO_03F (bit15). [When word device is assigned] Turns ON/OFF the word device output signal.
DD08	Output word device 04 (2 bytes)	Output word device 040 to Output word device 04F	DVO_040 to DVO_04F	[When bit device is assigned] Turns ON/OFF the bit device output signal. The bits are DVO_040 (bit0) to DVO_04F (bit15). [When word device is assigned] Turns ON/OFF the word device output signal.
DD0A	Output word device 05 (2 bytes)	Output word device 050 to Output word device 05F	DVO_050 to DVO_05F	[When bit device is assigned] Turns ON/OFF the bit device output signal. The bits are DVO_050 (bit0) to DVO_05F (bit15). [When word device is assigned] Turns ON/OFF the word device output signal.
DD0C	Output word device 06 (2 bytes)	Output word device 060 to Output word device 06F	DVO_060 to DVO_06F	[When bit device is assigned] Turns ON/OFF the bit device output signal. The bits are DVO_060 (bit0) to DVO_06F (bit15). [When word device is assigned] Turns ON/OFF the word device output signal.
DD0E	Output word device 07 (2 bytes)	Output word device 070 to Output word device 07F	DVO_070 to DVO_07F	[When bit device is assigned] Turns ON/OFF the bit device output signal. The bits are DVO_070 (bit0) to DVO_07F (bit15). [When word device is assigned] Turns ON/OFF the word device output signal.
:	:	:	:	:
DEFE	Output word device FF (2 bytes)	Output word device FF0 to Output word device FFF	DVO_FF0 to DVO_FFF	[When bit device is assigned] Turns ON/OFF the bit device output signal. The bits are DVO_FF0 (bit0) to DVO_FFF (bit15). [When word device is assigned] Turns ON/OFF the word device output signal.

6. APPLICATION FUNCTIONS

POINT	
	<ul style="list-style-type: none">• When a communication error (system error E401 to E407) occurs or SSCNET is disconnected, the status of the input device table is the same as RI control at communication error of control option 2 (parameter No.0201). The status of the output device table is maintained.• When using remote I/O modules, set the I/O table selection of I/O table (parameter No.004A) to "1: Use I/O device table". When "0: Use digital I/O table" is set and I/O devices are assigned, I/O table select error (system error E511), and system setting error (RIO control alarm 38, detail 05 to 06) occur.• Assign the I/O device not to overlap other settings. If the assignment is overlapped or exceeds the range of the I/O device table, the I/O No. assignment error (system error E510) and I/O No. assignment setting error (RIO control alarm 39, detail 01 and 02) occur.• Set the total points of the I/O devices assigned to remote I/O when setting I/O device points (parameter No.0210, 0212, 0214, 0216).• The delay time for the input device table to be updated after the signals of an input module or intelligent function module are input is SSCNET III/H head module input response time + (control cycle × 2). Refer to "MELSEC-L SSCNET III/H Head Module User's Manual" for input response time of SSCNET III/H head module.• The delay time for the C Controller module to update the output device table, and signals of an output module or intelligent function module to be output is SSCNET III/H head module output response time + (control cycle × 3). Also, for output of output bit devices using the other axes start function, the delay time from when other axes start conditions are established is SSCNET III/H head module output response time + (control cycle × 2). Refer to "MELSEC-L SSCNET III/H Head Module User's Manual" for output response time of SSCNET III/H head module.• When using I/O modules and intelligent function modules the I/O status may not be updated every control cycle depending on the control cycle setting and points used. Refer to "MELSEC-L SSCNET III/H Head Module User's Manual" for I/O status update times. When the time for the I/O status of the SSCNET III/H head module to be updated does not fit in the control cycle, the I/O status of I/O devices may not be updated every control cycle. When the I/O status is not updated every control cycle, perform any of the following.<ul style="list-style-type: none">• Change the control cycle.• If more than one SSCNET III/H head module is being used, change the distribution of I/O modules and intelligent function modules.• Increase the number of SSCNET III/H head modules.

6. APPLICATION FUNCTIONS

API LIBRARY

- Use the `sscGetInputDeviceBit` function to get input bit device.
- Use the `sscGetInputDeviceWord` function to get input word device.
- Use the `sscSetOutputDeviceBit` function to set output bit device.
- Use the `sscSetOutputDeviceWord` function to set output word device.
- Use the `sscGetOutputDeviceBit` function to get output bit device.
- Use the `sscGetOutputDeviceWord` function to get output word device.

6. APPLICATION FUNCTIONS

6.33.5 Example of setting procedure

The following shows the settings for two SSCNET III/H head modules (station 21 and station 22).

(1) Entire system configuration diagram

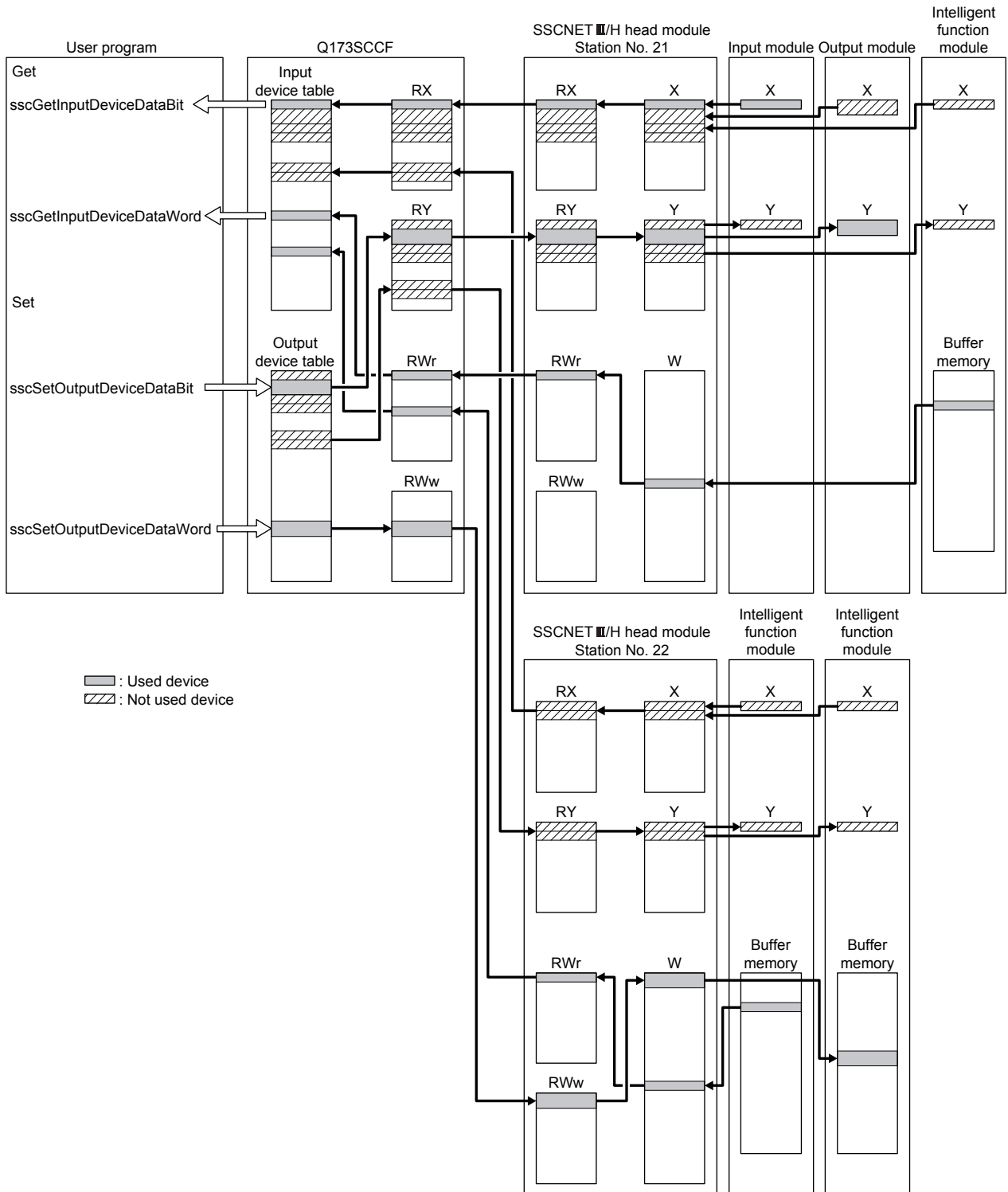

6. APPLICATION FUNCTIONS

Station No. on module	Station No.	Input/Output	Setting for SSCNETⅢ/H head module (link device assignment)			I/O device table	
			Device name	Points		Points	Start
21	1	Input	RX	64	→	64	Input bit device 000
			RWr	1 (1 word)	→	1 (1 word)	Input word device 0A
		Output	RY	64	←	64	Output bit device 000
22	2	Input	RX	32	→	32	Input bit device 070
			RWr	1 (1 word)	→	1 (1 word)	Input word device 10
		Output	RY	32	←	32	Output bit device 080
			RWw	2 (2 words)	←	2 (2 words)	Output word device 14

(2) SSCNETⅢ/H head module setting

Use GX Works2 to assign I/O of modules and buffer memory to the SSCNETⅢ/H head module link devices. Refer to "MELSEC-L SSCNETⅢ/H Head Module User's Manual" for SSCNETⅢ/H head module settings.

POINT
<ul style="list-style-type: none"> When setting SSCNETⅢ/H head module in GX Works2, check that the mode of "SSCNETⅢ/H Network Setting" on the "Communication Head Setting" tab is set to "Online". If the mode is not set to "Online", the Q173SCCF cannot communicate with the SSCNETⅢ/H head module. If the system is startup in this state, it stays in a waiting for SSCNET response (system status code 0009) state, or an axis that has not been mounted exists (system error E400) occurs.

(3) Q173SCCF setting

In order to allocate SSCNETⅢ/H head module link devices to the Q173SCCF I/O device table, set the total number of points (in units of 16) of each link device, and the start I/O device number to be assigned.

(a) Station parameter

Module No.	Parameter No.	Abbreviation	Name	Setting value
1	0210	*BDIO	Input bit device points	64
	0211	*BDINA	Input bit device start number	0000h
	0212	*WDIO	Input word device points	1
	0213	*WDINA	Input word device start number	000Ah
	0214	*BDOO	Output bit device points	64
	0215	*BDONA	Output bit device start number	0000h
	0216	*WDOO	Output word device points	0
	0217	*WDONA	Output word device start number	0000h
2	0210	*BDIO	Input bit device points	32
	0211	*BDINA	Input bit device start number	0070h
	0212	*WDIO	Input word device points	1
	0213	*WDINA	Input word device start number	0010h
	0214	*BDOO	Output bit device points	32
	0215	*BDONA	Output bit device start number	0080h
	0216	*WDOO	Output word device points	2
	0217	*WDONA	Output word device start number	0014h

6. APPLICATION FUNCTIONS

(4) Setting/getting I/O devices with API functions

Examples of getting input devices and setting/getting output devices are shown in the table below.

Note that the board ID is 0, and channel number is 1.

Module No.	Device name	Set/get	Setting value
1	RX	Get input bit device 002	<code>sscGetInputDeviceBit (0, 1, 0x0002, &data);</code>
	RWr	Get one word of input word device 0A	<code>sscGetInputDeviceWord (0, 1, 0x0000A, 1, &data);</code>
	RY	Set output bit device 087 to ON	<code>sscSetOutputDeviceBit (0, 1, 0x0087, SSC_ON);</code>
2	RWw	Set output word device 14 to 000Ah (one word)	<code>sscSetOutputDeviceWord (0, 1, 0x0014, 1, 0x000A);</code>

6.33.6 SSCNET III/H head module disconnect

The system can be startup with the SSCNET III/H head module disconnected, and simulate can be performed by making remote I/O disconnect valid in control option 1 (parameter No.0200) of the RIO module parameter. However, the input bit devices allocated to SSCNET III/H head module are OFF, and input word devices are 0 and are not updated. Also, any changes made to the status of output bit devices and output word devices allocated to SSCNET III/H head module are not output to the SSCNET III/H head module. (The status of output bit devices and output word devices can only be checked.)

6. APPLICATION FUNCTIONS

6.34 Sensing module connection

6.34.1 Summary

The sensing module consists of an SSCNET III/H communication module (sensing SSCNET III/H head module), and sensing extension modules (sensing I/O module, sensing pulse I/O module, sensing analog I/O module, sensing encoder I/F module) and fetches and outputs signals synchronized with SSCNET III/H communication. The sensing module controls input and output of sensing SSCNET III/H head module and sensing extension module I/O using link devices.

By assigning inputs and outputs of sensing SSCNET III/H head module and sensing extension modules to the I/O device table, they can be used as Q173SCCF inputs and outputs.

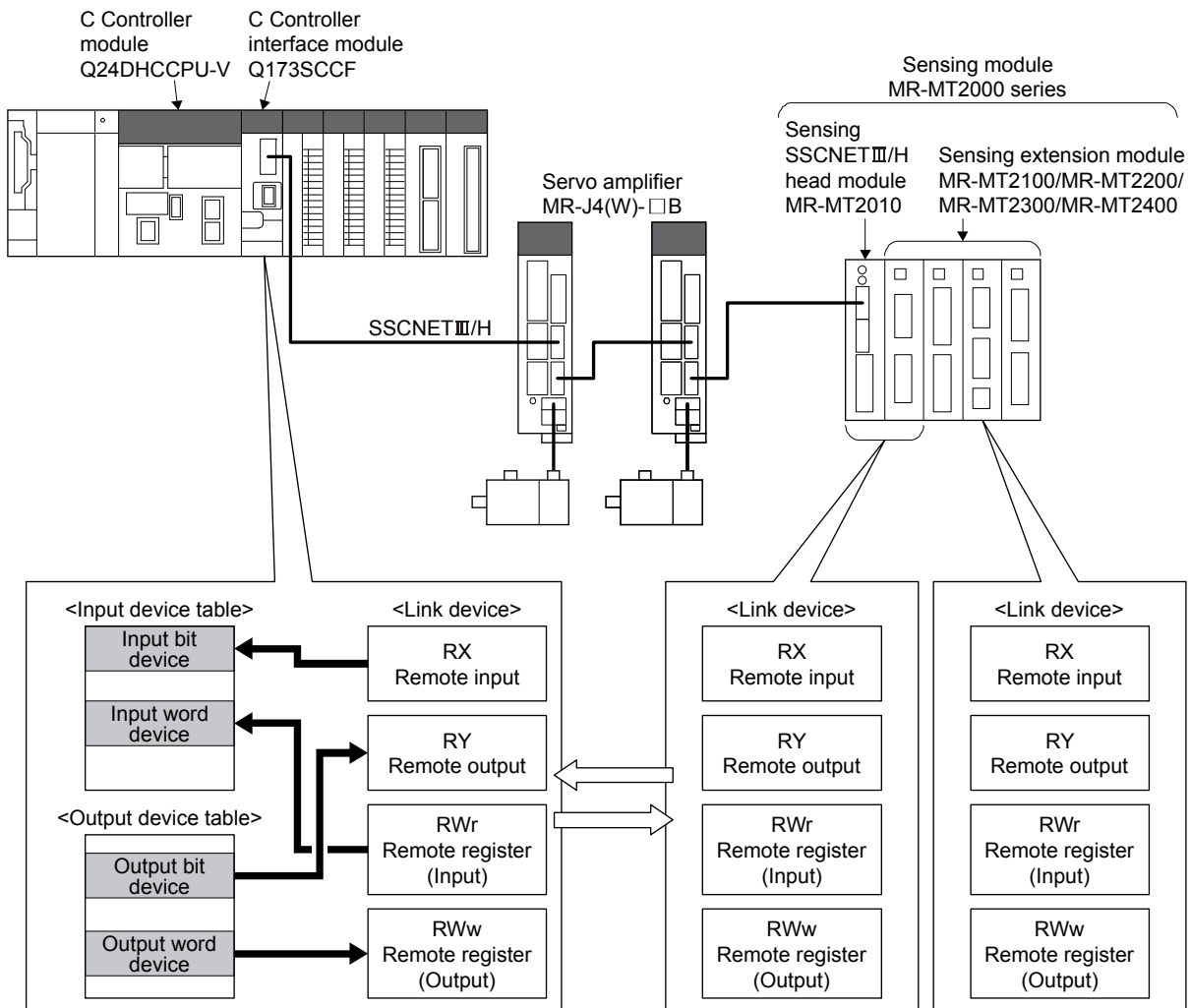

6. APPLICATION FUNCTIONS

(1) Number of connectable stations

The sensing module can use up to 4 stations.

The following shows the number of stations that can be controlled depending on the control cycle.

Control cycle	Maximum number of stations connected	Maximum number of stations connected per line	Recommended number of control axes
0.88ms	4 stations	4 stations	20 axes
0.44ms	2 stations	2 stations	12 axes
0.22ms	1 station	1 station	4 axes

Note. Processing times vary depending on the number of axes and functions used.

When operation cycle alarm (OCME), and operation cycle warning (OCMW) turn ON, review the following:

- Make the control cycle longer. (Example: When control cycle is 0.44ms, change it to 0.88ms)
- Reduce the number of control axes.
- Review the operation pattern so that the operation startup times of each axis do not overlap.

POINT
<ul style="list-style-type: none"> • For details on the stations of the sensing module, refer to the Sensing Module Instruction Manual. • When using the sensing module and SSCNET III/H head module at the same time, the maximum number of stations connected is the total number of stations connected by the sensing module and SSCNET III/H head module combined. • When 2 or more sensing extension modules are connected to a sensing SSCNET III/H head module, set the control station to "1: Controlled" for the RIO module parameter control option 1 (parameter No.0200) of all connected stations. If the control station is not set to "1: Controlled" for the RIO module parameter control option 1 (parameter No.0200) of all connected stations, an axis that has not been mounted exists (system error E400) occurs.

6. APPLICATION FUNCTIONS

6.34.2 Supported functions

The following sensing module and Q173SCCF functions are supported when the sensing module is used.

(1) Sensing module functions supported by the Q173SCCF

Classification	Function	Compatibility	Remarks
Sensing SSCNETⅢ/H head module	Digital input function	○	Returns the current ON/OFF state of the DI signals (12 points) to the Q173SCCF.
	Timing-latch input function	×	
	Digital output function	○	Turns ON/OFF the DO signal (2 points) according to the command from the Q173SCCF.
	Level output function	○	Provides digital output according to the level of the monitor values of the sensing pulse I/O module, sensing analog I/O module, and sensing encoder I/F module. Digital output is provided without going through the Q173SCCF.
	Output CLEAR/HOLD function	○	Specifies the state of output of external DO signals of the sensing module when communication is disconnected.
Sensing I/O module	Digital input function	○	Returns the current ON/OFF state of the DI signals (16 points) to the Q173SCCF.
	Timing-latch input function	×	
	Digital output function	○	Turns ON/OFF the DO signal (16 points) according to the command from the Q173SCCF.
	Level output function	○	Provides digital output according to the level of the monitor values of the sensing pulse I/O module, sensing analog I/O module, and sensing encoder I/F module. Digital output is provided without going through the Q173SCCF.
	Output CLEAR/HOLD function	○	Specifies the state of output of external DO signals of the sensing module when communication is disconnected.
Sensing pulse I/O module	Axis mode	×	
	Pulse input function	○	Enables the sending of feedback pulses to the Q173SCCF. (Max. 2 points)
	Pulse output function	○	Enables the output of pulses. (Max. 2 points)
	Digital input function	○	Returns the current ON/OFF state of the DI signals (14 points) to the Q173SCCF.
	Digital output function	○	Turns ON/OFF the DO signal (max. 10 points) according to the command from the Q173SCCF.
	Pulse coincidence output function	○	Controls the DO signal when pulse output coincides with the pulse counter value specified by the Q173SCCF. (Max. 2 points)
	Output CLEAR/HOLD function	○	Specifies the state of output of external DO signals of the sensing module when communication is disconnected.
Sensing analog I/O module	Analog input function	○	Enables the sending of analog input to the Q173SCCF. (Max. 4 channels)
	Analog output function	○	Enables the output of analog signals. (Max. 4 channels)
	Analog input averaging function	○	Averages multiple analog channel data, and notifies the Q173SCCF. (Max. 2 groups)
	Maximum/minimum value holding function	○	Enables checking of the values held in the analog I/O module with the Q173SCCF.
Sensing encoder I/F module	Encoder input function	○	Sends the position data from the encoder to the Q173SCCF. Compatible with open specification encoder interface.

Note. ○: Usable △: Restriction ×: Unusable —: Not applicable

6. APPLICATION FUNCTIONS

(2) Supported Q173SCCF functions

Classification	Function	Compatibility	Remarks
Application functions	Forced stop	○	Controller forced stop warning (RIO module warning E7) occurs. Refer to Sensing Module Instruction Manual for operation at a controller forced stop warning occurrence.
	Other axes start	○	
	Digital I/O	×	
	I/O device	○	
	Dual port memory exclusive control	○	
	SSCNETⅢ/H head module	—	
Auxiliary functions	Reading/writing parameters	△	Do not write RIO module parameters when the system is running.
	Changing parameters at the servo	×	
	Alarm and system error	○	
	Remote I/O disconnect	○	
	Monitor function	○	
	Interrupt	○	
	User watchdog function	—	When user watchdog function is used, there is no effect on the state of the link device I/O.
	Software reboot function	—	The I/O devices on the dual port memory are cleared to 0 regardless of the control option 2 setting. The output state of the external DO signal of the sensing module depends on the output CLEAR/HOLD function.
	Parameter backup	○	
	Test mode	×	
	Reconnect/disconnect function	△	Only the start station of the sensing module can be specified as disconnecting axis No.
	Sampling	△	Only the test tool supports the sampling of I/O device.
	Log	○	
	Operation cycle monitor function	—	
	Alarm history function	○	
Transient transmission	×		

Note. ○: Usable △: Restriction ×: Unusable —: Not applicable

6. APPLICATION FUNCTIONS

6.34.3 System startup

(1) Station No. setting parameter

Station No. settings are made with the station number selection rotary switch.

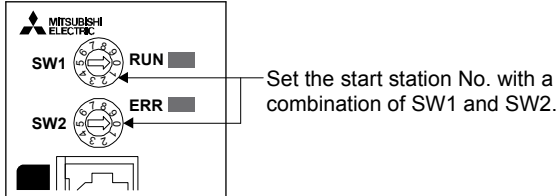

The station No. and station number selection rotary switch combinations are correlated as shown on the table below. Set the station No. so that it will not duplicate in the same line. If it is duplicated, the "An axis that has not been mounted exists" (system error E400) will occur at the time of system startup (system command code: 000Ah).

Station number selection rotary switch		Station No. on remote I/O module (Note 1)				Available/ unavailable
SW1	SW2	Start station	Second station	Third station	Fourth station	
0	0	Station 1	Station 2	Station 3	Station 4	Unavailable
	1	Station 2	Station 3	Station 4	Station 5	
	2	Station 3	Station 4	Station 5	Station 6	
	3	Station 4	Station 5	Station 6	Station 7	
	4	Station 5	Station 6	Station 7	Station 8	
	5	Station 6	Station 7	Station 8	Station 9	
	6	Station 7	Station 8	Station 9	Station 10	
	7	Station 8	Station 9	Station 10	Station 11	
	8	Station 9	Station 10	Station 11	Station 12	
	9	Station 10	Station 11	Station 12	Station 13	
1	0	Station 11	Station 12	Station 13	Station 14	
	1	Station 12	Station 13	Station 14	Station 15	
	2	Station 13	Station 14	Station 15	Station 16	
	3	Station 14	Station 15	Station 16	Station 17	
	4	Station 15	Station 16	Station 17	Station 18	
	5	Station 16	Station 17	Station 18	Station 19	
	6	Station 17	Station 18	Station 19	Station 20	
	7	Station 18	Station 19	Station 20	Station 21	
	8	Station 19	Station 20	Station 21	Station 22	
	9	Station 20	Station 21	Station 22	Station 23	
2	0	Station 21	Station 22	Station 23	Station 24	Available
	1	Station 22	Station 23	Station 24	(Note 2)	
	2	Station 23	Station 24	(Note 2)		
	3	Station 24	(Note 2)			

Note. 1 When connecting sensing SSCNET III/H head + sensing extension module, the station No. for the second sensing extension module and after is assigned in ascending order from the sensing SSCNET III/H head module.

2 Set so that the remote I/O station No. of last connected sensing extension module does not exceed station 24. If station 24 is exceeded, the "An axis that has not been mounted exists" (system error E400) will occur at the time of system startup (system command code: 000Ah).

6. APPLICATION FUNCTIONS

(2) Station No. assignment

With station No. assignment, station No. (station No. on the Q173SCCF) are assigned to station No. on remote I/O modules.

Also refer to axis No. assignment (Section 4.4.6) for station No. assignment.

When station No. assignment is invalid, correspondence between the station No. on a remote I/O module and the station No. is shown in the following table.

Station No. on remote I/O module		Line 1			
		21	22	23	24
Station No.	0.88ms	1	2	3	4
	0.44ms	1	2	-	-
	0.22ms	1	-	-	-

API LIBRARY

- When setting the API function argument "Axis No." to a station No., set a negative value. (Station 1: -1, station 2: -2, station 3: -3, station 4: -4)

(3) Remote I/O module I/O setting

When using remote I/O modules, set the I/O table selection of I/O table (parameter No.004A) to "1: Use I/O device table".

Also, set the points of the I/O devices controller by the Q173SCCF, and the start No. to be assigned to the I/O device table.

(4) Vendor ID and type code setting

Available functions, parameter settings and ranges will vary by remote I/O module type. At the time the communication with the remote I/O module has started, the Q173SCCF will perform consistency check between vendor ID and type code of the module connected and the parameter set. If a consistency check error occurs, driver type code error (system error E405) will be output, therefore set correct vendor ID and type code.

POINT

- If driver type code error (system error E405) occurred, the station that has set an incorrect type code can be confirmed with "type code erroneous station information" (system information monitor No.04C1).

6. APPLICATION FUNCTIONS

(a) RIO control parameter

Parameter No.	Abbreviation	Name	Function
021D	*VEND	Vendor ID	Set the vendor ID. 0000h: Mitsubishi Electric
021E	*CODE	Type code	Set the type code. 3010h: Sensing SSCNETⅢ/H head module 3011h: Sensing SSCNETⅢ/H head module+Sensing I/O module 3012h: Sensing SSCNETⅢ/H head module+Sensing pulse I/O module 3013h: Sensing SSCNETⅢ/H head module+Sensing analog I/O module 3014h: Sensing SSCNETⅢ/H head module+Sensing encoder I/F module 3021h: Sensing I/O module 3022h: Sensing pulse I/O module 3023h: Sensing analog I/O module 3024h: Sensing encoder I/F module

6.34.4 Interface

(1) Parameter

(a) System parameter

Parameter No.	Abbreviation	Name	Initial value	Units	Setting range	Function				
004A	*IOTBL	I/O table	0000h		0000h to 0001h	<table border="1" style="display: inline-table; vertical-align: middle;"> <tr> <td style="width: 20px; height: 20px; text-align: center;">0</td> <td style="width: 20px; height: 20px; text-align: center;">0</td> <td style="width: 20px; height: 20px; text-align: center;">0</td> <td style="width: 20px; height: 20px;"></td> </tr> </table> <p style="margin-left: 40px;">└ I/O table selection Set the I/O table to be used. 0: Use digital I/O table 1: Use I/O device table</p> <p>Note. For sensing module, set "1: Use I/O device table"</p>	0	0	0	
0	0	0								

(b) RIO module parameter

The parameter Nos. for each sensing module are shown below.

Module	Parameter No.	Sensing module parameter No.
Sensing SSCNETⅢ/H head module	1100 to 117F	PTA001 to PTA128
Sensing I/O module	1180 to 127F	PTB001 to PTB256
Sensing pulse I/O module	1280 to 12FF	PTC001 to PTC128
Sensing analog I/O module	1300 to 137F	PTD001 to PTD128
Sensing encoder I/F module	1380 to 13FF	PTE001 to PTE128

POINT

- Do not write RIO module parameters when the system is running.

6. APPLICATION FUNCTIONS

(c) RIO control parameter

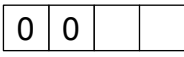
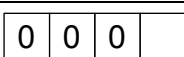
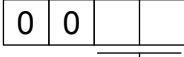
Parameter No.	Abbreviation	Name	Initial value	Units	Setting range	Function
0200	*OPC1	Control option 1	0000h		0000h to 0011h	 <p>Control station Set to 1 for implementing control of a remote I/O module. 0: Not controlled 1: Controlled</p> <p>Remote I/O disconnect Set to 1 when remote I/O communication is not implemented. When set to 1 together with the control station, it is possible to run without a remote I/O (simulate). 0: Invalid 1: Valid</p>
0201	OPC2	Control option 2	0000h		0000h to 0001h	 <p>RI control at communication error Set input device control at communication error(system error E401 to E407) 0: All points OFF 1: Maintain status</p>
0202	*UTALC	Station No. assignment	0001h		0000h to 001Fh	 <p>Remote I/O station No. Set the remote I/O station No. to be assigned to the station No. on the Q173SCCF. 00h : No station No. assignment 15h to 18h : Station No. Example) 16h: Remote I/O station No. 22</p>
0210	*BDIO	Input bit device points	0000h		0000h to 0200h	Set the points used for input bit device. 0000h to 0200h: 0 to 512 Note. Only a multiple of 16 can be selected.
0211	*BDINA	Input bit device start number	0000h		0000h to 0FF0h	Set the start of the input bit device number assigned to RX. 0000h to 0FF0h: 0 to 4080 Note. Only a multiple of 16 can be selected. Example: When the input points are 64, and input bit device 020 is specified as the start, assign the 64 points of DVI_020 to DVI_05F.
0212	*WDIO	Input word device points	0000h		0000h to 0020h	Set the points used for input word device. 0000h to 0020h: 0 to 32 Note. The size used is 1 word × set value.
0213	*WDINA	Input word device start number	0000h		0000h to 00FFh	Set the start of the input word device number assigned to RW. 0000h to 00FFh: 0 to 255 Example: When the input points are 2, and input word device 06 is specified as the start, assign input word devices 06 to 07.
0214	*BDOO	Output bit device points	0000h		0000h to 0200h	Set the points used for output bit device. 0000h to 0200h: 0 to 512 Note. Only a multiple of 16 can be selected.

6. APPLICATION FUNCTIONS

Parameter No.	Abbreviation	Name	Initial value	Units	Setting range	Function
0215	*BDONA	Output bit device start number	0000h		0000h to 0FF0h	Set the start of the output bit device number assigned to RY. 0000h to 0FF0h: 0 to 4080 Note. Only a multiple of 16 can be selected. Example: When the output points are 64, and output bit device 040 is specified as the start, assign the 64 points of DVO_040 to DVO_07F.
0216	*WDOO	Output word device points	0000h		0000h to 0020h	Set the points used for output word device. 0000h to 0020h: 0 to 32 Note. The size used is 1 word × set value.
0217	*WDONA	Output word device start number	0000h		0000h to 00FFh	Set the start of the output word device number assigned to RWw. 0000h to 00FFh: 0 to 255 Example: When the output points are 2, and output word device 08 is specified as the start, assign output word devices 08 to 09.
021D	*VEND	Vendor ID	0000h		0000h to FFFFh	Set the vendor ID. 0000h: Mitsubishi Electric
021E	*CODE	Type code	3000h		0000h to FFFFh	Set the type code. 3000h: SSCNETⅢ/H head module 3010h: Sensing SSCNETⅢ/H head module 3011h: Sensing SSCNETⅢ/H head module+Sensing I/O module 3012h: Sensing SSCNETⅢ/H head module+Sensing pulse I/O module 3013h: Sensing SSCNETⅢ/H head module+Sensing analog I/O module 3014h: Sensing SSCNETⅢ/H head module+Sensing encoder I/F module 3021h: Sensing I/O module 3022h: Sensing pulse I/O module 3023h: Sensing analog I/O module 3024h: Sensing encoder I/F module

POINT

- Set "1: Use I/O device table" for the I/O table setting. When "0: Use digital I/O table" is set, system setting error (operation alarm No. 38, detail 05 to 06) will occur.
- Assign the I/O device table not to overlap other settings. If the assignment is overlapped or exceeds the maximum points of the I/O device table, the I/O No. assignment error (system error E510) and I/O No. assignment setting error (RIO control alarm 39, detail 01 and 02) occur.
- Refer to Sensing Module Instruction Manual for points used for I/O devices.

6. APPLICATION FUNCTIONS

(2) RIO data command/status table

(a) RIO status bit

Address	Bit	Abbreviation	Signal name
3440	0	RURDY	Receiving controller ready on
	1	RUA	Outputting DO
	2		Reserved
	3		
	4		
	5	RUALM	RIO module alarm
	6	RUWRN	RIO module warning
	7		Reserved

Note 1. The addresses above are the addresses for the first station. For the second station and after, increase by 80h for each station.

1) Details on RIO status bit

Abbreviation	Signal name	Remarks
RURDY	Receiving controller ready on	[Function] Shows the operating status of remote I/O module.
RUA	Outputting DO	RURDY: OFF, RUA: OFFNo communication RURDY: ON, RUA: OFFStop RURDY: ON, RUA: ONRun RURDY: OFF, RUA: ONError

Note 1. When I/O No. assignment error (system error E510), and I/O table select error (system error E511) have occurred, Outputting DO (RUA) does not turn ON.

6. APPLICATION FUNCTIONS

(3) I/O device table

(a) Input device table

Address	Input word device number	Input bit device number	Abbreviation	Remarks
DB00	Input word device 00 (2 bytes)	Input word device 000 to Input word device 00F	DVI_000 to DVI_00F	[When bit device is assigned] Notifies the status of the bit device input signal. The bits are DVI_000 (bit0) to DVI_00F (bit15). [When word device is assigned] Notifies the status of the word device input signal.
DB02	Input word device 01 (2 bytes)	Input word device 010 to Input word device 01F	DVI_010 to DVI_01F	[When bit device is assigned] Notifies the status of the bit device input signal. The bits are DVI_010 (bit0) to DVI_01F (bit15). [When word device is assigned] Notifies the status of the word device input signal.
DB04	Input word device 02 (2 bytes)	Input word device 020 to Input word device 02F	DVI_020 to DVI_02F	[When bit device is assigned] Notifies the status of the bit device input signal. The bits are DVI_020 (bit0) to DVI_02F (bit15). [When word device is assigned] Notifies the status of the word device input signal.
DB06	Input word device 03 (2 bytes)	Input word device 030 to Input word device 03F	DVI_030 to DVI_03F	[When bit device is assigned] Notifies the status of the bit device input signal. The bits are DVI_030 (bit0) to DVI_03F (bit15). [When word device is assigned] Notifies the status of the word device input signal.
DB08	Input word device 04 (2 bytes)	Input word device 040 to Input word device 04F	DVI_040 to DVI_04F	[When bit device is assigned] Notifies the status of the bit device input signal. The bits are DVI_040 (bit0) to DVI_04F (bit15). [When word device is assigned] Notifies the status of the word device input signal.
DB0A	Input word device 05 (2 bytes)	Input word device 050 to Input word device 05F	DVI_050 to DVI_05F	[When bit device is assigned] Notifies the status of the bit device input signal. The bits are DVI_050 (bit0) to DVI_05F (bit15). [When word device is assigned] Notifies the status of the word device input signal.
DB0C	Input word device 06 (2 bytes)	Input word device 060 to Input word device 06F	DVI_060 to DVI_06F	[When bit device is assigned] Notifies the status of the bit device input signal. The bits are DVI_060 (bit0) to DVI_06F (bit15). [When word device is assigned] Notifies the status of the word device input signal.
DB0E	Input word device 07 (2 bytes)	Input word device 070 to Input word device 07F	DVI_070 to DVI_07F	[When bit device is assigned] Notifies the status of the bit device input signal. The bits are DVI_070 (bit0) to DVI_07F (bit15). [When word device is assigned] Notifies the status of the word device input signal.
:	:	:	:	:
DCFE	Input word device FF (2 bytes)	Input word device FF0 to Input word device FFF	DVI_FF0 to DVI_FFF	[When bit device is assigned] Notifies the status of the bit device input signal. The bits are DVI_FF0 (bit0) to DVI_FFF (bit15). [When word device is assigned] Notifies the status of the word device input signal.

6. APPLICATION FUNCTIONS

(b) Output device table

Address	Output word device number	Output bit device number	Abbreviation	Remarks
DD00	Output word device 00 (2 bytes)	Output word device 000 to Output word device 00F	DVO_000 to DVO_00F	[When bit device is assigned] Turns ON/OFF the bit device output signal. The bits are DVO_000 (bit0) to DVO_00F (bit15). [When word device is assigned] Turns ON/OFF the word device output signal.
DD02	Output word device 01 (2 bytes)	Output word device 010 to Output word device 01F	DVO_010 to DVO_01F	[When bit device is assigned] Turns ON/OFF the bit device output signal. The bits are DVO_010 (bit0) to DVO_01F (bit15). [When word device is assigned] Turns ON/OFF the word device output signal.
DD04	Output word device 02 (2 bytes)	Output word device 020 to Output word device 02F	DVO_020 to DVO_02F	[When bit device is assigned] Turns ON/OFF the bit device output signal. The bits are DVO_020 (bit0) to DVO_02F (bit15). [When word device is assigned] Turns ON/OFF the word device output signal.
DD06	Output word device 03 (2 bytes)	Output word device 030 to Output word device 03F	DVO_030 to DVO_03F	[When bit device is assigned] Turns ON/OFF the bit device output signal. The bits are DVO_030 (bit0) to DVO_03F (bit15). [When word device is assigned] Turns ON/OFF the word device output signal.
DD08	Output word device 04 (2 bytes)	Output word device 040 to Output word device 04F	DVO_040 to DVO_04F	[When bit device is assigned] Turns ON/OFF the bit device output signal. The bits are DVO_040 (bit0) to DVO_04F (bit15). [When word device is assigned] Turns ON/OFF the word device output signal.
DD0A	Output word device 05 (2 bytes)	Output word device 050 to Output word device 05F	DVO_050 to DVO_05F	[When bit device is assigned] Turns ON/OFF the bit device output signal. The bits are DVO_050 (bit0) to DVO_05F (bit15). [When word device is assigned] Turns ON/OFF the word device output signal.
DD0C	Output word device 06 (2 bytes)	Output word device 060 to Output word device 06F	DVO_060 to DVO_06F	[When bit device is assigned] Turns ON/OFF the bit device output signal. The bits are DVO_060 (bit0) to DVO_06F (bit15). [When word device is assigned] Turns ON/OFF the word device output signal.
DD0E	Output word device 07 (2 bytes)	Output word device 070 to Output word device 07F	DVO_070 to DVO_07F	[When bit device is assigned] Turns ON/OFF the bit device output signal. The bits are DVO_070 (bit0) to DVO_07F (bit15). [When word device is assigned] Turns ON/OFF the word device output signal.
:	:	:	:	:
DEFE	Output word device FF (2 bytes)	Output word device FF0 to Output word device FFF	DVO_FF0 to DVO_FFF	[When bit device is assigned] Turns ON/OFF the bit device output signal. The bits are DVO_FF0 (bit0) to DVO_FFF (bit15). [When word device is assigned] Turns ON/OFF the word device output signal.

6. APPLICATION FUNCTIONS

(4) Sensing module link devices

The contents of the devices (Input: RX, RWr/Output: RY, RWw) for storage of link data for communicating between the Q173SCCF and sensing module (station mode) are different for each module. The contents of the devices for storage of link data for each module are shown below.

(a) Sensing SSCNETⅢ/H head module

1) Input device

a) Bit data area (RX)

Offset(Note)	Signal name	Description
+0	External input DI1	Stores the input state of DI1 to DI12 of sensing SSCNETⅢ/H head module. 0: OFF 1: ON
+1	External input DI2	
+2	External input DI3	
+3	External input DI4	
+4	External input DI5	
+5	External input DI6	
+6	External input DI7	
+7	External input DI8	
+8	External input DI9	
+9	External input DI10	
+10	External input DI11	
+11	External input DI12	
+12	Unusable	—
+13		
+14		
+15		
+16		
+17	DO2 output enabling	
+18	Unusable	—
+19		
+20		
+21		
+22		
+23		
+24		
+25		
+26		
+27		
+28		
+29		
+30		
+31		

Note. The offset is the bit units from the start of the input device table that assigned the input bit device.

6. APPLICATION FUNCTIONS

b) Word data area (RWr)

Offset(Note)	Signal name	Description
+0	DO output state (DO for each signal)	Stores the DO output state of the sensing SSCNETⅢ/H head module.
+1	Unusable	—
+2		
+3		
+4		
+5		
+6		
+7		
+8		
+9		
+10		
+11		
+12		
+13		
+14		
+15		
+16		
+17		
+18		
+19		
+20		
+21		
+22		
+23		
+24		
+25		
+26		
+27		
+28		
+29		
+30		
+31		

Note. The offset is the word units from the start of the input device table that assigned the input bit device.

6. APPLICATION FUNCTIONS

2) Output device

a) Bit data area (RY)

Offset(Note)	Signal name	Description
+0	External output DO1	Sets the command for DO1, DO2 of sensing SSCNETⅢ/H head module. 0: OFF 1: ON
+1	External output DO2	
+2	Unusable	—
+3		
+4		
+5		
+6		
+7		
+8		
+9		
+10		
+11		
+12		
+13		
+14		
+15		
+16	DO1 output enable	Enables output of DO1, DO2 of the sensing SSCNETⅢ/H head module. 0: Disable 1: Enable
+17	DO2 output enable	
+18	Unusable	—
+19		
+20		
+21		
+22		
+23		
+24		
+25		
+26		
+27		
+28		
+29		
+30		
+31		

Note. The offset is the bit units from the start of the output device table that assigned the output bit device.

6. APPLICATION FUNCTIONS

b) Word data area (RWw)

Offset(Note)	Signal name	Description
+0	Unusable	—
+1		
+2		
+3		
+4		
+5		
+6		
+7		
+8		
+9		
+10		
+11		
+12		
+13		
+14		
+15		
+16		
+17		
+18		
+19		
+20		
+21		
+22		
+23		
+24		
+25		
+26		
+27		
+28		
+29		
+30		
+31		

Note. The offset is the word units from the start of the output device table that assigned the output bit device.

6. APPLICATION FUNCTIONS

(b) Sensing SSCNETⅢ/H head module+Sensing extension module

1) Input device

a) Bit data area (RX)

Offset(Note)	Signal name	Description
+0	External input DI1	Stores the input state of DI1 to DI12 of sensing SSCNETⅢ/H head module. 0: OFF 1: ON
+1	External input DI2	
+2	External input DI3	
+3	External input DI4	
+4	External input DI5	
+5	External input DI6	
+6	External input DI7	
+7	External input DI8	
+8	External input DI9	
+9	External input DI10	
+10	External input DI11	
+11	External input DI12	
+12	Unusable	—
+13		
+14		
+15		
+16	DO1 output enabling	Stores the output enable state of DO1 and DO2 of sensing SSCNETⅢ/H head module. 0: Disable 1: Enable
+17	DO2 output enabling	
+18	Unusable	—
+19		
+20		
+21		
+22		
+23		
+24		
+25		
+26		
+27		
+28		
+29		
+30		
+31		
+32	Sensing extension module bit data area	Stores the bit data area (RX) of the sensing extension module set to first station.
:		
+63		

Note. The offset is the bit units from the start of the input device table that assigned the input bit device.

6. APPLICATION FUNCTIONS

b) Word data area (RWr)

Offset(Note)	Signal name	Description
+0	DO output state (DO for each signal)	Stores the DO output state of the sensing SSCNETⅢ/H head module.
+1	Unusable	—
+2		
+3		
+4		
+5		
+6	Sensing extension module word data area	Stores the word data area (RWr) of the sensing extension module set to first station.
:		
+27		

Note. The offset is the word units from the start of the input device table that assigned the input bit device.

6. APPLICATION FUNCTIONS

2) Output device

a) Bit data area (RY)

Offset(Note)	Signal name	Description
+0	External output DO1	Sets the command for DO1, DO2 of sensing SSCNETⅢ/H head module. 0: OFF 1: ON
+1	External output DO2	
+2	Unusable	—
+3		
+4		
+5		
+6		
+7		
+8		
+9		
+10		
+11		
+12		
+13		
+14		
+15		
+16	DO1 output enable	Enables output of DO1, DO2 of the sensing SSCNETⅢ/H head module. 0: Disable 1: Enable
+17	DO2 output enable	
+18	Unusable	—
+19		
+20		
+21		
+22		
+23		
+24		
+25		
+26		
+27		
+28		
+29		
+30		
+31		
+32	Sensing extension module bit data area	Stores the bit data area (RY) of the sensing extension module set to first station.
:		
+63		

Note. The offset is the bit units from the start of the output device table that assigned the output bit device.

6. APPLICATION FUNCTIONS

b) Word data area (RWw)

Offset(Note)	Signal name	Description
+0	Unusable	—
+1		
+2		
+3		
+4		
+5		
+6	Sensing extension module word data area	Stores the word data area (RWw) of the sensing extension module set to first station.
:		
+27		

Note. The offset is the word units from the start of the output device table that assigned the output bit device.

6. APPLICATION FUNCTIONS

(c) Sensing I/O module

1) Input device

a) Bit data area (RX)

Offset(Note)	Signal name	Description
+0	External input DI1	Stores the input state of DI1 to DI16 of sensing I/O module. 0: OFF 1: ON
+1	External input DI2	
+2	External input DI3	
+3	External input DI4	
+4	External input DI5	
+5	External input DI6	
+6	External input DI7	
+7	External input DI8	
+8	External input DI9	
+9	External input DI10	
+10	External input DI11	
+11	External input DI12	
+12	External input DI13	
+13	External input DI14	
+14	External input DI15	
+15	External input DI16	
+16	DO1 output enabling	Stores the output enable state of DO1 to DO16 of sensing I/O module. 0: Disable 1: Enable
+17	DO2 output enabling	
+18	DO3 output enabling	
+19	DO4 output enabling	
+20	DO5 output enabling	
+21	DO6 output enabling	
+22	DO7 output enabling	
+23	DO8 output enabling	
+24	DO9 output enabling	
+25	DO10 output enabling	
+26	DO11 output enabling	
+27	DO12 output enabling	
+28	DO13 output enabling	
+29	DO14 output enabling	
+30	DO15 output enabling	
+31	DO16 output enabling	

Note. The offset is the bit units from the start of the input device table that assigned the input bit device.

6. APPLICATION FUNCTIONS

b) Word data area (RWr)

Offset(Note)	Signal name	Description
+0	DO output state (DO for each signal)	Stores the DO output state of the sensing I/O module.
+1	Unusable	—
+2		
+3		
+4		
+5		
+6		
+7		
+8		
+9		
+10		
+11		
+12		
+13		
+14		
+15		
+16		
+17		
+18		
+19		
+20		
+21		

Note. The offset is the word units from the start of the input device table that assigned the input bit device.

6. APPLICATION FUNCTIONS

2) Output device

a) Bit data area (RY)

Offset(Note)	Signal name	Description
+0	External output DO1	Sets the command for DO1 to DO16 of sensing I/O module. 0: OFF 1: ON
+1	External output DO2	
+2	External output DO3	
+3	External output DO4	
+4	External output DO5	
+5	External output DO6	
+6	External output DO7	
+7	External output DO8	
+8	External output DO9	
+9	External output DO10	
+10	External output DO11	
+11	External output DO12	
+12	External output DO13	
+13	External output DO14	
+14	External output DO15	
+15	External output DO16	
+16	DO1 output enable	Enables output of DO1 to DO16 of the sensing I/O module. 0: Disable 1: Enable
+17	DO2 output enable	
+18	DO3 output enable	
+19	DO4 output enable	
+20	DO5 output enable	
+21	DO6 output enable	
+22	DO7 output enable	
+23	DO8 output enable	
+24	DO9 output enable	
+25	DO10 output enable	
+26	DO11 output enable	
+27	DO12 output enable	
+28	DO13 output enable	
+29	DO14 output enable	
+30	DO15 output enable	
+31	DO16 output enable	

Note. The offset is the bit units from the start of the output device table that assigned the output bit device.

6. APPLICATION FUNCTIONS

b) Word data area (RWw)

Offset(Note)	Signal name	Description
+0	Unusable	—
+1		
+2		
+3		
+4		
+5		
+6		
+7		
+8		
+9		
+10		
+11		
+12		
+13		
+14		
+15		
+16		
+17		
+18		
+19		
+20		
+21		

Note. The offset is the word units from the start of the output device table that assigned the output bit device.

6. APPLICATION FUNCTIONS

(d) Sensing pulse I/O module

1) Input device

a) Bit data area (RX)

Offset(Note)	Signal name	Description	
+0	CN1	Stores the input state of CN1-DI1A to CN1-DI7A of sensing pulse I/O module. 0: OFF 1: ON	
+1			External input DI1A
+2			External input DI2A
+3			External input DI3A
+4			External input DI4A
+5			External input DI5A
+6			External input DI6A
+7			External input DI7A
+8	CN1	Stores the output enable state of CN1-DO1A to CN1-DO5A of sensing pulse I/O module. 0: Disable 1: Enable	
+9			Unusable
+10			DO1A output enabling
+11			DO2A output enabling
+12			DO3A output enabling
+13			DO4A output enabling
+14			DO5A output enabling
+15			Unusable
+16	CN2	Stores the input state of CN2-DI1B to CN2-DI7B of sensing pulse I/O module. 0: OFF 1: ON	
+17			External input DI1B
+18			External input DI2B
+19			External input DI3B
+20			External input DI4B
+21			External input DI5B
+22			External input DI6B
+23			External input DI7B
+24	CN2	Stores the output enable state of CN2-DO1B to CN2-DO5B sensing pulse I/O module. 0: Disable 1: Enable	
+25			Unusable
+26			DO1B output enabling
+27			DO2B output enabling
+28			DO3B output enabling
+29			DO4B output enabling
+30			DO5B output enabling
+31			Unusable

Note. The offset is the bit units from the start of the input device table that assigned the input bit device.

6. APPLICATION FUNCTIONS

b) Word data area (RWr)

Offset(Note)	Signal name	Description
+0	CN1	Pulse accumulated value
+1		
+2		Latch counter DI4A (pulse counter value)
+3		
+4		DO output state (for each DO signal)
+5		Unusable
+6		
+7		
+8	CN2	Pulse accumulated value
+9		
+10		Latch counter DI4B (pulse counter value)
+11		
+12		DO output state (for each DO signal)
+13		Unusable
+14		
+15		
+16	Unusable	
+17		
+18		
+19		
+20		
+21		

Note. The offset is the word units from the start of the input device table that assigned the input bit device.

6. APPLICATION FUNCTIONS

2) Output device

a) Bit data area (RY)

Offset(Note)	Signal name	Description		
+0	CN1	Sets the command for CN1-DO1A to CN1-DO5A of sensing pulse I/O module. 0: OFF 1: ON		
+1			External output DO1A	
+2			External output DO2A	
+3			External output DO3A	
+4			External output DO4A	
+5		Unusable	—	
+6				
+7				
+8				
+9				
+10		DO1A output enable	Enables output of CN1-DO1A to CN1-DO5A of sensing pulse I/O module. 0: Disable 1: Enable	
+11				DO2A output enable
+12				DO3A output enable
+13				DO4A output enable
+14				DO5A output enable
+15	CN2	Sets the command for CN2-DO1B to CN2-DO5B of sensing pulse I/O module. 0: OFF 1: ON		
+16			External output DO1B	
+17			External output DO2B	
+18			External output DO3B	
+19			External output DO4B	
+20		External output DO5B	—	
+21				
+22				
+23				
+24				
+25		DO1B output enable	Enables output of CN2-DO1B to CN2-DO5B of sensing pulse I/O module. 0: Disable 1: Enable	
+26				DO2B output enable
+27				DO3B output enable
+28				DO4B output enable
+29				DO5B output enable
+30	Unusable	—		
+31				

Note. The offset is the bit units from the start of the output device table that assigned the output bit device.

6. APPLICATION FUNCTIONS

b) Word data area (RWr)

Offset(Note)	Signal name	Description
+0	CN1	Pulse command value
+1		Sets the accumulated pulses since the power supply ON of the control circuit, output by CN1 of sensing pulse I/O module.
+2		ON timing (For pulse coincidence output function)
+3		
+4		OFF timing (For pulse coincidence output function)
+5		
+6		Unusable
+7		
+8	CN2	Pulse command value
+9		Sets the accumulated pulses since the power supply ON of the control circuit, output by CN2 of sensing pulse I/O module.
+10		ON timing (For pulse coincidence output function)
+11		
+12		OFF timing (For pulse coincidence output function)
+13		
+14		Unusable
+15		
+16	Unusable	
+17		
+18		
+19		
+20		
+21		

Note. The offset is the word units from the start of the output device table that assigned the output bit device.

6. APPLICATION FUNCTIONS

(e) Sensing analog I/O module

1) Input device

a) Bit data area (RX)

Offset(Note)	Signal name	Description
+0	Analog output signal CH1	Stores the output state of analog output CH1 to CH4 of sensing analog I/O module. 0: Stopped 1: Outputting
+1	Analog output signal CH2	
+2	Analog output signal CH3	
+3	Analog output signal CH4	
+4	Unusable	—
+5		
+6		
+7		
+8		
+9		
+10		
+11		
+12		
+13		
+14		
+15		
+16		
+17		
+18		
+19		
+20		
+21		
+22		
+23		
+24		
+25		
+26		
+27		
+28		
+29		
+30		
+31		

Note. The offset is the bit units from the start of the input device table that assigned the input bit device.

6. APPLICATION FUNCTIONS

b) Word data area (RWr)

Offset(Note)	Signal name	Description
+0	Maximum/Minimum value reset complete	Stores the reset state of maximum/minimum value. b0 0: CH1 resetting 1: CH1 reset complete b1 0: CH2 resetting 1: CH2 reset complete b2 0: CH3 resetting 1: CH3 reset complete b3 0: CH4 resetting 1: CH4 reset complete
+1	Unusable	—
+2	Digital value of analog input CH1	Converts the scaled value of voltage input to analog input CH1 to CH4 of sensing analog I/O module, and transfers to the Q173SCCF.
+3	Digital value of analog input CH2	
+4	Digital value of analog input CH3	
+5	Digital value of analog input CH4	
+6	Analog input channel average value Setting 1	
+7	Analog input channel average value Setting 2	
+8	Analog input maximum CH1	Stores the maximum value of voltage input to analog input CH1 to CH4 of sensing analog I/O module.
+9	Analog input maximum CH2	
+10	Analog input maximum CH3	
+11	Analog input maximum CH4	
+12	Analog input minimum CH1	Stores the minimum value of voltage input to analog input CH1 to CH4 of sensing analog I/O module.
+13	Analog input minimum CH2	
+14	Analog input minimum CH3	
+15	Analog input minimum CH4	
+16	Unusable	—
+17		
+18		
+19		
+20		
+21		

Note. The offset is the word units from the start of the input device table that assigned the input bit device.

6. APPLICATION FUNCTIONS

2) Output device

a) Bit data area (RY)

Offset(Note)	Signal name	Description
+0	Analog output enable CH1	Enable output of CH1 to CH4 of the sensing analog I/O module. 0: Disable 1: Enable
+1	Analog output enable CH2	
+2	Analog output enable CH3	
+3	Analog output enable CH4	
+4	Unusable	—
+5		
+6		
+7		
+8		
+9		
+10		
+11		
+12		
+13		
+14		
+15		
+16		
+17		
+18		
+19		
+20		
+21		
+22		
+23		
+24		
+25		
+26		
+27		
+28		
+29		
+30		
+31		

Note. The offset is the bit units from the start of the output device table that assigned the output bit device.

6. APPLICATION FUNCTIONS

b) Word data area (RWw)

Offset(Note)	Signal name	Description
+0	Maximum/Minimum value reset request	Stores the reset state of maximum/minimum value. b0 0: CH1 reset command OFF 1: CH1 reset command ON b1 0: CH2 reset command OFF 1: CH2 reset command ON b2 0: CH3 reset command OFF 1: CH3 reset command ON b3 0: CH4 reset command OFF 1: CH4 reset command ON
+1	Unusable	—
+2	Digital value of analog output CH1	Sets the voltage output by CH1 to CH4 of sensing analog I/O module with the scaled internal value.
+3	Digital value of analog output CH2	
+4	Digital value of analog output CH3	
+5	Digital value of analog output CH4	
+6	Unusable	—
+7		
+8		
+9		
+10		
+11		
+12		
+13		
+14		
+15		
+16		
+17		
+18		
+19		
+20		
+21		

Note. The offset is the word units from the start of the output device table that assigned the output bit device.

6. APPLICATION FUNCTIONS

(f) Sensing encoder I/F module

1) Input device

a) Bit data area (RX)

Offset(Note)	Signal name	Description
+0	Unusable	—
+1		
+2		
+3		
+4		
+5		
+6		
+7		
+8		
+9		
+10		
+11		
+12		
+13		
+14		
+15		
+16		
+17		
+18		
+19		
+20		
+21		
+22		
+23		
+24		
+25		
+26		
+27		
+28		
+29		
+30		
+31		

Note. The offset is the bit units from the start of the input device table that assigned the input bit device.

6. APPLICATION FUNCTIONS

b) Word data area (RWr)

Offset(Note)	Signal name	Description	
+0	CH.A	Transfers all data acquired from the encoder connected to CH.A of sensing encoder input I/F module. The information that can be acquired differs by encoder.	
+1			Encoder information 1
+2			Encoder information 2
+3			
+4			Encoder information 3
+5			
+6			Encoder current value (signed 32-bit data)
+7			
+8			Encoder error information
+9	Unusable	—	
+10	CH.B	Transfers all data acquired from the encoder connected to CH.B of sensing encoder input I/F module. The information that can be acquired differs by encoder.	
+11			Encoder information 1
+12			Encoder information 2
+13			Encoder information 3
+14			External input signal DI2 latch counter
+15			External input signal DI3 latch counter
+16			External input signal DI4 latch counter
+17			Encoder current value (signed 32-bit data)
+18			Encoder error information
+19	Unusable	—	
+20	Unusable	—	
+21	Unusable	—	

Note. The offset is the word units from the start of the input device table that assigned the input bit device.

6. APPLICATION FUNCTIONS

2) Output device

a) Bit data area (RY)

Offset(Note)	Signal name	Description
+0	Unusable	—
+1		
+2		
+3		
+4		
+5		
+6		
+7		
+8		
+9		
+10		
+11		
+12		
+13		
+14		
+15		
+16		
+17		
+18		
+19		
+20		
+21		
+22		
+23		
+24		
+25		
+26		
+27		
+28		
+29		
+30		
+31		

Note. The offset is the bit units from the start of the output device table that assigned the output bit device.

6. APPLICATION FUNCTIONS

b) Word data area (RWw)

Offset(Note)	Signal name	Description
+0	Unusable	—
+1		
+2		
+3		
+4		
+5		
+6		
+7		
+8		
+9		
+10		
+11		
+12		
+13		
+14		
+15		
+16		
+17		
+18		
+19		
+20		
+21		

Note. The offset is the word units from the start of the output device table that assigned the output bit device.

6. APPLICATION FUNCTIONS

POINT	
	<ul style="list-style-type: none">• When a communication error (system error E401 to E407) occurs or SSCNET is disconnected, the status of the input device table is the same as RI control at communication error of control option 2 (parameter No.0201). Also, for a sensing module that supports the output CLEAR/HOLD function, the status of the external DO signals of the sensing module is the same as the operation selection when communication is disconnected for DO□ setting 1. Refer to the Sensing Module Instruction Manual for output CLEAR/HOLD function settings.• When RI control at communication error of control option 2 (parameter No.0201) is set to "1: Maintain status", and the sensing module power supply is cut while the sensing module and Q173SCCF are communicating, an incorrect value may be held in the input device table.• When using remote I/O modules, set the I/O table selection of I/O table (parameter No.004A) to "1: Use I/O device table". When "0: Use digital I/O table" is set and I/O devices are assigned, I/O table select error (system error E511), and system setting error (RIO control alarm 38, detail 05 to 06) occur.• Assign the I/O device not to overlap other settings. If the assignment is overlapped or exceeds the range of the I/O device table, the I/O No. assignment error (system error E510) and I/O No. assignment setting error (RIO control alarm 39, detail 01 and 02) occur.• Set the total points of the I/O devices assigned to remote I/O when setting I/O device points (parameter No.0210, 0212, 0214, and 0216).• The delay time for the input device table to be updated after the signals of a sensing module are input is sensing module input response time + (control cycle × 2). Refer to Sensing Module Instruction Module for input response time of sensing module.• The delay time for the host controller to update the output device table, and signals of a sensing module to be output is sensing module output response time + (control cycle × 3). Also, for output of output bit devices using the other axes start function, the delay time from when other axes start conditions are established is sensing module output response time + (control cycle × 2). Refer to Sensing Module Instruction Manual for output response time of sensing module.

API LIBRARY	
	<ul style="list-style-type: none">• Use the sscGetInputDeviceBit function to get input bit device.• Use the sscGetInputDeviceWord function to get input word device.• Use the sscSetOutputDeviceBit function to set output bit device.• Use the sscSetOutputDeviceWord function to set output word device.• Use the sscGetOutputDeviceBit function to get output bit device.• Use the sscGetOutputDeviceWord function to get output word device.

6. APPLICATION FUNCTIONS

6.34.5 Example of setting procedure

The following shows the settings for two sensing modules (stations 1 to 3 and station 4).

(1) Entire system configuration diagram

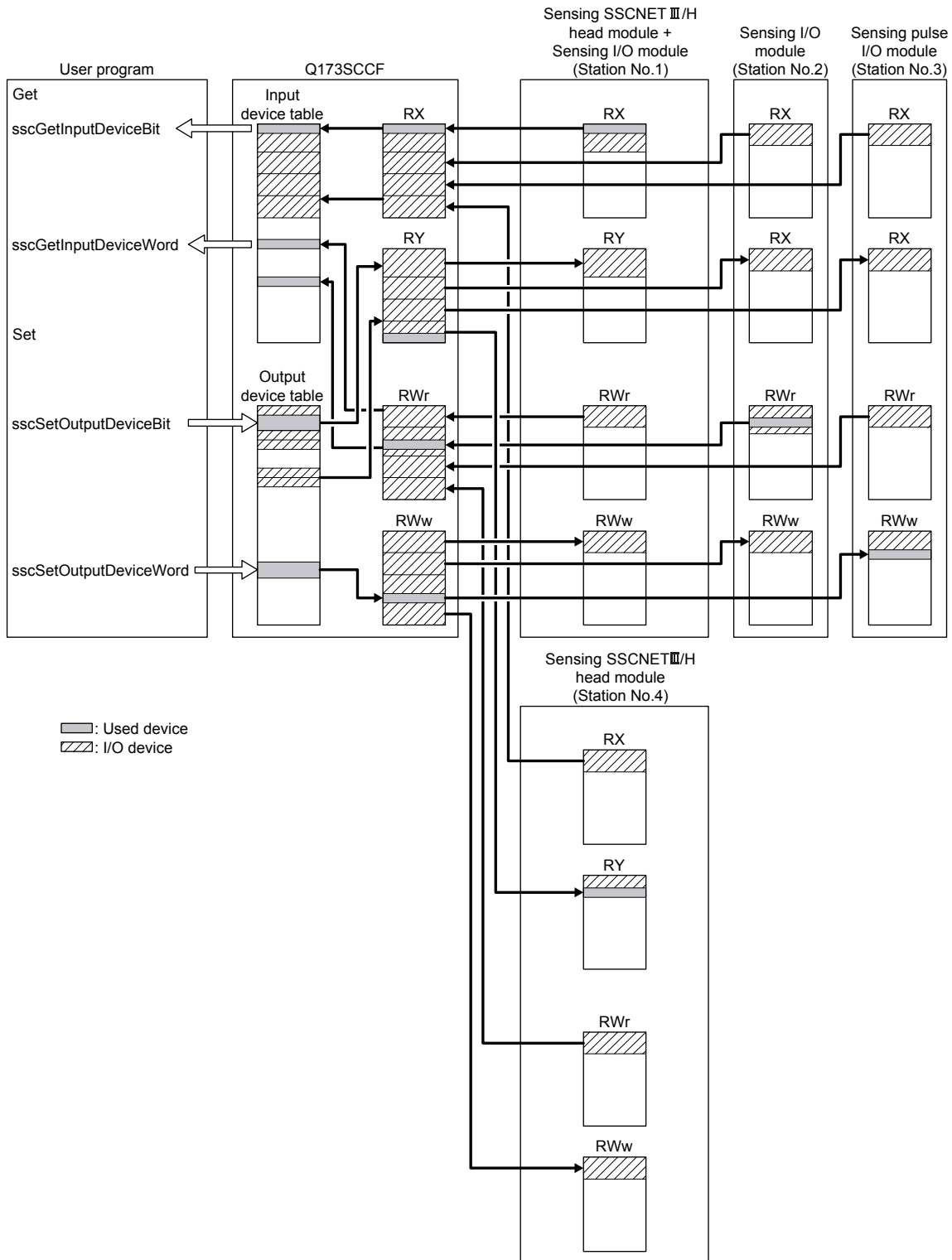

6. APPLICATION FUNCTIONS

(2) Q173SCCF setting

(a) Type code setting

Set the type code and vendor ID according to the system configuration.

Station No.	Module	Parameter No.	Abbreviation	Name	Setting value
1	Sensing SSCNETⅢ/H head module + sensing I/O module	021D	*VEND	Vendor ID	0000h
		021E	*CODE	Type code	3011h
2	Sensing I/O module	021D	*VEND	Vendor ID	0000h
		021E	*CODE	Type code	3021h
3	Sensing pulse I/O module	021D	*VEND	Vendor ID	0000h
		021E	*CODE	Type code	3023h
4	Sensing SSCNETⅢ/H head module	021D	*VEND	Vendor ID	0000h
		021E	*CODE	Type code	3010h

(b) Link device setting

To allocate sensing module link devices to the Q173SCCF I/O table, set the total number of points (in units of 16) of each link device, and the start I/O device number to be assigned

1) Station parameter

Module No.	Parameter No.	Abbreviation	Name	Setting value
1	0210	*BDIO	Input bit device points	0040h
	0211	*BDINA	Input bit device start number	0000h
	0212	*WDIO	Input word device points	001Ch
	0213	*WDINA	Input word device start number	0004h
	0214	*BDOO	Output bit device points	0040h
	0215	*BDONA	Output bit device start number	0000h
	0216	*WDOO	Output word device points	001Ch
	0217	*WDONA	Output word device start number	0004h
2	0210	*BDIO	Input bit device points	0040h
	0211	*BDINA	Input bit device start number	0400h
	0212	*WDIO	Input word device points	0016h
	0213	*WDINA	Input word device start number	0044h
	0214	*BDOO	Output bit device points	0040h
	0215	*BDONA	Output bit device start number	0400h
	0216	*WDOO	Output word device points	0016h
	0217	*WDONA	Output word device start number	0044h
3	0210	*BDIO	Input bit device points	0020h
	0211	*BDINA	Input bit device start number	0800h
	0212	*WDIO	Input word device points	0016h
	0213	*WDINA	Input word device start number	0084h
	0214	*BDOO	Output bit device points	0020h
	0215	*BDONA	Output bit device start number	0800h
	0216	*WDOO	Output word device points	0016h
	0217	*WDONA	Output word device start number	0084h
4	0210	*BDIO	Input bit device points	0020h
	0211	*BDINA	Input bit device start number	0C00h
	0212	*WDIO	Input word device points	0016h
	0213	*WDINA	Input word device start number	00C4h
	0214	*BDOO	Output bit device points	0020h
	0215	*BDONA	Output bit device start number	0C00h
	0216	*WDOO	Output word device points	0016h
	0217	*WDONA	Output word device start number	00C4h

6. APPLICATION FUNCTIONS

(3) Setting/getting I/O devices with API functions

Examples of getting input devices and setting/getting output devices are shown in the table below.

Note that the board ID is 0, and channel number is 1.

Station No.	Device name	Set/get	Setting value
1	RX	Get input bit device 000	int data; sscGetInputDeviceBit (0, 1, 0×0000, &data);
2	RWr	Get one word of input word device 3C	unsigned short data; sscGetInputDeviceWord (0, 1, 0×0024, 1, &data);
3	RY	Set output bit device 608 to ON	sscSetOutputDeviceBit (0, 1, 0×0608, SSC_ON);
3	RWw	Set output word device 52 to 000Ah (one word)	sscSetOutputDeviceWord (0, 1, 0×0052, 1, 0×000A);

6.34.6 Sensing module disconnect

The system can be startup with the sensing module disconnected, and simulate can be performed by making remote I/O disconnect valid in control option 1 (parameter No.0200) of the RIO module parameter.

However, the input bit devices allocated to sensing module are OFF, and input word devices are 0 and are not updated. Also, any changes made to the status of output bit devices and output word devices allocated to sensing module are not output to the sensing module. (The status of output bit devices and output word devices can only be checked.)

7. AUXILIARY FUNCTION

7. AUXILIARY FUNCTION

7.1 Reading/writing parameters

The parameter data in the Q173SCCF is accessed using the parameter read/write function. Types of parameters include: system parameters, control parameters, and servo parameters. The parameter read/write function can be used after system preparation completion (system status code: 0001h).

7.1.1 Writing parameters

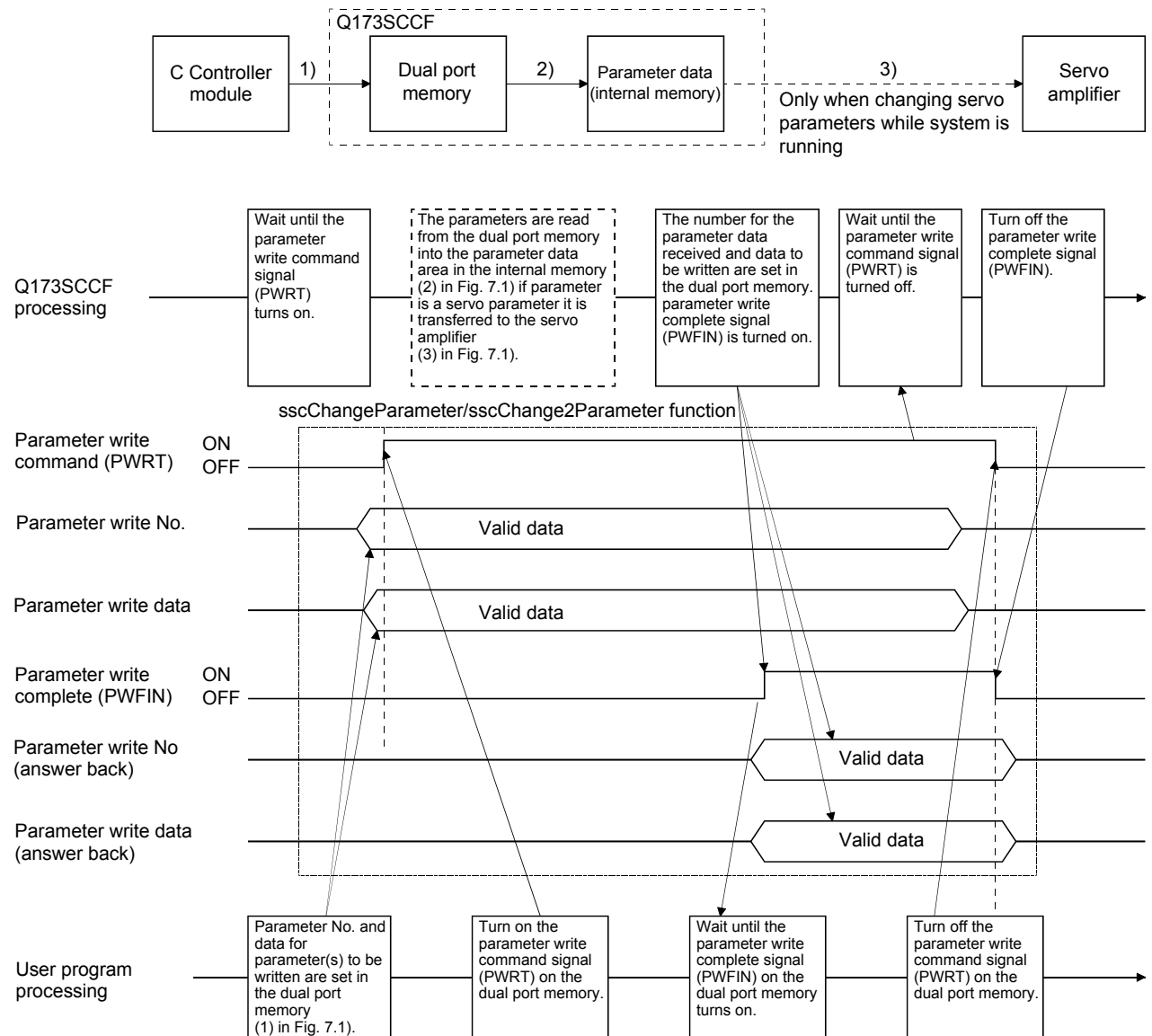

Fig. 7.1 Flow when data is written to parameters

7. AUXILIARY FUNCTION

POINT	
	<ul style="list-style-type: none"><li data-bbox="469 309 1382 416">▪ In some parameters, changing the settings after the system has started is invalid. Refer to Chapter 11; Parameters, concerning which parameters this applies to.<li data-bbox="469 427 1394 573">▪ 32 bit length parameters are separated into upper and lower items, therefore change them simultaneously. Changing of 32 bit length parameters separately can lead to erroneous operation.<li data-bbox="469 584 1390 651">▪ Two parameters can be written at a time. When writing one parameter, set 0 to the other parameter.<li data-bbox="469 663 1406 770">▪ If an erroneous parameter No. is set, a parameter number error (PWENn (n = 1 to 2)) is turned on. However, the parameter No.0 is not considered an erroneous parameter No.<li data-bbox="469 781 1362 848">▪ If a parameter setting is outside the setting range, a parameter data out of bounds (PWEDn (n = 1 to 2)) is set.<li data-bbox="469 860 1409 1196">▪ Parameter limit checks are not performed before system running (System status code: 000Ah). If the parameter set is incorrect, parameter error (system alarm 37, servo alarm 37, operation alarm 37, detail 01) occurs when the system is started. Check the error parameter number in servo parameter error number (monitor No.0510 to 0537), control parameter error number (monitor No.0330 to 033F) and system parameter error number (monitor No.0410 to 0417), and after rebooting software, set correct parameter and start the system again. Parameter error (system alarm 37, operation alarm 37, detail 01) cannot be reset by the alarm reset.<li data-bbox="469 1207 1382 1314">▪ In system parameter write, parameter write command (SPWRT), parameter write access complete (SPWFIN), parameter number error (SPWENn (n = 1 to 2)) and parameter data out of bounds (SPWEDn (n = 1 to 2)) are used.

7. AUXILIARY FUNCTION

7.1.2 Reading parameters

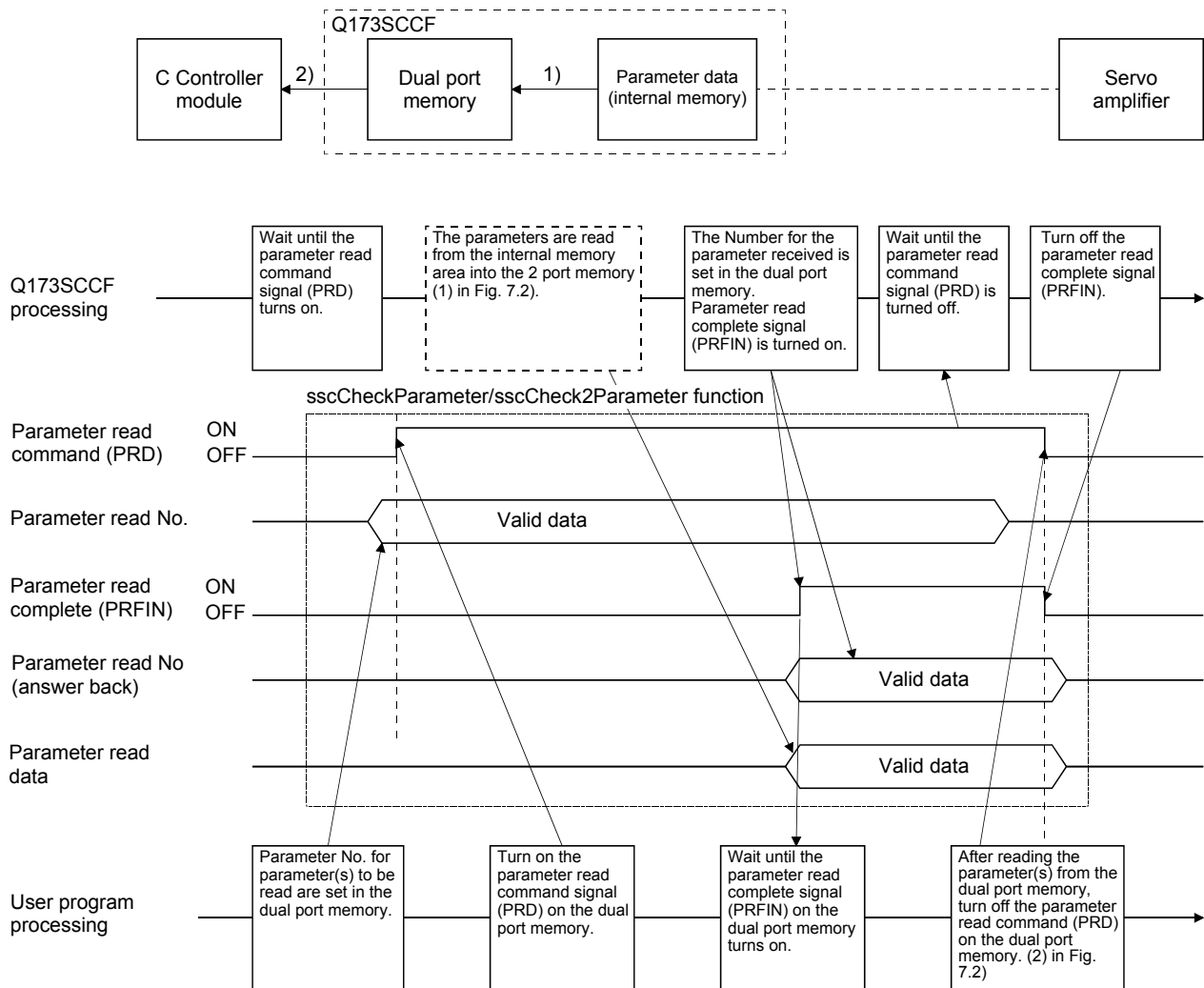

Fig. 7.2 Flow when data is read from parameters

POINT
<ul style="list-style-type: none"> Two parameters can be read at a time. When reading one parameter, set 0 to the other parameter. If an erroneous parameter number is set, a parameter number error (PR ENn (n = 1 to 2)) turned on. However, the parameter number. 0 is not considered an erroneous parameter number. In system parameter read, parameter read command (SPRD), parameter read access complete (SPRFIN) and parameter number error (SPRENn (n = 1 to 2)) are used.

7. AUXILIARY FUNCTION

7.2 Changing parameters at the servo

The Q173SCCF has a function of reflecting the results of changes made to parameters on the servo amplifier to the C Controller module. When parameters are changed on the servo amplifier, the Q173SCCF changes the parameter data area (internal memory), and notifies the C Controller module using the "changes to servo parameters exist" (PSCHG) signal. The changed servo parameter numbers are notified in units of 16 to the servo parameter change number table. To identify the changed parameter, check the servo parameter change number (monitor No.0590 to 05B7) corresponding to the notification. Monitor this signal periodically and record parameters for which changes have been made.

POINT
<ul style="list-style-type: none">▪ The reasons that parameters are re-written on the servo amplifier are as follows.<ul style="list-style-type: none">▪ When parameters are changed using MR Configurator2 (This includes execution of the machine analyzer and the gain search function).▪ The parameter was automatically changed such as by the real time auto tuning function.▪ Refer to the Servo Amplifier Instruction Manual on your servo amplifier concerning servo parameters that are automatically changed.

7. AUXILIARY FUNCTION

The sequence for when servo parameters are changed is as follows.

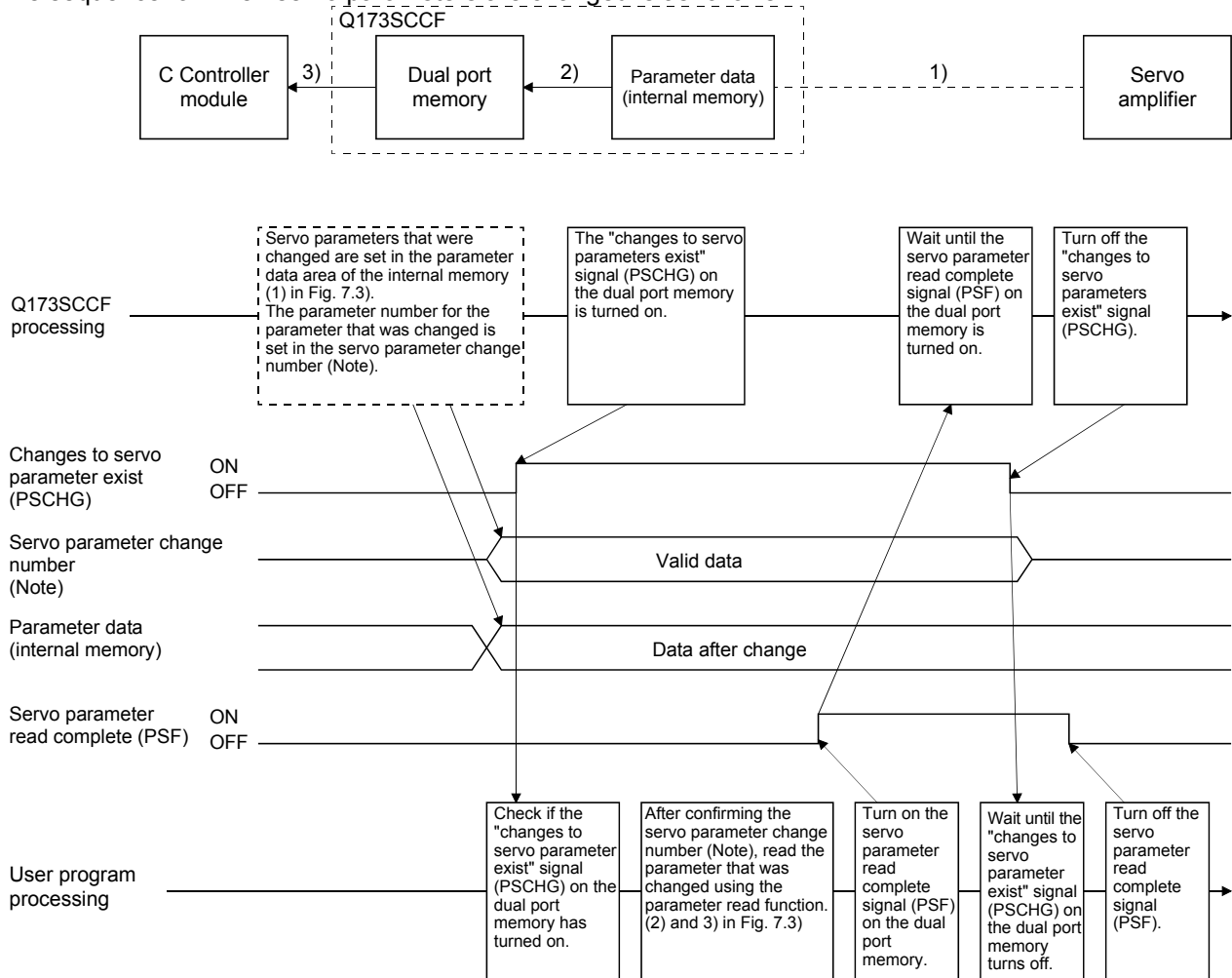

Note. Check the servo parameter change number (monitor No.0590 to 05B7) corresponding to the servo parameter change number 11□□ to 13□□ (PSN11 to PSN13).

Fig. 7.3 Data flow when servo parameter(s) are changed

7. AUXILIARY FUNCTION

7.3 Alarm and system error

When an incorrect setting or incorrect operation is done, the Q173SCCF raises an alarm, so make user program monitor the alarm periodically.

The Q173SCCF can raise the following six alarms: system alarm, servo alarm, operation alarm, RIO module alarm, RIO control alarm, and system error. For the cause of occurrence and treatment for each alarm, refer to Chapter 13.

API LIBRARY

- Use the `sscGetAlarm/sscResetAlarm` functions to get/reset the alarm number. Specify the following in the argument for the alarm type.
 - System alarm : `SSC_ALARM_SYSTEM`
 - Servo alarm : `SSC_ALARM_SERVO`
 - Operation alarm : `SSC_ALARM_OPERATION`
 - RIO module alarm : `SSC_ALARM_UNIT`
 - RIO control alarm : `SSC_ALARM_UNIT_CTRL`
- Use the `sscGetSystemStatusCode` function to get the system error.

(1) System alarm

System alarm is an alarm a Q173SCCF raises by incorrect setting of a system parameter or each function. When a system alarm occurs, during system alarm signal (CALM) turns on and the alarm number and the detail number are stored in System alarm number and Specific system alarm number.

To reset the system alarm, turn on the system alarm reset signal (CRST).

POINT

- Parameter error (system alarm 37) cannot be reset with the system alarm reset signal. Reexamine the parameter and start the system again.
- If another system alarm occurs while the system alarm is occurring, the first system alarm is notified to the system alarm number. By using log function, the history of the system alarm number can be checked.

(2) Servo alarm

Servo alarm is an alarm a servo amplifier raises by incorrect setting of a system parameter. When a servo alarm occurs, during servo alarm signal (SALM) or during servo warning (SWRN) turns on and the alarm number and the detail number are stored in Servo alarm number and Specific servo alarm number. To reset the servo alarm, turn on the servo alarm reset signal (SRST).

POINT

- For the reset of servo alarms, it depends on the specifications of the servo amplifier. For details, refer to the Servo Amplifier specification for your servo amplifier.
- When servo alarms have occurred by multiple causes, the servo alarm number notified to depends on the specifications of the servo amplifier.

7. AUXILIARY FUNCTION

(3) Operation alarm

Operation alarm is an alarm a Q173SCCF raises in each axis by incorrect setting of a system parameter or each function. When an operation alarm occurs, during operation alarm signal (OALM) turns on and the alarm number and the detail number are stored in Operation alarm number and Specific operation alarm number. To reset the operation alarm, turn on the operation alarm reset signal (ORST).

POINT
<ul style="list-style-type: none">▪ Parameter error (operation alarm 37) and system setting error (operation alarm 38) cannot be reset with the operation alarm reset signal. Check the cause of the alarm and treatment, and start the system again.▪ If another operation alarm occurs while the operation alarm is occurring, the first operation alarm is notified to the operation alarm number. By using log function, the history of the operation alarm number can be checked.

(4) RIO module alarm

RIO module alarms occur from remote I/O modules as a result of incorrect RIO module parameter settings, and remote I/O module hardware errors.

When a RIO module alarm occurs, the RIO module alarm (RUALM), or RIO module warning (RUWRN) signal turns ON, and the alarm number/detail number is stored to the RIO module alarm No./detail RIO module alarm No. To reset the RIO module alarm, turn ON the RIO module alarm reset (RURST) signal.

POINT
<ul style="list-style-type: none">▪ The resetting of the RIO module alarm depends on the specifications of the remote I/O module. Refer to the User's Manual of the remote I/O module being used for details.▪ When a RIO module alarm occurs due to several factors, the RIO module alarm No. that is notified depends on the specification of the remote I/O module.

7. AUXILIARY FUNCTION

(5) RIO control alarm

RIO control alarms occur at each station from the Q173SCCF as a result of incorrect control parameter settings, and incorrect settings for each function. When a RIO control alarm occurs, the RIO control alarm (RCALM) signal turns ON, and the alarm number/detail number is stored to the RIO control alarm No./detail RIO control alarm No. To reset the RIO control alarm, turn ON the RIO control alarm reset (RCRST) signal.

POINT
<ul style="list-style-type: none">▪ The following RIO control alarms cannot be reset. Check the error causes and corrective actions, and start the system again.<ul style="list-style-type: none">▪ Parameter error (RIO control alarm 37)▪ System setting error (RIO control alarm 38)▪ I/O No. assignment setting error (RIO control alarm 39)▪ When another RIO control alarm occurs at the same time a RIO control alarm has already occurred, the RIO control alarm No. of the RIO control alarm that occurred first is notified. The RIO control alarm No. history can be checked by using the log function.

(6) System error

System error occurs in the case when positioning control cannot be continued, such as when a hardware error of a Q173SCCF occurs, when SSCNET communication error occurs. Error code of the system error is stored in the system status code.

POINT
<ul style="list-style-type: none">▪ System error cannot be reset. Reboot the software as necessary and start the system again.▪ If another system error occurs while the system error is occurring, the error code of the system status code is overwritten. By using log function, the history of the system error occurred while system is running can be checked.

7. AUXILIARY FUNCTION

7.4 Monitor function

7.4.1 Summary

The monitor function is for referencing servo information such as current command position, speed Feedback etc. and operation information and system information.

When monitoring system information, the monitor area in the system command/status table is used. Also, when monitoring servo information and operational information, the monitor area of the command/status table for each axis is used.

2 items of system information and 4 items per axis of servo information can be monitored.

While the monitor command signal (MON) is on, the monitor data is continuously updated.

POINT
<ul style="list-style-type: none"> The update period is the control cycle to several ms and the updated period differs depending on the control status.

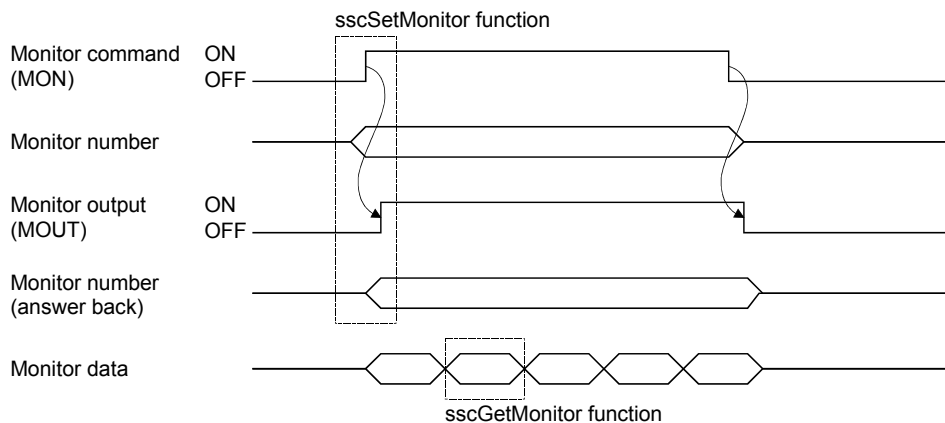

When changing the monitor number, turn off the monitor command signal (MON). Changing of the monitor number is performed on the raising edge of the monitor command signal (MON) (if monitor number is changed while the monitor command is on, it is ignored).

Monitor data is 16 bits per item. For referencing 32 bit data, designate 2 items, upper and lower or designate an operation information (double word) number. For designating operation information (double word) set the monitor number to monitor number 1 or monitor number 3. If the operation information (double word) number is set to monitor number 2 or monitor number 4 a monitor number error occurs.

Also, when designating operation information (double word) using monitor number 1 or monitor number 3, set monitor number 2 and monitor number 4 to 0. If a different monitor number is set for monitor number 2 or monitor number 4, a monitor number error occurs.

7. AUXILIARY FUNCTION

POINT	
	<ul style="list-style-type: none">▪ If an erroneous monitor number is commanded, a monitor number error (MERn (n = 1 to 4)) is turned on. Data for a correct monitor number can be monitored at this time (monitor output is turned on). However, if the monitor number is set to 0, a monitor number error is not set and monitor data is continually set to 0.▪ Servo information can not be referenced if the servo amplifier is not connected. If the servo amplifier is not connected, "servo amplifier is not connected" signal (MESV) is turned on.▪ When using the monitor function (when monitoring the system information), the monitor command (SMON), monitor output (SMOUT), monitor number error signal (SMERn (n = 1 to 2)) are used.

7. AUXILIARY FUNCTION

7.4.2 Monitor latch function

Monitor data is not updated while the monitor latch command signal (MONR) is on.

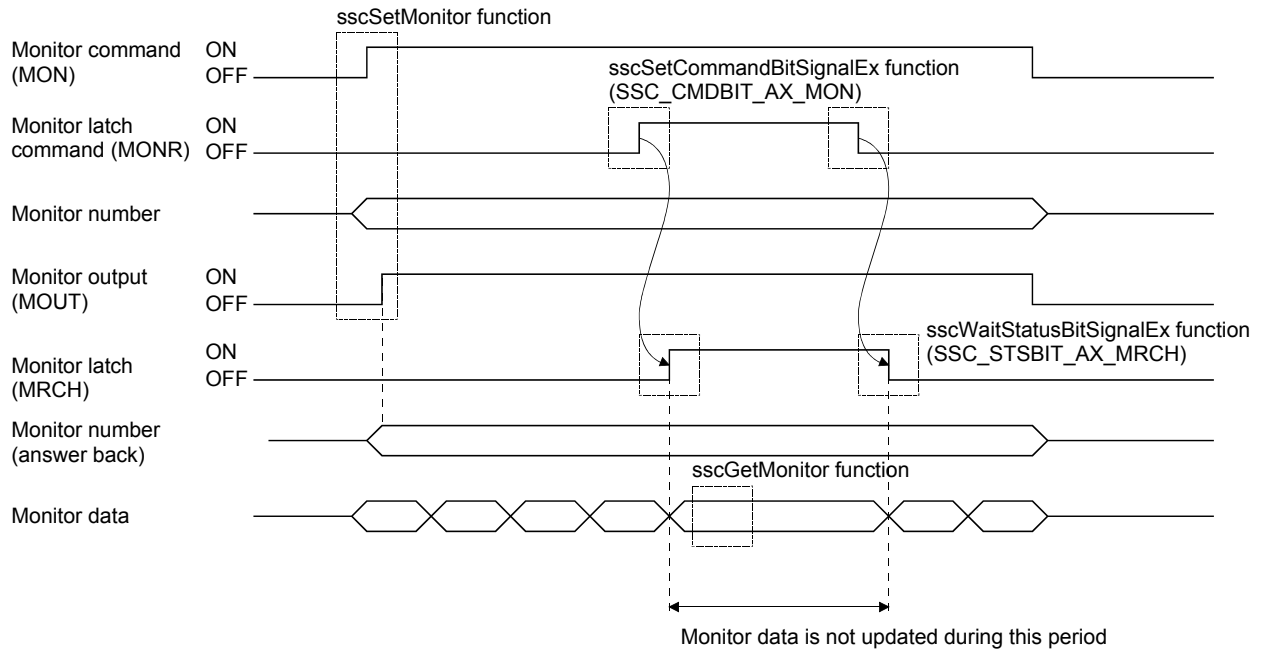

POINT

- When using the monitor function (when monitoring the system information), monitor latch command (SMONR) and monitor latch (SMRCH) are used.

API LIBRARY

- To turn ON/OFF the monitor latch command (MONR), set SSC_CMDBIT_AX_MON to the command bit number of the sscSetCommandBitSignalEx function.
When using the monitor function (when monitoring the system information), use SSC_CMDBIT_SYS_SMON.
- To check if monitor latch (MRCH or SMRCH) is ON/OFF, set SSC_STSBIT_AX_MRCH to the status bit number with the sscGetStatusBitSignalEx or sscWaitStatusBitSignalEx functions.
When using the monitor function (when monitoring the system information), use SSC_STSBIT_SYS_SMRCH.

7. AUXILIARY FUNCTION

7.5 High speed monitor function

7.5.1 Summary

High speed monitor function is a function for monitoring current command position and current feedback position etc. It becomes valid after system is started up, and monitor data is updated every control cycle.

The data that can be referenced with the high speed monitor function are the following 6 items.

Data item	Units	Data size	(Note 1) Address	Remarks
Current command position	Command units	4 byte	A000h + 20h × (n - 1)	Same as monitor No.300, 301
Current feedback position	Command units	4 byte	A004h + 20h × (n - 1)	Same as monitor No.302, 303
Moving speed	Speed units	4 byte	A008h + 20h × (n - 1)	Same as monitor No.304, 305
Feedback moving speed	Speed units	4 byte	A00Ch + 20h × (n - 1)	Same as monitor No.316, 317
Electrical current feedback	0.1%	2 byte	A010h + 20h × (n - 1)	Same as monitor No.20B
External signal status (Note 2)		2 byte	A012h + 20h × (n - 1)	Same as monitor No.320
Position droop (Note 3)	pulse	4 byte	A014h + 20h × (n - 1)	Same as monitor No.204, 205

Note 1. n is the axis No.

2. The sensor status specified at the sensor input option (parameter No.0219) is displayed for the external signal status.
3. The position droop monitor is supported by software version A4 or later and only in interface mode.

API LIBRARY

- Use the following functions to get high speed monitor data.
 - Current command position : sscGetCurrentCmdPositionFast
 - Current feedback position : sscGetCurrentFbPositionFast
 - Moving speed : sscGetCmdSpeedFast
 - Feedback moving speed : sscGetFbSpeedFast
 - Electrical current feedback : sscGetCurrentFbFast
 - External signal status : sscGetIoStatusFast

7. AUXILIARY FUNCTION

7.5.2 Monitor latch function

Monitor data is not updated while the high speed monitor latch command signal (RMONR) is on.

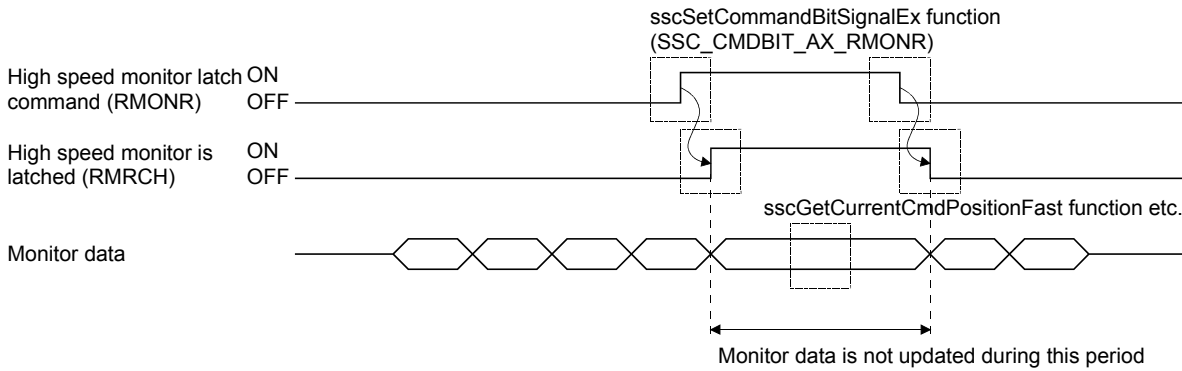

API LIBRARY

- To turn ON/OFF the high speed monitor latch command (RMONR), set `SSC_CMDBIT_AX_RMONR` to the command bit number of the `sscSetCommandBitSignalEx` function.
When using the monitor function (when monitoring the system information), use `SSC_CMDBIT_SYS_SMON`.
- To check if high speed monitor is latched (RMRCH) is ON/OFF, set `SSC_STSBIT_AX_RMRCH` to the status bit number with the `sscGetStatusBitSignalEx` or `sscWaitStatusBitSignalEx` function.

7. AUXILIARY FUNCTION

7.6 Interrupt

7.6.1 Interrupt sequence

If the interrupt output valid signal (ITS) is on and interrupt conditions are satisfied (Note1), the Q173SCCF sets the interrupt trigger on the dual port memory and generates an interrupt.

For cancellation of the interrupt, write 1 to an interrupt signal clear register (Note 2) using a C Controller module. After cancellation of the interrupt, turn on the interrupt processing complete signal (ITE). The Q173SCCF turns off the outputting with factor of interrupt signal (ITO) and clears the factor of interrupt to 0 after confirming the interrupt processing complete signal (ITE) is on. The next interrupt output will be put on hold until this operation is performed.

Note 1. The interrupt conditions can be set in system interrupt conditions (parameter No.0004), interrupt conditions 1 and 2 (parameter No.0204, 0205).

2. The interrupt signal clear register (offset of dual port memory is 20008h(CH1)) is changed to 0 automatically after the interrupt signal (IRQ□) is turned off.

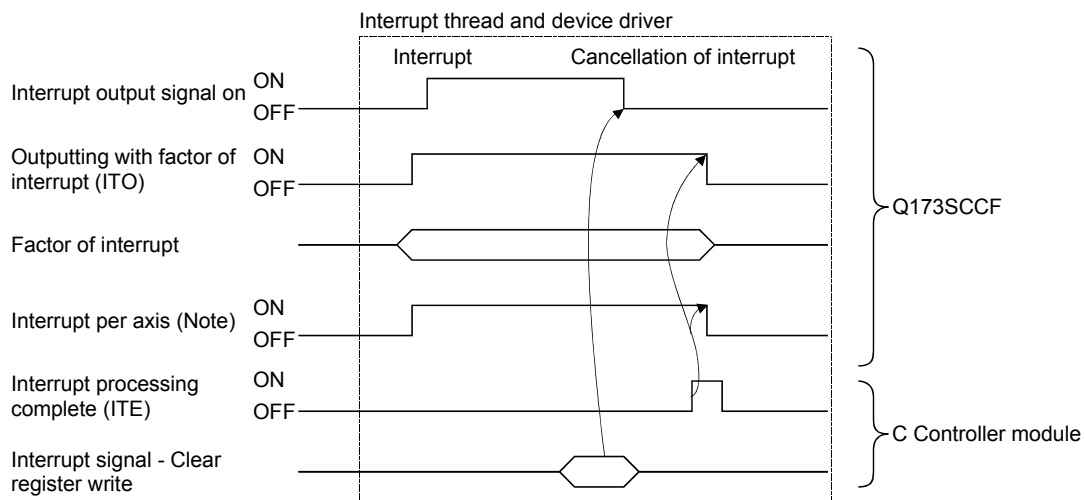

Note. Only the axis signal with an interrupt generated turns on.

POINT

- If multiple interrupt conditions are satisfied during one control cycle, all corresponding factors for interrupts are turned on.

API LIBRARY

- The factor of interrupt check and interrupt clear register are processed by the interrupt thread and device driver that is created when calling the sscIntStart function. Thus processing by user program is unnecessary.

7. AUXILIARY FUNCTION

If another interrupt condition is satisfied while the outputting with factor of interrupt (ITO is on), the factor of interrupt will be put on hold until the interrupt processing complete signal (ITE) turns off from on.

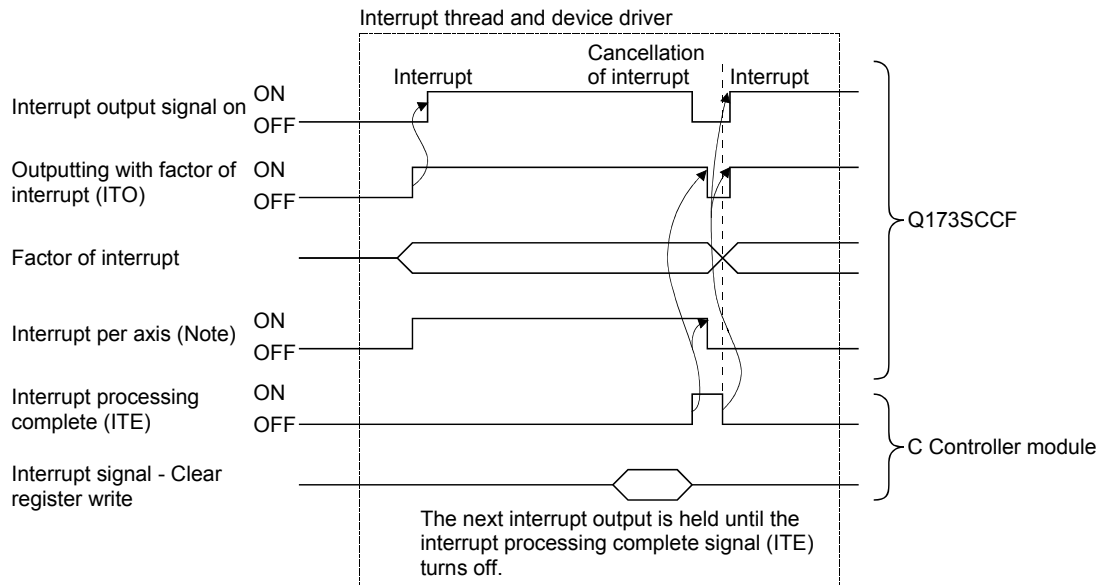

Note. The signal for the axis where the interrupt occurs is turned on.

POINT
<ul style="list-style-type: none"> After occurrence of an interrupt, if cancel of interrupt processing can not be performed by the C Controller module due to being backed up or some other reason, the interrupt output from the Q173SCCF can not be cancelled. In this case, turn off the power for the Q173SCCF.

7. AUXILIARY FUNCTION

7.6.2 Interrupt conditions

(1) Interrupt conditions (system parameters)

When interrupts the system are to be validated, set the values that designate ON for the bits that correspond to the conditions shown below to the parameter interrupt conditions (parameter No.0004).

API LIBRARY

- Use sscChangeParameter to set interrupt conditions.

Parameter No.0004 Interrupt conditions

Bit	Abbreviation	Name
0	SYSE	Current system error
1	CALM	Current system alarm
2	EMIO	During forced stop
3		Reserved
4		
5		
6		
7	OCME	Operation cycle alarm

Bit	Abbreviation	Name
8	OASF	Outputting with factor of other axes start interrupt
9	PPI	Outputting with factor of pass position interrupt
10		Reserved
11		
12		
13		
14		
15		

(2) Interrupt conditions (control parameters)

When interrupts each axis are to be validated, set the values that designate ON for the bits that correspond to the conditions shown below to the interrupt conditions 1 (parameter No.0204) and the interrupt conditions 2 (parameter No.0205) of the parameter.

Parameter No.0204 Interrupt conditions 1

Bit	Abbreviation	Signal name
0	RDY	Servo ready
1	INP	In-position
2	ZSP	Zero speed
3	ZPAS	Passed Z-phase
4	TLC	Torque limit effective
5	SALM	Servo alarm
6	SWRN	Servo warning
7	ABSE	Absolute position erased
8	OP	During operation
9	CPO	Rough match
10	PF	Positioning complete
11	ZP	Home position return complete
12	SMZ	During smoothing of stopping
13	OALM	Operation alarm
14	OPF	Completion of operation
15	PSW	Position switch

Parameter No.0205 Interrupt conditions 2

Bit	Abbreviation	Signal name
0	GAINO	During gain switching
1		Reserved
2		
3	SPC	During PID control
4		Reserved
5		
6	MAK2	Mark detection 2
7	PRSMO	During continuous operation to torque control
8	IWT	Interference check standby
9	SINP	Servo amplifier in-position
10		Reserved
11		
12		
13		
14		
15		

Interrupts occur on the leading edge of the signal corresponding to the interrupt condition.

Multiple interrupt conditions can be selected.

7. AUXILIARY FUNCTION

(3) Interrupt conditions (RIO control parameters)

When interrupts each station are to be validated, set the values that designate ON for the bits that correspond to the conditions shown below to the interrupt conditions (parameter No.0203) of the parameter.

Parameter No.0203 Interrupt conditions

Bit	Abbreviation	Signal name
0	/	Reserved
1		
2		
3		
4		
5	RUALM	RIO module alarm
6	RUWRN	RIO module warning
7	/	Reserved

Bit	Abbreviation	Signal name
8	/	Reserved
9		
10		
11		
12		
13	RCALM	RIO control alarm
14	/	Reserved
15		

Interrupts occur on the leading edge of the signal corresponding to the interrupt condition.

Multiple interrupt conditions can be selected.

7. AUXILIARY FUNCTION

7.6.3 Factor of interrupt

API LIBRARY

- The factor of interrupt check is processed by the interrupt thread that is created when calling the sscIntStart function. Thus processing by user program is unnecessary.
- Use the following functions for wait of factor of interrupt.
 - System and factor of axis interrupt: sscWaitIntEvent/sscWaitIntEventMulti
 - Factor of other axes start interrupt : sscWaitIntOasEvent
 - Factor of pass position interrupt : sscWaitIntPassPosition

(1) Information of outputting with factor of interrupt

When an interrupt occurs, the bit corresponding to the axis No., station No., or system which is the cause of the interrupt turns on.

Address	Content	Remarks
04C0	Outputting with factor of axis interrupt 1	Axis 1 (bit 0) to axis 20 (bit 19)
04C1		
04C2		
04C3		
04C4	Reserved	
04C5		
04C6		
04C7		
04C8	Outputting with factor of station interrupt	Station 1 (bit0) to station 4 (bit3)
04C9	Reserved	
04CA	Outputting with factor of system interrupt	System (bit 0)
04CB	Reserved	
04CC		
04CD		
04CE		
04CF		

7. AUXILIARY FUNCTION

(2) Factor of axis interrupt

(a) Factor of axis interrupt

Address	Content
04D0	Factor of interrupt Axis 1
04D1	
04D2	
04D3	
04D4	Factor of interrupt Axis 2
04D5	
04D6	
04D7	
04D8	Factor of interrupt Axis 3
04D9	
04DA	
04DB	
04DC	Factor of interrupt Axis 4
04DD	
04DE	
04DF	
04E0	Factor of interrupt Axis 5
04E1	
04E2	
04E3	
04E4	Factor of interrupt Axis 6
04E5	
04E6	
04E7	
04E8	Factor of interrupt Axis 7
04E9	
04EA	
04EB	
04EC	Factor of interrupt Axis 8
04ED	
04EE	
04EF	
04F0	Factor of interrupt Axis 9
04F1	
04F2	
04F3	
04F4	Factor of interrupt Axis 10
04F5	
04F6	
04F7	
04F8	Factor of interrupt Axis 11
04F9	
04FA	
04FB	

Address	Content
04FC	Factor of interrupt Axis 12
04FD	
04FE	
04FF	
0500	Factor of interrupt Axis 13
0501	
0502	
0503	
0504	Factor of interrupt Axis 14
0505	
0506	
0507	
0508	Factor of interrupt Axis 15
0509	
050A	
050B	
050C	Factor of interrupt Axis 16
050D	
050E	
050F	
0510	Factor of interrupt Axis 17
0511	
0512	
0513	
0514	Factor of interrupt Axis 18
0515	
0516	
0517	
0518	Factor of interrupt Axis 19
0519	
051A	
051B	
051C	Factor of interrupt Axis 20
051D	
051E	
051F	
0520	Reserved
:	
058F	

7. AUXILIARY FUNCTION

(b) Details on factor of interrupt on axis n

The addresses in the table are the addresses for the axis 1. For the axis 2 and above, increase in units of 04h for each axis.

Address	Bit	(Note) Abbreviation	Signal name
04D0 to 04D3	0	iRDY	Servo ready (interrupt)
	1	iINP	In-position (interrupt)
	2	iZSP	Zero speed (interrupt)
	3	iZPAS	Passed Z-phase (interrupt)
	4	iTLC	Torque limit effective (interrupt)
	5	iSALM	Servo alarm (interrupt)
	6	iSWRN	Servo warning (interrupt)
	7	iABSE	Absolute position erased (interrupt)
	8	iOP	During operation (interrupt)
	9	iCPO	Rough match (interrupt)
	10	iPF	Positioning complete (interrupt)
	11	iZP	Home position return complete (interrupt)
	12	iSMZ	During smoothing of stopping (interrupt)
	13	iOALM	Operation alarm (interrupt)
	14	iOPF	Completion of operation (interrupt)
	15	iPSW	Position switch (interrupt)
	16	iGAINO	During gain switching (interrupt)
	17	iFCLSO	Fully closed loop control changing (interrupt)
	18	iTLSO	Selecting torque limit (interrupt)
	19	iSPC	During PID control (interrupt)
	20		Reserved
	21	iMAK1	Mark detection 1 (interrupt)
	22	iMAK2	Mark detection 2 (interrupt)
	23	iPRSMO	During continuous operation to torque control (interrupt)
	24	iIWT	Interference check standby (interrupt)
	25	iSINP	Servo amplifier in-position (interrupt)
	26		Reserved
	27		
	28		
	29		
	30		
31			

Note. OFF: No factor of interrupt exists.

ON: A factor of interrupt exists.

7. AUXILIARY FUNCTION

(3) System interrupt factors

(a) System interrupt factors

Address	Content
0590	System interrupt factors
0591	
0592	Reserved
0593	
0594	Factor of other axes start interrupt
0595	
0596	
0597	
0598	Factor of pass position interrupt
0599	
059A	
059B	
059C	
059D	
059E	
059F	Reserved
05A0	
:	
05AF	

(b) Details on system interrupt factors

Address	Bit	(Note) Abbreviation	Signal name
0590 to 0591	0	iSYSE	System error (interrupt)
	1	iCALM	System alarm (interrupt)
	2	iEMIO	During forced stop (interrupt)
	3	/	Reserved
	4		
	5		
	6		
	7	iOCME	Operation cycle alarm (interrupt)
	8	iOASF	Outputting with factor of other axes start interrupt (interrupt)
	9	iPPI	Outputting with factor of pass position interrupt (interrupt)
	10	/	Reserved
	11		
	12		
	13		
	14		
	15		

Note. OFF: No factor of interrupt exists.

ON: A factor of interrupt exists.

7. AUXILIARY FUNCTION

(c) Factor of other axes start interrupt

When the outputting with factor of other axes start interrupt (iOASF) is on, the bit corresponding to other axes start data No. (1 to 32) turns on.

Address	Bit	Abbreviation	Signal name
0594 to 0597	0	iOAS1	Other axes start data 1 (interrupt)
	1	iOAS2	Other axes start data 2 (interrupt)
	2	iOAS3	Other axes start data 3 (interrupt)
	3	iOAS4	Other axes start data 4 (interrupt)
	4	iOAS5	Other axes start data 5 (interrupt)
	5	iOAS6	Other axes start data 6 (interrupt)
	6	iOAS7	Other axes start data 7 (interrupt)
	7	iOAS8	Other axes start data 8 (interrupt)
	8	iOAS9	Other axes start data 9 (interrupt)
	9	iOAS10	Other axes start data 10 (interrupt)
	10	iOAS11	Other axes start data 11 (interrupt)
	11	iOAS12	Other axes start data 12 (interrupt)
	12	iOAS13	Other axes start data 13 (interrupt)
	13	iOAS14	Other axes start data 14 (interrupt)
	14	iOAS15	Other axes start data 15 (interrupt)
	15	iOAS16	Other axes start data 16 (interrupt)
	16	iOAS17	Other axes start data 17 (interrupt)
	17	iOAS18	Other axes start data 18 (interrupt)
	18	iOAS19	Other axes start data 19 (interrupt)
	19	iOAS20	Other axes start data 20 (interrupt)
	20	iOAS21	Other axes start data 21 (interrupt)
	21	iOAS22	Other axes start data 22 (interrupt)
	22	iOAS23	Other axes start data 23 (interrupt)
	23	iOAS24	Other axes start data 24 (interrupt)
	24	iOAS25	Other axes start data 25 (interrupt)
	25	iOAS26	Other axes start data 26 (interrupt)
	26	iOAS27	Other axes start data 27 (interrupt)
	27	iOAS28	Other axes start data 28 (interrupt)
	28	iOAS29	Other axes start data 29 (interrupt)
	29	iOAS30	Other axes start data 30 (interrupt)
	30	iOAS31	Other axes start data 31 (interrupt)
	31	iOAS32	Other axes start data 32 (interrupt)

7. AUXILIARY FUNCTION

(d) Details on factor of other axes start interrupt

When the factor of other axes start interrupt (iOAS□) is on, the interrupt factor of other axes start status bit corresponding to other axes start data No. (1 to 32) turns on.

Details on factor of other axes start interrupt

Address	Content
0FE0	Details on factor of other axes start interrupt 1
0FE1	Details on factor of other axes start interrupt 2
0FE2	Details on factor of other axes start interrupt 3
0FE3	Details on factor of other axes start interrupt 4
0FE4	Details on factor of other axes start interrupt 5
0FE5	Details on factor of other axes start interrupt 6
0FE6	Details on factor of other axes start interrupt 7
0FE7	Details on factor of other axes start interrupt 8
0FE8	Details on factor of other axes start interrupt 9
0FE9	Details on factor of other axes start interrupt 10
0FEA	Details on factor of other axes start interrupt 11
0FEB	Details on factor of other axes start interrupt 12
0FEC	Details on factor of other axes start interrupt 13
0FED	Details on factor of other axes start interrupt 14
0FEE	Details on factor of other axes start interrupt 15
0FEF	Details on factor of other axes start interrupt 16

Address	Content
0FF0	Details on factor of other axes start interrupt 17
0FF1	Details on factor of other axes start interrupt 18
0FF2	Details on factor of other axes start interrupt 19
0FF3	Details on factor of other axes start interrupt 20
0FF4	Details on factor of other axes start interrupt 21
0FF5	Details on factor of other axes start interrupt 22
0FF6	Details on factor of other axes start interrupt 23
0FF7	Details on factor of other axes start interrupt 24
0FF8	Details on factor of other axes start interrupt 25
0FF9	Details on factor of other axes start interrupt 26
0FFA	Details on factor of other axes start interrupt 27
0FFB	Details on factor of other axes start interrupt 28
0FFC	Details on factor of other axes start interrupt 29
0FFD	Details on factor of other axes start interrupt 30
0FFE	Details on factor of other axes start interrupt 31
0FFF	Details on factor of other axes start interrupt 32

Details on factor of other axes start interrupt□

Address	Bit	Abbreviation	Signal name
0FE0	0	iOSOP□	Other axes start notice□ (interrupt)
	1	iOSFIN□	Other axes start complete□ (interrupt)
	2	iOSERR□	Other axes start incomplete□ (interrupt)
	3	\	Reserved
	4		
	5		
	6		
7			

Note 1. The addresses in the table above are the addresses for the other axes start status table 1. For the other axes status table 2 and above, increase in units of 1h for each axis.

2. □ : Other axes start No.

7. AUXILIARY FUNCTION

(e) Factor of pass position interrupt

When the outputting with factor of pass position interrupt (iPPI) is on, the bit corresponding to the pass position condition number of the factor of the pass position interrupt turns on.

Address	Bit	Abbreviation	Signal name
0598 to 059B	0	iPPI1	Pass position condition 1 (interrupt)
	1	iPPI2	Pass position condition 2 (interrupt)
	2	iPPI3	Pass position condition 3 (interrupt)
	3	iPPI4	Pass position condition 4 (interrupt)
	4	iPPI5	Pass position condition 5 (interrupt)
	5	iPPI6	Pass position condition 6 (interrupt)
	6	iPPI7	Pass position condition 7 (interrupt)
	7	iPPI8	Pass position condition 8 (interrupt)
	8	iPPI9	Pass position condition 9 (interrupt)
	9	iPPI10	Pass position condition 10 (interrupt)
	10	iPPI11	Pass position condition 11 (interrupt)
	11	iPPI12	Pass position condition 12 (interrupt)
	12	iPPI13	Pass position condition 13 (interrupt)
	13	iPPI14	Pass position condition 14 (interrupt)
	14	iPPI15	Pass position condition 15 (interrupt)
	15	iPPI16	Pass position condition 16 (interrupt)
	16	iPPI17	Pass position condition 17 (interrupt)
	17	iPPI18	Pass position condition 18 (interrupt)
	18	iPPI19	Pass position condition 19 (interrupt)
	19	iPPI20	Pass position condition 20 (interrupt)
	20	iPPI21	Pass position condition 21 (interrupt)
	21	iPPI22	Pass position condition 22 (interrupt)
	22	iPPI23	Pass position condition 23 (interrupt)
	23	iPPI24	Pass position condition 24 (interrupt)
	24	iPPI25	Pass position condition 25 (interrupt)
	25	iPPI26	Pass position condition 26 (interrupt)
	26	iPPI27	Pass position condition 27 (interrupt)
	27	iPPI28	Pass position condition 28 (interrupt)
	28	iPPI29	Pass position condition 29 (interrupt)
	29	iPPI30	Pass position condition 30 (interrupt)
	30	iPPI31	Pass position condition 31 (interrupt)
	31	iPPI32	Pass position condition 32 (interrupt)

Address	Bit	Abbreviation	Signal name
059C to 059F	0	iPPI33	Pass position condition 33 (interrupt)
	1	iPPI34	Pass position condition 34 (interrupt)
	2	iPPI35	Pass position condition 35 (interrupt)
	3	iPPI36	Pass position condition 36 (interrupt)
	4	iPPI37	Pass position condition 37 (interrupt)
	5	iPPI38	Pass position condition 38 (interrupt)
	6	iPPI39	Pass position condition 39 (interrupt)
	7	iPPI40	Pass position condition 40 (interrupt)
	8	iPPI41	Pass position condition 41 (interrupt)
	9	iPPI42	Pass position condition 42 (interrupt)
	10	iPPI43	Pass position condition 43 (interrupt)
	11	iPPI44	Pass position condition 44 (interrupt)
	12	iPPI45	Pass position condition 45 (interrupt)
	13	iPPI46	Pass position condition 46 (interrupt)
	14	iPPI47	Pass position condition 47 (interrupt)
	15	iPPI48	Pass position condition 48 (interrupt)
	16	iPPI49	Pass position condition 49 (interrupt)
	17	iPPI50	Pass position condition 50 (interrupt)
	18	iPPI51	Pass position condition 51 (interrupt)
	19	iPPI52	Pass position condition 52 (interrupt)
	20	iPPI53	Pass position condition 53 (interrupt)
	21	iPPI54	Pass position condition 54 (interrupt)
	22	iPPI55	Pass position condition 55 (interrupt)
	23	iPPI56	Pass position condition 56 (interrupt)
	24	iPPI57	Pass position condition 57 (interrupt)
	25	iPPI58	Pass position condition 58 (interrupt)
	26	iPPI59	Pass position condition 59 (interrupt)
	27	iPPI60	Pass position condition 60 (interrupt)
	28	iPPI61	Pass position condition 61 (interrupt)
	29	iPPI62	Pass position condition 62 (interrupt)
	30	iPPI63	Pass position condition 63 (interrupt)
	31	iPPI64	Pass position condition 64 (interrupt)

7. AUXILIARY FUNCTION

(f) Details on factor of pass position interrupt

When the outputting with factor of pass position interrupt (iPPI□) is on, the pass position status bit corresponding to the pass position condition number (1 to 64) turns on.

Address	Content	
0FA0	Details on factor of pass position interrupt (64 bytes)	Details on factor of pass position interrupt 1
0FA1		Details on factor of pass position interrupt 2
0FA2		Details on factor of pass position interrupt 3
0FA3		Details on factor of pass position interrupt 4
:		:
0FDF		Details on factor of pass position interrupt 64

Details on factor of pass position interrupt□

Address	Bit	Abbreviation	Signal name
0FA0	0	iPPIF□	Pass position interrupt complete□ (interrupt)
	1	iPPIE□	Pass position interrupt incomplete□ (interrupt)
	2	/	Reserved
	3		
	4		
	5		
	6		
	7		

Note 1. The address above is for the pass position condition number 1.

For the pass position condition number 2 and above, increase in units of 01h for each number.

2. □ indicates the pass position condition number (1 to 64).

7. AUXILIARY FUNCTION

(4) Station interrupt factors

(a) Station interrupt factors

Address	Content
05B0	Station interrupt factor station 1
05B1	
05B2	Station interrupt factor station 2
05B3	
05B4	Station interrupt factor station 3
05B5	
05B6	Station interrupt factor station 4
05B7	
05B8	Reserved
05B9	
05BA	
05BB	
05BC	
05BD	
05BE	
05BF	

(b) Details on station n interrupt factors

The addresses in the table are the addresses for the axis 1. For the axis 2 and above, increase in units of 02h for each axis.

Address	Bit	(Note) Abbreviation	Signal name		
05B0 to 05B1	0	/	Reserved		
	1				
	2				
	3				
	4				
	5	iRUALM	RIO module alarm (interrupt)		
	6	iRUWRN	RIO module warning (interrupt)		
	7	/	Reserved		
	8				
	9				
	10				
	11				
	12	/	Reserved		
	13			iRCALM	RIO control alarm
	14			/	Reserved
15					

Note. OFF: No factor of interrupt exists.

ON: A factor of interrupt exists.

7. AUXILIARY FUNCTION

7.6.4 Interrupt processing example

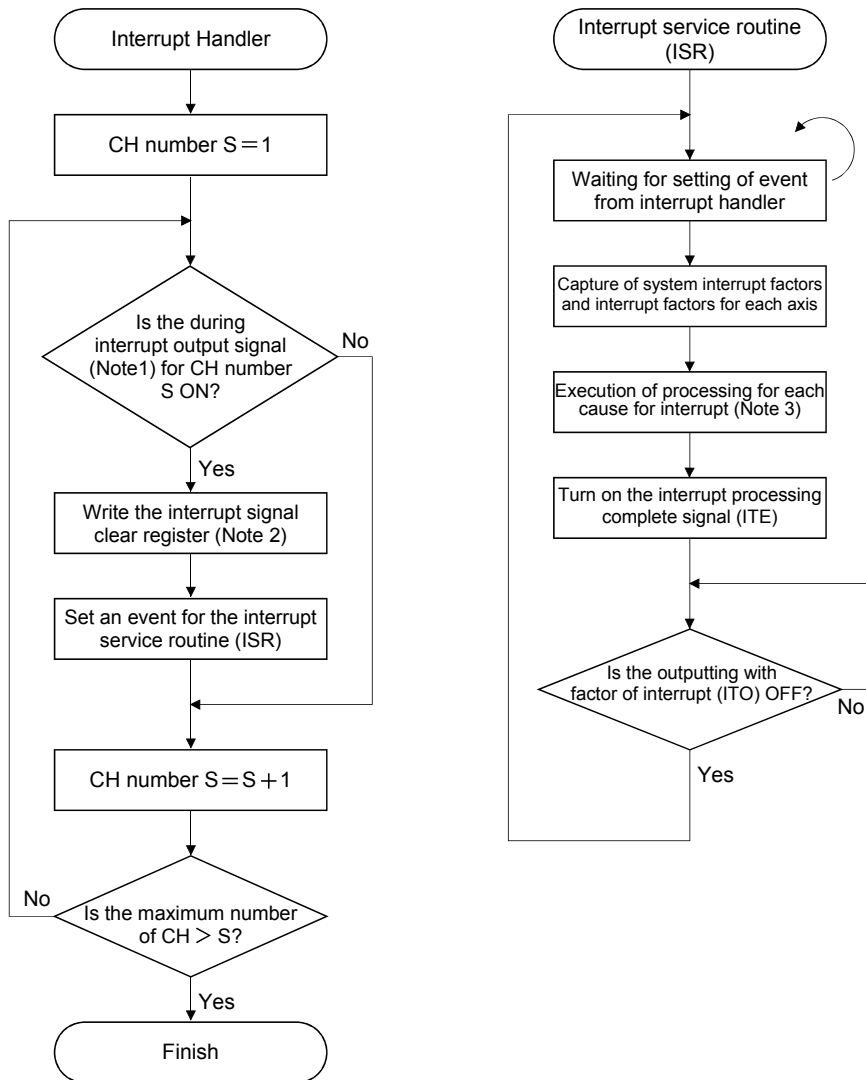

Note 1. Confirm the bit(s) for the during interrupt output signal (address 20004h on the dual port memory).

(If the bit(s) are on: a current interrupt is being output, while if the bit(s) are OFF: there is not a current interrupt)

2. When 1 is written in the interrupt signal clear register (address 20008h (CH1) on the dual port memory), the output of the interrupt is cancelled.

3. Implement processing necessary for the different causes of interrupts, such as for completion of operation and generation of an operation alarm.

(example) When an operation alarm occurs, send a stop request to other axes that are in operation.

API LIBRARY

- This interrupt processing example is processed by the device driver thus processing by user program is unnecessary.

7. AUXILIARY FUNCTION

7.7 User watchdog function

User watchdog function is a function that checks for errors of the user program. Reset the value of watchdog check counter on the dual port memory using a C Controller module on a periodic basis. If the watchdog check counter value is not reset at the designated time (watchdog timer counts down to zero), it is determined that the C Controller module error and a forced stop status is entered.

The Q173SCCF decrements the watchdog timer on each control cycle until the watchdog check counter value is reset. When the watchdog check counter value is reset, it is reset to the value set for the watchdog timer start counter.

POINT

- When the watchdog timer start counter is set to 0, user watchdog is not executed.

API LIBRARY

- Use the `sscWdEnable/sscWdDisable` functions to enable/disable user watchdog function.
- Use the `sscChangeWdCounter` function to update the watchdog check counter.
- For a detailed procedure for watchdog, refer to the sample program (WatchDog) contained on the utility software.

(1) Normal conditions

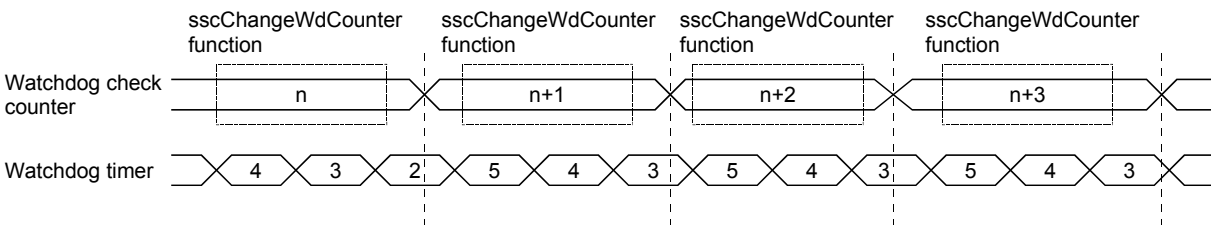

(2) When C Controller module overruns

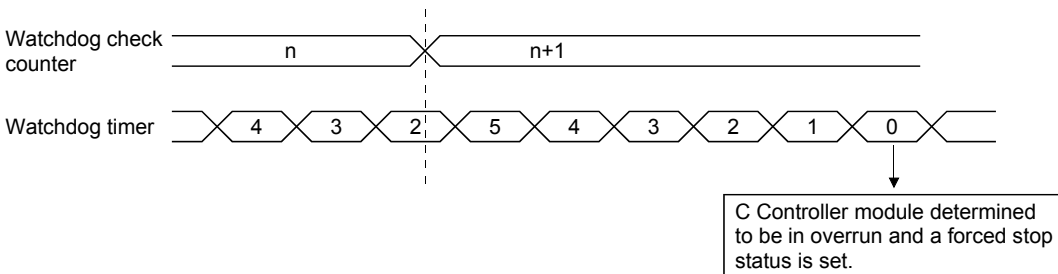

7. AUXILIARY FUNCTION

7.8 Software reboot function

Through using the software reboot function, the C Controller module can restart the Q173SCCF using software. Perform the software reboot according to the following procedure. (Refer to the system data table for the command/status signal.)

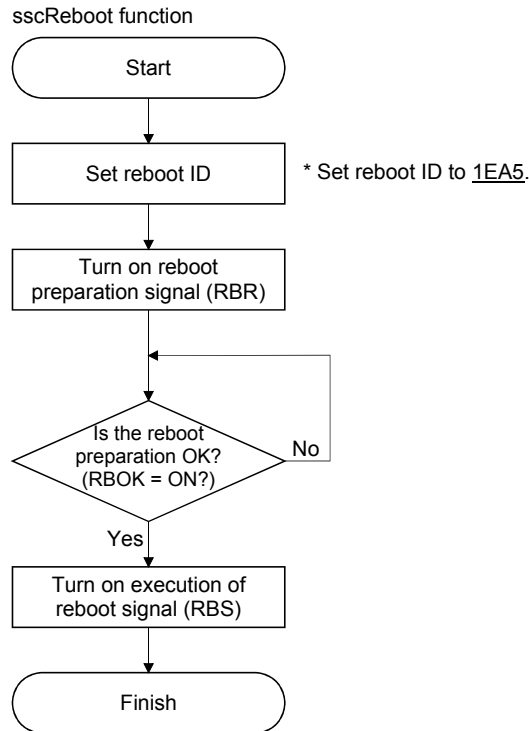

POINT

- When reboot preparation is turned on, it becomes a forced stop status.
- If an erroneous reboot ID is set and reboot preparation turned on or execution of reboot turned on without performing reboot preparation, a reboot preparation error occurs. If a reboot preparation error occurs, turn off reboot preparation and execution of reboot and restart the process from the beginning.

API LIBRARY

- Use the sscReboot function to perform software reboot.

7. AUXILIARY FUNCTION

7.9 Parameter backup

POINT

- When there are a lot of changing parameters of the Q173SCCF and servo amplifier and the parameter changing time effects the system startup, saving parameters in the flash ROM of the Q173SCCF by this function can shorten the time of system startup.

(1) Flash ROM parameter backup

The contents of the parameter data area in the Q173SCCF can be backed up to the flash ROM. When executing flash ROM parameter read (system command code: 0004h) at system preparation completion (system status code: 0001h), backup the parameter in the flash ROM with this function. Execute parameter backup in the flash ROM in the following procedure.

Note. At factory shipment, the initial value is set to each parameter.

sscSaveAllParameterToFlashROM function

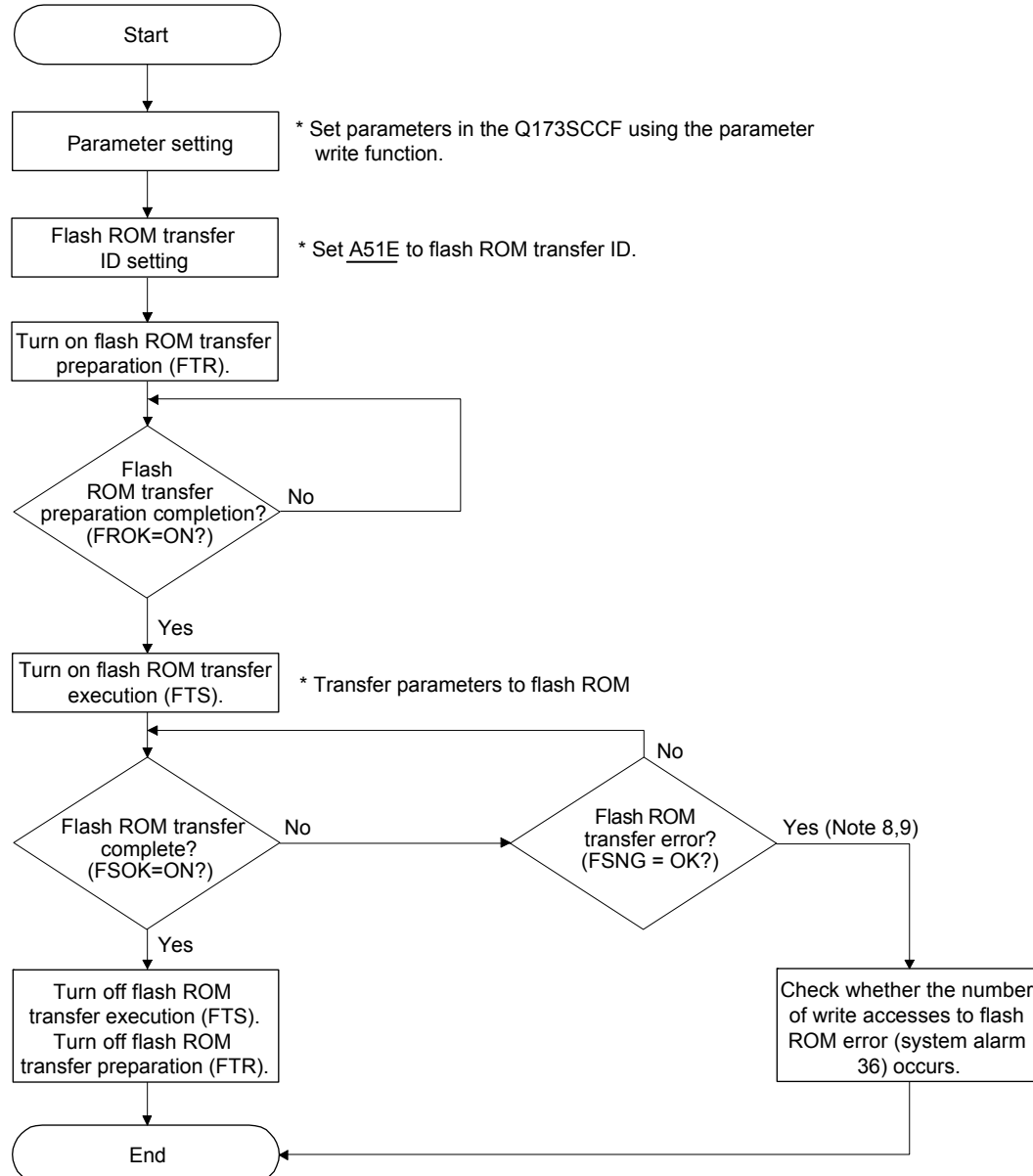

7. AUXILIARY FUNCTION

- Note 1. The flash ROM parameter backup function becomes available after the system preparation completion (system status code: 0001h).
2. When the flash ROM transfer preparation error (FRNG) or the flash ROM transfer error (FSNG) occurs, check the procedure and restart the process from the beginning.
 3. Do not turn off the power supply of the Q173SCCF during the parameter backup in the flash ROM. If flash ROM parameter read is executed before normal backup completion, flash ROM parameter read error (system status code: 0005h) occurs. In this case, execute parameter initialization (system command code: 0003h), set parameters as required and backup data to flash ROM again.
 4. When flash ROM parameter read is executed, the value of gain of the servo amplifier is the backed up value in the flash ROM, so vibration or abnormal sound may occur even when auto tuning is valid. Execute flash ROM backup after adjusting the gain of the servo amplifier.
 5. Execute flash ROM backup after home position return is performed when the absolute position detection system is used.
 6. Execute Note 5 above when changing a servo motor.
 7. Execute flash ROM backup after changing a Q173SCCF.
 8. The flash ROM can be rewritten up to 100,000 times. If it exceeds 100,000 times, number of write accesses to flash ROM error (system alarm 36, detail 01) occurs and parameter backup will not be performed.
 9. The flash ROM can be rewritten up to 25 times after every system preparation completion. If it exceeds 25 times, number of write accesses to flash ROM error (system alarm 36, detail 03) occurs and parameter backup will not be performed. Rewriting times to the flash ROM is cleared to 0 by resetting the system alarm or the software reboot. The parameter backup times executed after system preparation completion can be checked in the parameter backup times (system monitor No.040A).
 10. Perform the parameter backup while the operation of all axes is stopped.
 11. Writing and reading parameters are impossible during the flash ROM transfer.

7. AUXILIARY FUNCTION

(2) Flash ROM parameter initialization

The contents of the parameters which is backed up in the flash ROM is changed to the initial value.

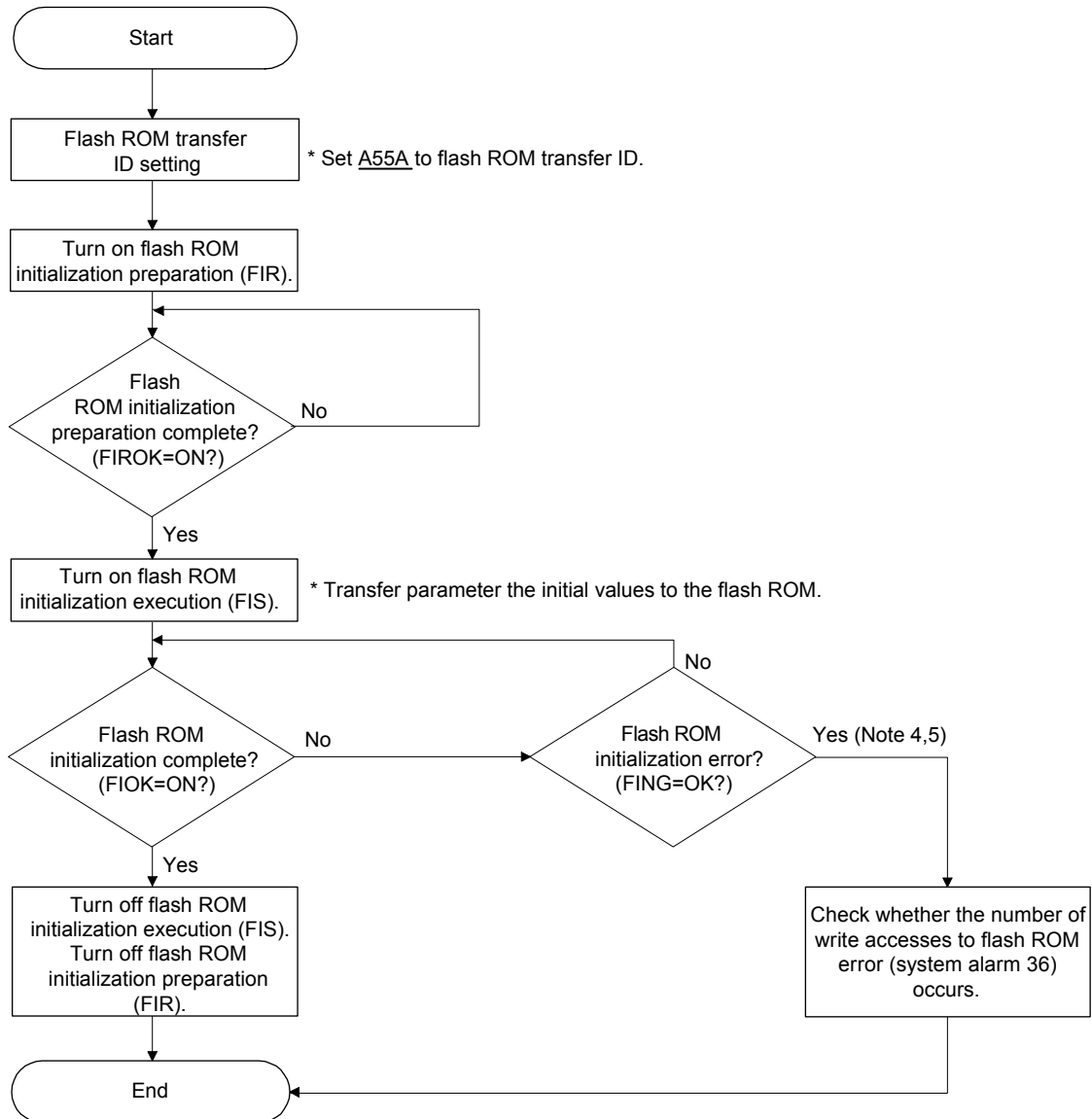

Note 1. The flash ROM initialization function becomes available after the parameter initialization completion (system status code: 0003h) or the flash ROM parameter read (system status code: 0004h) is executed.

2. When the flash ROM initialization preparation error (FIRNG) or the flash ROM initialization error (FING) occurs, check the procedure and restart the process from the beginning.

3. Do not turn off the power supply of the Q173SCCF while transferring parameter initial values to the flash ROM. If flash ROM parameter read is executed before normal initialization completion, flash ROM parameter read error (system status code: 0005h) occurs.

4. The flash ROM can be rewritten up to 100,000 times. If it exceeds 100,000 times, number of write accesses to flash ROM error (system alarm 36, detail 01) occurs and parameter initialization will not be performed. The parameter backup times executed (including flash ROM parameter initialization times) can be checked in the parameter backup times (system monitor No.040C, 040D).

5. The flash ROM can be rewritten up to 25 times after every system preparation completion. If it exceeds 25 times, number of write accesses to flash ROM error (system alarm 36, detail 03) occurs and parameter backup will not be performed. Rewriting times to the flash ROM is cleared to 0 by resetting the system alarm or the software reboot. The parameter backup times executed after system preparation completion can be checked in the parameter backup times (system monitor No.040A).

6. Perform the flash ROM parameter initialization while the operation of all axes is stopped.

7. Writing and reading parameters are impossible during the flash ROM initialization.

7. AUXILIARY FUNCTION

API LIBRARY

- For flash ROM parameter initialization, save the flash ROM parameters with the sscSaveAllParameterToFlashROM function after initializing the parameters with the sscResetAllParameter function.

(3) Flash ROM parameter reading

The parameters backed up in the flash ROM is read when the system preparation is completed (system status code: 0001h).

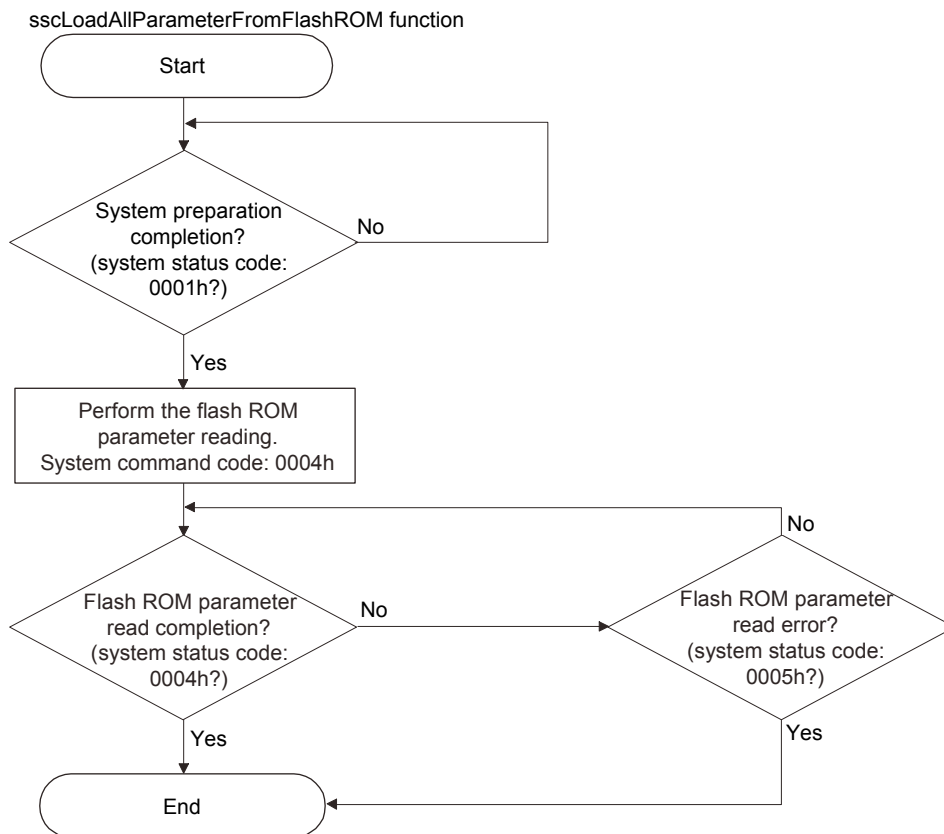

7. AUXILIARY FUNCTION

7.10 Test mode

Servo amplifier can be adjusted using test operation function (JOG, test positioning, machine analyzer etc.) of the MR Configurator2 attached to the Q173SCCF using a USB connection. This sets the Q173SCCF to test mode signal (TSTO) and operation (such as automatic operation) from the Q173SCCF can not be performed. In order to perform operations using the Q173SCCF, the system must be restarted. Refer to the servo amplifier instruction manual on your servo amplifier and/or MR Configurator2 help concerning MR Configurator2 test operation.

API LIBRARY

- To check if test mode (TSTO) is ON/OFF, check if SSC_STSBIT_AX_TSTO is ON/OFF with the sscGetStatusBitSignalEx or sscWaitStatusBitSignalEx function.

7.10.1 Structural diagram

(1) Under normal operation

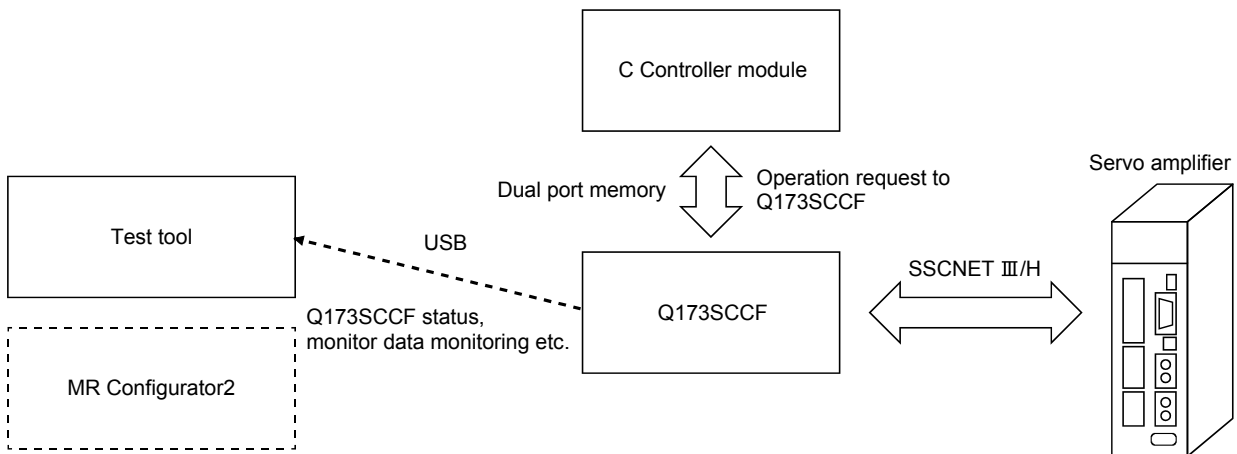

(2) While in test mode

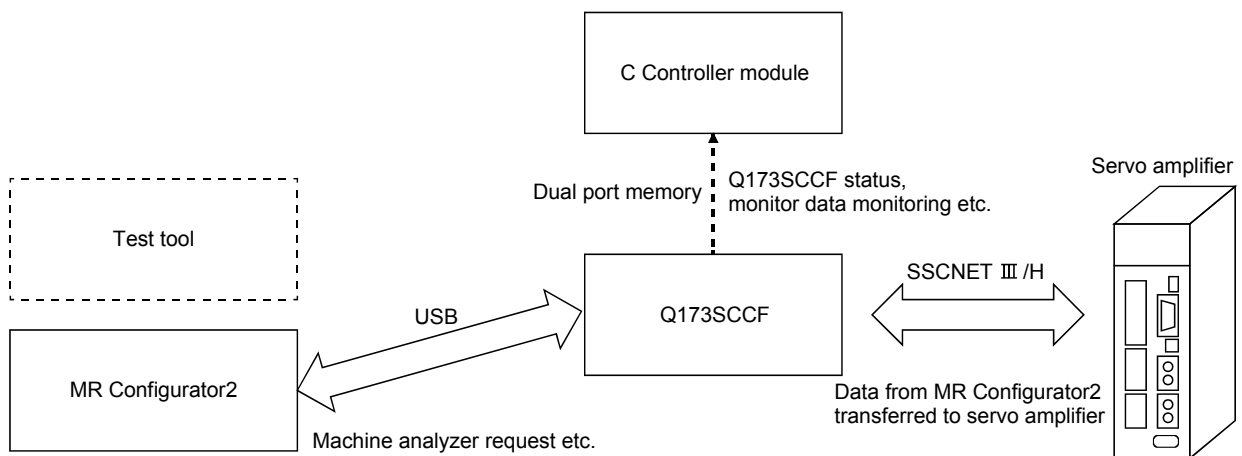

7. AUXILIARY FUNCTION

7.10.2 Test operation mode

(1) Limitations

- (a) If operation is started using the Q173SCCF, an in test mode error (operation alarm 1A, detail 01) occurs and operation can not be performed.
- (b) The commands to servo amplifier (servo-on/off, servo alarm reset, torque limit command etc.) are invalid. Monitoring and reading and writing of parameters can be performed as normal.

(2) Transition to test mode

In the following cases, it is not possible to transit to test mode. Confirm error messages on the MR Configurator2.

- (a) While not in system running (system status code 000Ah)
- (b) While an axis is in operation
- (c) While an axis has servo alarm

(3) When a servo parameter has been changed using the MR Configurator2

If a servo parameter is changed at the MR Configurator2 using the machine analyzer etc., it is necessary to reflect the parameters that are managed by the C Controller module for all the parameters that were changed. As the parameters that were changed can be confirmed using the "servo parameter change number", read the parameter and reflect it to the parameters being managed by the C Controller module.

7. AUXILIARY FUNCTION

7.11 Reconnect/disconnect function

7.11.1 Disconnection function summary

By turning on the disconnection command, SSCNET communication with selected axis and later can be disconnected.

To use this function, set the consistency check selection at system startup of the control cycle (parameter No.0002) to invalid. This function becomes available after the system is started.

The axes whose communication is disconnected become non-communicating axes, so their power supplies can be turned off and SSCNET cables can be detached. At this time, communicating axes are not affected.

Note. If the power supplies of communicating axes are turned off or their SSCNETIII cables are detached, a system error of the Q173SCCF occurs and the axes enter forced stop status.

POINT

- Refer to the controlling axis information after the disconnection is completed to check the bit corresponding to the non-communicating axis is off.

API LIBRARY

- Use the `sscDisconnectSSCNET` function to disconnect SSCNET communication.

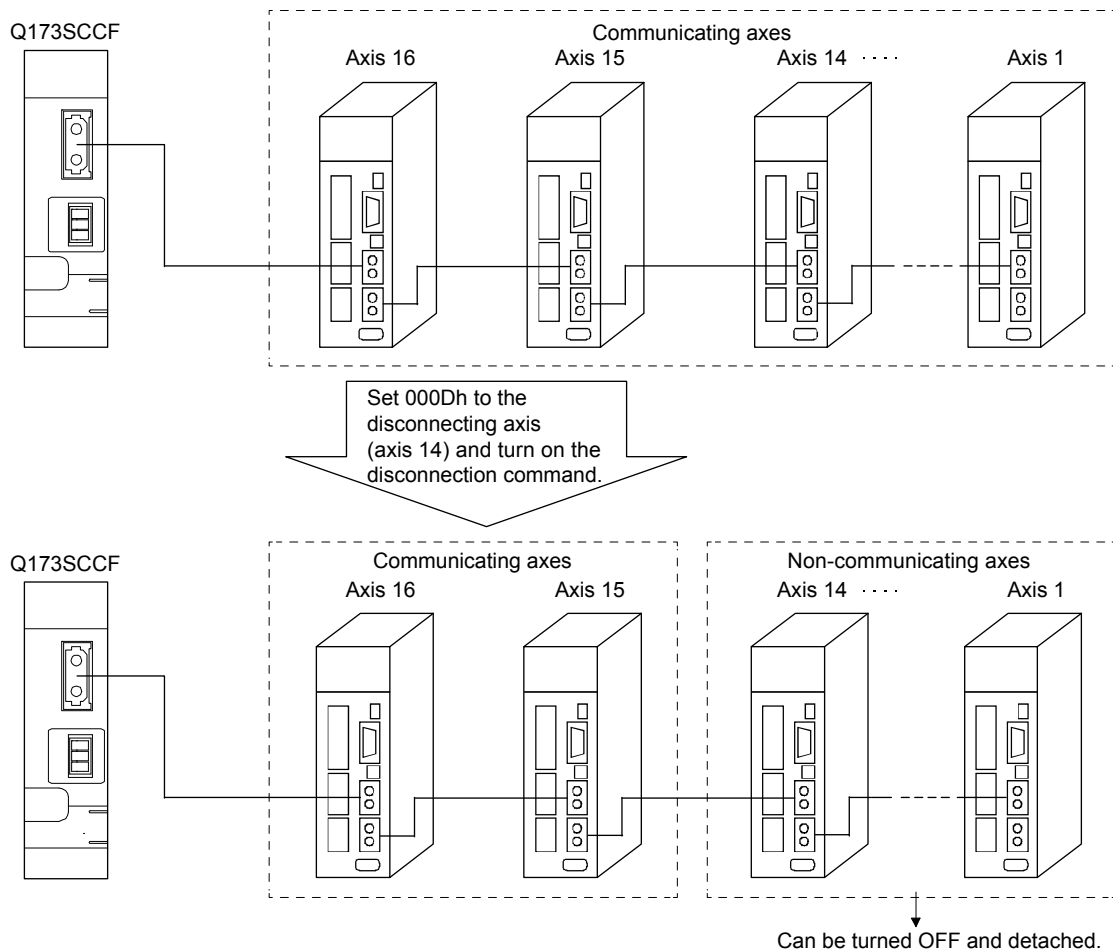

7. AUXILIARY FUNCTION

7.11.2 Reconnect function summary

This function is a function that searches for controlled and non-communicating axes from all connected axes and starts SSCNET communication with them by turning on the reconnection command (RCC).

To use this function, set the consistency check selection at system startup of the control cycle (parameter No.0002) to invalid. This function becomes available after the system is started.

POINT

- Set all parameters related to reconnecting axes before system startup, including the setting of control axis (parameter No.0200).
- Update time synchronization information before turning ON reconnection command (RCC).
- Refer to the controlling axis information after the reconnection is completed to check the bit corresponding to the communicating axis is on.
- When an axis which has completed home position return is reconnected after being disconnected, it is in a home position return incomplete status (home position return request (ZREQ) is ON) at the time of reconnection. (Except for when absolute position detection system is valid and absolute position was correctly restored, and when no home position is valid (parameter No.0200))

API LIBRARY

- Use the sscReconnectSSCNET function to reconnect SSCNET communication.
- Update the time synchronization information with the sscReconnectSSCNET function.

7. AUXILIARY FUNCTION

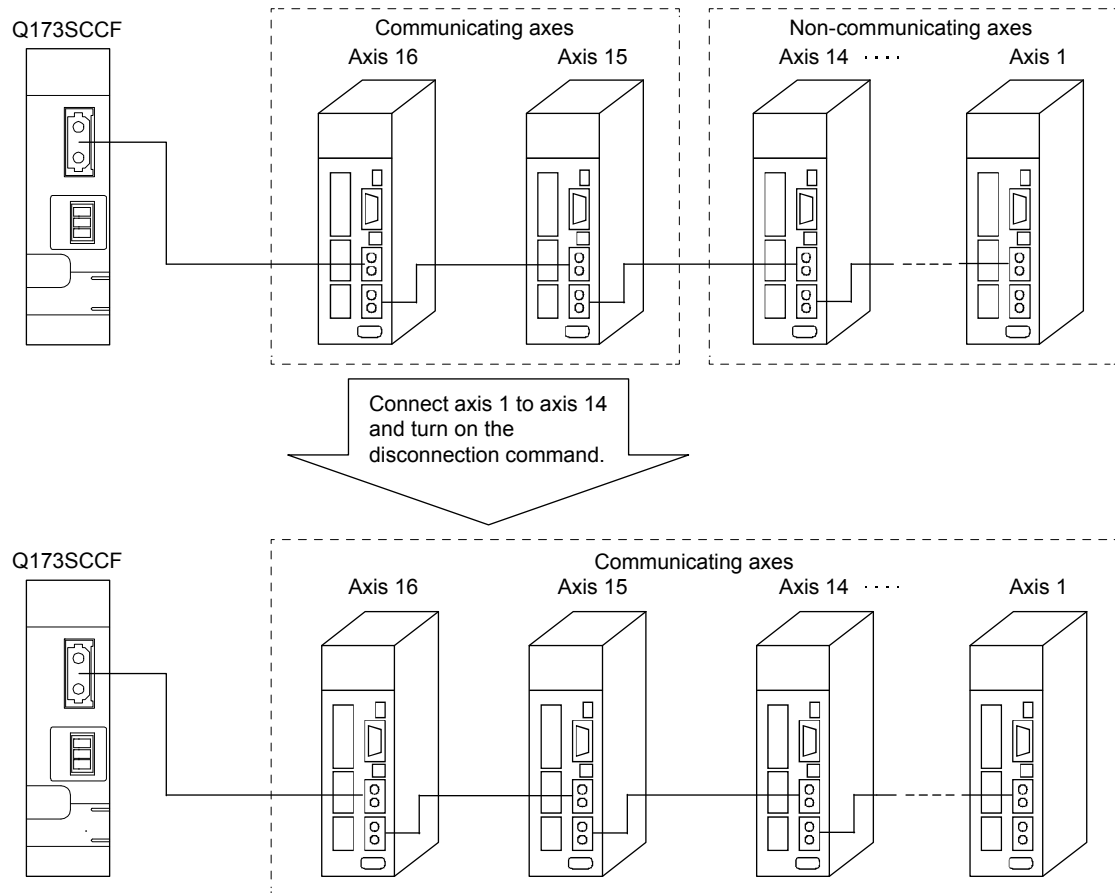

7. AUXILIARY FUNCTION

7.11.3 Interface

(1) System command/system status

Address	Content
0434	Disconnection axis No.
0435	

Address	Content
04A4	Error code of reconnection/disconnection
04A5	

Note. Set the axis No. by 0000h (axis 1) to 0013h (axis 20), and station No. by 8000h (station 1) to 8003h (station 4).

[Error code of reconnection/disconnection]

No.	Content	Detail
0001h	Disconnected axis specification error	The axis (station) specified as the disconnecting axis (station) is not in communication.
0002h	Reconnected axis No. duplication error	The axis No. (station No.) of the reconnected axis (station) is already used.
0003h	Reconnected axis type code error	The vendor ID and type code of the reconnected axis (station) differ from the setting of the parameter (parameter No.021D, 021E).
0004h	Reconnection error during communication error	Execute reconnection during communication error.
0006h	Communication cycle error	An axis (station) that is not compatible with the set control cycle (communication cycle) is connected.

(2) System command/status bit

Address	Bit	Abbreviation	Signal name
03EB	0	RCC	Reconnection command
	1		Reserved
	2		
	3	CCC	Disconnection command
	4		Reserved
	5		
	6		
7			

Address	Bit	Abbreviation	Signal name
045B	0	RCO	During reconnection processing
	1	RCF	Reconnection complete
	2	RCE	Reconnection error
	3	CCO	During disconnection processing
	4	CCF	Disconnection complete
	5	CCE	Disconnection error
	6	Reserved	
7			

(3) System parameter

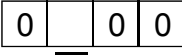
Parameter No.	Abbreviation	Name	Initial value	Unit	Setting range	Function
0002	*SYSOP2	System option 2	0000h		0000h to 0101h	 <p>Consistency check selection at system startup Set whether to perform consistency check selection for controlled axes setting at system startup. 0: Valid 1: Invalid</p>

7. AUXILIARY FUNCTION

(4) System configuration information table

Address	Content	Remarks
06E0	Controlling axis information (lower) (4-byte)	The bit corresponding to the SSCNET communicating axis or the amplifier-less axis turns on. The bit is the axis 1 (bit 0) to the axis 20 (bit 19).
06E4	Controlling axis information (upper) (4-byte)	Fixed at 0.
06E8	Controlling station information (2-byte)	The bit corresponding to the SSCNET communicating station or the remote I/O disconnect station turns on. The bit is the station 1 (bit 0) to the station 4 (bit3).

7.11.4 Disconnection method

SSCNET communication disconnection is executed by turning on the disconnection command after the axis No. of the axis to be disconnected is specified.

The flowchart of the disconnection is shown below.

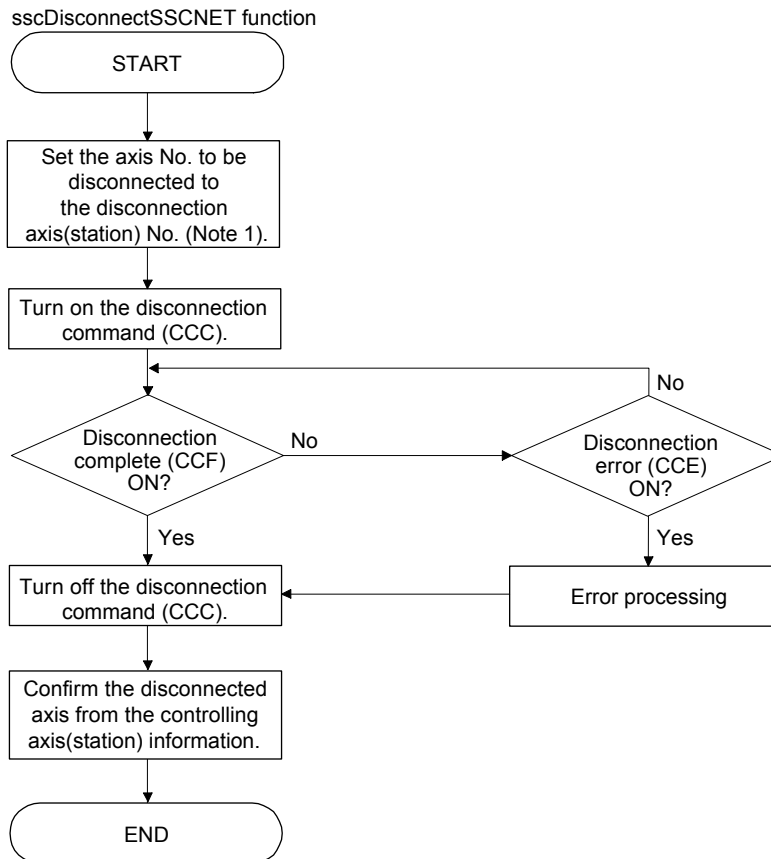

Note 1. Set the axis No. by 0000h (axis 1) to 0013h (axis 20), and station No. by 8000h (station 1) to 8003h (station 4).

2. When the consistency check selection at system startup of the control cycle (parameter No.0002) is valid, disconnection error (CCE) turns on.

7. AUXILIARY FUNCTION

7.11.5 Reconnection method

SSCNET communication reconnection is executed by turning on the reconnection command. The axis No. to be connected axis is not needed to be specified.

The flowchart of the reconnection is shown below.

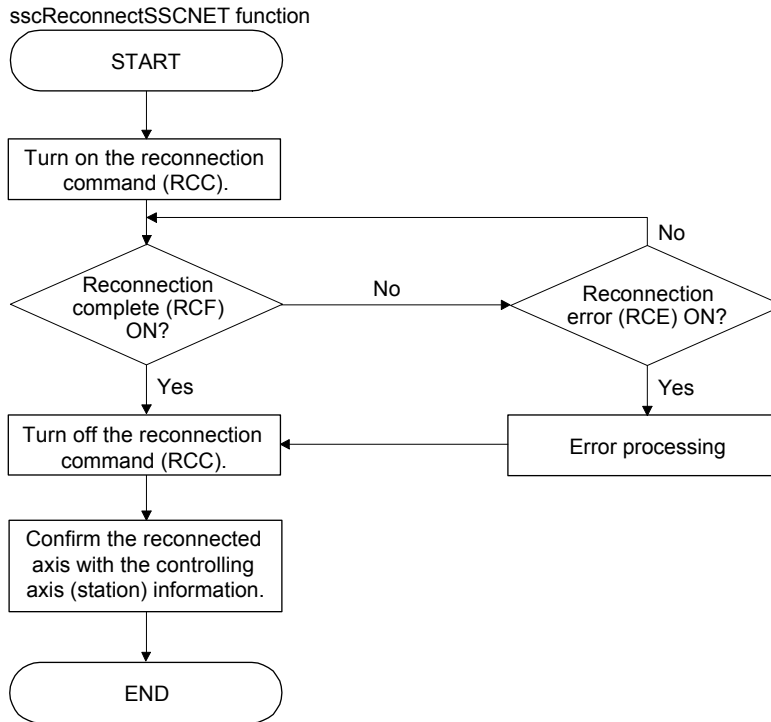

7. AUXILIARY FUNCTION

7.11.6 Restrictions

The restrictions for SSCNET reconnect/disconnect function are shown below.

(1) Linear interpolation startup

When the axis allocated to the same linear interpolation group is not connected, a primary axis linear interpolation startup error (operation alarm 40, detail 01) occurs.

(2) Tandem drive

When the axis allocated to the same tandem drive group is not connected, servo cannot be turned on during in the synchronous mode.

During operation in non-synchronous micro-adjustment mode, the servo operates normally.

(3) Disconnect during operation

When SSCNET disconnection is executed to the axis which is during operation, servo is not controllable (operation alarm B0, detail 02) occurs and the servo stops by the dynamic brake or decelerates to stop depending on the setting of the servo amplifier.

(4) Multi-axis amplifier

When using SSCNET disconnect function in multi-axis amplifier such as MR-J4W□-□B, make sure that all axes in the unit are simultaneously disconnected.

When the disconnection command is sent to the second axis or later in the same unit, the disconnection error (CCE) turns on.

(5) Turning off the power supply after disconnection

Turn off the power supply of the servo amplifier after confirming the LED indicates "AA" and SSCNET disconnection completed.

For the SSCNETⅢ/H head module, check that the REM.LED is OFF before turning OFF power supply of the SSCNETⅢ/H head module.

For the sensing module, check that the sensing SSCNETⅢ/H head module RUN.LED is flickering before turning OFF power supply of sensing module.

(6) Operation at the system startup

When the consistency check selection at system startup of the control cycle (parameter No.0002) is set to invalid and all control axes are not connected when system is started, an axis that has not been mounted exists (system error E400) does not occur and the system is started with the only connected axis.

(7) Input device signal

When a limit switch is allocated to a remote I/O input device and that input device allocated to the module is disconnected, the limit is continuously detected. However, when maintain status is set for RI control at communication error for control option 2 (parameter No.0201), the status before disconnection is maintained.

7. AUXILIARY FUNCTION

7.12 Sampling

7.12.1 Summary

The sampling function is a function that monitors the servo amplifier status and samples this data. After sending the sampling start signal (SMPS), the following data is sampled every sampling period. The data is sampled in the sampling data buffer area in the Q173SCCF up to 8192 points. In sampling with the sampling points exceeding 8192, the user program always needs to read sampling data during sampling. Data can be sampled up to 65536 points. (For details, refer to Section 7.12.10.)

POINT
<ul style="list-style-type: none">▪ The sampling function can be used in the test tool.▪ When using the graph function of the test tool using a USB connection, the data can be sampled up to 8192 points since enough data transfer speed cannot be ensured.

API LIBRARY
<ul style="list-style-type: none">▪ For a detailed procedure for sampling, refer to the sample program (Sampling) contained on the utility software.

The sampled data can be read to the sampling data read area (address: BE00h to CE80h) by specifying the sampling read page number. The sampled data is stored in the Q173SCCF internal memory and initialized by power off of the Q173SCCF or the software reboot.

7. AUXILIARY FUNCTION

7.12.2 Command/status bit

System command/status bits related to sampling function are shown below.

System command

Address	Bit	Symbol	Signal name
03E1	0	SMPS	Sampling start
	1	Reserved	Reserved
	2		
	3		
	4		
	5		
	6		
	7		

System status

Address	Bit	Symbol	Signal name
0451	0	SMPW	Waiting for sampling trigger
	1	SMPO	Sampling is being performed
	2	SMPF	Sampling is complete
	3	SMPE	Sampling error
	4	Reserved	Reserved
	5		
	6		
	7		

Address	Bit	Symbol	Signal name
03F2	0	SMPSW	Sampling setting write command
	1	Reserved	Reserved
	2		
	3		
	4	SMPSR	Sampling setting read command
	5	Reserved	Reserved
	6		
	7		

Address	Bit	Symbol	Signal name
0462	0	SWFIN	Sampling setting write complete
	1	SWEN	Sampling setting number error
	2	SWED	Sampling setting data out of bounds
	3	Reserved	Reserved
	4		
	4	SRFIN	Sampling setting read complete
	5	SREN	Sampling setting number error
	6	Reserved	Reserved
7			

(1) Details concerning system command bits

Symbol	Signal name	Function details
SMPS	Sampling start	<p>[Function] Starts sampling.</p> <p>[Operation] When the sampling start signal (SMPS) is turned on, storage of sampling data is started.</p>
SMPSR	Sampling setting read command	<p>[Function] Reads sampling setting.</p> <p>[Operation] Reads sampling setting set to sampling setting read number. When the sampling setting read number is incorrect, sampling setting read will not be performed.</p> <p>(Remarks) The sampling setting read command is valid only while system is running.</p>
SMPSW	Sampling setting write command	<p>[Function] Writes sampling setting.</p> <p>[Operation] Writes sampling setting set to sampling setting write number. When the sampling setting write number is incorrect and the sampling setting to be written is outside the setting range, the sampling setting write will not be performed.</p> <p>(Remarks) The sampling setting write command is valid only while system is running.</p>

7. AUXILIARY FUNCTION

(2) Details concerning system status bits

Symbol	Signal name	Function details
SMPW	Waiting for sampling trigger	<p>[Function] Notifies concerning the status of waiting for sampling trigger.</p> <p>[Operation] <Conditions for turning on> Turning on of sampling start signal (SMPS), and waiting for the sample trigger.</p> <p><Conditions for turning off></p> <ul style="list-style-type: none"> • The sampling start signal (SMPS) is turned off. • The trigger for the start sampling trigger axis is met.
SMPO	Sampling is being performed	<p>[Function] Notifies that sampling is now being performed.</p> <p>[Operation] <Conditions for turning on> Turning on of sampling start signal (SMPS), and sampling is now being performed.</p> <p><Conditions for turning off></p> <ul style="list-style-type: none"> • The sampling start signal (SMPS) is turned off. • Sampling is completed.
SMPF	Sampling is complete	<p>[Function] Notifies that sampling was completed normally.</p> <p>[Operation] <Conditions for turning on> Sampling is completed normally.</p> <p><Conditions for turning off> The sampling start signal (SMPS) is turned off.</p>
SMPE	Sampling error	<p>[Function] Notifies that sampling was not completed normally.</p> <p>[Operation] <Conditions for turning on></p> <ul style="list-style-type: none"> • The sampling setting error occurs. • The sampling item error occurs. • The next page number of the sampling completion page number is the same as the sampling read page number. (The data was not sampled in time.) • The sampling start signal (SMPS) is turned on when the read sampled data completion page number is -1. • The page number 0 is designated from the page number other than 0 when the sampling is being performed. <p><Conditions for turning off> The start sampling signal (SMPS) is turned off.</p>
SWFIN	Sampling setting write complete	<p>[Function] Notifies that writing of the sampling setting was completed.</p> <p>[Operation] <Conditions for turning on> The sampling setting write number and the setting value in the range are set correctly and the sampling setting write command (SMPSW) is turned on.</p> <p><Conditions for turning off> The sampling setting write command signal (SMPSW) is turned off.</p>
SWEN	Sampling setting number error	<p>[Function] Notifies that the sampling setting number is incorrect.</p> <p>[Operation] <Conditions for turning on> The sampling setting number is set incorrectly and the sampling setting write command (SMPSW) is turned on.</p> <p><Conditions for turning off> The sampling setting write command signal (SMPSW) is turned off.</p>

7. AUXILIARY FUNCTION

Symbol	Signal name	Function details
SWED	Sampling setting data out of bounds	<p>[Function] Notifies that the sampling setting value is outside the setting range.</p> <p>[Operation] <Conditions for turning on> The sampling setting value which is outside the setting range is set and the sampling setting write command (SMPSW) is turned on. <Conditions for turning off> The sampling setting write command signal (SMPSW) is turned off.</p>
SRFIN	Sampling setting read complete	<p>[Function] Notifies that reading of the sampling setting was completed.</p> <p>[Operation] <Conditions for turning on> The sampling setting read number is set correctly and the sampling setting read command (SMPSR) is turned on. <Conditions for turning off> The sampling setting read command signal (SMPSR) is turned off.</p>
SREN	Sampling setting number error	<p>[Function] Notifies that the sampling setting number is incorrect.</p> <p>[Operation] <Conditions for turning on> The sampling setting read number is set incorrectly and the sampling setting read command (SMPSR) is turned on. <Conditions for turning off> The sampling setting read command signal (SMPSR) is turned off.</p>

7. AUXILIARY FUNCTION

7.12.3 Command/status data

The system command/status data related to the sampling function are shown below.

(1) Sampling setting write (command)

Address	Name	Setting range	Remarks
BDA0	Sampling setting write number	0000h to 00AFh	Set the sampling setting number to be written. Note. For 0000h, sampling setting number error does not occur.
BDA1			
BDA2	Reserved		
BDA3			
BDA4	Sampling setting write data	00000000h to FFFFFFFFh	Set the data of the sampling setting number to be written.
BDA5			
BDA6			
BDA7			

(2) Sampling setting write (status)

Address	Name	Output limits	Remarks
BDA8	Sampling setting write number	0000h to FFFFh	Displays the sampling setting number which was written.
BDA9			
BDAA	Reserved		
BDAB			
BDAC	Sampling setting write data	00000000h to FFFFFFFFh	Displays the data of the sampling setting number which was written.
BDAD			
BDAE			
BDAF			

(3) Sampling setting read (command)

Address	Name	Setting range	Remarks
BDB0	Sampling setting read number	0000h to 00AFh	Set the sampling setting number to be read. Note. For 0000h, sampling setting number error does not occur.
BDB1			
BDB2	Reserved		
BDB3			
BDB4			
BDB5			
BDB6			
BDB7			

(4) Sampling setting read (status)

Address	Name	Output limits	Remarks
BDB8	Sampling setting read number	0000h to FFFFh	Displays the sampling setting number which was read.
BDB9			
BDBA	Reserved		
BDBB			
BDBC	Sampling setting read data	00000000h to FFFFFFFFh	Displays the data of the sampling setting number which was read.
BDBD			
BDBE			
BDBF			

7. AUXILIARY FUNCTION

(5) Sampling error information

Address	Name	Output limits	Remarks
BDC0	Sampling axis error information 1	10000000h to FFFFFFFFh	Turns on the bit of the axis which cannot be controlled. Axis No. 1 (bit 0) to 20 (bit 19)
BDC1			
BDC2			
BDC3			
BDC4	Reserved		
BDC5			
BDC6			
BDC7			
BDC8			
BDC9			
BDCA			
BDCB			
BDCC			
BDCD			
BDCE			
BDCF			
BDD0	Sampling data error information	00000000h to FFFFFFFFh	Turns on the bit of the sampling data which became sampling error. Sampling data 1 (bit 0) to 32 (bit 31)
BDD1			
BDD2			
BDD3			
BDD4	Reserved		
BDD5			
BDD6			
BDD7			
BDD8	Sampling bit error information	00000000h to 0000FFFFh	Turns on the bit of the sampling bit information which became sampling error. Sampling data information 1 (bit 0) to 16 (bit 15)
BDD9			
BDDA			
Bddb			
BDDC	Reserved		
BDDD			
BDDE			
BDDF			

7. AUXILIARY FUNCTION

(6) Sampled data read command

Address	Name	Setting range	Remarks
BDE0	Sampling read page number	0 to 256	Set the page number which is read in the sampling data read area. 12 points of sampled data are read per page. Note. When start sampling, set 0.
BDE1			
BDE2	Reserved		
BDE3			
BDE4			
BDE5			
BDE6			
BDE7			

(7) Sampled data read status

Address	Name	Output limits	Remarks
BDE8	Read sampled data completion page number	-2 to 256	The page number which is transferred to the sampling data read area is stored. -2: Sampling read error -1: Sampling reading 0: When sampling read number is 0 1 to 256: Page number whose sampled data is read
BDE9			
BDEA	Valid read sampled points	0 to 16	The number of sampled data in the page where sampling read is completed is stored. The user program needs to read the sampling data read area and to refer to the data of this valid read sampled points. All sampled data after the valid sampled points is 0. 0 to 16 points: Data points sampled in a page
BDEB			
BDEC	Sampling completion page number	0 to 256	The page number where sampling is completed by the Q173SCCF is stored. 0: Sampling trigger waiting or the page number 1 (only the first time) is being sampled 1 to 256: Sampling completion page number
BDED			
BDEE	Reserved		
BDEF			

7. AUXILIARY FUNCTION

7.12.4 Sampling setting write/read

The conditions for sampling and contents of sampling can be set. Also, the current sampling setting can be read. The sampling setting write/read is valid after executing parameter initialization (system command code: 0003h).

(1) When writing the sampling setting

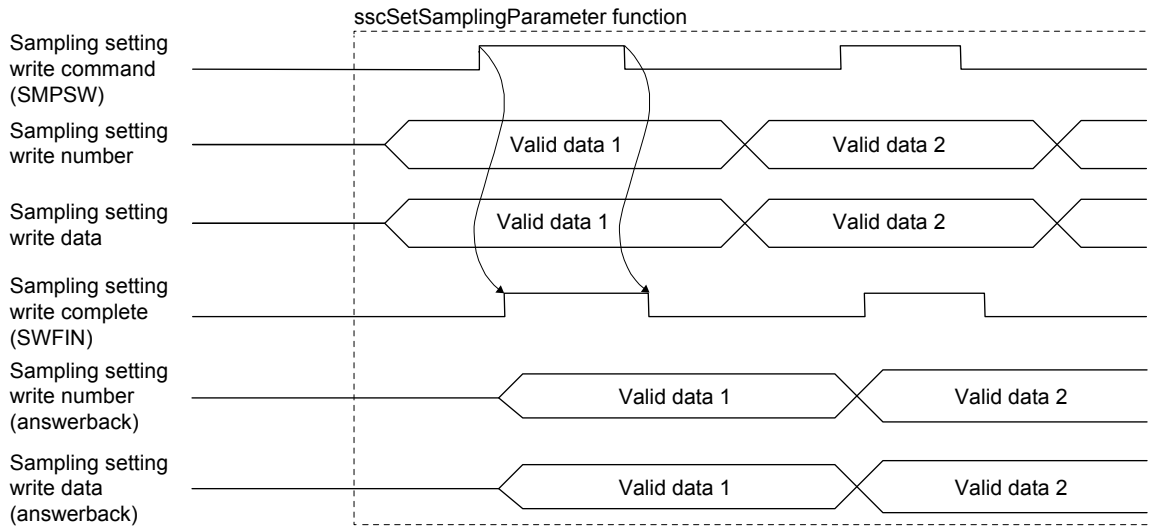

POINT

- The sampling setting write data is written in 4 bytes.

(2) When reading the sampling setting

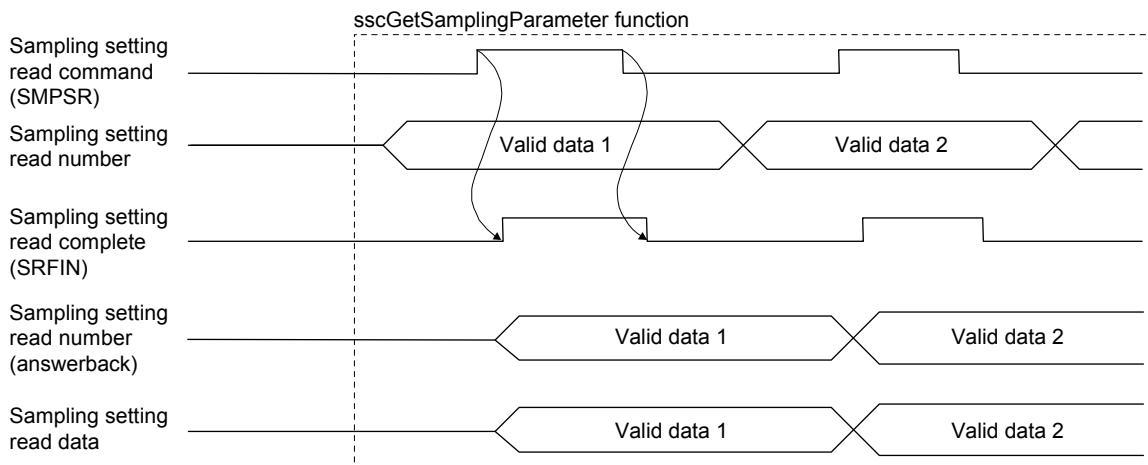

POINT

- The sampling setting read data is read in 4 bytes.

7. AUXILIARY FUNCTION

7.12.5 Details for sampling function settings

Settings related to sampling function are shown below. Each setting is imported when the sampling is started (SMPS: ON). The sampling setting cannot be changed while Waiting for sampling trigger (SMPW) is on and Sampling is being performed (SMPO) is on.

(1) Sampling setting

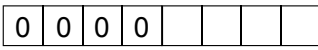
Setting No.	Name	Initial value	Setting range	Remarks
0001	Sampling option	00000000h	00000000h to 000029FFh	 <p>Sampling cycle Set the sampling cycle. 00h to FFh: Control cycle $\times(\text{setting} + 1)$ [Example] If the sampling cycle is set to 3 with the control cycle set to 0.44ms, sampling is executed every 1.777ms.</p> <p>Pre-trigger Set the timing that the trigger condition is satisfied. 0 to 9: Setting $\times 10\%$ [Example] When pre-trigger is 10% with 8192 points of sampling points, 819 points of data</p> <p>Trigger mode Set the trigger mode. 0: Trigger turns on when the sampling is started. 1: Trigger turns on when one of each trigger condition is satisfied. 2: Trigger turns on when all of the trigger conditions are satisfied.</p>
0002	Sampling points	8192	0 to 65536	Set the points to be sampled.
0003	For manufacturer setting	00000000h		
0004		00000000h		
0005		00000000h		
0006		00000000h		
0007		00000000h		
0008		00000000h		
0009		00000000h		
000A		00000000h		
000B		00000000h		
000C		00000000h		
000D		00000000h		
000E		00000000h		
000F		00000000h		

7. AUXILIARY FUNCTION

Setting No.	Name	Initial value	Setting range	Remarks
0010	Sampling trigger 1 setting	00000000h	00000000h to 10041F01h	<div style="display: flex; align-items: center;"> <div style="border: 1px solid black; padding: 2px; margin-right: 10px;">0</div> <div style="border: 1px solid black; padding: 2px; margin-right: 10px;">0</div> <div style="border: 1px solid black; padding: 2px; margin-right: 10px;">0</div> <div style="border: 1px solid black; padding: 2px; margin-right: 10px;">0</div> <div style="border: 1px solid black; padding: 2px; margin-right: 10px;">0</div> <div style="border: 1px solid black; padding: 2px; margin-right: 10px;">0</div> <div style="border: 1px solid black; padding: 2px; margin-right: 10px;">0</div> <div style="border: 1px solid black; padding: 2px; margin-right: 10px;">0</div> <div style="border: 1px solid black; padding: 2px; margin-right: 10px;">0</div> <div style="border: 1px solid black; padding: 2px; margin-right: 10px;">0</div> </div> <p>Trigger 1 sampling items Selects the sampling items referred by trigger 1. 0: Sampling data 1: Sampling bit information</p> <p>The following settings differ up to Trigger 1 sampling items.</p> <ul style="list-style-type: none"> When Sampling data is selected <div style="display: flex; align-items: center; margin-top: 10px;"> <div style="border: 1px solid black; padding: 2px; margin-right: 10px;">0</div> <div style="border: 1px solid black; padding: 2px; margin-right: 10px;">0</div> <div style="border: 1px solid black; padding: 2px; margin-right: 10px;">0</div> <div style="border: 1px solid black; padding: 2px; margin-right: 10px;">0</div> <div style="border: 1px solid black; padding: 2px; margin-right: 10px;">0</div> <div style="border: 1px solid black; padding: 2px; margin-right: 10px;">0</div> <div style="border: 1px solid black; padding: 2px; margin-right: 10px;">0</div> <div style="border: 1px solid black; padding: 2px; margin-right: 10px;">0</div> </div> <p>Trigger 1 sampling data number Set the sampling data number referred by trigger 1 in hexadecimal. Example: 00h to 1Fh: Sampling data 1 to 32</p> <p>Trigger 1 condition Set the trigger 1 condition. 0: Trigger 1 setting invalid 1: Fulfilled when passing through trigger value 1 in increase direction 2: Fulfilled when passing through trigger value 1 in decrease direction 3: Fulfilled with trigger value 1 or higher 4: Fulfilled with trigger value 1 or lower</p> <p>Trigger 1 code Set the code of sampling data referred by trigger 1. 0: Without code 1: With code</p> <ul style="list-style-type: none"> When Sampling bit information is selected <div style="display: flex; align-items: center; margin-top: 10px;"> <div style="border: 1px solid black; padding: 2px; margin-right: 10px;">0</div> <div style="border: 1px solid black; padding: 2px; margin-right: 10px;">0</div> <div style="border: 1px solid black; padding: 2px; margin-right: 10px;">0</div> <div style="border: 1px solid black; padding: 2px; margin-right: 10px;">0</div> <div style="border: 1px solid black; padding: 2px; margin-right: 10px;">0</div> <div style="border: 1px solid black; padding: 2px; margin-right: 10px;">1</div> </div> <p>Trigger 1 sampling bit information number Set the number of the sampling bit information referred by trigger 1 in hexadecimal. Example: 00h to 0Fh: sampling data 1 to 16</p> <p>Trigger 1 condition Set the trigger 1 condition. 0: Trigger 1 setting invalid 1: Fulfilled by leading edge of bit 2: Fulfilled by trailing edge of bit 3: Fulfilled while bit is on 4: Fulfilled while bit is off</p>
0011	Sampling trigger 2 setting	00000000h	00000000h to 10041F01h	Same as the sampling trigger 1 setting.
0012	Sampling trigger 3 setting	00000000h	00000000h to 10041F01h	Same as the sampling trigger 1 setting.
0013	Sampling trigger 4 setting	00000000h	00000000h to 10041F01h	Same as the sampling trigger 1 setting.
0014	Sampling trigger 5 setting	00000000h	00000000h to 10041F01h	Same as the sampling trigger 1 setting.

7. AUXILIARY FUNCTION

Setting No.	Name	Initial value	Setting range	Remarks
0015	Sampling trigger 6 setting	00000000h	00000000h to 10041F01h	Same as the sampling trigger 1 setting.
0016	Sampling trigger 7 setting	00000000h	00000000h to 10041F01h	Same as the sampling trigger 1 setting.
0017	Sampling trigger 8 setting	00000000h	00000000h to 10041F01h	Same as the sampling trigger 1 setting.
0018		00000000h		
0019		00000000h		
001A		00000000h		
001B		00000000h		
001C		00000000h		
001D		00000000h		
001E		00000000h		
001F		00000000h		
0020	Sampling trigger value 1	00000000h	00000000h to FFFFFFFFh	Set the threshold for trigger 1. Note 1. Set the threshold in double word regardless of the size of the data set in the sampling trigger 1 setting. 2. When the contents of trigger 1 are sampling bit information, this setting is not used.
0021	Sampling trigger value 2	00000000h	00000000h to FFFFFFFFh	Set the threshold for trigger 2. The setting contents are the same as the sampling trigger value 1.
0022	Sampling trigger value 3	00000000h	00000000h to FFFFFFFFh	Set the threshold for trigger 3. The setting contents are the same as the sampling trigger value 1.
0023	Sampling trigger value 4	00000000h	00000000h to FFFFFFFFh	Set the threshold for trigger 4. The setting contents are the same as the sampling trigger value 1.
0024	Sampling trigger value 5	00000000h	00000000h to FFFFFFFFh	Set the threshold for trigger 5. The setting contents are the same as the sampling trigger value 1.
0025	Sampling trigger value 6	00000000h	00000000h to FFFFFFFFh	Set the threshold for trigger 6. The setting contents are the same as the sampling trigger value 1.
0026	Sampling trigger value 7	00000000h	00000000h to FFFFFFFFh	Set the threshold for trigger 7. The setting contents are the same as the sampling trigger value 1.
0027	Sampling trigger value 8	00000000h	00000000h to FFFFFFFFh	Set the threshold for trigger 8 The setting contents are the same as the sampling trigger value 1.
0028	For manufacturer setting	00000000h		
0029		00000000h		
002A		00000000h		
002B		00000000h		
002C		00000000h		
002D		00000000h		
002E		00000000h		
002F		00000000h		

7. AUXILIARY FUNCTION

Setting No.	Name	Initial value	Setting range	Remarks								
0030	Sampling data 1 setting	00000000h	00000000h to 00FF14FFh	<div style="display: flex; align-items: center;"> <table border="1" style="border-collapse: collapse; text-align: center; width: 150px;"> <tr> <td style="width: 20px;">0</td> <td style="width: 20px;">0</td> <td style="width: 20px;"></td> <td style="width: 20px;"></td> <td style="width: 20px;"></td> <td style="width: 20px;"></td> <td style="width: 20px;"></td> <td style="width: 20px;"></td> </tr> </table> <div style="margin-left: 10px;"> <p>Monitor No. Specify the monitor number to be sampled. 0000h: Not selected 0100h to 01FFh: servo information (1) 0200h to 02FFh: servo information (2) 0300h to 03FFh: operation information 1300h to 13FFh: operation information (double word) 0400h to 04FFh: system information 1400h to 14FFh: system information (double word) Note. Axis No. is not needed to be set in the system information.</p> <p>Axis No. Set the axis No. of sampling data 1. 00h to 13h: Axis No.-1 Example: 00h: Axis No.1</p> </div> </div>	0	0						
0	0											
0031	Sampling data 2 setting	00000000h	00000000h to 00FF14FFh	Same as the sampling data 1 setting.								
0032	Sampling data 3 setting	00000000h	00000000h to 00FF14FFh	Same as the sampling data 1 setting.								
0033	Sampling data 4 setting	00000000h	00000000h to 00FF14FFh	Same as the sampling data 1 setting.								
0034	Sampling data 5 setting	00000000h	00000000h to 00FF14FFh	Same as the sampling data 1 setting.								
0035	Sampling data 6 setting	00000000h	00000000h to 00FF14FFh	Same as the sampling data 1 setting.								
0036	Sampling data 7 setting	00000000h	00000000h to 00FF14FFh	Same as the sampling data 1 setting.								
0037	Sampling data 8 setting	00000000h	00000000h to 00FF14FFh	Same as the sampling data 1 setting.								
0038	Sampling data 9 setting	00000000h	00000000h to 00FF14FFh	Same as the sampling data 1 setting.								
0039	Sampling data 10 setting	00000000h	00000000h to 00FF14FFh	Same as the sampling data 1 setting.								
003A	Sampling data 11 setting	00000000h	00000000h to 00FF14FFh	Same as the sampling data 1 setting.								
003B	Sampling data 12 setting	00000000h	00000000h to 00FF14FFh	Same as the sampling data 1 setting.								
003C	Sampling data 13 setting	00000000h	00000000h to 00FF14FFh	Same as the sampling data 1 setting.								
003D	Sampling data 14 setting	00000000h	00000000h to 00FF14FFh	Same as the sampling data 1 setting.								
003E	Sampling data 15 setting	00000000h	00000000h to 00FF14FFh	Same as the sampling data 1 setting.								
003F	Sampling data 16 setting	00000000h	00000000h to 00FF14FFh	Same as the sampling data 1 setting.								

7. AUXILIARY FUNCTION

Setting No.	Name	Initial value	Setting range	Remarks
0040	Sampling data 17 setting	00000000h	00000000h to 00FF14FFh	Same as the sampling data 1 setting.
0041	Sampling data 18 setting	00000000h	00000000h to 00FF14FFh	Same as the sampling data 1 setting.
0042	Sampling data 19 setting	00000000h	00000000h to 00FF14FFh	Same as the sampling data 1 setting.
0043	Sampling data 20 setting	00000000h	00000000h to 00FF14FFh	Same as the sampling data 1 setting.
0044	Sampling data 21 setting	00000000h	00000000h to 00FF14FFh	Same as the sampling data 1 setting.
0045	Sampling data 22 setting	00000000h	00000000h to 00FF14FFh	Same as the sampling data 1 setting.
0046	Sampling data 23 setting	00000000h	00000000h to 00FF14FFh	Same as the sampling data 1 setting.
0047	Sampling data 24 setting	00000000h	00000000h to 00FF14FFh	Same as the sampling data 1 setting.
0048	Sampling data 25 setting	00000000h	00000000h to 00FF14FFh	Same as the sampling data 1 setting.
0049	Sampling data 26 setting	00000000h	00000000h to 00FF14FFh	Same as the sampling data 1 setting.
004A	Sampling data 27 setting	00000000h	00000000h to 00FF14FFh	Same as the sampling data 1 setting.
004B	Sampling data 28 setting	00000000h	00000000h to 00FF14FFh	Same as the sampling data 1 setting.
004C	Sampling data 29 setting	00000000h	00000000h to 00FF14FFh	Same as the sampling data 1 setting.
004D	Sampling data 30 setting	00000000h	00000000h to 00FF14FFh	Same as the sampling data 1 setting.
004E	Sampling data 31 setting	00000000h	00000000h to 00FF14FFh	Same as the sampling data 1 setting.
004F	Sampling data 32 setting	00000000h	00000000h to 00FF14FFh	Same as the sampling data 1 setting.
0050	For manufacturer setting	00000000h		
:		:		
006F		00000000h		

7. AUXILIARY FUNCTION

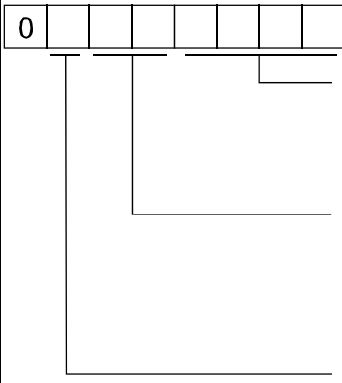
Setting No.	Name	Initial value	Setting range	Remarks
0070	Sampling bit information setting 1 (Note)	00000000h	00000000h to 0FFF03FFh	 <p>Monitor No. Set the monitor number including the bit information to be sampled. 0000h: Not selected 0300h to 03FFh: operation information</p> <p>Axis No./Station No. Set the axis No. of sampling data 1. 00h to 13h: Axis No.-1 Example: 00h: Axis No.1 80h to 83h: Station No.-1+80h Example: 80h: Station No.1</p> <p>Bit No. Set the bit number of the sampling bit information 1. 0h to Fh: Bit No.0 to F</p>
0071	Sampling bit information 2 setting	00000000h	00000000h to 0FFF04FFh	Same as the sampling bit information 1 setting.
0072	Sampling bit information 3 setting	00000000h	00000000h to 0FFF04FFh	Same as the sampling bit information 1 setting.
0073	Sampling bit information 4 setting	00000000h	00000000h to 0FFF04FFh	Same as the sampling bit information 1 setting.
0074	Sampling bit information 5 setting	00000000h	00000000h to 0FFF04FFh	Same as the sampling bit information 1 setting.
0075	Sampling bit information 6 setting	00000000h	00000000h to 0FFF04FFh	Same as the sampling bit information 1 setting.
0076	Sampling bit information 7 setting	00000000h	00000000h to 0FFF04FFh	Same as the sampling bit information 1 setting.
0077	Sampling bit information 8 setting	00000000h	00000000h to 0FFF04FFh	Same as the sampling bit information 1 setting.
0078	Sampling bit information 9 setting	00000000h	00000000h to 0FFF04FFh	Same as the sampling bit information 1 setting.
0079	Sampling bit information 10 setting	00000000h	00000000h to 0FFF04FFh	Same as the sampling bit information 1 setting.
007A	Sampling bit information 11 setting	00000000h	00000000h to 0FFF04FFh	Same as the sampling bit information 1 setting.
007B	Sampling bit information 12 setting	00000000h	00000000h to 0FFF04FFh	Same as the sampling bit information 1 setting.
007C	Sampling bit information 13 setting	00000000h	00000000h to 0FFF04FFh	Same as the sampling bit information 1 setting.
007D	Sampling bit information 14 setting	00000000h	00000000h to 0FFF04FFh	Same as the sampling bit information 1 setting.
007E	Sampling bit information 15 setting	00000000h	00000000h to 0FFF04FFh	Same as the sampling bit information 1 setting.
007F	Sampling bit information 16 setting	00000000h	00000000h to 0FFF04FFh	Same as the sampling bit information 1 setting.
0080	For manufacturer setting	00000000h	/	
:	:	:		
00AF		00000000h		

Note. For the bits which are able to be sampled and their settings (monitor number and bit number), refer to the Section 7.12.7 Sampling items.

7. AUXILIARY FUNCTION

7.12.6 Number of sampled points

By setting the number of sampled points (sampling setting No.0002), points to be sampled can be changed. Number of data which is sampled before the trigger conditions are met (set with pre-trigger) is specified by percentage to the number of sampled points. However, when the number of sampled points exceeds 8192, the percentage is to 8192.

For when the number of sampled points is 8192 or less, and 8193 or more, the characteristics are shown below.

(1) When the number of sampled points is 8192 or less

When sampling of the points set in the sampling points (sampling setting No.0002) is completed, sampling itself is completed automatically. Since the C Controller module is required to read the sampling data buffer area after the sampling is completed, the load on the C Controller module is light, however, on the other hand, sampling for a long time cannot be executed.

(2) When the number of sampled points is 8193 or more

Points which are set to the sampling points (sampling setting No.0002) are sampled by the Q173SCCF. However, the C Controller module is required to read sampled data during the sampling, the load on the C Controller module is high.

The sampling data buffer area of the Q173SCCF internal memory is regarded as the ring buffer of 256 pages (8192 points), and the C Controller module and the Q173SCCF read the sampling data read area with executing exclusive control based on the page number.

POINT
<ul style="list-style-type: none">• The larger the pre-trigger setting is, the higher the load on the C Controller module is since it is required to read the sampling data in a short time after the trigger conditions are met. As an example, when pre-trigger is set to 90%, after the trigger conditions are met, the C Controller module is required to complete reading the data sampled by pre-trigger (at least 1 page) before the Q173SCCF completes the sampling of 10% left.

7. AUXILIARY FUNCTION

7.12.7 Sampling items

Sampling items are sampling data and sampling bit information. By setting axis No./station No. and monitor number to be sampled in sampling data, arbitrary monitor data can be sampled. Up to 32 items of monitor data can be specified. Axis data command/status bit (address 1000h to 100Fh, 1060h to 106Fh) can be sampled as sampling bit information. Up to 16 items of bit information can be specified.

Examples of the sampling items are shown below.

(1) For operation information

Monitor No.0300, 0301 (current command position), monitor No.0302, 0303 (current feedback position), monitor No.0304, 0305 (moving speed) etc. For details, refer to Section 12.4.

(2) For servo information

Monitor No.0200, 0201 (position feedback), monitor No.0204, 0205 (position droop) etc. For details, refer to Section 12.2.

(3) For axis bit information

During operation signal (OP), completion of operation signal (OPF), servo alarm signal (SALM) etc. For details, refer to the following tables.

7. AUXILIARY FUNCTION

(a) Axis data command bit

Monitor No.	Content																																																				
0380	<table border="1"> <thead> <tr> <th>Bit No.</th> <th>Abbreviation</th> <th>Signal name</th> </tr> </thead> <tbody> <tr> <td>0</td> <td>SON</td> <td>Servo on</td> </tr> <tr> <td>1</td> <td rowspan="3">/</td> <td rowspan="3">Reserved</td> </tr> <tr> <td>2</td> </tr> <tr> <td>3</td> </tr> <tr> <td>4</td> <td>TL</td> <td>Torque limit</td> </tr> <tr> <td>5</td> <td>SRST</td> <td>Servo alarm reset</td> </tr> <tr> <td>6</td> <td rowspan="2">/</td> <td rowspan="2">Reserved</td> </tr> <tr> <td>7</td> </tr> </tbody> </table>			Bit No.	Abbreviation	Signal name	0	SON	Servo on	1	/	Reserved	2	3	4	TL	Torque limit	5	SRST	Servo alarm reset	6	/	Reserved	7	<table border="1"> <thead> <tr> <th>Bit No.</th> <th>Abbreviation</th> <th>Signal name</th> </tr> </thead> <tbody> <tr> <td>8</td> <td>ST</td> <td>Start operation</td> </tr> <tr> <td>9</td> <td>DIR</td> <td>Movement direction</td> </tr> <tr> <td>10</td> <td>STP</td> <td>Stop operation</td> </tr> <tr> <td>11</td> <td>RSTP</td> <td>Rapid stop</td> </tr> <tr> <td>12</td> <td rowspan="2">/</td> <td rowspan="2">Reserved</td> </tr> <tr> <td>13</td> </tr> <tr> <td>14</td> <td>ORST</td> <td>Operation alarm reset</td> </tr> <tr> <td>15</td> <td rowspan="2">/</td> <td rowspan="2">Reserved</td> </tr> <tr> <td></td> </tr> </tbody> </table>			Bit No.	Abbreviation	Signal name	8	ST	Start operation	9	DIR	Movement direction	10	STP	Stop operation	11	RSTP	Rapid stop	12	/	Reserved	13	14	ORST	Operation alarm reset	15	/	Reserved	
	Bit No.	Abbreviation	Signal name																																																		
0	SON	Servo on																																																			
1	/	Reserved																																																			
2																																																					
3																																																					
4	TL	Torque limit																																																			
5	SRST	Servo alarm reset																																																			
6	/	Reserved																																																			
7																																																					
Bit No.	Abbreviation	Signal name																																																			
8	ST	Start operation																																																			
9	DIR	Movement direction																																																			
10	STP	Stop operation																																																			
11	RSTP	Rapid stop																																																			
12	/	Reserved																																																			
13																																																					
14	ORST	Operation alarm reset																																																			
15	/	Reserved																																																			
0381	<table border="1"> <thead> <tr> <th>Bit No.</th> <th>Abbreviation</th> <th>Signal name</th> </tr> </thead> <tbody> <tr> <td>0</td> <td>AUT</td> <td>Automatic operation mode</td> </tr> <tr> <td>1</td> <td>ZRN</td> <td>Home position return mode</td> </tr> <tr> <td>2</td> <td>JOG</td> <td>JOG operation mode</td> </tr> <tr> <td>3</td> <td>S</td> <td>Incremental feed mode</td> </tr> <tr> <td>4</td> <td rowspan="2">/</td> <td rowspan="2">Reserved</td> </tr> <tr> <td>5</td> </tr> <tr> <td>5</td> <td>LIP</td> <td>Linear interpolation mode</td> </tr> <tr> <td>6</td> <td>DST</td> <td>Home position reset mode</td> </tr> <tr> <td>7</td> <td rowspan="2">/</td> <td rowspan="2">Reserved</td> </tr> <tr> <td></td> </tr> </tbody> </table>			Bit No.	Abbreviation	Signal name	0	AUT	Automatic operation mode	1	ZRN	Home position return mode	2	JOG	JOG operation mode	3	S	Incremental feed mode	4	/	Reserved	5	5	LIP	Linear interpolation mode	6	DST	Home position reset mode	7	/	Reserved		<table border="1"> <thead> <tr> <th>Bit No.</th> <th>Abbreviation</th> <th>Signal name</th> </tr> </thead> <tbody> <tr> <td>8</td> <td rowspan="8">/</td> <td rowspan="8">Reserved</td> </tr> <tr> <td>9</td> </tr> <tr> <td>10</td> </tr> <tr> <td>11</td> </tr> <tr> <td>12</td> </tr> <tr> <td>13</td> </tr> <tr> <td>14</td> </tr> <tr> <td>15</td> </tr> </tbody> </table>			Bit No.	Abbreviation	Signal name	8	/	Reserved	9	10	11	12	13	14	15					
	Bit No.	Abbreviation	Signal name																																																		
0	AUT	Automatic operation mode																																																			
1	ZRN	Home position return mode																																																			
2	JOG	JOG operation mode																																																			
3	S	Incremental feed mode																																																			
4	/	Reserved																																																			
5																																																					
5	LIP	Linear interpolation mode																																																			
6	DST	Home position reset mode																																																			
7	/	Reserved																																																			
Bit No.	Abbreviation	Signal name																																																			
8	/	Reserved																																																			
9																																																					
10																																																					
11																																																					
12																																																					
13																																																					
14																																																					
15																																																					
0382	<table border="1"> <thead> <tr> <th>Bit No.</th> <th>Abbreviation</th> <th>Signal name</th> </tr> </thead> <tbody> <tr> <td>0</td> <td>ITL</td> <td>Interlock</td> </tr> <tr> <td>1</td> <td>RMONR</td> <td>High speed monitor latch command</td> </tr> <tr> <td>2</td> <td rowspan="2">/</td> <td rowspan="2">Reserved</td> </tr> <tr> <td>3</td> </tr> <tr> <td>4</td> <td>LSPC</td> <td>+ side limit switch input</td> </tr> <tr> <td>5</td> <td>LSNC</td> <td>- side limit switch input</td> </tr> <tr> <td>6</td> <td>DOGC</td> <td>Proximity dog input</td> </tr> <tr> <td>7</td> <td rowspan="2">/</td> <td rowspan="2">Reserved</td> </tr> <tr> <td></td> </tr> </tbody> </table>			Bit No.	Abbreviation	Signal name	0	ITL	Interlock	1	RMONR	High speed monitor latch command	2	/	Reserved	3	4	LSPC	+ side limit switch input	5	LSNC	- side limit switch input	6	DOGC	Proximity dog input	7	/	Reserved		<table border="1"> <thead> <tr> <th>Bit No.</th> <th>Abbreviation</th> <th>Signal name</th> </tr> </thead> <tbody> <tr> <td>8</td> <td>SCHG</td> <td>Change speed</td> </tr> <tr> <td>9</td> <td>TACHG</td> <td>Change acceleration time constant</td> </tr> <tr> <td>10</td> <td>TDCHG</td> <td>Change deceleration time constant</td> </tr> <tr> <td>11</td> <td>PCHG</td> <td>Position change</td> </tr> <tr> <td>12</td> <td rowspan="4">/</td> <td rowspan="4">Reserved</td> </tr> <tr> <td>13</td> </tr> <tr> <td>14</td> </tr> <tr> <td>15</td> </tr> </tbody> </table>			Bit No.	Abbreviation	Signal name	8	SCHG	Change speed	9	TACHG	Change acceleration time constant	10	TDCHG	Change deceleration time constant	11	PCHG	Position change	12	/	Reserved	13	14	15
	Bit No.	Abbreviation	Signal name																																																		
0	ITL	Interlock																																																			
1	RMONR	High speed monitor latch command																																																			
2	/	Reserved																																																			
3																																																					
4	LSPC	+ side limit switch input																																																			
5	LSNC	- side limit switch input																																																			
6	DOGC	Proximity dog input																																																			
7	/	Reserved																																																			
Bit No.	Abbreviation	Signal name																																																			
8	SCHG	Change speed																																																			
9	TACHG	Change acceleration time constant																																																			
10	TDCHG	Change deceleration time constant																																																			
11	PCHG	Position change																																																			
12	/	Reserved																																																			
13																																																					
14																																																					
15																																																					
0383	<table border="1"> <thead> <tr> <th>Bit No.</th> <th>Abbreviation</th> <th>Signal name</th> </tr> </thead> <tbody> <tr> <td>0</td> <td>FST</td> <td>Fast start operation</td> </tr> <tr> <td>1</td> <td rowspan="7">/</td> <td rowspan="7">Reserved</td> </tr> <tr> <td>2</td> </tr> <tr> <td>3</td> </tr> <tr> <td>4</td> </tr> <tr> <td>5</td> </tr> <tr> <td>6</td> </tr> <tr> <td>7</td> </tr> </tbody> </table>			Bit No.	Abbreviation	Signal name	0	FST	Fast start operation	1	/	Reserved	2	3	4	5	6	7	<table border="1"> <thead> <tr> <th>Bit No.</th> <th>Abbreviation</th> <th>Signal name</th> </tr> </thead> <tbody> <tr> <td>8</td> <td>PPISTP</td> <td>Pass position interrupt cancel</td> </tr> <tr> <td>9</td> <td rowspan="7">/</td> <td rowspan="7">Reserved</td> </tr> <tr> <td>10</td> </tr> <tr> <td>11</td> </tr> <tr> <td>12</td> </tr> <tr> <td>13</td> </tr> <tr> <td>14</td> </tr> <tr> <td>15</td> </tr> </tbody> </table>			Bit No.	Abbreviation	Signal name	8	PPISTP	Pass position interrupt cancel	9	/	Reserved	10	11	12	13	14	15																	
	Bit No.	Abbreviation	Signal name																																																		
0	FST	Fast start operation																																																			
1	/	Reserved																																																			
2																																																					
3																																																					
4																																																					
5																																																					
6																																																					
7																																																					
Bit No.	Abbreviation	Signal name																																																			
8	PPISTP	Pass position interrupt cancel																																																			
9	/	Reserved																																																			
10																																																					
11																																																					
12																																																					
13																																																					
14																																																					
15																																																					

7. AUXILIARY FUNCTION

Monitor No.	Content																																																						
0384	<table border="1"> <thead> <tr> <th>Bit No.</th> <th>Abbreviation</th> <th>Signal name</th> </tr> </thead> <tbody> <tr> <td>0</td> <td>GAIN</td> <td>Gain switching command</td> </tr> <tr> <td>1</td> <td>FCLS</td> <td>Fully closed loop control change command</td> </tr> <tr> <td>2</td> <td></td> <td>Reserved</td> </tr> <tr> <td>3</td> <td>CPC</td> <td>PID control command</td> </tr> <tr> <td>4</td> <td></td> <td rowspan="4">Reserved</td> </tr> <tr> <td>5</td> <td></td> </tr> <tr> <td>6</td> <td></td> </tr> <tr> <td>7</td> <td></td> </tr> </tbody> </table>			Bit No.	Abbreviation	Signal name	0	GAIN	Gain switching command	1	FCLS	Fully closed loop control change command	2		Reserved	3	CPC	PID control command	4		Reserved	5		6		7		<table border="1"> <thead> <tr> <th>Bit No.</th> <th>Abbreviation</th> <th>Signal name</th> </tr> </thead> <tbody> <tr> <td>8</td> <td></td> <td rowspan="8">Reserved</td> </tr> <tr> <td>9</td> <td></td> </tr> <tr> <td>10</td> <td></td> </tr> <tr> <td>11</td> <td></td> </tr> <tr> <td>12</td> <td></td> </tr> <tr> <td>13</td> <td></td> </tr> <tr> <td>14</td> <td></td> </tr> <tr> <td>15</td> <td></td> </tr> </tbody> </table>			Bit No.	Abbreviation	Signal name	8		Reserved	9		10		11		12		13		14		15						
	Bit No.	Abbreviation	Signal name																																																				
0	GAIN	Gain switching command																																																					
1	FCLS	Fully closed loop control change command																																																					
2		Reserved																																																					
3	CPC	PID control command																																																					
4		Reserved																																																					
5																																																							
6																																																							
7																																																							
Bit No.	Abbreviation	Signal name																																																					
8		Reserved																																																					
9																																																							
10																																																							
11																																																							
12																																																							
13																																																							
14																																																							
15																																																							
0385	<table border="1"> <thead> <tr> <th>Bit No.</th> <th>Abbreviation</th> <th>Signal name</th> </tr> </thead> <tbody> <tr> <td>0</td> <td></td> <td rowspan="4">Reserved</td> </tr> <tr> <td>1</td> <td></td> </tr> <tr> <td>2</td> <td></td> </tr> <tr> <td>3</td> <td></td> </tr> <tr> <td>4</td> <td>ZSC</td> <td>Home position set command</td> </tr> <tr> <td>5</td> <td></td> <td rowspan="3">Reserved</td> </tr> <tr> <td>6</td> <td></td> </tr> <tr> <td>7</td> <td></td> </tr> </tbody> </table>			Bit No.	Abbreviation	Signal name	0		Reserved	1		2		3		4	ZSC	Home position set command	5		Reserved	6		7		<table border="1"> <thead> <tr> <th>Bit No.</th> <th>Abbreviation</th> <th>Signal name</th> </tr> </thead> <tbody> <tr> <td>8</td> <td></td> <td>Reserved</td> </tr> <tr> <td>9</td> <td>MKC1</td> <td>Mark detection clear command 1</td> </tr> <tr> <td>10</td> <td>MKD1</td> <td>Mark detection disable command 1</td> </tr> <tr> <td>11</td> <td>MKSEN1</td> <td>Mark detection setting enable command 1</td> </tr> <tr> <td>12</td> <td></td> <td>Reserved</td> </tr> <tr> <td>13</td> <td>MKC2</td> <td>Mark detection clear command 2</td> </tr> <tr> <td>14</td> <td>MKD2</td> <td>Mark detection disable command 2</td> </tr> <tr> <td>15</td> <td>MKSEN2</td> <td>Mark detection setting enable command 2</td> </tr> </tbody> </table>			Bit No.	Abbreviation	Signal name	8		Reserved	9	MKC1	Mark detection clear command 1	10	MKD1	Mark detection disable command 1	11	MKSEN1	Mark detection setting enable command 1	12		Reserved	13	MKC2	Mark detection clear command 2	14	MKD2	Mark detection disable command 2	15	MKSEN2	Mark detection setting enable command 2
	Bit No.	Abbreviation	Signal name																																																				
0		Reserved																																																					
1																																																							
2																																																							
3																																																							
4	ZSC	Home position set command																																																					
5		Reserved																																																					
6																																																							
7																																																							
Bit No.	Abbreviation	Signal name																																																					
8		Reserved																																																					
9	MKC1	Mark detection clear command 1																																																					
10	MKD1	Mark detection disable command 1																																																					
11	MKSEN1	Mark detection setting enable command 1																																																					
12		Reserved																																																					
13	MKC2	Mark detection clear command 2																																																					
14	MKD2	Mark detection disable command 2																																																					
15	MKSEN2	Mark detection setting enable command 2																																																					
0386	<table border="1"> <thead> <tr> <th>Bit No.</th> <th>Abbreviation</th> <th>Signal name</th> </tr> </thead> <tbody> <tr> <td>0</td> <td></td> <td rowspan="4">Reserved</td> </tr> <tr> <td>1</td> <td></td> </tr> <tr> <td>2</td> <td></td> </tr> <tr> <td>3</td> <td></td> </tr> <tr> <td>4</td> <td>CTLMC</td> <td>Control mode switch command</td> </tr> <tr> <td>5</td> <td></td> <td rowspan="3">Reserved</td> </tr> <tr> <td>6</td> <td></td> </tr> <tr> <td>7</td> <td></td> </tr> </tbody> </table>			Bit No.	Abbreviation	Signal name	0		Reserved	1		2		3		4	CTLMC	Control mode switch command	5		Reserved	6		7		<table border="1"> <thead> <tr> <th>Bit No.</th> <th>Abbreviation</th> <th>Signal name</th> </tr> </thead> <tbody> <tr> <td>8</td> <td></td> <td rowspan="8">Reserved</td> </tr> <tr> <td>9</td> <td></td> </tr> <tr> <td>10</td> <td></td> </tr> <tr> <td>11</td> <td></td> </tr> <tr> <td>12</td> <td></td> </tr> <tr> <td>13</td> <td></td> </tr> <tr> <td>14</td> <td></td> </tr> <tr> <td>15</td> <td></td> </tr> </tbody> </table>			Bit No.	Abbreviation	Signal name	8		Reserved	9		10		11		12		13		14		15								
	Bit No.	Abbreviation	Signal name																																																				
0		Reserved																																																					
1																																																							
2																																																							
3																																																							
4	CTLMC	Control mode switch command																																																					
5		Reserved																																																					
6																																																							
7																																																							
Bit No.	Abbreviation	Signal name																																																					
8		Reserved																																																					
9																																																							
10																																																							
11																																																							
12																																																							
13																																																							
14																																																							
15																																																							
0387	<table border="1"> <thead> <tr> <th>Bit No.</th> <th>Abbreviation</th> <th>Signal name</th> </tr> </thead> <tbody> <tr> <td>0</td> <td></td> <td rowspan="8">Reserved</td> </tr> <tr> <td>1</td> <td></td> </tr> <tr> <td>2</td> <td></td> </tr> <tr> <td>3</td> <td></td> </tr> <tr> <td>4</td> <td></td> </tr> <tr> <td>5</td> <td></td> </tr> <tr> <td>6</td> <td></td> </tr> <tr> <td>7</td> <td></td> </tr> </tbody> </table>			Bit No.	Abbreviation	Signal name	0		Reserved	1		2		3		4		5		6		7		<table border="1"> <thead> <tr> <th>Bit No.</th> <th>Abbreviation</th> <th>Signal name</th> </tr> </thead> <tbody> <tr> <td>8</td> <td></td> <td rowspan="8">Reserved</td> </tr> <tr> <td>9</td> <td></td> </tr> <tr> <td>10</td> <td></td> </tr> <tr> <td>11</td> <td></td> </tr> <tr> <td>12</td> <td></td> </tr> <tr> <td>13</td> <td></td> </tr> <tr> <td>14</td> <td></td> </tr> <tr> <td>15</td> <td></td> </tr> </tbody> </table>			Bit No.	Abbreviation	Signal name	8		Reserved	9		10		11		12		13		14		15										
	Bit No.	Abbreviation	Signal name																																																				
0		Reserved																																																					
1																																																							
2																																																							
3																																																							
4																																																							
5																																																							
6																																																							
7																																																							
Bit No.	Abbreviation	Signal name																																																					
8		Reserved																																																					
9																																																							
10																																																							
11																																																							
12																																																							
13																																																							
14																																																							
15																																																							

7. AUXILIARY FUNCTION

(b) Axis data status bit

Monitor No.	Content																																																											
03A0	<table border="1"> <thead> <tr> <th>Bit No.</th> <th>Abbreviation</th> <th>Signal name</th> </tr> </thead> <tbody> <tr><td>0</td><td>RDY</td><td>Servo ready</td></tr> <tr><td>1</td><td>INP</td><td>In-position</td></tr> <tr><td>2</td><td>ZSP</td><td>Zero speed</td></tr> <tr><td>3</td><td>ZPAS</td><td>Passed Z-phase</td></tr> <tr><td>4</td><td>TLC</td><td>Torque limit effective</td></tr> <tr><td>5</td><td>SALM</td><td>Servo alarm</td></tr> <tr><td>6</td><td>SWRN</td><td>Servo warning</td></tr> <tr><td>7</td><td>ABSE</td><td>Absolute position erased</td></tr> </tbody> </table>			Bit No.	Abbreviation	Signal name	0	RDY	Servo ready	1	INP	In-position	2	ZSP	Zero speed	3	ZPAS	Passed Z-phase	4	TLC	Torque limit effective	5	SALM	Servo alarm	6	SWRN	Servo warning	7	ABSE	Absolute position erased	<table border="1"> <thead> <tr> <th>Bit No.</th> <th>Abbreviation</th> <th>Signal name</th> </tr> </thead> <tbody> <tr><td>8</td><td>OP</td><td>During operation</td></tr> <tr><td>9</td><td>CPO</td><td>Rough match</td></tr> <tr><td>10</td><td>PF</td><td>Positioning complete</td></tr> <tr><td>11</td><td>ZP</td><td>Home position return complete</td></tr> <tr><td>12</td><td>SMZ</td><td>During smoothing of stopping</td></tr> <tr><td>13</td><td>OALM</td><td>Operation alarm</td></tr> <tr><td>14</td><td>OPF</td><td>Completion of operation</td></tr> <tr><td>15</td><td>PSW</td><td>Position switch</td></tr> </tbody> </table>			Bit No.	Abbreviation	Signal name	8	OP	During operation	9	CPO	Rough match	10	PF	Positioning complete	11	ZP	Home position return complete	12	SMZ	During smoothing of stopping	13	OALM	Operation alarm	14	OPF	Completion of operation	15	PSW	Position switch
	Bit No.	Abbreviation	Signal name																																																									
0	RDY	Servo ready																																																										
1	INP	In-position																																																										
2	ZSP	Zero speed																																																										
3	ZPAS	Passed Z-phase																																																										
4	TLC	Torque limit effective																																																										
5	SALM	Servo alarm																																																										
6	SWRN	Servo warning																																																										
7	ABSE	Absolute position erased																																																										
Bit No.	Abbreviation	Signal name																																																										
8	OP	During operation																																																										
9	CPO	Rough match																																																										
10	PF	Positioning complete																																																										
11	ZP	Home position return complete																																																										
12	SMZ	During smoothing of stopping																																																										
13	OALM	Operation alarm																																																										
14	OPF	Completion of operation																																																										
15	PSW	Position switch																																																										
03A1	<table border="1"> <thead> <tr> <th>Bit No.</th> <th>Abbreviation</th> <th>Signal name</th> </tr> </thead> <tbody> <tr><td>0</td><td>AUTO</td><td>In automatic operation mode</td></tr> <tr><td>1</td><td>ZRNO</td><td>In home position return mode</td></tr> <tr><td>2</td><td>JO</td><td>In JOG operation mode</td></tr> <tr><td>3</td><td>SO</td><td>In incremental feed mode</td></tr> <tr><td>4</td><td></td><td>Reserved</td></tr> <tr><td>5</td><td>LIPO</td><td>In linear interpolation mode</td></tr> <tr><td>6</td><td>DSTO</td><td>In home position reset mode</td></tr> <tr><td>7</td><td></td><td>Reserved</td></tr> </tbody> </table>			Bit No.	Abbreviation	Signal name	0	AUTO	In automatic operation mode	1	ZRNO	In home position return mode	2	JO	In JOG operation mode	3	SO	In incremental feed mode	4		Reserved	5	LIPO	In linear interpolation mode	6	DSTO	In home position reset mode	7		Reserved	<table border="1"> <thead> <tr> <th>Bit No.</th> <th>Abbreviation</th> <th>Signal name</th> </tr> </thead> <tbody> <tr><td>8</td><td></td><td rowspan="8">Reserved</td></tr> <tr><td>9</td><td></td></tr> <tr><td>10</td><td></td></tr> <tr><td>11</td><td></td></tr> <tr><td>12</td><td></td></tr> <tr><td>13</td><td></td></tr> <tr><td>14</td><td></td></tr> <tr><td>15</td><td></td></tr> </tbody> </table>			Bit No.	Abbreviation	Signal name	8		Reserved	9		10		11		12		13		14		15								
	Bit No.	Abbreviation	Signal name																																																									
0	AUTO	In automatic operation mode																																																										
1	ZRNO	In home position return mode																																																										
2	JO	In JOG operation mode																																																										
3	SO	In incremental feed mode																																																										
4		Reserved																																																										
5	LIPO	In linear interpolation mode																																																										
6	DSTO	In home position reset mode																																																										
7		Reserved																																																										
Bit No.	Abbreviation	Signal name																																																										
8		Reserved																																																										
9																																																												
10																																																												
11																																																												
12																																																												
13																																																												
14																																																												
15																																																												
03A2	<table border="1"> <thead> <tr> <th>Bit No.</th> <th>Abbreviation</th> <th>Signal name</th> </tr> </thead> <tbody> <tr><td>0</td><td>ISTP</td><td>Interlock stop</td></tr> <tr><td>1</td><td>RMRCH</td><td>High speed monitor is latched</td></tr> <tr><td>2</td><td>POV</td><td>Stop position over-bound</td></tr> <tr><td>3</td><td>STO</td><td>Start up acceptance complete</td></tr> <tr><td>4</td><td></td><td rowspan="2">Reserved</td></tr> <tr><td>5</td><td></td></tr> <tr><td>6</td><td>ZREQ</td><td>Home position return request</td></tr> <tr><td>7</td><td></td><td>Reserved</td></tr> </tbody> </table>			Bit No.	Abbreviation	Signal name	0	ISTP	Interlock stop	1	RMRCH	High speed monitor is latched	2	POV	Stop position over-bound	3	STO	Start up acceptance complete	4		Reserved	5		6	ZREQ	Home position return request	7		Reserved	<table border="1"> <thead> <tr> <th>Bit No.</th> <th>Abbreviation</th> <th>Signal name</th> </tr> </thead> <tbody> <tr><td>8</td><td>SCF</td><td>Completion of preparation for changing speed</td></tr> <tr><td>9</td><td>TACF</td><td>Completion of preparation for changing acceleration time constant</td></tr> <tr><td>10</td><td>TDCF</td><td>Completion of preparation for changing deceleration time constant</td></tr> <tr><td>11</td><td>PCF</td><td>Completion of preparation for changing position</td></tr> <tr><td>12</td><td>SCE</td><td>Speed change error</td></tr> <tr><td>13</td><td>TACE</td><td>Acceleration time constant change error</td></tr> <tr><td>14</td><td>TDCE</td><td>Deceleration time constant change error</td></tr> <tr><td>15</td><td>PCE</td><td>Position change error</td></tr> </tbody> </table>			Bit No.	Abbreviation	Signal name	8	SCF	Completion of preparation for changing speed	9	TACF	Completion of preparation for changing acceleration time constant	10	TDCF	Completion of preparation for changing deceleration time constant	11	PCF	Completion of preparation for changing position	12	SCE	Speed change error	13	TACE	Acceleration time constant change error	14	TDCE	Deceleration time constant change error	15	PCE	Position change error	
	Bit No.	Abbreviation	Signal name																																																									
0	ISTP	Interlock stop																																																										
1	RMRCH	High speed monitor is latched																																																										
2	POV	Stop position over-bound																																																										
3	STO	Start up acceptance complete																																																										
4		Reserved																																																										
5																																																												
6	ZREQ	Home position return request																																																										
7		Reserved																																																										
Bit No.	Abbreviation	Signal name																																																										
8	SCF	Completion of preparation for changing speed																																																										
9	TACF	Completion of preparation for changing acceleration time constant																																																										
10	TDCF	Completion of preparation for changing deceleration time constant																																																										
11	PCF	Completion of preparation for changing position																																																										
12	SCE	Speed change error																																																										
13	TACE	Acceleration time constant change error																																																										
14	TDCE	Deceleration time constant change error																																																										
15	PCE	Position change error																																																										
03A3	<table border="1"> <thead> <tr> <th>Bit No.</th> <th>Abbreviation</th> <th>Signal name</th> </tr> </thead> <tbody> <tr><td>0</td><td></td><td rowspan="8">Reserved</td></tr> <tr><td>1</td><td></td></tr> <tr><td>2</td><td></td></tr> <tr><td>3</td><td></td></tr> <tr><td>4</td><td></td></tr> <tr><td>5</td><td></td></tr> <tr><td>6</td><td></td></tr> <tr><td>7</td><td></td></tr> </tbody> </table>			Bit No.	Abbreviation	Signal name	0		Reserved	1		2		3		4		5		6		7		<table border="1"> <thead> <tr> <th>Bit No.</th> <th>Abbreviation</th> <th>Signal name</th> </tr> </thead> <tbody> <tr><td>8</td><td>PPIOP</td><td>Pass position interrupt</td></tr> <tr><td>9</td><td>PPIFIN</td><td>Pass position interrupt complete</td></tr> <tr><td>10</td><td>PPIERR</td><td>Pass position interrupt incomplete</td></tr> <tr><td>11</td><td></td><td rowspan="4">Reserved</td></tr> <tr><td>12</td><td></td></tr> <tr><td>13</td><td></td></tr> <tr><td>14</td><td></td></tr> <tr><td>15</td><td>AUTLO</td><td>In point table loop</td></tr> </tbody> </table>			Bit No.	Abbreviation	Signal name	8	PPIOP	Pass position interrupt	9	PPIFIN	Pass position interrupt complete	10	PPIERR	Pass position interrupt incomplete	11		Reserved	12		13		14		15	AUTLO	In point table loop										
	Bit No.	Abbreviation	Signal name																																																									
0		Reserved																																																										
1																																																												
2																																																												
3																																																												
4																																																												
5																																																												
6																																																												
7																																																												
Bit No.	Abbreviation	Signal name																																																										
8	PPIOP	Pass position interrupt																																																										
9	PPIFIN	Pass position interrupt complete																																																										
10	PPIERR	Pass position interrupt incomplete																																																										
11		Reserved																																																										
12																																																												
13																																																												
14																																																												
15	AUTLO	In point table loop																																																										

7. AUXILIARY FUNCTION

Monitor No.	Content																																																			
03A4	<table border="1"> <thead> <tr> <th>Bit No.</th> <th>Abbreviation</th> <th>Signal name</th> </tr> </thead> <tbody> <tr> <td>0</td> <td>GAINO</td> <td>During gain switching</td> </tr> <tr> <td>1</td> <td>FCLSO</td> <td>Fully closed loop control changing</td> </tr> <tr> <td>2</td> <td>TLSO</td> <td>Selecting torque limit</td> </tr> <tr> <td>3</td> <td>SPC</td> <td>During PID control</td> </tr> <tr> <td>4</td> <td rowspan="3"></td> <td rowspan="3">Reserved</td> </tr> <tr> <td>5</td> </tr> <tr> <td>6</td> </tr> <tr> <td>7</td> <td>PRSMO</td> <td>During continuous operation to torque control</td> </tr> </tbody> </table>			Bit No.	Abbreviation	Signal name	0	GAINO	During gain switching	1	FCLSO	Fully closed loop control changing	2	TLSO	Selecting torque limit	3	SPC	During PID control	4		Reserved	5	6	7	PRSMO	During continuous operation to torque control	<table border="1"> <thead> <tr> <th>Bit No.</th> <th>Abbreviation</th> <th>Signal name</th> </tr> </thead> <tbody> <tr> <td>8</td> <td>IWT</td> <td>Interference check standby</td> </tr> <tr> <td>9</td> <td>SINP</td> <td>Servo amplifier in-position</td> </tr> <tr> <td>10</td> <td rowspan="6"></td> <td rowspan="6">Reserved</td> </tr> <tr> <td>11</td> </tr> <tr> <td>12</td> </tr> <tr> <td>13</td> </tr> <tr> <td>14</td> </tr> <tr> <td>15</td> </tr> </tbody> </table>			Bit No.	Abbreviation	Signal name	8	IWT	Interference check standby	9	SINP	Servo amplifier in-position	10		Reserved	11	12	13	14	15						
	Bit No.	Abbreviation	Signal name																																																	
0	GAINO	During gain switching																																																		
1	FCLSO	Fully closed loop control changing																																																		
2	TLSO	Selecting torque limit																																																		
3	SPC	During PID control																																																		
4		Reserved																																																		
5																																																				
6																																																				
7	PRSMO	During continuous operation to torque control																																																		
Bit No.	Abbreviation	Signal name																																																		
8	IWT	Interference check standby																																																		
9	SINP	Servo amplifier in-position																																																		
10		Reserved																																																		
11																																																				
12																																																				
13																																																				
14																																																				
15																																																				
03A5	<table border="1"> <thead> <tr> <th>Bit No.</th> <th>Abbreviation</th> <th>Signal name</th> </tr> </thead> <tbody> <tr> <td>0</td> <td rowspan="4"></td> <td rowspan="4">Reserved</td> </tr> <tr> <td>1</td> </tr> <tr> <td>2</td> </tr> <tr> <td>3</td> </tr> <tr> <td>4</td> <td>ZSF</td> <td>Home position set complete</td> </tr> <tr> <td>5</td> <td>ZSE</td> <td>Home position set error</td> </tr> <tr> <td>6</td> <td rowspan="2"></td> <td rowspan="2">Reserved</td> </tr> <tr> <td>7</td> </tr> </tbody> </table>			Bit No.	Abbreviation	Signal name	0		Reserved	1	2	3	4	ZSF	Home position set complete	5	ZSE	Home position set error	6		Reserved	7	<table border="1"> <thead> <tr> <th>Bit No.</th> <th>Abbreviation</th> <th>Signal name</th> </tr> </thead> <tbody> <tr> <td>8</td> <td>MKIF1</td> <td>Mark detection compatible information 1</td> </tr> <tr> <td>9</td> <td>MKCF1</td> <td>Mark detection clear complete 1</td> </tr> <tr> <td>10</td> <td>MKDO1</td> <td>Mark detection disabled 1</td> </tr> <tr> <td>11</td> <td>MKSEF1</td> <td>Mark detection setting enable complete 1</td> </tr> <tr> <td>12</td> <td>MKIF2</td> <td>Mark detection compatible information 2</td> </tr> <tr> <td>13</td> <td>MKCF2</td> <td>Mark detection clear complete 2</td> </tr> <tr> <td>14</td> <td>MKDO2</td> <td>Mark detection disabled 2</td> </tr> <tr> <td>15</td> <td>MKSEF2</td> <td>Mark detection setting enable complete 2</td> </tr> </tbody> </table>			Bit No.	Abbreviation	Signal name	8	MKIF1	Mark detection compatible information 1	9	MKCF1	Mark detection clear complete 1	10	MKDO1	Mark detection disabled 1	11	MKSEF1	Mark detection setting enable complete 1	12	MKIF2	Mark detection compatible information 2	13	MKCF2	Mark detection clear complete 2	14	MKDO2	Mark detection disabled 2	15	MKSEF2	Mark detection setting enable complete 2
	Bit No.	Abbreviation	Signal name																																																	
0		Reserved																																																		
1																																																				
2																																																				
3																																																				
4	ZSF	Home position set complete																																																		
5	ZSE	Home position set error																																																		
6		Reserved																																																		
7																																																				
Bit No.	Abbreviation	Signal name																																																		
8	MKIF1	Mark detection compatible information 1																																																		
9	MKCF1	Mark detection clear complete 1																																																		
10	MKDO1	Mark detection disabled 1																																																		
11	MKSEF1	Mark detection setting enable complete 1																																																		
12	MKIF2	Mark detection compatible information 2																																																		
13	MKCF2	Mark detection clear complete 2																																																		
14	MKDO2	Mark detection disabled 2																																																		
15	MKSEF2	Mark detection setting enable complete 2																																																		
03A6	<table border="1"> <thead> <tr> <th>Bit No.</th> <th>Abbreviation</th> <th>Signal name</th> </tr> </thead> <tbody> <tr> <td>0</td> <td rowspan="4"></td> <td rowspan="4">Reserved</td> </tr> <tr> <td>1</td> </tr> <tr> <td>2</td> </tr> <tr> <td>3</td> </tr> <tr> <td>4</td> <td>CTLMCF</td> <td>Control mode switch complete</td> </tr> <tr> <td>5</td> <td>CTLMCE</td> <td>Control mode switch error</td> </tr> <tr> <td>6</td> <td rowspan="2"></td> <td rowspan="2">Reserved</td> </tr> <tr> <td>7</td> </tr> </tbody> </table>			Bit No.	Abbreviation	Signal name	0		Reserved	1	2	3	4	CTLMCF	Control mode switch complete	5	CTLMCE	Control mode switch error	6		Reserved	7	<table border="1"> <thead> <tr> <th>Bit No.</th> <th>Abbreviation</th> <th>Signal name</th> </tr> </thead> <tbody> <tr> <td>8</td> <td rowspan="8"></td> <td rowspan="8">Reserved</td> </tr> <tr> <td>9</td> </tr> <tr> <td>10</td> </tr> <tr> <td>11</td> </tr> <tr> <td>12</td> </tr> <tr> <td>13</td> </tr> <tr> <td>14</td> </tr> <tr> <td>15</td> </tr> </tbody> </table>			Bit No.	Abbreviation	Signal name	8		Reserved	9	10	11	12	13	14	15														
	Bit No.	Abbreviation	Signal name																																																	
0		Reserved																																																		
1																																																				
2																																																				
3																																																				
4	CTLMCF	Control mode switch complete																																																		
5	CTLMCE	Control mode switch error																																																		
6		Reserved																																																		
7																																																				
Bit No.	Abbreviation	Signal name																																																		
8		Reserved																																																		
9																																																				
10																																																				
11																																																				
12																																																				
13																																																				
14																																																				
15																																																				
03A7	<table border="1"> <thead> <tr> <th>Bit No.</th> <th>Abbreviation</th> <th>Signal name</th> </tr> </thead> <tbody> <tr> <td>0</td> <td rowspan="8"></td> <td rowspan="8">Reserved</td> </tr> <tr> <td>1</td> </tr> <tr> <td>2</td> </tr> <tr> <td>3</td> </tr> <tr> <td>4</td> </tr> <tr> <td>5</td> </tr> <tr> <td>6</td> </tr> <tr> <td>7</td> </tr> </tbody> </table>			Bit No.	Abbreviation	Signal name	0		Reserved	1	2	3	4	5	6	7	<table border="1"> <thead> <tr> <th>Bit No.</th> <th>Abbreviation</th> <th>Signal name</th> </tr> </thead> <tbody> <tr> <td>8</td> <td rowspan="8"></td> <td rowspan="8">Reserved</td> </tr> <tr> <td>9</td> </tr> <tr> <td>10</td> </tr> <tr> <td>11</td> </tr> <tr> <td>12</td> </tr> <tr> <td>13</td> </tr> <tr> <td>14</td> </tr> <tr> <td>15</td> </tr> </tbody> </table>			Bit No.	Abbreviation	Signal name	8		Reserved	9	10	11	12	13	14	15																				
	Bit No.	Abbreviation	Signal name																																																	
0		Reserved																																																		
1																																																				
2																																																				
3																																																				
4																																																				
5																																																				
6																																																				
7																																																				
Bit No.	Abbreviation	Signal name																																																		
8		Reserved																																																		
9																																																				
10																																																				
11																																																				
12																																																				
13																																																				
14																																																				
15																																																				

7. AUXILIARY FUNCTION

POINT	
	<ul style="list-style-type: none">▪ Up to 3 items (total of sampling data and sampling bit information) can be specified for the servo information. If more than 4 items are set, sampling error (SMPE: ON) occurs when sampling is started and the bit of the sampling error information corresponding to the fourth item turns on. However, there is no restriction for the number of the items in the following servo information.<ul style="list-style-type: none">▪ Monitor No.0200 (position feedback (lower))▪ Monitor No.0201 (position feedback (upper))▪ Monitor No.0204 (position droop (lower))▪ Monitor No.0205 (position droop (upper))▪ Monitor No.020B (current feed back)▪ Monitor No.0220 to 023F (servo parameter error No.)

7. AUXILIARY FUNCTION

7.12.8 Sampling trigger

As a trigger for start of sampling, up to 8 conditions can be set. The case when one of the trigger conditions is met or when all of the trigger conditions are met can be set as a trigger. The data or the bit information trigger refers to are selected from set sampling items. There are 4 types of trigger conditions for each of the contents the trigger refers to. (Refer to the following.)

(1) When the trigger content is data

(a) Fulfilled when passing through trigger value in increase direction

When the data increases from lower than the trigger value to the trigger value or higher, the trigger condition is met.

Example 1

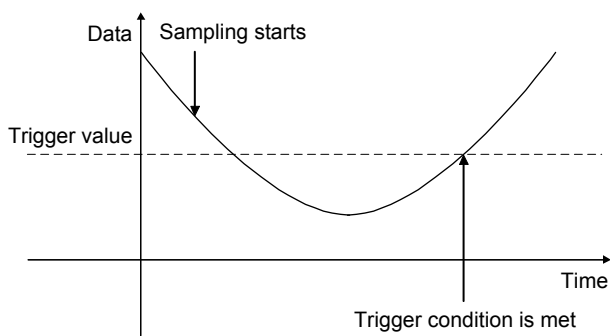

Example 2

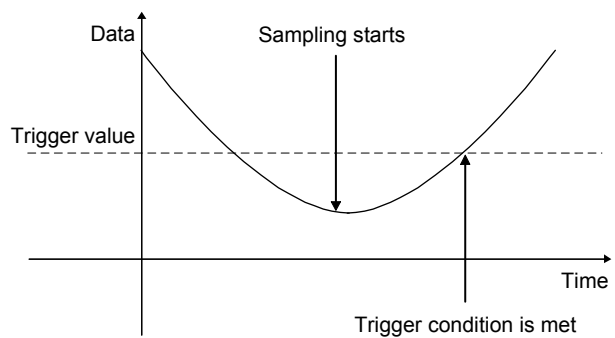

(b) Fulfilled when passing through trigger value in decrease direction

When the data decreases from higher than the trigger value to the trigger value or lower, the trigger condition is met.

Example 1

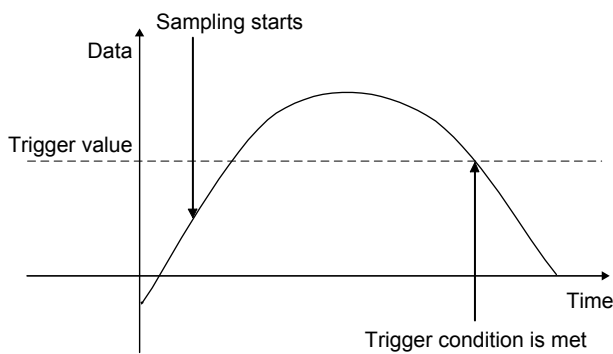

Example 2

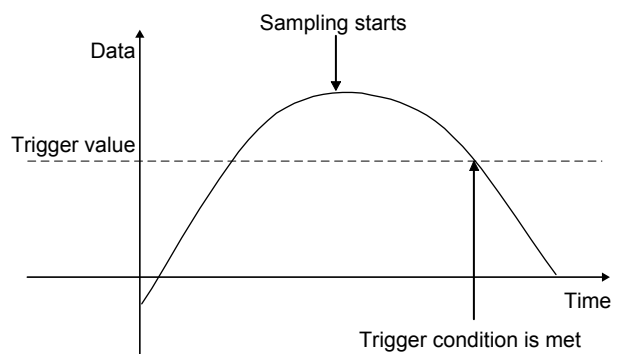

7. AUXILIARY FUNCTION

(c) Fulfilled when the data is the same as trigger value or higher

When the data is the same as the trigger value or higher, the trigger condition is met.

Example 1

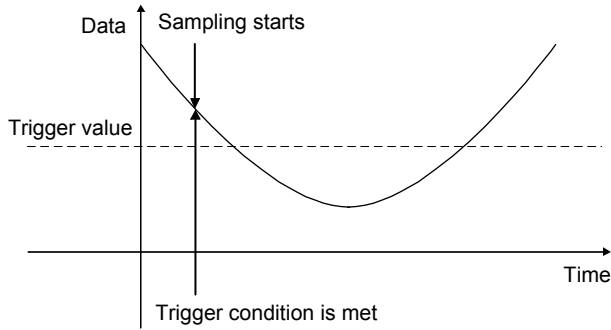

Example 2

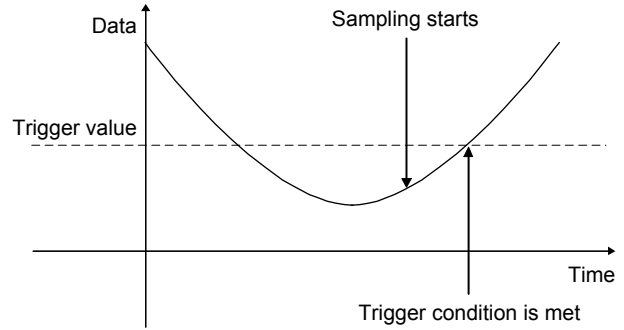

(d) Fulfilled when the data is the same as trigger value or lower

When the data is the same as the trigger value or lower, the trigger condition is met.

Example 1

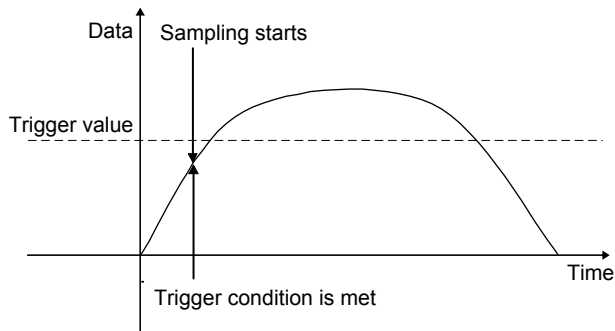

Example 2

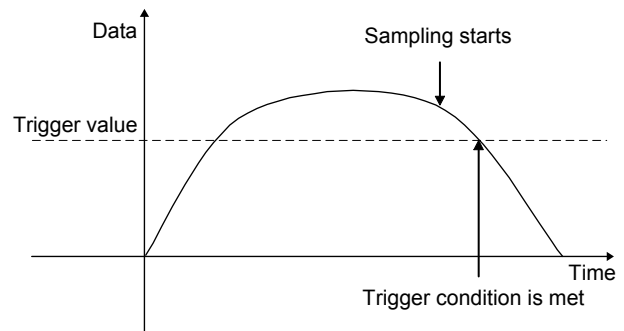

7. AUXILIARY FUNCTION

(2) When the trigger content is bit information

(a) Fulfilled by leading edge of bit

When the bit turns on from off, the trigger conditions are met.

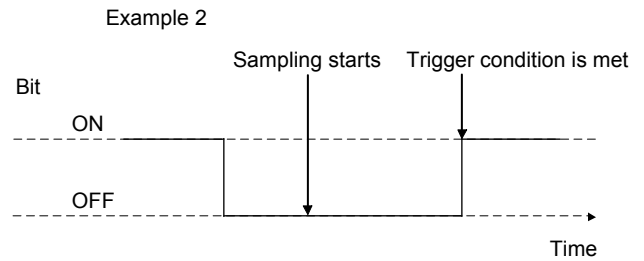
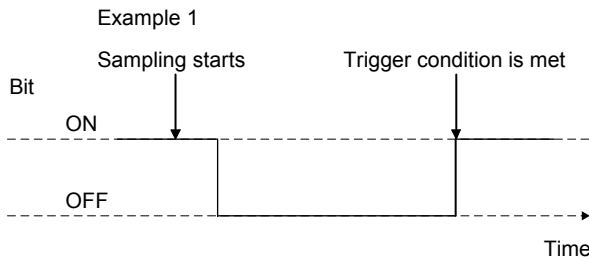

(b) Fulfilled by trailing edge of bit

When the bit turns off from on, the trigger conditions are met.

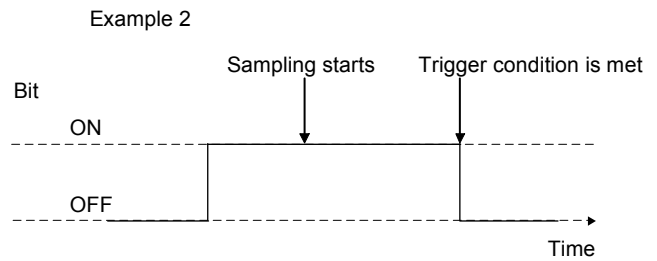
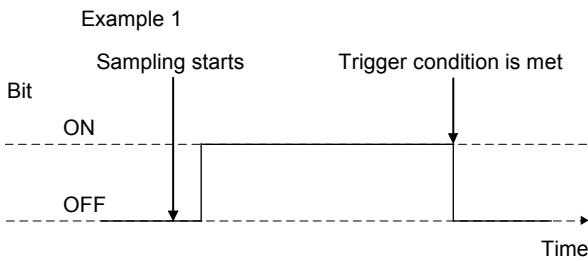

(c) Fulfilled while bit is on

While the bit is on, the trigger condition is met.

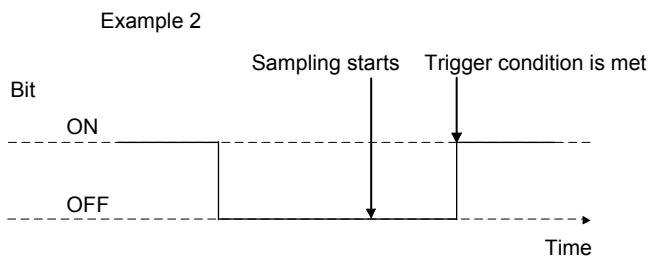
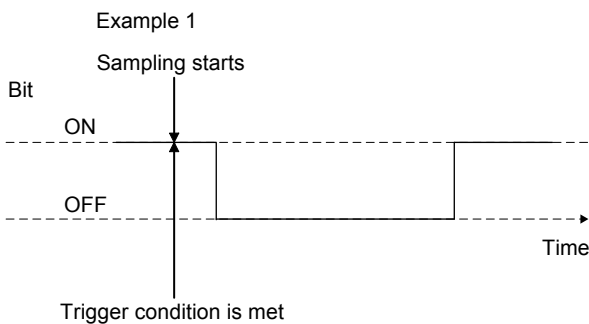

(d) Fulfilled while bit is off

While the bit is off, the trigger condition is met.

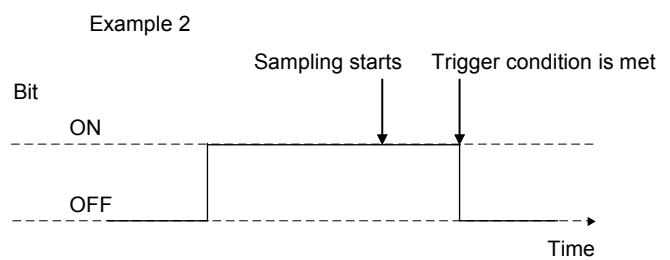
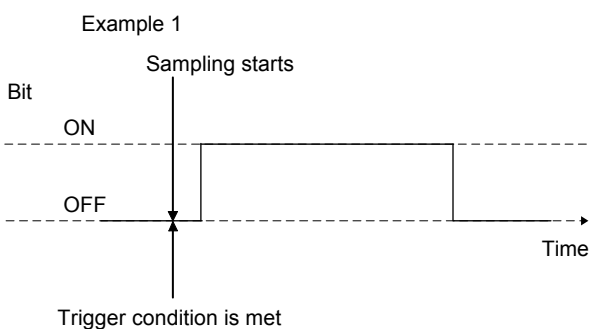

7. AUXILIARY FUNCTION

7.12.9 Sampling data read

Sampled data of 8192 points is stored in the sampling data buffer area of the Q173SCCF internal memory. Sampled data is transferred to the sampling data read area divided in units of a page (32 points/page). For the sampling data read during the sampling, refer to the Section 7.12.10.

(1) Sampling data read area

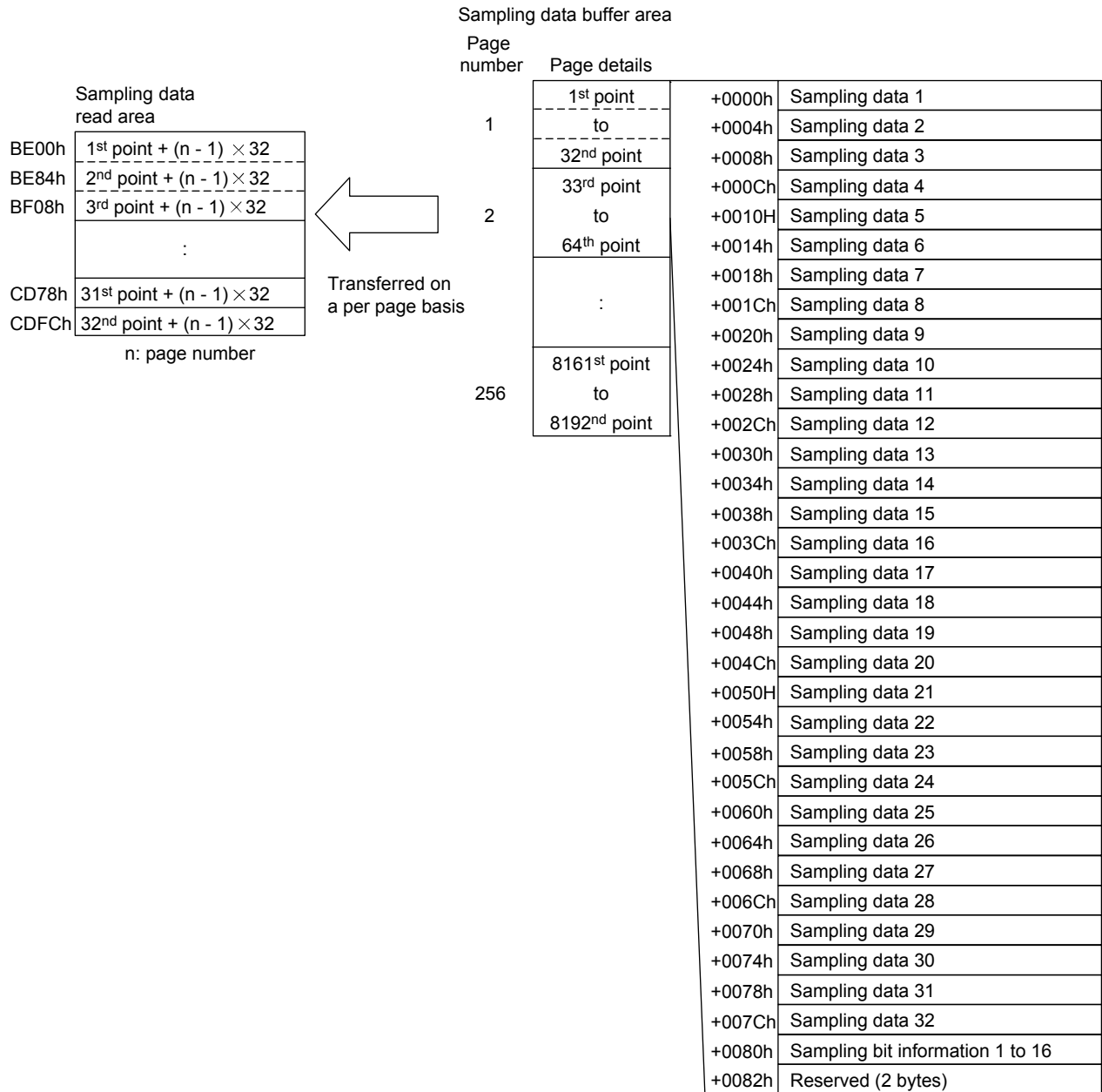

7. AUXILIARY FUNCTION

(2) A timing chart of reading of sampled data

To read the sampled data, set the page number to be transferred to the sample read page number. When detecting the change of the sampling read page number, the Q173SCCF transfers the sampled data corresponding to the page number to the sampling data read area and stores the points of data which are sampled in the page in the valid read sampled points.

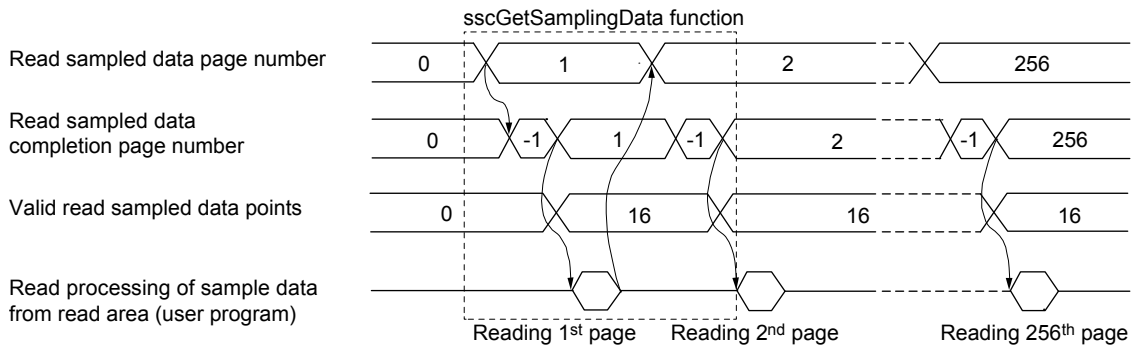

POINT
<ul style="list-style-type: none"> ▪ The read sampled data completion page number is -1 (during sampling data transferring) while the data is being transferred to the sampling data read area. ▪ When the sample read is executed in the following cases, read sampled data completion page number is -2 (sampling read error) and sampled data will not be read. <ul style="list-style-type: none"> ▪ When the sample read page number is incorrect ▪ When the next page number of the sampling completion page number is specified during sampling ▪ When the page number is changed from other than 0 to 0 during sampling, sampling is finished (sampling error (SMPE) turns on). The read sampled data completion page number becomes 0 and sampling data read area is cleared to 0. ▪ The change of sample read number is invalid while the data is being transferred to the sampling data read area (transferring the page number before changed is continued). After completion of the sample read, the sampled data of changed page number is started to be transferred. ▪ When 0 is set to the sampling read page number, sampling data read area is cleared to 0. ▪ The Q173SCCF does not start transferring sampled data until the sampling read page number is changed. When the same page number is needed to be set, such as to update the contents of the sampling data read area, set the sampling read page number to 0. After confirming the page number is 0, specify the page number to be transferred.

7. AUXILIARY FUNCTION

7.12.10 Timing chart for sampling function

A timing chart for the sampling function is shown below.

(1) When the number of sampled points is 8192 or less

1) When setting 8192 to the sampling points and starting sampling of 8192 points

To start the sampling, write the sampling setting previously and turn on the start sampling command (SMPS). When the start sampling command (SMPS) is accepted, the waiting for sampling trigger (SMPW) turns on. Then, after trigger conditions are met, the sampling is being performed (SMPO) turns on.

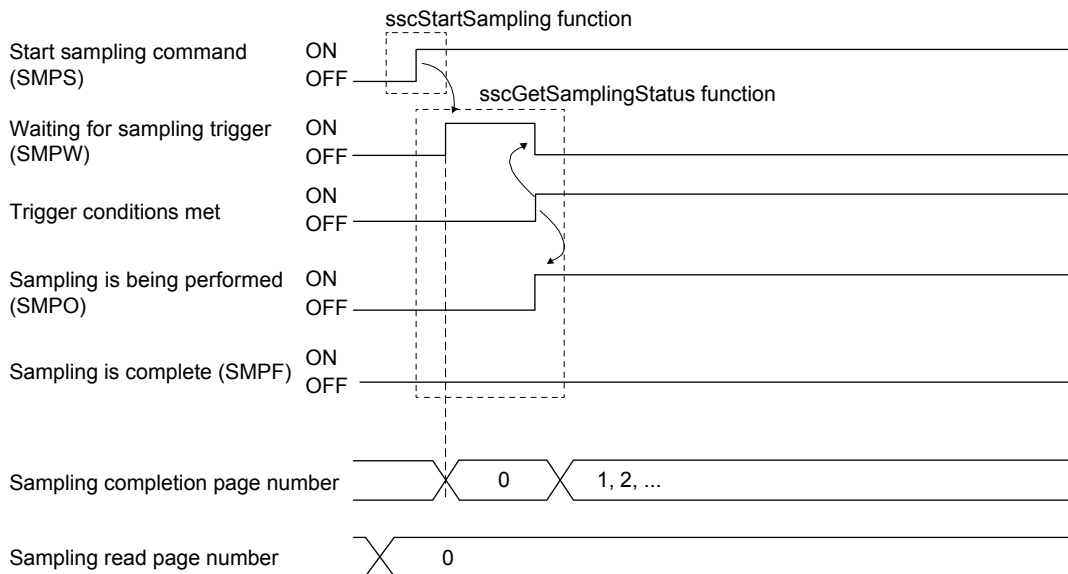

POINT
<ul style="list-style-type: none"> ▪ Turn on the start sampling (SMPS) after setting 0 to the sampling read page number. ▪ In the following cases, sampling error occurs (SMPE: ON). <ul style="list-style-type: none"> ▪ When the setting for the sampling option is outside of the setting range ▪ When the setting for the sampling data is outside of the setting range ▪ When the setting value for the sampling bit information is outside of the setting range ▪ When four or more monitor numbers for servo information are designated for the same axis ▪ When 0 is not set to the sampling read page number ▪ When a monitor number is designated for an axis for which communication with the servo amplifier has not been implemented, such as it is not the control axis or an amplifier-less axis, the data to be sampled is always 0 (for bit, off). (Sampling error (SMPE) and sampling error information do not turn on.)

7. AUXILIARY FUNCTION

2) When setting 8192 to the sampling points and sampling of 8192 points is completed

When the sampling of specified sampling points is completed, the sampling is completed (SMPF) turns on.

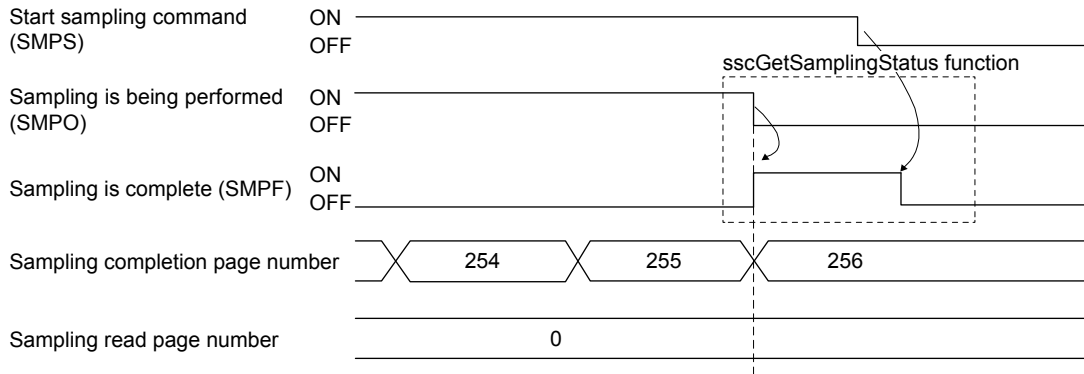

POINT

- In the timing chart above, since 8192 is the multiplication of 32, the valid sampled data (valid sampled read points) in the last page (page 256) are 1 to 32 points.

3) Sampling stopped prior to full completion

When the start sampling command (SMPS) is turned off during the sampling (SMPO: ON), the sampling is being performed (SMPO) turns off and the sampling finishes.

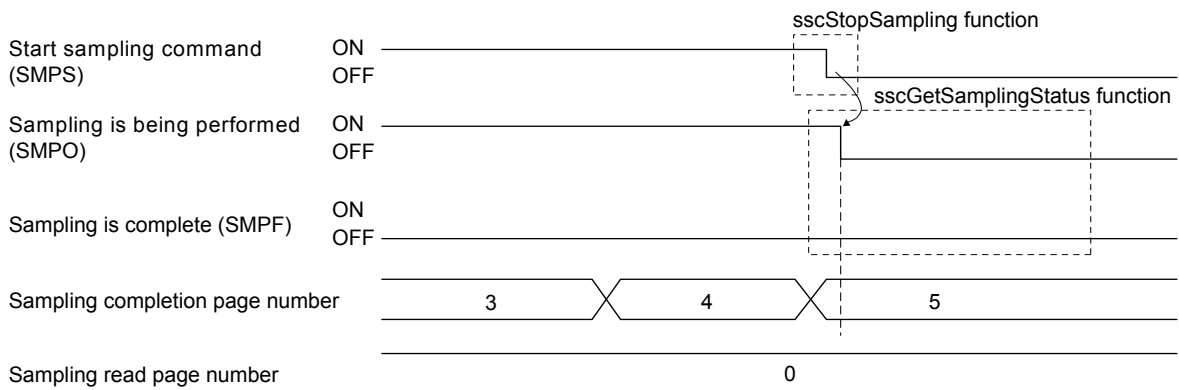

POINT

- The sampling is completed (SMPF) is not turned on.
- In the timing chart above, the sampling stopped in the 5 page. For the valid sampled data in the page, confirm the valid sampled read points at the sampling read.
- When sample data that is read is 0 for points outside of sample valid points.

7. AUXILIARY FUNCTION

4) When reading sampled data

After confirming the sampling is being performed (SMPO) is turned off, read the sampled data and valid read sampled points from the page 1 to the page of the sampling completion page number. Sampled data points in the page where the sampling read is completed is stored in the valid read sampled points.

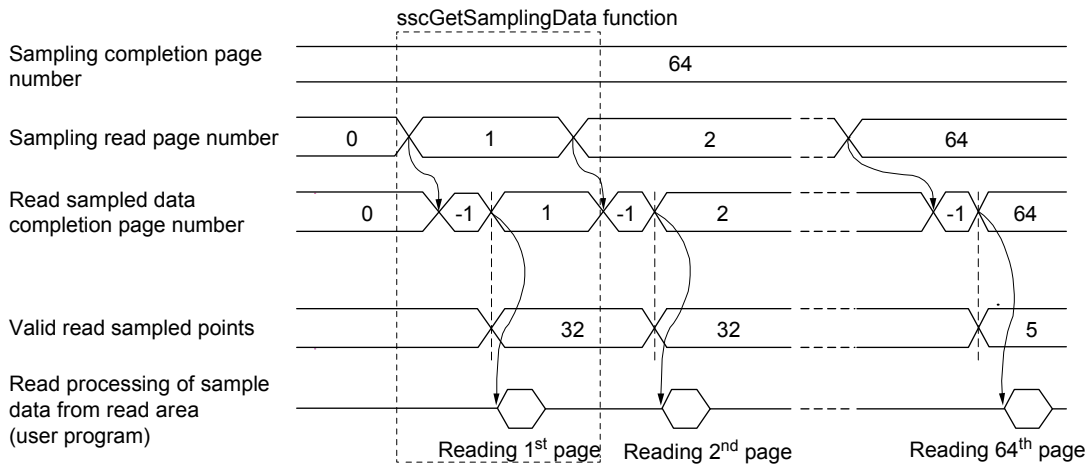

POINT

- In the timing chart above, the data is stored in the page 1 to 64, and the sampled data in the page 64 is valid from 1 to 5 points.
- When sample data that is read is 0 for points outside of sample valid points.
- In the following cases, the sampling read error (Read sampled data completion page number is -2) occurs.
 - When the setting for the sampling read page number is outside of the setting range
 - When the next page number of the sampling completion page number is specified during the sampling

7. AUXILIARY FUNCTION

(2) When the number of sampled points is 8193 or more

1) When starting the sampling

To start the sampling, write the sampling setting previously and turn on the start sampling command (SMPS). When the start sampling command (SMPS) is accepted, the waiting for sampling trigger (SMPW) turns on. Then, after trigger conditions are met, the sampling is being performed (SMPO) turns on.

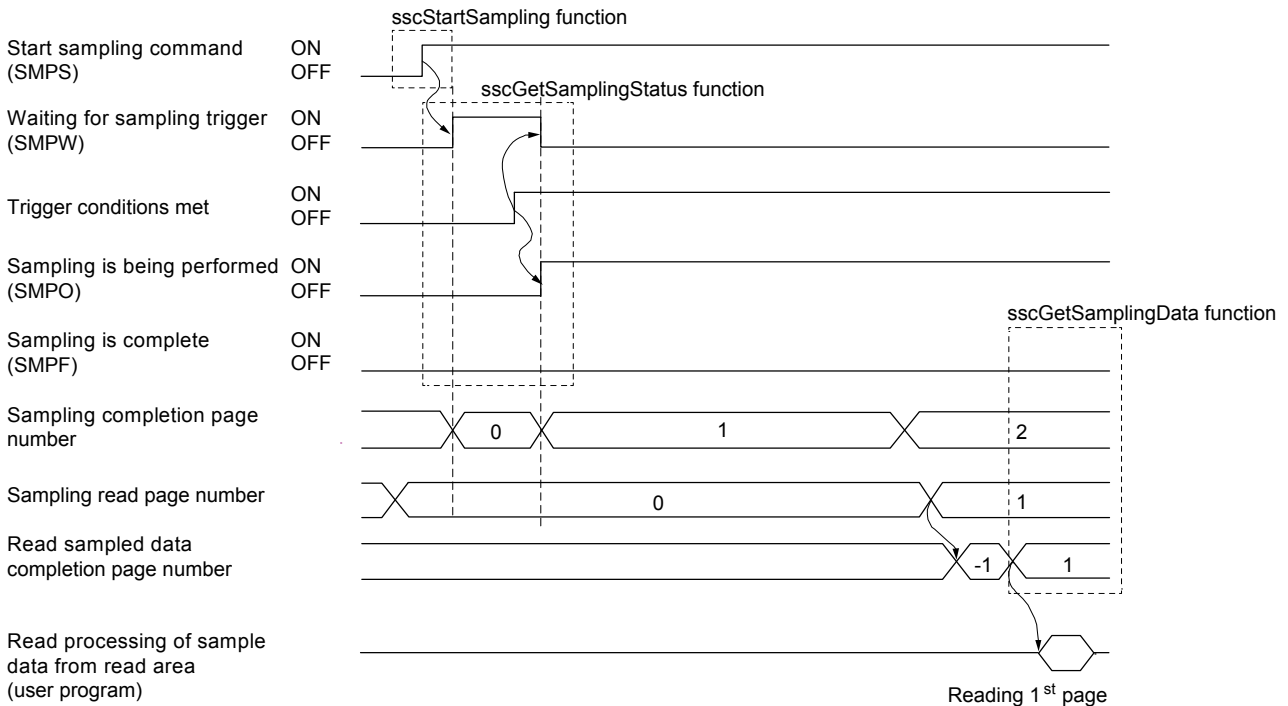

POINT

- Turn on the start sampling (SMPS) after setting 0 to the sampling read page number.
- In the following cases, sampling error occurs (SMPE: ON).
 - When the setting for the sampling option is outside of the setting range
 - When the setting for the sampling data is outside of the setting range
 - When the setting value for the sampling bit information is outside of the setting range
 - When four or more monitor numbers for servo information are designated for the same axis
 - When the sampling start signal (SMPS) is turned on when the read sampled data completion page number is -1
- When a monitor number is designated for an amplifier-less axis, the data to be sampled is always 0 (for bit, off).
(Sampling error (SMPE) and sampling error information do not turn on.)
- When a monitor number related to the servo information is designated for an axis for which communication with the servo amplifier has not been implemented, such as it is not the control axis, the corresponding sampling error information turns on (excluding the amplifier-less axis).
(The sampling error (SMPE) is not turned on.)

7. AUXILIARY FUNCTION

2) Sampling is being performed

The user program reads the sampled data sequentially according to the sampling completion page number.

The user program can read the page from the page of the sampling read page number to the page of the sampling completion page number in numerical order. The sampling data buffer area is a ring buffer of 256 pages. For example, when the sampling read page number is the page 254 and the sampling completion page number is the page 2, the pages 254, 255, 256, 1 and 2 can be read. When the sampling read page number differs from the sampling completion page number, the user program writes the next page number of the sampling read page number and executes the process of reading page.

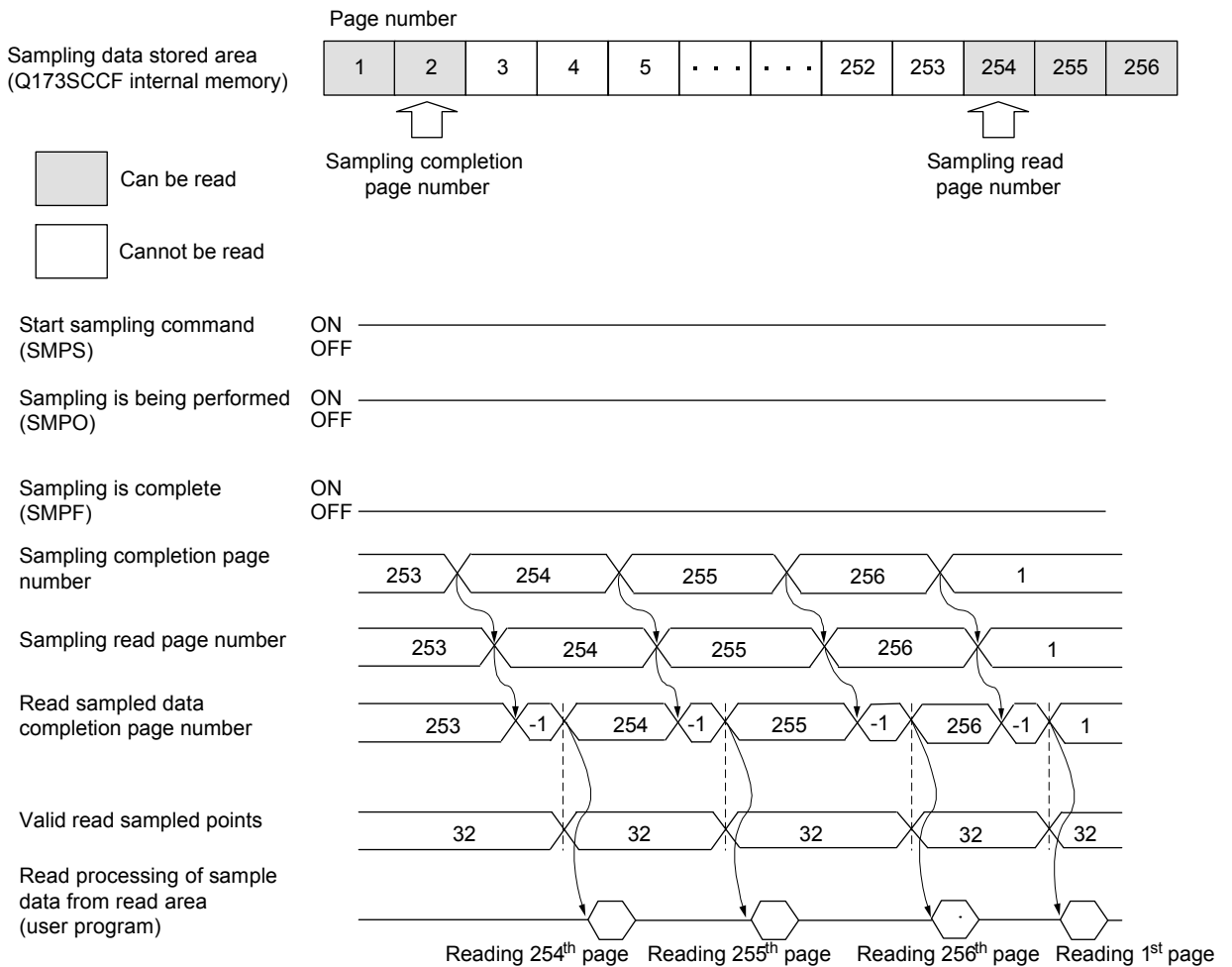

7. AUXILIARY FUNCTION

POINT	
	<ul style="list-style-type: none">▪ In the timing chart above, the sampling read page number differs from the sampling completion page number by 1 page, unless the next page number of the sampling completion page number becomes the sampling read page number, reading sampled data can be delayed.▪ In the following cases, the sampling read error (Read sampled data completion page number is -2) occurs.<ul style="list-style-type: none">▪ When the setting for the sampling read page number is outside of the setting range.▪ When the next page number of the sampling completion page number is specified during sampling.▪ In the following cases during the sampling, sampling error (SMPE: ON) occurs.<ul style="list-style-type: none">▪ When the next page number of the sampling completion page number is the same as the sampling read page number.▪ When the sampling completion page number switches to the page 256, with the sampling read page number remaining 0.▪ When the sampling read error (Read sampled data completion page number is -2) occurs.▪ When the page number is changed from other than 0 to 0 during the sampling. The read sampled data completion page number becomes 0 and sampling data read area is cleared to 0.

7. AUXILIARY FUNCTION

3) When the sampling is completed

When the sampling of specified points is completed, the sampling is complete (SMPF) turns on.

After confirming the sampling is complete (SMPF) turns on, read until the sampling completion page number.

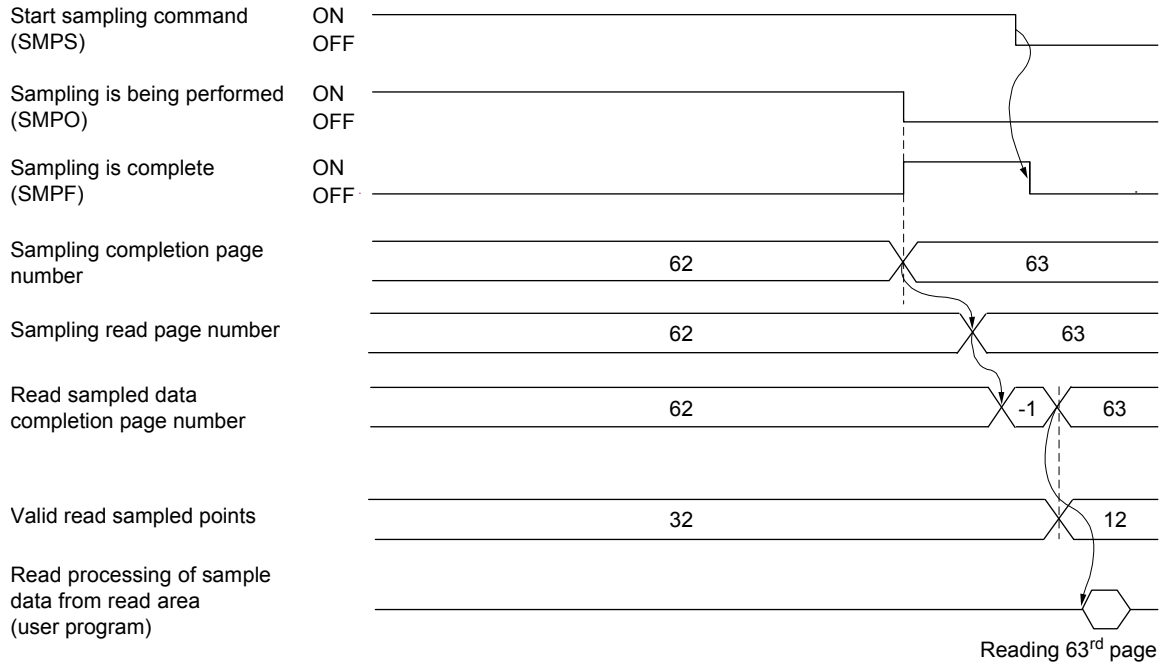

POINT

- In the timing chart above, since the valid read sampled points of the last page of the sampling (63rd page) are 12, the valid sampled data of the last page is 1 to 12 points.
- When sample data that is read is 0 for points outside of sample valid points.

7. AUXILIARY FUNCTION

4) Sampling stopped prior to full completion

When the start sampling command (SMPS) is turned on during the sampling (SMPO: ON), the sampling is being performed (SMPO) turns off and the sampling finishes. After confirming the sampling is being performed (SMPO) turns off, read until the sampling completion page number.

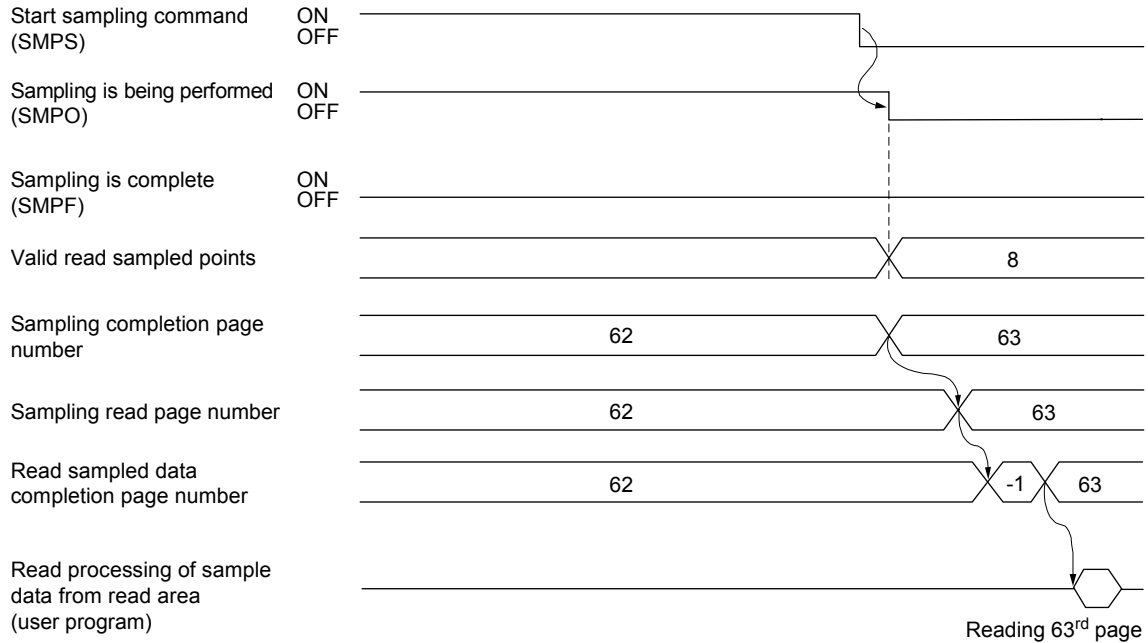

POINT

- In the timing chart above, since the valid read sampled points of the last page of the sampling (63rd page) are 8, the valid sampled data of the last page is 1 to 8 points.
- When sample data that is read is 0 for points outside of sample valid points.
- The sampling is completed (SMPF) is not turned on.

7. AUXILIARY FUNCTION

5) When the reading of sampled data is not finished in time

When the next page number of the sampling completion page number matches the sampling read page number during the sampling (SMPO: ON), the Q173SCCF judges that the reading of sampled data is not finished in time and the sampling is finished (the sampling error (SMPE) turns on). After confirming the sampling is being performed (SMPO) turns off, read the unread pages to the page of the read sampled data completion page number and valid read sampled points. The valid data points sampled in the page of the sampling completion page number are stored in the valid sampled read points.

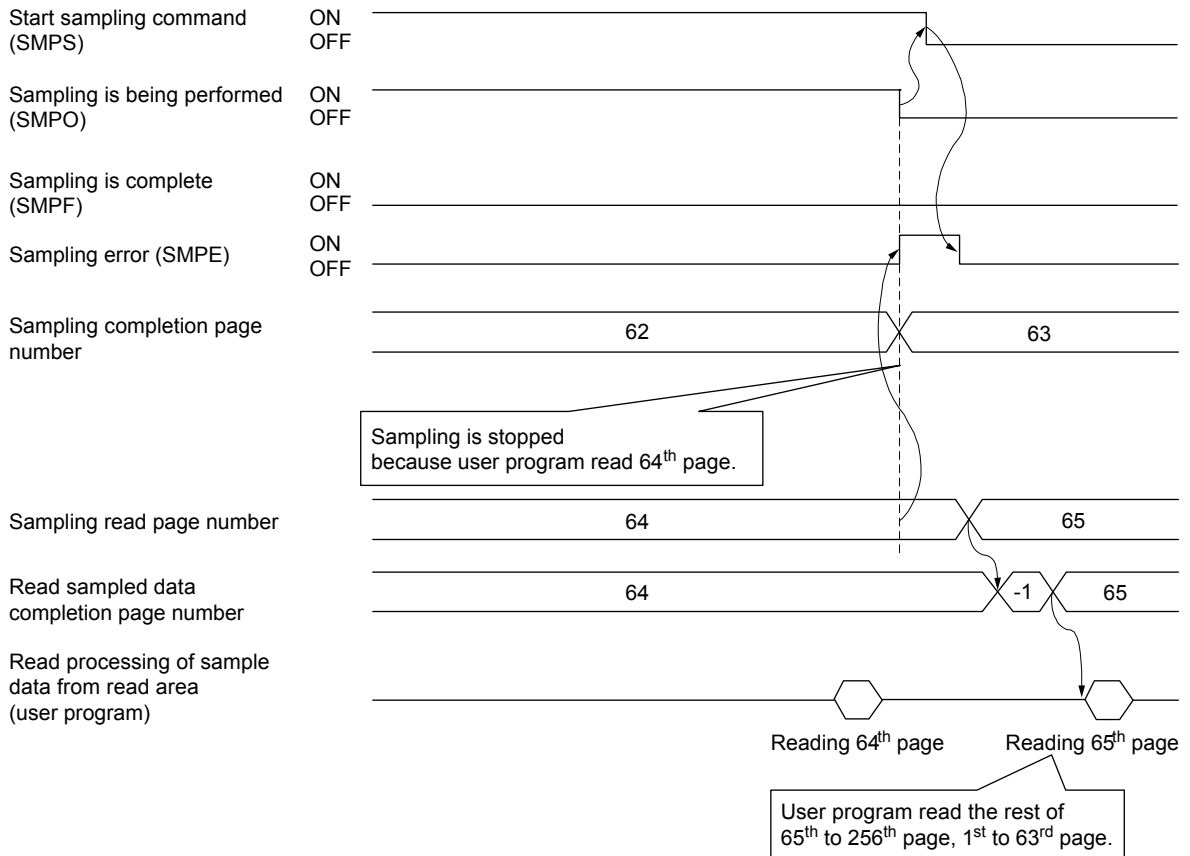

POINT
<ul style="list-style-type: none"> ▪ In the timing chart above, since the sampling is stopped when the sampling of the 63rd page is completed, the valid sampled data of the 63rd page (valid read sampled points) is 32 points. ▪ When sample data that is read is 0 for points outside of sample valid points.

7. AUXILIARY FUNCTION

7.13 Log

7.13.1 Summary

The log function is a function that stores the status when an event occurs (start operation, completion, alarm occurs etc.) on the Q173SCCF. The log data is stored in the log data buffer area (internal memory of the Q173SCCF). When a reading of log data command is generated at a C Controller module, the log data stored in the log data buffer area is transferred to the dual port memory.

The log data is a ring buffer where the oldest data is deleted sequentially.

The log data is stored in the internal memory of the Q173SCCF, and the log data is initialized when the power for the Q173SCCF is turned off, or by a software reboot.

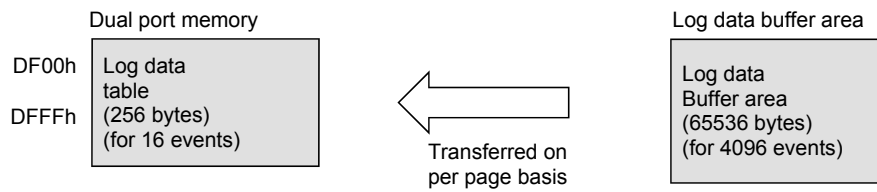

* Log data read to dual port memory from internal memory of Q173SCCF on per page (for 16 events) basis.

POINT

- Reading of log data can be performed in the test tool.

API LIBRARY

- Use the sscStartLog function to start log.
- Use the sscStopLog function to stop log.
- Use the sscCheckLogStatus function to get log operation status.
- Use the sscCheckLogEventNum function to get the number of valid log data events.
- Use the sscReadLogData function to get the log data.

7. AUXILIARY FUNCTION

7.13.2 Log data details

The log data for 1 event is 16 bytes. The details of the data are shown in the following.

Offset	Content
0000h	Axis No.
0002h	Event code
0004h	Time stamp
0006h	
0008h	Information for each event
000Ah	
000Ch	
000Eh	

(1) Axis No.

Axis (station) No. [0 : For events that are common to axes]

[1 to 20 : For events for separate axes]

[1 to 4 : For events for separate stations]

(2) Event code

Refer to Section 7.13.3.

(3) Time stamp

Sets the value of the 32 bit free run counter added to each control cycle. This free run counter value is reset at system start up. It is 0 cleared when a software reboot is performed or when the Q173SCCF power is turned off and on.

(4) Information for each event

Refer to Section 7.13.4.

7. AUXILIARY FUNCTION

7.13.3 Event code list

Event code	Factor	Each axis(station)/common
0001h	Start of automatic operation	Each axis
0002h	Start of return to home position	Each axis
0003h	Start of JOG operation	Each axis
0004h	Start of incremental movement	Each axis
0005h	Start of linear interpolation operation	Each axis
0006h	Home position reset startup	Each axis
0011h	Completion of automatic operation	Each axis
0012h	Home position return complete	Each axis
0013h	Completion of JOG operation	Each axis
0014h	Completion of incremental movement	Each axis
0015h	Completion of linear interpolation operation	Each axis
0016h	Home position reset completion	Each axis
0020h	Change speed	Each axis
0021h	Change acceleration time constant	Each axis
0022h	Change deceleration time constant	Each axis
0023h	Position change	Each axis
0100h	Operation alarm occurs	Each axis
0101h	A servo alarm occurs	Each axis
0102h	Start of operation while alarm is set	Each axis
0103h	System alarm occurs	Common
0201h	Parameter initialization	Common
0202h	Writing to parameters	Each axis, Common
0203h	Reading parameters	Each axis, Common
0210h	Backup parameters reading	Common
0211h	Flash ROM parameter backup	Common
0212h	Flash ROM parameter initialization	Common
0300h	Start of system startup	Common
0310h	Completion of system startup	Common
0311h	System error occurs	Common
0402h	Interlock occurs	Each axis
0403h	Interlock cancelled	Each axis
0404h	Stop command (STP)	Each axis
0408h	Rapid stop command (RSTP)	Each axis
0500h	Operation alarm reset	Each axis
0501h	Servo alarm reset	Each axis
0503h	System alarm reset	Common
0601h	Waiting required for interference	Each axis
0602h	Cancellation of waiting for interference	Each axis
0603h	Rough match output	Each axis
0604h	Pass position interrupt start	Each axis
0605h	Pass position interrupt complete	Each axis
0606h	Pass position interrupt incomplete	Each axis
0607h	Pass position interrupt cancel	Each axis
0608h	Pass position interrupt condition satisfied	Each axis
0609h	Point table loop start	Each axis
0800h	Other axes start complete	Common
0801h	Other axes start incomplete	Common

7. AUXILIARY FUNCTION

Event code	Factor	Each axis(station)/common
0900h	SSCNET disconnection command	Common
0901h	SSCNET disconnection complete	Common
0902h	SSCNET disconnection error	Common
0903h	SSCNET reconnection command	Common
0904h	SSCNET reconnection complete	Common
0905h	SSCNET reconnection error	Common
0A00h	Control mode switch complete	Each axis
0A01h	Control mode switch error	Each axis
0B00h	Mark detection signal detection	Each axis
0B01h	Mark detection clear	Each axis
0B02h	Mark detection disable start	Each axis
0B03h	Mark detection disable cancel	Each axis
0B04h	Mark detection setting enable	Each axis
0C00h	Transient transmit start	Each axis
0C01h	Transient transmit error occurrence	Each axis
2100h	RIO control alarm occurrence	Each station
2101h	RIO module alarm occurrence	Each station
2202h	Writing to parameters (remote I/O)	Each station
2500h	RIO control alarm reset	Each station
2501h	RIO module alarm reset	Each station
2C00h	Transient transmit start (remote I/O)	Each station
2C01h	Transient transmit error occurrence (remote I/O)	Each station

7. AUXILIARY FUNCTION

7.13.4 Information for each event

Log data set per event is as follows.

Also, details concerning the operation mode noted in the information per event is as follows.

- 0: Automatic operation
- 1: Home position return
- 2: JOG operation
- 3: Incremental feed
- 4: Mode not selected
- 5: Mode error
- 6: Home position reset
- 8: Linear interpolation operation

(1) Start of automatic operation

Offset	Content
0000h	Axis No.
0002h	Event code (0001h)
0004h	Time stamp
0006h	
0008h	Start point No.
000Ah	End point No.
000Ch	Operation startup coordinate
000Eh	

(2) Start of home position return

Offset	Content
0000h	Axis No.
0002h	Event code (0002h)
0004h	Time stamp
0006h	
0008h	Home position return speed
000Ah	Creep speed
000Ch	
000Eh	Return to home position mode (Note)

Note. Follow the home position return method designated in parameter No.0240.

(3) Start of JOG operation

Offset	Content
0000h	Axis No.
0002h	Event code (0003h)
0004h	Time stamp
0006h	
0008h	Manual feed speed (Note)
000Ah	
000Ch	0 (fixed value)
000Eh	0 (fixed value)

Note. Taken as a negative number when the movement direction is —.

(4) Start of incremental feed

Offset	Content
0000h	Axis No.
0002h	Event code (0004h)
0004h	Time stamp
0006h	
0008h	Manual feed speed (Note)
000Ah	
000Ch	Incremental feed movement amount
000Eh	

Note. Taken as a negative number when the movement direction is —.

(5) Start of linear interpolation operation

Offset	Content
0000h	Axis No.
0002h	Event code (0005h)
0004h	Time stamp
0006h	
0008h	Start point No.
000Ah	End point No.
000Ch	Operation startup coordinate
000Eh	

(6) Home position reset startup

Offset	Content
0000h	Axis No.
0002h	Event code (0006h)
0004h	Time stamp
0006h	
0008h	0 (fixed value)
000Ah	0 (fixed value)
000Ch	0 (fixed value)
000Eh	0 (fixed value)

7. AUXILIARY FUNCTION

(7) Completion of automatic operation

Offset	Content
0000h	Axis No.
0002h	Event code (0011h)
0004h	Time stamp
0006h	
0008h	Coordinate operation completed
000Ah	
000Ch	0 (fixed value)
000Eh	0 (fixed value)

(8) Home position return complete

Offset	Content
0000h	Axis No.
0002h	Event code (0012h)
0004h	Time stamp
0006h	
0008h	Completion status (0: normal – 1: error)
000Ah	
000Ch	0 (fixed value)
000Eh	0 (fixed value)

(9) Completion of JOG operation

Offset	Content
0000h	Axis No.
0002h	Event code (0013h)
0004h	Time stamp
0006h	
0008h	Coordinate operation completed
000Ah	
000Ch	0 (fixed value)
000Eh	0 (fixed value)

(10) Completion of incremental feed

Offset	Content
0000h	Axis No.
0002h	Event code (0014h)
0004h	Time stamp
0006h	
0008h	Coordinate operation completed
000Ah	
000Ch	0 (fixed value)
000Eh	0 (fixed value)

(11) Completion of linear interpolation operation

Offset	Content
0000h	Axis No.
0002h	Event code (0015h)
0004h	Time stamp
0006h	
0008h	Coordinate operation completed
000Ah	
000Ch	0 (fixed value)
000Eh	0 (fixed value)

(12) Home position reset complete

Offset	Content
0000h	Axis No.
0002h	Event code (0016h)
0004h	Time stamp
0006h	
0008h	Completion status (0: normal – 1: error)
000Ah	
000Ch	0 (fixed value)
000Eh	0 (fixed value)

(13) Change speed

Offset	Content
0000h	Axis No.
0002h	Event code (0020h)
0004h	Time stamp
0006h	
0008h	Speed after change
000Ah	
000Ch	Status 0: Completion of preparation for change 1: Change error
000Eh	0 (fixed value)

(14) Change acceleration time constant

Offset	Content
0000h	Axis No.
0002h	Event code (0021h)
0004h	Time stamp
0006h	
0008h	Acceleration time constant after change
000Ah	
000Ch	Status 0: Completion of preparation for change 1: Change error
000Eh	0 (fixed value)

7. AUXILIARY FUNCTION

(15) Change deceleration time constant

Offset	Content
0000h	Axis No.
0002h	Event code (0022h)
0004h	Time stamp
0006h	
0008h	Deceleration time constant after change
000Ah	
000Ch	Status 0: Completion of preparation for change 1: Change error
000Eh	0 (fixed value)

(16) Position change

Offset	Content
0000h	Axis No.
0002h	Event code (0023h)
0004h	Time stamp
0006h	
0008h	Position after change
000Ah	
000Ch	Status 0: Completion of preparation for change 1: Change error
000Eh	0 (fixed value)

(17) Operation alarm occurs

Offset	Content
0000h	Axis No.
0002h	Event code (0100h)
0004h	Time stamp
0006h	
0008h	Alarm number
000Ah	Details number
000Ch	0 (fixed value)
000Eh	0 (fixed value)

(18) A servo alarm occurs

Offset	Content
0000h	Axis No.
0002h	Event code (0101h)
0004h	Time stamp
0006h	
0008h	Alarm number
000Ah	Details number
000Ch	0 (fixed value)
000Eh	0 (fixed value)

(19) Start of operation while alarm is set

Offset	Content
0000h	Axis No.
0002h	Event code (0102h)
0004h	Time stamp
0006h	
0008h	Alarm number
000Ah	Details number
000Ch	0 (fixed value)
000Eh	0 (fixed value)

(20) System alarm occurs

Offset	Content
0000h	Axis No.
0002h	Event code (0103h)
0004h	Time stamp
0006h	
0008h	Alarm number
000Ah	Details number
000Ch	0 (fixed value)
000Eh	0 (fixed value)

(21) Parameter initialization

Offset	Content
0000h	Axis No.
0002h	Event code (0201h)
0004h	Time stamp
0006h	
0008h	System command code
000Ah	0 (fixed value)
000Ch	0 (fixed value)
000Eh	0 (fixed value)

(22) Writing to parameters

Offset	Content
0000h	Axis No.
0002h	Event code (0202h)
0004h	Time stamp
0006h	
0008h	Parameter number
000Ah	Parameter setting prior to change
000Ch	Parameter setting after change
000Eh	0 (fixed value)

7. AUXILIARY FUNCTION

(23) Reading parameters

Offset	Content
0000h	Axis No.
0002h	Event code (0203h)
0004h	Time stamp
0006h	
0008h	Parameter number
000Ah	Parameter data
000Ch	0 (fixed value)
000Eh	0 (fixed value)

(24) Backup parameters reading

Offset	Content
0000h	Axis No.
0002h	Event code (0210h)
0004h	Time stamp
0006h	
0008h	0 (fixed value)
000Ah	0 (fixed value)
000Ch	0 (fixed value)
000Eh	0 (fixed value)

(25) Flash ROM parameter backup

Offset	Content
0000h	Axis No.
0002h	Event code (0211h)
0004h	Time stamp
0006h	
0008h	0 (fixed value)
000Ah	0 (fixed value)
000Ch	0 (fixed value)
000Eh	0 (fixed value)

(26) Flash ROM parameter initialization

Offset	Content
0000h	Axis No.
0002h	Event code (0212h)
0004h	Time stamp
0006h	
0008h	0 (fixed value)
000Ah	0 (fixed value)
000Ch	0 (fixed value)
000Eh	0 (fixed value)

(27) Start of system startup

Offset	Content
0000h	Axis No.
0002h	Event code (0300h)
0004h	Time stamp
0006h	
0008h	System command code
000Ah	0 (fixed value)
000Ch	0 (fixed value)
000Eh	0 (fixed value)

(28) Completion of system startup

Offset	Content
0000h	Axis No.
0002h	Event code (0310h)
0004h	Time stamp
0006h	
0008h	0 (fixed value)
000Ah	0 (fixed value)
000Ch	0 (fixed value)
000Eh	0 (fixed value)

(29) System error occurs

Offset	Content
0000h	Axis No.
0002h	Event code (0311h)
0004h	Time stamp
0006h	
0008h	System status code
000Ah	0 (fixed value)
000Ch	0 (fixed value)
000Eh	0 (fixed value)

(30) Interlock occurs

Offset	Content
0000h	Axis No.
0002h	Event code (0402h)
0004h	Time stamp
0006h	
0008h	Operation mode
000Ah	0 (fixed value)
000Ch	0 (fixed value)
000Eh	0 (fixed value)

7. AUXILIARY FUNCTION

(31) Interlock cancelled

Offset	Content
0000h	Axis No.
0002h	Event code (0403h)
0004h	Time stamp
0006h	
0008h	Operation mode
000Ah	0 (fixed value)
000Ch	0 (fixed value)
000Eh	0 (fixed value)

(32) Stop command (STP)

Offset	Content
0000h	Axis No.
0002h	Event code (0404h)
0004h	Time stamp
0006h	
0008h	Operation mode
000Ah	0 (fixed value)
000Ch	0 (fixed value)
000Eh	0 (fixed value)

(33) Rapid stop command (RSTP)

Offset	Content
0000h	Axis No.
0002h	Event code (0408h)
0004h	Time stamp
0006h	
0008h	Operation mode
000Ah	0 (fixed value)
000Ch	0 (fixed value)
000Eh	0 (fixed value)

(34) Operation alarm reset

Offset	Content
0000h	Axis No.
0002h	Event code (0500h)
0004h	Time stamp
0006h	
0008h	Alarm number when reset is performed
000Ah	Details number when reset is performed
000Ch	0 (fixed value)
000Eh	0 (fixed value)

(35) Servo alarm reset

Offset	Content
0000h	Axis No.
0002h	Event code (0501h)
0004h	Time stamp
0006h	
0008h	Alarm number when reset is performed
000Ah	Details number when reset is performed
000Ch	0 (fixed value)
000Eh	0 (fixed value)

(36) System alarm reset

Offset	Content
0000h	Axis No.
0002h	Event code (0503h)
0004h	Time stamp
0006h	
0008h	Alarm number when reset is performed
000Ah	Details number when reset is performed
000Ch	0 (fixed value)
000Eh	0 (fixed value)

(37) Waiting required for interference

Offset	Content
0000h	Axis No.
0002h	Event code (0601h)
0004h	Time stamp
0006h	
0008h	Operation mode
000Ah	0 (fixed value)
000Ch	0 (fixed value)
000Eh	0 (fixed value)

(38) Cancellation of waiting for interference

Offset	Content
0000h	Axis No.
0002h	Event code (0602h)
0004h	Time stamp
0006h	
0008h	Operation mode
000Ah	0 (fixed value)
000Ch	0 (fixed value)
000Eh	0 (fixed value)

7. AUXILIARY FUNCTION

(39) Rough match output

Offset	Content
0000h	Axis No.
0002h	Event code (0603h)
0004h	Time stamp
0006h	
0008h	Operation mode
000Ah	0 (fixed value)
000Ch	0 (fixed value)
000Eh	0 (fixed value)

(40) Pass position interrupt start

Offset	Content
0000h	Axis No.
0002h	Event code (0604h)
0004h	Time stamp
0006h	
0008h	Pass position condition number
000Ah	Pass position option
000Ch	Start coordinate
000Eh	

(41) Pass position interrupt complete

Offset	Content
0000h	Axis No.
0002h	Event code (0605h)
0004h	Time stamp
0006h	
0008h	Pass position condition number
000Ah	Pass position option
000Ch	Completion coordinate
000Eh	

(42) Pass position interrupt incomplete

Offset	Content
0000h	Axis No.
0002h	Event code (0606h)
0004h	Time stamp
0006h	
0008h	Pass position condition number
000Ah	Pass position option
000Ch	Completion coordinate
000Eh	

(43) Pass position interrupt cancel

Offset	Content
0000h	Axis No.
0002h	Event code (0607h)
0004h	Time stamp
0006h	
0008h	Pass position condition number
000Ah	Pass position option
000Ch	Cancel coordinate
000Eh	

(44) Pass position interrupt condition satisfied

Offset	Content
0000h	Axis No.
0002h	Event code (0608h)
0004h	Time stamp
0006h	
0008h	Pass position condition number
000Ah	Pass position option
000Ch	Condition satisfied coordinate
000Eh	

(45) Point table loop start

Offset	Content
0000h	Axis No.
0002h	Event code (0609h)
0004h	Time stamp
0006h	
0008h	0 (fixed value)
000Ah	0 (fixed value)
000Ch	0 (fixed value)
000Eh	0 (fixed value)

7. AUXILIARY FUNCTION

(46) Other axes start complete

Offset	Content
0000h	Axis No.
0002h	Event code (0800h)
0004h	Time stamp
0006h	
0008h	Other axes start data No.
000Ah	0 (fixed value)
000Ch	0 (fixed value)
000Eh	0 (fixed value)

(47) Other axes start incomplete

Offset	Content
0000h	Axis No.
0002h	Event code (0801h)
0004h	Time stamp
0006h	
0008h	Other axes start data No.
000Ah	0 (fixed value)
000Ch	0 (fixed value)
000Eh	0 (fixed value)

(48) SSCNET disconnection command

Offset	Content
0000h	Axis No.
0002h	Event code (0900h)
0004h	Time stamp
0006h	
0008h	Disconnection axis No.
000Ah	0 (fixed value)
000Ch	0 (fixed value)
000Eh	0 (fixed value)

(49) SSCNET disconnection complete

Offset	Content
0000h	Axis No.
0002h	Event code (0901h)
0004h	Time stamp
0006h	
0008h	Controlling axis information (lower)
000Ah	
000Ch	Controlling axis information (upper) (0(fixed value))
000Eh	0 (fixed value)

(50) SSCNET disconnection error

Offset	Content
0000h	Axis No.
0002h	Event code (0902h)
0004h	Time stamp
0006h	
0008h	Error code of reconnection/disconnection
000Ah	0 (fixed value)
000Ch	0 (fixed value)
000Eh	0 (fixed value)

(51) SSCNET reconnection command

Offset	Content
0000h	Axis No.
0002h	Event code (0903h)
0004h	Time stamp
0006h	
0008h	0 (fixed value)
000Ah	0 (fixed value)
000Ch	0 (fixed value)
000Eh	0 (fixed value)

(52) SSCNET reconnection complete

Offset	Content
0000h	Axis No.
0002h	Event code (0904h)
0004h	Time stamp
0006h	
0008h	Controlling axis information (lower)
000Ah	
000Ch	Controlling axis information (upper) (0(fixed value))
000Eh	0 (fixed value)

(53) SSCNET reconnection error

Offset	Content
0000h	Axis No.
0002h	Event code (0905h)
0004h	Time stamp
0006h	
0008h	Error code of reconnection/disconnection
000Ah	0 (fixed value)
000Ch	0 (fixed value)
000Eh	0 (fixed value)

7. AUXILIARY FUNCTION

(54) Control mode switch complete

Offset	Content
0000h	Axis No.
0002h	Event code (0A00h)
0004h	Time stamp
0006h	
0008h	Control mode before switch 0: Position control mode 1: Speed control mode 2: Torque control mode
000Ah	Control mode after switch 0: Position control mode 1: Speed control mode 2: Torque control mode
000Ch	0 (fixed value)
000Eh	0 (fixed value)

(55) Control mode switch error

Offset	Content
0000h	Axis No.
0002h	Event code (0A01h)
0004h	Time stamp
0006h	
0008h	Control mode before switch 0: Position control mode 1: Speed control mode 2: Torque control mode
000Ah	Control mode after switch 0: Position control mode 1: Speed control mode 2: Torque control mode
000Ch	Switch error cause 0: Zero speed (ZSP) OFF 1: Control mode error 2: Incompatible axis 3: Switch not possible
000Eh	0 (fixed value)

(56) Mark detection signal detection

Offset	Content
0000h	Axis No.
0002h	Event code (0B00h)
0004h	Time stamp
0006h	
0008h	Mark detection number 0: Mark detection setting 1 1: Mark detection setting 2
000Ah	Mark detection edge data 1: OFF edge 2: ON edge
000Ch	Data latch 0: No latch 1: Latch
000Eh	0 (fixed value)

(57) Mark detection clear

Offset	Content
0000h	Axis No.
0002h	Event code (0B01h)
0004h	Time stamp
0006h	
0008h	Mark detection setting number
000Ah	0 (fixed value)
000Ch	0 (fixed value)
000Eh	0 (fixed value)

(58) Mark detection disable start

Offset	Content
0000h	Axis No.
0002h	Event code (0B02h)
0004h	Time stamp
0006h	
0008h	Mark detection setting number
000Ah	0 (fixed value)
000Ch	0 (fixed value)
000Eh	0 (fixed value)

(59) Mark detection disable cancel

Offset	Content
0000h	Axis No.
0002h	Event code (0B03h)
0004h	Time stamp
0006h	
0008h	Mark detection setting number
000Ah	0 (fixed value)
000Ch	0 (fixed value)
000Eh	0 (fixed value)

7. AUXILIARY FUNCTION

(60) Mark detection setting enable

Offset	Content
0000h	Axis No.
0002h	Event code (0B04h)
0004h	Time stamp
0006h	
0008h	Mark detection setting number
000Ah	0 (fixed value)
000Ch	0 (fixed value)
000Eh	0 (fixed value)

(61) Transient transmit start

Offset	Content
0000h	Axis No.
0002h	Event code (0C00h)
0004h	Time stamp
0006h	
0008h	Transient command
000Ah	0 (fixed value)
000Ch	0 (fixed value)
000Eh	0 (fixed value)

(62) Transient transmit error occurrence

Offset	Content
0000h	Axis No.
0002h	Event code (0C01h)
0004h	Time stamp
0006h	
0008h	Transient command
000Ah	0 (fixed value)
000Ch	0 (fixed value)
000Eh	0 (fixed value)

(63) RIO control alarm occurrence

Offset	Content
0000h	Station No.
0002h	Event code (2100h)
0004h	Time stamp
0006h	
0008h	Alarm number
000Ah	Details number
000Ch	0 (fixed value)
000Eh	0 (fixed value)

(64) RIO module alarm occurrence

Offset	Content
0000h	Station No.
0002h	Event code (2101h)
0004h	Time stamp
0006h	
0008h	Alarm number
000Ah	Details number
000Ch	0 (fixed value)
000Eh	0 (fixed value)

(65) Writing to parameters (remote I/O)

Offset	Content
0000h	Station No.
0002h	Event code (2202h)
0004h	Time stamp
0006h	
0008h	Parameter number
000Ah	Parameter setting prior to change
000Ch	Parameter setting after change
000Eh	0 (fixed value)

(66) RIO control alarm reset

Offset	Content
0000h	Station No.
0002h	Event code (2500h)
0004h	Time stamp
0006h	
0008h	Alarm number
000Ah	Details number
000Ch	0 (fixed value)
000Eh	0 (fixed value)

(67) RIO module alarm reset

Offset	Content
0000h	Station No.
0002h	Event code (2501h)
0004h	Time stamp
0006h	
0008h	Alarm number
000Ah	Details number
000Ch	0 (fixed value)
000Eh	0 (fixed value)

7. AUXILIARY FUNCTION

(68) Transient transmit start (remote I/O)

Offset	Content
0000h	Station No.
0002h	Event code (2C00h)
0004h	Time stamp
0006h	
0008h	Transient command
000Ah	0 (fixed value)
000Ch	0 (fixed value)
000Eh	0 (fixed value)

(69) Transient transmit error occurrence
(remote I/O)

Offset	Content
0000h	Station No.
0002h	Event code (2C01h)
0004h	Time stamp
0006h	
0008h	Transient command
000Ah	0 (fixed value)
000Ch	0 (fixed value)
000Eh	0 (fixed value)

POINT

- For change of parameters (event code 0202h), the parameter value prior to change and parameter value after change are compared and only if the setting is different is the parameter change recorded in the log data.
- For occurrence of system errors (event code 0311h), occurrence of system errors related to communication (E400h to) are recorded in the log data. However system errors that show issues with the Q173SCCF (E001h to E302h) are not recorded in the log data, as the Q173SCCF is in an error state.

7. AUXILIARY FUNCTION

7.13.5 Log function interface

(1) Command/status bit

System command/status bits related to log function are shown below.

System command

Address	Bit	Abbreviation	Signal name
03EA	0	LOGC	Log command
	1	LOGR	Reading of log data command
	2		Reserved
	3	LOGI	Log data initialization command
	4		Reserved
	5		
	6		
7			

System status

Address	Bit	Abbreviation	Signal name
045A	0	LOGO	Log operation being performed
	1	LOGRF	Reading of log data complete
	2	LOGRE	Reading of log data error
	3	LOGIF	Log data initialization is complete
	4	LOGIE	Log data initialization error
	5		Reserved
	6		
7			

(a) Details concerning system command bits

Abbreviation	Signal name	Function details
LOGC	Log command	<p>[Function] Starts/stops recording of log data.</p> <p>[Operation] When the log command signal (LOGC) is turned on, recording of log data is started, and log operation being performed signal (LOGO) is turned on. The log operation being performed signal (LOGO) is turned off when the log command signal (LOGC) is turned off.</p>
LOGR	Reading of log data command	<p>[Function] Reads the log data stored in the log data buffer area to the log data table on the dual port memory.</p> <p>[Operation] When the reading of log data command signal (LOGR) is turned on, the log data for the page number set as the read log data page number is read into the log data table. When reading of log data is complete, the reading of log data complete signal (LOGRF) is turned on or a reading of log data error signal (SMPRE) is turned on.</p>
LOGI	Log data initialization command	<p>[Function] Initialization of the log data stored in the log data buffer area.</p> <p>[Operation] When the log data initialization command signal (LOGI) is turned on, the log data is initialized and the number of valid log data events and time stamp are 0 cleared.</p>

7. AUXILIARY FUNCTION

(b) Details concerning system status bits

Abbreviation	Signal name	Function details
LOGO	Log operation being performed	<p>[Function] Notifies that log is now being taken.</p> <p>[Operation] <Conditions for turning on> The log command signal (LOGC) was turned on. <Conditions for turning off> The log command signal (LOGC) was turned off.</p>
LOGRF	Reading of log data complete	<p>[Function] Notifies that reading of log data was completed normally.</p> <p>[Operation] <Conditions for turning on> Reading of log data is completed normally. <Conditions for turning off> Entered reading of data because the log command signal (LOGC) was turned on. Reading of log data command signal (LOGR) was turned off.</p>
LOGRE	Reading of log data error	<p>[Function] Notifies that reading of log data was not completed normally.</p> <p>[Operation] <Conditions for turning on> Reading of log data command signal (LOGR) was turned on while log (LOGO: ON) was being taken. Reading of log data command signal (LOGR) was turned on with a reading of log data page number set outside page number limits. <Conditions for turning off> Reading of log data command signal (LOGR) was turned off.</p>
LOGIF	Log data initialization is complete	<p>[Function] Notifies that log data initialization was completed normally.</p> <p>[Operation] <Conditions for turning on> Initialization of log data is completed normally. <Conditions for turning off> Initialization of data entered through turning the log data initialization command signal (LOGI) on. The log data initialization command signal (LOGI) was turned off.</p>
LOGIE	Log data initialization error	<p>[Function] Notifies that log data initialization was not completed normally.</p> <p>[Operation] <Conditions for turning on> Log data initialization command signal (LOGI) was turned on while log operation being performed signal (LOGO) was turned on. <Conditions for turning off> The log data initialization command signal (LOGI) was turned off.</p>

7. AUXILIARY FUNCTION

(2) System Command/Status Data

(a) System Commands

Address	Name	Setting range	Remarks
01B0	Reading of log data Page number	1 to 256	Sets the page number for the log data area for logged data to be read to. Data for 16 events of log data are read for each page. Example. When the number of valid events is 345 events $345/16 = 21 \cdot \cdot \cdot 9$ In other words, pages 1 to 22 are read.
01B1			

(b) System status

Address	Name	Output limits	Remarks
01F0	Reading of log data Page number	1 to 256	Stores the page number that was read. The details for the settings for the page number of the log data that was read using a system command are stored.
01F1			
01F2	Number of valid log data events	0 to 4096	Stores the number of number of valid events stored in current log data. When the number of valid events reaches 4096 events the number of valid events becomes 4096.
01F3			

7. AUXILIARY FUNCTION

7.13.6 Timing chart for reading of log data

A method for reading log data stored in the log data buffer area is shown below.

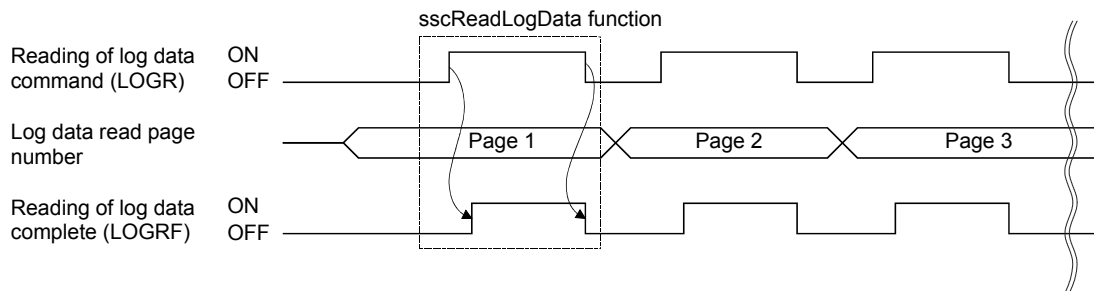

POINT
<ul style="list-style-type: none"> For reading of log data, turn off the log command signal (LOGC). If log data is read while the log operation being performed signal (LOGO) is turned on, the reading of log data error (LOGRE) is turned on. Log data is stored using a ring buffer format in the log data buffer area of the Q173SCCF; however, when transferred to the dual port memory, the data is transferred from the oldest (oldest is transferred first) in order.

7.13.7 Log acquiring selection

By setting the log acquiring selection (parameter No.0040 to 0042), the axis No. and system for which the log to be acquired can be set.

When the number of log events to be memorized is not enough, set the events (axis and system) for which log is to be acquired, using this function.

(1) System parameter

Parameter No.	Abbreviation	Name	Initial value	Unit	Setting range	Function
0040	LGS1	Log acquiring selection 1 (Note 1)	0000h	/	0000h to 0001h	Set whether to acquire the log of the system when the log function is used. System (bit 0) 0: Not acquire 1: Acquire
0041	LGS2	Log acquiring selection 2 (Note 1)	0000h	/	0000h to FFFFh	Set the axis No. for which the log is to be acquired. Axis 1 (bit 0) to axis 16 (bit 15) 0: Not acquire 1: Acquire
0042	LGS3	Log acquiring selection 3 (Note 1)	0000h	/	0000h to FFFFh	Set the axis No. for which the log is to be acquired. Axis 17 (bit 0) to axis 20 (bit 3) 0: Not acquire 1: Acquire
0044	LGS5	Log acquiring selection 5 (Note 1)	0000h	/	0000h to 00FFh	Set the station No. for which the log is to be acquired. Station 1 (bit 0) to station 4 (bit 3) 0: Not acquire 1: Acquire

Note 1. When all the system parameters of the log acquiring selection (parameters No.0040 to 0042, and 0044) are set to 0000h (initial value), log for all axes, stations, and systems will be acquired.

2. Since the parameter for the log acquiring selection is not determined before the system startup, log for all axes, stations, and systems will be acquired.

7. AUXILIARY FUNCTION

7.14 Operation cycle monitor function

7.14.1 Summary

The operation cycle monitor function is a function that monitors the operation cycle current time, operation cycle maximum time, and operation cycle over time. The operation cycle monitor function becomes valid after the system starts.

The operation cycle is the Q173SCCF processing (SSCNET communication process + motion operation process) time.

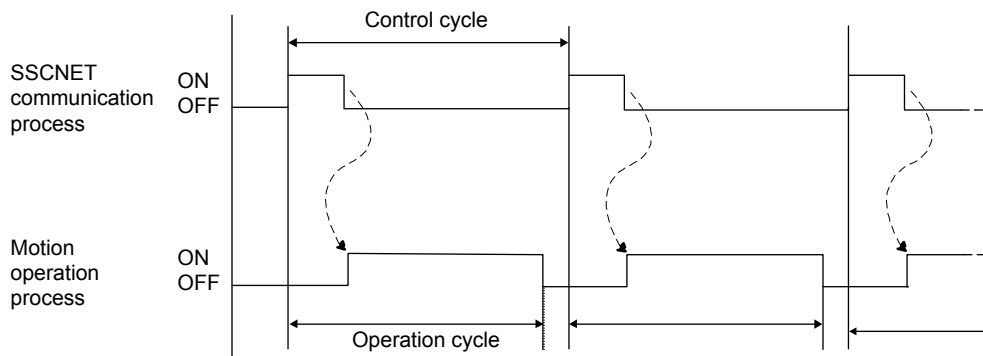

When the operation cycle exceeds the warning level (95% of the control cycle, 0.84ms when control cycle 0.88ms is selected), the operation cycle warning signal (OCMW) turns on. Also, when the operation cycle exceeds the alarm level (100% or more of the control cycle, 0.88ms or more when control cycle 0.88ms is selected), the count of the operation cycle over time (address 0018h) increases and the operation cycle alarm signal (OCME) turns on.

7.14.2 Interface

Interfaces related to the operation cycle monitor function are shown below.

(1) System command

Address	Bit	Abbreviation	Signal name
03EA	0	LOGC	Log command
	1	LOGR	Reading of log data command
	2		Reserved
	3	LOGI	Log data initialization command
	4		Reserved
	5	OCMC	Operation cycle monitor clear
	6		Reserved
7			Reserved

(2) System status

Address	Bit	Abbreviation	Signal name
045A	0	LOGO	Log operation being performed
	1	LOGRF	Reading of log data complete
	2	LOGRE	Reading of log data error
	3	LOGIF	Log data initialization is complete
	4	LOGIE	Log data initialization error
	5	OCMCO	During operation cycle monitor clear
	6	OCME	Operation cycle alarm
7	OCMW	Operation cycle warning	

(3) Operation cycle monitor data

Address	Size	Name	Unit	Description
0014h	2 byte	Operation cycle current time	μs	Current processing time is stored
0016h	2 byte	Operation cycle maximum time	μs	Maximum processing time is stored
0018h	2 byte	Operation cycle over time	Number of times	The cumulative value of the number of times which exceeds the control cycle is stored

7. AUXILIARY FUNCTION

7.14.3 Operation timing

(1) Operation cycle alarm, operation cycle warning occurrence timing

A timing chart for when the operation cycle exceeds the warning level (95% of the control cycle) and alarm level (100% of the control cycle) is shown below.

(The following figure shows: $a < \text{Operation cycle } 95\% < b < \text{Operation cycle } 100\% < c$)

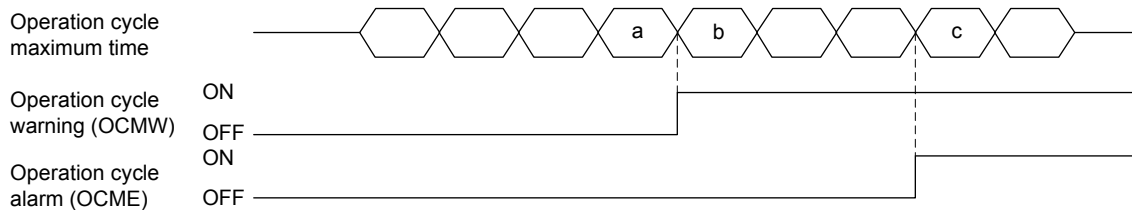

(2) Operation cycle monitor clear timing

When the operation cycle monitor clear signal (OCMC) is turned on, the during operation cycle monitor clear (OCMCO) is turned on. Then, the operation cycle alarm signal (OCME) and operation cycle warning signal (OCMW) are turned off, and each data item in the operation cycle monitor data is cleared to 0.

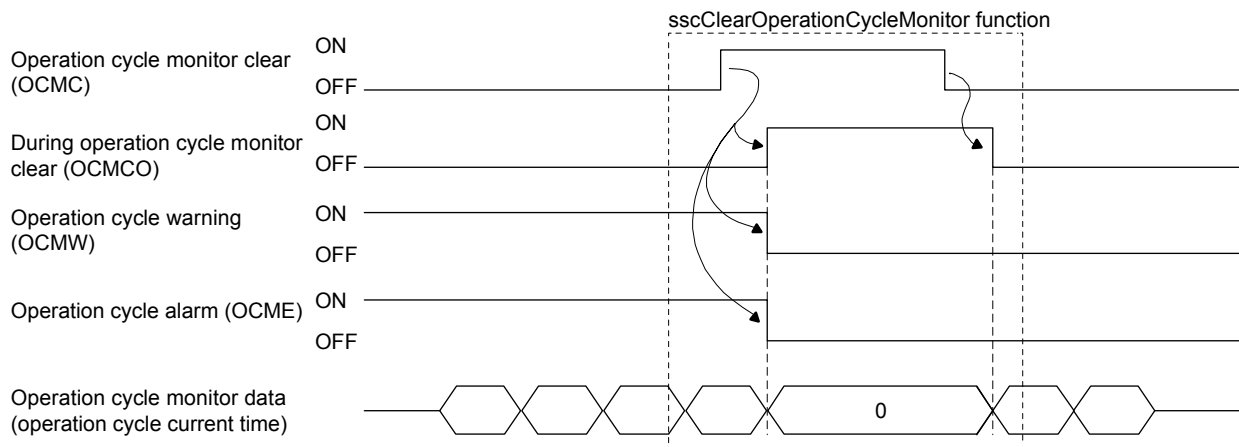

POINT

- When the operation cycle alarm signal (OCME) and operation cycle warning (OCMW) are turned on, the load of the motion operation is high. Review the following contents.
 - Extend the control cycle in the setting.
(Example. When the control cycle is 0.44 ms, change it to 0.88 ms.)
 - Set less control axes.
 - Reexamine the operation pattern so that each axis does not start operation simultaneously.
- For software version A4 or later, when operation cycle alarm (OCME) turns ON operation cycle alarm (system alarm 35, detail No.01) occurs. Operation continues even when operation cycle alarm (system alarm 35, detail No.01) has occurred. When clearing operation cycle alarm (system alarm 35, detail No.01) turn ON system alarm reset signal (CRST).

7. AUXILIARY FUNCTION

API LIBRARY

- Use the sscGetOperationCycleMonitor function to get the operation cycle current time/operation cycle maximum time/operation cycle over time.

7. AUXILIARY FUNCTION

7.15 External forced stop disabled

7.15.1 Summary

The external forced stop disabled function disables the external forced stop by input signal (EMI) from the I/O connector.

Note. Software forced stop by system command bit and forced stops due to system errors such as SSCNET communication errors (system status code E□□□h) are not disabled.

7.15.2 Interface

The interface added for the external forced stop disabled function is as follows.

(1) System status bit

Address	Bit	Abbreviation	Signal name
0452	0	EMIO	During forced stop
	1		Reserved
	2	TSTO	In test mode
	3		Reserved
	4		
	5		
	6	EMID	External forced stop disabled
	7		Reserved

(2) System parameter

Parameter No.	Abbreviation	Name	Initial value	Unit	Setting range	Function
000E	*EMID	External forced stop disabled	0000h		0000h to FFFFh	Disable the forced stop by EMI signal. 5AE1h : Forced stop disabled Other than 5AE1h : Forced stop enabled

7.15.3 Setting method

To disable the external forced stop, set 5AE1h to external forced stop disabled (parameter No.000E), and start the system. When the external forced stop is disabled, external forced stop disabled signal (EMID) turns ON.

Note 1. External forced stop disabled (parameter No.000E) settings are imported at the system startup. Changes while the system is running are invalid.

2. External forced stop disabled signal (EMID) turns ON at system startup.

7. AUXILIARY FUNCTION

7.16 Amplifier-less axis function

7.16.1 Summary

The amplifier-less axis function is a function that enables to operate the Q173SCCF without connecting a servo amplifier. This function enables to debug the user program at the start-up of the device and to simulate the positioning operation.

7.16.2 Interface

To use the amplifier-less axis function, set Valid in the amplifier-less axis function (parameter No.0200).

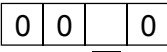
Parameter No.	Abbreviation	Name	Initial value	Unit	Setting range	Function
0200	*OPC1	Control option 1	0000h		0000h to 2111h	 <p>Amplifier-less axis function Set 1 when not communicating with servo amplifier. When 1 is set with the control axis, the Q173SCCF can be operated (simulated) without a servo amplifier. 0: Invalid 1: Valid</p>

7. AUXILIARY FUNCTION

7.16.3 Control details

The operation details related to the amplifier-less axis function are shown below.

Item	Operation						
Servo amplifier	<p>The specification of a supposedly connected servo amplifier is shown below.</p> <table border="1" data-bbox="544 461 1369 568"> <thead> <tr> <th>SSCNET communication method</th> <th>Number of encoder pulses per revolution [pulse]</th> <th>Maximum motor speed [r/min]</th> </tr> </thead> <tbody> <tr> <td>SSCNET III/H</td> <td>4194304</td> <td>6000</td> </tr> </tbody> </table> <p>Note. The servo amplifier operates as a servo amplifier compatible with a rotary servo motor. (It does not operate as a servo amplifier compatible with the fully closed, linear, and direct drive.)</p>	SSCNET communication method	Number of encoder pulses per revolution [pulse]	Maximum motor speed [r/min]	SSCNET III/H	4194304	6000
SSCNET communication method	Number of encoder pulses per revolution [pulse]	Maximum motor speed [r/min]					
SSCNET III/H	4194304	6000					
Home position return	Home position return using an incremental encoder or incremental linear scale including a scale home position signal detection method and a scale home position signal detection method 2 (home position return which searches a home position signal again) cannot be used.						
In-position signal (INP)	This signal turns on when the current command position and the current feedback position are the same.						
Servo alarm	No servo alarm occurs.						
Servo information	Servo information (monitor No.0100 to 02FF) cannot be referred unless the servo amplifier is connected. Servo amplifier is not connected (MESV) turns on.						
High speed monitor	The current command position of the previous control cycle is displayed in the current feedback position. Electrical current feedback and always 0 is displayed.						
Torque limit	By turning on/off the torque limit signal (TL), on/off of the selecting torque limit signal (TLSO) can be confirmed. However, the torque limit effective signal (TLC) does not turn on and the operation of the amplifier-less axis is not affected.						
Gain switching	By turning on/off the gain switching command signal (GAIN), on/off of the gain switching signal (GAINO) can be confirmed. However, the operation of the amplifier-less axis is not affected.						
Fully closed loop control change	By turning on/off the fully closed loop control change signal (CLD), on/off of the fully closed loop control changing signal (CLDO) can be confirmed. However, the operation of the amplifier-less axis is not affected.						
PI-PID switching	By turning on/off the PID control command signal (CPC), on/off of the during PID control signal (SPC) can be confirmed. However, the operation of the amplifier-less axis is not affected.						
Forced stop	When forced stop occurs, amplifier-less axis continues the positioning operation without controller forced stop warning (servo warning E7).						
External signal	To simulate an operation using a limit switch signal or dog signal (such as home position return), set dual port memory to the sensor input system (parameter No.0219) and control the sensor signal command (LSPC, LSNC, DOGC) with the user program.						
Absolute position detection system	The absolute position detection system cannot be used. The incremental system is always used.						
Reconnect/disconnect function	The amplifier-less axis cannot be disconnected or reconnected.						
Continuous operation to torque control	<p>After reaching the continuous operation to torque control speed limit value, it is regarded that the torque settle width has been reached, and operation is completed after the continuous operation to torque control time has passed.</p> <p>For electrical current feedback, torque 0% occurs before reaching the speed limit value, and target torque occurs after reaching the speed limit value.</p>						
Operation with MR Configurator2	Servo amplifier cannot be operated or monitored with MR Configurator.						

POINT

- The operation of the current feedback position and the timing of the in-position signal (INP) are different from the case where the servo amplifier is connected. Confirm the operation finally with a real machine.

7. AUXILIARY FUNCTION

7.17 Alarm history function

7.17.1 Summary

The alarm history function is a function that records the history of system errors and alarms (system, operation, and servo alarms) when they occur. The alarm history data is stored in the alarm history area of the flash ROM. Alarm history can also be checked after the power is turned off.

POINT
<ul style="list-style-type: none"> ▪ History data is also stored at system startup command (when 000Ah is input to the system command code) and at completion of system startup (when system status code has become 000Ah). ▪ Alarm history data is stored to the flash ROM once every 10s. (max. 100 alarms each storing) ▪ When more than 100 alarms occur over 10s, the data passed 100 alarms is discarded. ▪ If power is turned off or a reboot is performed before alarm history write, the history data is not saved. ▪ Reading of alarm history data can be performed in the test tool.

API LIBRARY
<ul style="list-style-type: none"> ▪ For a detailed procedure for getting alarm history data, refer to the sample program (AlarmHistory) contained on the utility software.

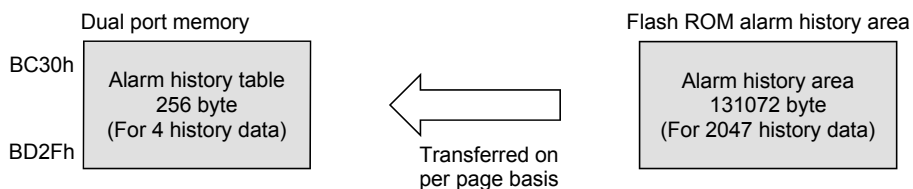

- Note 1. Log data is read to the dual port memory from internal memory of the Q173SCCF in units of pages (4 data)
- Note 2. There is a storage area for 2047 history data. However, when power supply is turned ON, or a software reboot is performed after storing 1536 data or more, the oldest 1024 items of history data are deleted.

(1) API library to be used

Function name	Description	Remarks
sscGetAlarmHistoryData	Gets alarm history data	Use the sscGetAlarmHistoryData function to read the alarm history. Calculate the largest page number (divide the number of valid events by 4 and round up to nearest whole number) to be read by using the number of valid events got with the sscCheckAlarmHistoryEventNum function. Use this function to get alarm history data from page 1 to the largest page number to be read.
sscCheckAlarmHistoryEventNum	Get the number of valid alarm history data events.	
sscClearAlarmHistoryData	Clears (initializes) the alarm history data.	

7. AUXILIARY FUNCTION

7.17.2 Alarm history data details

There are three types of history data, system startup command data and completion of system startup data, and alarm history data. One history data is 64 bytes. The details of the data are shown in the following.

(1) System startup command data

Offset	Content
0000h	System startup time
0001h	
0002h	
0003h	
0004h	
0005h	
0006h	
0007h	
0008h	Free run counter
0009h	
000Ah	
000Bh	
000Ch	Control cycle
000Dh	Event code
000Eh	Reserved
000Fh	
0010h	Communication mode
0011h	Control mode
0012h	Reserved
0013h	
0014h	
0015h	
0016h	
0017h	
0018h	
0019h	
001Ah	
001Bh	
001Ch	
001Dh	
001Eh	
001Fh	

Offset	Content
0020h	Reserved
0021h	
0022h	
0023h	
0024h	
0025h	
0026h	
0027h	
0028h	
0029h	
002Ah	
002Bh	
002Ch	
002Dh	
002Eh	
002Fh	
0030h	
0031h	
0032h	
0033h	
0034h	
0035h	
0036h	
0037h	
0038h	
0039h	
003Ah	
003Bh	
003Ch	
003Dh	
003Eh	
003Fh	Checksum

(a) System startup time

When the API library is used, the number of seconds passed since 0000hrs, January 1, 1970 at the input time for system startup command is stored.

When the API library is not used, "0" is stored.

(b) Free-run counter

Stores the value of the free-run counter at the system startup command.

7. AUXILIARY FUNCTION

(c) Control cycle

Stores the control cycle.

00h: 0.88ms

01h: 0.44ms

02h: 0.22ms

(d) Event code

Stores the type of history content.

00h: System startup command

02h: Completion of system startup

10h: System error

11h: System alarm

12h: Servo alarm

13h: Operation alarm

92h: RIO module alarm

93h: RIO control alarm

(e) Communication mode

Stores the communication mode.

00h: SSCNETⅢ/H mode

(f) Control mode

Stores the control mode.

00h: Standard mode

01h: Interface mode

(g) Checksum

Stores the inverted sum of the 1 byte data from the whole area for history data as the checksum data.

POINT	
	• If control mode, communication mode, and control cycle for history data are set outside the range in system parameters, the following history is stored.
	• Control cycle : 00h (0.88ms)
	• Communication mode : 00h (SSCNETⅢ/H mode)
	• Control mode : 00h (Standard mode)

7. AUXILIARY FUNCTION

(2) Completion of system startup data

Offset	Content
0000h	System startup time
0001h	
0002h	
0003h	
0004h	
0005h	
0006h	
0007h	
0008h	Free run counter
0009h	
000Ah	
000Bh	
000Ch	Control cycle
000Dh	Event code
000Eh	Reserved
000Fh	
0010h	
0011h	
0012h	
0013h	
0014h	
0015h	
0016h	
0017h	
0018h	
0019h	
001Ah	
001Bh	
001Ch	
001Dh	
001Eh	
001Fh	

Offset	Content
0020h	Reserved
0021h	
0022h	
0023h	
0024h	
0025h	
0026h	
0027h	
0028h	
0029h	
002Ah	
002Bh	
002Ch	
002Dh	
002Eh	
002Fh	
0030h	
0031h	
0032h	
0033h	
0034h	
0035h	
0036h	
0037h	
0038h	
0039h	
003Ah	
003Bh	
003Ch	
003Dh	
003Eh	
003Fh	Checksum

(a) Free-run counter

Stores the value of the free-run counter at the completion of system startup.

Note. Refer to "(1) System startup command data" of this section for details of other data.

7. AUXILIARY FUNCTION

(3) Alarm history data

Offset	Content
0000h	System startup time
0001h	
0002h	
0003h	
0004h	
0005h	
0006h	
0007h	
0008h	Free run counter
0009h	
000Ah	
000Bh	
000Ch	Control cycle
000Dh	Event code
000Eh	Reserved
000Fh	
0010h	
0011h	
0012h	
0013h	
0014h	Error axis (station) No.
0015h	Alarm number
0016h	
0017h	Operation mode
0018h	Reserved
0019h	
001Ah	
001Bh	Current command position
001Ch	
001Dh	
001Eh	
001Fh	

Offset	Content
0020h	Current feedback position
0021h	
0022h	
0023h	
0024h	Reserved
0025h	
0026h	
0027h	
0028h	
0029h	
002Ah	
002Bh	
002Ch	
002Dh	
002Eh	
002Fh	
0030h	
0031h	
0032h	
0033h	
0034h	
0035h	
0036h	
0037h	
0038h	
0039h	
003Ah	
003Bh	
003Ch	
003Dh	
003Eh	
003Fh	Checksum

(a) Free-run counter

Stores the value of the free-run counter at the alarm occurrence.

(b) Error axis (station) No.

Stores the error axis (station) No. when the event code is an alarm/error.

0000h : System

0001h to 0014h: Axis No.

0001h to 0004h: Station No.

(c) Alarm number

Stores the alarm number (lower), and details number (upper) when the event code is an alarm/error.

7. AUXILIARY FUNCTION

(d) Operation mode

Stores the operation mode.

- 00h: Automatic operation
- 01h: Home position return
- 02h: JOG operation
- 03h: Incremental feed
- 04h: Mode not selected
- 05h: Mode error
- 06h: Home position reset
- 08h: Linear interpolation operation

Stores "04h: Mode not selected" when the event code is not a servo alarm or operation alarm.

(e) Current command position

Stores the signed current command position [command units] when the event code is a servo alarm or operation alarm.

Stores 0 when the event code is not a servo alarm or operation alarm.

(f) Current feedback position

Stores the signed current feedback position [command units] when the event code is a servo alarm or operation alarm.

Stores 0 when the event code is not a servo alarm or operation alarm.

Note. Refer to "(1) System startup command data" of this section for details of other data.

7. AUXILIARY FUNCTION

7.17.3 Interface

(1) System Command/Status Bit

System command/status bits related to alarm history function are shown below.

System command

Address	Bit	Abbreviation	Signal name
03E1	0	SMPS	Sampling start
	1	Reserved	
	2		
	3		
	4		
	5		
	6		
	7		

System status

Address	Bit	Abbreviation	Signal name		
0451	0	SMPW	Waiting for sampling trigger		
	1	SMPO	Sampling is being performed		
	2	SMPF	Sampling is complete		
	3	SMPE	Sampling Error		
	4	Reserved			
	5			AHINF	Alarm history information
	6				
	7				

System command

Address	Bit	Abbreviation	Signal name		
03F7	0	ALHR	Alarm history read command		
	1	Reserved			
	2			ALHI	Alarm history initialization command
	3				
	4				
	5				
	6				
	7				

System status

Address	Bit	Abbreviation	Signal name
0467	0	ALHRF	Alarm history read complete
	1	ALHRE	Alarm history read error
	2	ALHIF	Alarm history initialization complete
	3	ALHIE	Alarm history initialization error
	4	Reserved	
	5		
	6		
	7		

(a) Details concerning system command bits

Abbreviation	Signal name	Function details
ALHR	Alarm history read command	<p>[Function] Reads the alarm history stored in the alarm history buffer area (flash ROM) to the alarm history table on the dual port memory.</p> <p>[Operation] When the alarm history read command signal (ALHR) is turned on, the alarm history for the page number set as the alarm history read page number is read to the alarm history table. When reading of alarm history is complete, the alarm history read complete signal (ALHRF) is turned on or alarm history read error signal (ALHRE) is turned on.</p>
ALHI	Alarm history initialization command	<p>[Function] Initialization of the alarm history stored in the alarm history buffer area (flash ROM)</p> <p>[Operation] When the alarm history initialization command signal (ALHI) is turned on, the alarm history is initialized and the number of valid alarm history events are 0 cleared.</p>

7. AUXILIARY FUNCTION

(b) Details concerning system status bits

Abbreviation	Signal name	Function details
MINFC	Machine type information (CCF)	<p>[Function] Shows that the controller connected is a Q173SCCF.</p> <p>[Operation] <Conditions for turning on> Q173SCCF is connected. <Conditions for turning off> A controller other than Q173SCCF is connected.</p>
AHINF	Alarm history information	<p>[Function] Shows that Q173SCCF is alarm history compatible.</p> <p>[Operation] <Conditions for turning on> An alarm history compatible Q173SCCF is connected. <Conditions for turning off> A Q173SCCF that is not alarm history compatible is connected.</p>
ALHRF	Alarm history read complete	<p>[Function] Notifies that reading of alarm history was completed normally.</p> <p>[Operation] <Conditions for turning on> Reading of alarm history is completed normally. <Conditions for turning off> Alarm history read command signal (ALHR) was turned off.</p>
ALHRE	Alarm history read error	<p>[Function] Notifies that reading of alarm history was not completed normally.</p> <p>[Operation] <Conditions for turning on> Alarm history read command signal (ALHR) was turned on with an alarm history read page number set outside page number limits. <Conditions for turning off> Alarm history read command signal (ALHR) was turned off.</p>
ALHIF	Alarm history initialization complete	<p>[Function] Notifies that alarm history initialization was completed normally.</p> <p>[Operation] <Conditions for turning on> Initialization of alarm history is completed normally. <Conditions for turning off> Initialization of data entered through turning the alarm history initialization command signal (ALHI) on. The alarm history initialization command signal (ALHI) was turned off.</p>
ALHIE	Alarm history initialization error	<p>[Function] Notifies that alarm history initialization was not completed normally.</p> <p>[Operation] <Conditions for turning on> Alarm history initialization command signal (ALHI) was turned on with a value other than E15Ah set to the alarm history initialization ID. <Conditions for turning off> The alarm history initialization command signal (ALHI) was turned off.</p>

7. AUXILIARY FUNCTION

(2) System Command/Status Data

(a) System Commands

Address	Name	Setting range	Remarks
0444	Alarm history read page number	1 to 512	Sets the page number for the alarm history area for alarm history to be read to. Data for 4 events of alarm history are read for each page. Example. When the number of valid events is 1250 events $1250/4 = 312 \cdot \cdot \cdot 2$ In other words, pages 1 to 313 are read.
0445			
0446	Alarm history initialization ID	E15Ah	When initializing the alarm history, set "E15Ah" Refer to Section 7.17.5 for details.
0447			
0448	System startup time	00000000 00000000h to FFFFFFFF FFFFFFFFh	When the API library sscSystemStart function is used, the C Controller module stores the time of system startup. When the API library is not used, perform system startup after storing the number of seconds since 0000hrs, January 1, 1970. Refer to Section 4.5 for details.
:			
044F			

(b) System status

Address	Name	Output limits	Remarks
04B4	Alarm history read page number	1 to 512	Stores the page number that was read. The details of the settings for the alarm history read page number of the system command are stored.
04B5			
04B6	Number of valid alarm history events	0 to 2047	Stores the number of valid events stored in current alarm history. When the number of valid events reaches 2047 events the number of valid events becomes 2047.
04B7			

7. AUXILIARY FUNCTION

7.17.4 Timing chart for alarm history read

A method for reading alarm history stored in the alarm history area is shown below.

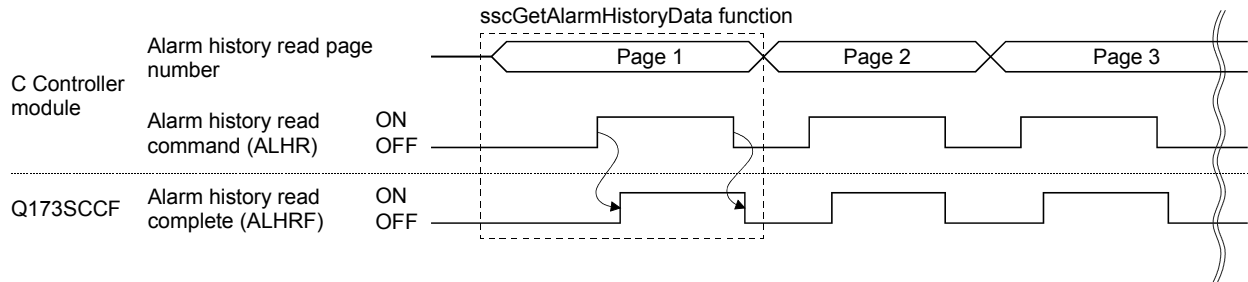

POINT

- The alarm history is stored in the alarm history area of the Q173SCCF flash ROM in ring buffer format. The data is read from the oldest data first when transmitting to the dual port memory.

API LIBRARY

- Use the `sscGetAlarmHistoryData` function to read the alarm history. Calculate the largest page number (divide the number of valid events by 4 and round up to nearest whole number) to be read by using the number of valid events got with the `sscCheckAlarmHistoryEventNum` function. Use this function to get alarm history data from page 1 to the largest page number to be read.

7. AUXILIARY FUNCTION

7.17.5 Alarm history initialization procedure

The procedure for initialization of parameters are as follows.

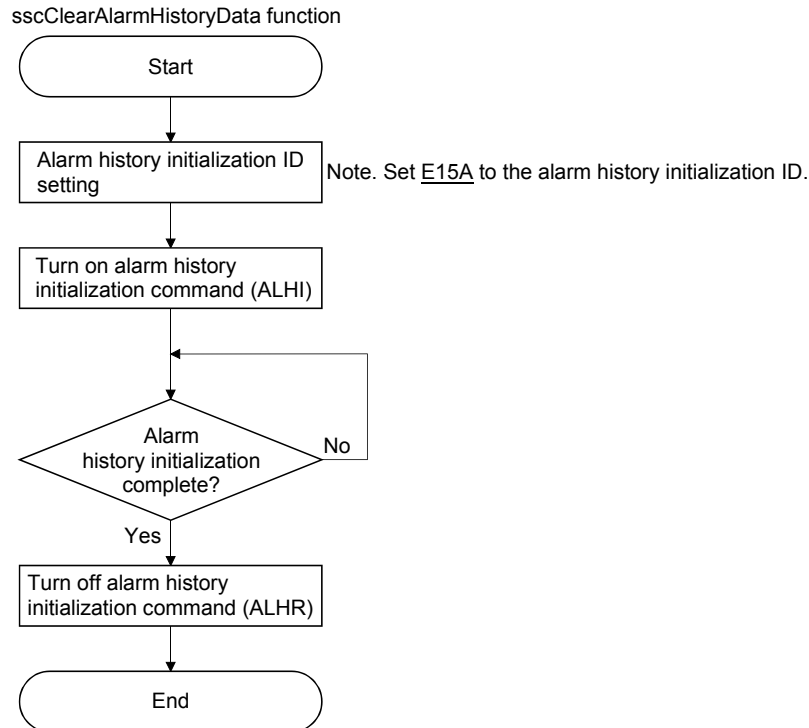

POINT

- Do not turn off the power supply to the Q173SCCF during initialization of alarm history.
- Alarm history data cannot be read during initialization of alarm history.

API LIBRARY

- Use the sscClearAlarmHistoryData function to initialize alarm history.

7.17.6 List of system errors that do not apply to alarm history storage

System errors that do not apply to alarm history storage are shown below.

Error code	Content
E001	ROM error
E002	RAM error 1
E003	Dual port memory error
E004	RAM error 2
E006	SSCNET communication IC error 1
E007	SSCNET communication IC error 2
E008	Board error
E1□□	CPU error
EF01	System command code error

7. AUXILIARY FUNCTION

7.18 Transient transmit

7.18.1 Summary

Using the transient transmit function allows the buffer memory of a servo amplifier or intelligent function module connected to a remote I/O module to be accessed directly from the Q173SCCF.

Compared to the monitor function, the transient transmit data receives data at a slower speed, however it is used to get data that isn't required to be read at a fixed cycle. Additionally, commands can be sent depending on the data type.

API LIBRARY

- Use the `sscSendReceiveTransientData` function to send and receive data by transient transmit.

7.18.2 Interface

The command/status data related to the transient transmit function are shown below.

(1) Transient transmit command

Address	Name	Setting range	Remarks
D400	Command transmission request (2 bytes)	0000h to 0001h	Requests transmission of transient command. 1: Transient request Other than the above: No request Note 1. If the value is changed while processing, the process is not interrupted. Note 2. For "1: Transient request", all data is cleared to 0 upon the completion of all processes.
D402	Transient command (2 bytes)	0000h to FFFFh	Sets the transient command to be sent. Note. Without checking the value, the set value is sent to the servo amplifier as a command. Do not set values other than those that are set for transient commands as the servo amplifier operation for other values is not guaranteed.
D404	Request data 1 (2 bytes)	0000h to FFFFh	Sets the request data. Note 1. Without checking the value, the set value is sent to the servo amplifier as a command. Note 2. Set "0" when request data is not defined by command.
D406	Request data 2 (2 bytes)	0000h to FFFFh	
D408	Request data 3 (2 bytes)	0000h to FFFFh	
D40A	Request data 4 (2 bytes)	0000h to FFFFh	
D40C	Reserved		
D40D			
D40E			
D40F			

Note 1. The addresses above are the addresses for the first axis. For the second axis and after, increase by 20h for each axis.

Note 2. The start address for the first station is DA00h. For the second station and after, increase by 20h for each station.

7. AUXILIARY FUNCTION

(2) Transient transmit status

Address	Name	Setting range	Remarks
D410	Transient status (2 bytes)	0000h to 800Fh	The process after sending transient request is stored. bit0: Transient command processing completion wait bit1: Transient request start bit2: Transient receiving bit3: Transient reception completed normally bitF: Data valid bit 1: ON (transient normal) 0: OFF (abnormal occurrence) Note. An abnormal occurrence is when there is a failure in communication, or a transient request is conducted to an axis/station other than the send target axis/station.
D412	Reserved		
D413			
D414	Response data 1 (2 bytes)	0000h to FFFFh	The response data is stored. The response data includes valid data and invalid data (0), and is always stored as 4 words.
D416	Response data 2 (2 bytes)	0000h to FFFFh	
D418	Response data 3 (2 bytes)	0000h to FFFFh	
D41A	Response data 4 (2 bytes)	0000h to FFFFh	
D41C	Reserved		
D41D			
D41E			
D41F			

Note 1. The addresses above are the addresses for the first axis. For the second axis and after, increase by 20h for each axis.

Note 2. The start address for the first station is DA10h. For the second station and after, increase by 20h for each station.

7. AUXILIARY FUNCTION

7.18.3 Transient commands for servo amplifier

Data type	Transient command	Unit	Number of valid words (Note 1)	Remark
Servo motor ID (SSCNETⅢ)/ Encoder ID	0304	—	3	
Servo motor ID (SSCNETⅢ/H)	0309	—	2	
Encoder resolution	0305	[pulse]	2	
Servo amplifier serial number (First 8 characters)	0306	[characters]	4	
Servo amplifier serial number (Last 8 characters)	0307	[characters]	4	
Servo amplifier recognition information (First 8 characters)	0310	[characters]	4	
Servo amplifier recognition information (Last 8 characters)	0311	[characters]	4	
Servo amplifier software number (First 8 characters)	0312	[characters]	4	
Servo amplifier software number (Last 8 characters)	0313	[characters]	4	
Power ON cumulative time	0319	[h]	2	
Inrush relay ON/OFF number	031A	[times]	2	Returns the contactor ON count.
Read alarm history number	0323	[items]	1	
Alarm history/Detail #1, #2	0324	—	4	
Alarm history/Detail #3, #4	0325	—	4	
Alarm history/Detail #5, #6	0326	—	4	
Alarm history/Detail/Occurrence time	0328	—/[h]	4	
Alarm occurrence time #1, #2	0329	[h]	4	
Alarm occurrence time #3, #4	032A	[h]	4	
Alarm occurrence time #5, #6	032B	[h]	4	
Alarm history clear command	0382	—	0	
Home position [command unit]	0408	[pulse]/[rev]	3	
Main circuit bus voltage	040A	[V]	1	
Regenerative load ratio	040B	[%]	1	
Effective load ratio	040C	[%]	1	
Peak load ratio	040D	[%]	1	
Estimate inertia moment ratio	040E	[×0.1]	1	
Model loop gain	040F	[rad/s]	1	
LED display	0410	[characters]	2	
Load-side encoder information 1	0416	[pulse]	2	Fully closed control or synchronous encoder via servo amplifier use
Load-side encoder information 2	0417	[pulse]	2	
Speed feedback	0418	[0.01mm/s]	2	Linear servo use
Servo motor thermistor temperature	0419	[°C]	1	Linear servo use
Z-phase counter	041A	[pulse]	2	
Module power consumption	0424	[W]	2	
Module integral power consumption	0425	[Wh]	2	
Disturbance torque	0427	[0.1%]	1	
Instantaneous torque	0428	[0.1%]	1	
Overload alarm margin	0429	[0.1%]	1	
Error excessive alarm margin	042A	[pulse]	2	
Settling time	042B	[ms]	1	
Overshoot amount	042C	[pulse]	1	
Servo motor side/load-side position deviation	042D	—	2	Fully closed control use

7. AUXILIARY FUNCTION

Data type	Transient command	Unit	Number of valid words (Note 1)	Remark
Servo motor side/load-side speed deviation	042E	—	2	
Machine diagnostic status	042F	—	1	
Friction estimation data	0430	[0.1%]	4	
Vibration estimation data	0431	[Hz/0.1%]	4	
Internal temperature of encoder	0434	[°C]	1	For encoders that are not supported, 0 is returned.
Optional transient command	—	—	4	Used when using an optional transient command.

Note 1. Number of valid words for response data 1 to 4.

(1) Servo motor ID (SSCNET \mathbb{III})/Encoder ID [0304h]

Request data	Content
Request data 1	Reserved
Request data 2	Reserved
Request data 3	Reserved
Request data 4	Reserved

Response data	Content
Response data 1	Servo motor ID (lower)
Response data 2	Servo motor ID (upper)
Response data 3	Encoder ID
Response data 4	Reserved

(2) Servo motor ID (SSCNET \mathbb{III} /H) [0309h]

Request data	Content
Request data 1	Reserved
Request data 2	Reserved
Request data 3	Reserved
Request data 4	Reserved

Response data	Content
Response data 1	Servo motor ID (lower)
Response data 2	Servo motor ID (upper)
Response data 3	Reserved
Response data 4	Reserved

(3) Alarm history/Detail #1, #2 [0324h]

Request data	Content
Request data 1	Reserved
Request data 2	Reserved
Request data 3	Reserved
Request data 4	Reserved

Response data	Content
Response data 1	Alarm history 1
Response data 2	Alarm detail 1
Response data 3	Alarm history 2
Response data 4	Alarm detail 2

(4) Alarm history/Detail/Occurrence time [0328h]

Request data	Content
Request data 1	Alarm history number (from N=0)
Request data 2	Reserved
Request data 3	Reserved
Request data 4	Reserved

Response data	Content
Response data 1	Alarm history number #(N+1)
Response data 2	Alarm history number #(N+1) detail
Response data 3	Alarm history number #(N+1) occurrence time (lower)
Response data 4	Alarm history number #(N+1) occurrence time (upper)

(5) Alarm history clear command [0382h]

Request data	Content
Request data 1	Alarm reset command (1EA5h)
Request data 2	Reserved
Request data 3	Reserved
Request data 4	Reserved

Response data	Content
Response data 1	Reserved
Response data 2	Reserved
Response data 3	Reserved
Response data 4	Reserved

7. AUXILIARY FUNCTION

(6) Home position [command unit] [0408h]

Request data	Content
Request data 1	Reserved
Request data 2	Reserved
Request data 3	Reserved
Request data 4	Reserved

Response data	Content
Response data 1	Home position within one revolution (lower)
Response data 2	Home position within one revolution (upper)
Response data 3	Home position multiple revolution counter
Response data 4	Reserved

(7) LED display [0410h]

Request data	Content
Request data 1	Reserved
Request data 2	Reserved
Request data 3	Reserved
Request data 4	Reserved

Response data	Content
Response data 1	Driver display status (7segLED) lower 2 digits
Response data 2	Character [JIS8 code] upper 2 digits
Response data 3	Reserved
Response data 4	Reserved

(8) Machine diagnostic status [042Fh]

Request data	Content
Request data 1	Reserved
Request data 2	Reserved
Request data 3	Reserved
Request data 4	Reserved

Response data	Content
Response data 1	<div style="display: flex; align-items: center;"> <div style="border: 1px solid black; padding: 2px; margin-right: 5px;">0</div> <div style="border: 1px solid black; width: 20px; height: 20px; margin-right: 5px;"></div> <div style="border: 1px solid black; width: 20px; height: 20px; margin-right: 5px;"></div> <div style="border: 1px solid black; width: 20px; height: 20px;"></div> </div> <ul style="list-style-type: none"> Forward rotation friction 0: Estimating friction 1: Estimating complete 2: One side operation (motor rotation stays in one direction) 3: Parameter threshold exceeded 4: Low variation high-speed operation 5: Time constant underestimate 7: 60 minutes elapsed Reverse rotation friction 0: Estimating friction 1: Estimating complete 2: One side operation (motor rotation stays in one direction) 3: Parameter threshold exceeded 4: Low variation high-speed operation 5: Time constant underestimate 7: 60 minutes elapsed Vibration estimation 0: Estimating vibration 1: Estimating complete
Response data 2	Reserved
Response data 3	Reserved
Response data 4	Reserved

7. AUXILIARY FUNCTION

(9) Friction estimation data [0430h]

Request data	Content
Request data 1	Reserved
Request data 2	Reserved
Request data 3	Reserved
Request data 4	Reserved

Response data	Content
Response data 1	Forward rotation torque static friction [0.1%]
Response data 2	Forward rotation torque kinetic friction (at rated speed) [0.1%]
Response data 3	Reverse rotation torque static friction [0.1%]
Response data 4	Reverse rotation torque kinetic friction (at rated speed) [0.1%]

(10) Vibration estimation data [0431h]

Request data	Content
Request data 1	Reserved
Request data 2	Reserved
Request data 3	Reserved
Request data 4	Reserved

Response data	Content
Response data 1	Motor stopped/servo amplifier locked Oscillation frequency [Hz]
Response data 2	Motor stopped/servo amplifier locked Vibration level [0.1%]
Response data 3	Motor operating Oscillation frequency [Hz]
Response data 4	Motor operating Vibration level [0.1%]

POINT
<ul style="list-style-type: none"> Input 0 for request data that is reserved. Get the "friction estimation data" and "vibration estimation data" with transient command after conducting machine diagnosis estimation.

7.18.4 Example of using transient commands

(1) Friction estimation data/vibration estimation data

Setting "friction estimation data" and "vibration estimation data" to the transient command does not enable the correct values to be stored. With the procedure below, perform machine diagnosis and refer to the values.

- Operate the servo motor approximately 20 minutes in the operation pattern of machine diagnosis function - Friction judgement speed (servo parameter No.121E) until the diagnosis function is complete.
- Check that the "forward rotation friction", "reverse rotation friction", and "vibration estimation" values of machine diagnostic status are 1: Estimating complete. When the values are not that of estimating complete and machine diagnosis fails, repeat the operating procedure starting from (a).
- Set "friction estimation data" and "vibration estimation data" to the transient command, and turn ON the transient request.

POINT
<ul style="list-style-type: none"> Refer to Servo Amplifier Instruction Manual for operation pattern of machine diagnosis function.

7. AUXILIARY FUNCTION

7.18.5 Transient commands for SSCNETⅢ/H head module

Data type	Transient command	Unit	Number of valid words (Note 1)	Remark
Buffer memory read	0211	—	4	
Buffer memory write (2byte)	0291	—	1	
Buffer memory write (4byte)	0292	—	1	

Note 1. Number of valid words for response data 1 to 4.

(1) Buffer memory read [0211h]

Request data	Content
Request data 1	Start I/O No. (first 2 digits of 3-digit display)
Request data 2	Buffer memory address
Request data 3	Number of read data (1 to 4)
Request data 4	0 (fixed value)

Response data	Content
Response data 1	2-byte data of buffer memory address+0
Response data 2	2-byte data of buffer memory address+2
Response data 3	2-byte data of buffer memory address+4
Response data 4	2-byte data of buffer memory address+6

(2) Buffer memory write (2byte) [0291h]

Request data	Content
Request data 1	Start I/O No. (first 2 digits of 3-digit display)
Request data 2	Buffer memory address
Request data 3	Write data
Request data 4	0 (fixed value)

Response data	Content
Response data 1	0 (fixed value)
Response data 2	0 (fixed value)
Response data 3	0 (fixed value)
Response data 4	0 (fixed value)

(3) Buffer memory write (4byte) [0292h]

Request data	Content
Request data 1	Start I/O No. (first 2 digits of 3-digit display)
Request data 2	Buffer memory address
Request data 3	Write data (lower)
Request data 4	Write data (upper)

Response data	Content
Response data 1	0 (fixed value)
Response data 2	0 (fixed value)
Response data 3	0 (fixed value)
Response data 4	0 (fixed value)

POINT

- Set the first 2 digits for the start I/O No. when the start I/O No. of the intelligent function module is a 3-digit display.
(Example. When start I/O No. is 1F0h, set 1Fh)

7. AUXILIARY FUNCTION

7.19 Hot line forced stop function

7.19.1 Summary

When an alarm occurs in a MR-JE-□B servo amplifier, the hot line forced stop function stops the other axes on the same line with a deceleration stop, allowing the axes to stop safely. When the main circuit power is shut-off at a servo alarm occurrence, use this function.

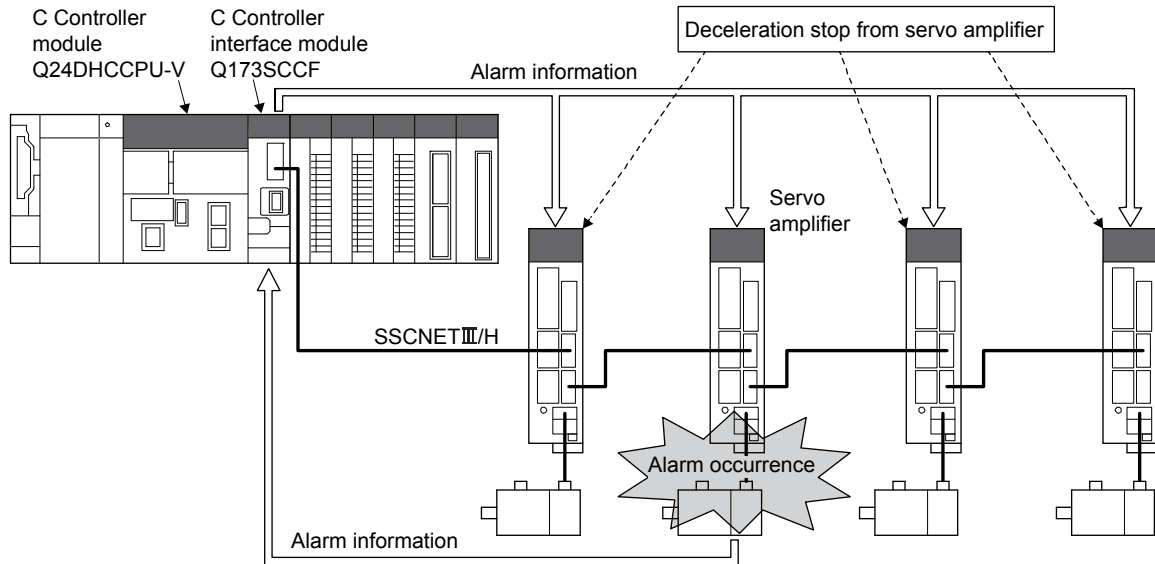

POINT

- For the MR-JE-□B, the control power supply and main circuit power are integrated. Therefore when L1/2/3, the equivalent of the main circuit power of MR-J4(W□)-□B is shut-off, the control power supply of the servo amplifier is turned OFF. Consequently, SSCNET communication of the axes after the axis where the alarm occurred is disconnected when the wiring is designed to shut-off the main circuit power at an alarm occurrence. When this occurs, the Q173SCCF can no longer control the disconnected axes and they are stopped by dynamic brake. Thus, if the hot line forced stop function is not used, machinery may cause a collision due to the coasting distance. When SSCNET communication is disconnected, a system error (E40□h) occurs.
- System errors cannot be reset. Reboot the software, restart the system as required.

7. AUXILIARY FUNCTION

7.19.2 Control details

The hot line forced stop function is set by a servo parameter. By using this function, other axes are stopped with a deceleration stop by a notification from the axis where the servo alarm occurred, without going through the control from the Q173SCCF. The hot line forced stop function is enabled by factory default in the MR-JE-□B. To disable the function, set 1 (disabled) in hot line forced stop function selection of hot line forced stop function (servo parameter No.111A).

Also, when using MR-JE-□B and MR-J4(W□)-□B together, the hot line forced stop function can stop MR-J4(W□)-□B axes with a deceleration stop when an alarm occurs in a MR-JE-□B.

In order to stop MR-J4(W□)-□B with a deceleration stop as well, set 2 (enabled) in hot line forced stop deceleration stop selection of hot line forced stop function (servo parameter No.111A) of MR-J4(W□)-□B. (The factory default is "0" (disabled).)

Refer to Servo Amplifier Instruction Manual for details.

POINT	<ul style="list-style-type: none"> For axes that deceleration stop by the hot line forced stop function, a controller forced stop warning (servo warning E7) occurs.
-------	---

The setting values for hot line forced stop function selection (servo parameter No.111A), and the operation in the servo amplifier is shown below.

(1) Using MR-JE-□B

Setting value	Hot line output	Deceleration stop at the receiving of hot line signal
0: Enabled (initial value)	Enabled	Enabled
1: Disabled	Disabled	Disabled

(2) Using MR-J4(W□)-□B

Setting value	Hot line output	Deceleration stop at the receiving of hot line signal
0: Disabled (initial value)	Disabled	Disabled
2: Enabled	Disabled	Enabled

Use a software version that supports hot line forced stop function for the servo amplifier. Servo amplifier software versions that support hot line forced stop function are shown in the table below.

Servo amplifier model	Software version
MR-J4(W□)-B□	B7 or later
MR-JE-□B	B6 or later

POINT	<ul style="list-style-type: none"> Servo amplifiers other than the above do not support the hot line forced stop function and therefore do not perform a hot line output or deceleration stop at the receiving of hot line signal.
-------	---

7. AUXILIARY FUNCTION

7.19.3 Timing for alarm occurrences

A timing chart using for servo alarm occurrence is shown below.

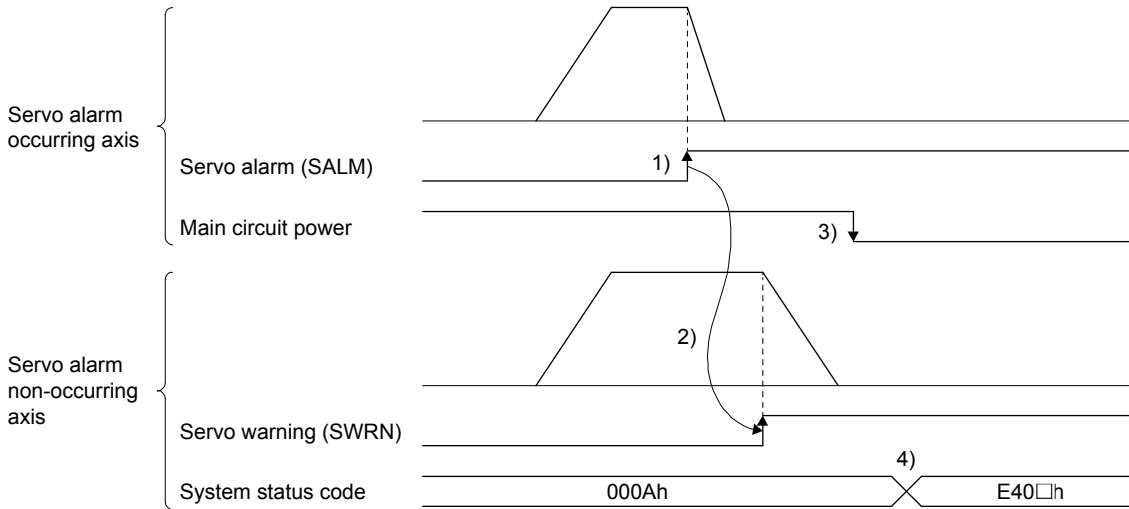

- 1) A servo alarm occurs, and a stop is performed by dynamic brake.
- 2) The servo alarm non-occurring axis receives notification from the servo alarm occurring axis, and servo warning (SWRN) turns ON.
- 3) Checks that servo alarm non-occurring axes are stopped, and main circuit power is shut-off by C Controller module command. (If the main circuit power is shut-off before servo warning (SWRN) turns ON in the servo alarm non-occurring axis, a deceleration stop by this function may not perform correctly.)
- 4) System error (E40□h) occurs.

8. TANDEM DRIVE

8. TANDEM DRIVE

Tandem drive is that 1 axis is physically connected to and driven by 2 motors. The Q173SCCF provides the same position command to the 2 axes set up for tandem drive.

Tandem drive can be set up for a maximum of 8 sets (16 axes).

8.1 Drive modes

For tandem drive there are 2 drive modes; synchronous mode and non-synchronous micro-adjustment control mode.

Types of operation that can be performed for each mode are as follows.

Operation mode	Drive Modes	
	Synchronous mode	Non-synchronous mode
JOG operation	○	○
Incremental feed	○	○
Automatic operation	○	×
Linear interpolation operation	○	×
Home position return	△ (Note)	×
Home position reset	○	×

Note. Home position return operation can be performed only using the following home position return method. If a different method is used to perform home position return, the tandem drive excursing error (operation alarm 52, detail 01) occurs.

Compatible home position return method

- Dog cradle method
- Dog method
- Data set method
- Dog front end method
- Z-phase detection method
- Scale home position signal detection method
- Scale home position signal detection method 2

POINT
▪ Performing start operation with a non-compatible mode during a non-synchronous micro-adjustment mode makes an alarm for tandem drive non-synchronous mode (operation alarm 51, detail 01) occur.

8. TANDEM DRIVE

8.1.1 Synchronous mode

Through providing the master and slave axes the same position command, they move together. Each axis uses a feedback signal position loop, speed loop, and current loop for control.

8.1.2 Non-synchronous micro-adjustment control mode

Non-synchronous micro-adjustment control mode temporarily cancels synchronizing in order to adjust the position balance between the master axis and the slave axis. This enables submitting different position commands to each of the axes. This can only be done using incremental feed or JOG operation.

When home position return has been completed, even if the tandem drive mode is switched to non-synchronous micro-adjustment mode, the system is not switched to non-home position return complete (home position return request (ZREQ) is not ON). After the mode is switched to the synchronous mode, automatic operation and linear interpolation can be performed without re-performing home position return.

POINT	
	<ul style="list-style-type: none">▪ If the synchronization setting (parameter No.0265) is set to valid, synchronization is not completed when the mode is switched to the non-synchronous micro-adjustment mode. When the mode is switched to the synchronous mode again, turn the servo off and then on, then perform synchronization. When automatic operation or linear interpolation is performed with synchronization incomplete, the tandem drive synchronous alignment error (operation error 58, detail 02) occurs.▪ When the synchronization setting (parameter No.0265) is set to invalid, the operation in the synchronization mode is performed based on the master axis holding deviation between master axis and slave axis at switching the mode to the synchronization mode.

8. TANDEM DRIVE

8.1.3 Changing of drive mode

The changing of modes is performed using ON/OFF of the non-synchronous command signal (ASYN□: □ is the group number). Changing of mode can be performed on a group basis.

Changing of drive mode can only be performed when all of the following conditions are satisfied.

- The during smoothing of stopping (SMZ) is on for both the master axis and the slave axis.
- The in-position signal (INP) is ON for both the master axis and slave axis.
- No operation alarm has occurred for both the master axis and slave axis.
- Neither the master axis nor the slave axis is operating.
- They are not being synchronized.

If even one of the conditions is not satisfied, the tandem drive mode change error (operation alarm 50, detail 01) occurs.

(1) Example when drive mode can be changed

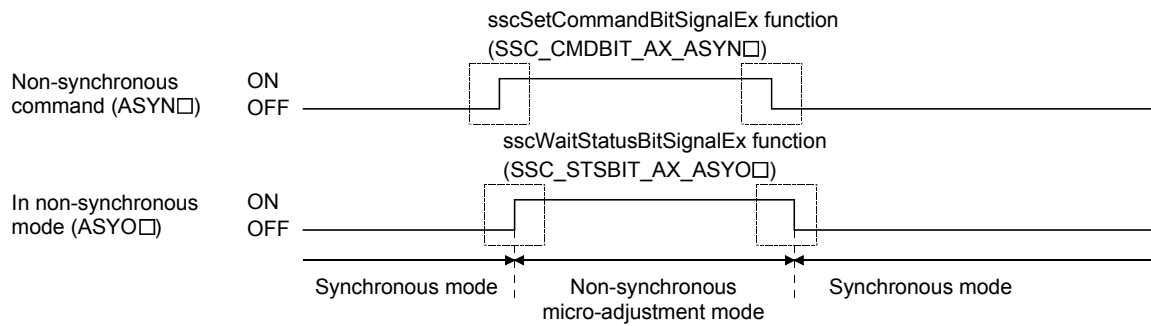

(2) Example when drive mode can not be changed (the in-position signal (INP) of the master axis is OFF)

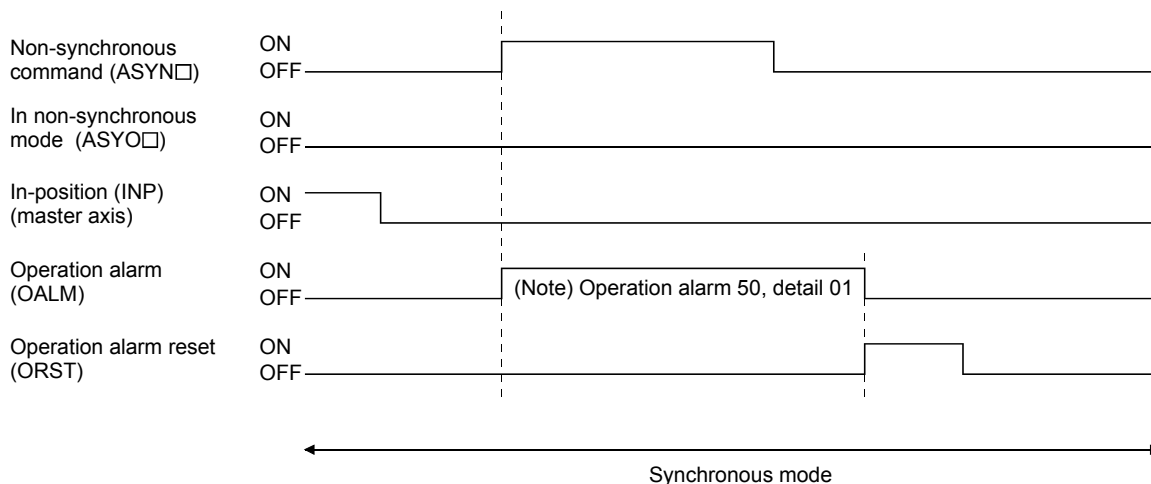

Note. When the tandem drive mode change error (operation alarm 50, detail 01) has been set, after returning the Non-synchronous command signal (ASYN□) to its normal status, turn the operation alarm reset signal (ORST) on to cancel the operation alarm.

When changing from non-synchronous micro-adjustment mode to synchronous mode, of the axis data for the slave axis, only the data that is valid for the master axis (refer to Section 8.3) is saved from the non-synchronous micro-adjustment mode. Zero clear and the like is not performed.

8. TANDEM DRIVE

8.2 Parameter settings

8.2.1 Designation of tandem drive axes

Setting the group number in the tandem drive group (parameter No.0264) defines the tandem drive axis. The 2 axes that are set to the same group No. can be driven in parallel. The maximum number of groups that can be driven in parallel is 8 (groups 1 to 8). Of the 2 axes that are designated with the same tandem drive group number the axis with the smaller axis No. is the master axis and the axis with the larger axis No. is the slave axis.

Control cycle	Valid group number
0.88ms	1 to 8
0.44ms	1 to 8
0.22ms	1 to 4

POINT
<ul style="list-style-type: none">▪ For the following conditions, upon system startup, the tandem drive axis setting value error (operation alarm 52, detail 02) occurs, and tandem drive control can not be performed.<ul style="list-style-type: none">▪ If the complement axis is not set up▪ If 3 or more axes are set up with the same group number▪ If the group number exceeds the valid group number

8.2.2 Servo parameters

Set the servo parameters to the same values for the axes for which tandem drive is performed. However, the rotation direction selection (servo parameter No.110D) can be different values depending on mechanical specifications.

8.2.3 Control parameters

The settings of the control parameters for when using tandem drive can be selected from among the following 3 selections: "only values of master axis are valid", "set master/slave axes to same values", and "master and slave can be set separately". Only master axis values are valid means that the parameter settings of the master axis are used for both the master and the slave. In this case, the parameters of the slave axis are ignored. Refer to Chapter 11 for setting classifications of each control parameter.

8. TANDEM DRIVE

8.3 Axis data classifications

Axis data for tandem drive axes have 2 data type settings: "only master axis data is valid" and "master axis/slave axis data are separate".

POINT
<ul style="list-style-type: none">▪ Refer to Section 10.7 concerning axis data classifications for tandem drive axes. In this table, "only master axis data is valid" is designated as "master" while "master axis/slave axis data are separate" is designated as "axes separate".▪ It is possible to review monitor data for each axis individually.

8.3.1 Only data from master axis is valid

(1) Command table data

When the drive mode is synchronous mode, only the command table data from the master axis is valid. For this case the command table data for the slave is ignored. If the drive mode is non-synchronous micro-adjustment mode, each axis becomes valid.

(2) Status table data

When the drive mode is synchronous mode, only the status table data from the master axis is valid. For this case the status table data for the slave axis is optional. If the drive mode is non-synchronous micro-adjustment mode, each axis becomes valid.

8.3.2 Individual data for master axis/slave axis

Data that is valid for each axis independent of the drive mode.

8. TANDEM DRIVE

8.4 Tandem drive axis operation

POINT
<ul style="list-style-type: none">▪ Only have the master axis call the start operation functions of each axis when in synchronous mode.

8.4.1 Home position return during tandem drive

Methods for returning to home position while using tandem drive axes include: dog method, dog cradle method, data set method, Z-phase detection method, scale home position signal detection method, and scale home position signal detection method 2. These home position return methods are performed while in synchronous mode.

Note 1. If a non-compatible method is used to perform home position return, the tandem drive axis setting error (operation alarm 52, detail 01) occurs when home position return is started.

2. When in non-synchronous micro-adjustment mode, the while in tandem drive non-synchronous mode (operation alarm 51, detail 01) occurs when home position return is started.

POINT
<ul style="list-style-type: none">▪ If a non-compatible method is used to perform home position return, the tandem drive axis setting error (operation alarm 52, detail 01) occurs when home position return is started.▪ When in non-synchronous micro-adjustment mode, the while in tandem drive non-synchronous mode (operation alarm 51, detail 01) occurs when home position return is started.▪ The amount of home position shift is set using a control parameter No.0248, 0249. The home position can be shifted by setting the amount of home position shift.▪ If the balance between tandem drive axes is not good just after turning on the power, it can cause stress to the equipment, therefore use non-synchronous micro-adjustment mode to adjust the balance and perform home position return.▪ When home position return is completed, the home position coordinates (master axis parameter No.0246, 0247) are set to the current command position for both the master axis and the slave axis.

8. TANDEM DRIVE

(1) Home position return using a dog method

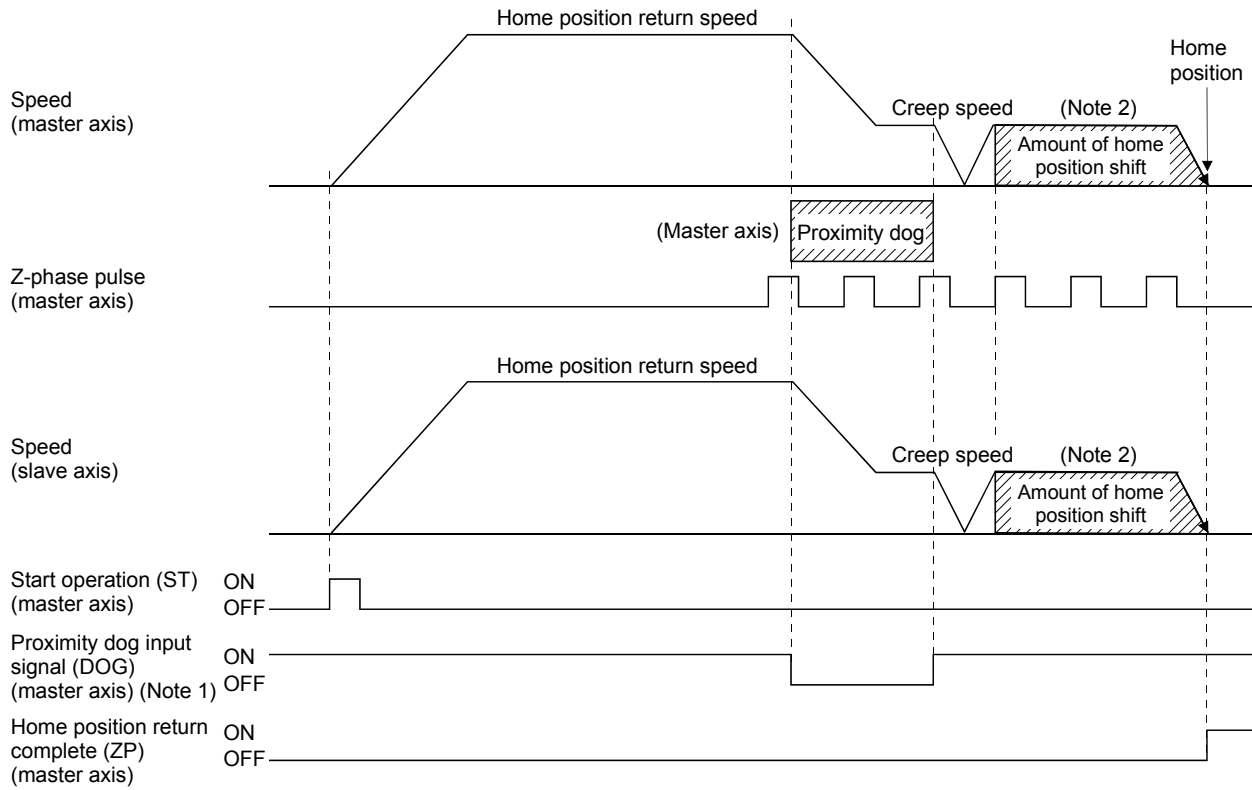

Note 1. The proximity dog signal for the master is the only valid signal. The slave axis also returns to home position based on the dog signal for the master.

- The final stop position for both the master axis and the slave axis is based on the final master axis motor Z-phase. Also, only the master axis parameter for the value for the home position shift amount is valid.

8. TANDEM DRIVE

(2) Home position return using the dog cradle method

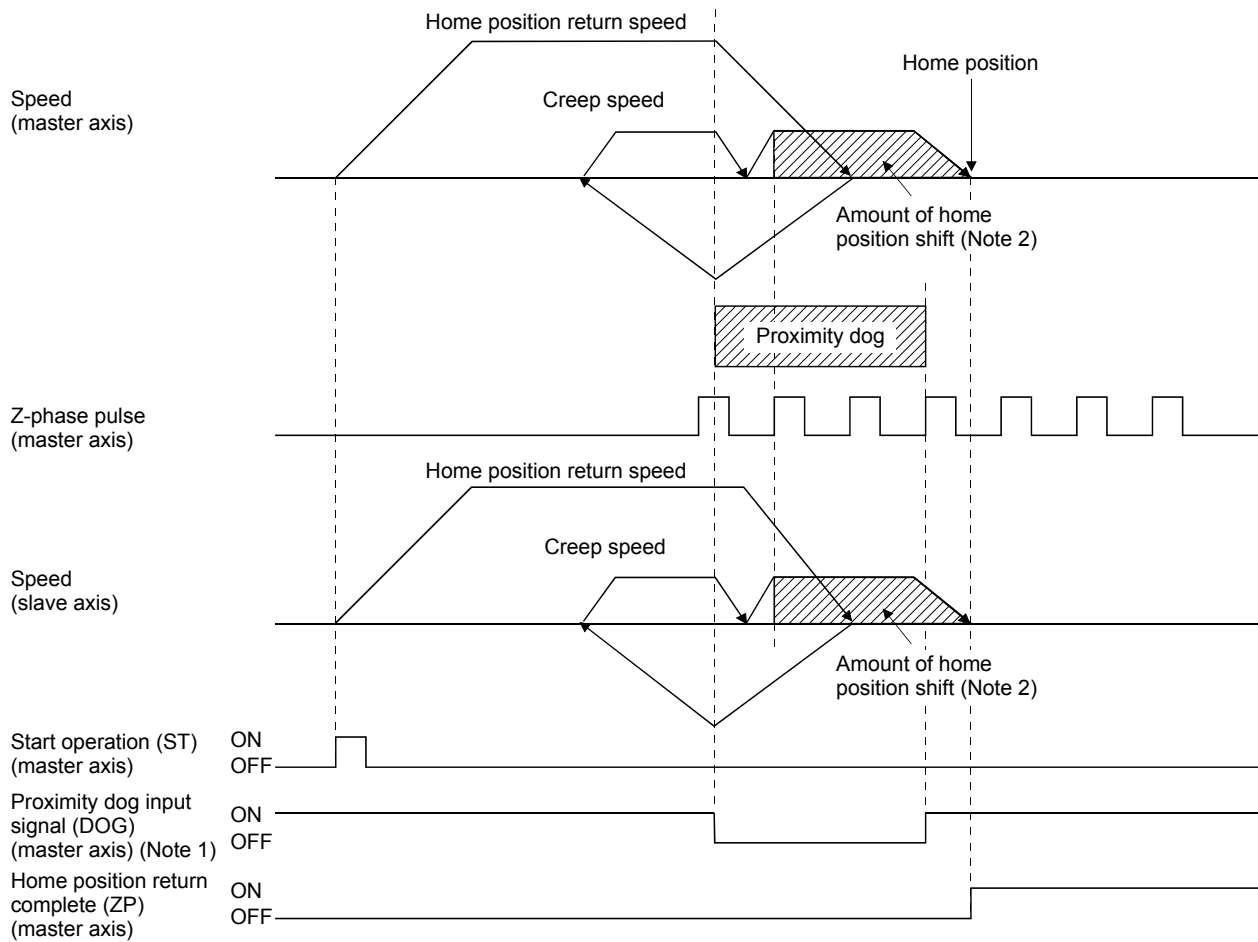

Note 1. The proximity dog signal for the master is the only valid signal. The slave axis also returns to home position based on the dog signal for the master.

Note 2. The final stop position for both the master axis and the slave axis is based on the final master axis motor Z-phase. Also, only the master axis parameter for the value for the home position shift amount is valid.

8. TANDEM DRIVE

(3) Home position return using a data set method

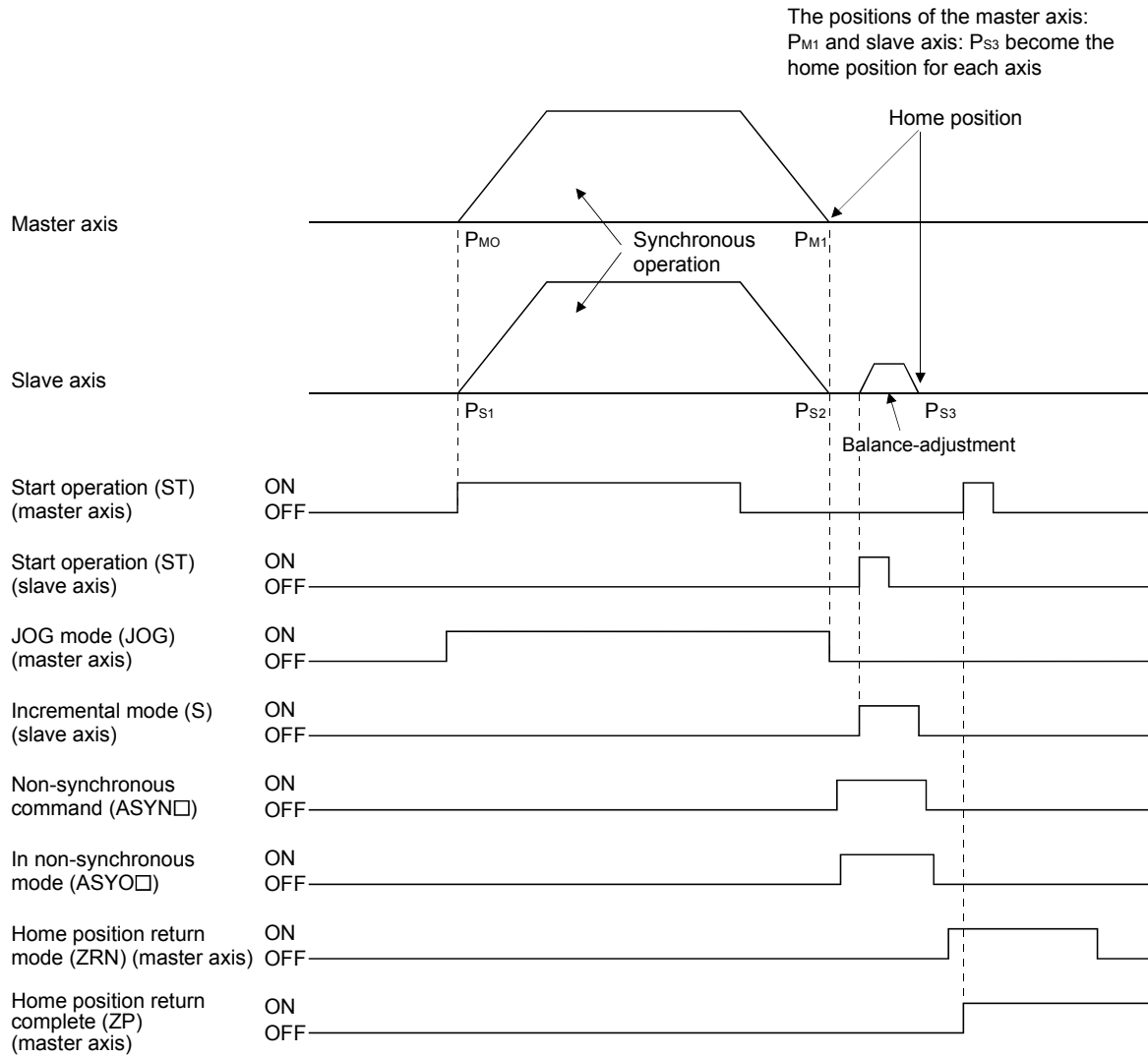

Note. This explanation is an example for using JOG operation for moving to home position.

8. TANDEM DRIVE

(4) Home position return using a dog front end method

Home position return using a dog front end method uses the proximity dog front end as the home position. The following two methods are available for the home position return using a dog front end method with the tandem drive axes: using the proximity dog front end on the master axis as the home position and detecting each proximity dog front end for the master axis and slave axis to perform tweaking (compensation of deviation between master axis and slave axis). Set either of the methods with the compensation of home position return deviation in the tandem drive options (parameter No.0265).

Tandem drive options (parameter No.0265)		Application
Compensation of home position return deviation	Home position return method	
Deviation compensation invalid		Uses the proximity dog front end as the home position. Use this method when there is no need to consider the mechanical deviation such as the case where no deviations occur between master axis and slave axis.
Deviation compensation valid	Adjustment mode	Use this mode to calculate the proximity dog front end offset (amount of deviation in the position of the proximity dog front end for the master axis and slave axis) during mechanical adjustment.
	Normal mode	Use this mode to detect the amount of proximity dog front end deviation between master axis and slave axis and perform tweaking (compensation of deviation between master axis and slave axis) in normal operation so that the axis is mechanically at a right angle.

8. TANDEM DRIVE

(a) Deviation compensation invalid

The motion detected by the proximity dog slows down to stop, and return to the proximity dog front end, setting there to the home position. When deviation compensation is invalid, only the proximity dog signal for the master axis is used.

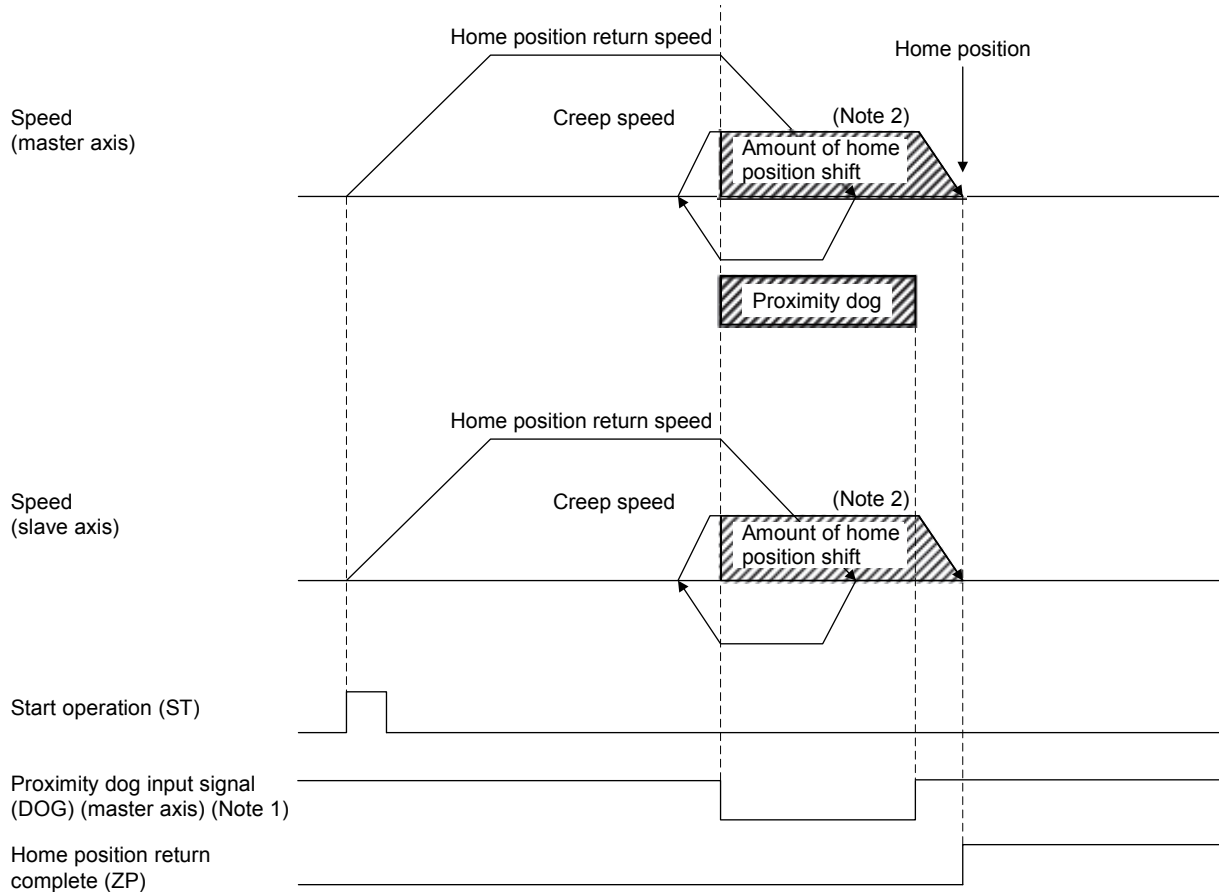

Note 1. The proximity dog signal for the master is the only valid signal. The slave axis also returns to home position based on the proximity dog signal for the master.

2. The final stop position for both the master axis and the slave axis is based on the master axis proximity dog front end. Also, only the master axis parameter for the value for the home position shift amount is valid.

8. TANDEM DRIVE

(b) Deviation compensation valid

The motion detected by the proximity dog slows down to stop, and return to the proximity dog front end, setting there to the home position. When deviation compensation is valid, the proximity dog signals for the master axis and for the slave axis are used to calculate the amount of deviation between each dog front end position or to compensate the deviation between the master axis and the slave axis. To perform the calculation or the compensation of deviation amount, designate adjustment mode or normal mode using tandem drive options (parameter No.0265).

1) Adjustment mode

a) Summary

Adjustment mode is used during mechanical adjustment, and is used to calculate the dog front end position offset (amount of deviation in the position of the proximity dog front end for the master axis and slave axis).

When executing home position return while in adjustment mode, after detecting the master axis dog front end position and the slave axis dog front end position while returning to home position, the axes are moved to the dog front end position of the master axis. At this time the amount of offset from the position of the dog front end for the master axis to the position of the dog front end for the slave axis is calculated and output using the tandem drive home position signal offset (parameter No.026C, 026D). This amount of offset is used when compensating the amount of deviation between the master axis and slave axis when returning to home position; therefore, after completing home position return save this offset on the user program.

Note. Prior to returning to home position, set the axis linking the master axis and slave axis mechanically at a right angle to the movement direction. If it is not at a right angle, the dog front end position offset amount can not be correctly calculated.

8. TANDEM DRIVE

b) Start operation method

1. Adjust the axis linking the master axis and slave axis mechanically at a right angle to the movement direction.
2. Set the home position return method (parameter No.0240) to "Dog front end method" and tandem drive option (parameter No.0265) to "Adjustment mode".
3. Start home position return operation.
4. After home position return is complete, read the tandem drive home position signal offset (parameter No.026C, 026D) and save it to the user program.

c) Operation example for adjustment mode

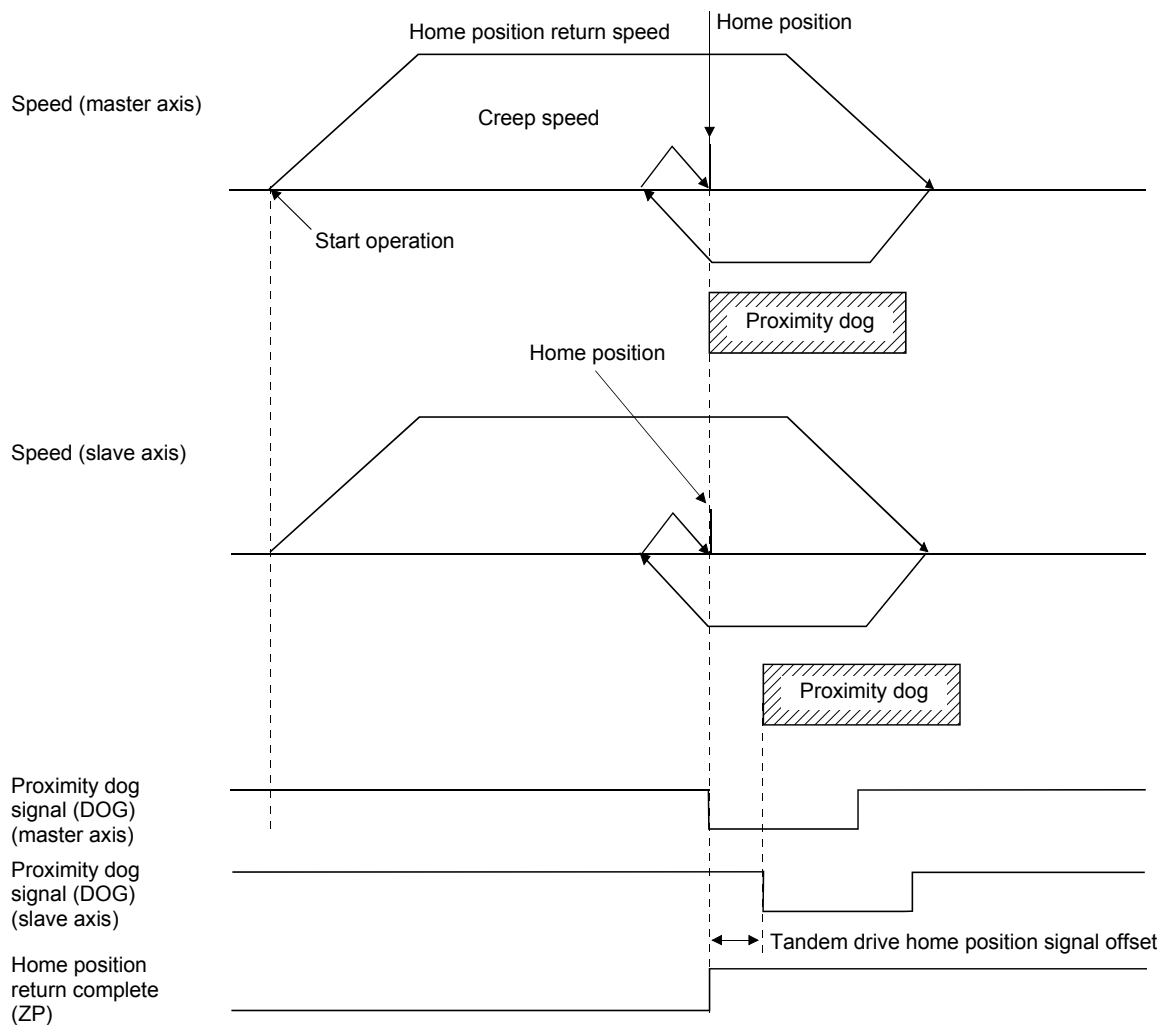

8. TANDEM DRIVE

2) Normal mode

a) Summary

In normal mode, the amount of deviation between the master axis and slave axis is detected and tweaking (compensation of deviation between master axis and slave axis) is performed. This movement sets the axis linking the master axis and slave axis mechanically at a right angle to the movement direction.

When home position return is performed using normal mode, after detecting the master axis dog front end position and slave axis dog front end position while returning to home position, calculate the deviation of the master axis and slave axis based on the tandem drive home position signal offset (parameter No.026C, 026D). The master axis moves to the dog front end position and the slave axis moves to the slave axis home position calculated based on the tandem driver home position signal offset and the previously noted deviation.

Note 1. When performing home position return in normal mode, set the tandem drive home position signal offset (parameter No.026C, 026D) to the correct value. If the tandem drive home position signal offset value is erroneous, the axis that links the master axis and slave axis will not be at a right angle.

2. If the amount of deviation between the master axis and the slave axis exceeds the value calculated from the valid width of tandem drive deviation compensation (parameter No.026B) \times tandem drive deviation compensation units multiplication (parameter No.026E), an exceeding of valid width of tandem drive deviation compensation error (operation alarm 57, detail 01) occurs and home position return operation is terminated. (Tweak movement is not performed.)

b) Start operation method

1. Set the home position return method (parameter No.0240) to "Dog front end method" and tandem drive option (parameter No.0265) to "Normal mode".
2. Set the tandem drive home position signal offset (parameter No.026C, 026D).
3. Start home position return operation.

Note. Through setting the amount of home position shift (parameter No.0248, 0249), the position shifted from dog front end position can be defined as the home position.

8. TANDEM DRIVE

c) Operation example for normal mode

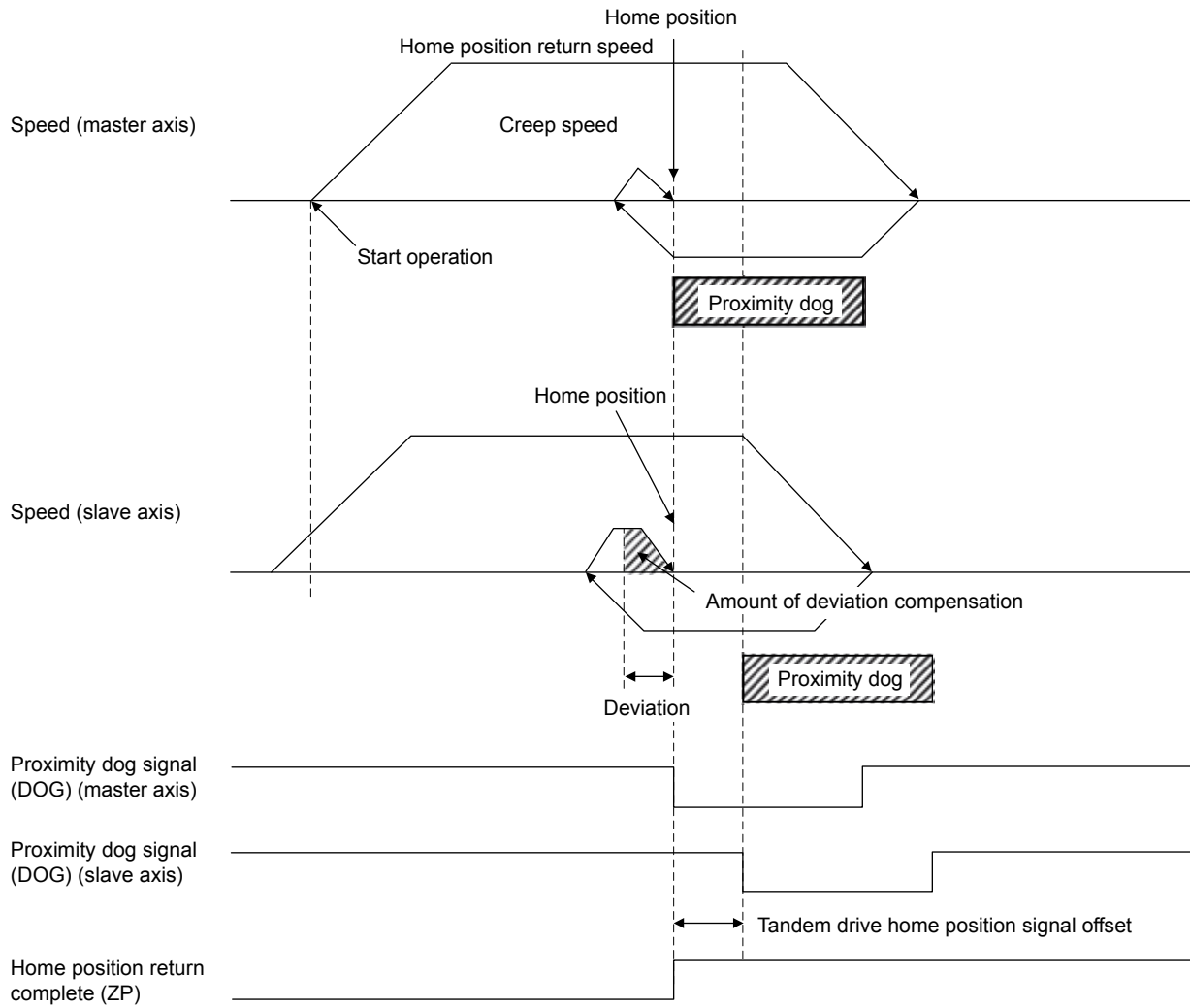

8. TANDEM DRIVE

(5) Home position return using a Z-phase detection method

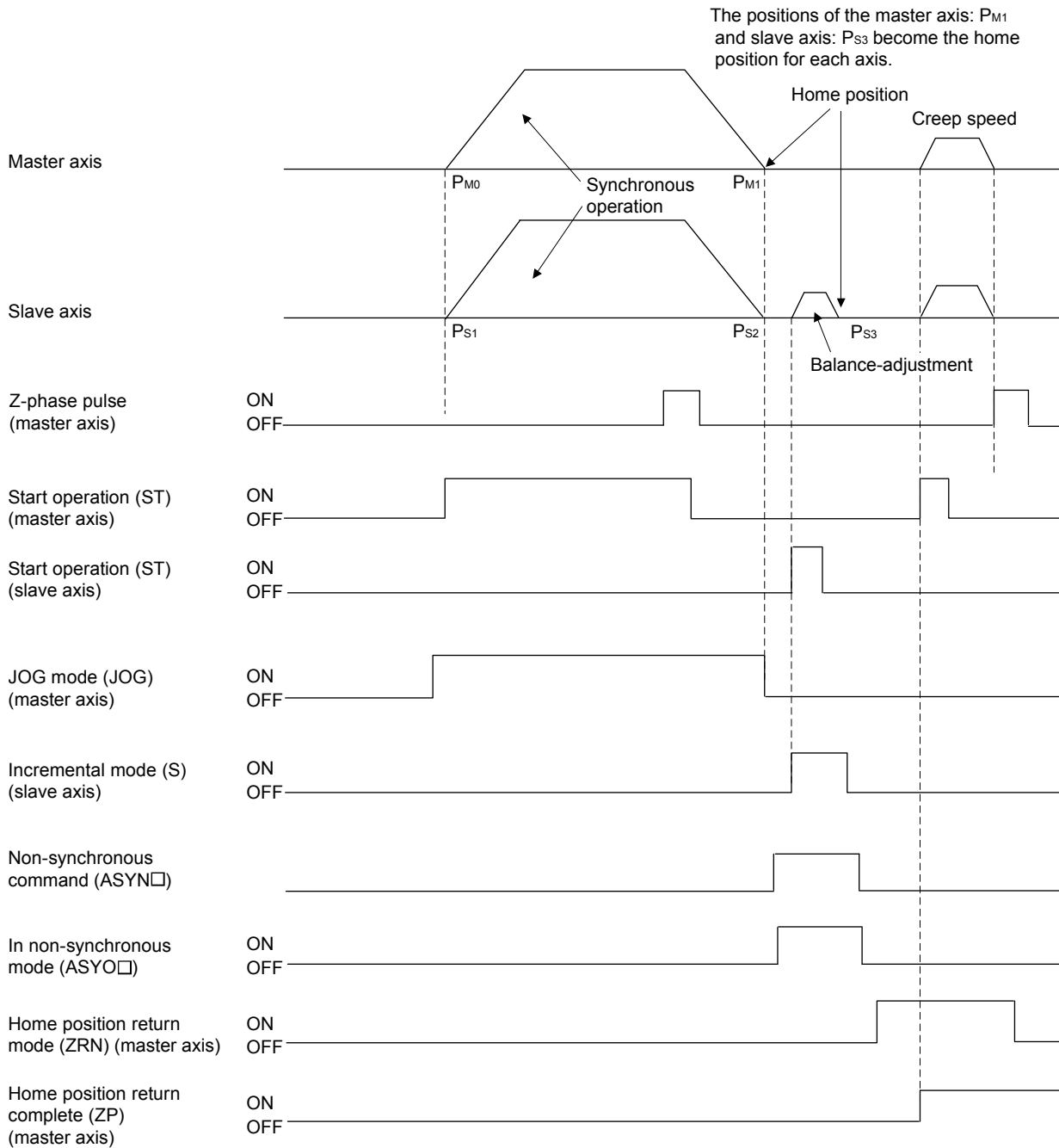

Note 1. This explanation is an example for using JOG operation for moving to home position.

2. The final stop position for both the master axis and the slave axis is based on the first master axis motor Z-phase in the home position return direction from the start operation position.

Also, only the master axis parameter for the value for the home position shift amount is valid.

8. TANDEM DRIVE

(6) Home position return using a scale home position signal detection method

Home position return is performed using a home position signal (Z-phase) on a linear scale. After detecting the proximity dog, move in the direction of the home position and in the opposite direction and the position where a home position signal is detected is defined to be the home position. When using scale home position signal detection home position return for tandem drive axes, designate adjustment mode or normal mode using tandem drive options (parameter No.0265).

(a) Adjustment mode

1) Summary

Adjustment mode is used during mechanical adjustment, and is used to calculate the home position signal offset (amount of deviation in the position of the home position signal for the master axis and slave axis) on a linear scale.

When executing home position return while in adjustment mode, after detecting the master axis home position signal and the slave axis home position signal while returning to home position, the axes are moved to the home position signal of the master axis. At this time the amount of offset from the position where the master home position signal was detected to the position where the slave home position was detected is calculated and output using the tandem drive home position signal offset (parameter No.026C, 026D). This amount of offset is used when compensating the amount of deviation between the master axis and slave axis when returning to home position; therefore, after completing home position return save this offset on the user program.

POINT
<ul style="list-style-type: none">▪ Prior to returning to home position, set the axis linking the master axis and slave axis mechanically at a right angle to the movement direction. If it is not at a right angle, the home position signal position offset amount can not be correctly calculated.

8. TANDEM DRIVE

2) Operation example for normal mode

a) Start operation method

1. Adjust the axis linking the master axis and slave axis mechanically at a right angle to the movement direction.
2. Set the home position return method (parameter No.0240) to scale home position signal detection method and tandem drive option (parameter No.0265) to normal mode.
3. Start home position return operation.
4. After home position return is complete, read the tandem drive home position signal offset (parameter No.026C, 026D) and save it to the user program.

b) Timing chart

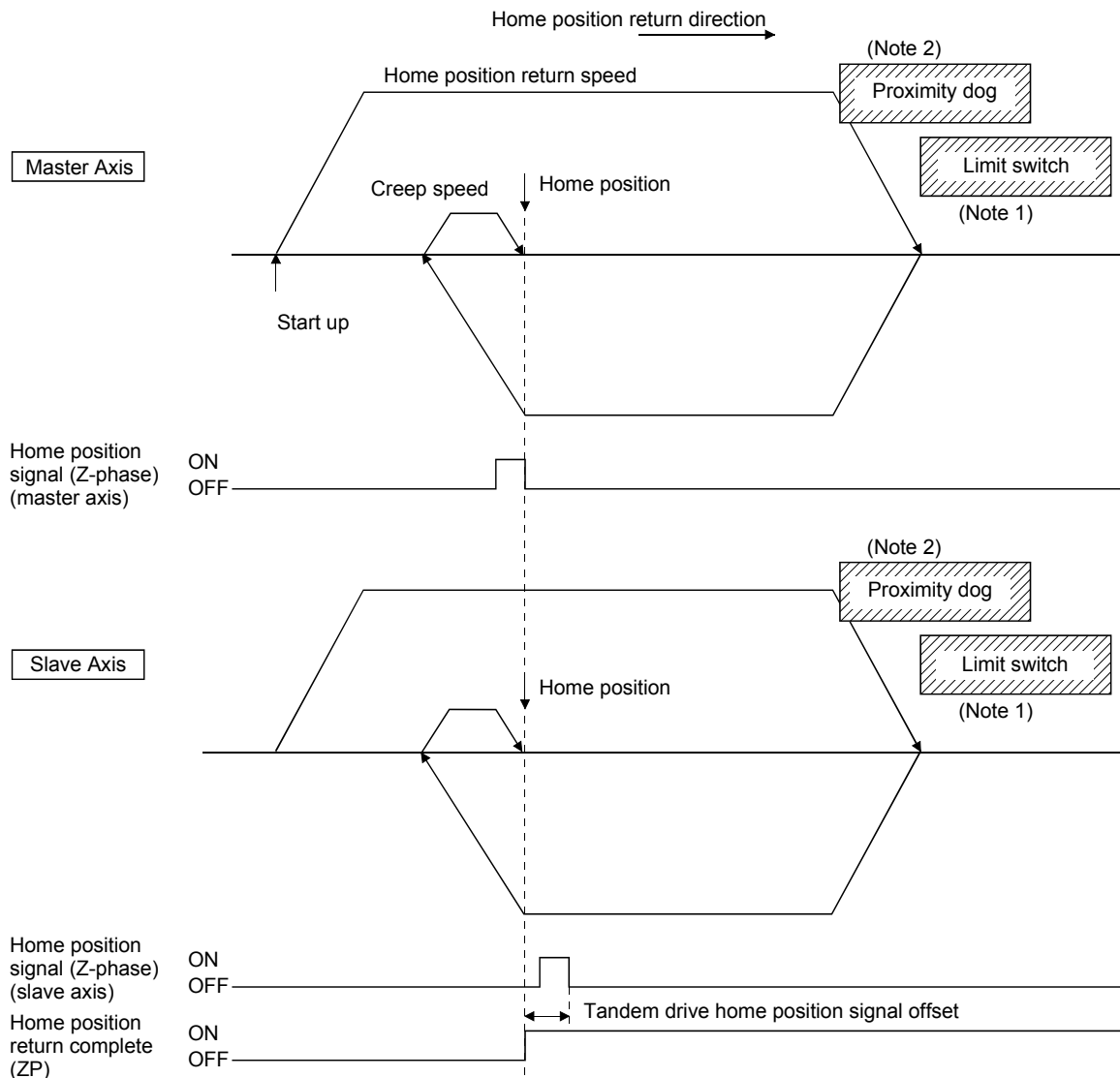

Note 1. When a limit switch signal is detected, an alarm occurs and execution of home position return is terminated.

Position the proximity dog in front of the limit switch signal.

(As shown in the diagram, position the proximity dog signal so that it overlaps the limit switch signal.)

2. Set the distance between the master axis/slave axis home position signals and the proximity dog so that it is greater than the deviation at maximum tolerance of the master axis and slave axis.

8. TANDEM DRIVE

(b) Normal mode

1) Summary

In normal mode, the amount of deviation between the master axis and slave axis is detected and tweaking (compensation of deviation between master axis and slave axis) is performed. This movement sets the axis linking the master axis and slave axis mechanically at a right angle to the movement direction.

When home position return is performed using normal mode, after detecting the master axis home position signal and slave position home position signal while returning to home position, calculate the deviation of the master axis and slave axis based on the tandem drive home position signal offset (parameter No.026C, 026D). The master axis moves to the position of the home position signal and the slave axis moves to the slave axis home position calculated based on the tandem driver home position signal offset and the previously noted deviation.

POINT	
	<ul style="list-style-type: none">▪ When performing home position return in normal mode, set the tandem drive home position signal offset (parameter No.026C, 026D) to the correct value. If the tandem drive home position signal offset value is erroneous, the axis that links the master axis and slave axis will not be at a right angle.▪ If the amount of deviation between the master axis and the slave axis exceeds the value calculated from the valid width of tandem drive deviation compensation (parameter No.026B) × tandem drive deviation compensation units multiplication (parameter No.026E), an exceeding of valid width of tandem drive deviation compensation error (operation alarm 57, detail 01) occurs and home position return operation is terminated. (Tweak movement is not performed.)

8. TANDEM DRIVE

2) Operation example for normal mode

a) Startup method

1. Set the home position return method (parameter No.0240) to scale home position signal detection method and tandem drive option (parameter No.0265) to normal mode.
2. Set the tandem drive home position signal offset (parameter No.026C, 026D).
3. Start home position return operation.

b) Timing chart

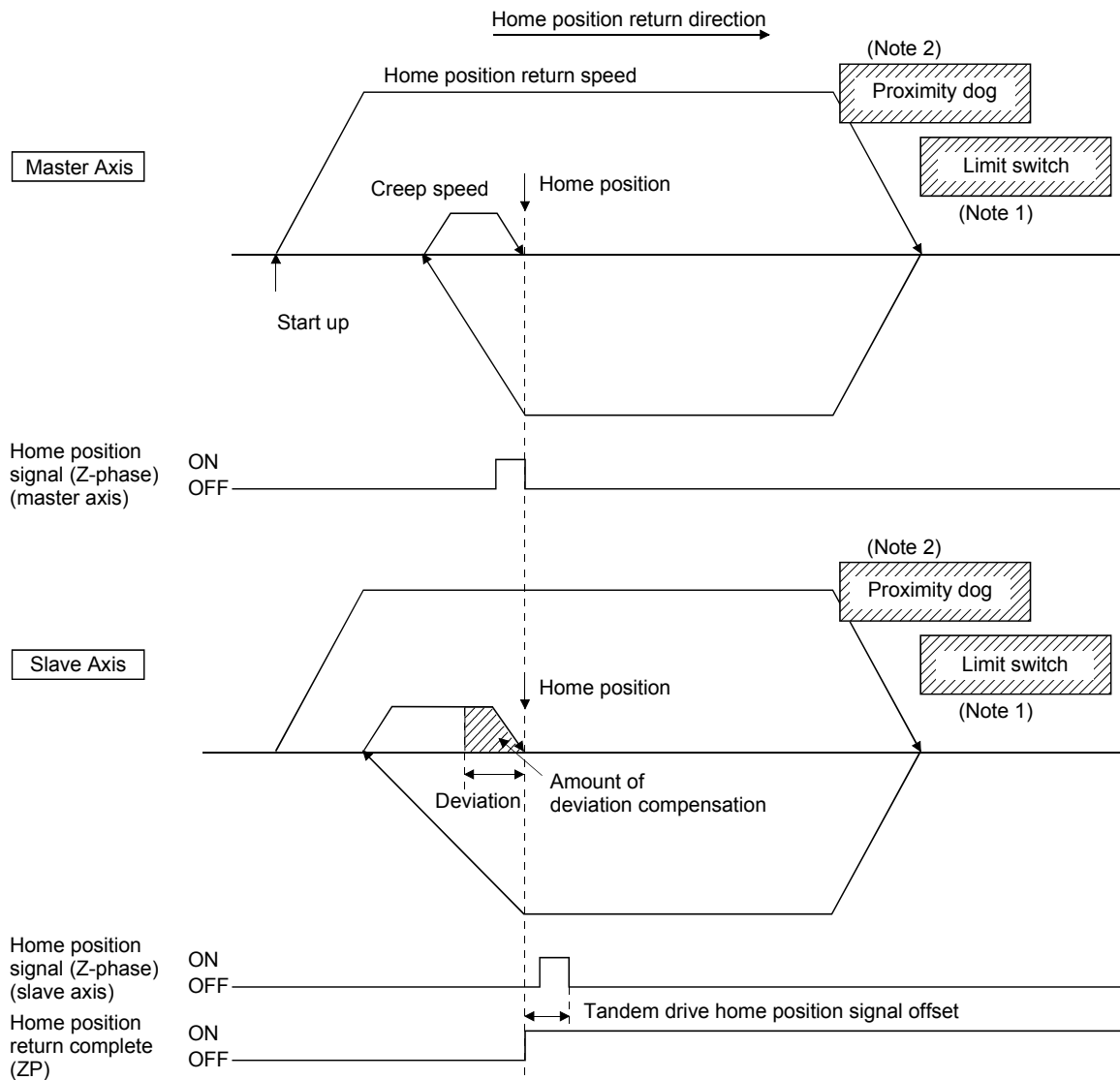

Note 1. When a limit switch signal is detected, an alarm occurs and execution of home position return is terminated.

Position the proximity dog in front of the limit switch signal.

(As shown in the diagram, position the proximity dog signal so that it overlaps the limit switch signal.)

2. Set the distance between the master axis/slave axis home position signals and the proximity dog so that it is greater than the deviation at maximum tolerance of the master axis and slave axis.

8. TANDEM DRIVE

(7) Home position return using a scale home position signal detection method 2

Home position return is performed using a home position signal (Z-phase) on a linear scale. After the start operation is performed, move in the opposite direction of the home position and the position where a home position signal is detected is defined to be the home position. When using scale home position signal detection home position return for tandem drive axes, designate adjustment mode or normal mode using tandem drive options (parameter No.0265).

(a) Adjustment mode

1) Summary

Adjustment mode is used during mechanical adjustment, and is used to calculate the home position signal offset (amount of deviation in the position of the home position signal for the master axis and slave axis) on a linear scale.

When executing home position return while in adjustment mode, after detecting the master axis home position signal and the slave axis home position signal while returning to home position, the axes are moved to the home position signal of the master axis. At this time the amount of offset from the position where the master home position signal was detected to the position where the slave home position was detected is calculated and output using the tandem drive home position signal offset (parameter No.026C, 026D). This amount of offset is used when compensating the amount of deviation between the master axis and slave axis when returning to home position; therefore, after completing home position return save this offset on the user program.

POINT
<ul style="list-style-type: none">▪ Prior to returning to home position, set the axis linking the master axis and slave axis mechanically at a right angle to the movement direction. If it is not at a right angle, the home position signal position offset amount cannot be correctly calculated.

8. TANDEM DRIVE

2) Operation example for adjustment mode

a) Start operation method

1. Adjust the axis linking the master axis and slave axis mechanically at a right angle to the movement direction.
2. Set the home position return method (parameter No.0240) to scale home position signal detection method and tandem drive option (parameter No.0265) to adjustment mode.
3. Start home position return operation.
4. After home position return is complete, read the tandem drive home position signal offset (parameter No.026C, 026D) and save it to the user program.

b) Timing chart

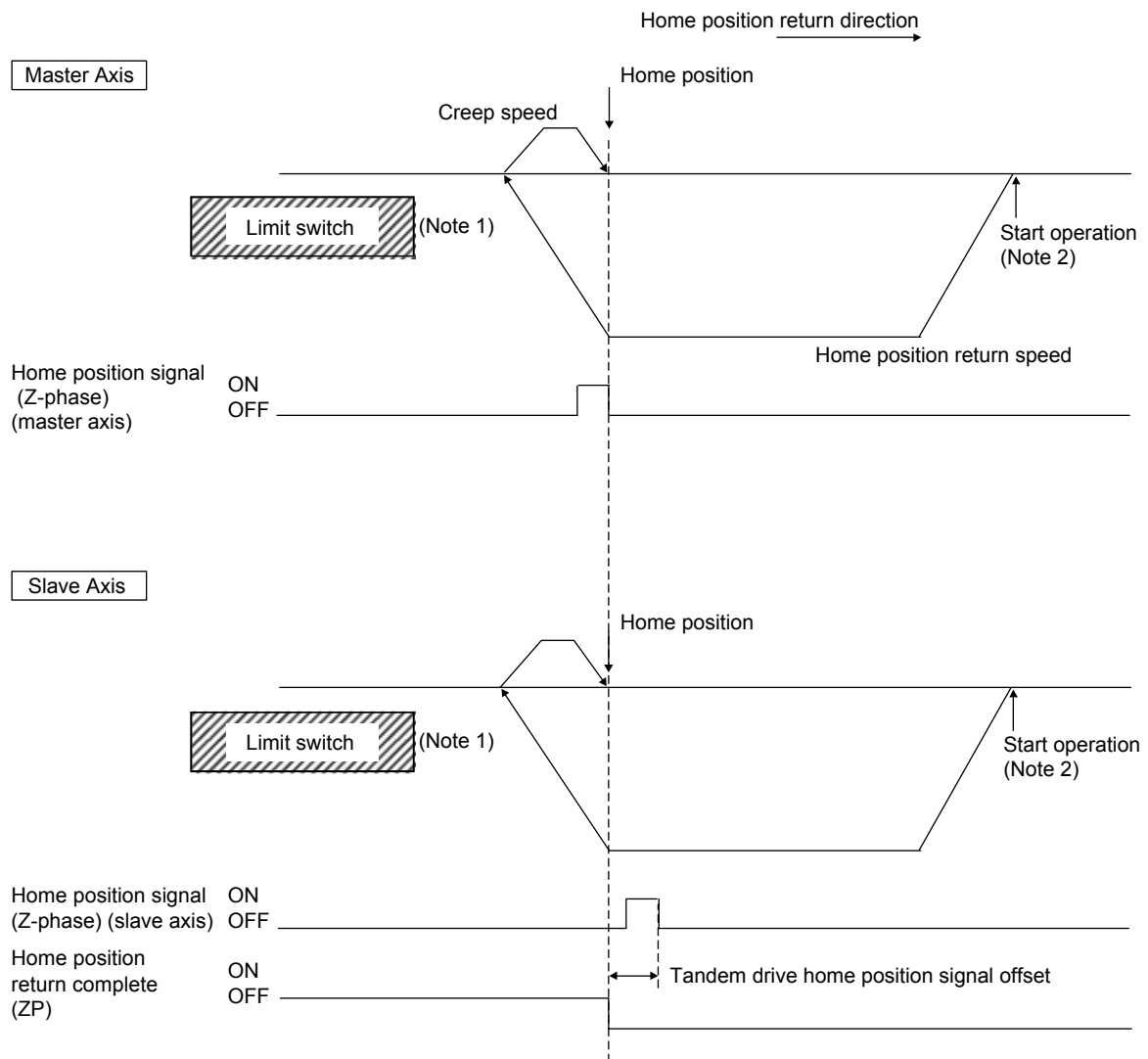

Note 1. When a limit switch signal is detected, an alarm occurs and execution of return to home position is terminated.

2. Set the distance between the master axis/slave axis home position signals and the start operation position so that it is greater than the deviation at maximum tolerance of the master axis and slave axis.

8. TANDEM DRIVE

(b) Normal mode

1) Summary

In normal mode, the amount of deviation between the master axis and slave axis is detected and tweaking (compensation of deviation between master axis and slave axis) is performed. This movement sets the axis linking the master axis and slave axis mechanically at a right angle to the movement direction.

When home position return is performed using normal mode, after detecting the master axis home position signal and slave position home position signal while returning to home position, calculate the deviation of the master axis and slave axis based on the tandem drive home position signal offset (parameter No.026C, 026D). The master axis moves to the position of the home position signal and the slave axis moves to the slave axis home position calculated based on the tandem driver home position signal offset and the previously noted deviation.

POINT	
	<ul style="list-style-type: none"><li data-bbox="469 817 1410 958">▪ When performing home position return in normal mode, set the tandem drive home position signal offset (parameter No.026C, 026D) to the correct value. If the tandem drive home position signal offset value is erroneous, the axis that links the master axis and slave axis will not be at a right angle.<li data-bbox="469 974 1390 1227">▪ If the amount of deviation between the master axis and the slave axis exceeds the value calculated from the valid width of tandem drive deviation compensation (parameter No.026B) × tandem drive deviation compensation units multiplication (parameter No.026E), an exceeding of valid width of tandem drive deviation compensation error (operation alarm 57, detail 01) occurs and home position return operation is terminated. (Tweak movement is not performed.)

8. TANDEM DRIVE

2) Operation example for normal mode

a) Start operation method

1. Set the home position return method (parameter No.0240) to scale home position signal detection method and tandem drive option (parameter No.0265) to normal mode.
2. Set the tandem drive home position signal offset (parameter No.026C, 026D).
3. Start home position return operation.

b) Timing chart

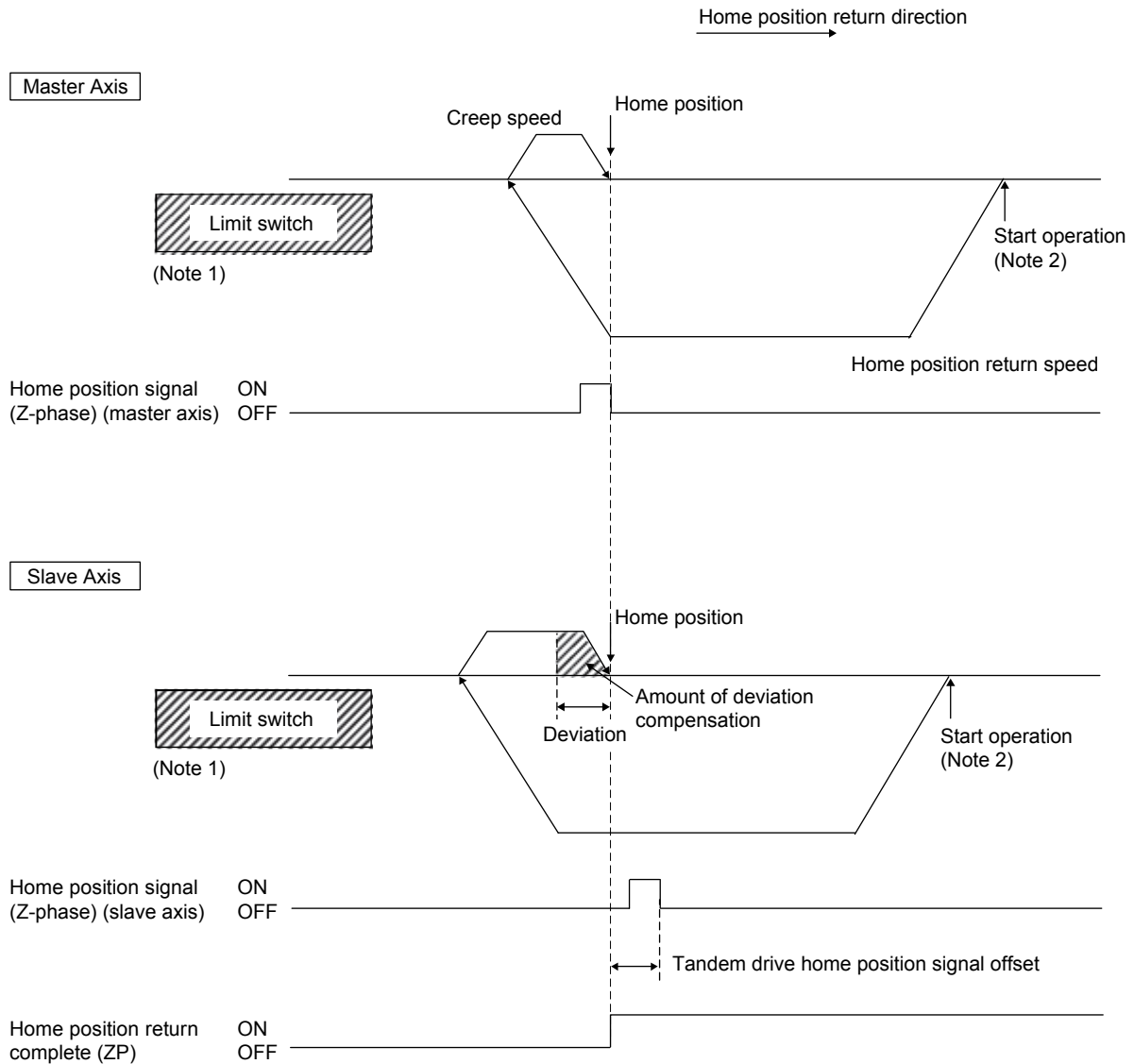

Note 1. When a limit switch signal is detected, an alarm occurs and execution of return to home position is terminated.

2. Set the distance between the master axis/slave axis home position signals and the start operation position so that it is greater than the deviation at maximum tolerance of the master axis and slave axis.

8. TANDEM DRIVE

8.4.2 JOG operation during tandem drive

(1) Synchronous mode

When JOG operation is performed while in synchronous mode, master axis data and signals are used. An example is shown below.

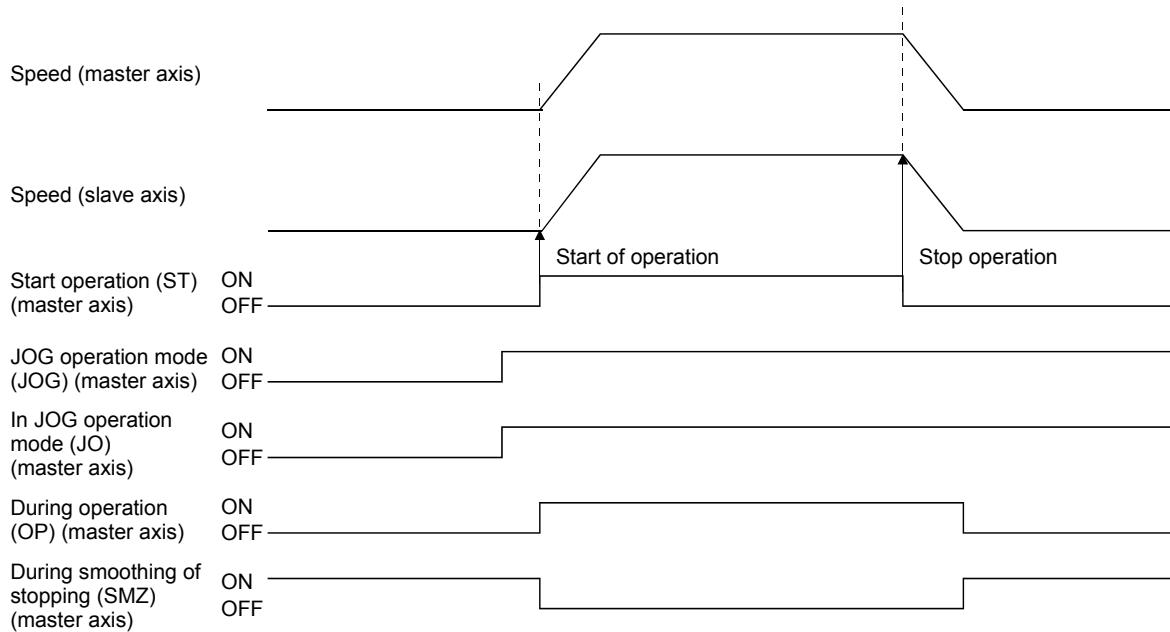

Important data classifications related to JOG operation during synchronous mode are shown in the following table. For other related data, refer to Section 10.7.

Type	Items for which only item associated with master is valid	Items defined for each axis
Command signal/data	JOG operation mode (JOG) Movement direction (DIR) Start operation (ST) Manual feed speed Acceleration time constant Deceleration time constant	None
Status signal	In JOG operation mode (JO) During operation (OP) During smoothing of stopping (SMZ)	In-position (INP) Position switch (PSW)

The in-position signal (INP) is output for each axis separately; therefore, when the axes have come to a stop and in-position signals are being used, check the in-position signal (INP) for both the master axis and the slave axis.

For other types of movement, normal axis movement is followed. (Refer to Section 5.1)

(2) Non-synchronous micro-adjustment mode

Movement is the same as for normal axis movement. (Refer to Section 5.1)

8. TANDEM DRIVE

8.4.3 Incremental feed while using tandem drive

(1) Synchronous mode

When incremental feed operation is performed while in synchronous mode, master axis data and signals are used. An example is shown below.

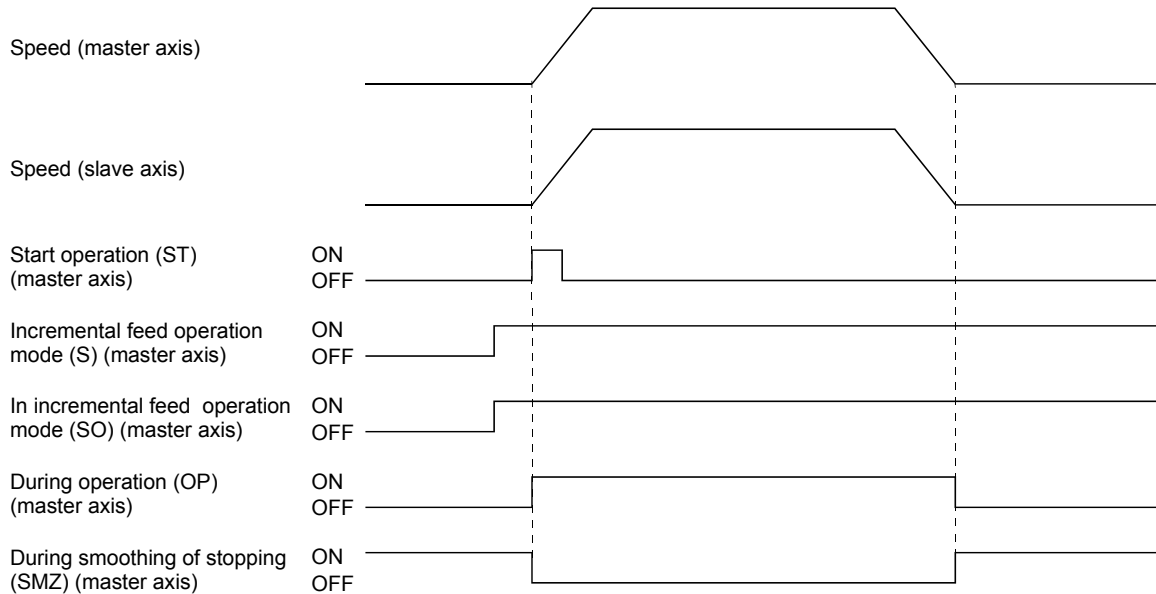

Important data classifications related to incremental feed operation during synchronous mode are shown in the following table. For other related data, refer to Section 10.7.

Type	Items for which only item associated with master is valid	Items defined for each axis
Command signal/data	Incremental feed operation mode (S) Movement direction (DIR) Start operation (ST) Manual feed speed Acceleration time constant Deceleration time constant Incremental feed movement amount	None
Status signal	In incremental feed mode (SO) During operation (OP) During smoothing of stopping (SMZ)	In-position (INP) Position switch (PSW)

The in-position signal (INP) is output for each axis separately; therefore, when the axes have come to a stop and in-position signals (INP) are being used, check the in-position signal (INP) for both the master axis and the slave axis.

For other types of movement, normal axis movement is followed. (Refer to Section 5.2)

(2) Non-synchronous micro-adjustment mode

Movement is the same as for normal axis movement. (Refer to Section 5.2)

8. TANDEM DRIVE

8.4.4 Automatic operation during tandem drive

(1) Synchronous mode

When automatic operation is entered while in synchronous mode, master axis data and signals are used. Also, the master axis table is used for the point table. An example is shown below.

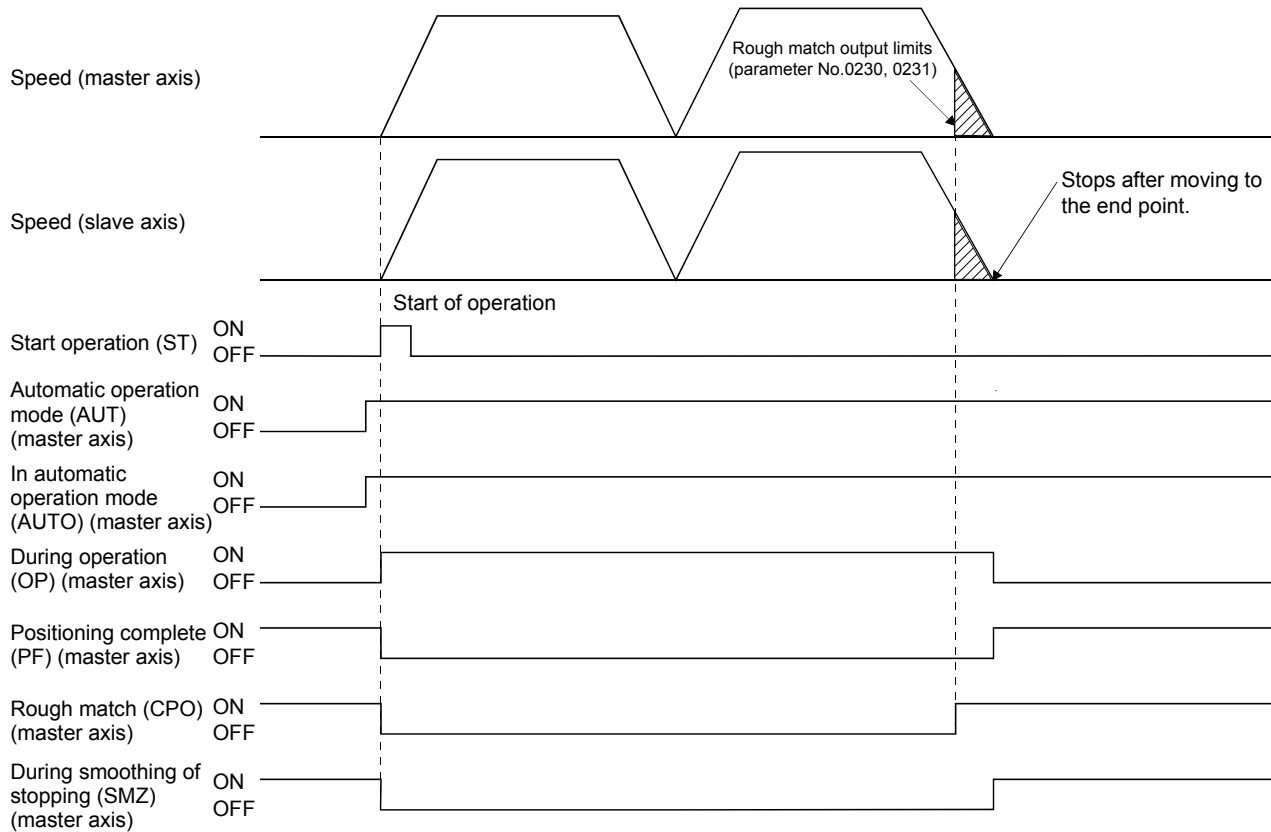

Important data classifications related to automatic operation during synchronous mode are shown in the following table. For other related data, refer to Section 10.7.

Type	Items for which only item associated with master is valid	Items defined for each axis
Command signal/data	Automatic operation mode (AUT) Start operation (ST) Start point No. End point No. (Point table)	None
Status signal	In automatic operation mode (AUTO) During operation (OP) During smoothing of stopping (SMZ) Positioning complete (PF) Rough match (CPO)	In-position (INP) Position switch (PSW)

The in-position signal (INP) is output for each axis separately; therefore, when the axes have come to a stop and in-position signals (INP) are being used, check the in-position signal (INP) for both the master axis and the slave axis.

For other types of movement, normal axis movement is followed. (Refer to Section 5.3)

(2) Non-synchronous micro-adjustment mode

Automatic operation can not be entered while in non-synchronous micro-adjustment mode. The while in tandem drive non-synchronous mode (operation alarm 51, detail 01) occurs upon start of operation.

8. TANDEM DRIVE

8.4.5 Linear interpolation during tandem drive

When performing linear interpolation operation, it is necessary to group the axes for which linear interpolation is to be set up. The groups are set up using linear interpolation group (parameter No.0260) and the master axis is the only one set up when in tandem drive axis operation. For other types of movement, normal axis movement is followed. (Refer to Section 5.4)

POINT
<ul style="list-style-type: none"> When performing linear interpolation operation, limit the total number of axes to 4, including slave axes. If the total number of axes exceeds 4, the linear interpolation start up error (operation alarm 40, detail 02) occurs upon start of operation.

The following is a system configuration set up example.

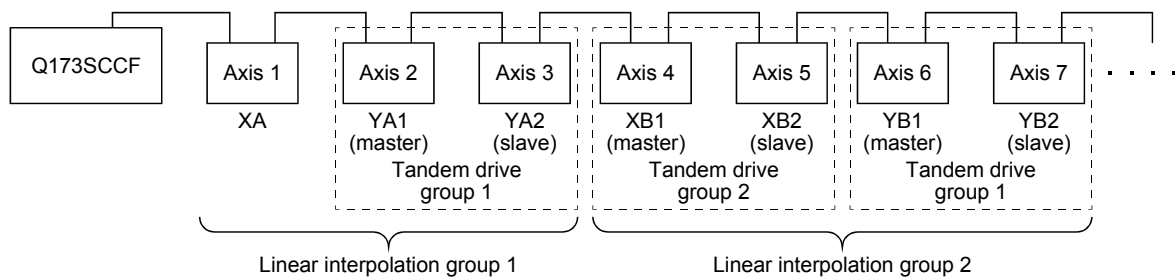

Axis No.	Axis name	Linear interpolation group (parameter No.0260)	Tandem drive group (parameter No.0264)
1	XA	1	0
2	YA1	1	1
3	YA2	0	1
4	XB1	2	2
5	XB2	0	2
6	YB1	2	3
7	YB2	0	3

The group number of the slave axis is set to the same number of the master axis independent of its setting.

(1) Synchronous mode

When linear interpolation operation is entered while in synchronous mode, master axis data and signals are used. Also, the master axis table is used for the point table.

Important data classifications related to linear interpolation operation during synchronous mode are shown in the following table. For other related data, refer to Section 10.7.

Type	Items for which only item associated with master is valid	Items defined for each axis
Command signal/data	Linear interpolation mode (LIP) Start operation (ST) Start point No. End point No. (Point table)	None
Status signal	In linear interpolation mode (LIPO) During operation (OP) During smoothing of stopping (SMZ) Positioning complete (PF) Rough match (CPO)	In-position (INP) Position switch (PSW)

8. TANDEM DRIVE

The in-position signal (INP) is output for each axis separately; therefore, when the axes have come to a stop and in-position signals are being used, check the in-position signal for both the master axis and the slave axis.

For other types of movement, normal axis movement is followed. (Refer to Section 5.4)

The following shows an example where start operation is performed for the linear interpolation group 1 from the configuration example on the previous page.

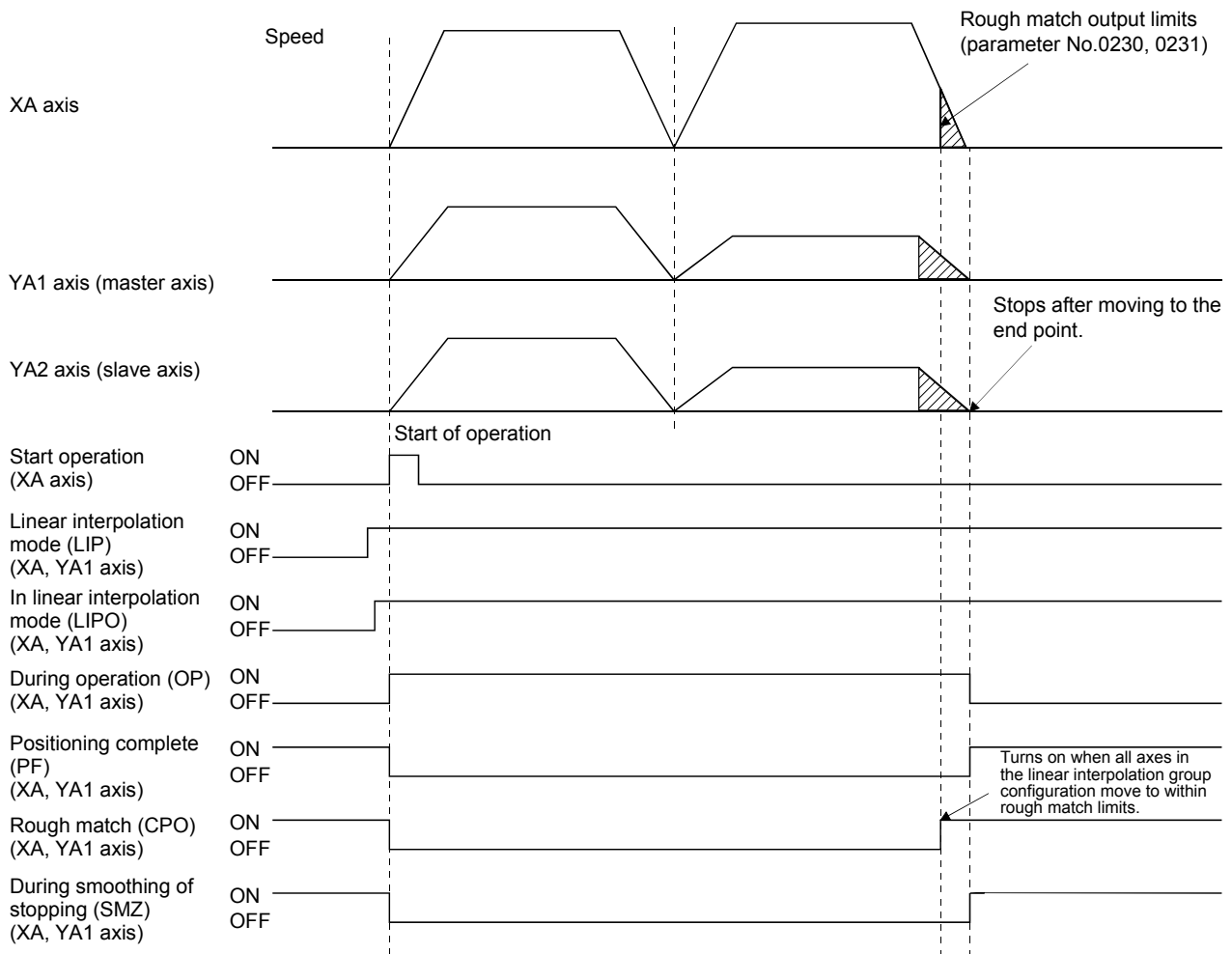

POINT
<ul style="list-style-type: none"> For Linear interpolation operation, the XA axis and YA1 axis (master axis) are used for linear interpolation operation. The YA2 axis (slave axis) moves synchronously with the master axis.

(2) Non-synchronous micro-adjustment mode

Linear interpolation operation cannot be entered while in non-synchronous micro-adjustment mode. The while in tandem drive non-synchronous mode (operation alarm 51, detail 01) occurs upon start of operation.

8. TANDEM DRIVE

8.5 Servo on and servo off during tandem drive axis operation

(1) Synchronous mode

When the master axis servo on signal (SON) and slave axis servo on signal (SON) are turned on, the both axes are turned on. Also, when the servo on signal (SON) for either the master axis or the slave axis is turned off, both axes are turned servo off.

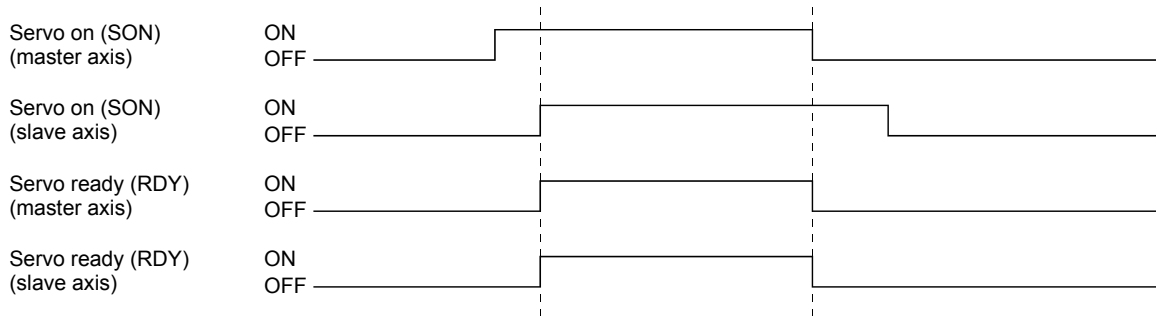

When an axis has moved while the servo off, the current command position is updated in accordance with the movement amount (Current feedback position) both for the master axis and for the slave axis.

When there is a misalignment between the master axis and slave axis at the servo on, synchronous alignment is performed by aligning the command for the slave axis with the one for the master axis.

During synchronous alignment, "synchronizing" status signal (SYEO□: □ is the group number) turns on.

After confirming the "synchronizing" status signal is off, perform the start operation.

However under the following conditions, the tandem drive synchronous alignment error (operation alarm 58, detail 01) occurs and synchronization is canceled. After the cause for the alarm is removed, turn the servo off and then on to perform synchronization again. When automatic operation or linear interpolation is performed with synchronization incomplete, the tandem drive synchronous alignment error (operation error 58, detail 02) occurs.

- (a) If the deviation between the master axes command position and the slave axis command position exceeds the tandem drive synchronous alignment valid width (parameter No.0266), the tandem drive synchronous alignment valid width error (operation alarm 54, detail 01) occurs.
- (b) If a stop command (STP, RSTP) is input while synchronizing, the tandem drive synchronous alignment error (operation alarm 58, detail 01) occurs.

8. TANDEM DRIVE

POINT	
	<ul style="list-style-type: none">▪ Synchronization is validated after home position return complete (after home position is established). When the home position return request (ZREQ) is ON, synchronization is not performed.▪ Set the speed at synchronization using the tandem drive synchronous alignment speed (parameter No.0267) and the speed units multiplication factor (parameter No.020E, 020F).▪ When start operation is performed during synchronization, the tandem drive while performing synchronization (operation alarm 55, detail 01) occurs.▪ When drive mode is toggled during synchronization, the tandem drive mode change error (operation alarm 50, detail 01) occurs.▪ If the "tandem drive synchronous alignment valid width error" (operation alarm 54, detail 01) or the "tandem drive synchronous alignment error" (operation alarm 58, detail 01) occurs within absolute position detection system, the absolute value will be lost. (The absolute position data of the home position return option 2 (parameter No.0241) becomes invalid and "absolute position erased signal" (ABSE) turns on.)▪ Implement a stop command on the master axis. Because system is in synchronous mode, a stop command to the slave axis is invalid.▪ If the synchronization setting (parameter No.0265) is set to invalid, synchronization for turning servo on is not performed. The Q173SCCF operates with the deviation between the master axis and the slave axis held. The setting of this parameter becomes valid at the leading edge of servo ready (RDY) signal. While synchronization is invalid, the following operations may make a deviation between the master axis and the slave axis. As necessary, perform synchronization (micro-adjustment) with the user program. In addition, check the deviation between the master axis and the slave axis is within an allowance.<ul style="list-style-type: none">▪ At turning on the after turning off the servo▪ At canceling a servo alarm after a servo alarm occurs▪ At resetting a forced stop after a forced stop occurs

(2) While in non-synchronous micro-adjustment mode

The servos can be turned on and off separately. Movement is as the same as normal axes.

(Refer to Section 6.4)

8.6 Tandem drive axis limit switch

If the limit switches on either the master axis or the slave axis is detected, an alarm occurs and both axes are stopped using the rapid stop time constant. For other types of movement, normal axis movement is followed.

(Refer to Section 6.8)

8. TANDEM DRIVE

8.7 Tandem drive axis software limit

Software limits become valid after completing home position return (home position return request (ZREQ) is off). Software limits are checked for both the master axis and the slave axis. In this case, the software limit boundaries for the master axis become valid.

The following shows an example where the software limit is reached during JOG operation when the synchronization setting (parameter No.0265) is set to invalid and there is a deviation between the master axis and slave axis at servo-on.

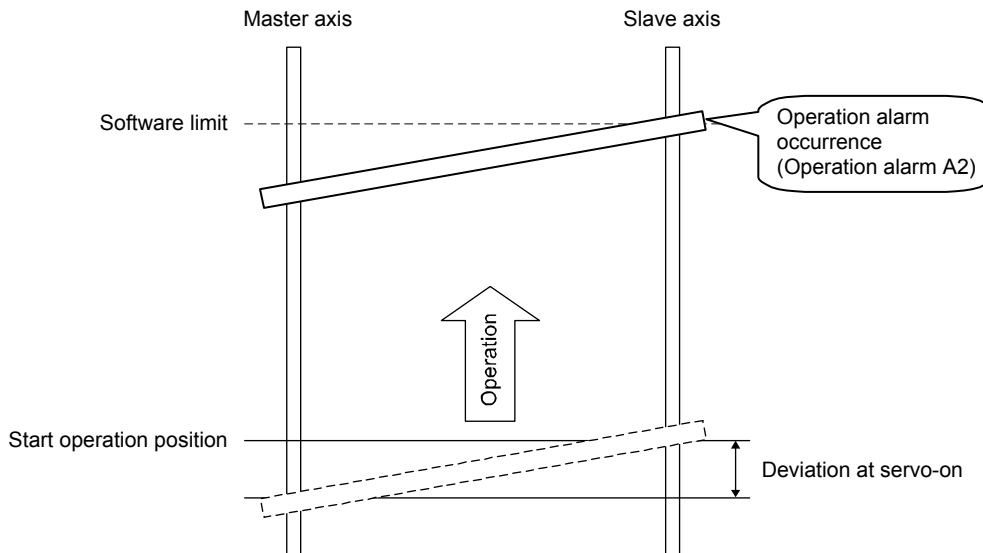

For other types of software limit occurrences, normal axis movement is followed.
(Refer to Section 6.9)

8.8 Tandem drive interference check

Interference check is performed both for the master axis and slave axis. The parameter value of interference check width for the master axis becomes valid.

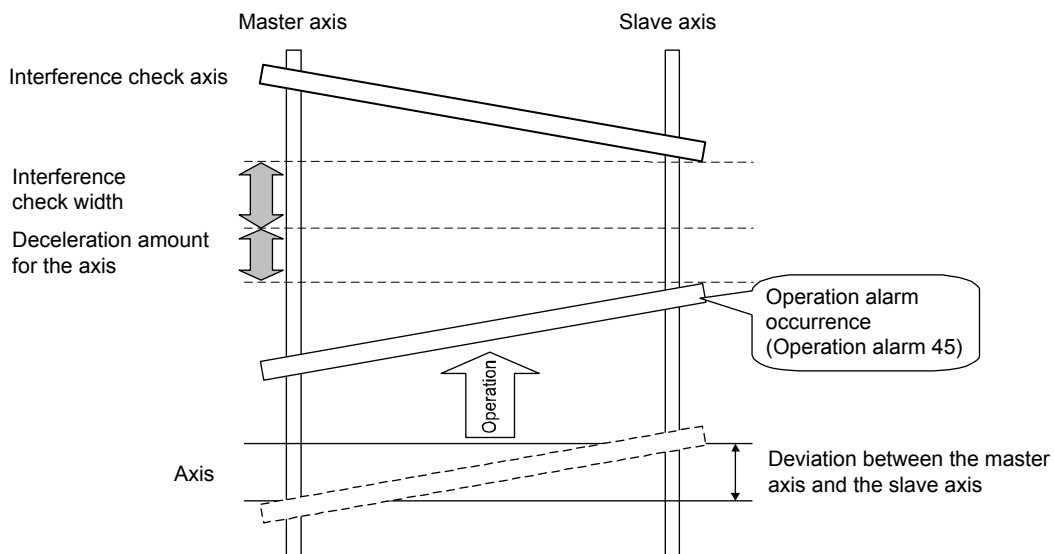

8. TANDEM DRIVE

8.9 Tandem drive axis servo alarms

If an alarm occurs on the master axis or slave axis, dynamic braking and stoppage is implemented for the axis for which the servo alarm did not occur as well. When the cause for an alarm on an axis is cancelled such as through a servo alarm reset, the dynamic brake is cancelled.

This is the same for a servo forced stop warning (E6) or a main circuit off warning (E9) status on either the master axis or the slave axis.

This operation does not exist in drive modes (synchronous mode/non-synchronous micro adjustment mode).

POINT	Relationship between servo on/off and dynamic brake on/off	
	While Servo On command is ON	While Servo On command is OFF
Dynamic brake off	Servo control is operating (Positioning can be controlled.)	Servo is coasting (Is easily turned using an external force.)
Dynamic brake on	Dynamic brake status (If an external force is placed to try and rotate axis, dynamic brake resists the force.)	

8.10 Deviation monitoring function

A function where if the deviation between the master axis and the slave axis exceeds the tandem drive excessive deviation width (parameter No.0268) during synchronous mode while in tandem drive axis mode, the tandem drive excessive deviation (operation alarm 53, detail 01) occurs and both axes are stopped using a dynamic brake. When the setting for the excessive deviation width is set to 0, it becomes invalid.

9. INTERFACE MODE

9. INTERFACE MODE

9.1 Summary

Interface mode is a function for sending the commands for every operation cycle (position commands, speed commands and torque commands) straight to the servo amplifier. By using this function, any given acceleration/deceleration pattern, speed pattern, or torque pattern is possible.

To use interface mode, designate "1: Interface mode" with system option 2 (parameter No.0002), and perform system startup after setting Interface mode option (parameter No.000F).

When system startup is performed in interface mode, operation modes from standard mode such as JOG operation, automatic operation, etc. cannot be used.

The C Controller module controls the servo amplifier by updating the contents of the command buffer at a timing of either when the C Controller module receives the interrupt output for each control cycle given by the Q173SCCF (when interrupt output is valid), or at any given timing (when interrupt output is invalid).

When interrupt output is valid, position control mode, speed control mode, and torque control mode can be used. When interrupt output is invalid, only position control mode can be used.

(1) Software version A3

Only position control mode can be used.

(2) Software version A4 or later

Position control mode, speed control mode, and torque control mode can be used.

POINT
<ul style="list-style-type: none">▪ When using interface mode, all axes operate in interface mode. Cannot operate some axes in standard mode during interface mode.▪ Cannot switch control modes (standard mode and interface mode) after system startup.▪ When using the test operation function of MR Configurator2 connected to the Q173SCCF with a USB connection, the Q173SCCF stops importing commands. If the test operation function is executed while motors are rotating, they come to a stop. Be sure to perform test operation after stopping operation. The system must be restarted to control with commands from the Q173SCCF again. For details on test operation refer to Servo Amplifier Instruction Manual, and help of MR Configurator2.▪ The test tool is not compatible with interface mode. It can get monitors and graphs of servo information.

API LIBRARY
<ul style="list-style-type: none">▪ For a detailed procedure for interface mode, refer to the sample program (InterruptIfmDrive/PollingIfmDrive) contained on the utility software

9. INTERFACE MODE

9.2 Combinations with functions

The following shows the combinations of interface mode with each function.

Classification	Function		Control mode			Remarks	
			Position control	Speed control	Torque control		
Operational function	JOG operation		×	×	×		
	Incremental feed		×	×	×		
	Automatic operation		×	×	×		
	Linear interpolation		×	×	×		
	Home position return		×	×	×	The normal home position return function is invalid. After moving to the home position, use the home position set command. Check the DOG signal status with the high-speed monitor.	
	Home position reset function		×	×	×		
Application function	Command units	Electronic gear	×	×	×	Command units are always pulse units.	
	Speed unit	Speed unit	△	△	△	Related only to speed units during monitor output.	
		Speed units multiplication factor	△	△	△	Related only to speed units during monitor output.	
		Speed limit	×	×	×		
	Acceleration/ deceleration	Linear acceleration/deceleration		×	×	×	
		Smoothing filter		×	×	×	
		Start up speed validity		×	×	×	
		S-curve acceleration/ deceleration (Sine acceleration/deceleration)		×	×	×	
	Servo off		×	×	×	The system becomes servo free. Follow up processes are not performed after servo off. Perform them with the user program. Operation stop by servo off is invalid. Perform servo off after a deceleration stop.	
	Forced stop		○	○	○		
	Stop operation		×	×	×		
	Rapid stop operation		×	×	×		
	Limit switch (stroke end)		×	×	×	Check the LSP/LSN signal status with the high-speed monitor.	
	Software limit		×	×	×		
	Interlock		×	×	×		
	Rough match output		×	×	×		
	Torque limit		○	○	×		
	Command change	Speed change		×	×	×	
		Change of time constants		×	×	×	
		Position change		×	×	×	
Backlash		×	×	×			
Position switch		×	×	×			
Completion of operation signal		×	×	×			
Interference check function		×	×	×			
Home position search limit		×	×	×			

○: Usable ×: Unusable △: Restriction

9. INTERFACE MODE

Classification	Function	Control mode			Remarks
		Position control	Speed control	Torque control	
Application function	Gain switching	○	○	○	
	PI-PID switching	○	×	×	
	Home position set	○	×	×	If home position set request is turned ON at speed control/torque control, home position set error (ZSE) turns ON.
	Absolute position detection system	○	○	○	
	Home position return request	×	×	×	
	High response I/F	×	×	×	
	Other axes start	×	×	×	
	In-position signal	○	×	×	
	Digital I/O	○	○	○	
	I/O device	○	○	○	
	Servo amplifier general I/O	○	○	○	
	Dual port memory exclusive control	○	○	○	
	Pass position interrupt	×	×	×	
	Mark detection	○	○	○	
	Continuous operation to torque control	×	×	×	
	SSCNET III/H head module	○	○	○	
Sensing module	○	○	○		
Auxiliary function	Reading/writing parameters	○	○	○	
	Changing parameters at the servo	○	○	○	
	Alarm and system error	○	○	○	
	Monitor function	○	○	○	
	High speed monitor function	○	○	○	
	Interrupt	△	△	△	Interrupt output is not performed by factor of interrupt. Interrupt is output according to the interrupt output cycle settings only during interrupt valid.
	Interrupt output cycle	○	○	○	Can only be used in interface mode.
	Command data update cycle	○	○	○	Can only be used in interface mode.
	User watchdog function	○	○	○	
	Software reboot function	○	○	○	
	Parameter backup	○	○	○	
	Test mode	○	○	○	
	Reconnect/disconnect function	○	△	△	When reconnecting, startup is in position control mode.
	Sampling	○	○	○	
	Log	○	○	○	
	Operation cycle monitor function	○	○	○	
	Amplifier-less axis function	○	○	○	For torque control mode, operation stops when torque command is 0.0%, or when torque control speed limit value is 0, and zero speed (ZSP) turns ON.
	Alarm history function	○	○	○	
External forced stop disabled	○	○	○		
Transient transmission	○	○	○		
Tandem drive	×	×	×		

○: Usable ×: Unusable △: Restriction

9. INTERFACE MODE

9.3 Parameters

For interface mode, the parameters used and some of the parameter functions change. The following are parameters used in interface mode.

(1) System parameters

(a) System parameters used

Parameter No.	Abbreviation	Name	Remarks
0001	*SYSOP1	System option 1	
0002	*SYSOP2	System option 2	Designates interface mode in control mode.
000E	*EMID	External forced stop disabled	
000F	*IFM0	Interface mode option	Designates the interrupt output cycle and command data update cycle.
0040	LGS1	Log acquiring selection1	
0041	LGS2	Log acquiring selection2	
0042	LGS3	Log acquiring selection3	

(b) Parameter details

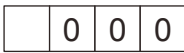
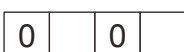
Parameter No.	Abbreviation	Name	Initial value	Units	Setting range	Function
0002	*SYSOP2	System option 2	0000h		0000h to 1101h	 <p>Control mode selection Select the control mode. 0: Standard mode 1: Interface mode</p>
000F	*IFM0	Interface mode option	0000h		0000h to 0F0Fh	 <p>Interrupt output cycle When interrupt by interface mode is valid, set the cycle for which the interrupt is output. Interrupt output cycle: $\text{Control cycle} \times (\text{setting value} + 1)$ Example: When interrupt output cycle is set to 1 and control cycle is 0.88ms, interrupt is output approximately every 1.77ms.</p> <p>Command data update cycle Set the cycle for which commands are updated in interface mode. Command data update cycle: $\text{Control cycle} \times (\text{setting value} + 1)$ Example: When control cycle is 0.88ms and command data update cycle is set to 2, position commands are updated approximately every 2.66ms.</p>

(2) Servo parameters

There are no differences to standard mode.

9. INTERFACE MODE

(3) Control parameters

(a) Control parameters used

Parameter No.	Abbreviation	Name	Remarks
0200	*OPC1	Control option 1	Speed units relates to the units during monitor output.
0203	*AXALC	Axis No. assignment	
020E	SUML	Speed units multiplication factor (lower)	Speed units multiplication factor relates to the units during monitor output.
020F	SUMH	Speed units multiplication factor (upper)	
0210	TLP	Forward rotation torque limit value	
0211	TLN	Reverse rotation torque limit value	
0213	*GIOO	General I/O option	
0214	*GDNA	General I/O number assignment	
0219	*SOP	Sensor input options	Sets the source of input for LSP/LSN/DOG signals. Each signal is used in monitor output only.
021A	*SLSP	Sensor signal (LSP) connection specification	
021B	*SLSN	Sensor signal (LSN) connection specification	
021C	*SDOG	Sensor signal (DOG) connection specification	
021D	*VEND	Vendor ID	
021E	*CODE	Type code	
023F	*IFBN	Interface mode maximum buffer number	Designates the maximum buffer number of the command buffer. Note. When controlling by interface mode with interrupt output invalid, 1 or more must be set.
0241	*OPZ2	Home position return Option 2	Can set valid/invalid of system only.
0246	ZPSL	Home position coordinates (lower)	Set only for absolute position system.
0247	ZPSH	Home position coordinates (upper)	
024D	*LSO	Home position multiple revolution data	Set only for absolute position system.
024E	*CYOL	Home position within 1 revolution position (lower)	Set only for absolute position system.
024F	*CYOH	Home position within 1 revolution position (upper)	

(b) Parameter details

The parameter details regarding interface mode are shown below.

Parameter No.	Abbreviation	Name	Initial value	Units	Setting range	Function	When in tandem drive
023F	*IFBN	Interface mode maximum buffer number	0		0 to 63	Sets the maximum value of the ring buffer number being used in interface mode. The set value+1 is the number of buffers. Note. When controlling by interface mode with interrupt output invalid, 1 or more must be set.	

9. INTERFACE MODE

9.4 Interface

(1) System information

Address	Content
0010	Interrupt output cycle
0011	
0012	Command data update cycle
0013	

(a) Interrupt output cycle

The interrupt output cycle (control cycle × N) outputs the value of N.

(b) Command data update cycle

The command data update cycle (control cycle × N) outputs the value of N.

(2) System status table

Address	Content
0478	Command buffer read error counter
0479	

(3) System command/status bit

System command

Address	Bit	Symbol	Signal name
03E0	0	ITE	Interrupt processing complete
	1	ITS	Interrupt output valid
	2		Reserved
	3		
	4	HMA	During user program memory access
	5		Reserved
	6		
7			

System status

Address	Bit	Symbol	Signal name
0450	0	ITO	Outputting with factor of interrupt
	1	IITO	During interface mode interrupt valid
	2	EVDO	Event detection enabled
	3	HRIF	During highly response I/F valid
	4	BMA	During system program memory access
	5	PRINF	Continuous operation to torque control compatible information
	6		Reserved
7	IFMO		

(a) Details on command bit

Abbreviation	Signal name	Function details
ITS	Interrupt output valid	<p>[Function] Commands interrupt output valid.</p> <p>[Operation] Outputs the interrupt each interrupt output cycle when interrupt output valid (ITS) is turned on.</p>
HMA	During user program memory access	<p>[Function] Commands when the user program is accessing the command buffer.</p> <p>[Operation] When during user program memory access (HMA) is turned on, the system program recognizes that the user program is accessing the command buffer, and does not access the command buffer. When this happens, the system program counts up on the command buffer read error counter.</p>

9. INTERFACE MODE

(b) Details on status bit

Abbreviation	Signal name	Function details
IITO	During interface mode interrupt valid	<p>[Function] Notifies the interrupt during interface mode is valid.</p> <p>[Operation] <Conditions for turning on> <ul style="list-style-type: none"> Interrupt output valid (ITS) is turned on. <Conditions for turning off> <ul style="list-style-type: none"> Interrupt output valid (ITS) is turned off. </p>
EVDO	Event detection enabled	<p>[Function] Notifies the event detection function is valid.</p> <p>[Operation] <Conditions for turning on> <ul style="list-style-type: none"> Interface mode is selected in control mode, and system startup is performed. </p>
BMA	During system program memory access	<p>[Function] Notifies the system program is accessing the command buffer.</p> <p>[Operation] <Conditions for turning on> <ul style="list-style-type: none"> The system program is accessing the command buffer. <Conditions for turning off> <ul style="list-style-type: none"> The system program is not accessing the command buffer. </p>
IFMO	In interface mode	<p>[Function] Notifies the control mode is in interface mode.</p> <p>[Operation] <Conditions for turning on> <ul style="list-style-type: none"> Interface mode is selected in control mode, and system startup is performed. <Conditions for turning off> <ul style="list-style-type: none"> Standard mode is selected in control mode, and system startup is performed. </p>

9. INTERFACE MODE

(4) Axis command/status

(a) Axis command

Address	Name	Setting range	Remarks
1030	Latest command buffer number	0 to 63	Set the latest command buffer number after updating.
1031			
1032	Control mode command	Refer to remarks	Set the mode to switch to. 0000h: Position control mode 0001h: Speed control mode 0002h: Torque control mode
1033			
1048	Torque control speed limit value (0.01r/min)	0 to 1000000000	Set the speed limit value when in torque control mode. When a value outside the setting range is set, the previous value that was set within the valid range is the speed limit value. Also, torque control setting error (operation alarm 2F, detail No.01) occurs.
1049			
104A			
104B			

Note. The addresses above are the addresses for the first axis. For the second axis and after, increase by C0h for each axis.

(b) Axis status

Address	Name	Setting range	Remarks
108E	Maximum buffer number	1 to 64	Notifies the maximum buffer number that can be used.
108F			
1090	Transmit buffer number	0 to 63	Notifies buffer number that is being transmitted.
1091			
1092	Control mode status	Refer to remarks	The current control mode is shown below. 
1093			

Note 1. A control mode switch error occurs when conducting the following operations.

- Switching from position control mode to another control mode while zero speed (ZSP) is OFF.
- Specifying a control mode outside of range to control mode command.

2. The addresses above are the addresses for the first axis. For the second axis and after, increase by C0h for each axis.

9. INTERFACE MODE

(5) Command buffer

The number of buffers and the addresses that are used differ for each control mode. The buffers for each control mode are shown below.

(a) Position control mode

Address	Content
5000	Position command buffer 0 (pulse)
5001	
5002	
5003	Position command buffer 1 (pulse)
5004	
5005	
5006	Position command buffer 2 (pulse)
5007	
5008	
5009	Position command buffer 3 (pulse)
500A	
500B	
500C	Position command buffer 4 (pulse)
500D	
500E	
500F	Position command buffer 5 (pulse)
5010	
5011	
5012	Position command buffer 6 (pulse)
5013	
5014	
5015	Position command buffer 7 (pulse)
5016	
5017	
5018	Position command buffer 8 (pulse)
5019	
501A	
501B	Position command buffer 9 (pulse)
501C	
501D	
501E	Position command buffer 10 (pulse)
501F	

Address	Content
5020	Position command buffer 8 (pulse)
5021	
5022	
5023	Position command buffer 9 (pulse)
5024	
5025	
5026	Position command buffer 10 (pulse)
5027	
5028	
5029	Position command buffer 60 (pulse)
502A	
502B	
502C	Position command buffer 61 (pulse)
:	
502E	
502F	Position command buffer 62 (pulse)
5030	
5031	
5032	Position command buffer 63 (pulse)
5033	
5034	
5035	Position command buffer 64 (pulse)
5036	
5037	
5038	Position command buffer 65 (pulse)
5039	
503A	
503B	Position command buffer 66 (pulse)
503C	
503D	
503E	Position command buffer 67 (pulse)
503F	
5040	

Note. The addresses in the table are the addresses for the axis 1. For the axis 2 and above, increase the units of 100h for each axis.

9. INTERFACE MODE

(b) Speed control mode

Address	Content
7800	Speed command buffer 0 (0.01r/min)
7801	
7802	
7803	

Note 1. Setting range: -1000000000 (-10000000r/min) to 1000000000 (10000000r/min)

2. The addresses above are the addresses for the first axis.

For the second axis and after, increase by 80h for each axis.

(c) Torque control mode

Address	Content
8C00	Torque command buffer 0
8C01	(0.1%)
8C02	(When parameter No.010D is 0,
8C03	positive: CCW, negative: CW)

Note 1. Setting range: -32768 (-3276.8%) to 32767 (3276.7%)

2. The addresses above are the addresses for the first axis.

For the second axis and after, increase by 80h for each axis.

9. INTERFACE MODE

9.5 Control method

9.5.1 Control mode

The control mode is switched by specifying the control mode in the "control mode command". Switching to/from position control mode to/from speed control mode/torque control mode is performed while the motor is stopped, and switching between speed control mode and torque control mode is possible at any given time. Refer to Section 9.5.7 and Section 9.5.8 for details on switching control mode.

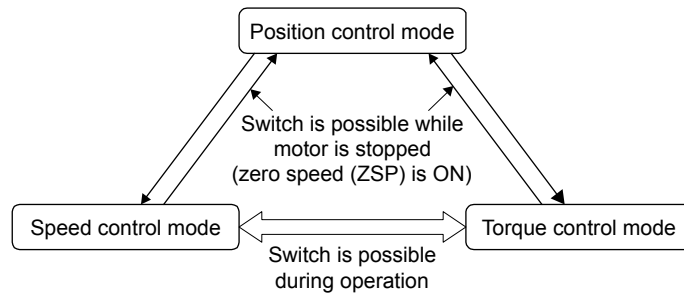

POINT
<ul style="list-style-type: none">• After turning power supply ON, or after SSCNET reconnection, the control mode is position control mode.• When a control mode other than position control mode was specified at power supply ON, or SSCNET reconnection, startup in position control mode, before switching to the specified control mode.• When a control mode switch error has occurred, return the control mode command to the current control mode before performing the control mode switch again.• When switching from speed control mode or torque control mode, update the command position with the current feedback position after confirming zero speed (ZSP).• The data for control mode command is applied at the timing of the command data update cycle.

9. INTERFACE MODE

9.5.2 Position control mode

Position control mode is where position commands (absolute position in pulse units) generated by the user program can be sent to the servo amplifier. The position command buffer is made up of position data × a maximum of 64 ring buffers, and is controlled with the latest position command buffer number and the transmitting position buffer number.

Refer to Section 9.5.5 or Section 9.5.6 for the update method of the buffer.

POINT
<ul style="list-style-type: none"> For the setting value of the position command buffer, ensure that the difference between the previous command value and the current command value is no more than 20000000. When the difference between the previous command value and the current command value exceeds 20000000, command data error (operation alarm A7, detail No.03) occurs, followed by an immediate stop. When an alarm other than command data error (operation alarm A7, detail No.03) occurs, conduct a deceleration stop by the user program.

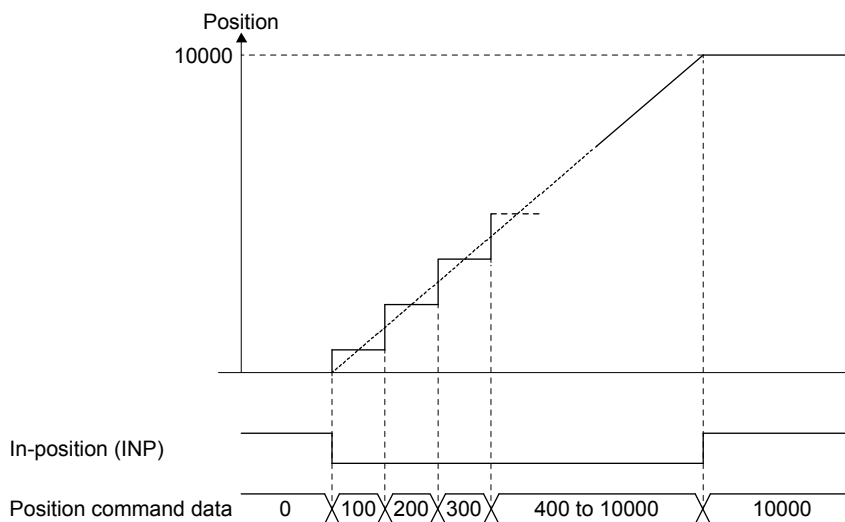

(1) Parameter

(a) System parameter

Parameter No.	Abbreviation	Name	Remarks
000F	*IFMO	Interface mode option	Specify the interrupt output cycle and command data update cycle.

(b) Control parameter

Parameter No.	Abbreviation	Name	Remarks
0210	TLP	Forward rotation torque limit value	Becomes valid when using torque limit.
0211	TLN	Reverse rotation torque limit value	
023F	*IFBN	Interface mode maximum buffer number	Set the maximum buffer number of the position command buffer. Note. When interrupt output is invalid in interface mode, 1 or higher must be set.

9. INTERFACE MODE

(2) Axis data command/status table

Axis data command table

Address	Content	Setting range
1030	Latest position command buffer number	0 to 63
1031		

Axis data status table

Address	Content	Output range
108E	Maximum position command buffer number	1 to 64
108F		
1090	Transmit position command buffer number	0 to 63
1091		

Note. The addresses above are the addresses for the first axis. For the second axis and after, increase by C0h for each axis.

(3) Position command buffer

Address	Name	Initial value	Units	Setting range	Remarks
5000	Position command buffer 0	0	pulse	-2147483648 to 2147483647	Input the target position in absolute position for every command data update cycle.
5001					
5002					
5003					
5004	Position command buffer 1	0	pulse	-2147483648 to 2147483647	Input the target position in absolute position for every command data update cycle.
5005					
5006					
5007					
5008	:	0	pulse	-2147483648 to 2147483647	Input the target position in absolute position for every command data update cycle.
:					
50FB					
50FC	Position command buffer 63	0	pulse	-2147483648 to 2147483647	Input the target position in absolute position for every command data update cycle.
50FD					
50FE					
50FF					

Note. The addresses in the table are the addresses for the first axis. For the second axis and after, increase by 100h for each axis.

9. INTERFACE MODE

9.5.3 Speed control mode

Speed control mode is where speed commands (speed in units of 0.01r/min) generated by the user program can be sent to the servo amplifier. The speed command buffer is made up of speed command data × a maximum of 1 buffer.

Refer to Section 9.5.6 for the update method of the buffer.

POINT
<ul style="list-style-type: none"> • If a value outside of the range is input to the speed command buffer, command data error (operation alarm A7, detail No.01) occurs. The speed command value becomes 0[0.01r/min], followed by an immediate stop. • When an alarm other than command data error (operation alarm A7, detail No.01) occurs, conduct a deceleration stop by the user program.

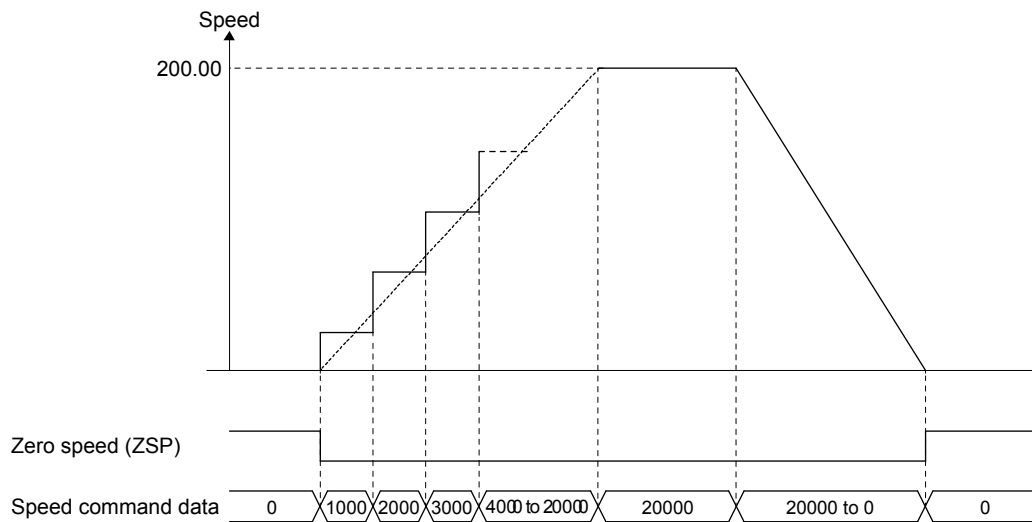

(1) Parameter

(a) System parameter

Parameter No.	Abbreviation	Name	Remarks
000F	*IFMO	Interface mode option	Specify the interrupt output cycle and command data update cycle.

(b) Control parameter

Parameter No.	Abbreviation	Name	Remarks
0210	TLP	Forward rotation torque limit value	Becomes valid when using torque limit.
0211	TLN	Reverse rotation torque limit value	

9. INTERFACE MODE

(2) Speed command buffer

Address	Name	Initial value	Units	Setting range	Remarks
7800	Speed command buffer 0	0	0.01r/min	-1000000000 to 1000000000	Input the target speed for every command data update cycle.
7801					
7802					
7803					

Note. The addresses in the table are the addresses for the first axis. For the second axis and after, increase by 80h for each axis.

(3) Monitor

When using speed control mode in interface mode, use the following monitor numbers to monitor/sample the speed commands being sent to the servo amplifier.

(a) Operation information

Monitor No.	Content	Units	Remarks
0324	Speed command (lower)	0.01r/min	Notifies the speed command during speed control.
0325	Speed command (upper)		

(b) Operation information (double word)

Monitor No.	Content	Units	Remarks
1324	Speed command	0.01r/min	Notifies the speed command during speed control.

9. INTERFACE MODE

9.5.4 Torque control mode

Torque control mode is where torque commands (torque in units of 0.1%) generated by the user program of the C Controller module can be sent to the servo amplifier. The torque command buffer is made up of torque command data × a maximum of 1 buffer.

Refer to Section 9.5.6 for the update method of the buffer.

The relationship between the torque command and the direction of the output torque of the servo motor differs depending on the settings of rotation direction selection/movement direction selection (servo parameter No.110D) and function selection C-B (servo parameter No.119C). The torque command during torque control mode is restricted by the torque control speed limit value.

The meanings of the signs for the following data that can be referred to by the monitor during torque control mode differ from other control modes.

• Servo information (2)

Monitor No.	Content	Units
020A	Electrical current command	0.1%
020B	Electrical current feedback	0.1%

The meanings of the signs for electrical current command (monitor No.020A) and electrical current feedback (monitor No.020B) during torque control mode are as follows.

Parameter No.	Command direction	Motor revolution direction	Electrical current command/electrical current feedback sign		
			Position control	Speed control	Torque control
0	Positive	CCW (positive)	Positive	Positive	Positive
	Negative	CW (negative)	Negative	Negative	Negative
1	Positive	CW (negative)	Negative	Negative	Positive
	Negative	CCW (positive)	Positive	Positive	Negative

POINT

- If a value outside of the range is input to the torque command buffer, command data error (operation alarm A7, detail No.02) occurs. The torque command value becomes the value before the change.
- When an alarm occurs, conduct a deceleration stop by the user program.

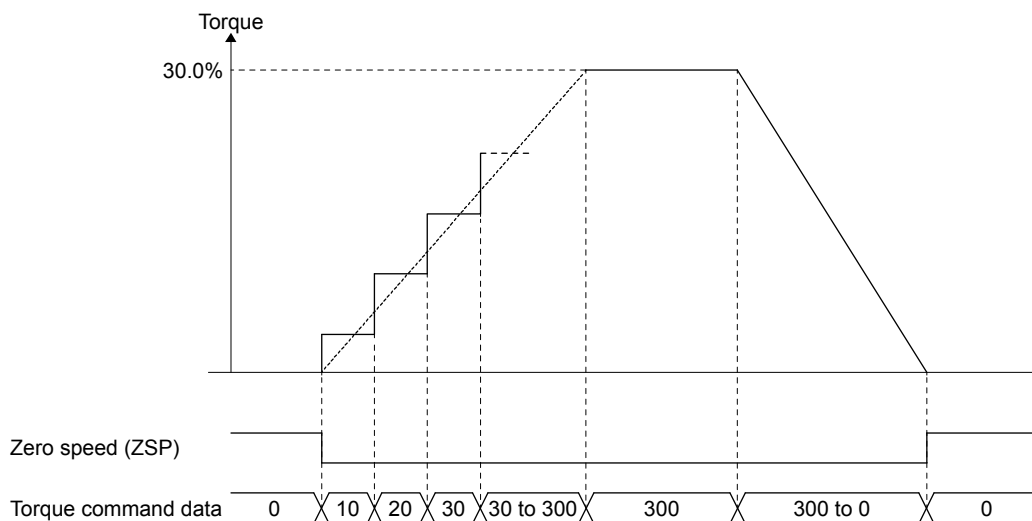

9. INTERFACE MODE

(1) Parameter

(a) System parameter

Parameter No.	Abbreviation	Name	Remarks
000F	*IFMO	Interface mode option	Specify the interrupt output cycle and command data update cycle.

(2) Axis data command/status table

Axis data command table

Address	Content	Setting range
1048	Torque control speed limit value (0.01r/min)	0 to 1000000000
1049		
104A		
104B		

Note. The addresses above are the addresses for the first axis.

For the second axis and after, increase by C0h for each axis.

(3) Torque command buffer

Address	Name	Initial value	Units	Setting range	Remarks
8C00	Torque command buffer 0	0	0.1%	-32768 to 32767	Input the target torque for every command data update cycle.
8C01					
8C02					
8C03					

Note. The addresses in the table are the addresses for the first axis. For the second axis and after, increase by 80h for each axis.

9. INTERFACE MODE

9.5.5 Control method for interrupt output invalid

Interrupt output invalid is compatible with position control mode only.

POINT	
	<ul style="list-style-type: none">▪ When the update of the latest position command buffer number is delayed etc. due to the load, etc. on the user program, and the latest position command buffer number and transmit position command buffer number continue to get closer, the same position command details are transmitted to the servo amplifier, and over time, an axis that was in operation, begins to output a command of speed 0.▪ When controlling with interrupt output invalid, set the Interface mode maximum buffer number (parameter No.023F) to 1 or more. When set to 0, the position command buffer cannot be updated and thus cannot control. (The same position command is transmitted to the servo amplifier)

The following is the control method for when interrupt output is invalidated (ITS is turned off).

The user program updates the latest position command buffer number by checking the latest position command buffer number and transmit position command buffer number at any given time, and setting the position command for each command data update cycle to an empty buffer. At this time, do not change the contents of the buffers between the transmit position command buffer number and latest position command buffer number.

The Q173SCCF transmits the contents of the next buffer every command data update cycle, and updates the transmit position command buffer number.

Note. When a value outside the range is set to the latest position command buffer number, a latest command buffer number setting error (operation alarm 2D) is output, and it stops.

9. INTERFACE MODE

(1) Procedure for updating position command data

The procedure for updating position command data when interrupt output is invalid is shown below.

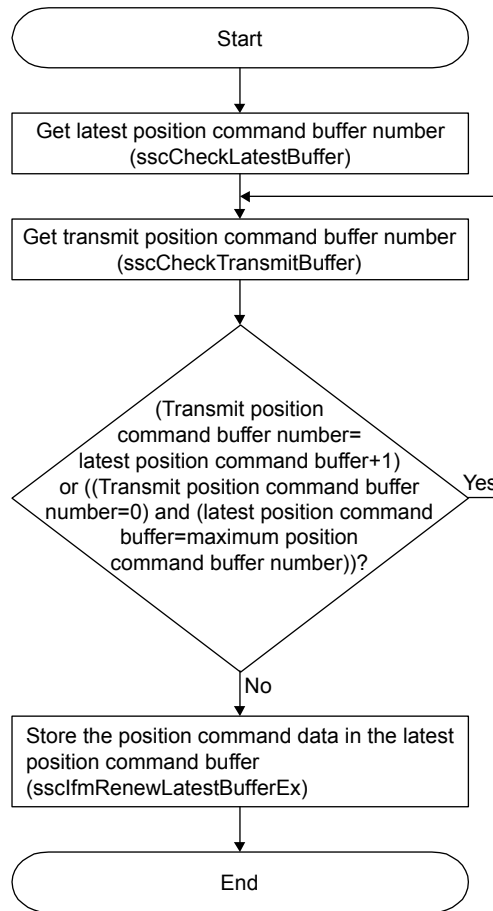

POINT

- During servo off always perform a follow up (store current feedback position to the latest position command buffer). Immediately after servo on, the motor may operate at a very high speed.
- When servo ready (RDY) switches from ON to OFF due to an alarm factor etc., turn servo on (SON) OFF. After removing the cause, an unexpected operation may occur.

9. INTERFACE MODE

9.5.6 Control method for interrupt output valid

There is no difference in control method for position control mode, speed control mode and torque control mode when control method for interrupt output is valid. The control method is as follows.

The following is the control method for when interrupt output is validated (ITS is turned on), and the number of command buffers used is 0.

The Q173SCCF outputs the command set by the user program for every command data update cycle after the system startup. While ITS is turned on, an interrupt is generated every interrupt output cycle. Have the user program update the command buffer 0, and read the high speed monitor from the generation of an interrupt (interrupt output cycle – control cycle/2). The command data update cycle, and interrupt output cycle can be set in Interface mode option (parameter No.000F).

In the time from the generation of an interrupt until the completion of the above process, turn on the during user program memory access signal (HMA). When the system program reads the command, it checks the during user program memory access signal (HMA). When the signal is on, the update is regarded as incomplete and does not perform the read, and the command buffer read error counter is incremented. When this happens, the previous position command value is sent to the servo amplifier, and when in position control mode, an immediate stop follows. When in speed control mode or torque control mode, operation continues with the previous values and same command data.

While the Q173SCCF is reading command and writing high speed monitor, the during system program memory access signal (BMA) is turned on. (When it is not a control cycle where command data is updated, during system program memory access signal (BMA) is not turned on).

When in position control mode and using several buffers in interrupt output valid, perform the same process at every interrupt output as interrupt output invalid. Clear the interrupt signal (IRQ) by writing 0 to the interrupt clear register (offset 20008h of dual port memory). Be sure to clear the interrupt signal within the interrupt handler.

Note. For real time processing, the execution of command read, high speed monitor, and communication with servo amplifier within the control cycle are guaranteed processes.

9. INTERFACE MODE

The timing of control differs depending on the settings of the command data update cycle and interrupt output cycle.

Use the table below when referring to the timing charts.

Command data update cycle	Interrupt output cycle	Reference
Control cycle × 1	Control cycle × 1	Refer to (2)(a)
	Control cycle × n (n = 2 to 16)	(Note 2)
Control cycle × 2	Control cycle × 1	Refer to (3), (Note 1)
	Control cycle × 2	Refer to (2)(b)
	Control cycle × n (n = 3 to 16)	(Note 2)
Control cycle × 3	Control cycle × 1	Refer to (3), (Note 1)
	Control cycle × 2	Unavailable
	Control cycle × 3	Refer to (2)(b)
	Control cycle × n (n = 4 to 16)	(Note 2)
Control cycle × 4	Control cycle × 1	Refer to (3), (Note 1)
	Control cycle × 2	Refer to (3), (Note 1)
	Control cycle × 3	Unavailable
	Control cycle × 4 (n = 4 to 16)	Refer to (2)(b)
	Control cycle × n (n = 5 to 16)	(Note 2)
:	:	:
Control cycle × m (m = 5 to 16)	Control cycle × n (when n < m, and m is a factor of n)	Refer to (3), (Note 1)
	Control cycle × n (when n < m, and m is not a factor of n)	Unavailable
	Control cycle × n when n = m	Refer to (2)(b)
	Control cycle × n (when n > m)	(Note 2)

Note 1. When the update of the command is slower than the control cycle, the servo amplifier in-position signal and current feedback position is still used when importing in a cycle shorter than the command data update is necessary.

2. When command data update cycle < interrupt output cycle, and command is updated for every interrupt output cycle, the timing of the update of command data is still too late. For position control mode the update of several position command buffers every interrupt output cycle is necessary. Set the maximum buffer number so that (command data update cycle) × (maximum buffer number + 1) > (interrupt output cycle), and perform the control method for interrupt output invalid at the timing of the interrupt generation.

For speed control mode or torque control mode, the above setting cannot be used.

9. INTERFACE MODE

(1) Procedure for updating command data

The procedure for storing command data is shown below.

There is no difference in the procedure for position control mode, speed control mode, or torque control mode.

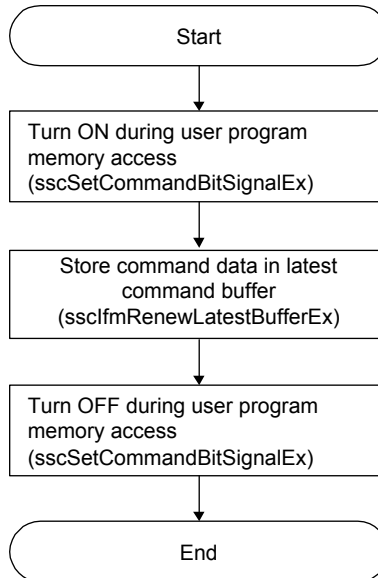

9. INTERFACE MODE

(2) When command data update cycle = interrupt output cycle

(a) When command data update cycle is control cycle $\times 1$, and interrupt out cycle is control cycle $\times 1$.

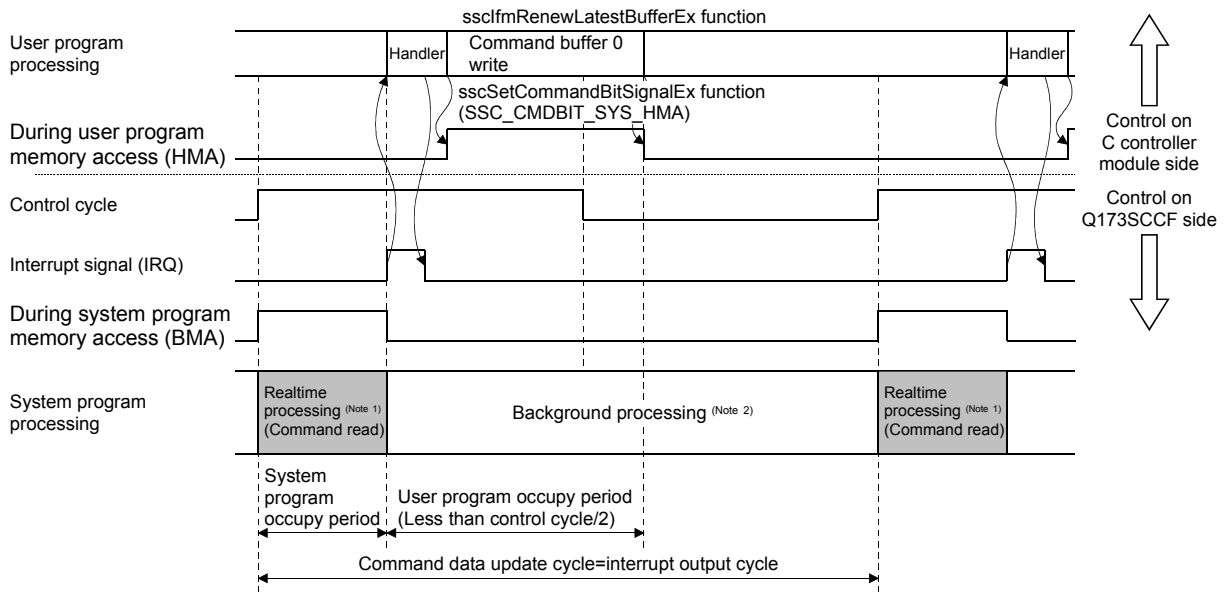

Note 1. For real time processing, the execution of command read, high speed monitor, and communication with servo amplifier within the control cycle are guaranteed processes.

2. For background processing, the execution of monitor, parameter read/write within the control cycle are not guaranteed processes.

(b) When command data update cycle is control cycle $\times n$, and interrupt output cycle is control cycle $\times n$.

The following is an example of when command data update cycle = interrupt output cycle = control cycle $\times 2$.

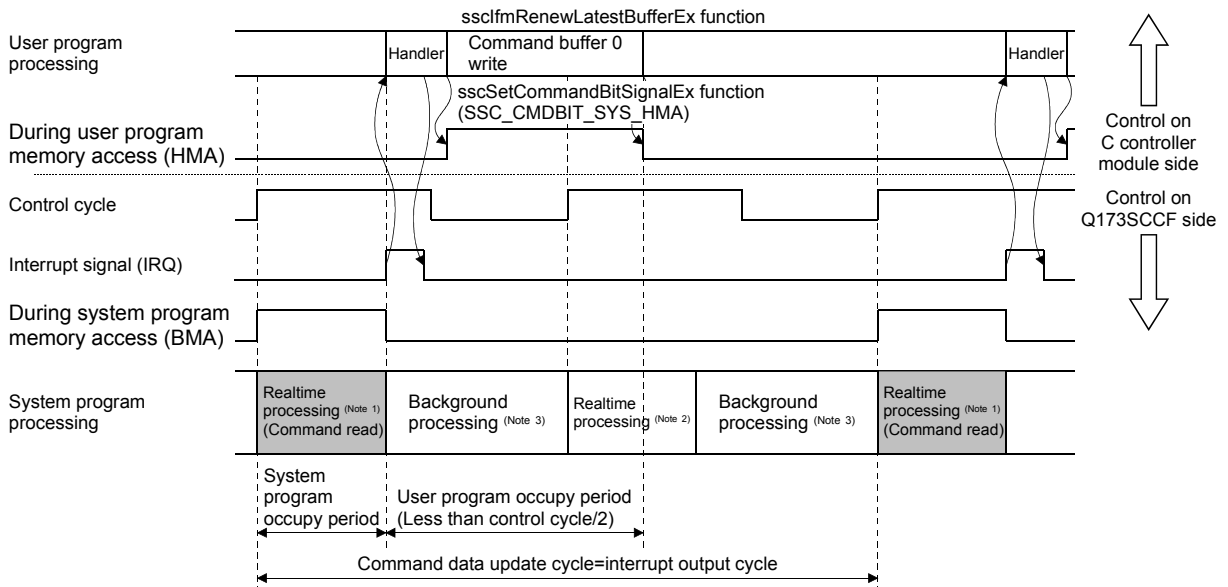

Note 1. For real time processing, the execution of command read, high speed monitor, and communication with servo amplifier within the control cycle are guaranteed processes.

2. Reading of command is not performed for this real time process. (During system program memory access (BMA) does not turn on)

3. For background processing, the execution of monitor, parameter read/write within the control cycle are not guaranteed processes.

9. INTERFACE MODE

(3) When command data update cycle > interrupt output cycle

The following is an example of when command data update cycle is control cycle $\times 2$, and interrupt output cycle is control cycle $\times 1$.

Using the interrupt output cycle as a reference, the user program updates the command buffer during the command data update cycle once only. Make sure the user program occupy period is within (interrupt output cycle) – (control cycle/2).

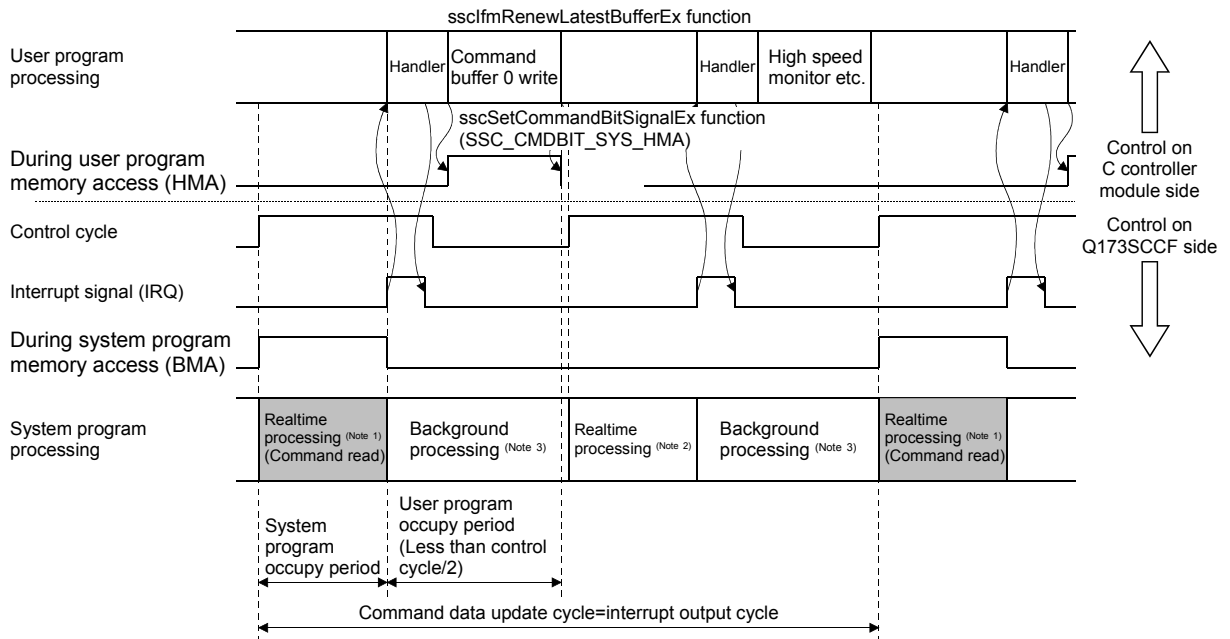

Note 1. For real time processing, the execution of command read, high speed monitor, and communication with servo amplifier within the control cycle are guaranteed processes.

2. Reading of command is not performed for this real time process. (During system program memory access (BMA) does not turn on)

3. For background processing, the execution of monitor, parameter read/write within the control cycle are not guaranteed processes.

9. INTERFACE MODE

9.5.7 Procedure for switching control mode

The procedure when switching control mode is as follows.

(1) Position control mode

Switch to position control mode is performed with the following procedure.

- (a) Check that zero speed (ZSP) is turned ON.
- (b) Perform a follow up to update the position command to match the current feedback position.
- (c) Input "0: Position control mode" to the control mode command.
- (d) Check that control mode status is "0: Position control mode".
- (e) Stop follow up.

API LIBRARY

- To check if zero speed (ZSP) is ON/OFF in (a) above, set SSC_STSBIT_AX_ZSP to the status bit number with the sscGetStatusBitSignalEx or sscWaitStatusBitSignalEx functions.
- Use the sscIfmRenewLatestBufferEx function to perform follow up in (b) above.
- Use the sscIfmSetControlMode function to set control mode command in (c) above.
- Use the sscIfmGetControlMode function to check control mode status in (d) above.

(2) Speed control mode

Switch to speed control mode is performed with the following procedure.

- (a) Check that zero speed (ZSP) is turned ON.
(Not required when switching from torque control mode)
- (b) Input "1: Speed control mode" to the control mode command.
- (c) Check that control mode status is "1: Speed control mode".

POINT

- Use the value of the torque limit (parameter No.0210, No.0211) during speed control mode. Set the value before switching modes.

API LIBRARY

- To check if zero speed (ZSP) is ON/OFF in (a) above, set SSC_STSBIT_AX_ZSP to the status bit number with the sscGetStatusBitSignalEx or sscWaitStatusBitSignalEx functions.
- Use the sscIfmSetControlMode function to set control mode command in (b) above.
- Use the sscIfmGetControlMode function to check control mode status in (c) above.

9. INTERFACE MODE

(3) Torque control mode

Switch to torque control mode is performed with the following procedure.

- (a) Check that zero speed (ZSP) is turned ON.
(Not required when switching from speed control mode)
- (b) Input the speed limit value during torque control mode to the torque control speed limit value.
- (c) Input "2: Torque control mode" to the control mode command.
- (d) Check that control mode status is "2: Torque control mode".

POINT

- | |
|--|
| <ul style="list-style-type: none">• Set the torque control speed limit value before switching modes. |
|--|

API LIBRARY

- | |
|--|
| <ul style="list-style-type: none">• To check if zero speed (ZSP) is ON/OFF in (a) above, set SSC_STSBIT_AX_ZSP to the status bit number with the sscGetStatusBitSignalEx or sscWaitStatusBitSignalEx functions.• Use the sscIcmTrqSetSpeedLimit function to set torque control speed limit value in (b) above.• Use the sscIcmSetControlMode function to set control mode command in (c) above.• Use the sscIcmGetControlMode function to check control mode status in (d) above. |
|--|

9. INTERFACE MODE

9.5.8 Examples of switching control mode

The switch timing for every setting of position control mode, speed control mode, and torque control mode when using interface mode is as follows.

(1) Position control mode ↔ speed control mode

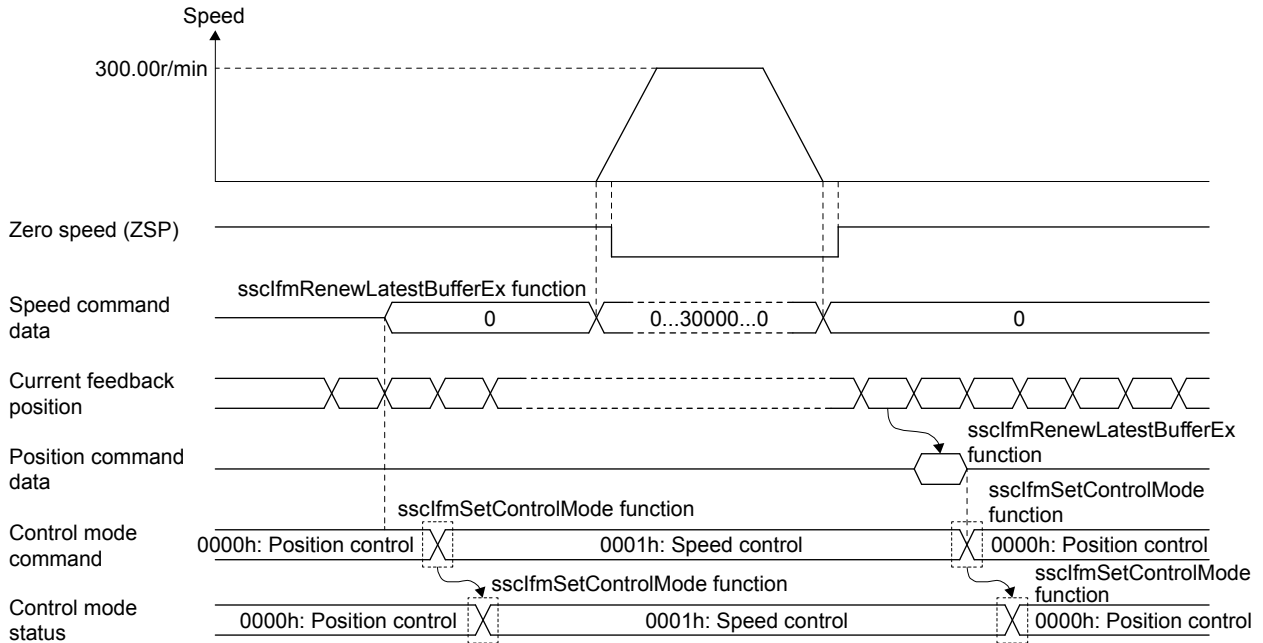

POINT

- When switching to position control mode and the travel amount at follow up exceeds 20000000, set position command data to the position command buffer to ensure that the travel amount per cycle is 20000000 or less.

9. INTERFACE MODE

(2) Position control mode ↔ torque control mode

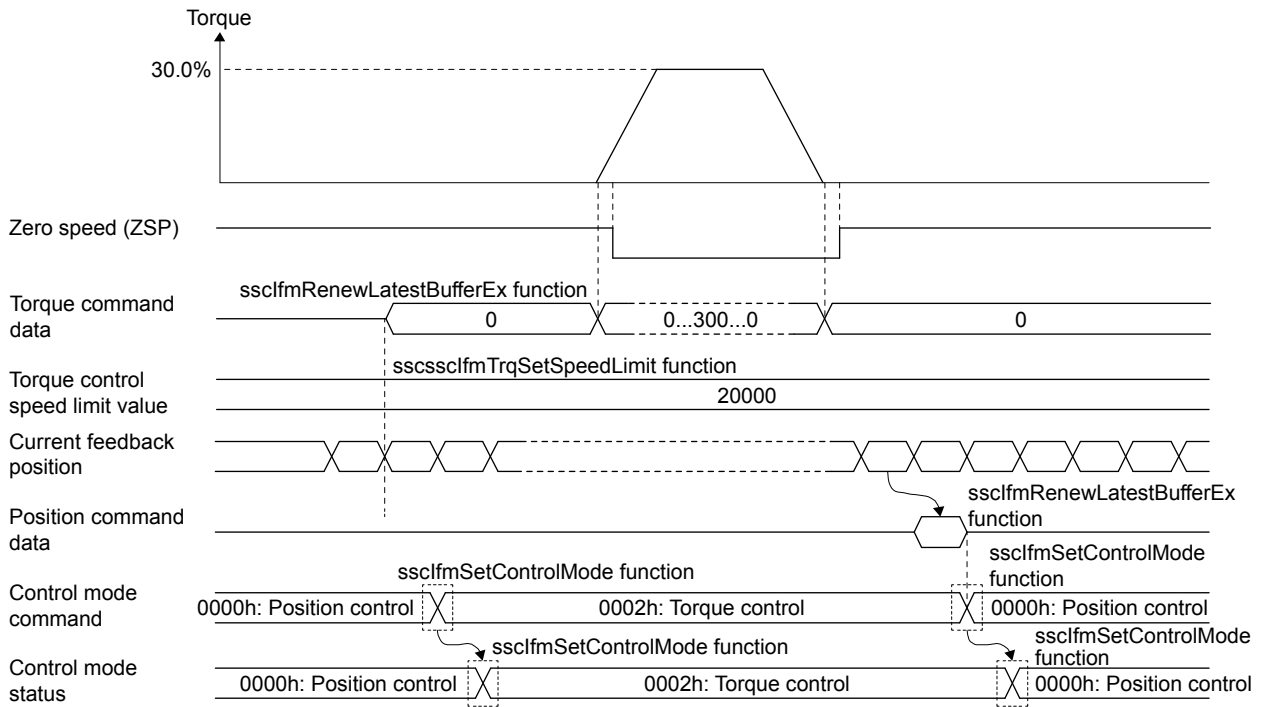

POINT

- Set the torque control speed limit value before switching control modes.
- When returning to position control mode, switch control modes after checking that zero speed (ZSP) is turned ON. If control mode is switched while zero speed (ZSP) is OFF, control mode switch error (operation alarm 2E, detail No.01) occurs.
- When switching to position control mode and the travel amount at follow up exceeds 20000000, set position command data to the position command buffer to ensure that the travel amount per cycle is 20000000 or less.

9. INTERFACE MODE

(3) Speed control mode ↔ torque control mode

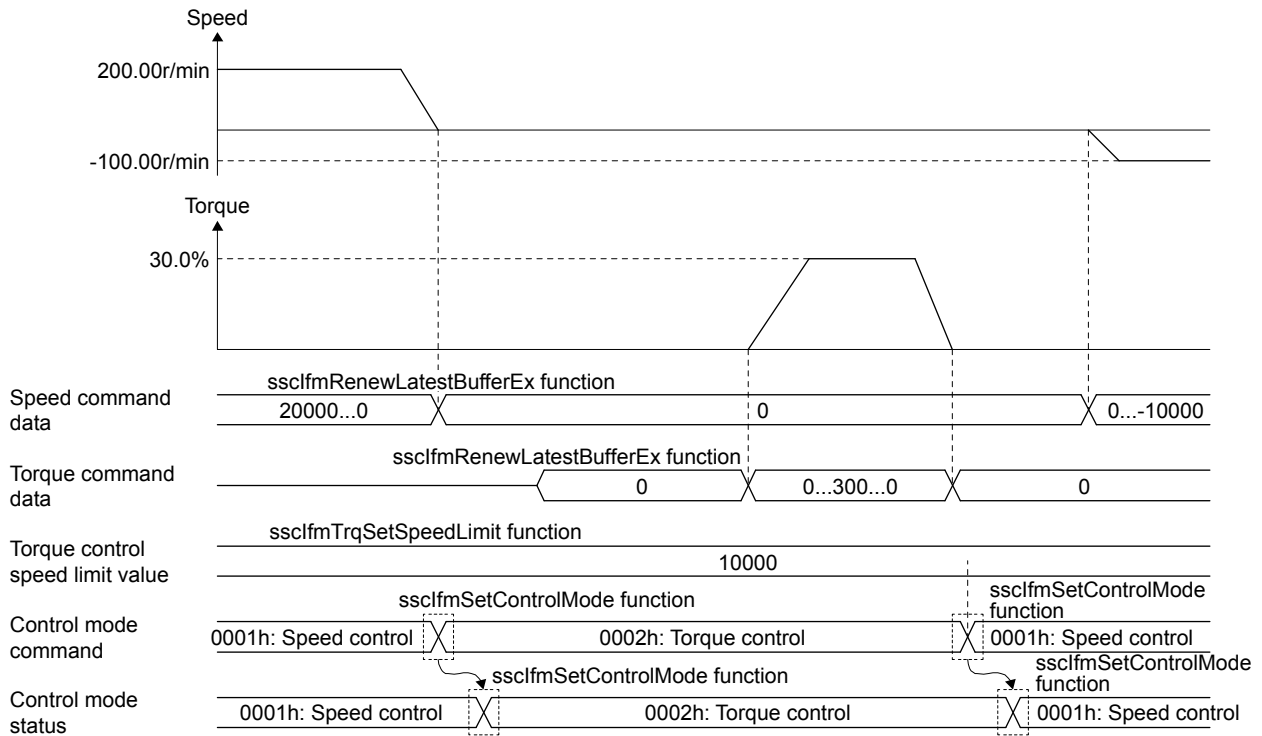

- Note 1. The torque at speed control, and the speed at torque control depends on the system the servo motor is connected to.
- Note 2. When returning to speed control during torque control, set the speed command data before switching to torque control. Depending on the speed command data at this time, the torque may increase/decrease due to torque control.

POINT
• Set the torque control speed limit value before switching control modes.

9. INTERFACE MODE

9.6 Interrupt output cycle

When several buffer are used in interrupt valid, and interrupt output for every control cycle is not needed, the cycle of interrupt output can be changed by the interrupt output cycle of Interface mode option (parameter No.000F).

(1) System parameters

Parameter No.	Abbreviation	Name	Initial value	Units	Setting range	Function
000F	*IFMO	Interface mode option	0000h		0000h to 0F0Fh	<div style="display: flex; align-items: center;"> <div style="border: 1px solid black; padding: 2px; margin-right: 10px;">0</div> <div style="border: 1px solid black; padding: 2px; margin-right: 10px;">0</div> <div style="border: 1px solid black; padding: 2px; margin-right: 10px;">0</div> <div style="border: 1px solid black; padding: 2px; margin-right: 10px;"> </div> </div> <p>Interrupt output cycle When interrupt by interface mode is valid, set the cycle for which the interrupt is output. Interrupt output cycle: Control cycle \times(setting value+1) Example: When interrupt output cycle is set to 1 and control cycle is 0.88ms, interrupt is output approximately every 1.77ms.</p>

(2) Interrupt output cycle

The relationship between interrupt output cycle and control cycle is shown in the table below.

Setting value	0	1	2	3	• •	8	• •	15
Control cycle 0.88ms	0.88ms	1.77ms	2.66ms	3.55ms	• •	8.00ms	• •	14.22ms
Control cycle 0.44ms	0.44ms	0.88ms	1.33ms	1.77ms		4.00ms		7.11ms
Control cycle 0.22ms	0.22ms	0.44ms	0.66ms	0.88ms		2.00ms		3.55ms

9. INTERFACE MODE

9.7 Command data update cycle

The update cycle of command can be changed by command data update cycle of Interface mode option (parameter No.000F). Have the user program generate the command for every command data update cycle, and set to command buffer.

Note. Because communication with the servo amplifier is performed every control cycle, the current feedback position and other high speed monitors are updated every control cycle.

(1) System parameters

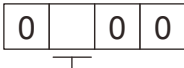
Parameter No.	Abbreviation	Name	Initial value	Units	Setting range	Function
000F	*IFMO	Interface mode option	0000h		0000h to 0F0Fh	 <p>Command data update cycle Set the cycle for which command is updated in interface mode. Command data update cycle: Control cycle×(setting value+1) Example: When command data update cycle is set to 2 and control cycle is 0.88ms, command is updated approximately every 2.66ms.</p>

(2) Command data update cycle

The relationship between command data update cycle and control cycle is shown in the table below.

Setting value	0	1	2	3	• •	8	• •	15
Control cycle 0.88ms	0.88ms	1.77ms	2.66ms	3.55ms		8.00ms		14.22ms
Control cycle 0.44ms	0.44ms	0.88ms	1.33ms	1.77ms	• •	4.00ms	• •	7.11ms
Control cycle 0.22ms	0.22ms	0.44ms	0.66ms	0.88ms		2.00ms		3.55ms

9. INTERFACE MODE

9.8 Event detection function

The event detection function detects the ON/OFF edges of specified status bits. Using this function eliminates the process of getting the status bits for every control cycle, reducing the processing load of the user program. The event detection function outputs the factor of event to the dual port memory when an event (alarm occurrence, change in the status of sensor input) occurs. The user program monitors the factor of event in addition to referring to outputting with factor of interrupt (ITO), and information of outputting with factor of interrupt.

The event detection function can be used at any time, and no settings are required to use it.

For clearing the factor of event, turn ON the interrupt processing high speed complete signal (ITFE). When the Q173SCCF receives the interrupt processing high speed complete signal (ITFE), it turns OFF the interrupt processing high speed complete signal (ITFE), and clears the factor of event.

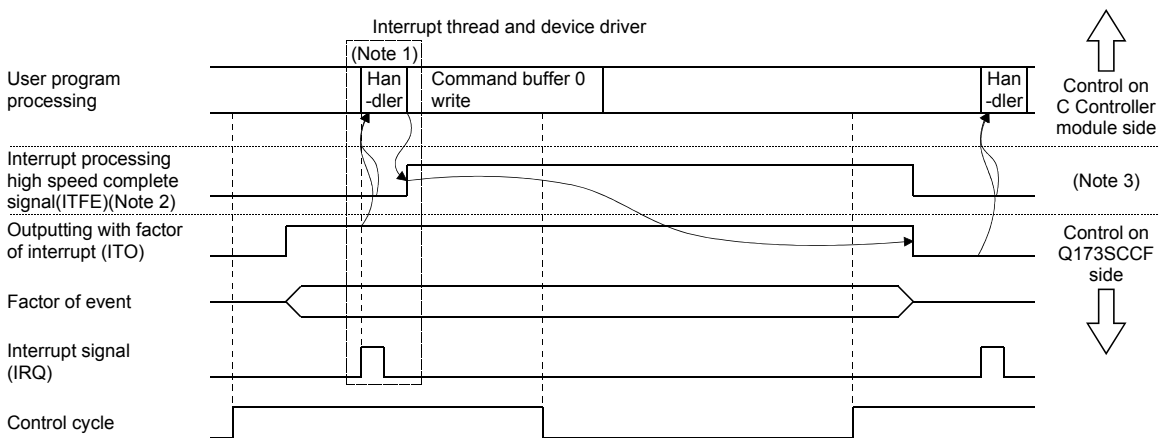

Note 1. The outputting with factor of interrupt (ITO), information of outputting with factor of interrupt, and factor of axis event are read by the interrupt handler.

Note 2. The Q173SCCF gets the commands for every control cycle.

Note 3. ON is performed on the API library side (interrupt handler), and OFF is performed by the Q173SCCF.

POINT
<ul style="list-style-type: none"> • When more than one event is detected in the same control cycle, all applicable factors of event turn ON. • Factors of event are held until interrupt processing high speed complete signal (ITFE) is conducted. However, if the status of a signal changes while it is being held, the last status is retained. (Example. While a factor of event is being held, when an OFF edge is detected after the detection of an ON edge, only the OFF edge is output.) • A factor of event in the system is the same as a system interrupt factor. Refer to Section 7.6.

API LIBRARY
<ul style="list-style-type: none"> • Getting the factor of event and turning ON the interrupt processing high speed complete signal are processed by the interrupt thread and device driver that is created when calling the <code>ssclntStart</code> function. Thus processing by user program is unnecessary. • Use the <code>ssclfmGetEventStatusBits</code> function for getting factor of event.

9. INTERFACE MODE

(1) Factor of axis event

(a) Factor of axis event

Address	Content
0EE0	Factor of event Axis 1
0EE1	
0EE2	
0EE3	
0EE4	Factor of event Axis 2
0EE5	
0EE6	
0EE7	
0EE8	Factor of event Axis 3
0EE9	
0EEA	
0EEB	
0EEC	Factor of event Axis 4
0EED	
0EEE	
0EEF	
0EF0	Factor of event Axis 5
0EF1	
0EF2	
0EF3	
0EF4	Factor of event Axis 6
0EF5	
0EF6	
0EF7	
0EF8	Factor of event Axis 7
0EF9	
0EFA	
0EFB	
0EFC	Factor of event Axis 8
0EFD	
0EFE	
0EFF	
0F00	Factor of event Axis 9
0F01	
0F02	
0F03	
0F04	Factor of event Axis 10
0F05	
0F06	
0F07	
0F08	Factor of event Axis 11
0F09	
0F0A	
0F0B	

Address	Content
0F0C	Factor of event Axis 12
0F0D	
0F0E	
0F0F	
0F10	Factor of event Axis 13
0F11	
0F12	
0F13	
0F14	Factor of event Axis 14
0F15	
0F16	
0F17	
0F18	Factor of event Axis 15
0F19	
0F1A	
0F1B	
0F1C	Factor of event Axis 16
0F1D	
0F1E	
0F1F	
0F20	Factor of event Axis 17
0F21	
0F22	
0F23	
0F24	Factor of event Axis 18
0F25	
0F26	
0F27	
0F28	Factor of event Axis 19
0F29	
0F2A	
0F2B	
0F2C	Factor of event Axis 20
0F2D	
0F2E	
0F2F	
0F30	Reserved
0F31	
0F32	
:	
0F9D	
0F9E	
0F9F	

9. INTERFACE MODE

(b) Details on factor of event on axis n

The addresses in the table are the addresses for the axis 1. For the axis 2 and above, increase in units of 04h for each axis.

Address	Bit	(Note) Abbreviation	Signal name	
0EE0 to 0EE3	0	iRDYON	Servo ready (ON edge)	
	1	iINPON	In-position (ON edge)	
	2	iZSPON	Zero speed (ON edge)	
	3	iTLCON	Torque limit effective (ON edge)	
	4	iSALMON	Servo alarm (ON edge)	
	5	iSWRNON	Servo warning (ON edge)	
	6	iABSEON	Absolute position erased (ON edge)	
	7	iOALMON	Operation alarm (ON edge)	
	8	iMAK1ON	Mark detection 1 (ON edge)	
	9	iMAK2ON	Mark detection 2 (ON edge)	
	10	/		Reserved
	11			
	12			
	13	iLSPON	+ side limit switch (ON edge)	
	14	iLSNON	- side limit switch (ON edge)	
	15	iDOGON	Proximity dog (ON edge)	
	16	iRDYOF	Servo ready (OFF edge)	
	17	iINPOF	In-position (OFF edge)	
	18	iZSPOF	Zero speed (OFF edge)	
	19	iTLCOF	Torque limit effective (OFF edge)	
	20	iSALMOF	Servo alarm (OFF edge)	
	21	iSWRNOF	Servo warning (OFF edge)	
	22	iABSEOF	Absolute position erased (OFF edge)	
	23	iOALMOF	Operation alarm (OFF edge)	
	24	iMAK1OF	Mark detection 1 (OFF edge)	
	25	iMAK2OF	Mark detection 2 (OFF edge)	
	26	/		Reserved
	27			
	28			
	29	iLSPOF	+ side limit switch (OFF edge)	
	30	iLSNOF	- side limit switch (OFF edge)	
	31	iDOGOF	Proximity dog (OFF edge)	

Note. OFF: No factor of event exists.

ON: A factor of event exists.

9. INTERFACE MODE

9.9 Servo off

When axes are moved by an external force during servo off, perform a follow up (refer to the formula below) that updates the position command to align with the movement (feedback position).

⚠ CAUTION

- If a follow up is not performed, the servo amplifiers will align the current command position with the position command at servo on, and the motors may operate at a very high speed.

Position command	= Feedback position
Machinery command position	= Position command – Home position offset

Coordinate return processing such as home position return after servo off are not necessary. If servo off is performed during axis operation, a free-run state occurs which is very dangerous. Be sure to servo off after stopping operation.

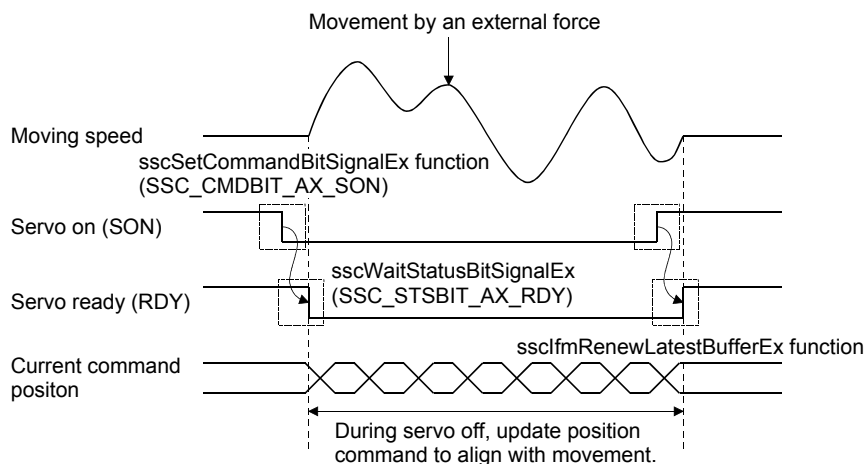

POINT

- After updating the position command to match the current feedback position, do not servo on until the transmit position command buffer number is the same as the latest position command buffer number.
- When the command data update cycle (control cycle × 2 or more) is set, the time of the command data update cycle set to the Q173SCCF follow up applies. When the command data update cycle is set, make sure servo on is performed at the next command data update or later.

9. INTERFACE MODE

9.10 Home position return

When startup is performed in interface mode, the operational function home position return cannot be used. Therefore, for an absolute position detection system, use the following method to perform a home position return. For an incremental system, home position set is not necessary. (The position at power supply ON is treated as 0).

- 1) Update the position command buffer and move to the home position.
- 2) Check that the in-position signal (INP) is on.
- 3) Turn ON the home position set command (ZSC).
- 4) Check that home position set complete (ZSF) turns ON.
- 5) Read the home position multiple revolution data (parameter 024D), and home position within 1 revolution position (parameter 024E, 024F), and save to the user program.
- 6) The next time power supply is ON, set the parameters read in 5)
- 7) The Q173SCCF will restore the absolute position based on the parameters above.

When home position return is performed by this function, coordinate systems such as the current command position and current feedback position are in the same state before home position return and do not change until the power supply is turned OFF/ON again. Therefore after home position return, perform a home position offset for position commands at home position return as shown in the formula below.

$$\text{Position command} = \text{Machinery command position} + \text{Home position offset}$$

- Position command : Position provided to the Q173SCCF. (pulse)
- Machinery command position : The actual position to move the machine to. (pulse)
- Home position offset : The difference between machinery command position and position command. (pulse)

When the home position coordinates are set by parameters, the absolute position is restored so that the place of set home position is the same as the home position coordinates.

When the home position set command turns on during in-position signal (INP) off, home position set error (ZSE) turns on, and home position return is not completed.

Also, when position command exceeds 32 bit or motor exceeds ± 32767 revolutions when moving from the home position in an absolute position detection system, the current command position cannot be normally restored at power supply on. Use absolute position detection system within ± 32767 revolutions and with position commands within 32 bit.

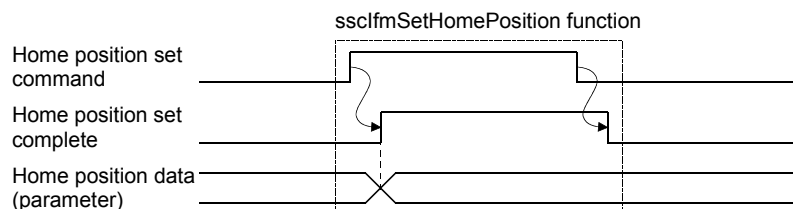

9. INTERFACE MODE

(1) Axis data command/status bit

Command bit

Address	Bit	Symbol	Signal name	When in auxiliary drive
100A	0		Reserved	
	1			
	2			
	3			
	4	ZSC	Home position set command	
	5		Reserved	
	6			
	7			

Status Bit

Address	Bit	Symbol	Signal name	When in auxiliary drive
0451	0		Reserved	
	1			
	2			
	3			
	4	ZSF	Home position set complete	
	5	ZSE	Home position set error	
	6		Reserved	
	7			

Note. The addresses above are the addresses for the first axis. For the second axis and after, increase by C0h for each axis.

(a) Details on command bit

Abbreviation	Signal name	Function details
ZSC	Home position set command	<p>[Function] Commands home position set.</p> <p>[Operation] When home position set command (ZSC) is turned on, the current position is set as home position. This is used when absolute position detection system is valid.</p>

(b) Details on status bit

Abbreviation	Signal name	Function details
ZSF	Home position set complete	<p>[Function] Notifies the home position set is complete.</p> <p>[Operation] <Conditions for turning on> • Home position set is completed. <Conditions for turning off> • Home position set command (ZSC) is turned off.</p>
ZSE	Home position set error	<p>[Function] Notifies the home position set failed.</p> <p>[Operation] <Conditions for turning on> • During an operation alarm. • During servo off (including servo alarm). • During test mode. • In-position signal is off. <Conditions for turning off> • Home position set command (ZSC) is turned off.</p>

9. INTERFACE MODE

9.11 Coordinate management

This section shows an example of how to approach coordination management.

9.11.1 Incremental system

When using servo amplifiers with incremental system setting, the current command position (position command) when SSCNET connection is restored is 0. Afterwards, a coordinate system value for a position of 0 when the SSCNET is connected needs to be used for the position command that the user program applies to Q173SCCF until connecting to SSCNET again. In many cases, the actual home position of the machine and the home position of the position command (position when SSCNET is connected) are different, therefore, the position command is calculated using the machinery command position and home position offset with the following formula.

$$\text{Position command} = \text{Machinery command position} + \text{Home position offset}$$

(1) When connected to SSCNET

Because the current command position (position command) when SSCNET connection is restored is 0, set home position offset to 0.

Until home position is determined, machinery command position is undefined. Use the position that is referred to when connected to SSCNET (=0) as the machinery command position.

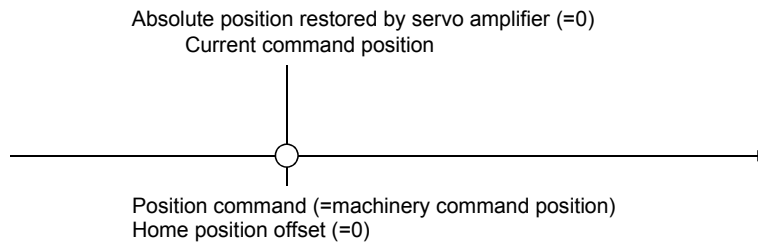

(2) Home position return

When home position return is required, move to home position on the user program side. The home position of the position command (distance from position when connected to SSCNET to home position) is the home position offset after home position return.

In an incremental system, home position set for Q173SCCF is not required.

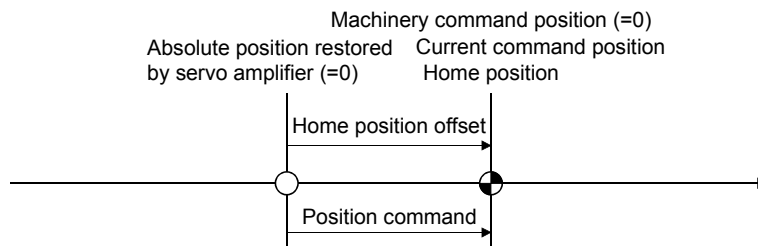

9. INTERFACE MODE

(3) After home position return

Calculate the position command (=machinery command position + home position offset) by using the home position offset determined at home position return.

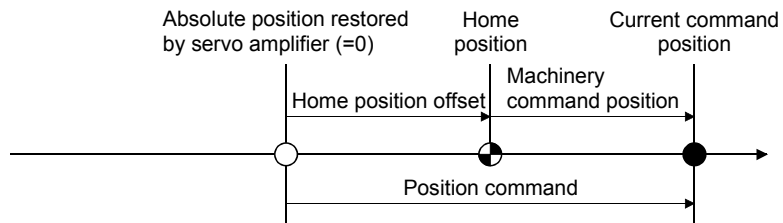

9. INTERFACE MODE

9.11.2 Absolute position system

When using servo amplifiers with absolute position system setting, the absolute position restored when connected to SSCNET is a position calculated from the "home position coordinates", "home position within 1 revolution", and "home position multiple revolution data" set to the parameters. Afterwards, a coordinate system value for when the SSCNET is connected needs to be used for the position command that the user program applies to Q173SCCF until connecting to SSCNET again.

Similar to an incremental system, the coordinate system does not change after home position return operation (after home position set). As a result, the actual home position of the machine and the home position of the position command (position when SSCNET is connected) is different, therefore, the position command is calculated using the machinery command position and home position offset with the following formula.

$$\text{Position command} = \text{Machinery command position} + \text{Home position offset}$$

(1) When connected to SSCNET (home position is not determined)

Because the current command position (position command) when SSCNET connection is restored is 0, set home position offset to 0.

Until home position is determined, machinery command position is undefined. Use the position that is referred to when connected to SSCNET (=0) as the machinery command position.

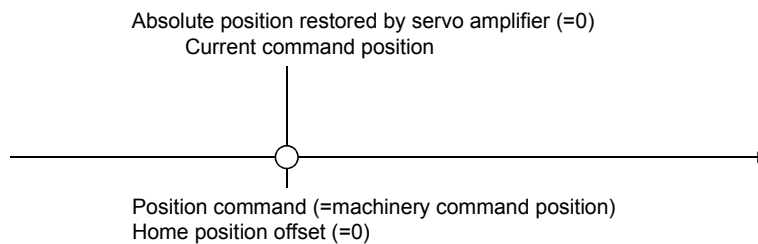

(2) Home position return

Move to home position on the user program side, execute home position set, and determine the home position. The home position of the position command (distance from position when connected to SSCNET to home position) is the home position offset after home position return.

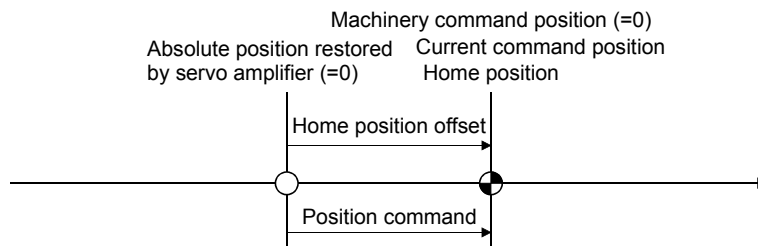

9. INTERFACE MODE

(3) After home position return

Q173SCCF also operates with the same coordinate system as when connected to SSCNET after home position return. As a result, the machinery command position and position command deviate by the difference between the new coordinate system and the coordinate system when connected to SSCNET. Set the amount of deviation to the home position offset.

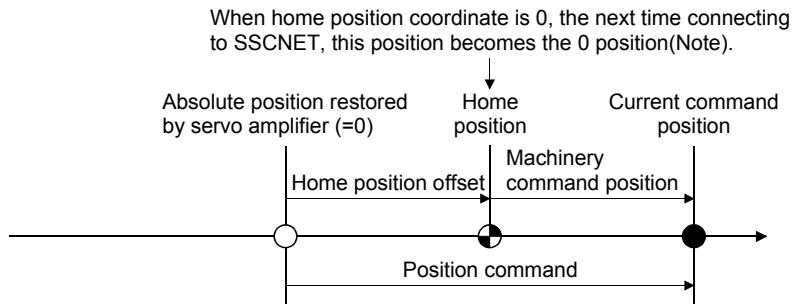

Note. 0 position is the position in the coordinate system where machinery command position is 0 when restoring absolute position, or after home position return. (When the home position coordinate is 0, this is the position after performing home position return)

Except for when home position coordinate is 0, the formula for calculating home position offset is as follows.

$$\text{Home position offset} = \text{Position command at home position return} - \text{Home position coordinate}$$

(4) After restoring absolute position

After restoring the home position, the machinery command position and position command are equivalent, thus set home position offset to 0.

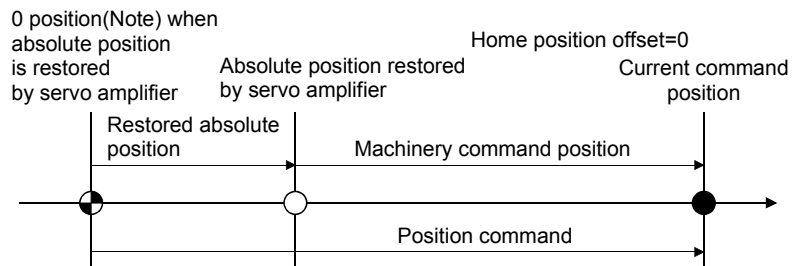

Note. 0 position is the position in the coordinate system where machinery command position is 0 when restoring absolute position, or after home position return. (When the home position coordinate is 0, this is the position after performing home position return)

9. INTERFACE MODE

9.12 Precautions

When performing interface mode the following precautions apply.

- (1) For the setting value of the position command buffer, ensure that the difference between the previous command value and the current command value is no more than 20000000. When the difference between the previous command value and the current command value exceeds 20000000, command data error (operation alarm A7, detail No.03) occurs, followed by an immediate stop.
- (2) If a value outside of the range is input to the speed command buffer, command data error (operation alarm A7, detail No.01) occurs. The speed command value becomes 0[0.01r/min], followed by an immediate stop.
- (3) If a value outside of the range is input to the torque command buffer, command data error (operation alarm A7, detail No.02) occurs. The torque command value becomes the value before the change.

10. TABLE MAP

10. TABLE MAP

10.1 Table list

POINT
<ul style="list-style-type: none"> Do not write to reserved areas. The first number in the point table for each axis can be designated using point number offset.

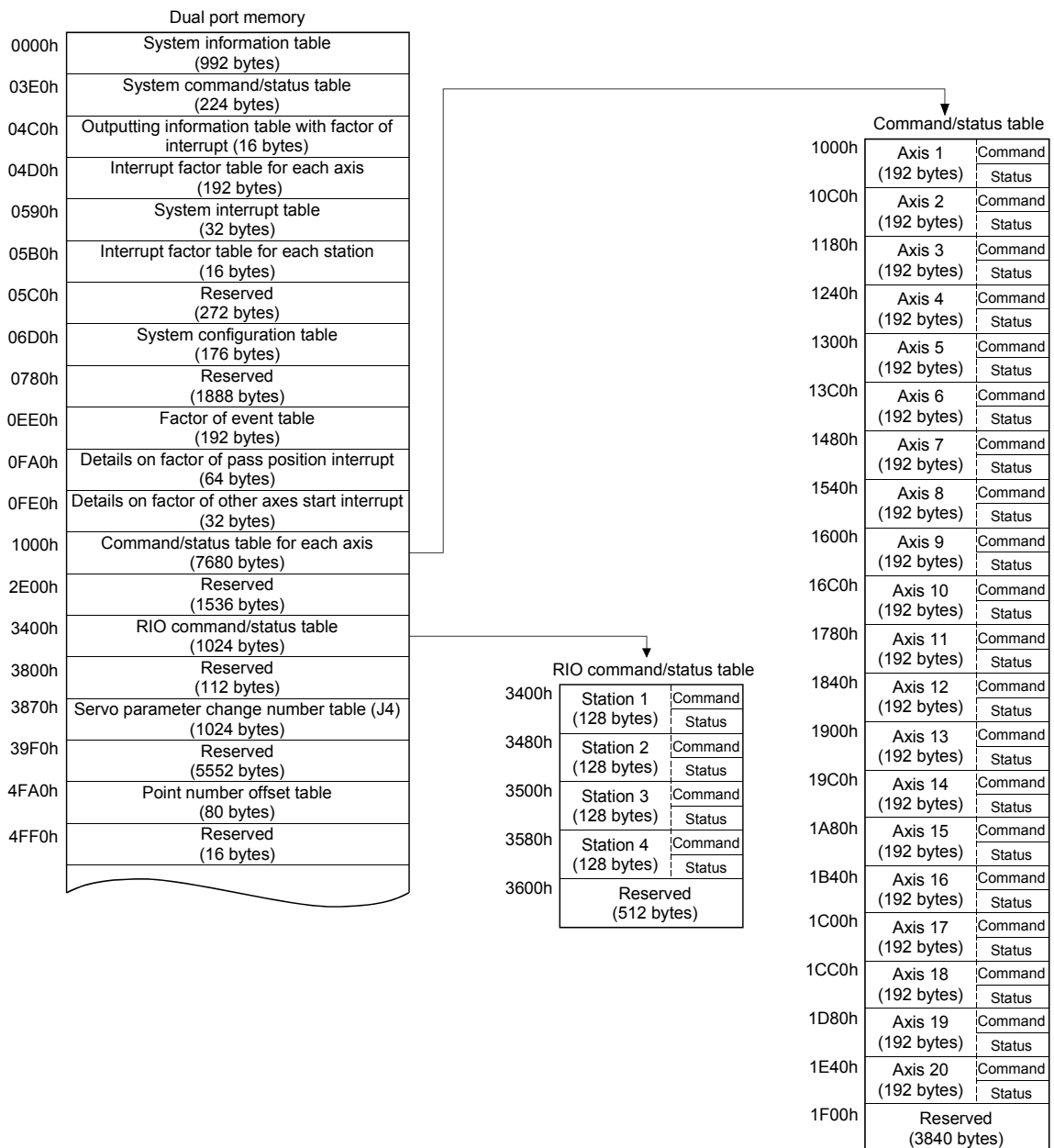

10. TABLE MAP

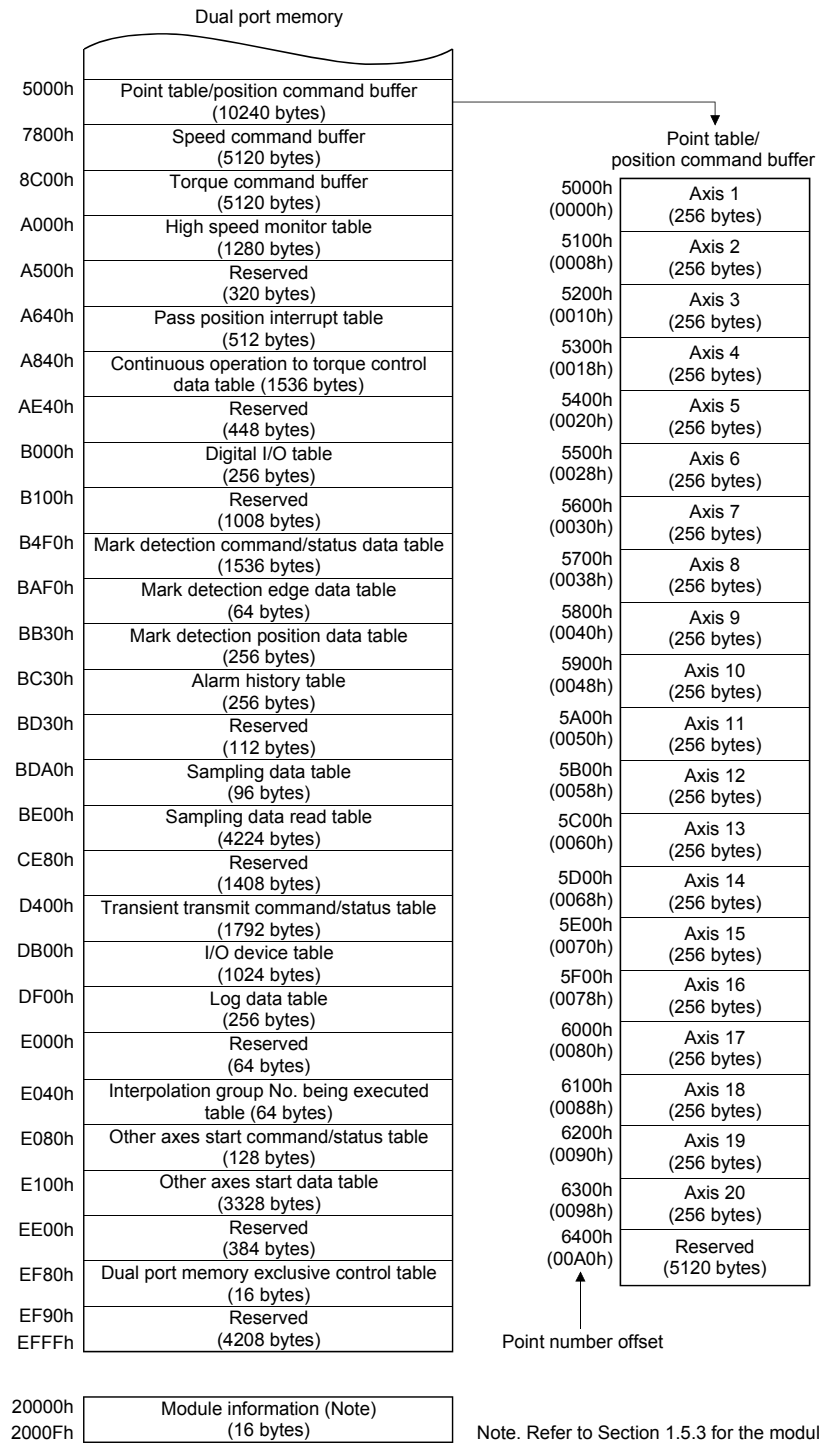

10. TABLE MAP

10.2 System information

Address	Content	
0000	CH number	1: 1CH
0001		
0002	Number of lines	1: Line 1
0003		
0004	Control cycle status	0001h: 0.88ms
0005		0002h: 0.44ms
0006		0003h: 0.22ms
0007	Reserved	
0008	SSCNET communication method	0: Not connected
0009		2: SSCNET III/H
000A	Reserved	
000B		
000C		
000D		
000E		
000F		
0010		
0011		
0012		
0013		
0014	Operation cycle current time	
0015		
0016	Operation cycle maximum time	
0017		
0018	Operation cycle over time	
0019		
001A	Reserved	
001B		
001C	Reserved	
001D		
001E		
001F		
0020		
0021		
0022		
0023		
0024		
0025		
0026		
0027		
0028		
0029		
002A		
002B		
002C		
002D		
002E		
002F		

Address	Content
0030	System program software version
0031	
0032	
0033	
0034	
0035	
0036	
0037	
0038	
0039	
003A	Reserved
003B	
003C	
003D	
003E	
003F	
0040	
0041	
0042	
0043	
0044	
0045	
0046	
0047	
0048	
0049	
004A	
004B	
004C	
004D	
004E	
004F	
0050	
0051	
0052	
0053	
0054	
0055	
0056	
0057	
0058	
0059	
005A	
005B	
005C	
005D	
005E	
005F	

10. TABLE MAP

Address	Content
0060	Servo amplifier software version (Axis 1)
0061	
0062	
0063	
0064	
0065	
0066	
0067	
0068	
0069	
006A	
006B	
006C	
006D	
006E	
006F	
0070	Servo amplifier software version (Axis 2)
:	
007F	
0080	Servo amplifier software version (Axis 3)
:	
008F	
0090	Servo amplifier software version (Axis 4)
:	
009F	
00A0	Servo amplifier software version (Axis 5)
:	
00AF	
00B0	Servo amplifier software version (Axis 6)
:	
00BF	
00C0	Servo amplifier software version (Axis 7)
:	
00CF	
00D0	Servo amplifier software version (Axis 8)
:	
00DF	
00E0	Servo amplifier software version (Axis 9)
:	
00EF	

Address	Content
00F0	Servo amplifier software version (Axis 10)
:	
00FF	
0100	Servo amplifier software version (Axis 11)
:	
010F	
0110	Servo amplifier software version (Axis 12)
:	
011F	
0120	Servo amplifier software version (Axis 13)
:	
012F	
0130	Servo amplifier software version (Axis 14)
:	
013F	
0140	Servo amplifier software version (Axis 15)
:	
014F	
0150	Servo amplifier software version (Axis 16)
:	
015F	
0160	Servo amplifier software version (Axis 17)
:	
016F	
0170	Servo amplifier software version (Axis 18)
:	
017F	
0180	Servo amplifier software version (Axis 19)
:	
018F	
0190	Servo amplifier software version (Axis 20)
:	
019F	
01A0	Reserved
:	
03DF	

10. TABLE MAP

10.3 System command/status table

(1) System commands

Address	Content
03E0	Command bit
03E1	
03E2	
03E3	
03E4	
03E5	
03E6	
03E7	
03E8	
03E9	
03EA	
03EB	
03EC	
03ED	
03EE	
03EF	
03F0	
03F1	
03F2	
03F3	
03F4	
03F5	
03F6	
03F7	
03F8	
03F9	
03FA	
03FB	
03FC	
03FD	
03FE	
03FF	
0400	System command code
0401	
0402	Watchdog check counter
0403	
0404	Watchdog timer start counter
0405	
0406	Reboot ID
0407	
0408	Flash ROM transfer ID
0409	(Flash ROM initialization ID)
040A	Reserved
040B	
040C	
040D	
040E	
040F	

Address	Content
0410	Monitor number 1
0411	
0412	Monitor number 2
0413	
0414	Reserved
0415	
0416	
0417	
0418	Parameter write number 1
0419	
041A	Parameter write data 1
041B	
041C	Parameter write number 2
041D	
041E	Parameter write data 2
041F	
0420	Parameter read number 1
0421	
0422	Reserved
0423	
0424	Parameter read number 2
0425	
0426	Reserved
0427	
0428	Log data read page number
0429	
042A	Reserved
042B	
042C	
042D	
042E	
042F	
0430	
0431	
0432	
0433	Disconnection axis No.
0434	
0435	Reserved
0436	
0437	
0438	
:	
0442	
0443	
0444	Alarm history read page number
0445	
0446	Alarm history initialization ID
0447	

10. TABLE MAP

Address	Content
0448	System startup time
0449	
044A	
044B	
044C	
044D	
044E	
044F	

(a) System command code

System command code	Content
0000	Initial value
0003	Parameter initialization
0004	Flash ROM parameter reading
000A	Start system startup

(b) Reboot ID

Reboot ID	Remarks
1EA5	Set when rebooting software.

(c) Flash ROM transfer ID (Flash ROM initialization ID)

Flash ROM transfer ID (Flash ROM initialization ID)	Remarks
A51E	Set when transferring data to flash ROM.
A55A	Set when initializing flash ROM.

10. TABLE MAP

(2) System status

Address	Content
0450	Status bit
0451	
0452	
0453	
0454	
0455	
0456	
0457	
0458	
0459	
045A	
045B	
045C	
045D	
045E	
045F	
0460	
0461	
0462	
0463	
0464	
0465	
0466	
0467	
0468	
0469	
046A	
046B	
046C	
046D	
046E	
046F	
0470	System status code
0471	Watchdog time
0472	
0473	
0474	System alarm number
0475	
0476	Specific system alarm number
0477	
0478	Command buffer read error counter
0479	
047A	Reserved
047B	
047C	
047D	
047E	
047F	

Address	Content
0480	Monitor number 1
0481	
0482	Monitor number 2
0483	
0484	Monitor data 1
0485	
0486	Monitor data 2
0487	
0488	Parameter write number 1
0489	
048A	Parameter write data 1
048B	
048C	Parameter write number 2
048D	
048E	Parameter write data 2
048F	
0490	Parameter read number 1
0491	
0492	Parameter read data 1
0493	
0494	Parameter read number 2
0495	
0496	Parameter read data 2
0497	
0498	Log data read page number
0499	
049A	Number of valid log data events
049B	
049C	Reserved
049D	
049E	
049F	
04A0	
04A1	
04A2	
04A3	
04A4	Error code of reconnection/disconnection
04A5	
04A6	Reserved
:	
04B3	
04B4	Alarm history read page number
04B5	
04B6	Number of valid alarm history events
04B7	
04B8	Reserved
:	
04BF	

10. TABLE MAP

(a) System status code

System status code	Content
0000	During system preparation
0001	System preparation completion
0003	Parameter initialization completion
0004	Flash ROM parameter read completion
0005	Flash ROM parameter read error
0009	Waiting for SSCNET response
000A	During system running
000F	Rebooting
E□□□	System error

Note. Notification items when a system error (E□□□ to) occurs.

- Forced stop is executed for servo amplifier. However, depending on the system status, there are cases where forced stop is not executed.
- System errors (E400h to) are SSCNET communication errors. Confirm the status of the servo amplifiers as well as the SSCNETⅢ cable. For details, refer to Section 13.6.

(b) Error code of reconnection/disconnection

Error code of reconnection/disconnection	Content
0000	No error
0001	Disconnected axis specification error
0002	Reconnected axis No. duplication error
0003	Reconnected axis type code error
0004	Reconnection error during communication error
0006	Communication cycle error

10. TABLE MAP

(3) Command bit

For each bit, 0 stands for invalid and 1 stands for valid.

Address	Bit	Symbol	Signal name
03E0	0	ITE	Interrupt processing complete
	1	ITS	Interrupt output valid
	2		Reserved
	3		
	4	HMA	During user program memory access
	5		Reserved
	6		
	7		

Address	Bit	Symbol	Signal name
03E1	0	SMPS	Sampling start
	1		Reserved
	2		
	3		
	4		
	5		
	6		
	7		

Address	Bit	Symbol	Signal name
03E2	0	SEMI	Software forced stop (Note)
	1		Reserved
	2		
	3		
	4		
	5		
	6		
	7		

Address	Bit	Symbol	Signal name
03E3	0		Reserved
	1		
	2		
	3		
	4		
	5		
	6		
	7		

Address	Bit	Symbol	Signal name
03E4	0	ITFE	Interrupt processing high speed complete
	1		Reserved
	2		
	3		
	4		
	5		
	6		
	7		

Address	Bit	Symbol	Signal name
03E5	0		Reserved
	1		
	2		
	3		
	4		
	5		
	6		
	7		

Address	Bit	Symbol	Signal name
03E6	0	ASYN1	Non-synchronous command (group 1)
	1	ASYN2	Non-synchronous command (group 2)
	2	ASYN3	Non-synchronous command (group 3)
	3	ASYN4	Non-synchronous command (group 4)
	4	ASYN5	Non-synchronous command (group 5)
	5	ASYN6	Non-synchronous command (group 6)
	6	ASYN7	Non-synchronous command (group 7)
	7	ASYN8	Non-synchronous command (group 8)

Address	Bit	Symbol	Signal name
03E7	0		Reserved
	1		
	2		
	3		
	4		
	5		
	6		
	7		

Note. Software forced stop is a normally-open contact (an external forced stop is a normally-closed contact). When the signal is turned on, the status becomes forced stop status. This is different than an external forced stop, in that it is performed through software processing.

10. TABLE MAP

Address	Bit	Symbol	Signal name
03E8	0	RBR	Reboot preparation
	1	RBS	Execution of reboot
	2	CRST	System alarm reset
	3		Reserved
	4	SMON	Monitor command
	5	SMONR	Monitor latch command
	6		Reserved
	7		

Address	Bit	Symbol	Signal name
03E9	0		Reserved
	1		
	2		
	3		
	4		
	5		
	6		
	7		

Address	Bit	Symbol	Signal name
03EA	0	LOGC	Log command
	1	LOGR	Reading of log data command
	2		Reserved
	3	LOGI	Log data initialization command
	4		Reserved
	5	OCMC	Operation cycle monitor clear
	6		Reserved
	7		

Address	Bit	Symbol	Signal name
03EB	0	RCC	Reconnection command
	1		Reserved
	2		
	3	CCC	Disconnection command
	4		Reserved
	5		
	6		
	7		

Address	Bit	Symbol	Signal name
03EC	0		Reserved
	1		
	2		
	3		
	4		
	5		
	6		
	7		

Address	Bit	Symbol	Signal name
03ED	0		Reserved
	1		
	2		
	3		
	4		
	5		
	6		
	7		

Address	Bit	Symbol	Signal name
03EE	0		Reserved
	1		
	2		
	3		
	4		
	5		
	6		
	7		

Address	Bit	Symbol	Signal name
03EF	0		Reserved
	1		
	2		
	3		
	4		
	5		
	6		
	7		

10. TABLE MAP

Address	Bit	Symbol	Signal name
03F0	0	SPWRT	Parameter write command
	1	Reserved	
	2		
	3		
	4		
	5		
	6		
	7		

Address	Bit	Symbol	Signal name
03F1	0	SPRD	Parameter read command
	1	Reserved	
	2		
	3		
	4		
	5		
	6		
	7		

Address	Bit	Symbol	Signal name
03F2	0	SMPSW	Sampling setting write command
	1	Reserved	
	2		
	3		
	4	SMPSR	Sampling setting read command
	5	Reserved	
	6		
	7		

Address	Bit	Symbol	Signal name
03F3	0	Reserved	
	1		
	2		
	3		
	4		
	5		
	6		
	7		

Address	Bit	Symbol	Signal name
03F4	0	Reserved	
	1		
	2		
	3		
	4		
	5		
	6		
	7		

Address	Bit	Symbol	Signal name
03F5	0	Reserved	
	1		
	2		
	3		
	4		
	5		
	6		
	7		

Address	Bit	Symbol	Signal name
03F6	0	FTR	Flash ROM transfer preparation
	1	FTS	Flash ROM transfer execution
	2	Reserved	
	3		
	4	FIR	Flash ROM initialization preparation
	5	FIS	Flash ROM initialization execution
	6	Reserved	
	7		

Address	Bit	Symbol	Signal name
03F7	0	ALHR	Alarm history read command
	1	Reserved	
	2		
	2	ALHI	Alarm history initialization command
	3	Reserved	
	4		
	5		
	6		
7			

10. TABLE MAP

Address	Bit	Symbol	Signal name
03F8	0		Reserved
	1		
	2		
	3		
	4		
	5		
	6		
	7		

Address	Bit	Symbol	Signal name
03F9	0		Reserved
	1		
	2		
	3		
	4		
	5		
	6		
	7		

Address	Bit	Symbol	Signal name
03FA	0		Reserved
	1		
	2		
	3		
	4		
	5		
	6		
	7		

Address	Bit	Symbol	Signal name
03FB	0		Reserved
	1		
	2		
	3		
	4		
	5		
	6		
	7		

Address	Bit	Symbol	Signal name
03FC	0		Reserved
	1		
	2		
	3		
	4		
	5		
	6		
	7		

Address	Bit	Symbol	Signal name
03FD	0		Reserved
	1		
	2		
	3		
	4		
	5		
	6		
	7		

Address	Bit	Symbol	Signal name
03FE	0		Reserved
	1		
	2		
	3		
	4		
	5		
	6		
	7		

Address	Bit	Symbol	Signal name
03FF	0		Reserved
	1		
	2		
	3		
	4		
	5		
	6		
	7		

10. TABLE MAP

(4) Status bit

For each bit, 0 stands for invalid and 1 stands for valid.

Address	Bit	Symbol	Signal name
0450	0	ITO	Outputting with factor of interrupt
	1	IITO	During interface mode interrupt valid
	2	EVDO	Event detection enabled
	3	HRIF	During highly response I/F valid
	4	BMA	During system program memory access
	5	PRINF	Continuous operation to torque control compatible information
	6		Reserved
	7	IFMO	In interface mode

Address	Bit	Symbol	Signal name
0451	0	SMPW	Waiting for sampling trigger
	1	SMPO	Sampling is being performed
	2	SMPF	Sampling is complete
	3	SMPE	Sampling error
	4		Reserved
	5	AHINF	Alarm history information
	6		Reserved
	7		Reserved

Address	Bit	Symbol	Signal name
0452	0	EMIO	During forced stop
	1		Reserved
	2	TSTO	In test mode (Note)
	3		Reserved
	4		Reserved
	5		Reserved
	6	EMID	External forced stop disabled
	7		Reserved

Address	Bit	Symbol	Signal name
0453	0		Reserved
	1		
	2		
	3		
	4		
	5		
	6	IPCH	Changeable interpolation group
	7		Reserved

Address	Bit	Symbol	Signal name
0454	0		Reserved
	1		
	2		
	3		
	4		
	5		
	6		
	7		

Address	Bit	Symbol	Signal name
0455	0		Reserved
	1		
	2		
	3		
	4		
	5		
	6		
	7		

Address	Bit	Symbol	Signal name
0456	0	ASYO1	In non-synchronous mode (group 1)
	1	ASYO2	In non-synchronous mode (group 2)
	2	ASYO3	In non-synchronous mode (group 3)
	3	ASYO4	In non-synchronous mode (group 4)
	4	ASYO5	In non-synchronous mode (group 5)
	5	ASYO6	In non-synchronous mode (group 6)
	6	ASYO7	In non-synchronous mode (group 7)
	7	ASYO8	In non-synchronous mode (group 8)

Address	Bit	Symbol	Signal name
0457	0	SYEO1	Synchronizing (group 1)
	1	SYEO2	Synchronizing (group 2)
	2	SYEO3	Synchronizing (group 3)
	3	SYEO4	Synchronizing (group 4)
	4	SYEO5	Synchronizing (group 5)
	5	SYEO6	Synchronizing (group 6)
	6	SYEO7	Synchronizing (group 7)
	7	SYEO8	Synchronizing (group 8)

Note. If test mode is selected from MR Configurator2, status becomes test mode in operation (TSTO). The following items concerning control exist during test mode.

- Operation from the Q173SCCF (such as automatic operation) can not be performed.
- In order to perform operations using the Q173SCCF, the system must be restarted.

10. TABLE MAP

Address	Bit	Symbol	Signal name
0458	0	RBOK	Reboot preparation complete
	1	RBNG	Reboot preparation error
	2	CALM	Current system alarm
	3		Reserved
	4	SMOUT	Monitor output
	5	SMRCH	Monitor latch
	6	SMER1	Monitor number error 1
	7	SMER2	Monitor number error 2

Address	Bit	Symbol	Signal name
0459	0		Reserved
	1		
	2		
	3		
	4		
	5		
	6		
	7		

Address	Bit	Symbol	Signal name
045A	0	LOGO	Log operation being performed
	1	LOGRF	Reading of log data complete
	2	LOGRE	Reading of log data error
	3	LOGIF	Log data initialization is complete
	4	LOGIE	Log data initialization error
	5	OCMCO	Operation cycle monitor clear
	6	OCME	Operation cycle alarm
	7	OCMW	Operation cycle warning

Address	Bit	Symbol	Signal name
045B	0	RCO	During reconnection processing
	1	RCF	Reconnection complete
	2	RCE	Reconnection error
	3	CCO	During disconnection processing
	4	CCF	Disconnection complete
	5	CCE	Disconnection error
	6		Reserved
	7		

Address	Bit	Symbol	Signal name
045C	0		Reserved
	1		
	2		
	3		
	4		
	5		
	6		
	7		

Address	Bit	Symbol	Signal name
045D	0		Reserved
	1		
	2		
	3		
	4		
	5		
	6		
	7		

Address	Bit	Symbol	Signal name
045E	0		Reserved
	1		
	2		
	3		
	4		
	5		
	6		
	7		

Address	Bit	Symbol	Signal name
045F	0		Reserved
	1		
	2		
	3		
	4		
	5		
	6		
	7		

10. TABLE MAP

Address	Bit	Symbol	Signal name
0460	0	SPWFIN1	Parameter write complete 1
	1	SPWEN1	Parameter number error 1
	2	SPWED1	Parameter data out of bounds 1
	3		Reserved
	4	SPWFIN2	Parameter write complete 2
	5	SPWEN2	Parameter number error 2
	6	SPWED2	Parameter data out of bounds 2
	7		Reserved

Address	Bit	Symbol	Signal name
0461	0	SPRFIN1	Parameter read complete 1
	1	SPREN1	Parameter number error 1
	2	SPRFIN2	Parameter read complete 2
	3	SPREN2	Parameter number error 2
	4		Reserved
	5		
	6		
	7		

Address	Bit	Symbol	Signal name
0462	0	SWFIN	Sampling setting write complete
	1	SWEN	Sampling setting number error
	2	SWED	Sampling setting data out of bounds
	3		Reserved
	4	SRFIN	Sampling setting read complete
	5	SREN	Sampling setting number error
	6		Reserved
	7		

Address	Bit	Symbol	Signal name
0463	0		Reserved
	1		
	2		
	3		
	4		
	5		
	6		
	7		

Address	Bit	Symbol	Signal name
0464	0		Reserved
	1		
	2		
	3		
	4		
	5		
	6		
	7		

Address	Bit	Symbol	Signal name
0465	0		Reserved
	1		
	2		
	3		
	4		
	5		
	6		
	7		

Address	Bit	Symbol	Signal name
0466	0	FROK	Flash ROM transfer preparation complete
	1	FRNG	Flash ROM transfer preparation error
	2	FSOK	Flash ROM transfer complete
	3	FSNG	Flash ROM transfer error
	4	FIROK	Flash ROM initialization preparation complete
	5	FIRNG	Flash ROM initialization preparation error
	6	FIOK	Flash ROM initialization complete
	7	FING	Flash ROM initialization error

Address	Bit	Symbol	Signal name
0467	0	ALHRF	Alarm history read complete
	1	ALHRE	Alarm history read error
	2	ALHIF	Alarm history initialization complete
	3	ALHIE	Alarm history initialization error
	4		Reserved
	5		
	6		
	7		

10. TABLE MAP

Address	Bit	Symbol	Signal name
0468	0		Reserved
	1		
	2		
	3		
	4		
	5		
	6		
	7		

Address	Bit	Symbol	Signal name
0469	0		Reserved
	1		
	2		
	3		
	4		
	5		
	6		
	7		

Address	Bit	Symbol	Signal name
046A	0		Reserved
	1		
	2		
	3		
	4		
	5		
	6		
	7		

Address	Bit	Symbol	Signal name
046B	0		Reserved
	1		
	2		
	3		
	4		
	5		
	6		
	7		

Address	Bit	Symbol	Signal name
046C	0		Reserved
	1		
	2		
	3		
	4		
	5		
	6		
	7		

Address	Bit	Symbol	Signal name
046D	0		Reserved
	1		
	2		
	3		
	4		
	5		
	6		
	7		

Address	Bit	Symbol	Signal name
046E	0		Reserved
	1		
	2		
	3		
	4		
	5		
	6		
	7		

Address	Bit	Symbol	Signal name
046F	0		Reserved
	1		
	2		
	3		
	4		
	5		
	6		
	7		

10. TABLE MAP

10.4 Factor of interrupt

(1) Information of outputting with factor of interrupt

When an interrupt occurs, the bit corresponding to the axis No. or system which is the factor of the interrupt turns on.

Address	Content	Remarks
04C0	Outputting with factor of axis interrupt 1	Axis 1 (bit 0) to axis 20 (bit 19)
04C1		
04C2		
04C3		
04C4	Reserved	
04C5		
04C6		
04C7		
04C8	Outputting with factor of station interrupt	Station 1 (bit0) to station 4 (bit3)
04C9	Reserved	
04CA	Outputting with factor of system interrupt	System (bit 0)
04CB	Reserved	
04CC		
04CD		
04CE		
04CF		

10. TABLE MAP

(2) Factor of axis interrupt

(a) Factor of axis interrupt

Address	Content
04D0	Factor of interrupt Axis 1
04D1	
04D2	
04D3	
04D4	Factor of interrupt Axis 2
04D5	
04D6	
04D7	
04D8	Factor of interrupt Axis 3
04D9	
04DA	
04DB	
04DC	Factor of interrupt Axis 4
04DD	
04DE	
04DF	
04E0	Factor of interrupt Axis 5
04E1	
04E2	
04E3	
04E4	Factor of interrupt Axis 6
04E5	
04E6	
04E7	
04E8	Factor of interrupt Axis 7
04E9	
04EA	
04EB	
04EC	Factor of interrupt Axis 8
04ED	
04EE	
04EF	
04F0	Factor of interrupt Axis 9
04F1	
04F2	
04F3	
04F4	Factor of interrupt Axis 10
04F5	
04F6	
04F7	
04F8	Factor of interrupt Axis 11
04F9	
04FA	
04FB	
04FC	Factor of interrupt Axis 12
04FD	
04FE	
04FF	

Address	Content
0500	Factor of interrupt Axis 13
0501	
0502	
0503	
0504	Factor of interrupt Axis 14
0505	
0506	
0507	
0508	Factor of interrupt Axis 15
0509	
050A	
050B	
050C	Factor of interrupt Axis 16
050D	
050E	
050F	
0510	Factor of interrupt Axis 17
0511	
0512	
0513	
0514	Factor of interrupt Axis 18
0515	
0516	
0517	
0518	Factor of interrupt Axis 19
0519	
051A	
051B	
051C	Factor of interrupt Axis 20
051D	
051E	
051F	
0520	Reserved
:	
058F	

10. TABLE MAP

(b) Details on factor of interrupt on axis n

The addresses in the table are the addresses for the axis 1. For the axis 2 and above, add +04h for each axis.

Address	Bit	Symbol	Signal name
04D0 to 04D3	0	iRDY	Servo ready (interrupt)
	1	iINP	In-position (interrupt)
	2	iZSP	Zero speed (interrupt)
	3	iZPAS	Passed Z-phase (interrupt)
	4	iTLC	Torque limit effective (interrupt)
	5	iSALM	Servo alarm (interrupt)
	6	iSWRN	Servo warning (interrupt)
	7	iABSE	Absolute position erased (interrupt)
	8	iOP	During operation (interrupt)
	9	iCPO	Rough match (interrupt)
	10	iPF	Positioning complete (interrupt)
	11	iZP	Home position return complete (interrupt)
	12	iSMZ	During smoothing of stopping (interrupt)
	13	iOALM	Operation alarm (interrupt)
	14	iOPF	Completion of operation (interrupt)
	15	iPSW	Position switch (interrupt)
	16	iGAINO	During gain switching (interrupt)
	17	iFCLSO	Fully closed loop control changing (interrupt)
	18	iTLSO	Selecting torque limit (interrupt)
	19	iSPC	During PID control (interrupt)
	20		Reserved
	21	iMAK1	Mark detection 1 (interrupt)
	22	iMAK2	Mark detection 2 (interrupt)
	23	iPRSMO	During continuous operation to torque control (interrupt)
	24	iIWT	Interference check standby (interrupt)
	25	iSINP	Servo amplifier in-position (interrupt)
26		Reserved	
27			
28			
29			
30			
31			

Note. OFF: No factor of interrupt exists.

ON: A factor of interrupt exists.

10. TABLE MAP

(3) System interrupt factors

(a) System interrupt factors

Address	Content
0590	System interrupt factors
0591	
0592	Reserved
0593	
0594	Factor of other axes start interrupt
0595	
0596	
0597	
0598	Factor of pass position interrupt
0599	
059A	
059B	
059C	
059D	
059E	
059F	Reserved
05A0	
:	
05AF	

(b) Details on factor of system interrupt

Address	Bit	(Note) Symbol	Signal name
0590 to 0591	0	iSYSE	System error (interrupt)
	1	iCALM	System alarm (interrupt)
	2	iEMIO	During forced stop (interrupt)
	3		Reserved
	4		
	5		
	6		
	7	iOCME	Operation cycle alarm (interrupt)
	8	iOASF	Outputting with factor of other axes start interrupt (interrupt)
	9	iPPI	Outputting with factor of pass position interrupt (interrupt)
	10		Reserved
	11		
	12		
	13		
	14		
	15		

Note. OFF: No factor of interrupt exists.

ON: A factor of interrupt exists.

10. TABLE MAP

(c) Factor of other axes start interrupt

When the outputting with factor of other axes start interrupt (iOASF) is on, the bit corresponding to other axes start data No. (1 to 32) turns on.

Address	Bit	Symbol	Signal name
0594 to 0597	0	iOAS1	Other axes start data 1 (interrupt)
	1	iOAS2	Other axes start data 2 (interrupt)
	2	iOAS3	Other axes start data 3 (interrupt)
	3	iOAS4	Other axes start data 4 (interrupt)
	4	iOAS5	Other axes start data 5 (interrupt)
	5	iOAS6	Other axes start data 6 (interrupt)
	6	iOAS7	Other axes start data 7 (interrupt)
	7	iOAS8	Other axes start data 8 (interrupt)
	8	iOAS9	Other axes start data 9 (interrupt)
	9	iOAS10	Other axes start data 10 (interrupt)
	10	iOAS11	Other axes start data 11 (interrupt)
	11	iOAS12	Other axes start data 12 (interrupt)
	12	iOAS13	Other axes start data 13 (interrupt)
	13	iOAS14	Other axes start data 14 (interrupt)
	14	iOAS15	Other axes start data 15 (interrupt)
	15	iOAS16	Other axes start data 16 (interrupt)
	16	iOAS17	Other axes start data 17 (interrupt)
	17	iOAS18	Other axes start data 18 (interrupt)
	18	iOAS19	Other axes start data 19 (interrupt)
	19	iOAS20	Other axes start data 20 (interrupt)
	20	iOAS21	Other axes start data 21 (interrupt)
	21	iOAS22	Other axes start data 22 (interrupt)
	22	iOAS23	Other axes start data 23 (interrupt)
	23	iOAS24	Other axes start data 24 (interrupt)
	24	iOAS25	Other axes start data 25 (interrupt)
	25	iOAS26	Other axes start data 26 (interrupt)
	26	iOAS27	Other axes start data 27 (interrupt)
	27	iOAS28	Other axes start data 28 (interrupt)
	28	iOAS29	Other axes start data 29 (interrupt)
	29	iOAS30	Other axes start data 30 (interrupt)
	30	iOAS31	Other axes start data 31 (interrupt)
	31	iOAS32	Other axes start data 32 (interrupt)

10. TABLE MAP

(d) Details on factor of other axes start interrupt

When the factor of other axes start interrupt (iOAS□) is on, the interrupt factor of other axes start status bit corresponding to other axes start data No. (1 to 32) turns on.

Details on factor of other axes start interrupt

Address	Content
0FE0	Details on factor of other axes start interrupt 1
0FE1	Details on factor of other axes start interrupt 2
0FE2	Details on factor of other axes start interrupt 3
0FE3	Details on factor of other axes start interrupt 4
0FE4	Details on factor of other axes start interrupt 5
0FE5	Details on factor of other axes start interrupt 6
0FE6	Details on factor of other axes start interrupt 7
0FE7	Details on factor of other axes start interrupt 8
0FE8	Details on factor of other axes start interrupt 9
0FE9	Details on factor of other axes start interrupt 10
0FEA	Details on factor of other axes start interrupt 11
0FEB	Details on factor of other axes start interrupt 12
0FEC	Details on factor of other axes start interrupt 13
0FED	Details on factor of other axes start interrupt 14
0FEE	Details on factor of other axes start interrupt 15
0FEF	Details on factor of other axes start interrupt 16

Address	Content
0FF0	Details on factor of other axes start interrupt 17
0FF1	Details on factor of other axes start interrupt 18
0FF2	Details on factor of other axes start interrupt 19
0FF3	Details on factor of other axes start interrupt 20
0FF4	Details on factor of other axes start interrupt 21
0FF5	Details on factor of other axes start interrupt 22
0FF6	Details on factor of other axes start interrupt 23
0FF7	Details on factor of other axes start interrupt 24
0FF8	Details on factor of other axes start interrupt 25
0FF9	Details on factor of other axes start interrupt 26
0FFA	Details on factor of other axes start interrupt 27
0FFB	Details on factor of other axes start interrupt 28
0FFC	Details on factor of other axes start interrupt 29
0FFD	Details on factor of other axes start interrupt 30
0FFE	Details on factor of other axes start interrupt 31
0FFF	Details on factor of other axes start interrupt 32

Details on factor of other axes start interrupt□

Address	Bit	Abbreviation	Signal name
0FE0	0	iOSOP□	Other axes start notice□ (interrupt)
	1	iOSFIN□	Other axes start complete□ (interrupt)
	2	iOSERR□	Other axes start incomplete□ (interrupt)
	3	\	Reserved
	4		
	5		
	6		
7			

Note 1. The addresses in the table above are the addresses for the other axes start status table 1. For the other axes status table 2 and above, increase in units of 1h for each axis.

2. □ : Other axes start No.

10. TABLE MAP

(e) Factor of pass position interrupt

When the outputting with factor of pass position interrupt (iPPI) is on, the bit corresponding to the pass position condition number of the factor of the pass position interrupt turns on.

Address	Bit	Abbreviation	Signal name
0598 to 059B	0	iPPI1	Pass position condition 1 (interrupt)
	1	iPPI2	Pass position condition 2 (interrupt)
	2	iPPI3	Pass position condition 3 (interrupt)
	3	iPPI4	Pass position condition 4 (interrupt)
	4	iPPI5	Pass position condition 5 (interrupt)
	5	iPPI6	Pass position condition 6 (interrupt)
	6	iPPI7	Pass position condition 7 (interrupt)
	7	iPPI8	Pass position condition 8 (interrupt)
	8	iPPI9	Pass position condition 9 (interrupt)
	9	iPPI10	Pass position condition 10 (interrupt)
	10	iPPI11	Pass position condition 11 (interrupt)
	11	iPPI12	Pass position condition 12 (interrupt)
	12	iPPI13	Pass position condition 13 (interrupt)
	13	iPPI14	Pass position condition 14 (interrupt)
	14	iPPI15	Pass position condition 15 (interrupt)
	15	iPPI16	Pass position condition 16 (interrupt)
	16	iPPI17	Pass position condition 17 (interrupt)
	17	iPPI18	Pass position condition 18 (interrupt)
	18	iPPI19	Pass position condition 19 (interrupt)
	19	iPPI20	Pass position condition 20 (interrupt)
	20	iPPI21	Pass position condition 21 (interrupt)
	21	iPPI22	Pass position condition 22 (interrupt)
	22	iPPI23	Pass position condition 23 (interrupt)
	23	iPPI24	Pass position condition 24 (interrupt)
	24	iPPI25	Pass position condition 25 (interrupt)
	25	iPPI26	Pass position condition 26 (interrupt)
	26	iPPI27	Pass position condition 27 (interrupt)
	27	iPPI28	Pass position condition 28 (interrupt)
	28	iPPI29	Pass position condition 29 (interrupt)
	29	iPPI30	Pass position condition 30 (interrupt)
	30	iPPI31	Pass position condition 31 (interrupt)
	31	iPPI32	Pass position condition 32 (interrupt)

Address	Bit	Abbreviation	Signal name
059C to 059F	0	iPPI33	Pass position condition 33 (interrupt)
	1	iPPI34	Pass position condition 34 (interrupt)
	2	iPPI35	Pass position condition 35 (interrupt)
	3	iPPI36	Pass position condition 36 (interrupt)
	4	iPPI37	Pass position condition 37 (interrupt)
	5	iPPI38	Pass position condition 38 (interrupt)
	6	iPPI39	Pass position condition 39 (interrupt)
	7	iPPI40	Pass position condition 40 (interrupt)
	8	iPPI41	Pass position condition 41 (interrupt)
	9	iPPI42	Pass position condition 42 (interrupt)
	10	iPPI43	Pass position condition 43 (interrupt)
	11	iPPI44	Pass position condition 44 (interrupt)
	12	iPPI45	Pass position condition 45 (interrupt)
	13	iPPI46	Pass position condition 46 (interrupt)
	14	iPPI47	Pass position condition 47 (interrupt)
	15	iPPI48	Pass position condition 48 (interrupt)
	16	iPPI49	Pass position condition 49 (interrupt)
	17	iPPI50	Pass position condition 50 (interrupt)
	18	iPPI51	Pass position condition 51 (interrupt)
	19	iPPI52	Pass position condition 52 (interrupt)
	20	iPPI53	Pass position condition 53 (interrupt)
	21	iPPI54	Pass position condition 54 (interrupt)
	22	iPPI55	Pass position condition 55 (interrupt)
	23	iPPI56	Pass position condition 56 (interrupt)
	24	iPPI57	Pass position condition 57 (interrupt)
	25	iPPI58	Pass position condition 58 (interrupt)
	26	iPPI59	Pass position condition 59 (interrupt)
	27	iPPI60	Pass position condition 60 (interrupt)
	28	iPPI61	Pass position condition 61 (interrupt)
	29	iPPI62	Pass position condition 62 (interrupt)
	30	iPPI63	Pass position condition 63 (interrupt)
	31	iPPI64	Pass position condition 64 (interrupt)

10. TABLE MAP

(f) Details on factor of pass position interrupt

When the outputting with factor of pass position interrupt (iPPI□) is on, the pass position status bit corresponding to the pass position condition number (1 to 64) turns on.

Address	Content	
0FA0	Details on factor of pass position interrupt (64 bytes)	Details on factor of pass position interrupt 1
0FA1		Details on factor of pass position interrupt 2
0FA2		Details on factor of pass position interrupt 3
0FA3		Details on factor of pass position interrupt 4
:		:
0FDF		Details on factor of pass position interrupt 64

Details on factor of pass position interrupt□

Address	Bit	Abbreviation	Signal name
0FA0	0	iPPIF□	Pass position interrupt complete□ (interrupt)
	1	iPPIE□	Pass position interrupt incomplete□ (interrupt)
	2	/	Reserved
	3		
	4		
	5		
	6		
	7		

Note 1. The address above is for the pass position condition number 1.

For the pass position condition number 2 and above, increase in units of 01h for each number.

2. □ indicates the pass position condition number (1 to 64).

10. TABLE MAP

(4) Station interrupt factors

(a) Station interrupt factors

Address	Content
05B0	Station interrupt factor station 1
05B1	
05B2	Station interrupt factor station 2
05B3	
05B4	Station interrupt factor station 3
05B5	
05B6	Station interrupt factor station 4
05B7	
05B8	Reserved
05B9	
05BA	
05BB	
05BC	
05BD	
05BE	
05BF	

(b) Details on station n interrupt factors

The addresses in the table are the addresses for the axis 1. For the axis 2 and above, increase in units of 02h for each axis.

Address	Bit	(Note) Abbreviation	Signal name		
05B0 to 05B1	0		Reserved		
	1				
	2				
	3				
	4				
	5	iRUALM	RIO module alarm (interrupt)		
	6	iRUWRN	RIO module warning (interrupt)		
	7		Reserved		
	8				
	9				
	10				
	11				
	12		Reserved		
	13			iRCALM	RIO control alarm (interrupt)
	14				Reserved
15					

Note. OFF: No factor of interrupt exists.

ON: A factor of interrupt exists.

10. TABLE MAP

10.5 Factor of event

(1) Factor of axis event

(a) Factor of axis event

Address	Content
0EE0	Factor of event Axis 1
0EE1	
0EE2	
0EE3	
0EE4	Factor of event Axis 2
0EE5	
0EE6	
0EE7	
0EE8	Factor of event Axis 3
0EE9	
0EEA	
0EEB	
0EEC	Factor of event Axis 4
0EED	
0EEE	
0EEF	
0EF0	Factor of event Axis 5
0EF1	
0EF2	
0EF3	
0EF4	Factor of event Axis 6
0EF5	
0EF6	
0EF7	
0EF8	Factor of event Axis 7
0EF9	
0EFA	
0EFB	
0EFC	Factor of event Axis 8
0EFD	
0EFE	
0EFF	
0F00	Factor of event Axis 9
0F01	
0F02	
0F03	
0F04	Factor of event Axis 10
0F05	
0F06	
0F07	
0F08	Factor of event Axis 11
0F09	
0F0A	
0F0B	

Address	Content
0F0C	Factor of event Axis 12
0F0D	
0F0E	
0F0F	
0F10	Factor of event Axis 13
0F11	
0F12	
0F13	
0F14	Factor of event Axis 14
0F15	
0F16	
0F17	
0F18	Factor of event Axis 15
0F19	
0F1A	
0F1B	
0F1C	Factor of event Axis 16
0F1D	
0F1E	
0F1F	
0F20	Factor of event Axis 17
0F21	
0F22	
0F23	
0F24	Factor of event Axis 18
0F25	
0F26	
0F27	
0F28	Factor of event Axis 19
0F29	
0F2A	
0F2B	
0F2C	Factor of event Axis 20
0F2D	
0F2E	
0F2F	
0F30	Reserved
0F31	
0F32	
:	
0F9D	
0F9E	
0F9F	

10. TABLE MAP

(b) Details on factor of event on axis n

The addresses in the table are the addresses for the axis 1. For the axis 2 and above, increase in units of 04h for each axis.

Address	Bit	(Note) Abbreviation	Signal name	
0EE0 to 0EE3	0	iRDYON	Servo ready (ON edge)	
	1	iINPON	In-position (ON edge)	
	2	iZSPON	Zero speed (ON edge)	
	3	iTLCON	Torque limit effective (ON edge)	
	4	iSALMON	Servo alarm (ON edge)	
	5	iSWRNON	Servo warning (ON edge)	
	6	iABSEON	Absolute position erased (ON edge)	
	7	iOALMON	Operation alarm (ON edge)	
	8	iMAK1ON	Mark detection 1 (ON edge)	
	9	iMAK2ON	Mark detection 2 (ON edge)	
	10	\		Reserved
	11			
	12			
	13	iLSPON	+ side limit switch (ON edge)	
	14	iLSNON	- side limit switch (ON edge)	
	15	iDOGON	Proximity dog (ON edge)	
	16	iRDYOF	Servo ready (OFF edge)	
	17	iINPOF	In-position (OFF edge)	
	18	iZSPOF	Zero speed (OFF edge)	
	19	iTLCOF	Torque limit effective (OFF edge)	
	20	iSALMOF	Servo alarm (OFF edge)	
	21	iSWRNOF	Servo warning (OFF edge)	
	22	iABSEOF	Absolute position erased (OFF edge)	
	23	iOALMOF	Operation alarm (OFF edge)	
	24	iMAK1OF	Mark detection 1 (OFF edge)	
	25	iMAK2OF	Mark detection 2 (OFF edge)	
	26	\		Reserved
	27			
	28			
	29	iLSPOF	+ side limit switch (OFF edge)	
	30	iLSNOF	- side limit switch (OFF edge)	
31	iDOGOF	Proximity dog (OFF edge)		

Note. OFF: No factor of event exists.

ON: A factor of event exists.

10. TABLE MAP

10.6 System configuration information table

(1) System configuration information table

Address	Content	Remarks
06D0	Reserved (16 bytes)	
06E0	Controlling axis information (lower) (4 bytes)	The bit corresponding to the axis which is currently controllable (SSCNET communicating axis or amplifier-less axis) turns on. The bit is the axis 1 (bit 0) to the axis 20 (bit 19).
06E4	Controlling axis information (upper) (4 bytes)	Fixed to 0.
06E8	Controlling station information (2 bytes)	The bit corresponding to the station which is currently controllable (SSCNET communicating station or the remote I/O disconnect station) turns on. The bit is the station 1 (bit 0) to the station 4 (bit3).
06EA	Reserved (142 bytes)	
0778	Time synchronization information (8 bytes)	Set the time when starting up system, or reconnecting. When the set value is 0, the time is 0000hrs on January 1st, 2000.

(a) Details on time synchronization information

Address	Content
0778	Year
0779	
077A	Month
007B	Date
077C	Hour
077D	Minute
077E	Seconds
077F	Day 0: Sunday 1: Monday 2: Tuesday 3: Wednesday 4: Thursday 5: Friday 6: Saturday

10. TABLE MAP

10.7 Axis data

10.7.1 Axis data command table

(1) Table list

The addresses in the table are the addresses for the axis 1. For the axis 2 and above, increase in units of C0 for each axis.

The column in the table for when tandem drive (synchronous) is being used is for axis data classification for when using tandem drive.

Master : The data only valid for the master axis (refer to Section 8.3)

Each axis: The data valid for both the master axis and slave axis (refer to Section 8.3)

Address	Content	Tandem drive when in (synchronous)	Address	Content	Tandem drive when in (synchronous)
1000	Command bit	Refer to (2) of this section	1020	Manual feed speed (Note)	Master
1001			1021		
1002			1022		
1003			1023		
1004			1024	Master	
1005			1025		Manual feed acceleration time constant
1006			1026	Master	
1007			1027		Manual feed deceleration time constant
1008			1028	Master	
1009			1029		Incremental feed movement amount
100A			102A		
100B			102B	Master	
100C			102C		Start point No.
100D			102D		
100E			102E	Master	
100F			102F		End point No.
1010			1030	Latest position command buffer number	
1011	1031				
1012	1032	Control mode command			
1013	1033				
1014	1034	Each axis			
1015	1035		Pass position condition start number		
1016	1036	Each axis			
1017	1037		Pass position condition end number		
1018	1038	Reserved			
1019	1039				
101A	103A	Master			
101B	103B		Latest command point No.		
101C	103C	Reserved			
101D	103D				
101E	103E				
101F	103F				

Note. The manual feed speed is the moving speed for manual operation (JOG operation as well as incremental feed).

10. TABLE MAP

Address	Content	Tandem drive when in (synchronous)
1040	Monitor number 1	Each axis
1041		
1042	Monitor number 2	Each axis
1043		
1044	Monitor number 3	Each axis
1045		
1046	Monitor number 4	Each axis
1047		
1048	Torque control speed limit value	/
1049		
104A		
104B		
104C	Reserved	/
104D		
104E		
104F		

Address	Content	Tandem drive when in (synchronous)
1050	Parameter write number 1	Each axis
1051		
1052	Parameter write data 1	Each axis
1053		
1054	Parameter write number 2	Each axis
1055		
1056	Parameter write data 2	Each axis
1057		
1058	Parameter read number 1	Each axis
1059		
105A	Reserved	/
105B		
105C	Parameter read number 2	Each axis
105D		
105E	Reserved	/
105F		

10. TABLE MAP

(2) Command bit

The addresses in the table are the addresses for the axis 1. For the axis 2 and above, increase in units of C0h for each axis.

The column in the table for when tandem drive is being used is for axis data classification for when using tandem drive synchronous mode.

Master : The data only valid for the master axis (refer to Section 8.3)

Each axis : The data valid for both the master axis and slave axis (refer to Section 8.3)

Special : Refer to Section 8.5 for details.

Not supported : The data not supported by tandem drive.

Address	Bit	Symbol	Signal name	When tandem drive is being used
1000	0	SON	Servo on	Special
	1	/	Reserved	/
	2			
	3			
	4	TL	Torque limit	Each axis
	5	SRST	Servo alarm reset	Each axis
	6	/	Reserved	/
7				

Address	Bit	Symbol	Signal name	When tandem drive is being used
1001	0	ST	Start operation	Master
	1	DIR	Movement direction	Master
	2	STP	Stop operation	Master
	3	RSTP	Rapid stop	Master
	4	/	Reserved	/
	5			
	6	/	Reserved	/
7				

Address	Bit	Symbol	Signal name	When tandem drive is being used
1002	0	AUT	Automatic operation mode	Master
	1	ZRN	Home position return mode	Master
	2	JOG	JOG operation mode	Master
	3	S	Incremental feed mode	Master
	4	/	Reserved	/
	5			
	6	DST	Home position reset mode	Master
7	/	Reserved	/	

Address	Bit	Symbol	Signal name	When tandem drive is being used
1003	0	/	Reserved	/
	1			
	2			
	3			
	4			
	5			
	6			
7				

Address	Bit	Symbol	Signal name	When tandem drive is being used
1004	0	ITL	Interlock	Master
	1	RMONR	High speed monitor latch command	Each axis
	2	/	Reserved	/
	3			
	4	LSPC	+ side limit switch input	Each axis
	5	LSNC	- side limit switch input	Each axis
	6	DOGC	Proximity dog input	Each axis
7	/	Reserved	/	

Address	Bit	Symbol	Signal name	When tandem drive is being used
1005	0	SCHG	Change speed	Master
	1	TACHG	Change acceleration time constant	Master
	2	TDCHG	Change deceleration time constant	Master
	3	PCHG	Position change	Master
	4	/	Reserved	/
	5			
	6			
7	/	Reserved	/	

10. TABLE MAP

Address	Bit	Symbol	Signal name	When tandem drive is being used
1006	0	FST	Fast start operation	Master
	1	Reserved	Reserved	Reserved
	2			
	3			
	4			
	5			
	6			
	7			

Address	Bit	Symbol	Signal name	When tandem drive is being used
1007	0	PPISTP	Pass position interrupt cancel	Master
	1	Reserved	Reserved	Reserved
	2			
	3			
	4			
	5			
	6			
	7			

Address	Bit	Symbol	Signal name	When tandem drive is being used			
1008	0	GAIN	Gain changing command	Each axis			
	1	FCLS	Fully closed loop control change command	Each axis			
	2	Reserved	Reserved	Reserved			
	3				CPC	PID control command	Each axis
	4						
	5						
	6						
	7						

Address	Bit	Symbol	Signal name	When tandem drive is being used
1009	0	Reserved	Reserved	Reserved
	1			
	2			
	3			
	4			
	5			
	6			
	7			

Address	Bit	Symbol	Signal name	When tandem drive is being used
100A	0	Reserved	Reserved	Reserved
	1			
	2			
	3			
	4	ZSC	Home position set command	Reserved
	5	Reserved	Reserved	Reserved
	6			
	7			

Address	Bit	Symbol	Signal name	When tandem drive is being used						
100B	0	Reserved	Reserved	Reserved						
	1				MKC1	Mark detection clear command 1	Each axis			
	2				MKD1	Mark detection disable command 1	Each axis			
	3				MKSEN1	Mark detection setting enable command 1	Each axis			
	4				Reserved	Reserved	Reserved			
	5							MKC2	Mark detection clear command 2	Each axis
	6							MKD2	Mark detection disable command 2	Each axis
	7	MKSEN2	Mark detection setting enable command 2	Each axis						

10. TABLE MAP

Address	Bit	Symbol	Signal name	When tandem drive is being used
100C	0		Reserved	
	1			
	2			
	3			
	4	CTLMC	Control mode switch command	Not supported
	5		Reserved	
	6			
	7			

Address	Bit	Symbol	Signal name	When tandem drive is being used
100D	0		Reserved	
	1			
	2			
	3			
	4			
	5			
	6			
	7			

Address	Bit	Symbol	Signal name	When tandem drive is being used
100E	0		Reserved	
	1			
	2			
	3			
	4			
	5			
	6			
	7			

Address	Bit	Symbol	Signal name	When tandem drive is being used
100F	0		Reserved	
	1			
	2			
	3			
	4			
	5			
	6			
	7			

Address	Bit	Symbol	Signal name	When tandem drive is being used
1010	0	MON	Monitor command	Each axis
	1	MONR	Monitor latch command	Each axis
	2		Reserved	
	3			
	4			
	5			
	6			
	7			

Address	Bit	Symbol	Signal name	When tandem drive is being used
1011	0		Reserved	
	1			
	2			
	3			
	4			
	5			
	6			
	7			

Address	Bit	Symbol	Signal name	When tandem drive is being used
1012	0		Reserved	
	1			
	2			
	3			
	4			
	5			
	6			
	7			

Address	Bit	Symbol	Signal name	When tandem drive is being used
1013	0		Reserved	
	1			
	2			
	3			
	4			
	5			
	6			
	7			

10. TABLE MAP

Address	Bit	Symbol	Signal name	When tandem drive is being used
1014	0	PWRT	Parameter write command	
	1		Reserved	
	2			
	3			
	4			
	5			
	6			
	7	PSF	Servo parameter read complete	

Address	Bit	Symbol	Signal name	When tandem drive is being used
1015	0	PRD	Parameter read command	Each axis
	1		Reserved	
	2			
	3			
	4			
	5			
	6			
	7			

Address	Bit	Symbol	Signal name	When tandem drive is being used
1016	0		Reserved	
	1			
	2			
	3			
	4			
	5			
	6			
	7			

Address	Bit	Symbol	Signal name	When tandem drive is being used
1017	0		Reserved	
	1			
	2			
	3			
	4			
	5			
	6			
	7			

Address	Bit	Symbol	Signal name	When tandem drive is being used
1018	0		Reserved	
	1			
	2			
	3			
	4			
	5			
	6			
	7			

Address	Bit	Symbol	Signal name	When tandem drive is being used
1019	0		Reserved	
	1			
	2			
	3			
	4			
	5			
	6			
	7			

Address	Bit	Symbol	Signal name	When tandem drive is being used
101A	0		Reserved	
	1			
	2			
	3			
	4			
	5			
	6			
	7			

Address	Bit	Symbol	Signal name	When tandem drive is being used
101B	0		Reserved	
	1			
	2			
	3			
	4			
	5			
	6			
	7			

10. TABLE MAP

Address	Bit	Symbol	Signal name	When tandem drive is being used
101C	0		Reserved	
	1			
	2			
	3			
	4			
	5			
	6			
	7			

Address	Bit	Symbol	Signal name	When tandem drive is being used
101D	0		Reserved	
	1			
	2			
	3			
	4			
	5			
	6			
	7			

Address	Bit	Symbol	Signal name	When tandem drive is being used
101E	0		Reserved	
	1			
	2			
	3			
	4			
	5			
	6			
	7			

Address	Bit	Symbol	Signal name	When tandem drive is being used
101F	0		Reserved	
	1			
	2			
	3			
	4			
	5			
	6			
	7			

10. TABLE MAP

10.7.2 Axis data status table

(1) Table list

The addresses in the table are the addresses for the first axis. For the axis 2 and above, increase in units of C0h for each axis.

The column in the table for when tandem drive (synchronous) is being used is for axis data classification for when using tandem drive.

Master : The data only valid for the master axis (refer to Section 8.3)

Each axis: The data valid for both the master axis and slave axis (refer to Section 8.3)

Address	Content	When in parallel drive (synchronous)	Address	Content	When in parallel drive (synchronous)
1060	Status bit	Refer to (2) of this section	1080	Operation alarm number	Master
1061			1081		
1062			1082	Specific operation alarm number	Master
1063			1083		
1064			1084	Servo alarm number	Each axis
1065			1085		
1066			1086	Specific servo alarm number	Each axis
1067			1087		
1068			Reserved	/	1088
1069					1089
106A					108A
106B					108B
106C			108C	Operation point No.	Master
106D			108D		
106E			108E	Maximum position command buffer number	/
106F			108F		
1070			1090	Transmit position command buffer number	/
1071			1091		
1072			1092	Control mode status	/
1073			1093		
1074	1094	Executing pass position condition number	Master		
1075	1095				
1076	Reserved	/	1096		
1077			1097		
1078			1098		
1079			1099		
107A			109A		
107B			109B		
107C			109C		
107D			109D		
107E			109E		
107F			109F		

10. TABLE MAP

Address	Content	When in parallel drive (synchronous)
10A0	Monitor number 1	Each axis
10A1		
10A2	Monitor number 2	Each axis
10A3		
10A4	Monitor number 3	Each axis
10A5		
10A6	Monitor number 4	Each axis
10A7		
10A8	Monitor data 1	Each axis
10A9		
10AA	Monitor data 2	Each axis
10AB		
10AC	Monitor data 3	Each axis
10AD		
10AE	Monitor data 4	Each axis
10AF		

Address	Content	When in parallel drive (synchronous)
10B0	Parameter write number 1	Each axis
10B1		
10B2	Parameter write data 1	Each axis
10B3		
10B4	Parameter write number 2	Each axis
10B5		
10B6	Parameter write data 2	Each axis
10B7		
10B8	Parameter read number 1	Each axis
10B9		
10BA	Parameter read data 1	Each axis
10BB		
10BC	Parameter read number 2	Each axis
10BD		
10BE	Parameter read data 2	Each axis
10BF		

10. TABLE MAP

(2) Status bit

For each bit, 0 stands for invalid and 1 stands for valid.

The column in the table for when tandem drive is being used is for axis data classification for when using tandem drive synchronous mode.

Master : The data only valid for the master axis (refer to Section 8.3)

Each axis : The data valid for both the master axis and slave axis (refer to Section 8.3)

Not supported : The data not supported by tandem drive.

Address	Bit	Symbol	Signal name	When tandem drive is being used
1060	0	RDY	Servo ready	Each axis
	1	INP	In-position	Each axis
	2	ZSP	Zero speed	Each axis
	3	ZPAS	Passed Z-phase	Each axis
	4	TLC	Torque limit effective	Each axis
	5	SALM	Servo alarm	Each axis
	6	SWRN	Servo warning	Each axis
	7	ABSE	Absolute position erased	Each axis

Address	Bit	Symbol	Signal name	When tandem drive is being used
1061	0	OP	During operation	Master
	1	CPO	Rough match	Master
	2	PF	Positioning complete	Master
	3	ZP	Home position return complete	Master
	4	SMZ	During smoothing of stopping	Master
	5	OALM	Operation alarm	Master
	6	OPF	Completion of operation	Master
	7	PSW	Position switch	Each axis

Address	Bit	Symbol	Signal name	When tandem drive is being used
1062	0	AUTO	In automatic operation mode	Master
	1	ZRNO	In home position return mode	Master
	2	JO	In JOG operation mode	Master
	3	SO	In incremental feed mode	Master
	4		Reserved	
	5	LIPO	In linear interpolation mode	Master
	6	DSTO	In home position reset mode	Master
	7		Reserved	

Address	Bit	Symbol	Signal name	When tandem drive is being used
1063	0		Reserved	
	1			
	2			
	3			
	4			
	5			
	6			
	7			

10. TABLE MAP

Address	Bit	Symbol	Signal name	When tandem drive is being used
1064	0	ISTP	Interlock stop	Master
	1	RMRCH	High speed monitor is latched	Each axis
	2	POV	Stop position over-round	Master
	3	STO	Start up acceptance complete	Master
	4		Reserved	
	5			
	6	ZREQ	Home position return request	Master
	7		Reserved	

Address	Bit	Symbol	Signal name	When tandem drive is being used
1065	0	SCF	Completion of preparation for changing speed	Master
	1	TACF	Completion of preparation for changing acceleration time constant	Master
	2	TDCF	Completion of preparation for changing deceleration time constant	Master
	3	PCF	Completion of preparation for changing position	Master
	4	SCE	Speed change error	Master
	5	TACE	Acceleration time constant change error	Master
	6	TDCE	Deceleration time constant change error	Master
	7	PCE	Position change error	Master

Address	Bit	Symbol	Signal name	When tandem drive is being used
1066	0		Reserved	
	1			
	2			
	3			
	4			
	5			
	6			
	7			

Address	Bit	Symbol	Signal name	When tandem drive is being used
1067	0	PPIOP	Pass position interrupt	Master
	1	PPIFIN	Pass position interrupt complete	Master
	2	PPIERR	Pass position interrupt incomplete	Master
	3		Reserved	
	4			
	5			
	6			
	7	AUTLO	In point table loop	Master

10. TABLE MAP

Address	Bit	Symbol	Signal name	When tandem drive is being used
1068	0	GAINO	During gain switching	Each axis
	1	FCLSO	Fully closed loop control changing	Each axis
	2	TLSO	Selecting torque limit	Each axis
	3	SPC	During PID control	Each axis
	4		Reserved	
	5			
	6			
	7	PRSMO	During continuous operation to torque control	Not supported

Address	Bit	Symbol	Signal name	When tandem drive is being used
1069	0	IWT	Interference check standby	Each axis
	1	SINP	Servo amplifier in-position	Each axis
	2		Reserved	
	3			
	4			
	5			
	6			
	7			

Address	Bit	Symbol	Signal name	When tandem drive is being used
106A	0		Reserved	
	1			
	2			
	3			
	4	ZSF	Home position set complete	Not supported
	5	ZSE	Home position set error	Not supported
	6		Reserved	
	7			

Address	Bit	Symbol	Signal name	When tandem drive is being used
106B	0	MKIF1	Mark detection compatible information 1	Each axis
	1	MKCF1	Mark detection clear complete 1	Each axis
	2	MKDO1	Mark detection disabled 1	Each axis
	3	MKSEF1	Mark detection setting enable complete 1	Each axis
	4	MKIF2	Mark detection compatible information 2	Each axis
	5	MKCF2	Mark detection clear complete 2	Each axis
	6	MKDO2	Mark detection disabled 2	Each axis
	7	MKSEF2	Mark detection setting enable complete 2	Each axis

Address	Bit	Symbol	Signal name	When tandem drive is being used
106C	0		Reserved	
	1			
	2			
	3			
	4	CTLMCF	Control mode switch complete	Not supported
	5	CTLMCE	Control mode switch error	Not supported
	6		Reserved	
	7			

Address	Bit	Symbol	Signal name	When tandem drive is being used
106D	0		Reserved	
	1			
	2			
	3			
	4			
	5			
	6			
	7			

10. TABLE MAP

Address	Bit	Symbol	Signal name	When tandem drive is being used
106E	0		Reserved	
	1			
	2			
	3			
	4			
	5			
	6			
	7			

Address	Bit	Symbol	Signal name	When tandem drive is being used
106F	0		Reserved	
	1			
	2			
	3			
	4			
	5			
	6			
	7			

Address	Bit	Symbol	Signal name	When tandem drive is being used
1070	0	MOUT	Monitor output	Each axis
	1	MRCH	Monitor latch	Each axis
	2	MER1	Monitor number error 1	Each axis
	3	MER2	Monitor number error 2	Each axis
	4	MER3	Monitor number error 3	Each axis
	5	MER4	Monitor number error 4	Each axis
	6	MESV	Servo amplifier is not connected	Each axis
	7		Reserved	

Address	Bit	Symbol	Signal name	When tandem drive is being used
1071	0		Reserved	
	1			
	2			
	3			
	4			
	5			
	6			
	7			

Address	Bit	Symbol	Signal name	When tandem drive is being used
1072	0		Reserved	
	1			
	2			
	3			
	4			
	5			
	6			
	7			

Address	Bit	Symbol	Signal name	When tandem drive is being used
1073	0		Reserved	
	1			
	2			
	3			
	4			
	5			
	6			
	7			

10. TABLE MAP

Address	Bit	Symbol	Signal name	When tandem drive is being used
1074	0	PWFIN1	Parameter write complete 1	Each axis
	1	PWEN1	Parameter number error 1	Each axis
	2	PWED1	Parameter data out of bounds 1	Each axis
	3		Reserved	
	4	PWFIN2	Parameter write complete 2	Each axis
	5	PWEN2	Parameter number error 2	Each axis
	6	PWED2	Parameter data out of bounds 2	Each axis
	7	PSCHG	Changes to servo parameters exist	Each axis

Address	Bit	Symbol	Signal name	When tandem drive is being used
1075	0	PRFIN1	Parameter read complete 1	Each axis
	1	PREN1	Parameter number error 1	Each axis
	2	PRFIN2	Parameter read complete 2	Each axis
	3	PREN2	Parameter number error 2	Each axis
	4		Reserved	
	5			
	6			
	7			

Address	Bit	Symbol	Signal name	When tandem drive is being used
1076	0		Reserved	
	1			
	2			
	3			
	4			
	5			
	6			
	7			

Address	Bit	Symbol	Signal name	When tandem drive is being used
1077	0		Reserved	
	1			
	2			
	3			
	4			
	5			
	6			
	7			

Address	Bit	Symbol	Signal name	When tandem drive is being used
1078	0		Reserved	
	1			
	2			
	3			
	4			
	5			
	6			
	7			

Address	Bit	Symbol	Signal name	When tandem drive is being used
1079	0		Reserved	
	1			
	2			
	3			
	4			
	5			
	6			
	7			

10. TABLE MAP

Address	Bit	Symbol	Signal name	When tandem drive is being used
107A	0		Reserved	
	1			
	2			
	3			
	4			
	5			
	6			
	7			

Address	Bit	Symbol	Signal name	When tandem drive is being used
107B	0		Reserved	
	1			
	2			
	3			
	4			
	5			
	6			
	7			

Address	Bit	Symbol	Signal name	When tandem drive is being used
107C	0		Reserved	
	1			
	2			
	3			
	4			
	5			
	6			
	7			

Address	Bit	Symbol	Signal name	When tandem drive is being used
107D	0		Reserved	
	1			
	2			
	3			
	4			
	5			
	6			
	7			

Address	Bit	Symbol	Signal name	When tandem drive is being used
107E	0		Reserved	
	1			
	2			
	3			
	4			
	5			
	6			
	7			

Address	Bit	Symbol	Signal name	When tandem drive is being used
107F	0		Reserved	
	1			
	2			
	3			
	4			
	5			
	6			
	7			

10. TABLE MAP

10.8 Remote I/O data

10.8.1 RIO data command table

(1) Table list

The addresses in the table are the addresses for the station 1. For the station 2 and above, increase in units of 80 for each station.

Address	Content
3400	Command bit
3401	
3402	
3403	
3404	
3405	
3406	
3407	
3408	
3409	
340A	
340B	
340C	
340D	
340E	
340F	
3410	Reserved
3411	
3412	
3413	
3414	
3415	
3416	
3417	
3418	
3419	
341A	
341B	
341C	
341D	
341E	
341F	

Address	Content
3420	Monitor number 1
3421	
3422	Monitor number 2
3423	
3424	Monitor number 3
3425	
3426	Monitor number 4
3427	
3428	Reserved
3429	
342A	
342B	
342C	
342D	
342E	
342F	
3430	Parameter write number 1
3431	
3432	Parameter write data 1
3433	
3434	Parameter write number 2
3435	
3436	Parameter write data 2
3437	
3438	Parameter read number 1
3439	
343A	Reserved
343B	
343C	Parameter read number 2
343D	
343E	Reserved
343F	

10. TABLE MAP

(2) Command bit

For each bit, 0 stands for invalid and 1 stands for valid.

The addresses in the table are the addresses for the station 1. For the station 2 and above, increase in units of 80 for each station.

Address	Bit	Symbol	Signal name
3400	0		Reserved
	1		
	2		
	3		
	4		
	5	RURST	RIO module alarm reset
	6		Reserved
	7		

Address	Bit	Symbol	Signal name
3401	0		Reserved
	1		
	2		
	3		
	4		
	5	RCRST	RIO control alarm reset
	6		Reserved
	7		

Address	Bit	Symbol	Signal name
3402	0		Reserved
	1		
	2		
	3		
	4		
	5		
	6		
	7		

Address	Bit	Symbol	Signal name
3403	0		Reserved
	1		
	2		
	3		
	4		
	5		
	6		
	7		

Address	Bit	Symbol	Signal name
3404	0	MON	Monitor command
	1	MONR	Monitor latch command
	2		Reserved
	3		
	4		
	5		
	6		
	7		

Address	Bit	Symbol	Signal name
3405	0		Reserved
	1		
	2		
	3		
	4		
	5		
	6		
	7		

Address	Bit	Symbol	Signal name
3406	0	PWRT	Parameter write command
	1		Reserved
	2		
	3		
	4		
	5		
	6		
	7		

Address	Bit	Symbol	Signal name
3407	0	PRD	Parameter read command
	1		Reserved
	2		
	3		
	4		
	5		
	6		
	7		

10. TABLE MAP

Address	Bit	Symbol	Signal name
3408	0	/	Reserved
	1		
	2		
	3		
	4		
	5		
	6		
	7		

Address	Bit	Symbol	Signal name
3409	0	/	Reserved
	1		
	2		
	3		
	4		
	5		
	6		
	7		

Address	Bit	Symbol	Signal name
340A	0	/	Reserved
	1		
	2		
	3		
	4		
	5		
	6		
	7		

Address	Bit	Symbol	Signal name
340B	0	/	Reserved
	1		
	2		
	3		
	4		
	5		
	6		
	7		

Address	Bit	Symbol	Signal name
340C	0	/	Reserved
	1		
	2		
	3		
	4		
	5		
	6		
	7		

Address	Bit	Symbol	Signal name
340D	0	/	Reserved
	1		
	2		
	3		
	4		
	5		
	6		
	7		

Address	Bit	Symbol	Signal name
340E	0	/	Reserved
	1		
	2		
	3		
	4		
	5		
	6		
	7		

Address	Bit	Symbol	Signal name
340F	0	/	Reserved
	1		
	2		
	3		
	4		
	5		
	6		
	7		

10. TABLE MAP

10.8.2 RIO data status table

(1) Table list

The addresses in the table are the addresses for the station 1. For the station 2 and above, increase in units of 80 for each station.

Address	Content
3440	Status bit
3441	
3442	
3443	
3444	
3445	
3446	
3447	
3448	
3449	
344A	
344B	
344C	
344D	
344E	
344F	
3450	RIO control alarm No.
3451	
3452	Detail RIO control alarm No.
3453	
3454	RIO module alarm No.
3455	
3456	Detail RIO module alarm No.
3457	
3458	Reserved
3459	
345A	
345B	
345C	
345D	
345E	
345F	

Address	Content
3460	Monitor number 1
3461	
3462	Monitor number 2
3463	
3464	Monitor number 3
3465	
3466	Monitor number 4
3467	
3468	Monitor data 1
3469	
346A	Monitor data 2
346B	
346C	Monitor data 3
346D	
346E	Monitor data 4
346F	
3470	Parameter write number 1
3471	
3472	Parameter write data 1
3473	
3474	Parameter write number 2
3475	
3476	Parameter write data 2
3477	
3478	Parameter read number 1
3479	
347A	Parameter read data 1
347B	
347C	Parameter read number 2
347D	
347E	Parameter read data 2
347F	

10. TABLE MAP

(2) Status bit

For each bit, 0 stands for invalid and 1 stands for valid.

The addresses in the table are the addresses for the station 1. For the station 2 and above, increase in units of 80 for each station.

Address	Bit	Symbol	Signal name
3440	0	RURDY	Receiving controller ready on
	1	RUA	Outputting DO
	2	Reserved	
	3		
	4		
	5		
	6	RUALM	RIO module alarm
	7	RUWRN	RIO module warning
		Reserved	

Address	Bit	Symbol	Signal name
3441	0	Reserved	
	1		
	2		
	3		
	4	Reserved	
	5		
	6		
	7		
		RCALM	RIO control alarm
		Reserved	

Address	Bit	Symbol	Signal name
3442	0	Reserved	
	1		
	2		
	3		
	4		
	5		
	6		
	7		

Address	Bit	Symbol	Signal name
3443	0	Reserved	
	1		
	2		
	3		
	4		
	5		
	6		
	7		

Address	Bit	Symbol	Signal name
3444	0	MOUT	Monitor output
	1	MRCH	Monitor latch
	2	MER1	Monitor number error 1
	3	MER2	Monitor number error 2
	4	MER3	Monitor number error 3
	5	MER4	Monitor number error 4
	6	MERIO	RIO module is not connected
	7		Reserved

Address	Bit	Symbol	Signal name
3445	0	Reserved	
	1		
	2		
	3		
	4		
	5		
	6		
	7		

Address	Bit	Symbol	Signal name
3446	0	PWFIN1	Parameter write complete 1
	1	PWEN1	Parameter number error 1
	2	PWED1	Parameter data out of bounds 1
	3		Reserved
	4	PWFIN2	Parameter write complete 2
	5	PWEN2	Parameter number error 2
	6	PWED2	Parameter data out of bounds 2
	7		Reserved

Address	Bit	Symbol	Signal name
3447	0	PRFIN1	Parameter read complete 1
	1	PREN1	Parameter number error 1
	2	PRFIN2	Parameter read complete 2
	3	PREN2	Parameter number error 2
	4	Reserved	
	5		
	6		
	7		

10. TABLE MAP

Address	Bit	Symbol	Signal name
3448	0	/	Reserved
	1		
	2		
	3		
	4		
	5		
	6		
	7		

Address	Bit	Symbol	Signal name
3449	0	/	Reserved
	1		
	2		
	3		
	4		
	5		
	6		
	7		

Address	Bit	Symbol	Signal name
344A	0	/	Reserved
	1		
	2		
	3		
	4		
	5		
	6		
	7		

Address	Bit	Symbol	Signal name
344B	0	/	Reserved
	1		
	2		
	3		
	4		
	5		
	6		
	7		

Address	Bit	Symbol	Signal name
344C	0	/	Reserved
	1		
	2		
	3		
	4		
	5		
	6		
	7		

Address	Bit	Symbol	Signal name
344D	0	/	Reserved
	1		
	2		
	3		
	4		
	5		
	6		
	7		

Address	Bit	Symbol	Signal name
344E	0	/	Reserved
	1		
	2		
	3		
	4		
	5		
	6		
	7		

Address	Bit	Symbol	Signal name
344F	0	/	Reserved
	1		
	2		
	3		
	4		
	5		
	6		
	7		

10. TABLE MAP

10.9 Servo parameter change number

When parameter settings within the servo amplifier are changed using the auto tuning function or parameter changes using MR Configurator2 (set up software), the bit corresponding to the servo parameter number that was changed is turned on to notify concerning which parameter number was changed (in units of 16). To identify the changed parameter, check the servo parameter change number (monitor No.0590 to 05B7) corresponding to the bit which is turned on. Refer to Section 7.2 for more information.

(1) Servo parameter change number (SSCNET III/H)

Address	Content
3870	
3871	
3872	
3873	Servo parameter
3874	change number 1□□□ Axis 1
3875	
3876	
3877	
3878	
3879	
387A	
387B	Servo parameter
387C	change number 1□□□ Axis 2
387D	
387E	
387F	
3880	
3881	
3882	
3883	Servo parameter
3884	change number 1□□□ Axis 3
3885	
3886	
3887	
3888	
3889	
388A	
388B	Servo parameter
388C	change number 1□□□ Axis 4
388D	
388E	
388F	
3890	
3891	
3892	
3893	Servo parameter
3894	change number 1□□□ Axis 5
3895	
3896	
3897	

Address	Content
3898	
3899	
389A	
389B	Servo parameter
389C	change number 1□□□ Axis 6
389D	
389E	
389F	
38A0	
38A1	
38A2	
38A3	Servo parameter
38A4	change number 1□□□ Axis 7
38A5	
38A6	
38A7	
38A8	
38A9	
38AA	
38AB	Servo parameter
38AC	change number 1□□□ Axis 8
38AD	
38AE	
38AF	
38B0	
38B1	
38B2	
38B3	Servo parameter
38B4	change number 1□□□ Axis 9
38B5	
38B6	
38B7	
38B8	
38B9	
38BA	
38BB	Servo parameter
38BC	change number 1□□□ Axis 10
38BD	
38BE	
38BF	

10. TABLE MAP

Address	Content
38C0	Servo parameter change number 1□□□ Axis 11
38C1	
38C2	
38C3	
38C4	
38C5	
38C6	
38C7	
38C8	Servo parameter change number 1□□□ Axis 12
38C9	
38CA	
38CB	
38CC	
38CD	
38CE	
38CF	
38D0	Servo parameter change number 1□□□ Axis 13
38D1	
38D2	
38D3	
38D4	
38D5	
38D6	
38D7	
38D8	Servo parameter change number 1□□□ Axis 14
38D9	
38DA	
38DB	
38DC	
38DD	
38DE	
38DF	
38E0	Servo parameter change number 1□□□ Axis 15
38E1	
38E2	
38E3	
38E4	
38E5	
38E6	
38E7	
38E8	Servo parameter change number 1□□□ Axis 16
38E9	
38EA	
38EB	
38EC	
38ED	
38EE	
38EF	

Address	Content
38F0	Servo parameter change number 1□□□ Axis 17
38F1	
38F2	
38F3	
38F4	
38F5	
38F6	
38F7	
38F8	Servo parameter change number 1□□□ Axis 18
38F9	
38FA	
38FB	
38FC	
38FD	
38FE	
38FF	
3900	Servo parameter change number 1□□□ Axis 19
3901	
3902	
3903	
3904	
3905	
3906	
3907	
3908	Servo parameter change number 1□□□ Axis 20
3909	
390A	
390B	
390C	
390D	
390E	
390F	
3910	Reserved
:	
39EF	

10. TABLE MAP

(2) Details on servo amplifier change number on axis n (SSCNET III/H)

Address	Name	Abbreviation	Remarks
3870	Servo parameter change number 11□□	PSN11	bit0: Parameter No.1100 to 111F
3871			to bit15: Parameter No.11F0 to 11FF
3872	Servo parameter change number 12□□	PSN12	bit0: Parameter No.1200 to 121F
3873			to bit15: Parameter No.12F0 to 12FF
3874	Servo parameter change number 13□□	PSN13	bit0: Parameter No.1300 to 131F
3875			to bit7: Parameter No.1370 to 137F
3876	Reserved		
3877			

Note. The address in the table is the address for the axis 1. For the axis 2 and above, increase in units of 8h for each axis.

10. TABLE MAP

10.10 Transient transmit command/status table

(1) Transient transmit command table

Address	Content
D400	Command transmission request
D401	
D402	Transient command
D403	
D404	Request data 1
D405	
D406	Request data 2
D407	
D408	Request data 3
D409	
D40A	Request data 4
D40B	
D40C	Reserved
D40D	
D40E	
D40F	

Note 1. The addresses above are the addresses for the first axis. For the second axis and after, increase by 20h for each axis.

Note 2. The start address for the first station is DA00h. For the second station and after, increase by 20h for each station.

(2) Transient transmit status table

Address	Content
D410	Transient status
D411	
D412	Reserved
D413	
D414	Response data 1
D415	
D416	Response data 2
D417	
D418	Response data 3
D419	
D41A	Response data 4
D41B	
D41C	Reserved
D41D	
D41E	
D41F	

Note 1. The addresses above are the addresses for the first axis. For the second axis and after, increase by 20h for each axis.

Note 2. The start address for the first station is DA10h. For the second station and after, increase by 20h for each station.

10. TABLE MAP

10.11 Point number offset

The first number in the point table for each axis can be designated using point number offset.

The amount of offset from the first point in the point table is set by the point number for the point number offset.

When setting up the point table, use the following equation to derive the 2-point memory address.

$$\text{The address of the dual port memory} = 5000\text{h} + 20\text{h} \times \text{point number offset}$$

When the point number offset of the axis 2 is 0020h, the dual port memory address calculates to.

$$5000\text{h} + 20\text{h} \times 0020\text{h} = 5400\text{h}$$

Set the point table for the axis 2 from 5400h.

Address	Content	Initial Value
4FA0	Axis 1 point number offset	0000h
4FA1		
4FA2	Axis 2 point number offset	0008h
4FA3		
4FA4	Axis 3 point number offset	0010h
4FA5		
4FA6	Axis 4 point number offset	0018h
4FA7		
4FA8	Axis 5 point number offset	0020h
4FA9		
4FAA	Axis 6 point number offset	0028h
4FAB		
4FAC	Axis 7 point number offset	0030h
4FAD		
4FAE	Axis 8 point number offset	0038h
4FAF		
4FB0	Axis 9 point number offset	0040h
4FB1		
4FB2	Axis 10 point number offset	0048h
4FB3		
4FB4	Axis 11 point number offset	0050h
4FB5		

Address	Content	Initial Value
4FB6	Axis 12 point number offset	0058h
4FB7		
4FB8	Axis 13 point number offset	0060h
4FB9		
4FBA	Axis 14 point number offset	0068h
4FBB		
4FBC	Axis 15 point number offset	0070h
4FBD		
4FBE	Axis 16 point number offset	0078h
4FBF		
4FC0	Axis 17 point number offset	0080h
4FC1		
4FC2	Axis 18 point number offset	0088h
4FC3		
4FC4	Axis 19 point number offset	0090h
4FC5		
4FC6	Axis 20 point number offset	0098h
4FC7		
4FC8	Reserved	/
:		
4FEF		

10. TABLE MAP

10.12 Command buffers

(1) Position command buffer

Address	Content
5000	
5001	Position command buffer 0
5002	(pulse)
5003	
5004	
5005	Position command buffer 1
5006	(pulse)
5007	
5008	
5009	Position command buffer 2
500A	(pulse)
500B	
500C	
500D	Position command buffer 3
500E	(pulse)
500F	
5010	
5011	Position command buffer 4
5012	(pulse)
5013	
5014	
5015	Position command buffer 5
5016	(pulse)
5017	
5018	
5009	Position command buffer 6
501A	(pulse)
501B	
501C	
501D	Position command buffer 7
501E	(pulse)
501F	
5020	
5021	Position command buffer 8
5022	(pulse)
5023	
5024	
5025	Position command buffer 9
5026	(pulse)
5027	
5028	
5029	Position command buffer 10
502A	(pulse)
502B	

Address	Content
502C	
502D	Position command buffer 11
502E	(pulse)
502F	
5030	
5031	Position command buffer 12
5032	(pulse)
5033	
5034	
5035	Position command buffer 13
5036	(pulse)
5037	
5038	
5039	Position command buffer 14
503A	(pulse)
503B	
503C	
503D	Position command buffer 15
503E	(pulse)
503F	
5040	
5041	Position command buffer 16
5042	(pulse)
5043	
5044	
:	:
50EF	
50F0	
50F1	Position command buffer 60
50F2	(pulse)
50F3	
50F4	
50F5	Position command buffer 61
50F6	(pulse)
50F7	
50F8	
50F9	Position command buffer 62
50FA	(pulse)
50FB	
50FC	
50FD	Position command buffer 63
50FE	(pulse)
50FF	

Note. The addresses in the table are the addresses for the axis 1. For the axis 2 and above, increase the units of 100h for each axis.

10. TABLE MAP

(2) Speed command buffer

Address	Content
7800	Speed command buffer 0 (0.01r/min)
7801	
7802	
7803	

Note 1. Setting range: -1000000000 (-10000000r/min) to 1000000000 (10000000r/min)

2. The addresses above are the addresses for the first axis.

For the second axis and after, increase by 80h for each axis.

(3) Torque command buffer

Address	Content
8C00	Torque command buffer 0
8C01	(0.1%)
8C02	(When parameter No.010D is 0,
8C03	positive: CCW negative: CW)

Note 1. Setting range: -32768 (-3276.8%) to 32767 (3276.7%)

2. The addresses above are the addresses for the first axis.

For the second axis and after, increase by 80h for each axis.

10. TABLE MAP

10.13 Digital I/O table

(1) Digital input table

Address	Digital input area number	Digital input number	Symbol	Remarks
B000	Digital input area 0 (2 bytes)	Digital input 0 to Digital input 15	DI_000 to DI_00F	Notifies the status of the digital input signal. The bits are DI_000 (bit0) to DI_00F (bit15).
B002	Digital input area 1 (2 bytes)	Digital input 16 to Digital input 31	DI_010 to DI_01F	Notifies the status of the digital input signal. The bits are DI_010(bit0) to DI_01F(bit15).
B004	Digital input area 2 (2 bytes)	Digital input 32 to Digital input 47	DI_020 to DI_02F	Notifies the status of the digital input signal. The bits are DI_020(bit0) to DI_02F(bit15).
B006	Digital input area 3 (2 bytes)	Digital input 48 to Digital input 63	DI_030 to DI_03F	Notifies the status of the digital input signal. The bits are DI_030(bit0) to DI_03F(bit15).
B008	Digital input area 4 (2 bytes)	Digital input 64 to Digital input 79	DI_040 to DI_04F	Notifies the status of the digital input signal. The bits are DI_040(bit0) to DI_04F(bit15).
B00A	Digital input area 5 (2 bytes)	Digital input 80 to Digital input 95	DI_050 to DI_05F	Notifies the status of the digital input signal. The bits are DI_050(bit0) to DI_05F(bit15).
B00C	Digital input area 6 (2 bytes)	Digital input 96 to Digital input 111	DI_060 to DI_06F	Notifies the status of the digital input signal. The bits are DI_060(bit0) to DI_06F(bit15).
B00E	Digital input area 7 (2 bytes)	Digital input 112 to Digital input 127	DI_070 to DI_07F	Notifies the status of the digital input signal. The bits are DI_070(bit0) to DI_07F(bit15).
:	:	:	:	:
B07E	Digital input area 63 (2 bytes)	Digital input 1008 to Digital input 1023	DI_3F0 to DI_3FF	Notifies the status of the digital input signal. The bits are DI_3F0(bit0) to DI_3FF(bit15).

(2) Digital output table

Address	Digital input area number	Digital input number	Symbol	Remarks
B080	Digital output area 0 (2 bytes)	Digital output 0 to Digital output 15	DO_000 to DO_00F	Turns on/off the digital output signal. The bits are DO_000(bit0) to DO_00F(bit15).
B082	Digital output area 1 (2 bytes)	Digital output 16 to Digital output 31	DO_010 to DO_01F	Turns on/off the digital output signal. The bits are DO_010(bit0) to DO_01F(bit15).
B084	Digital output area 2 (2 bytes)	Digital output 32 to Digital output 47	DO_020 to DO_02F	Turns on/off the digital output signal. The bits are DO_020(bit0) to DO_02F(bit15).
B086	Digital output area 3 (2 bytes)	Digital output 48 to Digital output 63	DO_030 to DO_03F	Turns on/off the digital output signal. The bits are DO_030(bit0) to DO_03F(bit15).
B088	Digital output area 4 (2 bytes)	Digital output 64 to Digital output 79	DO_040 to DO_04F	Turns on/off the digital output signal. The bits are DO_040(bit0) to DO_04F(bit15).
B08A	Digital output area 5 (2 bytes)	Digital output 80 to Digital output 95	DO_050 to DO_05F	Turns on/off the digital output signal. The bits are DO_050(bit0) to DO_05F(bit15).
B08C	Digital output area 6 (2 bytes)	Digital output 96 to Digital output 111	DO_060 to DO_06F	Turns on/off the digital output signal. The bits are DO_060(bit0) to DO_06F(bit15).
B08E	Digital output area 7 (2 bytes)	Digital output 112 to Digital output 127	DO_070 to DO_07F	Turns on/off the digital output signal. The bits are DO_070(bit0) to DO_07F(bit15).
:	:	:	:	:
B0FE	Digital output area 63 (2 bytes)	Digital output 1008 to Digital output 1023	DO_3F0 to DO_3FF	Turns on/off the digital output signal. The bits are DO_3F0(bit0) to DO_3FF(bit15).

10. TABLE MAP

10.14 I/O device table

(1) Input device table

Address	Content
DB00	Input word device 0
DB01	
DB02	Input word device 1
DB03	
DB04	Input word device 2
DB05	
DB06	Input word device 3
DB07	
DB08	Input word device 4
DB09	
DB0A	Input word device 5
DB0B	
DB0C	Input word device 6
DB0D	
DB0E	Input word device 7
DB0F	

Address	Content
DB10	Input word device 8
DB11	
DB12	Input word device 9
DB13	
DB14	Input word device 10
DB15	
DB16	
:	
DCF9	Input word device 253
DCFA	
DCFB	Input word device 254
DCFC	
DCFD	Input word device 255
DCFE	
DCFF	

(2) Output device table

Address	Content
DD00	Output word device 0
DD01	
DD02	Output word device 1
DD03	
DD04	Output word device 2
DD05	
DD06	Output word device 3
DD07	
DD08	Output word device 4
DD09	
DD0A	Output word device 5
DD0B	
DD0C	Output word device 6
DD0D	
DD0E	Output word device 7
DD0F	

Address	Content
DD10	Output word device 8
DD11	
DD12	Output word device 9
DD13	
DD14	Output word device 10
DD15	
DD16	
:	
DEF9	Output word device 253
DEFA	
DEFB	Output word device 254
DEFC	
DEFD	Output word device 255
DEFE	
DEFF	

10. TABLE MAP

10.15 Mark detection command/status table

(1) Mark detection command table

The column in the table for when tandem drive is being used is for axis data classification for when using tandem drive synchronous mode.

Each axis: The data valid for both the master axis and slave axis (refer to Section 8.3)

Address	Name	When in tandem drive
B4F0	Read complete buffer number 1	Each axis
B4F1	Read complete buffer number 2	Each axis
B4F2	Reserved	
B4F3		
B4F4		
B4F5		
B4F6		
B4F7		
B4F8		
B4F9		
B4FA		
B4FB		
B4FC		
B4FD		
B4FE		
B4FF		

Note. The addresses above are the addresses for the first axis.

For the second axis and after, increase by 20h for each axis.

(2) Mark detection status table

The column in the table for when tandem drive is being used is for axis data classification for when using tandem drive synchronous mode.

Each axis: The data valid for both the master axis and slave axis (refer to Section 8.3)

Address	Name	When in tandem drive
B500	Start data storage area 1	Each axis
B501	Number of continuous latch data storages 1	Each axis
B502	Number of mark detections counter 1	Each axis
B503	Mark detection mode 1	Each axis
B504	Start data storage area 2	Each axis
B505	Number of continuous latch data storages 2	Each axis
B506	Number of mark detections counter 2	Each axis
B507	Mark detection mode 2	Each axis
B508	Reserved	
B509		
B50A		
B50B		
B50C		
B50D		
B50E		
B50F		

Note. The addresses above are the addresses for the first axis.

For the second axis and after, increase by 20h for each axis.

10. TABLE MAP

10.16 Mark detection data tables

(1) Mark detection edge data table

This data shows the detection edges for every positioning data of the mark detection positioning data table.

0: Not detected 1: OFF edge 2: ON edge

Address	Content
BAF0	Mark detection edge data 0
BAF1	Mark detection edge data 1
BAF2	Mark detection edge data 2
BAF3	Mark detection edge data 3
BAF4	Mark detection edge data 4
BAF5	Mark detection edge data 5
BAF6	Mark detection edge data 6
BAF7	Mark detection edge data 7

Address	Content
BAF8	Mark detection edge data 8
BAF9	Mark detection edge data 9
BAFA	Mark detection edge data 10
:	:
BB2C	Mark detection edge data 60
BB2D	Mark detection edge data 61
BB2E	Mark detection edge data 62
BB2F	Mark detection edge data 63

(2) Mark detection positioning data table

Address	Content
BB30	Mark detection positioning data 0
BB31	
BB32	
BB33	
BB34	Mark detection positioning data 1
BB35	
BB36	
BB37	
BB38	Mark detection positioning data 2
BB39	
BB3A	
BB3B	
BB3C	Mark detection positioning data 3
BB3D	
BB3E	
BB3F	
BB40	Mark detection positioning data 4
BB41	
BB42	
BB43	
BB44	Mark detection positioning data 5
BB45	
BB46	
BB47	
BB48	Mark detection positioning data 6
BB49	
BB4A	
BB4B	
BB4C	Mark detection positioning data 7
BB4D	
BB4E	
BB4F	

Address	Content
BB50	Mark detection positioning data 8
BB51	
BB52	
BB53	
BB54	Mark detection positioning data 9
BB55	
BB56	
BB57	
BB58	Mark detection positioning data 10
BB59	
BB5A	
BB5B	
BB5C	:
:	
:	
:	
BC1F	Mark detection positioning data 60
BC20	
BC21	
BC22	
BC23	Mark detection positioning data 61
BC24	
BC25	
BC26	
BC27	Mark detection positioning data 62
BC28	
BC29	
BC2A	
BC2B	Mark detection positioning data 63
BC2C	
BC2D	
BC2E	
BC2F	

10. TABLE MAP

10.17 Continuous operation to torque control data table

Address	Abbreviation	Name	At manual switch selection
A840	PRCPS	Continuous operation to torque control switching position (4 bytes)	Invalid
A841			
A842			
A843			
A844	PRLMPS	Press limit position (4 bytes)	Valid
A845			
A846			
A847			
A848	PRCTSP	Continuous operation to torque control speed limit value (4 bytes)	Valid
A849			
A84A			
A84B			
A84C	PRTGTR	Target torque (2 bytes)	Valid
A84D			
A84E	PRTM	Press time (2 bytes)	Invalid
A84E			
A850	PRTRW	Torque settle width (2 bytes)	Valid
A851			
A852	PRWTM	Torque settle waiting time (2 bytes)	Valid
A853			
A854	PRCA	Continuous operation to torque control acceleration time constant (2 bytes)	Valid
A855			
A856	PRCD	Continuous operation to torque control deceleration time constant (2 bytes)	Valid
A857			
A858	PRCOP	Continuous operation to torque control operating conditions (2 bytes)	Valid
A859			
A85A		Reserved	
A85B			
A85C			
A85D			
A85E			
A85F			

Note. The addresses above are the addresses for the first axis. For the second axis and after, increase by 20h for each axis.

10.18 Interpolation group No. being executed table

Address	Content
E040	Interpolation group No. being executed

Note. The address above is the address for the first axis. For the second axis and after, increase by 1h for each axis.

(1) Interpolation group No. being executed

Stores the linear interpolation group No. in axes that are executing linear interpolation.

When linear interpolation operation is completed, the interpolation group No. being executed is cleared and changes to 0.

11. PARAMETERS

11. PARAMETERS

Concerning the parameters for which the parameter name shows that it is set by manufacturer, do not use other than the default values. If erroneous values are set, unexpected movement can occur.

The parameters are classified as is shown below.

Classification		(Note) Parameter No.	Remarks
System parameters		No. 0001 to 007F	
Servo amplifier	Servo parameters	No. 1100 to 1380	Each axis
	Control parameters	No. 0200 to 02FF	Each axis
SSCNETⅢ/H head module	RIO module parameters		Each station
	RIO control parameters	No. 0200 to 023F	Each station
Sensing module	RIO module parameters	No.1100 to 13FF	Each station
	RIO control parameters	No.0200 to 023F	Each station

Note. Parameter numbers are given in hexadecimal.

11. PARAMETERS

11.1 System parameters

POINT

▪ The settings for the parameters with a * mark at the front of the symbol are validated when the system is started.

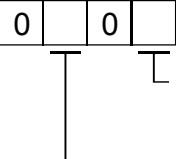
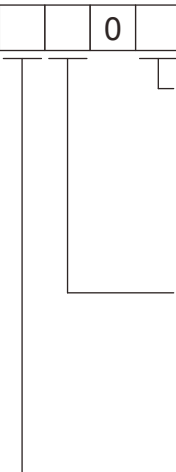
Parameter No.	Symbol	Name	Initial Value	Units	Setting range	Function
0001	*SYSOP1	System option 1	0000h		0000h to 0002h	 <p>Set the control cycle 0: 0.88ms 1: 0.44ms 2: 0.22ms</p> <p>SSCNET communication method Set the SSCNET communication method. 0: SSCNET III/H</p>
0002	*SYSOP2	System option 2	0000h		0000h to 1101h	 <p>Axis/station No. assignment Set 1 when validating axis/station No. assignment. When axis/station No. assignment is invalid, axis/station No. is automatically assigned. 0: Invalid 1: Valid</p> <p>Consistency check selection at system startup Set whether to perform consistency check for controlled axes setting at system startup. 0: Valid 1: Invalid</p> <p>Control mode selection Set the control mode. 0: Standard mode 1: Interface mode</p>
0003		For manufacturer setting	0			
0004	SITM	System interrupt conditions	0000h		0000h to FFFFh	Set the interrupt conditions for the system.
0005		For manufacturer setting	0			
0006			0			
0007			0			
0008			0			
0009			0			
000A			0			
000B			0			
000C			0			
000D			0			
000E	*EMID	External forced stop disabled	0000h		0000h to FFFFh	Disable the forced stop by EMI signal. 5AE1h : Forced stop disabled Other than 5AE1h: Forced stop enabled

11. PARAMETERS

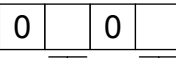
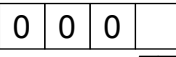
Parameter No.	Symbol	Name	Initial Value	Units	Setting range	Function
000F	*IFM0	Interface mode option	0000h		0000h to 0F0Fh	 <p>Interrupt output cycle When interrupt by interface mode is valid, set the cycle for which the interrupt is output. Interrupt output cycle: Control cycle × (setting value + 1) Example: When interrupt output cycle is set to 1 and control cycle is 0.88ms, interrupt is output approximately every 1.77ms.</p> <p>Command data update cycle Set the cycle for which position command is updated in interface mode. Command data update cycle: Control cycle × (setting value + 1) Example: When command data update cycle is set to 2 and control cycle is 0.88ms, position command is updated approximately every 2.66ms.</p>
0010	/	For manufacturer setting	0	/	/	/
:			:			
003F			0			
0040	LGS1	Log acquiring selection 1 (Note)	0000h		0000h to 0001h	Set whether to acquire the log of the system when the log function is used. System (bit 0) 0: Not acquire 1: Acquire
0041	LGS2	Log acquiring selection 2 (Note)	0000h		0000h to FFFFh	Set the axis No. for which the log is to be acquired. Axis 1 (bit 0) to axis 16 (bit 15) 0: Not acquire 1: Acquire
0042	LGS3	Log acquiring selection 3 (Note)	0000h		0000h to FFFFh	Set the axis No. for which the log is to be acquired. Axis 17 (bit 0) to axis 20 (bit 03) 0: Not acquire 1: Acquire
0043	/	For manufacturer setting	0000h	/	/	/
0044			0000h			
0045			0			
0046			0			
0047			0000h			
0048			0			
0049			0			
004A	*IOTBL	I/O table	0000h		0000h to 0001h	 <p>I/O table selection Set the I/O table to be used. 0: Use digital I/O table 1: Use I/O device table</p>
004B	/	For manufacturer setting	0	/	/	/

11. PARAMETERS

Parameter No.	Symbol	Name	Initial Value	Units	Setting range	Function				
004C	*SYSOP5	System option 5	0000h		0000h to 0001h	<table border="1" style="display: inline-table; vertical-align: middle;"> <tr> <td style="width: 20px; height: 20px; text-align: center;">0</td> <td style="width: 20px; height: 20px; text-align: center;">0</td> <td style="width: 20px; height: 20px; text-align: center;">0</td> <td style="width: 20px; height: 20px;"></td> </tr> </table> <p style="margin-left: 40px;">Interpolation axis setting method Specify the interpolation axis setting method. 0: Use control parameter 1: Use point table</p>	0	0	0	
0	0	0								
004D	/	For manufacturer setting	0	/	/	/				
:			:							
007F			0							

Note. When all the system parameters of the log acquiring selection (parameters No. 0040 to 0043) are set to 0000h (initial value), log for all axes and systems will be acquired.

11. PARAMETERS

11.2 Servo parameters

11.2.1 Servo amplifier MR-J4(W□)-□B

The parameters described in this section are for using the servo amplifier MR-J4(W□)-□B. For details, refer to the Servo Amplifier Instruction Manual on your servo amplifier.

POINT
<ul style="list-style-type: none">▪ The parameters with a * mark at the front of the symbol are validated according to the following conditions.<ul style="list-style-type: none">*: The setting value for the system startup or the SSCNET reconnection is valid. The parameter change after the system startup is invalid.** : The setting value for the system startup or the SSCNET reconnection is valid. However, after the system startup, turn off the power supply of the servo amplifier once, and it is necessary to turn on it again. The parameter change after the system startup is invalid.

11. PARAMETERS

(1) Menu A) Basic settings

Parameter No.	MR-J4-B Parameter No.	Symbol	Name	Initial Value	Units
1100	PA01	**STY	Operation mode	1000h	
1101	PA02	**REG	Regenerative option	0000h	
1102	PA03	*ABS	Absolute position detection system	0000h	
1103	PA04	*AOP1	Function selection A-1	2000h	
1104	PA05		For manufacturer setting	10000	
1105	PA06			1	
1106	PA07			1	
1107	PA08	ATU	Auto tuning mode	0001h	
1108	PA09	RSP	Auto tuning response	16	
1109	PA10	INP	In-position range	1600	pulse
110A	PA11		For manufacturer setting	10000	
110B	PA12			10000	
110C	PA13			0000h	
110D	PA14	*POL	Rotation direction selection/travel direction selection	0	
110E	PA15	*ENR	Encoder output pulses	4000	pulse/rev
110F	PA16	*ENR2	Encoder output pulses 2	1	
1110	PA17	**MSR	Servo motor series setting	0000h	
1111	PA18	**MTY	Servo motor type setting	0000h	
1112	PA19	*BLK	Parameter writing inhibit	00ABh	
1113	PA20	*TDS	Tough drive setting	0000h	
1114	PA21	*AOP3	Function selection A-3	0001h	
1115	PA22	**PCS	Position control composition selection	0000h	
1116	PA23	DRAT	Drive recorder arbitrary alarm trigger setting	0000h	
1117	PA24	AOP4	Function selection A-4	0000h	
1118	PA25	OTHOV	One-touch tuning - Overshoot permissible level	0000h	%
1119	PA26	*AOP5	Function selection A-5 (Note)	0000h	
111A	PA27		For manufacturer setting	0000h	
111B	PA28			0000h	
111C	PA29			0000h	
111D	PA30			0000h	
111E	PA31			0000h	
111F	PA32			0000h	
1120	PA33			0000h	
:	:			:	
113F	PA64		0000h		

Note. MR-J4-□B use.

11. PARAMETERS

(2) Menu B) Gain filter settings

Parameter No.	MR-J4-B Parameter No.	Symbol	Name	Initial Value	Units
1140	PB01	FILT	Adaptive tuning mode (adaptive filterII)	0000h	
1141	PB02	VRFT	Vibration suppression control tuning mode (Advanced vibration suppression controlII)	0000h	
1142	PB03	TFBGN	Torque feedback loop gain	18000	rad/s
1143	PB04	FFC	Feed forward gain	0	%
1144	PB05		For manufacturer setting	500	
1145	PB06	GD2	Load to motor inertia ratio/load to motor mass ratio	700	0.01 times
1146	PB07	PG1	Model loop gain	150	0.1 rad/s
1147	PB08	PG2	Position loop gain	370	0.1 rad/s
1148	PB09	VG2	Speed loop gain	823	rad/s
1149	PB10	VIC	Speed integral compensation	337	0.1ms
114A	PB11	VDC	Speed differential compensation	980	
114B	PB12	OVA	Overshoot amount compensation	0	%
114C	PB13	NH1	Machine resonance suppression filter 1	4500	Hz
114D	PB14	NHQ1	Notch shape selection 1	0000h	
114E	PB15	NH2	Machine resonance suppression filter 2	4500	Hz
114F	PB16	NHQ2	Notch shape selection 2	0000h	
1150	PB17	NHF	Shaft resonance suppression filter	0000h	
1151	PB18	LPF	Low-pass filter setting	3141	rad/s
1152	PB19	VRF11	Vibration suppression control 1 - Vibration frequency	1000	0.1Hz
1153	PB20	VRF12	Vibration suppression control 1 - Resonance frequency	1000	0.1Hz
1154	PB21	VRF13	Vibration suppression control 1 - Vibration frequency damping	0	0.1
1155	PB22	VRF14	Vibration suppression control 1 - Resonance frequency damping	0	0.1
1156	PB23	VFBF	Low-pass filter selection	0000h	
1157	PB24	*MVS	Slight vibration suppression control	0000h	
1158	PB25	*BOP1	Function selection B-1	0000h	
1159	PB26	*CDP	Gain switching function	0000h	
115A	PB27	CDL	Gain switching condition	10	kpps pulse r/min
115B	PB28	CDT	Gain switching time constant	1	ms
115C	PB29	GD2B	Load to motor inertia ratio/load to motor mass ratio after gain switching	700	0.01 times
115D	PB30	PG2B	Position loop gain after gain switching	0	0.1 rad/s
115E	PB31	VG2B	Speed loop gain after gain switching	0	rad/s
115F	PB32	VICB	Speed integral compensation after gain switching	0	0.1ms
1160	PB33	VRF11B	Vibration suppression control 1 - Vibration frequency after gain switching	0	0.1Hz
1161	PB34	VRF12B	Vibration suppression control 1 - Resonance frequency after gain switching	0	0.1Hz
1162	PB35	VRF13B	Vibration suppression control 1- Vibration frequency damping after gain switching	0	0.01
1163	PB36	VRF14B	Vibration suppression control 1- Resonance frequency damping after gain switching	0	0.01
1164	PB37		For manufacturer setting	1600	
1165	PB38			0	
1166	PB39			0	
1167	PB40			0	
1168	PB41			0	
1169	PB42			0	

11. PARAMETERS

Parameter No.	MR-J4-B Parameter No.	Symbol	Name	Initial Value	Units
116A	PB43		For manufacturer setting	0000h	
116B	PB44			0	
116C	PB45	CNHF	Command notch filter	0000h	
116D	PB46	NH3	Machine resonance suppression filter 3	4500	Hz
116E	PB47	NHQ3	Notch shape selection 3	0000h	
116F	PB48	NH4	Machine resonance suppression filter 4	4500	Hz
1170	PB49	NHQ4	Notch shape selection 4	0000h	
1171	PB50	NH5	Machine resonance suppression filter 5	4500	Hz
1172	PB51	NHQ5	Notch shape selection 5	0000h	
1173	PB52	VRF21	Vibration suppression control 2 - Vibration frequency	1000	0.1Hz
1174	PB53	VRF22	Vibration suppression control 2 - Resonance frequency	1000	0.1Hz
1175	PB54	VRF23	Vibration suppression control 2 - Vibration frequency damping	0	0.01
1176	PB55	VRF24	Vibration suppression control 2 - Resonance frequency damping	0	0.01
1177	PB56	VRF21B	Vibration suppression control 2 - Vibration frequency after gain switching	0	0.1Hz
1178	PB57	VRF22B	Vibration suppression control 2 - Resonance frequency after gain switching	0	0.1Hz
1179	PB58	VRF23B	Vibration suppression control 2 - Vibration frequency damping after gain switching	0	0.01
117A	PB59	VRF24B	Vibration suppression control 2 - Resonance frequency damping after gain switching	0	0.01
117B	PB60	PG1B	Model loop gain after gain switching	0	0.1rad/s
117C	PB61		For manufacturer setting	0	
117D	PB62			0000h	
117E	PB63			0000h	
117F	PB64			0000h	

11. PARAMETERS

(3) Menu C) Expansion settings 1

Parameter No.	MR-J4-B Parameter No.	Symbol	Name	Initial Value	Units
1180	PC01	ERZ	Error excessive alarm level	0	rev or mm
1181	PC02	MBR	Electromagnetic brake sequence output	0	ms
1182	PC03	*ENRS	Encoder output pulse selection	0000h	
1183	PC04	**COP1	Function selection C-1	0000h	
1184	PC05	**COP2	Function selection C-2	0000h	
1185	PC06	*COP3	Function selection C-3	0000h	
1186	PC07	ZSP	Zero speed	50	r/min or mm/s
1187	PC08	OSL	Overspeed alarm detection level	0	r/min or mm/s
1188	PC09	MOD1	Analog monitor 1 output	0000h	
1189	PC10	MOD2	Analog monitor 2 output	0001h	
118A	PC11	MO1	Analog monitor 1 offset	0	mV
118B	PC12	MO2	Analog monitor 2 offset	0	mV
118C	PC13	MOSDL	Analog monitor - Feedback position output standard data - Low	0	pulse
118D	PC14	MOSDH	Analog monitor - Feedback position output standard data - High	0	10000 pulses
118E	PC15		For manufacturer setting	0	
118F	PC16			0000h	
1190	PC17	**COP4	Function selection C-4	0000h	
1191	PC18	*COP5	Function selection C-5	0000h (Note 1)	
1192	PC19		For manufacturer setting	0000h	
1193	PC20	*COP7	Function selection C-7	0000h	
1194	PC21	*BPS	Alarm history clear	0000h	
1195	PC22		For manufacturer setting	0	
1196	PC23			0000h	
1197	PC24	RSBR	Forced stop deceleration time constant	100	ms
1198	PC25		For manufacturer setting	0	
1199	PC26	**COP8	Function selection C-8 (Note 2)	0000h	
119A	PC27	**COP9	Function selection C-9	0000h	
119B	PC28		For manufacturer setting	0000h	
119C	PC29	*COPB	Function selection C-B	0000h	
119D	PC30		For manufacturer setting	0	
119E	PC31	RSUP1	Vertical axis freefall prevention compensation amount	0	0.0001rev or 0.01mm
119F	PC32		For manufacturer setting	0000h	
11A0	PC33			0	
11A1	PC34			100	
11A2	PC35			0000h	
11A3	PC36			0000h	
11A4	PC37			0000h	
11A5	PC38	ERW		Error excessive warning level	0
11A6	PC39		For manufacturer setting	0000h	
11A7	PC40			0000h	
11A8	PC41			0000h	

Note. 1. For Q173SCCF, the initial value is "1000h".

2. MR-J4-□B use.

11. PARAMETERS

Parameter No.	MR-J4-B Parameter No.	Symbol	Name	Initial Value	Units
11A9	PC42		For manufacturer setting	0000h	
11AA	PC43			0000h	
11AB	PC44			0000h	
11AC	PC45			0000h	
11AD	PC46			0000h	
11AE	PC47			0000h	
11AF	PC48			0000h	
11B0	PC49			0000h	
11B1	PC50			0000h	
11B2	PC51			0000h	
11B3	PC52			0000h	
11B4	PC53			0000h	
11B5	PC54			0000h	
11B6	PC55			0000h	
11B7	PC56			0000h	
11B8	PC57			0000h	
11B9	PC58			0000h	
11BA	PC59			0000h	
11BB	PC60			0000h	
11BC	PC61			0000h	
11BD	PC62	0000h			
11BE	PC63	0000h			
11BF	PC64	0000h			

11. PARAMETERS

(4) Menu D) I/O settings

Parameter No.	MR-J4-B Parameter No.	Symbol	Name	Initial Value	Units
11C0	PD01		For manufacturer setting	0000h	
11C1	PD02	*DIA2	Input signal automatic on selection 2	0000h	
11C2	PD03		For manufacturer setting	0020h	
11C3	PD04			0021h	
11C4	PD05			0022h	
11C5	PD06			0000h	
11C6	PD07	*DO1		Output device selection 1	
11C7	PD08	*DO2	Output device selection 2	0004h	
11C8	PD09	*DO3	Output device selection 3	0003h	
11C9	PD10		For manufacturer setting	0000h	
11CA	PD11	*DIF	Input filter setting	0004h	ms
11CB	PD12	*DOP1	Function selection D-1	0000h	
11CC	PD13	*DOP2	Function selection D-2	0000h	
11CD	PD14	*DOP3	Function selection D-3	0000h	
11CE	PD15		For manufacturer setting	0000h	
11CF	PD16			0000h	
11D0	PD17			0000h	
11D1	PD18			0000h	
11D2	PD19			0000h	
11D3	PD20			0	
11D4	PD21			0	
11D5	PD22			0	
11D6	PD23			0	
11D7	PD24			0000h	
11D8	PD25			0000h	
11D9	PD26			0000h	
11DA	PD27			0000h	
11DB	PD28			0000h	
11DC	PD29			0000h	
11DD	PD30			0	
11DE	PD31			0	
11DF	PD32			0	
11E0	PD33			0000h	
11E1	PD34			0000h	
11E2	PD35			0000h	
11E3	PD36			0000h	
11E4	PD37			0000h	
11E5	PD38			0000h	
11E6	PD39			0000h	
11E7	PD40			0000h	
11E8	PD41			0000h	
11E9	PD42			0000h	
11EA	PD43			0000h	
11EB	PD44			0000h	
11EC	PD45		0000h		
11ED	PD46		0000h		
11EE	PD47		0000h		
11EF	PD48		0000h		

11. PARAMETERS

Parameter No.	MR-J4-B Parameter No.	Symbol	Name	Initial Value	Units
11F0	PD49	/	For manufacturer setting	0000h	/
:	:			:	
11FF	PD64			0000h	

11. PARAMETERS

(5) Menu E) Expansion settings 2

Parameter No.	MR-J4-B Parameter No.	Symbol	Name	Initial Value	Units
1200	PE01	**FCT1	Fully closed loop function selection 1	0000h	
1201	PE02		For manufacturer setting	0000h	
1202	PE03	*FCT2	Fully closed loop function selection 2	0003h	
1203	PE04	**FBN	Fully closed loop control - Feedback pulse electronic gear 1 - Numerator	1	
1204	PE05	**FBD	Fully closed loop control - Feedback pulse electronic gear 2 - Denominator	1	
1205	PE06	BC1	Fully closed loop control - Speed deviation error detection level	400	r/min
1206	PE07	BC2	Fully closed loop control - Position deviation error detection level	100	kpulse
1207	PE08	DUF	Fully closed loop dual feedback filter	10	rad/s
1208	PE09		For manufacturer setting	0000h	
1209	PE10	FCT3	Fully closed loop function selection 3	0000h	
120A	PE11		For manufacturer setting	0	
120B	PE12			0	
120C	PE13			0000h	
120D	PE14			0111h	
120E	PE15			20	
120F	PE16			0000h	
1210	PE17			0000h	
1211	PE18			0000h	
1212	PE19			0000h	
1213	PE20			0000h	
1214	PE21			0000h	
1215	PE22			0000h	
1216	PE23			0000h	
1217	PE24			0000h	
1218	PE25			0000h	
1219	PE26			0000h	
121A	PE27			0000h	
121B	PE28			0000h	
121C	PE29			0000h	
121D	PE30			0000h	
121E	PE31			0000h	
121F	PE32			0000h	
1220	PE33			0000h	
1221	PE34	**FBN2	Fully closed loop control - Feedback pulse electronic gear 2- Numerator	1	
1222	PE35	**FBD2	Fully closed loop control - Feedback pulse electronic gear 2 - Denominator	1	
1223	PE36		For manufacturer setting	0	
1224	PE37			0	
1225	PE38			0	
1226	PE39			20	
1227	PE40			0000h	
1228	PE41	EOP3	Function selection E-3	0000h	
1229	PE42		For manufacturer setting	0	
122A	PE43			0	

11. PARAMETERS

Parameter No.	MR-J4-B Parameter No.	Symbol	Name	Initial Value	Units
122B	PE44	LMCP	Lost motion compensation positive-side compensation value selection (Note)	0	0.01%
122C	PE45	LMCN	Lost motion compensation negative-side compensation value selection (Note)	0	0.01%
122D	PE46	LMFLT	Lost motion filter setting (Note)	0	0.1ms
122E	PE47	TOF	Torque offset	0	0.01%
122F	PE48	*LMOP	Lost motion compensation function selection (Note)	0000h	
1230	PE49	LMCD	Lost motion compensation timing (Note)	0	0.1ms
1231	PE50	LMCT	Lost motion compensation non-sensitive band (Note)	0	pulse/kpulse
1232	PE51		For manufacturer setting	0000h	
1233	PE52			0000h	
1234	PE53			0000h	
1235	PE54			0000h	
1236	PE55			0000h	
1237	PE56			0000h	
1238	PE57			0000h	
1239	PE58			0000h	
123A	PE59			0000h	
123B	PE60			0000h	
123C	PE61			0	
123D	PE62			0	
123E	PE63			0	
123F	PE64			0	

Note. MR-J4-□B use.

11. PARAMETERS

(6) Menu F) Expansion settings 3

Parameter No.	MR-J4-B Parameter No.	Symbol	Name	Initial Value	Units
1240	PF01		For manufacturer setting	0000h	
1241	PF02	*FOP2	Function selection F-2 (Note)	0000h	
1242	PF03		For manufacturer setting	0000h	
1243	PF04			0	
1244	PF05			0000h	
1245	PF06	*FOP5	Function selection F-5	0000h	
1246	PF07		For manufacturer setting	0000h	
1247	PF08			0000h	
1248	PF09			0	
1249	PF10			0	
124A	PF11			0	
124B	PF12	DBT	Electronic dynamic brake operating time	2000	ms
124C	PF13		For manufacturer setting	0000h	
124D	PF14			10	
124E	PF15			0000h	
124F	PF16			0000h	
1250	PF17			0000h	
1251	PF18	**STOD	STO diagnosis error detection time	0	s
1252	PF19		For manufacturer setting	0000h	
1253	PF20			0000h	
1254	PF21	DRT	Drive recorder switching time setting	0	s
1255	PF22		For manufacturer setting	200	
1256	PF23	OSCL1	Vibration tough drive - Oscillation detection level	50	%
1257	PF24	*OSCL2	Vibration tough drive function selection	0000h	
1258	PF25	CVAT	SEMI-F47 function instantaneous power failure detection time (instantaneous power failure tough drive - detection time)	200	ms
1259	PF26		For manufacturer setting	0	
125A	PF27			0	°C
125B	PF28			0	
125C	PF29			0000h	
125D	PF30			0	
125E	PF31	FRIC	Machine diagnosis function - Friction judgement speed	0	r/min or mm/s
125F	PF32		For manufacturer setting	50	
1260	PF33			0000h	
1261	PF34			0000h	
1262	PF35			0000h	
1263	PF36			0000h	
1264	PF37			0000h	
1265	PF38			0000h	
1266	PF39			0000h	
1267	PF40			0000h	
1268	PF41			0000h	
1269	PF42			0000h	
126A	PF43			0000h	
126B	PF44			0000h	
126C	PF45			0000h	
126D	PF46			0000h	

Note. MR-J4W□-□B use.

11. PARAMETERS

Parameter No.	MR-J4-B Parameter No.	Symbol	Name	Initial Value	Units
126E	PF47		For manufacturer setting	0000h	
126F	PF48			0000h	
1270	PF49			0000h	
:	:			:	
127F	PF64			0000h	

11. PARAMETERS

(7) Menu O) Option setting

Parameter No.	MR-J4-B Parameter No.	Symbol	Name	Initial Value	Units
1280	Po01		For manufacturer setting	0000h	
1281	Po02			0000h	
1282	Po03			0000h	
1283	Po04			0000h	
1284	Po05			0000h	
1285	Po06			0	
1286	Po07			0	
1287	Po08			0	
1288	Po09			0	
1289	Po10			0000h	
128A	Po11			0000h	
128B	Po12			0000h	
128C	Po13			0000h	
128D	Po14			0000h	
128E	Po15			0000h	
128F	Po16			0000h	
1290	Po17			0000h	
1291	Po18			0000h	
1292	Po19			0000h	
1293	Po20			0000h	
1294	Po21			0000h	
1295	Po22			0000h	
1296	Po23			0000h	
1297	Po24			0000h	
1298	Po25			0000h	
1299	Po26			0000h	
129A	Po27			0000h	
129B	Po28			0000h	
129C	Po29			0000h	
129D	Po30			0000h	
129E	Po31			0000h	
129F	Po32			0000h	
12A0	Po33			0000h	
:	:	:			
12BF	Po64	0000h			

11. PARAMETERS

(8) Menu S) Special settings

Parameter No.	MR-J4-B Parameter No.	Symbol	Name	Initial Value	Units
12C0	PS01		For manufacturer setting	0000h	
12C1	PS02			0000h	
12C2	PS03			0000h	
12C3	PS04			0000h	
12C4	PS05			0000h	
12C5	PS06			0000h	
12C6	PS07			0000h	
12C7	PS08			0000h	
12C8	PS09			0000h	
12C9	PS10			0000h	
12CA	PS11			0000h	
12CB	PS12			0000h	
12CC	PS13			0000h	
12CD	PS14			0000h	
12CE	PS15			0000h	
12CF	PS16			0000h	
12D0	PS17			0000h	
12D1	PS18			0000h	
12D2	PS19			0000h	
12D3	PS20			0000h	
12D4	PS21			0000h	
12D5	PS22			0000h	
12D6	PS23			0000h	
12D7	PS24			0000h	
12D8	PS25			0000h	
12D9	PS26			0000h	
12DA	PS27			0000h	
12DB	PS28			0000h	
12DC	PS29			0000h	
12DD	PS30			0000h	
12DE	PS31			0000h	
12DF	PS32			0000h	
12E0	PS33			0000h	
:	:	:			
12FF	PS64	0000h			

11. PARAMETERS

(9) Menu L) Linear servo motor/DD motor settings

Parameter No.	MR-J4-B Parameter No.	Symbol	Name	Initial Value	Units
1300	PL01	**LIT1	Linear servo motor/DD motor function selection 1	0301h	
1301	PL02	**LIM	Linear encoder resolution setting Numerator	1000	μm
1302	PL03	**LID	Linear encoder resolution setting Denominator	1000	μm
1303	PL04	*LIT2	Linear servo motor/DD motor function selection 2	0003h	
1304	PL05	LB1	Position deviation error detection level	0	mm 0.01rev
1305	PL06	LB2	Speed deviation error detection level	0	r/min mm/s
1306	PL07	LB3	Torque/thrust deviation error detection level	100	%
1307	PL08	*LIT3	Linear servo motor/DD motor function selection 3	0010h	
1308	PL09	LPWM	Magnetic pole detection voltage level	30	%
1309	PL10		For manufacturer setting	5	
130A	PL11			100	
130B	PL12			500	
130C	PL13			0000h	
130D	PL14			0	
130E	PL15			20	
130F	PL16			0	
1310	PL17	LTSTS	Magnetic pole detection - Minute position detection method - Function selection	0000h	
1311	PL18	IDLV	Magnetic pole detection - Minute position detection method - Identification signal amplitude	0	%
1312	PL19		For manufacturer setting	0	
1313	PL20			0	
1314	PL21			0	
1315	PL22			0	
1316	PL23			0000h	
1317	PL24			0	
1318	PL25			0000h	
1319	PL26			0000h	
131A	PL27			0000h	
131B	PL28			0000h	
131C	PL29			0000h	
131D	PL30			0000h	
131E	PL31			0000h	
131F	PL32			0000h	
1320	PL33			0000h	
1321	PL34			0000h	
1322	PL35			0000h	
1323	PL36			0000h	
1324	PL37			0000h	
1325	PL38			0000h	
1326	PL39			0000h	
1327	PL40			0000h	
1328	PL41			0000h	
1329	PL42			0000h	
132A	PL43			0000h	
132B	PL44	0000h			
132C	PL45	0000h			

11. PARAMETERS

Parameter No.	MR-J4-B Parameter No.	Symbol	Name	Initial Value	Units
132D	PL46			0000h	
132E	PL47			0000h	
132F	PL48			0000h	
1330	PL49			0000h	
:	:			:	
133F	PL64			0000h	

11. PARAMETERS

(10) Menu T) Parameter for manufacturer setting

Parameter No.	MR-J4-B Parameter No.	Symbol	Name	Initial Value	Units
1340	PT01		For manufacturer setting	0000h	
1341	PT02			0000h	
1342	PT03			0001h	
1343	PT04			500	
1344	PT05			10	
1345	PT06			100	
1346	PT07			100	
1347	PT08			0000h	
1348	PT09			0000h	
1349	PT10			0000h	
134A	PT11			0000h	
134B	PT12			0400h	
134C	PT13			0000h	
134D	PT14			0000h	
134E	PT15			100	
134F	PT16			100	
1350	PT17			100	
1351	PT18			0	
1352	PT19			0	
1353	PT20			0000h	
1354	PT21			0000h	
1355	PT22			0000h	
1356	PT23			100	
1357	PT24			150	
1358	PT25			20	
1359	PT26			0000h	
135A	PT27			0000h	
135B	PT28			0000h	
135C	PT29			0000h	
135D	PT30			0000h	
135E	PT31			0000h	
135F	PT32			0000h	
1360	PT33			0000h	
1361	PT34			0000h	
1362	PT35			0000h	
1363	PT36			0000h	
1364	PT37			0000h	
1365	PT38			0000h	
1366	PT39			0000h	
1367	PT40			0000h	
1368	PT41			0000h	
1369	PT42			0000h	
136A	PT43			0000h	
136B	PT44			0000h	
136C	PT45			0000h	
136D	PT46			0000h	
136E	PT47			0000h	
136F	PT48			0000h	
:	:		0000h		
137F	PT64		0000h		

11. PARAMETERS

11.3 Control parameters

POINT

- The settings for the parameters with a * mark at the front of the symbol are validated when the system is started.
- The column in the table for when tandem drive is being used is for control parameter setting classification of the axis for which the tandem drive is performed. Master shows where only the master value are valid, Same value shows both the master/slave axes is set to the same value, and Each axis shows where master/slave axis can be set separately.
Refer to "Chapter 8 TANDEM DRIVE" concerning details for the classification.

Parameter No.	Symbol	Name	Initial Value	Units	Setting range	Function	When tandem drive is being used
0200	*OPC1	Control option 1	0001h		0000h to 2111h	 <p>Control Axis Set to 1 for implementing control of servo amplifier 0: Not controlled 1: Controlled</p> <p>Amplifier-less axis function Set to 1 when servo amplifier communication is not implemented. When set to 1 together with the control axis, it is possible to run without a servo amplifier (simulate). 0: Invalid 1: Valid</p> <p>No home position If the position when power is turned on is to be defined as home position set to 1. If home position return is performed, the current position after executing home position return is the home position. 0: Invalid 1: Valid</p> <p>Speed units Set the units for the speed command 0: Position command units/min 1: Position command units/sec 2: r/min (Note) Always set the same value for the master axis and slave axis when tandem drive is being used.</p>	Same value

11. PARAMETERS

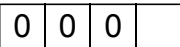
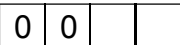
Parameter No.	Symbol	Name	Initial Value	Units	Setting range	Function	When tandem drive is being used
0201	OPC2	Control option 2	0000h		0000h to 0121h	 <p>Position switch judgement conditions Set the position switch judgement conditions 0: Current command position 1: Current feedback position</p> <p>Continuous operation position over-bound processing Defines processing for when the stop position exceeds the command position during operation. 0: Alarm 1: Return to command position 2: Stop firmly at command position</p> <p>Change of position over-bound processing Set processing for when the stop position exceeds the command position during position change. 0: Alarm 1: Return to command position</p>	Master
0202	*OPC3	Control option 3	0001h		0000h to 0001h	 <p>Interlock signal polarity Set the polarity of the Interlock signal. 0: B-contact 1: A-contact</p>	Master
0203	*AXALC	Axis No. assignment	0000h		0000h to 001Fh	 <p>Servo amplifier axis No. Set the servo amplifier axis No. to be assigned to the axis Nos. on the Q173SCCF. 00h: No axis No. assignment 01h to 14h: Axis No. Example) 0Ah: Axis No. 10</p>	Each axis
0204	ITM1	Interrupt condition 1	0000h		0000h to FFFFh	Set interrupt condition 1.	Each axis
0205	ITM2	Interrupt condition 2	0000h		0000h to FFFFh	Set interrupt condition 2.	Each axis

11. PARAMETERS

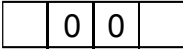
Parameter No.	Symbol	Name	Initial Value	Units	Setting range	Function	When tandem drive is being used
0206	*OPC4	Control option 4	0000h		0000h to 1001h	 <p> Predwell setting range Set the setting range of predwell. 0: 0 to 3000ms 1: 0 to 65535ms Re-acceleration setting for position change during deceleration Set the re-acceleration setting for position change during deceleration to enabled/disabled. 0: Disabled 1: Enabled </p>	Master
0207		For manufacturer setting	0				
0208	*BKC	Backlash compensation amount	0000h	pulse	0 to 65535	Setting for performing compensation of machine backlash.	Same value
0209		For manufacturer setting	0				
020A	*CMXL	Electronic gear numerator (lower)	0001h		1 to 5242879 (32 bit)	Set the numerator for electronic gears.	Master
020B	*CMXH	Electronic gear numerator (upper)	0000h				
020C	*CDVL	Electronic gear denominator (lower)	0001h		1 to 589823 (32 bit)	Set the denominator for electronic gears.	Master
020D	*CDVH	Electronic gear denominator (upper)	0000h				
020E	SUML	Speed units multiplication factor (lower)	2000h		1 to 32768 (32 bit)	Set the multiplication factor for the speed command.	Master
020F	SUMH	Speed units multiplication factor (upper)	0000h				
0210	TLP	Forward rotation torque limit value	3000	0.1%	0 to 32767	Set for limiting torque generated in the CW direction when the servo motor is exerting in the CCW direction.	Master
0211	TLN	Reverse rotation torque limit value	3000	0.1%	0 to 32767	Set for limiting torque generated in the CCW direction when the servo motor is exerting in the CW direction.	Master

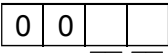

11. PARAMETERS

Parameter No.	Symbol	Name	Initial Value	Units	Setting range	Function	When tandem drive is being used
0212		For manufacturer setting	0				
0213	*GIOO	General I/O option	0000h		0000h to 0011h	 <p>Servo amplifier general input setting Set whether to use the general input of the servo amplifier. 0: Not used 1: Used Note: When the general input is used, the limit switch signal and the dog signal cannot be input from the servo amplifier. Set other than "Driver input" to the sensor input method (parameter No.0219).</p> <p>Servo amplifier general output setting Set whether to use the general output of the servo amplifier. 0: Not used 1: Used</p>	Each axis

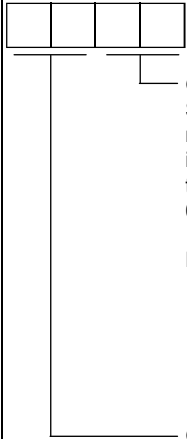

11. PARAMETERS

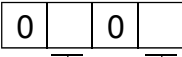
Parameter No.	Symbol	Name	Initial Value	Units	Setting range	Function	When tandem drive is being used
0214	*GDNA	General I/O number assignment	0000h		0000h to FFFFh	<p>Set assignment of the general I/O number.</p> <p>The setting target differs depending on the I/O table (parameter No.004A) setting.</p> <p>[When using a digital I/O table]</p>  <p>General input assignment Specify the first digital input area number to assign the general input. 00h to 3Fh: Digital input area 0 to 63 Example: When the digital input area number 1 is specified, assign 16 points of DI_010 to DI_01F. However, DI_013 to DI_01F are unavailable.</p> <p>General output assignment Specify the first digital output area number to assign the general output. 00h to 3Fh: Digital output area 0 to 63 Example: When the digital output area number 2 is specified, 16 points are assigned from DO_020 to DO_02F. However, DO_023 to DO_02F are unavailable.</p> <p>[When using a I/O device table]</p>  <p>General input assignment Specify the first input word device number that corresponds with the input bit device number to assign the general input. 00h to FFh: Input word device number 0 to FF Example: When the input word device number 01 is specified, 16 points are assigned from DVI_010 to DVI_01F. However, DVI_013 to DVI_01F are unavailable.</p> <p>General output assignment Specify the first output word device number that corresponds with the output bit device number to assign the general input. 00h to FFh: Output word device number 00 to FF Example: When the output word device number 2 is specified, 16 points are assigned from DVO_020 to DVO_02F. However, DVO_023 to DVI_02F are unavailable.</p>	Each axis

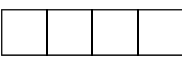

11. PARAMETERS

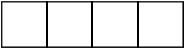
Parameter No.	Symbol	Name	Initial Value	Units	Setting range	Function	When tandem drive is being used
0215		For manufacturer setting	0000h				
0216			0000h				
0217			0000h				
0218			0				
0219	*SOP	Sensor input options	0000h		0000h to 0304h	 <p>Sensor input method 0: Unavailable 1: Driver input 2: Digital or input device input 3: Not connected (does not detect LSP, LSN, DOG) 4: Dual port memory input</p> <p>Limit switch signal selection 0: LSP/LSN are valid 1: LSP is valid, LSN is invalid 2: LSP is invalid, LSN is valid 3: LSP/LSN are invalid</p>	Each axis
021A	*SLSP	Sensor signal (LSP) connection specification	0000h		0000 to FFF1h	<p>The setting target differs depending on the I/O table (parameter No.004A) setting. [When using a digital I/O table]</p>  <p>Digital input assignment Set valid/invalid for the digital input assignment where LSP is connected. 0: Not assigned 1: Assigned</p> <p>Digital input number assignment Set the digital input number where LSP is connected. 000h to 3FFh: DI_000 to DI_3FF</p> <p>[When using a I/O device table]</p>  <p>Input device assignment Set valid/invalid for the input device assignment where LSP is connected. 0: Not assigned 1: Assigned</p> <p>Input device number assignment Set the input device number where LSP is connected. 000h to FFFh: DVI_000 to DVI_3FF</p>	Each axis

11. PARAMETERS

Parameter No.	Symbol	Name	Initial Value	Units	Setting range	Function	When tandem drive is being used
021B	*SLSN	Sensor signal (LSN) connection specification	0000h		0000 to FFF1h	<p>The setting target differs depending on the I/O table (parameter No.004A) setting.</p> <p>[When using a digital I/O table]</p>  <p>Digital input assignment Set valid/invalid for the digital input assignment where LSN is connected. 0: Not assigned 1: Assigned</p> <p>Digital input number assignment Set the digital input number where LSN is connected. 000h to 3FFh: DI_000 to DI_3FF</p> <p>[When using a I/O device table]</p>  <p>Input device assignment Set valid/invalid for the input device assignment where LSN is connected. 0: Not assigned 1: Assigned</p> <p>Input device number assignment Set the input device number where LSN is connected. 000h to FFFh: DVI_000 to DVI_3FF</p>	Each axis

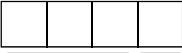
11. PARAMETERS

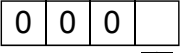
Parameter No.	Symbol	Name	Initial Value	Units	Setting range	Function	When tandem drive is being used
021C	*SDOG	Sensor signal (DOG) connection specification	0000h		0000 to FFF1h	<p>The setting target differs depending on the I/O table (parameter No.004A) setting.</p> <p>[When using a digital I/O table]</p>  <p>Digital input assignment Set valid/invalid for the digital input assignment where DOG is connected. 0: Not assigned 1: Assigned</p> <p>Digital input number assignment Set the digital input number where DOG is connected. 000h to 3FFh: DI_000 to DI_3FF</p> <p>[When using a I/O device table]</p>  <p>Input device assignment Set valid/invalid for the input device assignment where DOG is connected. 0: Not assigned 1: Assigned</p> <p>Input device number assignment Set the input device number where DOG is connected. 000h to FFFh: DVI_000 to DVI_3FF</p>	Each axis
021D	*VEND	Vendor ID	0000h		0000h to FFFFh	Set the vendor ID. (SSCNET III/H communication) 0000h: Mitsubishi Electric	Same value
021E	*CODE	Type code	0100h		0000h to FFFFh	Sets the type code. 1000h: MR-J4(W□)-□B 1200h: MR-JE-□B	Same value
021F		For manufacturer setting	0				
0220	OPS	Speed options	0000h		0000h to 0002h	 <p>Acceleration/deceleration method Set the type of acceleration/deceleration 0: Linear acceleration/deceleration 1: Smoothing filter 2: Start up speed active</p>	Master

11. PARAMETERS

Parameter No.	Symbol	Name	Initial Value	Units	Setting range	Function	When tandem drive is being used
0221	SRATE	S-curve ratio	0	%	0 to 100	Set the S-curve ratio of the S-curve acceleration/deceleration (Sine acceleration/deceleration). 0: S-curve acceleration/deceleration invalid 1 to 100: S-curve acceleration/deceleration (Note 1) S-curve acceleration/deceleration is performed for the acceleration/deceleration selected in acceleration/deceleration method (parameter No.0220). (Note 2) The S-curve ratio set by this parameter is used in JOG operation, incremental feed operation and home position return. For automatic operation and linear interpolation operation, set the S-curve ratio in the point table.	Master
0222	SPLL	Speed limit value (lower)	0BB8h	Speed units	0000h to FFFFh	Set the value for the moving speed limit.	Master
0223	SPLH	Speed limit value (upper)	0000h		0000h to 7FFFh		
0224	LSPL	Start up speed (lower)	0000h	Speed Units	0000h to FFFFh	Set the start up speed	Master
0225	LSPH	Start up speed (upper)	0000h		0000h to 7FFFh		
0226	STC	Smoothing time constant	0	ms	0 to 100	Sets the time constant of the smoothing filter.	Master
0227	STE	Rapid stop time constant	20	ms	0 to 20000	Set the deceleration time constant for when operation rapid stop or limit switch is input.	Master
0228	SLPL	Software limit Upper limit (lower)	0000h	Command Units	0000h to FFFFh	Set the + side of the software limit.	Master
0229	SLPH	Software limit Upper limit (upper)	0000h		0000h to FFFFh		
022A	SLNL	Software limit Lower limit (lower)	0000h	Command Units	0000h to FFFFh	Set the - side of the software limit.	Master
022B	SLNH	Software limit Lower limit (upper)	0000h		0000h to FFFFh		
022C	PSPL	Position switch Upper limit (lower)	0000h	Command Units	0000h to FFFFh	Set the + end position for turning on the position switch.	Master
022D	PSPH	Position switch Upper limit (upper)	0000h		0000h to FFFFh		Master
022E	PSNL	Position switch Lower limit (lower)	0000h	Command Units	0000h to FFFFh	Set the - end position for turning on the position switch.	Master
022F	PSNH	Position switch Lower limit (upper)	0000h		0000h to FFFFh		Master

11. PARAMETERS

Parameter No.	Symbol	Name	Initial Value	Units	Setting range	Function	When tandem drive is being used
0230	CRPL	Rough match output limits (lower)	0000h	Command Units	0000h to FFFFh	Set the remaining distance limits for outputting a command for rough matching.	Master
0231	CRPH	Rough match output limits (upper)	0000h		0000h to 7FFFh		
0232		For manufacturer setting	0				
0233			0				
0234			0				
0235			0				
0236			0				
0237			0				
0238			0				
0239			0				
023A			0				
023B			0				
023C			0				
023D			0				
023E			0				
023F			*IFBN				

11. PARAMETERS

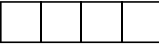
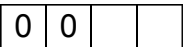
Parameter No.	Symbol	Name	Initial Value	Units	Setting range	Function	When tandem drive is being used
0240	*OPZ1	Home position return Option 1	0000h		0000h to 112Dh	 <p>Home position return method (Note 1), (Note 2) Set the method for home position return.</p> <ul style="list-style-type: none"> 0: Dog method 2: Data set method 3: Stopper method 4: Dog cradle method 5: Limit switch combined method 6: Scale home position signal detection method 7: Limit switch front end method 8: Dog front end method C: Z-phase detection method D: Scale home position signal detection method 2 <p>Home position return direction Set the home position return direction with respect to the proximity dog. Or the movement direction for creep speed movement.</p> <ul style="list-style-type: none"> 0: - direction 1: + direction 2: Shortcut direction (Note 1) <p>Proximity dog input polarity Set the input polarity for the proximity dog</p> <ul style="list-style-type: none"> 0: Normally closed contact 1: Normally open contact <p>Home position signal re-search (Note 2) Set "1" when using an incremental encoder or incremental linear scale.</p> <ul style="list-style-type: none"> 0: Do not search again 1: Master searching again <p>Note 1. Shortcut direction is available only by Z-phase detection method.</p> <p>2. Can be changed while system is running. (Software version A5 or later)</p>	Master
0241	*OPZ2	Home position return Option 2	0000h		0000h to 0011h	 <p>Absolute position data Set the validity/invalidity of restoring the absolute position.</p> <ul style="list-style-type: none"> 0: Invalid (The position at system startup is defined to be 0. Home position return must be executed prior to performing automatic operation or linear interpolation operation.) 1: Valid (absolute position is set at startup based on the home position multiple revolution data and the home position within 1 revolution position.) <p>Change of absolute position data on home position reset If 1 is set, the home position multiple revolution data and home position within 1 revolution position are renewed when the home position is reset.</p> <ul style="list-style-type: none"> 0: Invalid 1: Valid 	Master

11. PARAMETERS

Parameter No.	Symbol	Name	Initial Value	Units	Setting range	Function	When tandem drive is being used
0242	ZSPL	Home position return speed (lower)	00C8h	Speed Units	0000h to FFFFh	Set the moving speed for home position return.	Master
0243	ZSPH	Home position return speed (upper)	0000h		0000h to 7FFFh		
0244	ZTCA	Home position return acceleration time constant	100	ms	0 to 20000	Set the acceleration time constant for home position return.	Master
0245	ZTCD	Home position return deceleration time constant	100	ms	0 to 20000	Set the deceleration time constant for home position return.	Master
0246	ZPSL	Home position coordinates (lower)	0000h	Command Units	0000h to FFFFh	Set the home position coordinates (position after completing home position return).	Master
0247	ZPSH	Home position coordinates (upper)	0000h		0000h to FFFFh		
0248	ZSTL	Amount of home position shift (lower)	0000h	Command Units	0000h to FFFFh	Set the amount of shift from the Z-phase pulse detection position of the detector.	Master
0249	ZSTH	Amount of home position shift (upper)	0000h		0000h to FFFFh		
024A	ZLL	Home position search limit (lower)	0000h	Command Units	0000h to FFFFh	Set a limit on the movement amount when searching for the home position.	Master
024B	ZLH	Home position search limit (upper)	0000h		0000h to 7FFFh		
024C	CRF	Creep speed	0014h	Speed Units	0000h to 7FFFh	Set the creep speed after detecting the proximity dog.	Master
024D	*LS0	Home position multiple revolution data	0000h	rev	0000h to FFFFh	Set the home position multiple revolution data. (Only using with the absolute position detection system.)	Each axis
024E	*CY0L	Home position within 1 revolution position (lower)	0000h	pulse	0000h to FFFFh	Set the within 1 revolution home position. (Only using with the absolute position detection system.)	Each axis
024F	*CY0H	Home position within 1 revolution position (upper)	0000h		0000h to FFFFh		

11. PARAMETERS

Parameter No.	Symbol	Name	Initial Value	Units	Setting range	Function	When tandem drive is being used
0250	ZPML	Z-phase mask amount (lower)	0000h	Command Units	0000h to FFFFh	Set the reference encoder Z-phase mask amount when the home position return method is set to the Z-phase detection method.	Master
0251	ZPMH	Z-phase mask amount (upper)	0000h		0000h to 7FFFh		
0252		For manufacturer setting	0				
0253			0				
0254			0				
0255			0				
0256			0				
0257			0				
0258			0				
0259			0				
025A			0				
025B			0				
025C			0				
025D			0				
025E			0				
025F			0				
0260			*LGRP				
0261	LOP	Linear interpolation options	0000h	0000h to 0002h	<div style="border: 1px solid black; display: inline-block; padding: 2px;">0 0 0</div> Excessive speed processing 0: Speed clamp 1: Alarm and stop 2: No processing	Master	
0262	LSLL	Linear interpolation speed limit value (lower)	0BB8h	Speed Units	0000h to FFFFh	Set the limit for linear interpolation speed.	Master
0263	LSLH	Linear interpolation speed limit value (upper)	0000h		0000h to 7FFFh		
0264	*TGRP	Tandem drive group	0		0000h to 0008h	<div style="border: 1px solid black; display: inline-block; padding: 2px;">0 0 0</div> Group number Set the group number for the tandem drive group. 0: Invalid 1 to 8: Group number	Same value

11. PARAMETERS

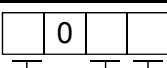
Parameter No.	Symbol	Name	Initial Value	Units	Setting range	Function	When tandem drive is being used
0265	TOP	Tandem drive options	0000h		0000h to 1011h	 <p>Method of to home position return Set the operation method when the scale home position signal detection method is used for return to home position. 0: Normal mode 1: Adjustment mode</p> <p>Synchronization setting Set the validity/invalidity of synchronization for turning servo on. 0: Valid 1: Invalid</p> <p>Compensation of home position return deviation Set the validity/invalidity of deviation compensation for home position return. 0: Deviation compensation invalid 1: Deviation compensation valid (Note) In home position return using a scale home position signal detection method, the deviation compensation becomes valid regardless of this setting.</p>	Master
0266	*TEV	Tandem drive synchronous alignment valid width	10000	Command Units	0 to 32767	Set the valid width for performing compensation of the deviation between the master axis and slave axis when the servo is turned on. (0: The check with the synchronous alignment valid width is invalid.)	Master
0267	*TES	Tandem drive synchronous alignment speed	10000	Speed Units	1 to 32767	Set the speed for performing compensation of the deviation between the master axis and slave axis when the servo is turned on.	Master
0268	*TEO	Tandem drive excessive deviation width	10000	Command Units	0 to 32767	Set the detection level for the excessive deviation alarm for deviation between the master axis and the slave axis. (0: The check with the excessive deviation width is invalid.)	Master
0269	*TMAG	Tandem drive unit multiplication factor	1		1 to 32767	Set the multiplication factor for excessive deviation width, synchronization speed, and synchronization valid width for tandem drive axes.	Master
026A	*TED	Late starting of tandem drive excessive deviation detection	50	ms	0 to 500	Set the delay time for from completion of synchronization for turning servo on until detection of excessive deviation is started.	Master
026B	*TOFL	Valid width of tandem drive deviation compensation	10000	Command Units	0 to 32767	Set the permissible width for performing compensation of the deviation between the master axis and slave axis when home position return is performed while in tandem drive axes mode. (0: The check with the valid width of deviation compensation is invalid.)	Master

11. PARAMETERS

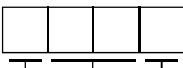
Parameter No.	Symbol	Name	Initial Value	Units	Setting range	Function	When tandem drive is being used
026C	TZOFL	Tandem drive home position signal offset (lower)	0000h	Command Units	0000h to FFFFh	Set the amount of offset for the home position signal position while in tandem drive axes mode. (Used when performing home position return using the scale home position signal detection method.)	Master
026D	TZOFH	Tandem drive home position signal offset (upper)	0000h		0000h to FFFFh		
026E	*TOFS	Tandem drive deviation compensation units multiplication	0		0 to 32767	Set the multiplication for valid width of tandem drive deviation compensation. (Note) When the setting value is 0, the multiplication is 1 times.	Master
026F		For manufacturer setting	0				
0270			0				
0271			0				
0272			0				
0273			0				
0274			0				
0275			0				
0276			0				
0277			0				
0278			0				
0279			0				
027A			0				
027B			0				
027C			0				
027D	0						
027E	0						
027F	0						
0280	0						
0281	*IOP	Interference check Options	0000h		0000h to 1FF1h	 <p>Interference check Set validity/invalidity of interference check. 0: Invalid 1: Valid</p> <p>Interference check axis Set the opposing axis for performing interference check. 00h to 13h: Interference check axis-1 Example: 0: Axis No. 1</p> <p>Interference check coordinate direction Set the direction of the coordinate system for the axis from the perspective of the standard coordinate system. 0: Same direction 1: Opposite direction</p>	Master

11. PARAMETERS

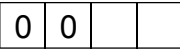
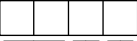
Parameter No.	Symbol	Name	Initial Value	Units	Setting range	Function	When tandem drive is being used
0282	*IOP2	Interference check Options 2	0000h		0000h to 0011h	 <p>Interference check direction Set the direction for which interference check is performed. 0: + direction of coordinate system for the axis 1: - direction of coordinate system for the axis</p> <p>Interference check standby Set validity/invalidity of interference check standby. 0: Invalid 1: Valid</p>	Master
0283		For manufacturer setting	0				
0284	IOFL	Interference check Offset (lower)	0000h	Command Units	0000h to FFFFh	Set the position on the home position standard coordinate system.	Master
0285	IOFH	Interference check Offset (upper)	0000h		0000h to FFFFh		
0286	IWL	Interference check width (lower)	0000h	Command Units	0000h to FFFFh	Set the width from the interference check axis target position of the area where interference check is performed.	Master
0287	IWH	Interference check width (upper)	0000h		0000h to 7FFFh		
0288		For manufacturer setting	0				
0289			0				
028A			0				
028B			0				
028C			0				
028D			0				
028E			0				
028F			0				
:			:				
02AF			0				
02B0	*MKOP1	Mark detection option 1	0000h		0000h to 3F23h	 <p>Mark detection signal number specification 1 Set the mark detection signal number to be used. 0 : Invalid 1 to 3: Mark detection signal number (DI1 to DI3)</p> <p>Mark detection mode Set the mark detection mode 0: Continuous detection 1: Specified number of detection 2: Ring buffer</p> <p>Number of continuous latch data storages (Note) Set the number of data that can be latched continuously. 00h to 3Fh: Number of continuous latch data storages-1 Note. Up to 64 can be set in the whole system.</p>	Each axis

11. PARAMETERS

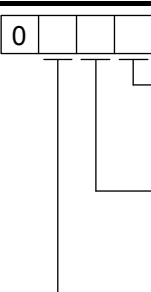
Parameter No.	Symbol	Name	Initial Value	Units	Setting range	Function	When tandem drive is being used
02B1	MKDS1	Mark detection data setting 1	0000h		0000h to 0111h	 <p>ON edge detection setting Set enable/disable for detection at ON edge. 0: Disable 1: Enable</p> <p>OFF edge detection setting Set enable/disable for detection at OFF edge. 0: Disable 1: Enable</p> <p>Mark detection data type Set the type of data to be stored as mark detection data. 0: Current feedback position [command units] 1: Current feedback position [pulse]</p>	Each axis
02B2	*MKOP2	Mark detection option 2	0000h		0000h to 3F23h	Same as mark detection option 1.	Each axis
02B3	MKDS2	Mark detection data setting 2	0000h		0000h to 0111h	Same as mark detection data setting 1.	Each axis
02B4	MKNL1	Latch data range lower limit 1 (lower)	0000h		0000h to FFFFh	Specify the range (lower limit) of data to be latched at detection of the mark detection signal of mark detection signal number specification 1. (Note1), (Note 2)	Each axis
02B5	MKNH1	Latch data range lower limit 1 (upper)	0000h		0000h to FFFFh		Each axis
02B6	MKXL1	Latch data range upper limit 1 (lower)	0000h		0000h to FFFFh	Specify the range (upper limit) of data to be latched at detection of the mark detection signal of mark detection signal number specification 1. (Note1), (Note 2)	Each axis
02B7	MKXH1	Latch data range upper limit 1 (upper)	0000h		0000h to FFFFh		Each axis
02B8	MKNL2	Latch data range lower limit 2 (lower)	0000h		0000h to FFFFh	Same as latch data range lower limit 1.	Each axis
02B9	MKNH2	Latch data range lower limit 2 (upper)	0000h		0000h to FFFFh		Each axis
02BA	MKXL2	Latch data range upper limit 2 (lower)	0000h		0000h to FFFFh	Same as latch data range upper limit 1.	Each axis
02BB	MKXH2	Latch data range upper limit 2 (upper)	0000h		0000h to FFFFh		Each axis
02BC		For manufacturer setting	0				
02BD			0				
02BE			0				
02BF			0				
:			:				
02FF			0				

Note 1. When changed while system is running, changes are enabled when a mark detection settings enable command is input.

2. The set units are regarded as command units, or pulse units (the unit set in mark detection data type (parameter No.02B1)).

11. PARAMETERS

11.4 RIO module parameters

11.4.1 SSCNET III/H head module

Refer to "MELSEC-L SSCNET III/H Head Module User's Manual" for the RIO module parameters of the SSCNET III/H head module.

11.4.2 Sensing module

The RIO module parameters of the sensing module are shown below. Refer to Sensing Module Instruction Manual for details of the sensing module.

POINT
<ul style="list-style-type: none">• The parameters with a * mark at the front of the symbol are validated according to the following conditions.<ul style="list-style-type: none">*: The setting value for the system startup or the SSCNET reconnection is valid. The parameter change after the system startup is invalid.** : The setting value for the system startup or the SSCNET reconnection is valid. However, after the system startup, turn off the power supply of the servo amplifier once, and it is necessary to turn on it again. The parameter change after the system startup is invalid.

11. PARAMETERS

(1) Sensing SSCNETⅢ/H head module parameters

Parameter No.	Sensing module Parameter No.	Symbol	Name	Initial Value	Units
1100	PTA001	*HDI11	DI1 (CN2-13) setting 1	0000h	
1101	PTA002	*HDI12	DI1 (CN2-13) setting 2	0000h	
1102	PTA003	*HDI21	DI2 (CN2-1) setting 1	0000h	
1103	PTA004	*HDI22	DI2 (CN2-1) setting 2	0000h	
1104	PTA005	*HDI31	DI3 (CN2-14) setting 1	0000h	
1105	PTA006	*HDI32	DI3 (CN2-14) setting 2	0000h	
1106	PTA007	*HDI41	DI4 (CN2-2) setting 1	0000h	
1107	PTA008	*HDI42	DI4 (CN2-2) setting 2	0000h	
1108	PTA009	*HDI51	DI5 (CN2-15) setting 1	0000h	
1109	PTA010	*HDI52	DI5 (CN2-15) setting 2	0000h	
110A	PTA011	*HDI61	DI6 (CN2-3) setting 1	0000h	
110B	PTA012	*HDI62	DI6 (CN2-3) setting 2	0000h	
110C	PTA013	*HDI71	DI7 (CN2-16) setting 1	0000h	
110D	PTA014	*HDI72	DI7 (CN2-16) setting 2	0000h	
110E	PTA015	*HDI81	DI8 (CN2-4) setting 1	0000h	
110F	PTA016	*HDI82	DI8 (CN2-4) setting 2	0000h	
1110	PTA017	*HDI91	DI9 (CN2-17) setting 1	0000h	
1111	PTA018	*HDI92	DI9 (CN2-17) setting 2	0000h	
1112	PTA019	*HDI A1	DI10 (CN2-5) setting 1	0000h	
1113	PTA020	*HDI A2	DI10 (CN2-5) setting 2	0000h	
1114	PTA021	*HDI B1	DI11 (CN2-18) setting 1	0000h	
1115	PTA022	*HDI B2	DI11 (CN2-18) setting 2	0000h	
1116	PTA023	*HDI C1	DI12 (CN2-6) setting 1	0000h	
1117	PTA024	*HDI C2	DI12 (CN2-6) setting 2	0000h	
1118	PTA025		For manufacturer setting	0000h	
1119	PTA026			0003h	
111A	PTA027	*HDO11	DO1 (CN2-20) setting 1	0000h	
111B	PTA028	*HDO12	DO1 (CN2-20) setting 2	0000h	
111C	PTA029	*HDO21	DO2 (CN2-8) setting 1	0000h	
111D	PTA030	*HDO22	DO2 (CN2-8) setting 2	0000h	
111E	PTA031		For manufacturer setting	0000h	
111F	PTA032	*AOP1	Function selection A-1	0000h	
1120	PTA033	*LO1	Level output function - Setting group 1 - Detailed setting 1	0000h	
1121	PTA034	LONL1	Level output function - Setting group 1 - Lower limit setting - Lower	0000h	
1122	PTA035	LONH1	Level output function - Setting group 1 - Lower limit setting - Upper	0000h	
1123	PTA036	LOFL1	Level output function - Setting group 1 - Upper limit setting - Lower	0000h	
1124	PTA037	LOFH1	Level output function - Setting group 1 - Upper limit setting - Upper	0000h	
1125	PTA038	*LO2	Level output function - Setting group 2 - Detailed setting 1	0000h	
1126	PTA039	LONL2	Level output function - Setting group 2 - Lower limit setting - Lower	0000h	
1127	PTA040	LONH2	Level output function - Setting group 2 - Lower limit setting - Upper	0000h	
1128	PTA041	LOFL2	Level output function - Setting group 2 - Upper limit setting - Lower	0000h	
1129	PTA042	LOFH2	Level output function - Setting group 2 - Upper limit setting - Upper	0000h	
112A	PTA043		For manufacturer setting	0000h	
112B	PTA044			0000h	
:	:			:	
117F	PTA128			0000h	

11. PARAMETERS

(2) Sensing I/O module parameters

Parameter No.	Sensing module Parameter No.	Symbol	Name	Initial Value	Units
1180	PTB001	*IDI11	DI1 (CN1-10) setting 1	0000h	
1181	PTB002	*IDI12	DI1 (CN1-10) setting 2	0000h	
1182	PTB003	*IDI21	DI2 (CN1-1) setting 1	0000h	
1183	PTB004	*IDI22	DI2 (CN1-1) setting 2	0000h	
1184	PTB005	*IDI31	DI3 (CN1-11) setting 1	0000h	
1185	PTB006	*IDI32	DI3 (CN1-11) setting 2	0000h	
1186	PTB007	*IDI41	DI4 (CN1-2) setting 1	0000h	
1187	PTB008	*IDI42	DI4 (CN1-2) setting 2	0000h	
1188	PTB009	*IDI51	DI5 (CN1-12) setting 1	0000h	
1189	PTB010	*IDI52	DI5 (CN1-12) setting 2	0000h	
118A	PTB011	*IDI61	DI6 (CN1-3) setting 1	0000h	
118B	PTB012	*IDI62	DI6 (CN1-3) setting 2	0000h	
118C	PTB013	*IDI71	DI7 (CN1-13) setting 1	0000h	
118D	PTB014	*IDI72	DI7 (CN1-13) setting 2	0000h	
118E	PTB015	*IDI81	DI8 (CN1-4) setting 1	0000h	
118F	PTB016	*IDI82	DI8 (CN1-4) setting 2	0000h	
1190	PTB017	*IDI91	DI9 (CN1-14) setting 1	0000h	
1191	PTB018	*IDI92	DI9 (CN1-14) setting 2	0000h	
1192	PTB019	*IDIA1	DI10 (CN1-5) setting 1	0000h	
1193	PTB020	*IDIA2	DI10 (CN1-5) setting 2	0000h	
1194	PTB021	*IDIB1	DI11 (CN1-15) setting 1	0000h	
1195	PTB022	*IDIB2	DI11 (CN1-15) setting 2	0000h	
1196	PTB023	*IDIC1	DI12 (CN1-6) setting 1	0000h	
1197	PTB024	*IDIC2	DI12 (CN1-6) setting 2	0000h	
1198	PTB025	*IDID1	DI13 (CN1-16) setting 1	0000h	
1199	PTB026	*IDID2	DI13 (CN1-16) setting 2	0000h	
119A	PTB027	*IDIE1	DI14 (CN1-7) setting 1	0000h	
119B	PTB028	*IDIE2	DI14 (CN1-7) setting 2	0000h	
119C	PTB029	*IDIF1	DI15 (CN1-17) setting 1	0000h	
119D	PTB030	*IDIF2	DI15 (CN1-17) setting 2	0000h	
119E	PTB031	*IDIG1	DI16 (CN1-8) setting 1	0000h	
119F	PTB032	*IDIG2	DI16 (CN1-8) setting 2	0000h	
11A0	PTB033		For manufacturer setting	0000h	
11A1	PTB034			0003h	
11A2	PTB035			0000h	
11A3	PTB036			0000h	
11A4	PTB037	*IDO11	DO1 (CN2-11) setting 1	0000h	
11A5	PTB038	*IDO12	DO1 (CN2-11) setting 2	0000h	
11A6	PTB039	*IDO21	DO2 (CN2-1) setting 1	0000h	
11A7	PTB040	*IDO22	DO2 (CN2-1) setting 2	0000h	
11A8	PTB041	*IDO31	DO3 (CN2-12) setting 1	0000h	
11A9	PTB042	*IDO32	DO3 (CN2-12) setting 2	0000h	
11AA	PTB043	*IDO41	DO4 (CN2-2) setting 1	0000h	
11AB	PTB044	*IDO42	DO4 (CN2-2) setting 2	0000h	
11AC	PTB045	*IDO51	DO5 (CN2-13) setting 1	0000h	
11AD	PTB046	*IDO52	DO5 (CN2-13) setting 2	0000h	
11AE	PTB047	*IDO61	DO6 (CN2-3) setting 1	0000h	
11AF	PTB048	*IDO62	DO6 (CN2-3) setting 2	0000h	

11. PARAMETERS

Parameter No.	Sensing module Parameter No.	Symbol	Name	Initial Value	Units
11B0	PTB049	*IDO71	DO7 (CN2-14) setting 1	0000h	
11B1	PTB050	*IDO72	DO7 (CN2-14) setting 2	0000h	
11B2	PTB051	*IDO81	DO8 (CN2-4) setting 1	0000h	
11B3	PTB052	*IDO82	DO8 (CN2-4) setting 2	0000h	
11B4	PTB053	*IDO91	DO9 (CN2-15) setting 1	0000h	
11B5	PTB054	*IDO92	DO9 (CN2-15) setting 2	0000h	
11B6	PTB055	*IDOA1	DO10 (CN2-5) setting 1	0000h	
11B7	PTB056	*IDOA2	DO10 (CN2-5) setting 2	0000h	
11B8	PTB057	*IDOB1	DO11 (CN2-16) setting 1	0000h	
11B9	PTB058	*IDOB2	DO11 (CN2-16) setting 2	0000h	
11BA	PTB059	*IDOC1	DO12 (CN2-6) setting 1	0000h	
11BB	PTB060	*IDOC2	DO12 (CN2-6) setting 2	0000h	
11BC	PTB061	*IDOD1	DO13 (CN2-17) setting 1	0000h	
11BD	PTB062	*IDOD2	DO13 (CN2-17) setting 2	0000h	
11BE	PTB063	*IDOE1	DO14 (CN2-7) setting 1	0000h	
11BF	PTB064	*IDOE2	DO14 (CN2-7) setting 2	0000h	
11C0	PTB065	*IDOF1	DO15 (CN2-18) setting 1	0000h	
11C1	PTB066	*IDOF2	DO15 (CN2-18) setting 2	0000h	
11C2	PTB067	*IDOG1	DO16 (CN2-8) setting 1	0000h	
11C3	PTB068	*IDOG2	DO16 (CN2-8) setting 2	0000h	
11C4	PTB069		For manufacturer setting	0000h	
11C5	PTB070			0000h	
11C6	PTB071			0000h	
11C7	PTB072			0000h	
11C8	PTB073	*ILO1	Level output function - Setting group 1 - Detailed setting 1	0000h	
11C9	PTB074	ILONL1	Level output function - Setting group 1 - Lower limit setting - Lower	0000h	
11CA	PTB075	ILONH1	Level output function - Setting group 1 - Lower limit setting - Upper	0000h	
11CB	PTB076	ILOFL1	Level output function - Setting group 1 - Upper limit setting - Lower	0000h	
11CC	PTB077	ILOFH1	Level output function - Setting group 1 - Upper limit setting - Upper	0000h	
11CD	PTB078	*ILO2	Level output function - Setting group 2 - Detailed setting 1	0000h	
11CE	PTB079	ILONL2	Level output function - Setting group 2 - Lower limit setting - Lower	0000h	
11CF	PTB080	ILONH2	Level output function - Setting group 2 - Lower limit setting - Upper	0000h	
11D0	PTB081	ILOFL2	Level output function - Setting group 2 - Upper limit setting - Lower	0000h	
11D1	PTB082	ILOFH2	Level output function - Setting group 2 - Upper limit setting - Upper	0000h	
11D2	PTB083	*ILO3	Level output function - Setting group 3 - Detailed setting 1	0000h	
11D3	PTB084	ILONL3	Level output function - Setting group 3 - Lower limit setting - Lower	0000h	
11D4	PTB085	ILONH3	Level output function - Setting group 3 - Lower limit setting - Upper	0000h	
11D5	PTB086	ILOFL3	Level output function - Setting group 3 - Upper limit setting - Lower	0000h	
11D6	PTB087	ILOFH3	Level output function - Setting group 3 - Upper limit setting - Upper	0000h	
11D7	PTB088	*ILO4	Level output function - Setting group 4 - Detailed setting 1	0000h	
11D8	PTB089	ILONL4	Level output function - Setting group 4 - Lower limit setting - Lower	0000h	
11D9	PTB090	ILONH4	Level output function - Setting group 4 - Lower limit setting - Upper	0000h	
11DA	PTB091	ILOFL4	Level output function - Setting group 4 - Upper limit setting - Lower	0000h	
11DB	PTB092	ILOFH4	Level output function - Setting group 4 - Upper limit setting - Upper	0000h	
11DC	PTB093	*ILO5	Level output function - Setting group 5 - Detailed setting 1	0000h	
11DD	PTB094	ILONL5	Level output function - Setting group 5 - Lower limit setting - Lower	0000h	
11DE	PTB095	ILONH5	Level output function - Setting group 5 - Lower limit setting - Upper	0000h	
11DF	PTB096	ILOFL5	Level output function - Setting group 5 - Upper limit setting - Lower	0000h	
11E0	PTB097	ILOFH5	Level output function - Setting group 5 - Upper limit setting - Upper	0000h	

11. PARAMETERS

Parameter No.	Sensing module Parameter No.	Symbol	Name	Initial Value	Units
11E1	PTB098	*ILO6	Level output function - Setting group 6 - Detailed setting 1	0000h	
11E2	PTB099	ILONL6	Level output function - Setting group 6 - Lower limit setting - Lower	0000h	
11E3	PTB100	ILONH6	Level output function - Setting group 6 - Lower limit setting - Upper	0000h	
11E4	PTB101	ILOFL6	Level output function - Setting group 6 - Upper limit setting - Lower	0000h	
11E5	PTB102	ILOFH6	Level output function - Setting group 6 - Upper limit setting - Upper	0000h	
11E6	PTB103	*ILO7	Level output function - Setting group 7 - Detailed setting 1	0000h	
11E7	PTB104	ILONL7	Level output function - Setting group 7 - Lower limit setting - Lower	0000h	
11E8	PTB105	ILONH7	Level output function - Setting group 7 - Lower limit setting - Upper	0000h	
11E9	PTB106	ILOFL7	Level output function - Setting group 7 - Upper limit setting - Lower	0000h	
11EA	PTB107	ILOFH7	Level output function - Setting group 7 - Upper limit setting - Upper	0000h	
11EB	PTB108	*ILO8	Level output function - Setting group 8 - Detailed setting 1	0000h	
11EC	PTB109	ILONL8	Level output function - Setting group 8 - Lower limit setting - Lower	0000h	
11ED	PTB110	ILONH8	Level output function - Setting group 8 - Lower limit setting - Upper	0000h	
11EE	PTB111	ILOFL8	Level output function - Setting group 8 - Upper limit setting - Lower	0000h	
11EF	PTB112	ILOFH8	Level output function - Setting group 8 - Upper limit setting - Upper	0000h	
11F0	PTB113		For manufacturer setting	0000h	
11F1	PTB114			0000h	
:	:			:	
127F	PTB256			0000h	

11. PARAMETERS

(3) Sensing pulse I/O module parameters

Parameter No.	Sensing module Parameter No.	Symbol	Name	Initial Value	Units
1280	PTC001	*PSFA	A-axis setting	0000h	
1281	PTC002	*PIFA1	A-axis input function setting 1	0000h	
1282	PTC003	*PIFA2	A-axis input function setting 2	0000h	
1283	PTC004	*POFA1	A-axis output function selection 1	0000h	
1284	PTC005	*POFA2	A-axis output function selection 2	0000h	
1285	PTC006		For manufacturer setting	0000h	
1286	PTC007	*CMXA	A-axis input-side electronic gear setting	0000h	
1287	PTC008	*CDVA	A-axis output-side electronic gear setting	0000h	
1288	PTC009		For manufacturer setting	0000h	
1289	PTC010			0000h	
128A	PTC011			0000h	
128B	PTC012			0000h	
128C	PTC013			0000h	
128D	PTC014			0000h	
128E	PTC015			0000h	
128F	PTC016			0000h	
1290	PTC017	*PFSB	B-axis setting	0000h	
1291	PTC018	*PIFB1	B-axis input function setting 1	0000h	
1292	PTC019	*PIFB2	B-axis input function setting 2	0000h	
1293	PTC020	*POFB1	B-axis output function selection 1	0000h	
1294	PTC021	*POFB2	B-axis output function selection 2	0000h	
1295	PTC022		For manufacturer setting	0000h	
1296	PTC023	*CMXB	B-axis input-side electronic gear setting	0000h	
1297	PTC024	*CDVB	B-axis output-side electronic gear setting	0000h	
1298	PTC025		For manufacturer setting	0000h	
1299	PTC026			0000h	
129A	PTC027			0000h	
129B	PTC028			0000h	
129C	PTC029			0000h	
129D	PTC030			0000h	
129E	PTC031			0000h	
129F	PTC032			0000h	
12A0	PTC033	*IDI1A1	DI1A (CN1-8) setting 1	0000h	
12A1	PTC034		For manufacturer setting	0000h	
12A2	PTC035	*IDI2A1	DI2A (CN1-10) setting 1	0000h	
12A3	PTC036		For manufacturer setting	0000h	
12A4	PTC037	*IDI3A1	DI3A (CN1-7) setting 1	0000h	
12A5	PTC038		For manufacturer setting	0000h	
12A6	PTC039	*IDI4A1	DI4A (CN1-9) setting 1	0000h	
12A7	PTC040		For manufacturer setting	0000h	
12A8	PTC041	*IDI5A1	DI5A (CN1-19) setting 1	0000h	
12A9	PTC042		For manufacturer setting	0000h	
12AA	PTC043	*IDI6A1	DI6A (CN1-20) setting 1	0000h	
12AB	PTC044		For manufacturer setting	0000h	
12AC	PTC045	*IDI7A1	DI7A (CN1-21) setting 1	0000h	
12AD	PTC046		For manufacturer setting	0000h	
12AE	PTC047	*IDI1B1	DI1B (CN2-8) setting 1	0000h	
12AF	PTC048		For manufacturer setting	0000h	

11. PARAMETERS

Parameter No.	Sensing module Parameter No.	Symbol	Name	Initial Value	Units
12B0	PTC049	*IDI2B1	DI2B (CN2-10) setting 1	0000h	
12B1	PTC050		For manufacturer setting	0000h	
12B2	PTC051	*IDI3B1	DI3B (CN2-7) setting 1	0000h	
12B3	PTC052		For manufacturer setting	0000h	
12B4	PTC053	*IDI4B1	DI4B (CN2-9) setting 1	0000h	
12B5	PTC054		For manufacturer setting	0000h	
12B6	PTC055	*IDI5B1	DI5B (CN2-19) setting 1	0000h	
12B7	PTC056		For manufacturer setting	0000h	
12B8	PTC057	*IDI6B1	DI6B (CN2-20) setting 1	0000h	
12B9	PTC058		For manufacturer setting	0000h	
12BA	PTC059	*IDI7B1	DI7B (CN2-21) setting 1	0000h	
12BB	PTC060		For manufacturer setting	0000h	
12BC	PTC061			0000h	
12BD	PTC062			0003h	
12BE	PTC063			0000h	
12BF	PTC064			0000h	
12C0	PTC065	*IDO1A1	DO1A (CN1-11) setting 1	0000h	
12C1	PTC066	*IDO1A2	DO1A (CN1-11) setting 2	0000h	
12C2	PTC067	*IDO2A1	DO2A (CN1-12) setting 1	0000h	
12C3	PTC068	*IDO2A2	DO2A (CN1-12) setting 2	0000h	
12C4	PTC069	*IDO3A1	DO3A (CN1-23) setting 1	0000h	
12C5	PTC070	*IDO3A2	DO3A (CN1-23) setting 2	0000h	
12C6	PTC071	*IDO4A1	DO4A (CN1-1) setting 1	0000h	
12C7	PTC072	*IDO4A2	DO4A (CN1-1) setting 2	0000h	
12C8	PTC073	*IDO5A1	DO5A (CN1-13) setting 1	0000h	
12C9	PTC074	*IDO5A2	DO5A (CN1-13) setting 2	0000h	
12CA	PTC075	*IDO1B1	DO1B (CN2-11) setting 1	0000h	
12CB	PTC076	*IDO1B2	DO1B (CN2-11) setting 2	0000h	
12CC	PTC077	*IDO2B1	DO2B (CN2-12) setting 1	0000h	
12CD	PTC078	*IDO2B2	DO2B (CN2-12) setting 2	0000h	
12CE	PTC079	*IDO3B1	DO3B (CN2-23) setting 1	0000h	
12CF	PTC080	*IDO3B2	DO3B (CN2-23) setting 2	0000h	
12D0	PTC081	*IDO4B1	DO4B (CN2-1) setting 1	0000h	
12D1	PTC082	*IDO4B2	DO4B (CN2-1) setting 2	0000h	
12D2	PTC083	*IDO5B1	DO5B (CN2-13) setting 1	0000h	
12D3	PTC084	*IDO5B2	DO5B (CN2-13) setting 2	0000h	
12D4	PTC085		For manufacturer setting	0000h	
12D5	PTC086			0000h	
:	:			:	
12FF	PTC128			0000h	

11. PARAMETERS

(4) Sensing analog I/O module parameters

Parameter No.	Sensing module Parameter No.	Symbol	Name	Initial Value	Units
1300	PTD001	*AIF1	Analog input function selection 1	0000h	
1301	PTD002	*AI1F2	Analog input ch. 1 - Function selection 2	0000h	
1302	PTD003	*AI1FT	Analog input ch. 1 - Primary delay filter time constant	0	ms
1303	PTD004	AI1OF	Analog input ch. 1 - Offset voltage setting	0	mV
1304	PTD005	*AI1SH	Analog input ch. 1 - Scaling function - Upper limit setting	20000	
1305	PTD006	*AI1SL	Analog input ch. 1 - Scaling function - Lower limit setting	-20000	
1306	PTD007	*AI1SF	Analog input ch. 1 - Scaling function - Shift amount setting	0	
1307	PTD008		For manufacturer setting	0000h	
1308	PTD009			0000h	
1309	PTD010	*AI2F2	Analog input ch. 2 - Function selection 2	0000h	
130A	PTD011	*AI2FT	Analog input ch. 2 - Primary delay filter time constant	0	ms
130B	PTD012	AI2OF	Analog input ch. 2 - Offset voltage setting	0	mV
130C	PTD013	*AI2SH	Analog input ch. 2 - Scaling function - Upper limit setting	20000	
130D	PTD014	*AI2SL	Analog input ch. 2 - Scaling function - Lower limit setting	-20000	
130E	PTD015	*AI2SF	Analog input ch. 2 - Scaling function - Shift amount setting	0	
130F	PTD016		For manufacturer setting	0000h	
1310	PTD017			0000h	
1311	PTD018	*AI3F2	Analog input ch. 3 - Function selection 2	0000h	
1312	PTD019	*AI3FT	Analog input ch. 3 - Primary delay filter time constant	0	ms
1313	PTD020	AI3OF	Analog input ch. 3 - Offset voltage setting	0	mV
1314	PTD021	*AI3SH	Analog input ch. 3 - Scaling function - Upper limit setting	20000	
1315	PTD022	*AI3SL	Analog input ch. 3 - Scaling function - Lower limit setting	-20000	
1316	PTD023	*AI3SF	Analog input ch. 3 - Scaling function - Shift amount setting	0	
1317	PTD024		For manufacturer setting	0000h	
1318	PTD025			0000h	
1319	PTD026	*AI4F2	Analog input ch. 4 - Function selection 2	0000h	
131A	PTD027	*AI4FT	Analog input ch. 4 - Primary delay filter time constant	0	ms
131B	PTD028	AI4OF	Analog input ch. 4 - Offset voltage setting	0	mV
131C	PTD029	*AI4SH	Analog input ch. 4 - Scaling function - Upper limit setting	20000	
131D	PTD030	*AI4SL	Analog input ch. 4 - Scaling function - Lower limit setting	-20000	
131E	PTD031	*AI4SF	Analog input ch. 4 - Scaling function - Shift amount setting	0	
131F	PTD032		For manufacturer setting	0000h	
1320	PTD033			0000h	
1321	PTD034	AO1OF	Analog output ch. 1 - Offset	0	mV
1322	PTD035	*AO1SH	Analog output ch. 1 - Scaling function - Upper limit setting	20000	
1323	PTD036	*AO1SL	Analog output ch. 1 - Scaling function - Lower limit setting	-20000	
1324	PTD037	*AO1SF	Analog output ch. 1 - Scaling function - Shift amount setting	0	
1325	PTD038		For manufacturer setting	0000h	
1326	PTD039			0000h	
1327	PTD040			0000h	
1328	PTD041			0000h	
1329	PTD042	AO2OF	Analog output ch. 2 - Offset	0	mV
132A	PTD043	*AO2SH	Analog output ch. 2 - Scaling function - Upper limit setting	20000	
132B	PTD044	*AO2SL	Analog output ch. 2 - Scaling function - Lower limit setting	-20000	
132C	PTD045	*AO2SF	Analog output ch. 2 - Scaling function - Shift amount setting	0	

11. PARAMETERS

Parameter No.	Sensing module Parameter No.	Symbol	Name	Initial Value	Units
132D	PTD046	/	For manufacturer setting	0000h	/
132E	PTD047			0000h	
132F	PTD048			0000h	
1330	PTD049			0000h	
1331	PTD050	AO3OF	Analog output ch. 3 - Offset	0	mV
1332	PTD051	*AO3SH	Analog output ch. 3 - Scaling function - Upper limit setting	20000	
1333	PTD052	*AO3SL	Analog output ch. 3 - Scaling function - Lower limit setting	-20000	
1334	PTD053	*AO3SF	Analog output ch. 3 - Scaling function - Shift amount setting	0	
1335	PTD054	/	For manufacturer setting	0000h	/
1336	PTD055			0000h	
1337	PTD056			0000h	
1338	PTD057			0000h	
1339	PTD058	AO4OF	Analog output ch. 4 - Offset	0	mV
133A	PTD059	*AO4SH	Analog output ch. 4 - Scaling function - Upper limit setting	20000	
133B	PTD060	*AO4SL	Analog output ch. 4 - Scaling function - Lower limit setting	-20000	
133C	PTD061	*AO4SF	Analog output ch. 4 - Scaling function - Shift amount setting	0	
133D	PTD062	/	For manufacturer setting	0000h	/
133E	PTD063			0000h	
133F	PTD064			0000h	
1340	PTD065	*AIAVF	Analog input averaging - Signal selection	0000h	
1341	PTD066		For manufacturer setting	0000h	
1342	PTD067	*AIAV1C1	Analog input average 1 - Ch. 1 weighting	1	
1343	PTD068	*AIAV1C2	Analog input average 1 - Ch. 2 weighting	1	
1344	PTD069	*AIAV1C3	Analog input average 1 - Ch. 3 weighting	1	
1345	PTD070	*AIAV1C4	Analog input average 1 - Ch. 4 weighting	1	
1346	PTD071	*AIAV2C1	Analog input average 2 - Ch. 1 weighting	1	
1347	PTD072	*AIAV2C2	Analog input average 2 - Ch. 2 weighting	1	
1348	PTD073	*AIAV2C3	Analog input average 2 - Ch. 3 weighting	1	
1349	PTD074	*AIAV2C4	Analog input average 2 - Ch. 4 weighting	1	
134A	PTD075	/	For manufacturer setting	0000h	/
134B	PTD076			0000h	
:	:			:	
137F	PTD128			0000h	

11. PARAMETERS

(5) Sensing encoder I/F module parameters

Parameter No.	Sensing module Parameter No.	Symbol	Name	Initial Value	Units
1380	PTE001		For manufacturer setting	0003h	
1381	PTE002			0000h	
1382	PTE003			0000h	
1383	PTE004			0000h	
1384	PTE005			0000h	
1385	PTE006			0000h	
1386	PTE007			0000h	
1387	PTE008			0000h	
1388	PTE009	**ENCA	Ch. A function selection	0000h	
1389	PTE010		For manufacturer setting	0000h	
138A	PTE011			0000h	
138B	PTE012			0000h	
138C	PTE013			0000h	
138D	PTE014			0000h	
138E	PTE015			0000h	
138F	PTE016			0000h	
1390	PTE017			0000h	
1391	PTE018			0000h	
1392	PTE019			0000h	
1393	PTE020			0000h	
1394	PTE021			0000h	
1395	PTE022			0000h	
1396	PTE023			0000h	
1397	PTE024			0000h	
1398	PTE025			0000h	
1399	PTE026			0000h	
139A	PTE027			0000h	
139B	PTE028			0000h	
139C	PTE029			0000h	
139D	PTE030			0000h	
139E	PTE031			0000h	
139F	PTE032			0000h	
13A0	PTE033			0000h	
13A1	PTE034			0000h	
13A2	PTE035			0000h	
13A3	PTE036			0000h	
13A4	PTE037			**SECA1	
13A5	PTE038	**SECA2	SSI - Ch. A function setting 2	0000h	
13A6	PTE039	**SECA3	SSI - Ch. A function setting 3	0000h	
13A7	PTE040	**SECA4	SSI - Ch. A function setting 4	0000h	
13A8	PTE041	**SECA5	SSI - Ch. A function setting 5	0000h	
13A9	PTE042	**SECA6	SSI - Ch. A function setting 6	0000h	
13AA	PTE043	**SDPLA	Ch. A position variation error threshold - Lower	0000h	
13AB	PTE044	**SDPHA	Ch. A position variation error threshold - Upper	0000h	
13AC	PTE045		For manufacturer setting	0000h	
13AD	PTE046			0000h	
13AE	PTE047			0000h	
13AF	PTE048			0000h	

11. PARAMETERS

Parameter No.	Sensing module Parameter No.	Symbol	Name	Initial Value	Units
13B0	PTE049		For manufacturer setting	0000h	
13B1	PTE050			0000h	
13B2	PTE051			0000h	
13B3	PTE052			0000h	
13B4	PTE053			0000h	
13B5	PTE054			0000h	
13B6	PTE055			0000h	
13B7	PTE056			0000h	
13B8	PTE057			0000h	
13B9	PTE058			0000h	
13BA	PTE059			0000h	
13BB	PTE060			0000h	
13BC	PTE061			0000h	
13BD	PTE062			0000h	
13BE	PTE063			0000h	
13BF	PTE064	0000h			
13C0	PTE065	**ENCB	Ch. B function selection	0000h	
13C1	PTE066		For manufacturer setting	0000h	
13C2	PTE067			0000h	
13C3	PTE068			0000h	
13C4	PTE069			0000h	
13C5	PTE070			0000h	
13C6	PTE071			0000h	
13C7	PTE072			0000h	
13C8	PTE073			0000h	
13C9	PTE074			0000h	
13CA	PTE075			0000h	
13CB	PTE076			0000h	
13CC	PTE077			0000h	
13CD	PTE078			0000h	
13CE	PTE079			0000h	
13CF	PTE080			0000h	
13D0	PTE081			0000h	
13D1	PTE082			0000h	
13D2	PTE083			0000h	
13D3	PTE084			0000h	
13D4	PTE085			0000h	
13D5	PTE086			0000h	
13D6	PTE087	0000h			
13D7	PTE088	0000h			
13D8	PTE089	0000h			
13D9	PTE090	0000h			
13DA	PTE091	0000h			
13DB	PTE092	0000h			
13DC	PTE093	**SECB1	SSI - Ch. B function setting 1	2000h	
13DD	PTE094	**SECB2	SSI - Ch. B function setting 2	0000h	
13DE	PTE095	**SECB3	SSI - Ch. B function setting 3	0000h	
13DF	PTE096	**SECB4	SSI - Ch. B function setting 4	0000h	
13E0	PTE097	**SECB5	SSI - Ch. B function setting 5	0000h	

11. PARAMETERS

Parameter No.	Sensing module Parameter No.	Symbol	Name	Initial Value	Units
13E1	PTE098	**SECB6	SSI - Ch. B function setting 6	0000h	
13E2	PTE099	**SDPLB	Ch. B position variation error threshold - Lower	0000h	
13E3	PTE100	**SDPHB	Ch. B position variation error threshold - Upper	0000h	
13E4	PTE101		For manufacturer setting	0000h	
13E5	PTE102			0000h	
:	:			:	
13FF	PTE128			0000h	

11. PARAMETERS

11.5 RIO control parameters

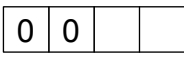
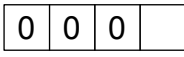
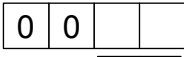
Parameter No.	Abbreviation	Name	Initial value	Units	Setting range	Function
0200	*OPC1	Control option 1	0000h		0000h to 0011h	 <p>Control station Set to 1 for implementing control of a remote I/O module. 0: Not controlled 1: Controlled</p> <p>Remote I/O disconnect Set to 1 when remote I/O communication is not implemented. When set to 1 together with the control station, it is possible to run without a remote I/O (simulate). 0: Invalid 1: Valid</p>
0201	OPC2	Control option 2	0000h		0000h to 0001h	 <p>RI control at communication error Set input device control at communication error(system error E401 to E407) 0: All points OFF 1: Maintain status</p>
0202	*UTALC	Station No. assignment	0000h		0000h to 001Fh	 <p>Remote I/O station No. Set the remote I/O station No. to be assigned to the station No. on the Q173SCCF. 00h : No station No. assignment 15h to 18h : Station No. Example) 16h: Remote I/O No. 22</p>
0203	ITM	Interrupt condition	0000h		0000h to FFFFh	Set interrupt condition.
0204		For manufacturer setting	0			
0205			0			
0206			0			
0207			0			
0208			0			
0209			0			
020A			0			
020B			0			
020C			0			
020D			0			
020E			0			
020F			0			

11. PARAMETERS

Parameter No.	Abbreviation	Name	Initial value	Units	Setting range	Function
0210	*BDIO	Input bit device points	0000h		0000h to 0200h	Set the points used for input bit device. 0000h to 0200h: 0 to 512 Note. Only a multiple of 16 can be selected.
0211	*BDINA	Input bit device start number	0000h		0000h to 0FF0h	Set the start of the input bit device number assigned to RX. 0000h to 0FF0h: 0 to 4080 Note. Only a multiple of 16 can be selected. Example: When the input points are 64, and input bit device 020 is specified as the start, assign the 64 points of DVI_020 to DVI_05F.
0212	*WDIO	Input word device points	0000h		0000h to 0020h	Set the points used for input word device. 0000h to 0020h: 0 to 32 Note. The size used is 1 word × set value.
0213	*WDINA	Input word device start number	0000h		0000h to 00FFh	Set the start of the input word device number assigned to RWr. 0000h to 00FFh: 0 to 255 Example: When the input points are 2, and input word device 06 is specified as the start, assign input word devices 06 to 07.
0214	*BDOO	Output bit device points	0000h		0000h to 0200h	Set the points used for output bit device. 0000h to 0200h: 0 to 512 Note. Only a multiple of 16 can be selected.
0215	*BDONA	Output bit device start number	0000h		0000h to 0FF0h	Set the start of the output bit device number assigned to RY. 0000h to 0FF0h: 0 to 4080 Note. Only a multiple of 16 can be selected. Example: When the output points are 64, and output bit device 040 is specified as the start, assign the 64 points of DVO_040 to DVO_07F.
0216	*WDOO	Output word device points	0000h		0000h to 0020h	Set the points used for output word device. 0000h to 0020h: 0 to 32 Note. The size used is 1 word × set value.
0217	*WDONA	Output word device start number	0000h		0000h to 00FFh	Set the start of the output word device number assigned to RWw. 0000h to 00FFh: 0 to 255 Example: When the output points are 2, and output word device 08 is specified as the start, assign output word devices 08 to 09.
0218		For manufacturer setting	0			
0219			0			
021A			0			
021B			0			
021C			0			
021D	*VEND	Vendor ID	0000h		0000h to FFFFh	Set the vendor ID. 0000h: Mitsubishi Electric

Note. When a value other than a multiple of 16 is set to parameters where only a multiple of 16 can be set, a parameter error (RIO control alarm 37, detail 01) occurs at system startup.

11. PARAMETERS

Parameter No.	Abbreviation	Name	Initial value	Units	Setting range	Function
021E	*CODE	Type code	3000h		0000h to FFFFh	Set the type code. 3000h: SSCNETⅢ/H head module 3010h: Sensing SSCNETⅢ/H head module 3011h: Sensing SSCNETⅢ/H head module+Sensing I/O module 3012h: Sensing SSCNETⅢ/H head module+Sensing pulse I/O module 3013h: Sensing SSCNETⅢ/H head module+Sensing analog I/O module 3014h: Sensing SSCNETⅢ/H head module+Sensing encoder I/F module 3021h: Sensing I/O module 3022h: Sensing pulse I/O module 3023h: Sensing analog I/O module 3024h: Sensing encoder I/F module
021F		For manufacturer setting	0			
0220			0			
0221			0			
0222			0			
0223			0			
0224			0			
0225			0			
0226			0			
0227			0			
0228			0			
0229			0			
022A			0			
022B			0			
022C			0			
022D			0			
022E			0			
022F			0			
0230			0			
0231			0			
0232			0			
0233			0			
0234			0			
0235			0			
0236			0			
0237		0				
0238		0				
0239		0				
023A		0				
023B		0				
023C		0				
023D		0				
023E		0				
023F		0				

12. MONITOR NUMBER

12. MONITOR NUMBER

12.1 Servo information (1)

Monitor No.	Content	Units	Remarks
0100	Unit type name		Hexadecimal ASCII character string (2 Characters per monitor number)
0101			
0102			
0103			
0104			
0105			
0106			
0107	Software number		Hexadecimal ASCII character string (2 Characters per monitor number)
0108			
0109			
010A			
010B			
010C			
010D			
010E	Type code		1000h: MR-J4(W□)-□B 1200h: MR-JE-□B
0110			
0111	Vendor ID		0000h: Mitsubishi Electric
0112	Motor rated revolution speed	r/min	
0113	Motor rated current	0.1%	
0114	Motor maximum revolution speed	r/min	
0115	Motor maximum torque	0.1%	
0116	Number of encoder pulses per revolution (lower)	pulse	
0117	Number of encoder pulses per revolution (upper)		
0118	Reserved		
0119	Initial within 1 revolution position (lower)	pulse	
011A	Initial within 1 revolution position (upper)		
011B	Initial multiple revolution data	rev	
011C	Reserved		
011D			
011E			
011F			
0120	Motor permissible pulse rate (lower)	kpps	Pulse rate of operation at the motor maximum revolution speed.
0121	Motor permissible pulse rate (upper)		
0122	Maximum output pulse rate (lower)	kpps	Maximum pulse rate that can be output by the Q173SCCF.
0123	Maximum output pulse rate (upper)		
0124	Reserved		
0125			
0126			

12. MONITOR NUMBER

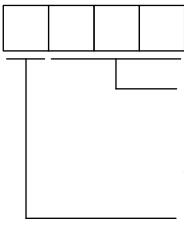
Monitor No.	Content	Units	Remarks
0127	Station No. in order of connection		 <p>Station No. in order of connection on line Indicates the place where the station is connected from the Q173SCCF. Axes and stations are both included in the connection order. Line No. 0: Line 1 Example. Monitor value for the axis connected fifth on line 1: 0005h</p>
0128	Reserved		
0129			
012A			
012B			
012C			
012D			
012E			
012F			

12. MONITOR NUMBER

12.2 Servo information (2)

Monitor No.	Content	Units	Remarks
0200	Position feedback (lower)	pulse	
0201	Position feedback (upper)		
0202	Reserved		
0203			
0204	Position droop (lower)	pulse	
0205	Position droop (upper)		
0206	Reserved		
0207			
0208	Speed feedback (lower)	0.01r/min	
0209	Speed feedback (upper)		
020A	Electrical current command	0.1%	
020B	Electrical current feedback	0.1%	
020C	Reserved		
020D			
020E	Detector within 1 revolution position (lower)	pulse	
020F	Detector within 1 revolution position (upper)		
0210	Home position within 1 revolution position (lower)	pulse	
0211	Home position within 1 revolution position (upper)		
0212	ZCT (lower)	pulse	
0213	ZCT (upper)		
0214	Multiple revolution counter	rev	
0215	Home position multiple revolution data	rev	
0216	Speed command (lower)	0.01r/min	0.01mm/s for linear servo motor
0217	Speed command (upper)		
0218	Reserved		
0219			
021A			
021B			
021C			
021D			
021E			
021F			

12. MONITOR NUMBER

Monitor No.	Content	Units	Remarks
0220			
0221			
0222			
0223			
0224			
0225			
0226			
0227			
0228			
0229			
022A			
022B			
022C			
022D			
022E			
022F	Reserved		
0230			
0231			
0232			
0233			
0234			
0235			
0236			
0237			
0238			
0239			
023A			
023B			
023C			
023D			
023E			
023F			

12. MONITOR NUMBER

Monitor No.	Content	Units	Remarks
0240	Selected droop pulse (lower)	pulse	Select in the parameter when using the fully closed loop control (motor side/load side/motor side - load side)
0241	Selected droop pulse (upper)		
0242	Reserved		
0243			
0244	Selected cumulative feed pulses (lower)	pulse	Select in the parameter when using the fully closed loop control (motor side/load side)
0245	Selected cumulative feed pulses (upper)		
0246	Load side encoder information data 1 (lower)	pulse	When using the linear servo/fully closed loop control
0247	Load side encoder information data 1 (upper)		
0248	Load side encoder information data 2 (lower)	pulse	When using the linear servo/fully closed loop control
0249	Load side encoder information data 2 (upper)		
024A	Speed feedback (lower)	0.01mm/s	When using a linear servo
024B	Speed feedback (upper)		
024C	Voltage of generating line	V	
024D	Regenerative load factor	%	
024E	Effective load factor	%	
024F	Peak load factor	%	
0250	Estimated load inertial ratio	0.1 times	
0251	Position gain (model position gain)	rad/s	
0252	Motor thermistor temperature	°C	When using a motor with thermistor attached.
0253	Reserved		
0254			
0255			
0256			
0257			
0258			
0259			
025A			
025B			
025C			
025D			
025E			
025F			
0260			
0261	Alarm/warning number		
0262	Alarm detailed bits		
0263	Reserved		
0264	Alarm status AL-1 <input type="checkbox"/>		<input type="checkbox"/> is 0 (bit 0) to F (bit 15) Bit corresponding to alarm number is turned on. Review the alarms when multiple alarms occurs simultaneously etc.
0265	Alarm status AL-2 <input type="checkbox"/>		
0266	Alarm status AL-3 <input type="checkbox"/>		
0267	Alarm status AL-4 <input type="checkbox"/>		
0268	Alarm status AL-5 <input type="checkbox"/>		
0269	Alarm status AL-6 <input type="checkbox"/>		
026A	Alarm status AL-7 <input type="checkbox"/>		
026B	Alarm status AL-8 <input type="checkbox"/>		
026C	Alarm status AL-9 <input type="checkbox"/>		
026D	Alarm status AL-E <input type="checkbox"/>		
026E	Alarm status AL-F <input type="checkbox"/>		
026F	Alarm status AL-A <input type="checkbox"/>		

12. MONITOR NUMBER

Monitor No.	Content	Units	Remarks
0270			
0271			
0272			
0273			
0274			
0275			
0276			
0277			
0278			
0279			
027A			
027B			
027C			
027D			
027E			
027F			
0280			
0281			
0282			
0283			
0284			
0285			
0286			
0287	Reserved		
0288			
0289			
028A			
028B			
028C			
028D			
028E			
028F			
0290			
0291			
0292			
0293			
0294			
0295			
0296			
0297			
0298			
0299			
029A			
029B			
029C			
029D			
029E			
029F			
02A0	Module power consumption	W	
02A1	Reserved		

12. MONITOR NUMBER

Monitor No.	Content	Units	Remarks
02A2	Module cumulative power consumption (lower)	Wh	
02A3	Module cumulative power consumption (upper)		
02A4	Reserved		
02A5			
02A6			
02A7	Internal temperature of encoder	°C	
02A8	Torques corresponding to disturbance	0.1%	Thrust corresponding to disturbance when using the linear
02A9	Instantaneous torque	0.1%	Instantaneous thrust when using the linear
02AA	Overload alarm margin	0.1%	
02AB	Error excessive alarm margin	16pulse	
02AC	Settling time	ms	
02AD	Overshoot amount	pulse	
02AE	Motor side/load side position deviation (lower)	pulse	When using the fully closed loop control
02AF	Motor side/load side position deviation (upper)		
02B0	Motor side/load side speed deviation (lower)	0.01r/min	When using the fully closed loop control
02B1	Motor side/load side speed deviation (upper)		
02B2	Module power consumption (double word) (lower)	W	
02B3	Module power consumption (double word) (upper)		
02B4	Reserved		
02B5			
02B6			
02B7			
02B8			
02B9			
02BA			
02BB			
02BC			
02BD			
02BE			
02BF			
02C0			
02C1			
02C2			
02C3			
02C4			
02C5			
02C6			
02C7			
02C8			
02C9			
02CA			
02CB			
02CC			
02CD			
02CE			
02CF			

12. MONITOR NUMBER

12.3 RIO information

Monitor No.	Content	Units	Remarks
0100	Reserved		
0101			
0102			
0103			
0104			
0105			
0106			
0107			
0108			
0109			
010A			
010B			
010C			
010D			
010E			
010F			
0110	Type code		3000h: SSCNETⅢ/H head module 3010h: Sensing SSCNETⅢ/H head module 3011h: Sensing SSCNETⅢ/H head module+Sensing I/O module 3012h: Sensing SSCNETⅢ/H head module+Sensing pulse I/O module 3013h: Sensing SSCNETⅢ/H head module+Sensing analog I/O module 3014h: Sensing SSCNETⅢ/H head module+Sensing encoder I/F module 3021h: Sensing I/O module 3022h: Sensing pulse I/O module 3023h: Sensing analog I/O module 3024h: Sensing encoder I/F module
0111	Vendor ID		0000h: Mitsubishi Electric
0112	Reserved		
0113			
0114			
0115			
0116			
0117			
0118			
0119			
011A			
011B			
011C			
011D			
011E			
011F			
0120			
0121			
0122			
0123			
0124			

12. MONITOR NUMBER

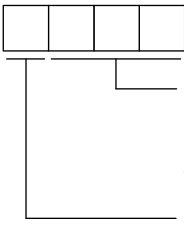
Monitor No.	Content	Units	Remarks
0125	Reserved		
0126			
0127	Station No. in order of connection		 <p>Station No. in order of connection on line Indicates the place where the station is connected from the Q173SCCF. Axes and stations are both included in the connection order. Line No. 0: Line 1 Example. Monitor value for the axis connected fifth on line 1: 0005h</p>
0128	Reserved		
0129			
012A			
012B			
012C			
012D			
012E			
012F			
0130			
0131			
0132			
0133			
0134			
0135			
0136			
0137			
0138			
0139			
013A			
013B			
013C			
013D			
013E			
013F			
0140			
0141			
0142			
0143			
0144	Number of pulses per revolution CH1 (lower)	pulse	
0145	Number of pulses per revolution CH1 (upper)		
0146	Multiple revolution counter maximum value CH1 (lower)	rev	
0147	Multiple revolution counter maximum value CH1 (upper)		
0148	Reserved		
0149			
014A			
014B			

12. MONITOR NUMBER

Monitor No.	Content	Units	Remarks
014C	Number of pulses per revolution CH2 (lower)	pulse	
014D	Number of pulses per revolution CH2 (upper)		
014E	Multiple revolution counter maximum value CH2 (lower)	rev	
014F	Multiple revolution counter maximum value CH2 (upper)		
0150	Cycle counter at power supply ON CH1	rev	
0151	Reserved		
0152			
0153	Multiple revolution counter at power supply ON CH1	rev	
0154	Reserved		
0155	Cycle counter at power supply ON CH2	rev	
0156	Reserved		
0157			
0158	Multiple revolution counter at power supply ON CH2	rev	
0159	Reserved		
015A			
015B			
015C			
015D			
015E			
015F			

12. MONITOR NUMBER

12.4 Operation information

Monitor No.	Content	Units	Remarks
0300	Current command position (lower)	Command units	Current command position prior to electronic gear processing
0301	Current command position (upper)		
0302	Current feedback position (lower)	Command units	Current feedback position prior to electronic gear processing
0303	Current feedback position (upper)		
0304	Moving speed (lower)	Speed units	Current speed output to servo amplifier
0305	Moving speed (upper)		
0306	Remaining distance to move (lower)	Command units	Distance from current command position to end point when in automatic operation
0307	Remaining distance to move (upper)		
0308	Grid size (lower)	pulse	Distance from standard position of return to home position (end of dog etc.) to the Z-phase For the home position return method which does not use the Z-phase, 0 is displayed.
0309	Grid size (upper)		
030A	Operation point No.		Value equal to operation point No. + 1 is displayed. 0 is displayed while stopped.
030B	Remaining dwell time	ms	
030C	Reserved		
030D			
030E			
030F			
0310			
0311	Current command position (upper)		
0312	Current feedback position (lower)	pulse	Current feedback position after electronic gear processing
0313	Current feedback position (upper)		
0314	F Δ T (lower)	pulse	Movement amount per control cycle
0315	F Δ T (upper)		
0316	Feedback moving speed (lower)	Speed units	The feedback speed converted from the difference of the current feedback position (after electronic gear processing)
0317	Feedback moving speed (upper)		
0318	Reserved		
0319			
031A			
031B			
031C			
031D			
031E			
031F			
0320	External signal status		bit0: LSP - bit1: LSN - bit2: DOG (Note)
0321	Reserved		
0322			
0323			
0324	Speed command (lower)	0.01r/min	Notifies the speed command during speed control.
0325	Speed command (upper)	0.01r/min	
0326	Torque command	0.1%	Notifies the torque command during torque control.
0327	Reserved		
0328			
0329			
032A			
032B			
032C			
032D			
032E			
032F			

Note. 0: I/O input signal OFF, 1: I/O input signal ON is indicated.

12. MONITOR NUMBER

Monitor No.	Content	Units	Remarks
0330	Control parameter error number No.0200 to 020F		Bit corresponding to parameter number is turned on. bit is No.0200 (bit 0) to 020F (bit 15).
0331	Control parameter error number No.0210 to 021F		Bit corresponding to parameter number is turned on. bit is No.0210 (bit 0) to 021F (bit 15).
0332	Control parameter error number No.0220 to 022F		Bit corresponding to parameter number is turned on. bit is No.0220 (bit 0) to 022F (bit 15).
0333	Control parameter error number No.0230 to 023F		Bit corresponding to parameter number is turned on. bit is No.0230 (bit 0) to 023F (bit 15).
0334	Control parameter error number No.0240 to 024F		Bit corresponding to parameter number is turned on. bit is No.0240 (bit 0) to 024F (bit 15).
0335	Control parameter error number No.0250 to 025F		Bit corresponding to parameter number is turned on. bit is No.0250 (bit 0) to 025F (bit 15).
0336	Control parameter error number No.0260 to 026F		Bit corresponding to parameter number is turned on. bit is No.0260 (bit 0) to 026F (bit 15).
0337	Control parameter error number No.0270 to 027F		Bit corresponding to parameter number is turned on. bit is No.0270 (bit 0) to 027F (bit 15).
0338	Control parameter error number No.0280 to 028F		Bit corresponding to parameter number is turned on. bit is No.0280 (bit 0) to 028F (bit 15).
0339	Control parameter error number No.0290 to 029F		Bit corresponding to parameter number is turned on. bit is No.0290 (bit 0) to 029F (bit 15).
033A	Control parameter error number No.02A0 to 02AF		Bit corresponding to parameter number is turned on. bit is No.02A0 (bit 0) to 02AF (bit 15).
033B	Control parameter error number No.02B0 to 02BF		Bit corresponding to parameter number is turned on. bit is No.02B0 (bit 0) to 02BF (bit 15).
033C	Control parameter error number No.02C0 to 02CF		Bit corresponding to parameter number is turned on. bit is No.02C0 (bit 0) to 02CF (bit 15).
033D	Control parameter error number No.02D0 to 02DF		Bit corresponding to parameter number is turned on. bit is No.02D0 (bit 0) to 02DF (bit 15).
033E	Control parameter error number No.02E0 to 02EF		Bit corresponding to parameter number is turned on. bit is No.02E0 (bit 0) to 02EF (bit 15).
033F	Control parameter error number No.02F0 to 02FF		Bit corresponding to parameter number is turned on. bit is No.02F0 (bit 0) to 02FF (bit 15).
0340	Reserved		
0341			
0342			
0343			
0344			
0345			
0346			
0347			
0348			
0349			
034A			
034B			
034C			
034D			
034E			
034F			
:			
037F			

12. MONITOR NUMBER

Monitor No.	Content	Units	Remarks
0380	Axis data command bit 1		Use these when sampling the axis data command bit. For details, refer to Section 7.12.7.
0381	Axis data command bit 2		
0382	Axis data command bit 3		
0383	Axis data command bit 4		
0384	Axis data command bit 5		
0385	Axis data command bit 6		
0386	Axis data command bit 7		
0387	Axis data command bit 8		
0388	Reserved		
0389			
038A			
038B			
038C			
038D			
038E			
038F			
0390			
:			
039F			
03A0	Axis data status bit 1		Use these when sampling the axis data status bit. For details, refer to Section 7.12.7.
03A1	Axis data status bit 2		
03A2	Axis data status bit 3		
03A3	Axis data status bit 4		
03A4	Axis data status bit 5		
03A5	Axis data status bit 6		
03A6	Axis data status bit 7		
03A7	Axis data status bit 8		
03A8	Reserved		
03A9			
03AA			
03AB			
03AC			
03AD			
03AE			
03AF			
03B0			
:			
03BF			

12. MONITOR NUMBER

12.5 Operation information (double word)

Monitor No.	Content	Units	Remarks
1300	Current command position	Command units	Command position prior to electronic gear processing
1302	Current feedback position	Command units	Current feedback position prior to electronic gear processing
1304	Moving speed	Speed units	Command speed output to servo amplifier
1306	Remaining distance to move	Command units	Distance from current command position to end point when in automatic operation
1308	Grid size	pulse	Distance from standard position of return to home position (end of dog etc.) to the Z-phase. For the home position return method which does not use the Z-phase, 0 is displayed.
130A	Reserved		
130C			
130E			
1310	Current command position	pulse	Command position after electronic gear processing
1312	Current feedback position	pulse	Current feedback position after electronic gear processing
1314	F Δ T	pulse	Movement amount per control cycle
1316	Feedback moving speed	Speed units	The feedback speed converted from the difference of the current feedback position (after electronic gear processing)
1318	Reserved		
131A			
131C			
131E			
1320			
1322			
1324	Speed command	0.01r/min	Notifies the speed command during speed control.
1326	Reserved		
1328			
132A			
132C			
132E			
1330			
1332			
1334			
1336			
1338			
133A			
133C			
133E			
1340			
1342			
1344			
1346			
1348			
134A			
134C			
134E			

12. MONITOR NUMBER

12.6 RIO control information

Monitor No.	Content	Units	Remarks
0300			
0301			
0302			
0303			
0304			
0305			
0306			
0307			
0308			
0309			
030A			
030B			
030C			
030D			
030E			
030F			
0310			
0311			
0312			
0313			
0314			
0315			
0316			
0317	Reserved		
0318			
0319			
031A			
031B			
031C			
031D			
031E			
031F			
0320			
0321			
0322			
0323			
0324			
0325			
0326			
0327			
0328			
0329			
032A			
032B			
032C			
032D			
032E			
032F			

12. MONITOR NUMBER

Monitor No.	Content	Units	Remarks
0330	RIO control parameter error number No. 0200 to 020F		Bit corresponding to parameter error number is turned on. bit is No. 0200 (bit 0) to 020F (bit 15).
0331	RIO control parameter error number No. 0210 to 021F		Bit corresponding to parameter error number is turned on. bit is No. 0210 (bit 0) to 021F (bit 15).
0332	RIO control parameter error number No. 0220 to 022F		Bit corresponding to parameter error number is turned on. bit is No. 0220 (bit 0) to 022F (bit 15).
0333	RIO control parameter error number No. 0230 to 023F		Bit corresponding to parameter error number is turned on. bit is No. 0230 (bit 0) to 023F (bit 15).
0334	Reserved		
0335			
0336			
0337			
0338			
0339			
033A			
033B			
033C			
033D			
033E			
033F			

Note. Information concerning parameter error (RIO control alarm 37, detail 01) that has occurred at system startup can be monitored.

12. MONITOR NUMBER

12.7 System information

Monitor No.	Content	Units	Remarks
0400	Reserved		
0401	Cause of forced stop (Note)		bit 0: External forced stop bit 1: Software forced stop bit 2: User watchdog bit 3: Communication error bit 4: An axis that has not been mounted exists bit 5: During reboot preparation bit 6: System error E5□□ occurrence
0402	Reserved		
0403			
0404			
0405			
0406			
0407			
0408			
0409			
040A	Parameter backup times	Times	Displays the times of write accesses to flash ROM by the parameter backups after system preparation is completed.
040B	Reserved		
040C			
040D			
040E			
040F			
0410	System parameter error number No.0001 to 000F		Bit corresponding to parameter number is turned on. bit is No.0001 (bit 1) to 000F (bit 15).
0411	System parameter error number No.0010 to 001F		Bit corresponding to parameter number is turned on. bit is No.0010 (bit 0) to 001F (bit 15).
0412	System parameter error number No.0020 to 002F		Bit corresponding to parameter number is turned on. bit is No.0020 (bit 0) to 002F (bit 15).
0413	System parameter error number No.0030 to 003F		Bit corresponding to parameter number is turned on. bit is No.0030 (bit 0) to 003F (bit 15).
0414	System parameter error number No.0040 to 004F		Bit corresponding to parameter number is turned on. bit is No.0040 (bit 0) to 004F (bit 15).
0415	System parameter error number No.0050 to 005F		Bit corresponding to parameter number is turned on. bit is No.0050 (bit 0) to 005F (bit 15).
0416	System parameter error number No.0060 to 006F		Bit corresponding to parameter number is turned on. bit is No.0060 (bit 0) to 006F (bit 15).
0417	System parameter error number No.0070 to 007F		Bit corresponding to parameter number is turned on. bit is No.0070 (bit 0) to 007F (bit 15).
0418	Reserved		
:			
047F			

Note. The bit for the corresponding forced stop factor is turned on.

12. MONITOR NUMBER

Monitor No.	Content	Units	Remarks
0480	Information concerning axis that is not mounted 1 (For driver)		When system error E400: "An axis that has not been mounted exists" is set, this bit is turned on. Axis 1 (bit 0) to axis 16 (bit 15)
0481	Information concerning axis that is not mounted 2 (For driver)		When system error E400: "An axis that has not been mounted exists" is set, this bit is turned on. Axis 17 (bit 0) to axis 20 (bit 3)
0482	Reserved		
0483			
0484	Type code erroneous axis information 1 (For driver)		When system error E405: Driver type code error is set, this bit is turned on. Axis 1 (bit 0) to axis 16 (bit 15)
0485	Type code erroneous axis information 2 (For driver)		When system error E405: Driver type code error is set, this bit is turned on. Axis 17 (bit 0) to axis 20 (bit 3)
0486	Reserved		
0487			
0488	Electronic gear setting error axis information 1		When an electronic gear setting error (system error E500) is set, this bit is turned on. Axis 1 (bit 0) to axis 16 (bit 15)
0489	Electronic gear setting error axis information 2		When an electronic gear setting error (system error E500) is set, this bit is turned on. Axis 17 (bit 0) axis 20 (bit 3)
048A	Reserved		
:			
04BF			
04C0	Information concerning station that is not mounted (For module)		When system error E400: "An axis that has not been mounted exists" is set, this bit is turned on. Station 1 (bit 0) to station 4 (bit 3)
04C1	Type code erroneous station information (For module)		When system error E405: Driver type code error is set, this bit is turned on. Station 1 (bit 0) to station 4 (bit 3)
04C2	Reserved		
:			
04BF			

12. MONITOR NUMBER

12.8 Servo parameter information

Monitor No.	Content	Units	Remarks
0500	Reserved		
.			
050F			
0510	Servo parameter error number (Note) No.1100 to 110F		Bit corresponding to parameter number is turned on. bit is No.1100 (bit 0) to 110F (bit 15).
0511	Servo parameter error number (Note) No.1110 to 111F		Bit corresponding to parameter number is turned on. bit is No.1110 (bit 0) to 111F (bit 15).
0512	Servo parameter error number (Note) No.1120 to 112F		Bit corresponding to parameter number is turned on. bit is No.1120 (bit 0) to 112F (bit 15).
0513	Servo parameter error number (Note) No.1130 to 113F		Bit corresponding to parameter number is turned on. bit is No.1130 (bit 0) to 113F (bit 15).
0514	Servo parameter error number (Note) No.1140 to 114F		Bit corresponding to parameter number is turned on. bit is No.1140 (bit 0) to 114F (bit 15).
0515	Servo parameter error number (Note) No.1150 to 115F		Bit corresponding to parameter number is turned on. bit is No.1150 (bit 0) to 115F (bit 15).
0516	Servo parameter error number (Note) No.1160 to 116F		Bit corresponding to parameter number is turned on. bit is No.1160 (bit 0) to 116F (bit 15).
0517	Servo parameter error number (Note) No.1170 to 117F		Bit corresponding to parameter number is turned on. bit is No.1170 (bit 0) to 117F (bit 15).
0518	Servo parameter error number (Note) No.1180 to 118F		Bit corresponding to parameter number is turned on. bit is No.1180 (bit 0) to 118F (bit 15).
0519	Servo parameter error number (Note) No.1190 to 119F		Bit corresponding to parameter number is turned on. bit is No.1190 (bit 0) to 119F (bit 15).
051A	Servo parameter error number (Note) No.11A0 to 11AF		Bit corresponding to parameter number is turned on. bit is No.11A0 (bit 0) to 11AF (bit 15).
051B	Servo parameter error number (Note) No.11B0 to 11BF		Bit corresponding to parameter number is turned on. bit is No.11B0 (bit 0) to 11BF (bit 15).
051C	Servo parameter error number (Note) No.11C0 to 11CF		Bit corresponding to parameter number is turned on. bit is No.11C0 (bit 0) to 11CF (bit 15).
051D	Servo parameter error number (Note) No.11D0 to 11DF		Bit corresponding to parameter number is turned on. bit is No.11D0 (bit 0) to 11DF (bit 15).
051E	Servo parameter error number (Note) No.11E0 to 11EF		Bit corresponding to parameter number is turned on. bit is No.11E0 (bit 0) to 11EF (bit 15).
051F	Servo parameter error number (Note) No.11F0 to 11FF		Bit corresponding to parameter number is turned on. bit is No.11F0 (bit 0) to 11FF (bit 15).

Note. Information concerning parameter error (servo alarm 37) that has occurred at system startup can be monitored. If a parameter warning (servo alarm E4) occurs while system is running, it is not reflected in this information.

12. MONITOR NUMBER

Monitor No.	Content	Units	Remarks
0520	Servo parameter error number (Note) No.1200 to 120F		Bit corresponding to parameter number is turned on. bit is No.1200 (bit 0) to 120F (bit 15).
0521	Servo parameter error number (Note) No.1210 to 121F		Bit corresponding to parameter number is turned on. bit is No.1210 (bit 0) to 121F (bit 15).
0522	Servo parameter error number (Note) No.1220 to 122F		Bit corresponding to parameter number is turned on. bit is No.1220 (bit 0) to 122F (bit 15).
0523	Servo parameter error number (Note) No.1230 to 123F		Bit corresponding to parameter number is turned on. bit is No.1230 (bit 0) to 123F (bit 15).
0524	Servo parameter error number (Note) No.1240 to 124F		Bit corresponding to parameter number is turned on. bit is No.1240 (bit 0) to 124F (bit 15).
0525	Servo parameter error number (Note) No.1250 to 125F		Bit corresponding to parameter number is turned on. bit is No.1250 (bit 0) to 125F (bit 15).
0526	Servo parameter error number (Note) No.1260 to 126F		Bit corresponding to parameter number is turned on. bit is No.1260 (bit 0) to 126F (bit 15).
0527	Servo parameter error number (Note) No.1270 to 127F		Bit corresponding to parameter number is turned on. bit is No.1270 (bit 0) to 127F (bit 15).
0528	Servo parameter error number (Note) No.1280 to 128F		Bit corresponding to parameter number is turned on. bit is No.1280 (bit 0) to 128F (bit 15).
0529	Servo parameter error number (Note) No.1290 to 129F		Bit corresponding to parameter number is turned on. bit is No.1290 (bit 0) to 129F (bit 15).
052A	Servo parameter error number (Note) No.12A0 to 12AF		Bit corresponding to parameter number is turned on. bit is No.12A0 (bit 0) to 12AF (bit 15).
052B	Servo parameter error number (Note) No.12B0 to 12BF		Bit corresponding to parameter number is turned on. bit is No.12B0 (bit 0) to 12BF (bit 15).
052C	Servo parameter error number (Note) No.12C0 to 12CF		Bit corresponding to parameter number is turned on. bit is No.12C0 (bit 0) to 12CF (bit 15).
052D	Servo parameter error number (Note) No.12D0 to 12DF		Bit corresponding to parameter number is turned on. bit is No.12D0 (bit 0) to 12DF (bit 15).
052E	Servo parameter error number (Note) No.12E0 to 12EF		Bit corresponding to parameter number is turned on. bit is No.12E0 (bit 0) to 12EF (bit 15).
052F	Servo parameter error number (Note) No.12F0 to 12FF		Bit corresponding to parameter number is turned on. bit is No.12F0 (bit 0) to 12FF (bit 15).

Note. Information concerning parameter error (servo alarm 37) that has occurred at system startup can be monitored. If a parameter warning (servo alarm E4) occurs while system is running, it is not reflected in this information.

12. MONITOR NUMBER

Monitor No.	Content	Units	Remarks
0530	Servo parameter error number (Note) No.1300 to 130F		Bit corresponding to parameter number is turned on. bit is No.1300 (bit 0) to 130F (bit 15).
0531	Servo parameter error number (Note) No.1310 to 131F		Bit corresponding to parameter number is turned on. bit is No.1310 (bit 0) to 131F (bit 15).
0532	Servo parameter error number (Note) No.1320 to 132F		Bit corresponding to parameter number is turned on. bit is No.1320 (bit 0) to 132F (bit 15).
0533	Servo parameter error number (Note) No.1330 to 133F		Bit corresponding to parameter number is turned on. bit is No.1330 (bit 0) to 133F (bit 15).
0534	Servo parameter error number (Note) No.1340 to 134F		Bit corresponding to parameter number is turned on. bit is No.1340 (bit 0) to 134F (bit 15).
0535	Servo parameter error number (Note) No.1350 to 135F		Bit corresponding to parameter number is turned on. bit is No.1350 (bit 0) to 135F (bit 15).
0536	Servo parameter error number (Note) No.1360 to 136F		Bit corresponding to parameter number is turned on. bit is No.1360 (bit 0) to 136F (bit 15).
0537	Servo parameter error number (Note) No.1370 to 137F		Bit corresponding to parameter number is turned on. bit is No.1370 (bit 0) to 137F (bit 15).
0538	Reserved		
:			
054F			

Note. Information concerning parameter error (servo alarm 37) that has occurred at system startup can be monitored. If a parameter warning (servo alarm E4) occurs while system is running, it is not reflected in this information.

12. MONITOR NUMBER

Monitor No.	Content	Units	Remarks
0580	Reserved		
:			
058F			
0590	Servo parameter change number No.1100 to 110F		Bit corresponding to parameter number is turned on. bit is No.1100 (bit 0) to 110F (bit 15).
0591	Servo parameter change number No.1110 to 111F		Bit corresponding to parameter number is turned on. bit is No.1110 (bit 0) to 111F (bit 15).
0592	Servo parameter change number No.1120 to 112F		Bit corresponding to parameter number is turned on. bit is No.1120 (bit 0) to 112F (bit 15).
0593	Servo parameter change number No.1130 to 113F		Bit corresponding to parameter number is turned on. bit is No.1130 (bit 0) to 113F (bit 15).
0594	Servo parameter change number No.1140 to 114F		Bit corresponding to parameter number is turned on. bit is No.1140 (bit 0) to 114F (bit 15).
0595	Servo parameter change number No.1150 to 115F		Bit corresponding to parameter number is turned on. bit is No.1150 (bit 0) to 115F (bit 15).
0596	Servo parameter change number No.1160 to 116F		Bit corresponding to parameter number is turned on. bit is No.1160 (bit 0) to 116F (bit 15).
0597	Servo parameter change number No.1170 to 117F		Bit corresponding to parameter number is turned on. bit is No.1170 (bit 0) to 117F (bit 15).
0598	Servo parameter change number No.1180 to 118F		Bit corresponding to parameter number is turned on. bit is No.1180 (bit 0) to 118F (bit 15).
0599	Servo parameter change number No.1190 to 119F		Bit corresponding to parameter number is turned on. bit is No.1190 (bit 0) to 119F (bit 15).
059A	Servo parameter change number No.11A0 to 11AF		Bit corresponding to parameter number is turned on. bit is No.11A0 (bit 0) to 11AF (bit 15).
059B	Servo parameter change number No.11B0 to 11BF		Bit corresponding to parameter number is turned on. bit is No.11B0 (bit 0) to 11BF (bit 15).
059C	Servo parameter change number No.11C0 to 11CF		Bit corresponding to parameter number is turned on. bit is No.11C0 (bit 0) to 11CF (bit 15).
059D	Servo parameter change number No.11D0 to 11DF		Bit corresponding to parameter number is turned on. bit is No.11D0 (bit 0) to 11DF (bit 15).
059E	Servo parameter change number No.11E0 to 11EF		Bit corresponding to parameter number is turned on. bit is No.11E0 (bit 0) to 11EF (bit 15).
059F	Servo parameter change number No.11F0 to 11FF		Bit corresponding to parameter number is turned on. bit is No.11F0 (bit 0) to 11FF (bit 15).

12. MONITOR NUMBER

Monitor No.	Content	Units	Remarks
05A0	Servo parameter change number No.1200 to 120F		Bit corresponding to parameter number is turned on. bit is No.1200 (bit 0) to 120F (bit 15).
05A1	Servo parameter change number No.1210 to 121F		Bit corresponding to parameter number is turned on. bit is No.1210 (bit 0) to 121F (bit 15).
05A2	Servo parameter change number No.1220 to 122F		Bit corresponding to parameter number is turned on. bit is No.1220 (bit 0) to 122F (bit 15).
05A3	Servo parameter change number No.1230 to 123F		Bit corresponding to parameter number is turned on. bit is No.1230 (bit 0) to 123F (bit 15).
05A4	Servo parameter change number No.1240 to 124F		Bit corresponding to parameter number is turned on. bit is No.1240 (bit 0) to 124F (bit 15).
05A5	Servo parameter change number No.1250 to 125F		Bit corresponding to parameter number is turned on. bit is No.1250 (bit 0) to 125F (bit 15).
05A6	Servo parameter change number No.1260 to 126F		Bit corresponding to parameter number is turned on. bit is No.1260 (bit 0) to 126F (bit 15).
05A7	Servo parameter change number No.1270 to 127F		Bit corresponding to parameter number is turned on. bit is No.1270 (bit 0) to 127F (bit 15).
05A8	Servo parameter change number No.1280 to 128F		Bit corresponding to parameter number is turned on. bit is No.1280 (bit 0) to 128F (bit 15).
05A9	Servo parameter change number No.1290 to 129F		Bit corresponding to parameter number is turned on. bit is No.1290 (bit 0) to 129F (bit 15).
05AA	Servo parameter change number No.12A0 to 12AF		Bit corresponding to parameter number is turned on. bit is No.12A0 (bit 0) to 12AF (bit 15).
05AB	Servo parameter change number No.12B0 to 12BF		Bit corresponding to parameter number is turned on. bit is No.12B0 (bit 0) to 12BF (bit 15).
05AC	Servo parameter change number No.12C0 to 12CF		Bit corresponding to parameter number is turned on. bit is No.12C0 (bit 0) to 12CF (bit 15).
05AD	Servo parameter change number No.12D0 to 12DF		Bit corresponding to parameter number is turned on. bit is No.12D0 (bit 0) to 12DF (bit 15).
05AE	Servo parameter change number No.12E0 to 12EF		Bit corresponding to parameter number is turned on. bit is No.12E0 (bit 0) to 12EF (bit 15).
05AF	Servo parameter change number No.12F0 to 12FF		Bit corresponding to parameter number is turned on. bit is No.12F0 (bit 0) to 12FF (bit 15).

12. MONITOR NUMBER

Monitor No.	Content	Units	Remarks
05B0	Servo parameter change number No.1300 to 130F		Bit corresponding to parameter number is turned on. bit is No.1300 (bit 0) to 130F (bit 15).
05B1	Servo parameter change number No.1310 to 131F		Bit corresponding to parameter number is turned on. bit is No.1310 (bit 0) to 131F (bit 15).
05B2	Servo parameter change number No.1320 to 132F		Bit corresponding to parameter number is turned on. bit is No.1320 (bit 0) to 132F (bit 15).
05B3	Servo parameter change number No.1330 to 133F		Bit corresponding to parameter number is turned on. bit is No.1330 (bit 0) to 133F (bit 15).
05B4	Servo parameter change number No.1340 to 134F		Bit corresponding to parameter number is turned on. bit is No.1340 (bit 0) to 134F (bit 15).
05B5	Servo parameter change number No.1350 to 135F		Bit corresponding to parameter number is turned on. bit is No.1350 (bit 0) to 135F (bit 15).
05B6	Servo parameter change number No.1360 to 136F		Bit corresponding to parameter number is turned on. bit is No.1360 (bit 0) to 136F (bit 15).
05B7	Servo parameter change number No.1370 to 137F		Bit corresponding to parameter number is turned on. bit is No.1370 (bit 0) to 137F (bit 15).
05B8	Reserved		
:			
05CF			

13. ALARM NUMBER

13. ALARM NUMBER

The Q173SCCF can raise the following four alarms: system alarm, servo alarm, operation alarm, and system error. The alarm numbers are represented in hexadecimal numbers.

API LIBRARY
<ul style="list-style-type: none"> ▪ Use the sscGetAlarm/sscResetAlarm functions to get/reset the alarm number. Specify the following in the argument for the alarm type. <ul style="list-style-type: none"> ▪ System alarm : SSC_ALARM_SYSTEM ▪ Servo alarm : SSC_ALARM_SERVO ▪ RIO module alarm : SSC_ALARM_UNIT ▪ Operation alarm : SSC_ALARM_OPERATION ▪ RIO control alarm : SSC_ALARM_UNIT_CTRL ▪ Use the sscGetSystemStatusCode function to get the system error.

13

13.1 System alarm

Alarm No.	Content	Detail No.	Cause of occurrence	Procedure
35	Operation cycle alarm	01	An operation cycle alarm occurred.	Reexamine the following. (1) Make the control cycle setting longer. (Example. When control cycle is 0.44ms, change to 0.88ms) (2) Decrease the number of control axes. (3) Reexamine the operation pattern so that the timing of the operation startup of each axis does not overlap.
36	Number of write accesses to flash ROM error	01	The number of write accesses to flash ROM by parameter backups exceeds 100,000 times.	Data cannot be written to the flash ROM because the flash ROM is expected to reach its service life.
		03	The number of write accesses to flash ROM by parameter backups exceeds 25 times after system preparation completion.	Check for unnecessary parameter backups. To perform the parameter backup again, reset the system alarm.
37 (Note)	Parameter error	01	Parameter setting is erroneous.	Set the setting to a correct value within the parameter limits.
3B (Note)	Mark detection setting error	01	When mark detection is enabled, the total number of continuous latch data storages (parameter No.02B0, No.02B2) for the whole system exceeds 64.	Set the total number of continuous latch data storages (parameter No.02B0, No.02B2) for the whole system to within 64.

Note. The system alarm cannot be reset.

13. ALARM NUMBER

13.2 Servo alarm

13.2.1 Servo amplifier MR-J4(W□)-□B

The servo alarms of MR-J4(W□)-□B are shown in the following table. For details, refer to the Servo Amplifier Instruction Manual.

Alarm

Alarm No.	Name
10	Undervoltage
11	Switch setting error
12	Memory error 1 (RAM)
13	Clock error
14	Control process error
15	Memory error 2 (EEP-ROM)
16	Encoder initial communication error 1
17	Board error
19	Memory error 3 (FLASH-ROM)
1A	Servo motor combination error
1B	Converter error
1E	Encoder initial communication error 2
1F	Encoder initial communication error 3
20	Encoder normal communication error 1
21	Encoder normal communication error 2
24	Main circuit error
25	Absolute position erased
27	Initial magnetic pole detection error
28	Linear encoder error 2
2A	Linear encoder error 1
2B	Encoder counter error
30	Regenerative error
31	Overspeed
32	Overcurrent
33	Overvoltage
34	SSCNET receive error 1
35	Command frequency error
36	SSCNET receive error 2
37	Parameter error
39	Program error
3A	Inrush current suppression circuit error
3D	Parameter setting error for driver communication
3E	Operation mode error
42	Servo control error
45	Main circuit device overheat
46	Servo motor overheat
47	Cooling fan error
50	Overload 1
51	Overload 2

Alarm No.	Name
52	Error excessive
54	Oscillation detection
56	Forced stop error
61	Operation error
63	STO timing error
64	Functional safety unit setting error
65	Functional safety unit connection error
66	Encoder initial communication error
67	Encoder normal communication error 1
68	STO diagnosis error
69	Command error
70	Load-side encoder initial communication error 1
71	Load-side encoder normal communication error 1
72	Load-side encoder normal communication error 2
74	Option card error 1
75	Option card error 2
79	Functional safety unit diagnosis error
7A	Parameter setting error
7B	Encoder diagnosis error
7C	Functional safety unit communication diagnosis error
7D	Safety observation error
82	Master-slave operation error 1
84	Network module initialization error
85	Network module error
86	Network communication error
8A	USB communication time-out/serial communication time-out error/Modbus-RTU communication time-out error
8D	CC-Link IE communication error
8E	USB communication error/serial communication error/Modbus-RTU communication error
88888	Watchdog

13. ALARM NUMBER

Warning

Alarm No.	Name
90	Home position return incomplete warning
91	Servo amplifier overheat warning
92	Battery cable disconnection warning
93	ABS data transfer warning
95	STO warning
96	Home position setting warning
97	Positioning specification warning
98	Software limit warning
99	Stroke limit warning
9A	Optional unit input data error warning
9B	Error excessive warning
9C	Converter error
9D	CC-Link IE warning 1
9E	CC-Link IE warning 2
9F	Battery warning
E0	Excessive regeneration warning
E1	Overload warning 1
E2	Servo motor overheat warning
E3	Absolute position counter warning
E4	Parameter warning
E6	Servo forced stop warning
E7	Controller forced stop warning
E8	Cooling fan speed reduction warning
E9	Main circuit off warning
EA	ABS servo-on warning
EB	Other axes error warning
EC	Overload warning 2
ED	Output watt excess warning
F0	Tough drive warning
F2	Drive recorder – Miswriting warning
F3	Oscillation detection warning
F4	Positioning warning
F5	Simple cam function - Cam data miswriting warning
F6	Simple cam function - Cam control warning

Note. For the specific servo alarm numbers, refer to the Servo Amplifier Instruction Manual.

13. ALARM NUMBER

13.3 RIO module alarm

13.3.1 SSCNET III/H head module

Refer to "MELSEC-L SSCNET III/H Head Module User's Manual" for SSCNET III/H head module RIO module alarms.

13.3.2 Sensing module

The RIO module alarms of the sensing module are shown in the following table. For details, refer to the Sensing Module Instruction Manual.

Alarm

Alarm No.	Name
10	Undervoltage
11	Switch setting error
12	Memory error 1 (RAM)
13	Clock error
14	Control process error
15	Memory error 2 (EEP-ROM)
17	Board error
19	Memory error 3 (Flash-ROM)
1A	Incorrect combination of extension modules
1B	Driver error
1E	Encoder I/F module - Initial communication error 2
1F	Encoder I/F module - Initial communication error 3
20	Encoder I/F module - Ch. A Normal communication error 1
21	Encoder I/F module - Ch. A Normal communication error 2
28	Encoder I/F module - Linear encoder error 2
2A	Encoder I/F module - Ch. A Linear encoder error 1
34	SSCNET receive error 1
35	I/O pulse frequency error
36	SSCNET receive error 2
37	Parameter error
71	Encoder I/F module - Ch. B Normal communication error 1
72	Encoder I/F module - Ch. B Normal communication error 2
75	Extension module error
76	Encoder I/F module - Ch. B Linear encoder error 1
8E	Serial communication error
—	Watchdog

Warning

Alarm No.	Name
E4	Parameter warning
E7	Controller forced stop warning

Note. For the specific servo alarm numbers, refer to the Sensing Module Instruction Manual.

13. ALARM NUMBER

13.4 Operation alarm

Alarm No.	Content	Detail No.	Cause of occurrence	Procedure
10	Stop command on	01	The stop operation signal (STP) is on.	Turn off the stop operation signal (STP).
		02	The rapid stop signal (RSTP) is on.	Turn off the rapid stop signal (RSTP).
12	During forced stop	01	An forced stop is present.	Cancel the forced stop.
13	Interlock is on	01	An Interlock is present.	Cancel the interlock.
16	Group error	01	An alarm occurred on an axis that is part of a group. (Not the axis)	Remove the cause for the alarm from the axis where the alarm occurred.
1A	In test mode	01	Currently in test mode.	If test mode was selected using MR Configurator2 (set up software), operation (automatic operation etc.) can not be performed using the Q173SCCF. For performing operations using the Q173SCCF, perform a restart.
20	Operation mode error	01	Operation modes overlap.	Set up the operation modes correctly.
		02	Operation modes are not set up.	
21	Command speed zero	01	The command speed is zero or less.	Set the command speed to 1 or more. Note. Depending on parameter settings, a setting of 1 or more may be treated as 0 by internal calculations.
		02	The speed limit is zero or less.	Set the speed limit to 1 or more.
22	Point number error	01	The start point No. or end point No. is a negative value.	Set up the point numbers correctly.
		02	Start point No. is greater than end point No.	
		03	Start point No. or end point No. exceeds the point table area of the dual port memory.	Set up the point numbers and point number offset correctly.
23	Mode change during operation	01	Operation mode was changed during operation.	Do not attempt to change operation modes during operation.
24	Position exceeded during positioning	01	Stopping of end point or changing position for continuous operation, when the deceleration stop point exceeds the command position.	Perform command position taking into account the minimum distance needed to stop.
25	Point table Setting error	01	The position command system setting is erroneous.	Set up the position command system correctly.
		02	The deceleration check system setting is erroneous.	Set up the deceleration check system correctly.
		06	The S-curve ratio setting is erroneous.	Set up the S-curve ratio correctly.
		07	The speed switching point specification setting is erroneous.	Set up the help command correctly.
		08	The point data setting of the next point is erroneous. * Only when "1: Before point switching" is set in the speed switching point specification	Reexamine the setting value of the next point in the point table.
		09	The other axes start specification setting is erroneous.	Set up the other axes start specification correctly.
		0A	The predwell setting is erroneous.	Set up the predwell correctly.
26	Incremental feed movement amount error	01	The setting for incremental feed movement amount is a negative number.	Set the incremental feed movement amount using natural numbers including 0. Movement direction is designated by the movement direction signal (DIR).
		0C	The setting of pass position interrupt specification is erroneous.	Set only the start point for the pass position interrupt specification.
2D	Latest command buffer number setting error	01	A value outside of range is set to the latest buffer number.	Set a value inside the range to the latest buffer number.

13. ALARM NUMBER

Alarm No.	Content	Detail No.	Cause of occurrence	Procedure
2E	Control mode switch error	01	Control mode was changed during operation.	When changing from position control mode to speed control mode/torque control mode, or changing from speed control mode/torque control mode to position control mode, perform the control mode change while stopped.
		02	A control mode outside of setting range was set.	Reexamine the value of the control mode command.
		03 (Note)	Without the control mode changing, a time out occurred.	(1) If the control mode change was conducted on an axis that does not support control mode change, check that control mode change is possible before performing a control mode change. (2) An error occurred in communication processing between the Q173SCCF and the servo amplifier. Make contact with and explain the failure symptoms to an agency or branch office.
		04	During standard mode, a switch command to a control mode that cannot be switched to was input.	Reexamine the value of the control mode command. (a value that is not speed control mode, torque control mode, or outside of range)
2F	Torque control setting error	01	A value outside of range is set to the torque control speed limit value.	Reexamine the value of the torque control speed limit value.
37(Note)	Parameter error	01	Parameter setting is erroneous.	Set the setting to correct value within the parameter limits.
38(Note)	System setting error	01	The setting for the control axis exceeds the maximum number of control axes.	Reexamine the structure of the system.
		02	When Axis No. assignment is valid, the servo amplifier axis No. (parameter No.0203) is set to 0.	Set the axis No. to the servo amplifier axis No. (parameter No.0203).
		03	When Axis No. assignment is valid, the setting value of the servo amplifier axis No. (parameter No.0203) is out of range of the valid axis No.	Set the axis No. within the valid range to the servo amplifier axis No. (parameter No.0203).
		04	When Axis No. assignment is valid, the setting value of the servo amplifier axis No. (parameter No.0203) is the same as other axes.	Reexamine of the setting of the servo amplifier axis No. (parameter No.0203).
39(Note)	I/O number assignment error	01	The general input number assigned to the digital input table or input device table is the same as the setting for other servo amplifiers/remote I/O modules. Or, the assignment exceeds its allowable range.	Reexamine the general I/O number assignment setting (parameter No.0214) for the servo amplifier.
		02	The general output number assigned to the digital output table or input device table is the same as the setting for other servo amplifiers/remote I/O modules. Or, the assignment exceeds its allowable range.	Reexamine the general I/O number assignment setting (parameter No.0214) for the servo amplifier.
3B (Note)	Mark detection setting error	01	Mark detection was enabled in a communication mode that is not compatible.	Use mark detection in an SSCNETⅢ/H system.
		02	Mark detection function is set to enabled for an axis that does not support mark detection function.	(1) Change the servo amplifier being used to an axis with a mark detection signal function. (2) Disable the mark detection settings.
		03	When the mark detection mode is ring buffer, the number of continuous latch storages was set to 0.	Reexamine the value of number of continuous latch data storages (parameter No.02B0, No.02B2).
		04	Mark detection function was set to enabled for an axis that is set to get sensor input from driver.	(1) Reexamine the setting of sensor input option (parameter No.0219). (2) Disable the mark detection settings.

Note. The operation alarm cannot be reset.

13. ALARM NUMBER

Alarm No.	Content	Detail No.	Cause of occurrence	Procedure
40	Linear interpolation start up error	01	Axes that have been set to something besides linear interpolation mode (LIP) are included in the same group.	Designate all of the axes in the group as linear interpolation mode (LIP).
		02	There are 5 or more axes in the group formation.	Set the group formation to a maximum of 4 axes.
		03	Start operation was performed for linear interpolation with the invalid linear interpolation group number.	Reexamine the linear interpolation group (parameter No.0260). Refer to Section 5.4 linear interpolation for further details concerning valid group number.
		04	The number of points defined for axes in the group is different.	Set the same number of points for all axes.
		05	The speed unit for the primary axis (parameter No.0200) is defined to be r/min.	Change the speed units.
41	Linear interpolation point data error	01	The movement amount in the group exceeds the maximum value "999999999".	Set it to the correct data.
		02	With excessive speed processing (parameter No.0261) set to "1: alarm stop", the group formation axis exceeds the speed limit.	Reexamine feed speed and speed limit values.
		03	The axis No. for interpolation axis No. is outside the valid range.	Reexamine the interpolation axis No. setting value.
		04	The number of linear interpolation groups operating simultaneously exceeds the valid number of linear interpolation groups.	Reexamine the operation pattern so that the number of linear interpolation groups operating simultaneously does not exceed the valid number of linear interpolation groups.
		05	The axis No. for the auxiliary axis specified by the point table is the same as the primary axis or another auxiliary axis.	Reexamine the auxiliary axis No. so that it is not the same as another axis No.
42	Can't start linear interpolation auxiliary axis error	01	The auxiliary axis is in operation.	Perform start operation for linear interpolation after making sure all axes in the group are stopped.
		02	The auxiliary axis has an alarm set.	Remove the cause for the alarm on the auxiliary axis.
43	Interference check axis setting error	01	The axis is set up as the interference check axis.	Set it to the correct data.
		02	The axis in the same linear interpolation group as the axis is set up as the interference check axis.	
44	Command error in interference area	01	Commanded to move into interference area.	Perform a commanded to move out of the interference area.
45	Entering interference area error	01	Entered interference area during operation.	(1) Confirm that the parameter settings related to interference check are correct. (2) Change the operation pattern so that the interference area is not entered.
4D	Other axes start setting error	01	The start condition setting is erroneous.	Set correct data.
		02	The operation setting is erroneous.	
50	Tandem drive mode change error	01	Drive mode change was attempted while tandem drive axis mode toggling was prohibited.	Only attempt to change drive mode when change conditions are satisfied. Refer to Section 8.1.3.
51	While in tandem drive non-synchronous mode	01	Home position return, automatic operation, or linear interpolation operation was attempted while in non-synchronous micro adjustment mode of tandem drive axes.	Perform home position return, automatic operation as well as linear interpolation operation while in synchronous mode.
52	Tandem drive axis setting error	01	A home position return method other than dog method, dog cradle method, data set method, scale home position signal detection method, or dog front end method was attempted for home position return while in tandem drive axis mode.	Set the home position return option 1 to one of the return to home position methods listed to the left.
		02	A second axis is not set for the tandem drive axis group. Or 3 or more axes are set up with the same tandem drive group number.	Set up the tandem drive axis group number in pairs.
53	Tandem drive excessive deviation	01	The deviation between the master axis and slave axis for tandem drive axes exceeds the tandem drive excessive deviation width of the parameter.	Make adjustments so that the deviation between the master axis and slave axis is reduced. And reexamine excessive deviation width and delay of start detection for excessive deviation, defined in the parameters.

13. ALARM NUMBER

Alarm No.	Content	Detail No.	Cause of occurrence	Procedure
54	Tandem drive synchronous alignment valid width error	01	When deviation exceeds the synchronous alignment valid width during calculation error correction performed for servo on, while in tandem drive synchronous mode.	Reexamine the parameter synchronous alignment valid width. As the home position return is incomplete (home position return request (ZREQ) is ON), execute home position return again.
55	Tandem drive while performing synchronization	01	When start of operation is executed during calculation error correction performed for turning on of the servo, while in tandem drive synchronous mode.	Do not perform start up while the "synchronizing" signal (SYEO□) is on.
56	Tandem drive slave axis error	01	There is a servo alarm for the parallel drive slave axis (including servo warning E6, E7, E9).	Cancel the servo alarm. For details, refer to the Servo Amplifier Instruction Manual on your servo amplifier.
		02	A communication error or a power outage on the servo amplifier occurred.	Confirm that the connection to the servo amplifier is intact. Refer to Section 13.6 for details concerning communication errors.
		03	The tandem drive slave axis entered servo ready off mode.	
57	Exceeding of valid width of tandem drive deviation compensation error	01	The deviation between the master axis and the slave axis exceeded the valid width when home position return was performed while in tandem drive mode.	(1) Adjust the mechanical deviation between the master axis and the slave axis so that it is within the valid width. (2) Set the tandem drive home position signal offset (parameter No.026C, 026D) to a correct value.
58	Tandem drive synchronous alignment error	01	When a stop command is input during calculation error correction performed for turning on the servo, while in tandem drive synchronous mode.	To correct the error between the master axis and the slave axis, turn the servo off and then on to perform synchronization again.
		02	In tandem drive synchronous mode, the start operation is performed without completion of synchronization.	
5B	Using other axes start data	01	Other axes start data is being used (the other axes start notice signal (OSOP□) is on).	Check the other axes start data is not being used (the other axes start notice signal (OSOP□) is off).
5C	Pass position interrupt error	01	The setting to the start number of the pass interrupt condition is out of range.	Check the start number setting of the pass interrupt condition.
		02	The setting to the end number of the pass interrupt condition is out of range.	Check the end number setting of the pass interrupt condition.
		03	The start number of the pass interrupt condition exceeds the end number.	Check the start number setting and the end number setting of the pass interrupt condition.
		04	The setting of the pass interrupt condition is out of range.	Check the pass interrupt condition setting.
		05	The specified pass interrupt condition is used for other axes.	Do not overlap the pass interrupt condition numbers for each axis.
		06	The operation is started during the pass position output interrupt.	Do not start the operation until the pass position output interruption is completed.
		07	During the pass position output interrupt cancel signal (PPISTP) is on, the operation is started with setting valid to the pass position specification for auxiliary command of point table.	Start the operation after turning off the pass position output interrupt cancel signal (PPISTP).

13. ALARM NUMBER

Alarm No.	Content	Detail No.	Cause of occurrence	Procedure
5D	Continuous operation to torque control error	01	Continuous operation to torque control valid was specified to a tandem drive axis.	Specify continuous operation to torque control invalid to the tandem drive axis.
		02	When operating at a continuous operation to torque control point, the operation was completed without conducting a switch to continuous operation to torque control.	(1) For automatic switch, reexamine the setting of the continuous operation to torque control switching position. (2) For manual switch, conduct a switch to continuous operation to torque control mode before position control mode operation is completed.
		03	The press limit position was reached.	Reexamine the positions of the pressing position in continuous operation to torque control and the press limit position.
		04	Interlock command (ITL) turned ON during the operation of a point set to continuous operation to torque control valid.	Do not input an interlock command during the operation of a continuous operation to torque control point.
		05	The travel direction and press limit position were incorrect.	(1) Reexamine the set values of the point table. (2) Travel in the opposite direction, and start operation before the press limit position.
		06	A continuous operation to torque control point was specified for a connected module that does not support continuous operation to torque control.	(1) Reexamine the set values of the point table. (2) Use a servo amplifier that supports continuous operation to torque control mode.
		07	The control mode switch command (CTLMC) turned ON during movement in continuous operation to torque control mode (before reaching target torque).	Turn ON control mode switch command after completion of continuous operation to torque control. (Switch to position control mode)
		08	The press limit position was set to a position before the position data of the point table.	Set the press limit position to a position after the position data of the point table.
		09	The software limit was set to a position before the press limit position.	Set the press limit position to a position before the software limit.
5E	Continuous operation to torque control setting error	0A	Continuous operation to torque control valid was specified to a linear interpolation axis.	Specify continuous operation to torque control invalid to a linear interpolation axis.
		0B	Continuous operation to torque control was specified as valid for a point where travel amount is 0.	Set the required travel amount in order to conduct continuous operation to torque control.
		01	Continuous operation to torque control speed limit value is outside of range.	Reexamine the setting of the continuous operation to torque control speed limit value.
		02	Target torque is outside of range.	Reexamine the setting of the target torque.
		03	Continuous operation to torque control acceleration time constant is outside of range.	Reexamine the setting of continuous operation to torque control acceleration time constant.
5F	Point table loop error	01	The loop start point is specified but the latest command point No. is 0.	After updating the point table, set the latest command point No.
		02	The loop start point is specified but the number of points used is 1.	When specifying the point table loop, set more than one point.
		03	A value smaller than the start point No. or a value larger than the end point No. was input to the latest command point No.	Input a number within the range of start point No. and end point No. to the latest command point No.
		04	The next point for a point that specifies continuous operation has not been updated.	(1) Increase the number of points to be used in loop method so that update is complete at the time of operation start for the next point. (2) Increase the updating speed so that update is complete at the time of operation start for the next point. (3) After updating the point table, set the latest command point No.
		05	Loop end point was specified while not in point table loop.	Specify loop end point while using point table loop method.
90	Home position return not complete	01	Automatic operation, linear interpolation operation, or home position reset were performed without executing return to home position.	Execute home position return. Or validate no home position (parameter No.0200).

13. ALARM NUMBER

Alarm No.	Content	Detail No.	Cause of occurrence	Procedure
91	Z-phase not passed	01	The Z-phase has not been passed.	Turn the motor more than 1 revolution in the + / - direction and then perform home position return.
92	The proximity dog is short	01	When using dog method home position return, after the dog turned on and decelerating to a stop, the position is not above the dog.	Lengthen the proximity dog. Or in order to stop on top of the dog, reduce the home position return speed.
94	Home position return direction error	01	The home position return direction and stopper method direction are opposite when using a stopper method for return to home position.	Set the home position return direction to be the same as the push direction.
95	Not limiting torque	01	"Torque limit effective" has not been turned on when stopper method is being used for return to home position.	Perform push, and after torque limitation effective state, perform start operation for home position return.
96	Home position setting error	01	Home position setting was performed prior to motor being stabilized.	Adjust the servo so that it stabilizes quickly upon stopping at the home position.
97	Home position stop error	01	Upon stopping at home position, even after 1800 ms passed, in-position was not achieved.	(1) Reduce home position return speed and creep speed. (2) Lengthen the home position return time constant. (3) Broaden the in-position boundaries. (4) Confirm that it is not contacting the machine when return to home position is being performed.
98	Home position search limit error	01	The movement amount moved to detect the home position signal or dog signal while performing return to home position exceeded the home position search limit (parameter No.024A, 024B)	Confirm the input status of the dog signal etc.
9C	Z-phase mask amount setting error	01	The value calculated by Z-phase mask amount \times electronic gear numerator (CMX) \div electronic gear denominator (CDV) exceeds 32 bits. The Z-phase mask amount + the travel distance to the Z-phase exceeds 32 bits.	Reexamine the setting value of the Z-phase mask amount.
9D	Home position return parameter setting error	01	For a home position return method that requires the Z-phase being passed, "Not need to pass motor Z phase after the power supply is switched on" is set.	Reexamine the home position return method (parameter No.0240) or the home position setting condition selection (parameter No.1190).
		02	In the Z-phase detection method home position return, "Search again" is set in the setting of the home position signal re-search.	Set "Do not search again" to the home position signal re-search (parameter No.0240).
		03	In the home position return using other than a Z-phase detection method, a shortcut direction is set as the home position return direction.	Set the - or + direction to the home position return direction (parameter No.0240).
		04	The setting for home position return method (parameter No.0240) is incorrect.	Reexamine the setting of home position return method (parameter No.0240).
A0	Limit switch	01	The upper limit switch (LSP) turned off while moving in the + direction.	Using JOG operation etc. move in the opposite direction to return to within the limit switch boundaries.
		02	The lower limit switch (LSN) turned off while moving in the - direction.	Using JOG operation etc. move in the opposite direction to return to within the limit switch boundaries.
A1	Out of software limit boundaries	01	Position outside of software limit boundaries is being designated.	Set the movement command to within the software limit boundaries.
A2	Reached software limit	01	The software limit has been reached.	Using JOG operation etc. move in the opposite direction to return to within the software limit boundaries.
A4	Software limit Parameter error	01	The parameter settings for the software limits has the upper limit < lower limit.	Set the parameter settings for the software limits such that the upper limit > lower limit.

13. ALARM NUMBER

Alarm No.	Content	Detail No.	Cause of occurrence	Procedure
A5	Position switch parameter error	01	The parameter settings for the position switch has the upper limit < lower limit.	Set the parameter settings for the position switch such that the upper limit > lower limit.
A6	Mark detection write/read error	01	During mark detection, it is not possible to write to the target buffer.	The reading speed of the C Controller module for a mark detection occurrence is too slow. Perform the following. (1) Increase the number of continuous latch data storages (parameter No.02B0, No.02B2) for the applicable mark sensor. (2) Increase the reading speed.
		02	After the input of a value to the read complete buffer number that exceeds the mark detection count, a mark sensor was detected.	Reexamine the input value for the read complete buffer number.
A7	Command data error	01	A value outside of range was input to the speed command buffer.	Reexamine the speed command data.
		02	A value outside of range was input to the torque command buffer.	Reexamine the torque command data.
		03	Position command data that exceeds the allowable difference between the position command data of the previous command data update cycle was input.	Reexamine the position command data.
B0	Servo is not controllable	01	Axis is not a control axis.	Validate control axes (parameter No.0200).
		02	A communication error or a power outage on the servo amplifier occurred.	Confirm that the connection to the servo amplifier is intact. Refer to Section 13.6 for further details concerning communication errors.
		03	A servo alarm was set and servo ready off mode was entered.	Cancel the servo alarm. For details, refer to the Servo Amplifier Instruction Manual on your servo amplifier.
			The main circuit is in off status.	Turn on the main circuit.
B1	Servo alarm occurrence	01	A servo alarm occurs (including servo warning E6, E7, E9).	Cancel the servo alarm. For details, refer to the Servo Amplifier Instruction Manual on your servo amplifier.
B2	Servo is off	01	Servo is in off status.	Turn on the servo.
B3	Servo off command	01	Servo on signal (SON) was turned off during operation.	Turn on the servo.

13. ALARM NUMBER

13.5 RIO control alarm

Alarm No.	Content	Detail No.	Cause of occurrence	Procedure
37 (Note)	Parameter error	01	Parameter setting is erroneous.	Set the setting to correct value within the parameter limits.
38 (Note)	System setting error	01	The setting for the control station exceeds the maximum number of control stations.	Reexamine the structure of the system.
		02	When station No. assignment is valid, the remote I/O module station No. (parameter No.0202) is set to 0.	Set the station No. to the remote I/O module station No. (parameter No.0202).
		03	When station No. assignment is valid, the setting value of the remote I/O module station No. (parameter No.0202) is out of range of the valid station No.	Set the station No. within the valid range to remote I/O module station No. (parameter No.0202).
		04	When station No. assignment is valid, the setting value of remote I/O module station No. (parameter No.0202) is the same as other stations.	Reexamine the setting of the remote I/O module station No. (parameter No.0202).
		05	The used points were set to an input table that is not being used.	Review the settings for I/O table selection (parameter No.004A), input bit device points (parameter No.0210) and input word device points (parameter No.0212) for remote I/O module
		06	The used points were set to an output table that is not being used.	Review the settings for I/O table selection (parameter No.004A), output bit device points (parameter No.0214) and output word device points (parameter No.0216) for remote I/O module
39 (Note)	I/O No. assignment setting error	01	The number assigned to the digital input table or input device table is the same as the setting for other servo amplifiers/remote I/O modules. Or, the assignment exceeds its allowable range.	Reexamine the input bit device start No. (parameter No.0211), and input word device start No. (parameter No.0213) for the remote I/O module.
		02	The number assigned to the digital output table or output device table is the same as the setting for other servo amplifiers/remote I/O modules. Or, the assignment exceeds its allowable range.	Reexamine the output bit device start No. (parameter No.0215), and output word device start No. (parameter No.0217) for the remote I/O module.

Note. The RIO control alarm cannot be reset.

13. ALARM NUMBER

13.6 System error

The error code for system errors can be confirmed using system status codes (address 01D0). When the status code is E □ □ □ h, this corresponds to a system error.

Error code	Content	Cause of occurrence	Procedure
E001	ROM error	Component failure inside Q173SCCF.	Replace the Q173SCCF.
E002	RAM error 1		
E003	Dual port memory error	Component (dual port memory) failure inside Q173SCCF. (Note 1)	If the conditions described in (Note 1) are not applicable, replace the Q173SCCF.
E004	RAM error 2	Component error inside Q173SCCF.	Replace the Q173SCCF.
E006	SSCNET communication IC error 1		
E007	SSCNET communication IC error 2		
E008	Board error		
E1 □ □	CPU error		
E200	Interrupt error		
E301	Watchdog error (Note 2)		
E302	DC FAIL	The +5VDC being supplied to the Q173SCCF was reduced.	Check that there are no failures in the power supply module or the main base unit.
E310	PCIe bus connection error	PCIe communication with C Controller module was cut off.	Check the connection status of the PCIe bus connected to the Q173SCCF.
E400	An axis that has not been mounted exists	The control option 1 (parameter No.0200) control axis (■ ■ ■ □) setting and the servo amplifier connection status are different.	Check the following details. (1) That the control option 1 setting and the servo amplifier connection status, setting (rotary switch) match. (2) Power supply status to servo amplifier. (3) SSCNETIII cable connection status. (4) For disconnection of SSCNETIII cable.
		Communication was cut off by power outage of servo amplifier etc.	Check the following details. (1) Power supply status to servo amplifier. (2) SSCNETIII cable connection status. (3) For disconnection of SSCNETIII cable. Turn on the control power supplies for the communication route servo amplifiers.
		The disconnection command is sent to the second or later axis in the module of the multi-axis amplifier.	Make sure the all axes in the module of the multi-axis amplifier are simultaneously disconnected.
E401	CRC error	SSCNET communication error	Check the following details. (1) SSCNETIII cable connection status. (2) For disconnection of SSCNETIII cable.
E403	Data ID error		
E405	Driver type code error	Type code (parameter No.021E) is different from actual drivers.	Check the respective parameters.
		The vendor ID (parameter No.021D) is different from the actual driver.	Check the respective parameters.
E407	SSCNET time out	No response from the servo amplifier and a communication time out occurred.	An error occurred in communication processing between the Q173SCCF and the servo amplifier. Make contact with and explain the failure symptoms to an agency or branch office.

Note. 1. There are cases where this occurs when data is written to the dual port memory from the C Controller module prior to system status code becoming "system preparation completion" after turning on the power for the Q173SCCF (or after reboot).

2. Not user watchdog. Watchdog error on the Q173SCCF side.

13. ALARM NUMBER

Error code	Content	Cause of occurrence	Procedure
E40B	Uncontrollable driver	The Q173SCCF failed to shift to the status where the driver is controllable since an error occurred in initial communication between the Q173SCCF and the servo amplifier.	Check the following details. (1) The setting value of the control option 1 should correspond to the servo amplifier connection status. (2) The setting of multi-axis amplifier and the control option 1 or axis/station No. assignment should correspond.
E40E	Communication cycle error	A servo amplifier that does not support the set communication cycle is connected.	Check that all servo amplifiers support the set control cycle (communication cycle).
E500	Electronic gear setting error	A value out of the setting range was input.	Check the following details. (1) The settings of the electronic gear numerator (CMX) and the electronic gear denominator (CDV) are within the setting range. (2) The settings of the electronic gears (CMX/CDV) are within the setting range.
E503	Exclusive control error	The invalid value is set to the exclusive control data area.	Reexamine the setting process for the exclusive control data.
E510	I/O number assignment error	The digital I/O table or I/O table assignment is erroneous.	Check the axis or station in which the I/O number assignment setting error (Operation alarm No.39, RIO control alarm 39) is occurring and reexamine the setting.
E511	I/O table select error	The used points were set to an I/O table that is not being used.	Check the station in which the system setting error (RIO control alarm 38) is occurring and reexamine the setting.
E5E0	SSCNET communication system error	An error occurred in initial communication with the servo amplifier.	An error occurred in initial communication between the Q173SCCF and the servo amplifier. Make contact with and explain the failure symptoms to an agency or branch office.
E5E1	SSCNET communication system error 2		
EF01	System command code error	An erroneous system command code was set.	Do not set any values other than those listed in Section 10.3.

14. EMC DIRECTIVE

14. EMC DIRECTIVE

Compliance to the EMC Directive, which is one of the EU Directives, has been a legal obligation for the products sold in European countries since 1996 as well as the Low Voltage Directive since 1997.

Manufacturers who recognize their products are compliant to the EMC and Low Voltage Directives are required to declare that print a "CE mark" on their products.

(1) Authorized representative in Europe

Authorized representative in Europe is shown below.

Name : Mitsubishi Electric Europe B.V.

Address : Gothaer strase 8, 40880 Ratingen, Germany

14.1 Requirements for compliance with the EMC directive

The EMC Directive specifies that products placed on the market must be so constructed that they do not cause excessive electromagnetic interference (emissions) and are not unduly affected by electromagnetic interference (immunity)". Section 14.1.1 through Section 14.1.3 summarize the precautions on compliance with the EMC Directive of the machinery constructed with the Q173SCCF.

These precautions are based on the requirements and the standards of the regulation, however, it does not guarantee that the entire machinery constructed according to the descriptions will comply with above-mentioned directive. The method and judgement for complying with the EMC Directive must be determined by the person who construct the entire machinery.

14. EMC DIRECTIVE

14.1.1 Standards relevant to the EMC directive

The standards relevant to the EMC Directive are listed in table below.

Certification	Test item	Test details	Standard value
EN61000-6-4:2007+A1:2011 EN61131-2:2007	EN55011:2009/A1:2010 Radiated emission (Note 1)	Radio waves from the product are measured.	30M-230MHz QP (Note 2) : 40dB μ V/m (10m (32.81ft.) in measurement range) 230M-1000MHz QP: 47dB μ V/m (10m (32.81ft.) in measurement range)
	EN55011:2009/A1:2010 Conducted emission	Noise from the product to the power line is measured.	AC power line 0.15M-0.5MHz QP : 79dB μ V AV (Note 3) : 66dB μ V 0.5M-30MHz QP : 73dB μ V AV : 60dB μ V
EN61000-6-2:2005 EN61131-2:2007	EN61000-4-2:1995/ A1:1998/A2:2001 Electrostatic discharge immunity	Immunity test in which electrostatic discharge is applied to the product.	8kV: 10 times at 1 second interval, Air discharge 4kV: 10 times at 1 second interval, Contact discharge
	EN61000-4-3:2006/ A1:2008/A2:2010 Radiated immunity (Note 1)	Immunity test in which electric fields are radiated to the product.	80%AM modulation @1kHz, 80-1000MHz 10V/m, 1400M-2000MHz 3V/m, 2000M-2700MHz 1V/m
	EN61000-4-4:2004/ A1:2010 Electrical fast transient/ burst (EFT/B) immunity	Immunity test in which burst noise is applied to the power cable and signal line.	AC power line : \pm 2kV/5kHz DC power line : \pm 2kV/5kHz I/O, communication line : \pm 1kV/5kHz
	EN61000-4-5:2006 Surge immunity	Immunity test in which surge is applied to the power line and signal line.	AC power line Common mode: \pm 2.0kV Differential mode: \pm 1.0kV DC power line Common mode: \pm 0.5kV Differential mode: \pm 0.5kV I/O, communication line Common mode: \pm 1kV
	EN61000-4-6:2009 Conducted immunity	Immunity test in which high frequency noise is applied to the power line and signal line.	0.15-80MHz, 80%AM modulation @1kHz, 10Vrms
	EN61000-4-11:2004 Short interruptions immunity	Immunity test in which power supply has short interruptions.	0% of rated voltage, 250cycle
	EN61000-4-11:2004 Voltage dip	Test in which voltage dip is applied to the power supply.	40% of rated voltage, 10cycle 70% of rated voltage, 25cycle
EN61131-2:2007	EN61131-2:2007 Voltage dip immunity	Immunity test in which dips are applied to the power supply.	0% of rated voltage, 0.5cycle, 20 times

Note 1. This product is an open type device (a device designed to be housed inside other equipment) and must be installed inside a conductive control panel.

The corresponding test has been done with the programmable controller installed inside a control panel.

2. QP : Quasi-peak value

3. AV: Average value

14. EMC DIRECTIVE

14.1.2 Installation instructions for EMC directive

(1) Installation

Q173SCCF is an open type device and must be installed, and used inside a control panel.

This not only ensures safety but also ensures effective shielding of Q173SCCF-generated electromagnetic noise.

(a) Control panel

- 1) Use a conductive control panel.
- 2) When attaching the control panel's top plate or base plate, expose bare metal surface and weld so that good surface contact can be made between the panel and plate.
- 3) To ensure good electrical contact with the control panel, mask the paint on the installation bolts of the inner plate in the control panel so that contact between surfaces can be ensured over the widest possible area.
- 4) Ground the control panel with a thick wire so that a low impedance connection to ground can be ensured even at high frequencies.
- 5) Holes made in the control panel must be 10cm (3.94inch) diameter or less. If the holes are 10cm (3.94 inch) or larger, radio frequency noise may be emitted. In addition, because radio waves leak through a clearance between the control panel door and the main unit, reduce the clearance as much as practicable. The leakage of radio waves can be suppressed by the direct application of an EMI gasket on the paint surface.

(2) Connection of power line and ground wire

Ground wire and power supply cable for the programmable controller must be connected as described below.

- (a) Provide a grounding point near the FG terminal. Ground the FG terminals (Frame Ground) with the thickest and shortest wire possible. (The wire length must be 30cm (11.81inch) or shorter.) The FG terminals function is to pass the noise generated in the Q173SCCF to the ground, so the ground wire ensures a low impedance as possible.

Because the wire does the role to transfer the noise, the wire itself carries a large noise content and thus short wiring means that the wire is prevented from acting as an antenna.

- (b) Twist the ground wire drawn out from grounding point with the power line. By twisting the power line with ground wire, it can transfer the noise more from power line to the ground. However, if the noise filter is attached to the power line, it might be unnecessary to twist with the ground wire.

(3) Precautions relevant to the electrostatic discharge

There is a weak part to electrostatic discharge in the surface of the module.

Before touching the module, always touch grounded metal, etc. to discharge static electricity from human body. Failure to do so may cause the module to fail or malfunction.

Do not directly touch the conductive parts of module and electronic components. Touching them could cause an operation failure or give damage to the module.

14. EMC DIRECTIVE

14.1.3 Parts of measure against noise

(1) Ferrite core

A ferrite core has the effect of reducing noise in the 30MHz to 100MHz band.

It is not required to fit ferrite cores to cables, but it is recommended to fit ferrite cores if shield cables pulled out of the enclosure do not provide sufficient shielding effects.

Note that the ferrite cores must be fitted to the cables in the position immediately before they are pulled out of the enclosure. If the fitting position is improper, the ferrite core will not produce any effect.

• Ferrite core (Recommended product)

Manufacturer	Model name
TDK	ZCAT3035-1330

(2) Noise filter (power supply line filter)

A noise filter is a component which has an effect on conducted noise.

The attachment of the noise filter to the power supply line of the servo amplifier and system's power supply is effective for the reducing noise.

(The noise filter has the effect of reducing conducted noise of 10 MHz or less.)

• Recommended noise filters

Manufacturer	Model name	Rated current (A)	Rated voltage (V)
SCHAFFNER	FN343-3/01	3	250
	FN660-6/06	6	
TDK	ZHC2203-11	3	

The precautions required when installing a noise filter are described below.

(a) Do not bundle the wires on the input side and output side of the noise filter. When bundled, the output side noise will be induced into the input side wires from which the noise was filtered.

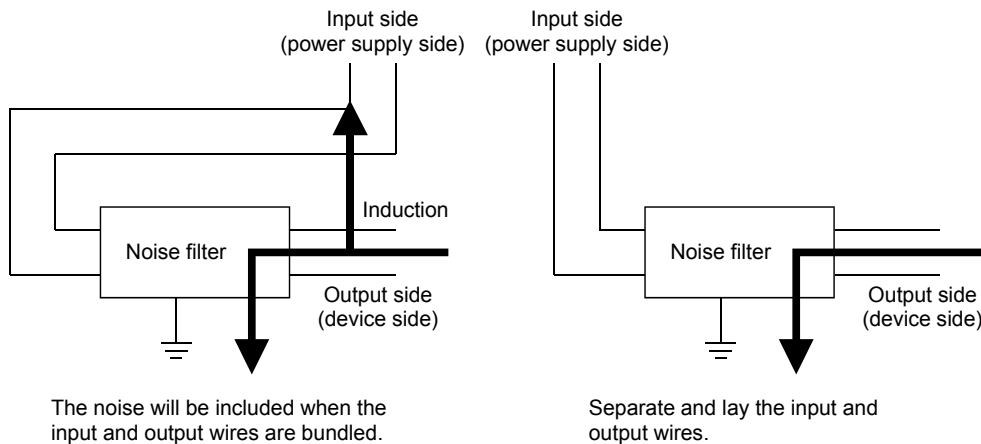
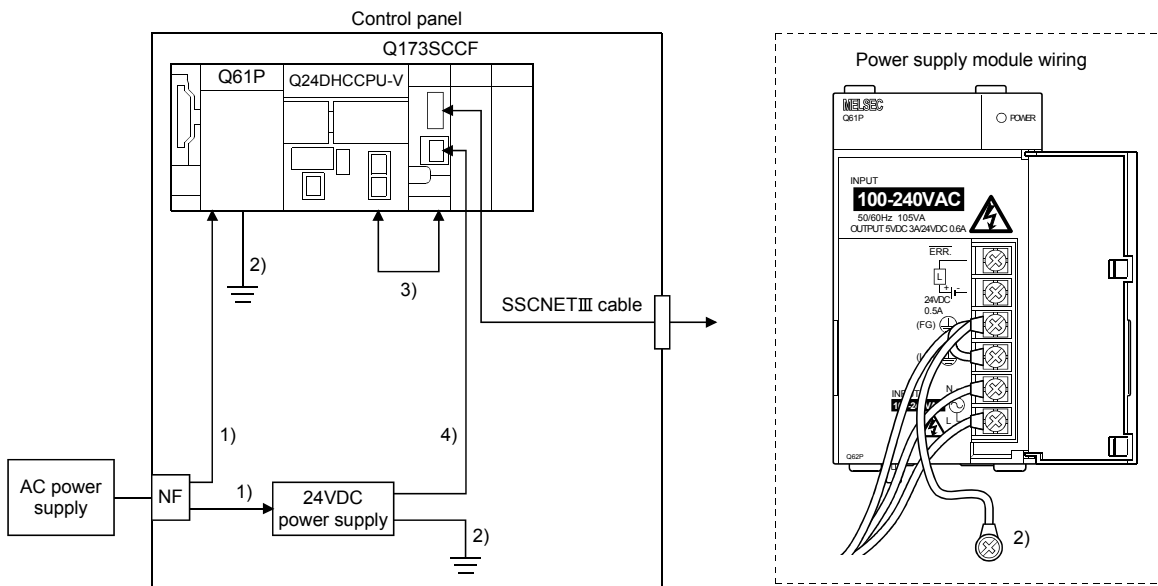

Figure 14.1 Precautions on noise filter

(b) Ground the noise filter grounding terminal to the control panel with the shortest wire possible (approx. 10cm (3.94 inch)).

14. EMC DIRECTIVE

14.1.4 Example of measure against noise



- 1) Wire the power supply cable as short as possible using the twisted cable (2mm² or more).
- 2) Wire the power supply and 24VDC power supply as short as possible using the cable of approx. 2mm², and ground to the control panel.
- 3) Wire the PCIe cable 10cm(3.94inch) or more from the lead wire and other cables.
- 4) Use a twisted pair cable for the forced stop input cable and do not mix with power lines etc.

(1) Refer to this chapter or "EMC and Low Voltage Directives" of "QCPU User's Manual (Hardware Design, Maintenance and Inspection)" for basic wire. We examined Q173SCCF by the above example.

(2) In wiring inside the panel, the power line connected to the power or servo amplifier and the communication cable such as bus connection cable or network cable must not be mixed. If the cables are installed closely with each other for wiring reasons, using a separator (made of metal) can make the cables less influenced by noise. Mixing the power line and communication cable may cause malfunction due to noise.

APPENDIX

App. 1 Supplementary explanation for the use of linear servo system

App. 1.1 Q173SCCF

The software versions of the Q173SCCF that can set up the linear servo system are as follows.

C Controller interface module	Software version
Q173SCCF	A3 or later

App. 1.2 Utility software

The utility software versions supporting Q173SCCF are as follows.

Utility software	Software version
SW1DNC-QSCCF-B	Ver. 1.50 or later

App. 1.3 Servo amplifier

The servo amplifier MR-J4(W□)-□B can set linear servo system with the Q173SCCF.

For detailed specifications of the servo amplifier, refer to the Servo Amplifier Instruction Manual for your servo amplifier.

App. 1.4 Operations and functions of the linear servo system

(1) Startup procedure

Linear servo system startup procedures are as follows.

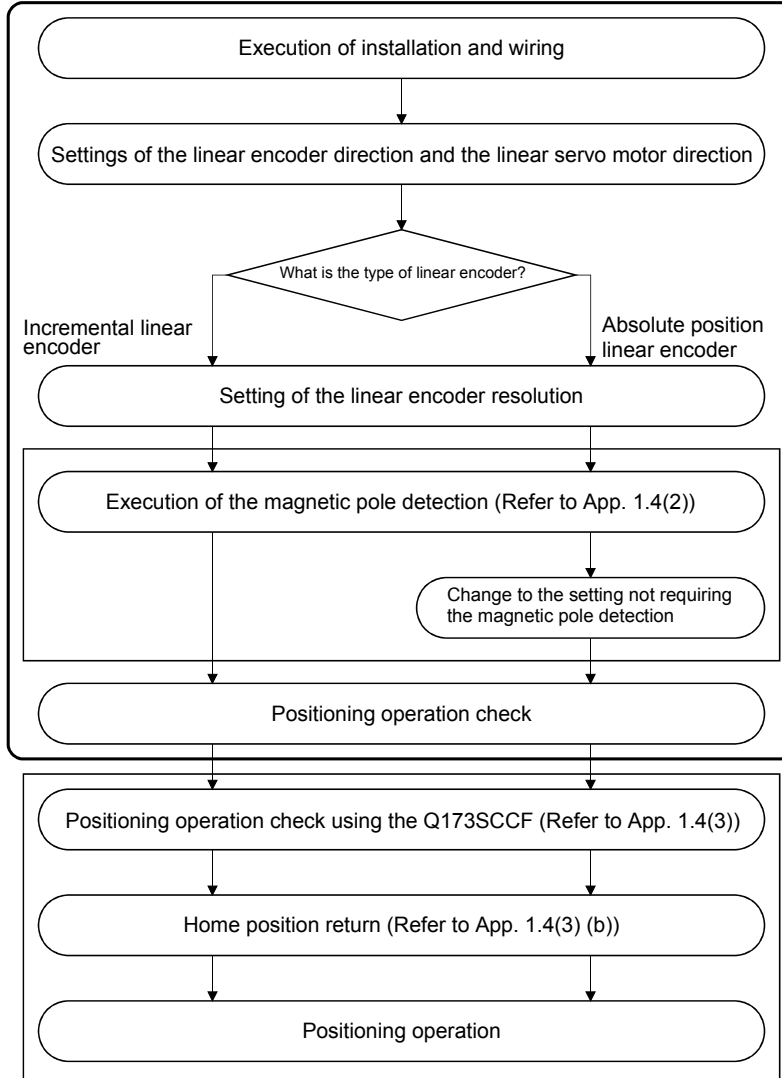

Refer to the Servo Amplifier Instruction Manual for your servo amplifier.

(2) Magnetic pole detection

For magnetic pole detection methods, refer to the Servo Amplifier Instruction Manual for your servo amplifier.

When an incremental scale is used, magnetic pole detection is performed at every power on. The magnetic pole detection is started when the first servo-on command following power on is received. Completion of the magnetic pole detection turns the servo on.

(a) For a single axis

Timing chart

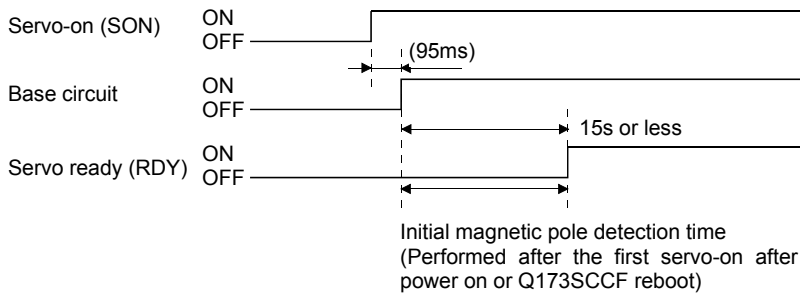

Axis movement in magnetic pole detection

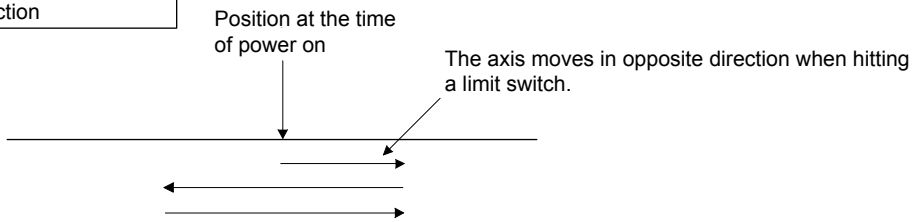

(b) For tandem drive axes

For tandem drive axes, perform magnetic pole detection for the master axis, and then for the slave axis in the non-synchronous micro adjustment mode. Make sure the axis where magnetic pole detection is not performed is servo off (free).

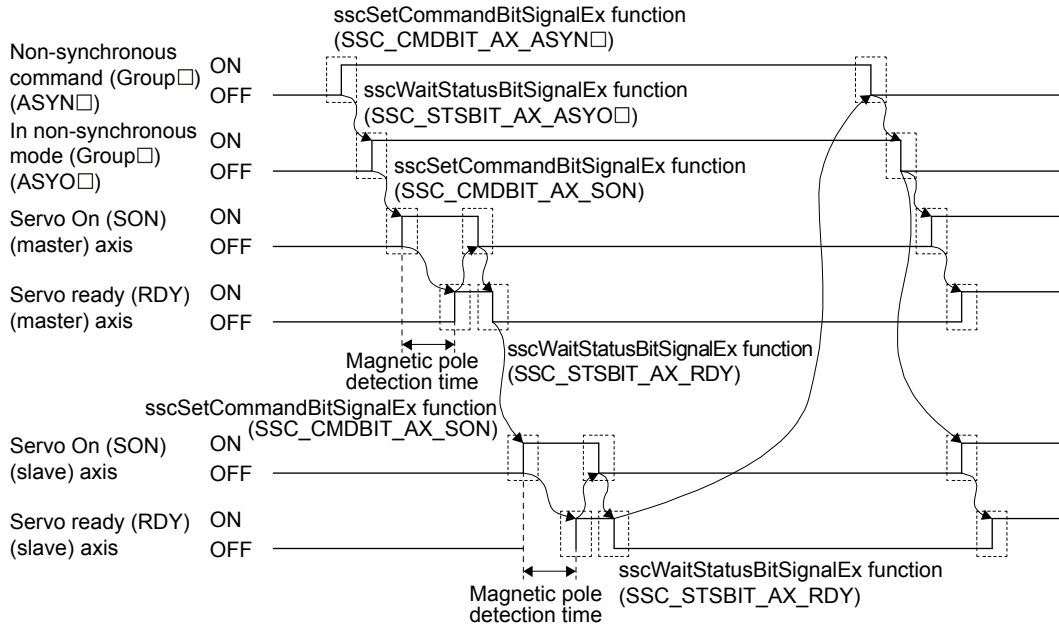

- Note 1. As shown on the timing chart above, during magnetic pole detection operation, it takes up to 15s from servo-on (SON) signal turning on to servo ready (RDY) signal turning on. Before using the API function library included in the utility software (SW1DNC-QSCCF-B), set 15s or more to the time-out period in sscWaitStatusBitSignalEx function, and wait until the servo on.
- Establish the machine configuration using a limit switch. Collision may be caused between components without a limit switch.
 - In initial magnetic pole adjustment, a controlled object may move in the forward direction or reverse direction.
 - For tandem drive axes, do not turn servo on simultaneously for both the master and slave axes.
 - Magnetic pole detection time is the operating time when the stroke limit signal (FLS/RLS) is on.
 - When switching between non-synchronous mode/synchronous mode, check that all of the following conditions are satisfied.
 - The in-position signal (INP) is ON for both the master axis and slave axis.
 - No operation alarm has occurred for both the master axis and slave axis.

APPENDIX

(3) Operation from the Q173SCCF

Positioning operation using the Q173SCCF is basically the same as operation for using a rotary servo motor.

However, some parameters, home position return operation, and monitor No. vary from when using a rotary servo motor. Details are as follows.

(a) Parameter

When using the linear servo system, set the parameters shown on the table below.

For other servo parameters, control parameters, and system parameters, set them as equivalent to using standard control mode (operation mode).

1) Servo parameters

For details on each parameter, refer to the Servo Amplifier Instruction Manual for your servo amplifier.

<MR-J4(W□)-□B>

Parameter No.	MR-J4-B Parameter No.	(Note) Abbreviation	Name
1100	PA01	**STY	Operation mode
1110	PA17	**MSR	Servo motor series setting
1111	PA18	**MTY	Servo motor type setting
1180	PC01	ERZ	Error excessive alarm level
1182	PC03	*ENRS	Encoder output pulse selection
119A	PC27	**COP9	Function selection C-9
1300	PL01	**LIT1	Linear servo motor/DD motor function selection 1
1301	PL02	**LIM	Linear encoder resolution setting Numerator
1302	PL03	**LID	Linear encoder resolution setting Denominator
1303	PL04	*LIT2	Linear servo motor/DD motor function selection 2
1304	PL05	LB1	Position deviation error detection level
1305	PL06	LB2	Speed deviation error detection level
1306	PL07	LB3	Torque/thrust deviation error detection level
1307	PL08	*LIT3	Linear servo motor/DD motor function selection 3
1308	PL09	LPWM	Magnetic pole detection voltage level
1310	PL17	LTSTS	Magnetic pole detection - Minute position detection method - Function selection
1311	PL18	IDLV	Magnetic pole detection - Minute position detection method - Identification signal amplitude

Note. The parameters with a * mark at the front of the abbreviation are validated according to the following conditions.

*: After setting, turn off the power supply and then on again, or reset controller.

**: After setting, turn off the power supply and then on again.

2) Control parameters

Parameter No.	(Note 1) Abbreviation	Name	Initial value	Unit	Setting range	Function
0200	*OPC1	Control option 1	0001h		0000h to 2111h	<div style="border: 1px solid black; display: inline-block; padding: 2px;"> 0 0 0 </div> <p>Speed unit (Note 3) Set the speed command unit. 0: Position command unit / min 1: Position command unit / s</p>
020A	*CMXL	Electronic gear numerator (lower)	0001h		1 to 5242879 (32 bit) (Note2)	Set the numerator of the electronic gear. (For setting methods, refer to 3.)
020B	*CMXH	Electronic gear numerator (upper)	0000h			
020C	*CDVL	Electronic gear denominator (lower)	0001h		1 to 589823 (32 bit) (Note2)	Set the denominator of the electronic gear. (For setting methods, refer to 3.)
020D	*CDVH	Electronic gear denominator (upper)	0000h			
021D	*VEND	Vendor ID	0000h		0000h to FFFFh	Set the vendor ID. 0000h: Mitsubishi Electric
021E	*CODE	Type code	1000h		0000h to FFFFh	Set the type code. 1000h: MR-J4(W□)-□B servo amplifier

Note 1. The settings for the parameters with a * mark at the front of the abbreviation are validated when the system is started.

2. For details on the setting range, refer to Section 6.1.1.

3. When using a linear servo amplifier, select [position command unit/min] or [position command unit/s] as the speed command unit. [r/min] cannot be used as the speed command unit.

3) Setting example of electronic gears

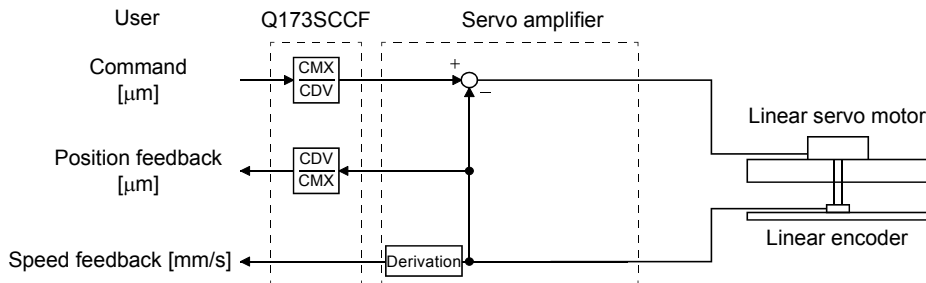

Conditions:

Command unit: μm

Linear encoder resolution: 0.05 μm

$$\frac{\text{Number of pulses (CMX) [pulse]}}{\text{Travel (CDV) [μm]}} = \frac{1}{0.05} = \frac{20}{1}$$

APPENDIX

(b) Home position return operation

The home position return operation from the Q173SCCF is basically the same as operation for using a rotary servo motor.

However, note the following.

- 1) When using the absolute position type linear scale, the scale home position signal detection method or the scale home position signal detection method 2 cannot be used.

The other home position return methods are available and a home position return is performed to the reference home position created based on stop interval settings for the home position return.

- 2) When using the incremental linear scale, it is recommended to use the scale home position signal detection method or the scale home position signal detection method 2. In this case, the home position return is performed based on the home position signal (Z-phase). The reference home position which is created based on stop interval settings for the home position return is not used.

<Control parameter>

Parameter No.	(Note 1) Abbreviation	Name	Initial value	Unit	Setting range	Function
0240	*OPZ1	Home position return option 1	0000h		0000h to 112Dh	<div style="display: flex; align-items: center;"> <div style="border: 1px solid black; padding: 2px; margin-right: 5px;">0</div> <div style="border: 1px solid black; padding: 2px; margin-right: 5px;">0</div> <div style="border: 1px solid black; padding: 2px; margin-right: 5px;">0</div> <div style="border: 1px solid black; padding: 2px; margin-right: 5px;">0</div> </div> <p>Home position return method (Note) Set the method for home position return. 0: Dog method 2: Data set method 3: Stopper method 4: Dog cradle method 5: Limit switch combined method 6: Scale home position signal detection method 7: Limit switch front end method 8: Dog front end method C: Z-phase detection method D: Scale home position signal detection method 2 Note. Can be changed while system is running. (Software version A5 or later)</p>

Note 1. *: Setting will be valid at system startup.

- 3) When using the incremental scale, the home position return using a Z-phase detection method cannot be used.

- 4) With the incremental scale, when using a home position return method other than the scale home position signal detection method or the scale home position signal detection method 2, "1□□□" (Search again) must be set for the parameter No.0240 (*OPZ1).

In this case, the home position return is performed based on the home position return reference position which is created based on stop interval settings for the home position return and the home position signal (Z-phase).

<Control parameter>

Parameter No.	(Note 1) Abbreviation	Name	Initial value	Unit	Setting range	Function
0240	*OPZ1	Home position return option 1	0000h		0000h to 112Dh	<div style="display: flex; align-items: center;"> <div style="border: 1px solid black; padding: 2px; margin-right: 5px;">1</div> <div style="border: 1px solid black; padding: 2px; margin-right: 5px;">0</div> <div style="border: 1px solid black; padding: 2px; margin-right: 5px;">0</div> <div style="border: 1px solid black; padding: 2px; margin-right: 5px;">0</div> </div> <p>Home position signal additional search (Note) Set "1" when using an incremental encoder or incremental linear scale. 0: Do not search again 1: Search again Note. Can be changed while system is running. (Software version A5 or later)</p>

Note 1. *: Setting will be valid at system startup.

<Servo parameter (MR-J4(W□)-□B)>

Parameter No.	MR-J4-B Parameter No.	(Note) Abbreviation	Name	Initial value	Unit	Setting range	Function																
1300	PL01	**LIT1	Linear servo motor/direct drive motor function selection 1	0301h		0000h to 0605h	<div style="display: flex; align-items: center;"> <div style="border: 1px solid black; width: 40px; height: 20px; margin-right: 5px;"></div> <div style="border: 1px solid black; width: 40px; height: 20px; margin-right: 5px;"></div> <div style="border: 1px solid black; width: 40px; height: 20px; margin-right: 5px;"></div> <div style="border: 1px solid black; width: 40px; height: 20px;"></div> </div> <p style="margin-left: 20px;">Stop interval setting for home position return</p> <table border="1" style="margin-left: 20px;"> <thead> <tr> <th>Setting value</th> <th>Stop interval [pulse]</th> </tr> </thead> <tbody> <tr><td>0</td><td>8192</td></tr> <tr><td>1</td><td>131072</td></tr> <tr><td>2</td><td>262144</td></tr> <tr><td>3</td><td>1048576</td></tr> <tr><td>4</td><td>4194304</td></tr> <tr><td>5</td><td>16777216</td></tr> <tr><td>6</td><td>67108864</td></tr> </tbody> </table>	Setting value	Stop interval [pulse]	0	8192	1	131072	2	262144	3	1048576	4	4194304	5	16777216	6	67108864
Setting value	Stop interval [pulse]																						
0	8192																						
1	131072																						
2	262144																						
3	1048576																						
4	4194304																						
5	16777216																						
6	67108864																						

Note **: After setting, turn off the power supply and then on again to make the setting valid.

(Example) Home position return reference position for dog method home position return

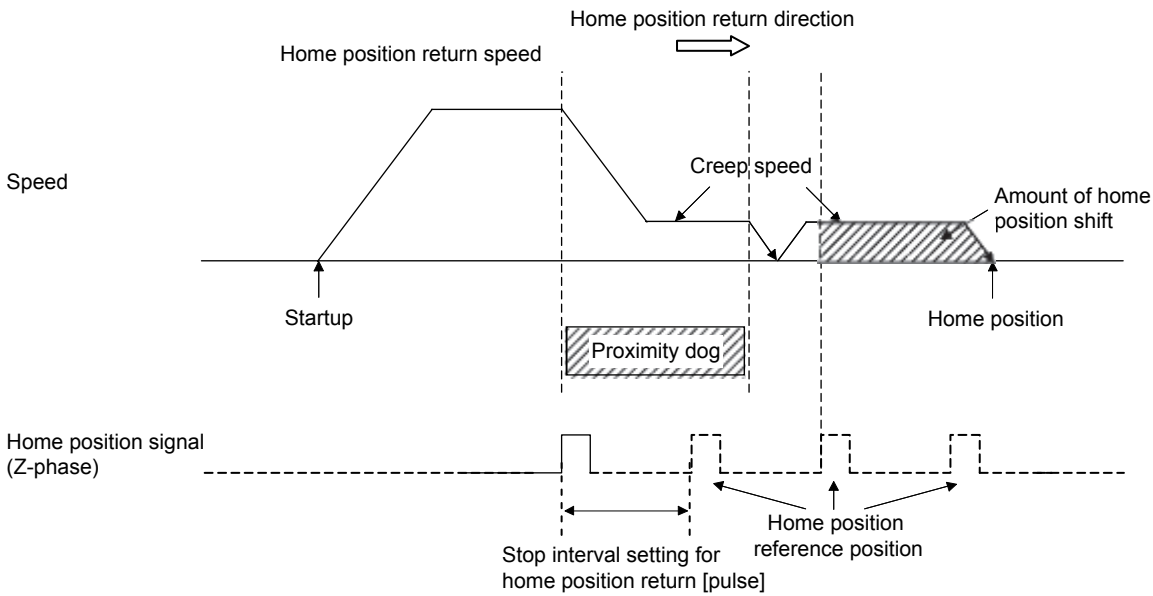

- Note 1. Adjust the position of the proximity dog sensor so that a stop position following the passed proximity dog is not near the reference home position. The reference home position may differ due to dispersion in the proximity dog signal detection, etc., which may prevent normal completion of the home position return.
2. When the reference home position is passed during deceleration after the proximity dog is passed, the reference home position that is the closest to the home position direction is defined as the home position.

For other precautions, refer to the Servo Amplifier Instruction Manual for your servo amplifier.

(c) Home position return process for tandem drive axes

The following shows an example of the home position return for the tandem drive axes. In this example, the scale home position signal detection method is used as a home position method. The scale home position signal detection method has the adjustment mode and the normal mode, which can be selected in the tandem drive options (parameter No.0265).

- Adjustment mode: This mode is used, for example, during adjustment at factory shipment, and is used to calculate the home position signal offset (amount of deviation in the position of the home position signal for the master axis and slave axis) on a linear scale.
- Normal mode: In this mode, the amount of deviation between the master axis and slave axis is detected and tweaking (compensation of deviation between master axis and slave axis) is performed. This movement sets the axis linking the master axis and slave axis mechanically at a right angle to the movement direction.

1) In adjustment mode

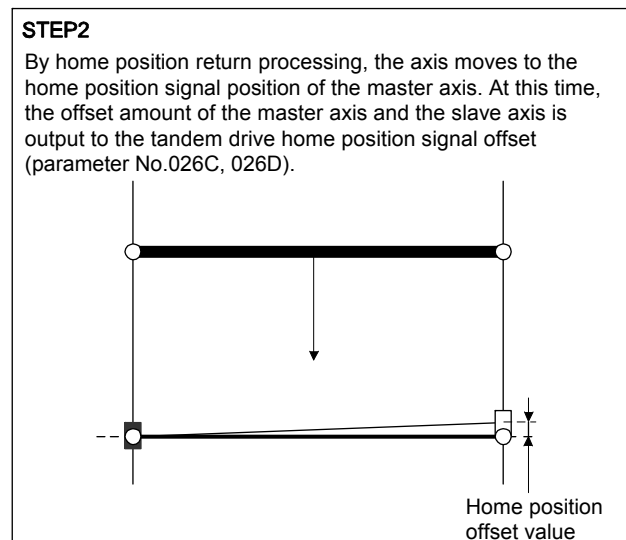
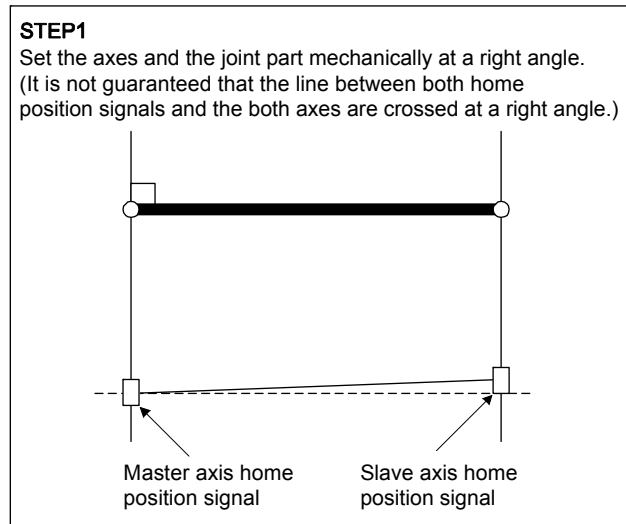
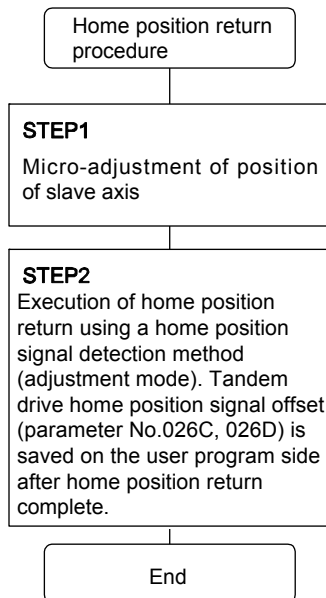

2) In normal mode

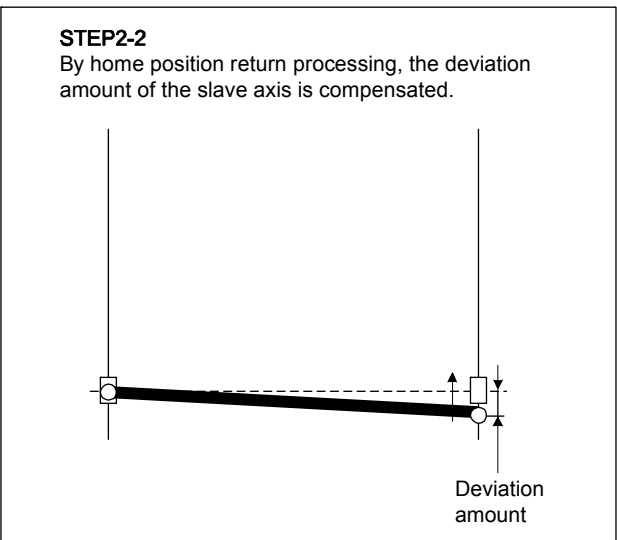
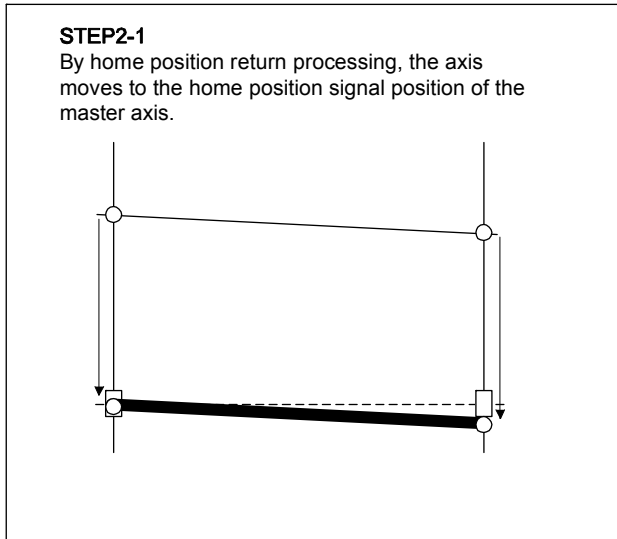
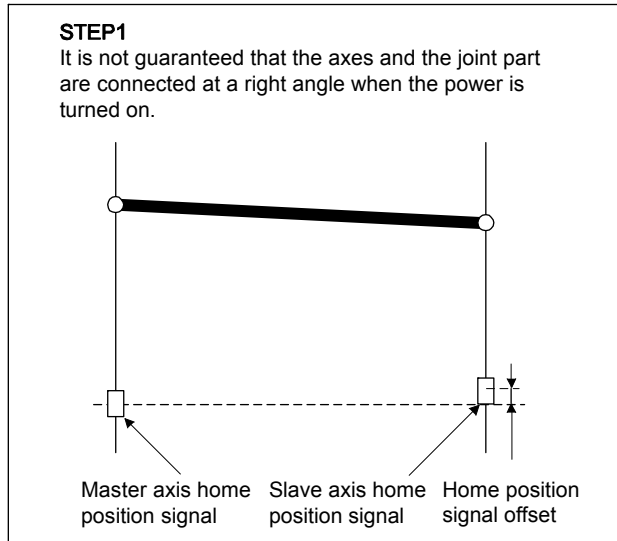
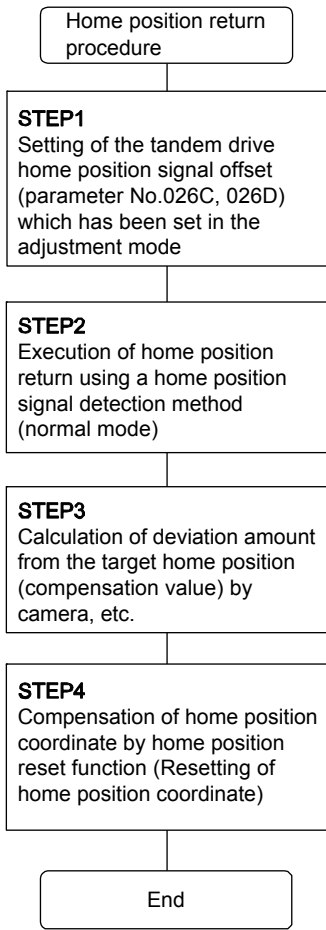

APPENDIX

(d) Monitor

The following monitor numbers are added.

1) Servo information (2)

Monitor No.	Description	Unit	Description
0246	Load side encoder information data 1 (lower)		For incremental type linear encoder, displays the counter from power on. For absolute position type linear encoder, displays the absolute position data.
0247	Load side encoder information data 1 (upper)		
0248	Load side encoder information data 2 (lower)		For incremental type linear encoder, displays the distance (No. of pulses) from reference mark (Z-phase). For absolute position type linear encoder, displays "00000000".
0249	Load side encoder information data 2 (upper)		
024A	Speed feedback (lower)	0.01mm/s	Displays motor speed in units of 0.01mm/s.
024B	Speed feedback (upper)		

For the following monitor numbers, the monitor data details vary from those of a rotary servo motor.

2) Servo information (1)

Monitor No.	Description	Unit	Description
0112	Motor rated revolution speed	r/min	Displays the value calculated in the equations shown below. Motor rated speed [m/s] × 1000 × 1000 × 60 / Scale resolution [μm/pulse] / Stop interval at home position return [pulse]
0114	Motor maximum revolution speed	r/min	Displays the value calculated in the equations shown below. Motor rated speed [m/s] × 1000 × 1000 × 60 / Scale resolution [μm/pulse] / Stop interval at home position return [pulse]
0116	Number of encoder pulses per revolution (lower)	pulse	Displays the stop interval during home position return set in parameter No.1300 (**LIT1).
0117	Number of encoder pulses per revolution (upper)		
0119	Initial within 1 revolution position (lower)	pulse	Displays the within one-revolution position (Note 1) at the time of power-on.
011A	Initial within 1 revolution position (upper)		
011B	Initial multiple revolution data	rev	Displays the multi-revolution data (Note 2) at the time of power-on.

APPENDIX

3) Servo information (2)

Monitor No.	Description	Unit	Description
0208	Speed feedback (lower)	0.01mm/s	Displays motor speed in units of 0.01mm/s.
0209	Speed feedback (upper)		
020E	Detector within 1 revolution position (lower)	pulse	Displays the current position within one-revolution. (Note 1)
020F	Detector within 1 revolution position (upper)		
0210	Home position within 1 revolution position (lower)	pulse	Displays the home position within one-revolution. (Note 1)
0211	Home position within 1 revolution position (upper)		
0214	Multiple revolution counter	rev	Displays the current multiple revolution counter. (Note 2)
0215	Home position multiple revolution data	rev	Displays the home position multi-revolution data. (Note 2)

Note 1. Incremental linear encoder : Setting the position at the time of power on as 0, the position normalized by the stop interval during home position.

Absolute position linear encoder : Setting the linear encoder home position (absolute position data = 0), the position normalized by the stop interval during home position.

2. Incremental linear encoder : Setting the position at the time of power on as 0, the counter that counts up or down by the stop interval during home position return.

Absolute position linear encoder : Setting the linear encoder home position (absolute position data = 0), the counter that counts up or down by the stop interval during home position return.

(e) Command units

When using speed control mode in interface mode, the conversion of data in units of 0.01r/min is required. The formula for conversion is as follows.

$$\text{Speed command [0.01r/min]} = \frac{\text{Speed command[m/s]} \times 1000 \times 1000 \times 60 \times 100}{\text{Linear encoder resolution}[\mu\text{m/pulse}] \times \text{Stop interval setting for home position return[pulse]}}$$

$$\text{Linear encoder resolution} [\mu\text{m/pulse}] = \frac{\text{Linear encoder resolution setting Numerator (Parameter No.1301)}}{\text{Linear encoder resolution setting Denominator (Parameter No.1302)}}$$

APPENDIX

App. 2 Supplementary explanation for the use of fully closed loop system

App. 2.1 Q173SCCF

The software versions of the Q173SCCF that can set up the fully closed loop system are as follows.

C Controller interface module	Software version
Q173SCCF	A3 or later

App. 2.2 Utility software

The utility software versions supporting Q173SCCF are as follows.

Utility software	Software version
SW1DNC-QSCCF-B	Ver. 1.50 or later

App. 2.3 Servo amplifier

The software versions of the servo amplifier that can set up the fully closed loop system with the Q173SCCF are as follows.

Servo amplifier	Software version
MR-J4(W□)-□B	A3 or later

For detailed specifications of the servo amplifier, refer to the Servo Amplifier Instruction Manual for your servo amplifier.

App. 2.4 Operations and functions of the fully closed loop control

(1) Startup procedure

The fully closed loop system startup procedures are as follows.

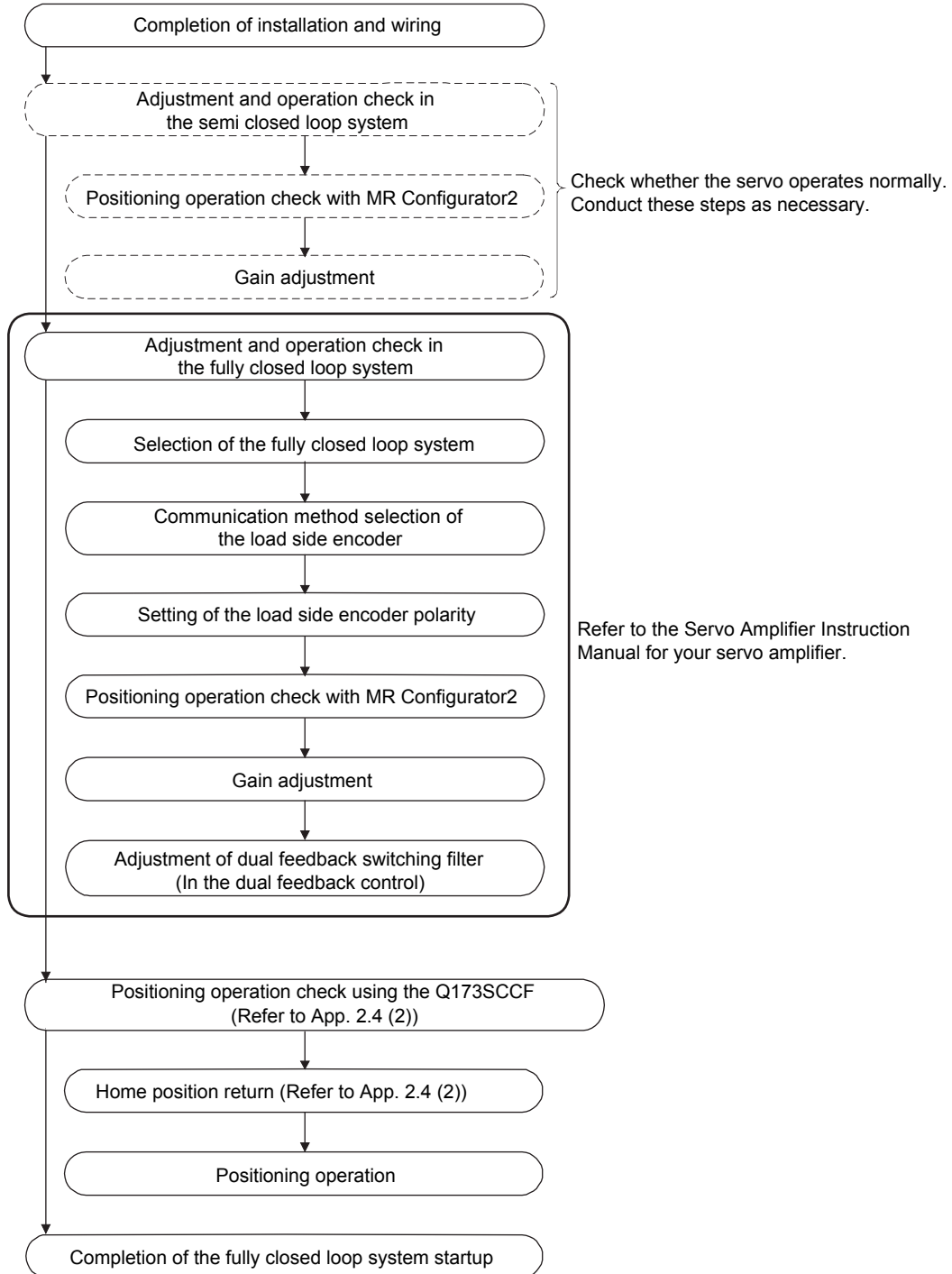

APPENDIX

(2) Operation from the Q173SCCF

Positioning operation using the Q173SCCF is basically the same as operation for using a rotary servo motor.

However, some parameters, home position return operation, command/status bit, and monitor No. vary from when using a rotary servo motor. Details are as follows.

(a) Parameters

When using the fully closed loop system, set the parameters shown on the table below.

For other servo parameters, control parameters, and system parameters, set them as equivalent to using a rotary servo motor.

1) Servo parameters

For details on each parameter, refer to the Servo Amplifier Instruction Manual for your servo amplifier.

<MR-J4(W□)-□B>

Parameter No.	MR-J4-B Parameter No.	Abbreviation (Note)	Name
1100	PA01	**STY	Operation mode
1190	PC17	**COP4	Function selection C-4
119A	PC27	**COP9	Function selection C-9
1200	PE01	**FCT1	Fully closed loop function selection 1
1202	PE03	*FCT2	Fully closed loop function selection 2
1203	PE04	**FBN	Fully closed loop control feedback pulse electronic gear numerator 1
1204	PE05	**FBD	Fully closed loop control feedback pulse electronic gear denominator 1
1205	PE06	BC1	Fully closed loop control speed deviation error detection level
1206	PE07	BC2	Fully closed loop control position deviation error detection level
1207	PE08	DUF	Fully closed loop dual feedback filter
1209	PE10	FCT3	Fully closed loop function selection 3
1221	PE34	**FBN2	Fully closed loop control feedback pulse electronic gear numerator 2
1222	PE35	**FBD2	Fully closed loop control feedback pulse electronic gear denominator 2

Note. The parameters with a * mark at the front of the abbreviation are validated according to the following conditions.

*: After setting, turn off the power supply and then on again, or reset controller.

**: After setting, turn off the power supply and then on again.

2) Control parameters

Parameter No.	Abbreviation (Note 1)	Name	Initial value	Unit	Setting range	Function
020A	*CMXL	Electronic gear numerator (lower)	0001h		1 to 5242879 (32 bit) (Note2)	Set the numerator of the electronic gear. (For setting methods, refer to App. 2.4(2)(a)3.)
020B	*CMXH	Electronic gear numerator (upper)	0000h			
020C	*CDVL	Electronic gear denominator (lower)	0001h		1 to 589823 (32 bit) (Note2)	Set the denominator of the electronic gear. (For setting methods, refer to App. 2.4(2)(a)3.)
020D	*CDVH	Electronic gear denominator (upper)	0000h			
021D	*VEND	Vendor ID	0000h		0000h to FFFFh	Set the vendor ID. 0000h: Mitsubishi Electric
021E	*CODE	Type code	1000h		0000h to FFFFh	Set the type code. 1000h: MR-J4(W□)-□B servo amplifier

Note 1. The settings for the parameters with a * mark at the front of the abbreviation are validated when the system is started.

2. The setting range differs depending on the setting of speed units (parameter No.0200). For details on the setting range, refer to Section 6.1.1.

3) Setting example of electronic gears

For the electronic gear numerator (CMX), set the number of linear encoder pulses (= load side resolution unit) per revolution of the servo motor, not the number of pulses per revolution of the servo motor.

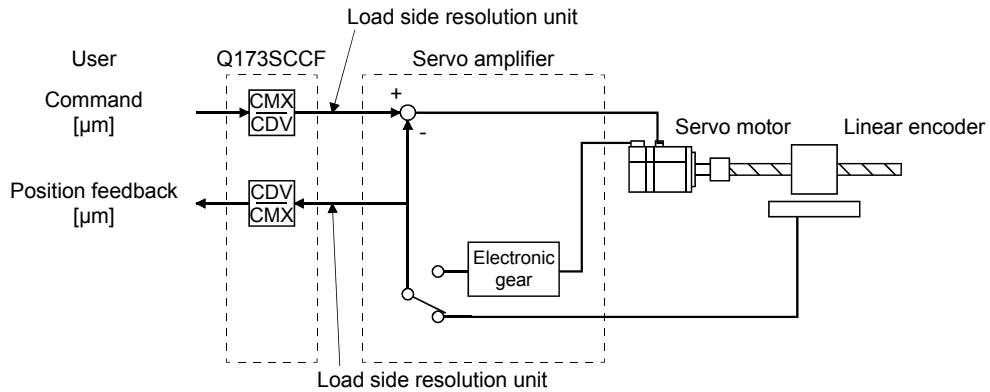

Conditions:

Command unit: μm

Ball screw lead: 20 mm

Linear encoder resolution: $0.05 \mu\text{m}$

Ball screw lead / Linear encoder resolution = $20 \text{ mm} / 0.05 \mu\text{m} = 400000 \text{ pulses}$

$$\frac{\text{Number of pulses per revolution [pulse] (CMX)}}{\text{Travel distance per revolution } [\mu\text{m}] \text{ (CDV)}} = \frac{400000 \text{ pulses}}{20 \text{ mm}} = \frac{400000}{20000} = \frac{20}{1}$$

APPENDIX

(b) Home position return operation

The home position return operation from the Q173SCCF is basically the same as operation for using a rotary servo motor.

However, when using the incremental linear scale, it is recommended to use the scale home position signal detection method or the scale home position signal detection method 2. In this case, the home position return is performed based on the home position signal (Z-phase). The reference home position which is created based on the number of encoder pulses per revolution of the servo motor is not used.

<Control parameter>

Parameter No.	Abbreviation (Note 1)	Name	Initial value	Unit	Setting range	Function
0240	*OPZ1	Home position return option 1	0000h		0000h to 112Dh	<div style="display: flex; align-items: center;"> <div style="border: 1px solid black; padding: 2px; margin-right: 5px;">0</div> <div style="border: 1px solid black; padding: 2px; margin-right: 5px;">0</div> <div style="border: 1px solid black; padding: 2px; margin-right: 5px;">0</div> <div style="border: 1px solid black; padding: 2px; margin-right: 5px;"> </div> </div> <p>Home position return method (Note) Set the method for home position return. 0: Dog method 2: Data set method 3: Stopper method 4: Dog cradle method 5: Limit switch combined method 6: Scale home position signal detection method 7: Limit switch front end method 8: Dog front end method C: Z-phase detection method D: Scale home position signal detection method 2 Note. Can be changed while system is running. (Software version A5 or later)</p>

Note 1. *: Setting will be valid at system startup.

The home position return using a Z-phase detection method cannot be used.

When using a home position return method other than the scale home position signal detection method or the scale home position signal detection method 2, "1□□□" (Search again) must be set for the parameter No.0240 (*OPZ1).

<Control parameter>

Parameter No.	Abbreviation (Note 1)	Name	Initial value	Unit	Setting range	Function
0240	*OPZ1	Home position return option 1	0000h		0000h to 112Dh	<div style="display: flex; align-items: center;"> <div style="border: 1px solid black; padding: 2px; margin-right: 5px;"> </div> <div style="border: 1px solid black; padding: 2px; margin-right: 5px;">0</div> <div style="border: 1px solid black; padding: 2px; margin-right: 5px;">0</div> <div style="border: 1px solid black; padding: 2px; margin-right: 5px;">0</div> </div> <p>Home position signal additional search (Note) Set "1" when using an incremental encoder or incremental linear scale. 0: Do not search again 1: Search again Note. Can be changed while system is running. (Software version A5 or later)</p>

Note 1. *: Setting will be valid at system startup.

For other precautions, refer to the Servo Amplifier Instruction Manual for your servo amplifier.

APPENDIX

(c) Bit information

The following bit (in the thick frame) is used to switch between the semi closed loop control and fully closed loop control.

The switching between the semi closed loop control and fully closed loop control is set with the parameter No.1200 (MR-J4(W□)-□B parameter No.PE01).

1) Command bit

Address	Bit	Symbol	Signal name	When tandem drive is being used	Description
0308	0	GAIN	Gain changing command	Each axis	
	1	CLD	Fully closed loop control change command	Each axis	0: Semi closed loop control 1: Dual feedback control (Fully closed loop control)
	2		Reserved		
	3	CPC	PID control command	Each axis	
	4		Reserved		
	5				
	6				
	7				

2) Status bit

Address	Bit	Symbol	Signal name	When tandem drive is being used	Description
0348	0	GAIN	During gain switching	Each axis	
	1	CLDO	Fully closed loop control changing	Each axis	0: During semi closed loop control 1: During dual feedback control (During fully closed loop control)
	2	TLSO	Selecting torque limit	Each axis	
	3	SPC	During PID control	Each axis	
	4		Reserved		
	5				
	6				
	7				

APPENDIX

(d) Monitor

The following monitor numbers are added.

1) Servo information (2)

Monitor No.	Description	Unit	Description
0240	Selected droop pulse (lower)	pulse	The data set to the second digit from the upper of the parameter No.1209 (MR-J4(W□)-□B parameter No.PE10) is output.
0241	Selected droop pulse (upper)		
0244	Selected cumulative feed pulses (lower)	pulse	The data set to the first digit from the upper of the parameter No.1209 (MR-J4(W□)-□B parameter No.PE10) is output.
0245	Selected cumulative feed pulses (upper)		
0246	Load side encoder information data 1 (lower)		For incremental type linear encoder, displays the counter from power on. For absolute position type linear encoder, displays the absolute position data.
0247	Load side encoder information data 1 (upper)		
0248	Load side encoder information data 2 (lower)		For incremental type linear encoder, displays the distance (No. of pulses) from reference mark (Z-phase). For absolute position type linear encoder, displays "00000000".
0249	Load side encoder information data 2 (upper)		

For the following monitor numbers, the monitor data details vary from those of a rotary servo motor.

2) Servo information (1)

Monitor No.	Description	Unit	Description (upper: data, lower: unit) (Note 1)		
			Semi closed loop system (Note 2)	Fully closed loop system (Note 2)	
				Semi closed loop control (Note 2)	Fully closed loop control (Note 2)
0112	Motor rated revolution speed	r/min	Motor side Motor unit	Motor side Motor unit	Motor side Motor unit
0114	Motor maximum revolution speed	r/min	Motor side Motor unit	Motor side Motor unit	Motor side Motor unit
0116	Number of encoder pulses per revolution (lower)	pulse	Motor side Motor unit	Load side Machine unit	Load side Machine unit
0117	Number of encoder pulses per revolution (upper)				
0119	Initial within 1 revolution position (lower)	pulse	Motor side Motor unit	Motor side Machine unit	Load side Machine unit
011A	Initial within 1 revolution position (upper)				
011B	Initial multiple revolution data	rev	Motor side Motor unit	Motor side Machine unit	Load side Machine unit

Note 1. Data : Motor side → Data from the servo motor encoder

Load side → Data from the load side encoder

Unit : Motor unit → Motor side encoder resolution unit

Machine unit → Load side encoder resolution unit

Note 2. For the definitions of the semi closed loop system, the fully closed loop system, the semi closed loop control, and the fully closed loop control, refer to the Servo Amplifier Instruction Manual for your servo amplifier.

APPENDIX

3) Servo information (2)

Monitor No.	Description	Unit	Description (upper: data, lower: unit) (Note 1)		
			Semi closed loop system (Note 2)	Fully closed loop system (Note 2)	
				Semi closed loop control (Note 2)	Fully closed loop control (Note 2)
0200	Position feedback (lower)	pulse	Motor side	Motor side	Load side
0201	Position feedback (upper)		Motor unit	Machine unit	Machine unit
0204	Position droop (lower)	pulse	Motor side	Motor side	Load side
0205	Position droop (upper)		Motor unit	Machine unit	Machine unit
0208	Speed feedback (lower)	0.01r/min	Motor side	Motor side	Motor side
0209	Speed feedback (upper)		Motor unit	Motor unit	Motor unit
020E	Detector within 1 revolution position (lower)	pulse	Motor side	Motor side	Load side
020F	Detector within 1 revolution position (upper)		Motor unit	Machine unit	Machine unit
0210	Home position within 1 revolution position (lower)	pulse	Motor side	Motor side	Load side
0211	Home position within 1 revolution position (upper)		Motor unit	Machine unit	Machine unit
0212	ZCT (lower)	pulse	Motor side	Motor side	Load side
0213	ZCT (upper)		Motor unit	Machine unit	Machine unit
0214	Multiple revolution counter	rev	Motor side	Motor side	Load side
			Motor unit	Machine unit	Machine unit
0215	Home position multiple revolution data	rev	Motor side	Motor side	Load side
			Motor unit	Machine unit	Machine unit

Note 1. Data : Motor side → Data from the servo motor encoder

Load side → Data from the load side encoder

Unit : Motor unit → Motor side encoder resolution unit

Machine unit → Load side encoder resolution unit

Note 2. For the definitions of the semi closed loop system, the fully closed loop system, the semi closed loop control, and the fully closed loop control, refer to the Servo Amplifier Instruction Manual for your servo amplifier.

4) Operation information

The contents of the following table are also applied to the corresponding monitor numbers of operation information (double word).

Monitor No.	Description	Unit	Description (upper: data, lower: unit) (Note 1)		
			Semi closed loop system (Note 2)	Fully closed loop system (Note 2)	
				Semi closed loop control (Note 2)	Fully closed loop control (Note 2)
0308	Grid size (lower)	pulse	Motor side	Motor side	Load side
0309	Grid size (upper)		Motor unit	Machine unit	Machine unit
0310	Current command position (lower)	pulse	Motor side	Motor side	Load side
0311	Current command position (upper)		Motor unit	Machine unit	Machine unit
0312	Current feedback position (lower)	pulse	Motor side	Motor side	Load side
0313	Current feedback position (upper)		Motor unit	Machine unit	Machine unit
0314	F Δ T (lower)	pulse	Motor side	Motor side	Load side
0315	F Δ T (upper)		Motor unit	Machine unit	Machine unit

Note 1. Data : Motor side → Data from the servo motor encoder

Load side → Data from the load side encoder

Unit : Motor unit → Motor side encoder resolution unit

Machine unit → Load side encoder resolution unit

Note 2. For the definitions of the semi closed loop system, the fully closed loop system, the semi closed loop control, and the fully closed loop control, refer to the Servo Amplifier Instruction Manual for your servo amplifier.

App. 3 Supplementary explanation for the use of direct drive servo system

App. 3.1 Q173SCCF

The software versions of the Q173SCCF that can set up the direct drive servo system are as follows.

C Controller interface module	Software version
Q173SCCF	A3 or later

App. 3.2 Utility software

The utility software versions supporting Q173SCCF are as follows.

Utility software	Software version
SW1DNC-QSCCF-B	Ver. 1.50 or later

App. 3.3 Servo amplifier

The servo amplifier MR-J4(W□)-□B can set the direct drive servo system with the Q173SCCF.

For detailed specifications of the servo amplifier, refer to the Servo Amplifier Instruction Manual for your servo amplifier.

App. 3.4 Operations and functions of the direct drive servo system

(1) Startup procedure

The direct drive servo system startup procedures are as follows.

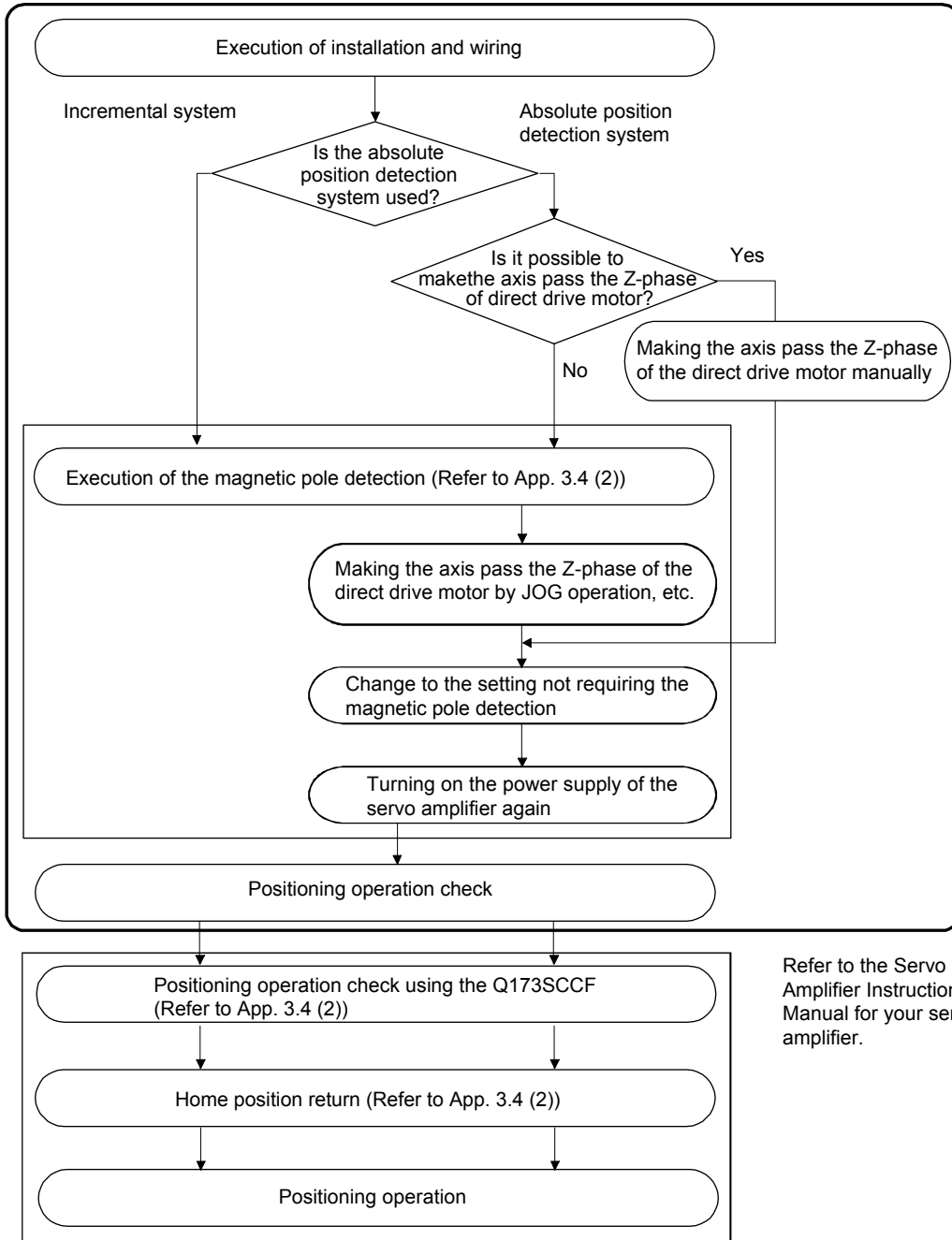

Refer to the Servo Amplifier Instruction Manual for your servo amplifier.

APPENDIX

(2) Operation from the Q173SCCF

Positioning operation using the Q173SCCF is basically the same as operation for using a rotary servo motor.

However, some parameters, home position return operation, command/status bit, and monitor No. vary from when using a rotary servo motor. Details are as follows.

(a) Parameters

When using the direct drive system, set the parameters shown on the table below.

For other servo parameters, control parameters, and system parameters, set them as equivalent to using a rotary servo motor.

1) Servo parameters

For details on each parameter, refer to the Servo Amplifier Instruction Manual for your servo amplifier.

<MR-J4(W□)-□B>

Parameter No.	MR-J4-B Parameter No.	(Note) Abbreviation	Name
1100	PA01	**STY	Operation mode
1180	PC01	ERZ	Error excessive alarm level
1182	PC03	*ENRS	Encoder output pulse selection
1300	PL01	**LIT1	Linear servo motor/DD motor function selection 1
1303	PL04	*LIT2	Linear servo motor/DD motor function selection 2
1304	PL05	LB1	Position deviation error detection level
1305	PL06	LB2	Speed deviation error detection level
1306	PL07	LB3	Torque/thrust deviation error detection level
1307	PL08	*LIT3	Linear servo motor/DD motor function selection 3
1308	PL09	LPWM	Magnetic pole detection voltage level
1310	PL17	LTSTS	Magnetic pole detection - Minute position detection method - Function selection
1311	PL18	IDLV	Magnetic pole detection - Minute position detection method - Identification signal amplitude

Note. The parameters with a * mark at the front of the abbreviation are validated according to the following conditions.

*: After setting, turn off the power supply and then on again, or reset controller.

**: After setting, turn off the power supply and then on again.

2) Control parameters

Parameter No.	(Note1) Abbreviation	Name	Initial value	Unit	Setting range	Function
020A	*CMXL	Electronic gear numerator (lower)	0001h		1 to 5242879 (32 bit) (Note2)	Set the numerator of the electronic gear. (For setting methods, refer to App. 3.4(2)(c).)
020B	*CMXH	Electronic gear numerator (upper)	0000h			
020C	*CDVL	Electronic gear denominator (lower)	0001h		1 to 589823 (32 bit) (Note2)	Set the denominator of the electronic gear. (For setting methods, refer to App. 3.4(2)(c).)
020D	*CDVH	Electronic gear denominator (upper)	0000h			
021D	*VEND	Vendor ID	0000h		0000h to FFFFh	Set the vendor ID. 0000h: Mitsubishi Electric
021E	*CODE	Type code	1000h		0000h to FFFFh	Set the type code. 1000h: MR-J4(W□)-□B servo amplifier

Note1. The settings for the parameters with a * mark at the front of the abbreviation are validated when the system is started.

2. The setting range differs depending on the setting of speed units (parameter No.0200). Refer to Section 6.1.1.

APPENDIX

(b) Home position return operation

The home position return operation from the Q173SCCF is basically the same as operation for using a rotary servo motor.

When the home position return is performed using the Q173SCCF, it is recommended to use the scale home position signal detection method 2. In this case, the home position return is performed based on the first home position signal (Z-phase) following start operation.

<Control parameter>

Parameter No.	(Note 1) Abbreviation	Name	Initial value	Unit	Setting range	Function
0240	*OPZ1	Home position return option 1	0000h		0000h to 112Dh	<div style="display: flex; align-items: center;"> <div style="border: 1px solid black; padding: 2px; margin-right: 5px;">0</div> <div style="border: 1px solid black; padding: 2px; margin-right: 5px;">0</div> <div style="border: 1px solid black; padding: 2px; margin-right: 5px;">0</div> <div style="border: 1px solid black; padding: 2px; margin-right: 5px;">0</div> </div> <p>Home position return method (Note) Set the method for home position return. 0: Dog method 2: Data set method 3: Stopper method 4: Dog cradle method 5: Limit switch combined method 6: Scale home position signal detection method 7: Limit switch front end method 8: Dog front end method C: Z-phase detection method D: Scale home position signal detection method 2 Note. Can be changed while system is running. (Software version A5 or later)</p>

Note 1. *: Setting will be valid at system startup.

The home position return using a Z-phase detection method cannot be used.

When using a home position return method other than the scale home position signal detection method or the scale home position signal detection method 2, "1□□□" (Search again) must be set for the parameter No.0240 (*OPZ1).

<Control parameter>

Parameter No.	(Note 1) Abbreviation	Name	Initial value	Unit	Setting range	Function
0240	*OPZ1	Home position return option 1	0000h		0000h to 112Dh	<div style="display: flex; align-items: center;"> <div style="border: 1px solid black; padding: 2px; margin-right: 5px;">1</div> <div style="border: 1px solid black; padding: 2px; margin-right: 5px;">0</div> <div style="border: 1px solid black; padding: 2px; margin-right: 5px;">0</div> <div style="border: 1px solid black; padding: 2px; margin-right: 5px;">0</div> </div> <p>Home position signal additional search (Note) Set "1" when using an incremental encoder or incremental linear scale. 0: Do not search again 1: Search again Note. Can be changed while system is running. (Software version A5 or later)</p>

Note 1. *: Setting will be valid at system startup.

For other precautions, refer to the Servo Amplifier Instruction Manual for your servo amplifier.

(c) Position command unit

As "degree" cannot be used as a position command unit, note the following when using the axis as a degree axis.

POINT
<ul style="list-style-type: none"> ▪ For positioning the automatic operation, etc., set "Relative position command" to the auxiliary command of the point table, and set the difference of the travel distance to the target position in the position data. Also, the rotating direction is determined by the code of the position data. Use the user program for shortcut control of a degree axis. ▪ The function to judge based on the current command position or the current feedback position such as the position switch, software limit, other axes start cannot be used.

1) When the movement range is limited (-2147483648 to 2147483647)

For the electronic gear setting, set values so that conversion from travel distance per motor revolution to the number of encoder pulses per revolution does not produce a round value for electronic gear processing.

In this case, the travel distance per motor revolution can be converted to the number of encoder pulses per revolution by the following formula.

Example: When the position command unit is 0.001° and the travel distance per motor revolution is 360000 [0.001°]

$$\frac{\text{Electronic gear numerator}}{\text{Electronic gear denominator}} = \frac{\text{Number of encoder pulses per revolution [pulse]}}{\text{Travel distance per motor revolution [position command unit]}} = \frac{\text{Number of encoder pulses per revolution [pulse]}}{360000}$$

$$\text{Travel distance per motor revolution [position command unit]} \times \frac{\text{Electronic gear numerator}}{\text{Electronic gear denominator}} = \text{Number of encoder pulses per revolution [pulse]}$$

2) When using the unlimited length feed such as an unidirectional feed

When the travel distance per motor revolution is a power of two, the unlimited length feed can be used. As the monitor of a current command position is 4 bytes in size, unidirectional feed causes the overflow of current command position. Even though overflowed high-byte data is lost, the range of 4 bytes normally continues to be updated. And positioning control is not affected. (Position mismatch does not occur.)

To control the axis as a degree axis, use the user program process to convert the current command position to the ring counter. As necessary, perform the same process for the current feedback position. The conversion process of the ring counter is as follows.

Example: When the command unit of the user program (user program command unit) is 0.001° and the range of the ring counter is 0 to 359999 [0.001°]

In this example, the travel distance per motor revolution is a power of two (2^{20}), and the unit is the position command unit of the Q173SCCF (Q173SCCF command unit).

The user program uses the user program electronic gear for converting the user program command unit to the Q173SCCF command unit when the position command (position data, parameter, etc.) is set in the Q173SCCF. Also, when the Q173SCCF current command position is referred, the user program uses the user program electronic gear for converting the Q173SCCF command unit to the user program command unit (ring counter) inversely.

The relationship of each command unit is as follows.

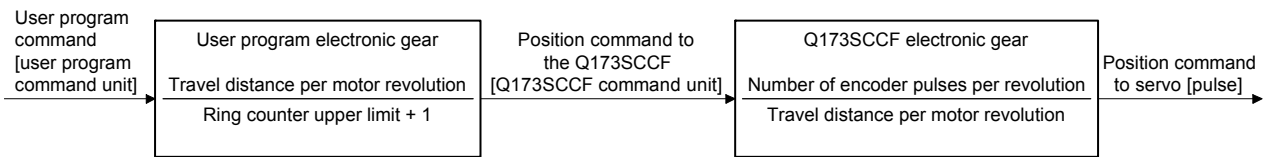

Note. Processed by user program.

(i) Conversion from the user program position command [user program command unit] to the position command to the Q173SCCF (position data) [Q173SCCF command unit]

$$\begin{aligned} \text{Position data} &= \text{User program position command} \times \frac{\text{Travel distance per motor revolution}}{\text{Ring counter upper limit} + 1} \\ &= \text{User program position command} \times \frac{2^{20}}{360000} \end{aligned}$$

(ii) Inverse conversion from current command position [Q173SCCF command unit] to ring counter [user program command unit]

$$\begin{aligned} \text{Ring counter} &= \{ \text{Current command position} \& \text{ (Travel distance per motor revolution - 1)} \} \times \frac{\text{Ring counter upper limit} + 1}{\text{Travel distance per motor revolution}} \\ &= (\text{Current command position} \& \text{ 0x000FFFFF}) \times \frac{360000}{2^{20}} \end{aligned}$$

(d) Absolute position detection system

When the travel distance from the home position exceeds the value calculated from $32767 \times$ (number of encoder pulses per revolution) due to a unidirectional feed, etc., the absolute position cannot be restored. To restore the absolute position, when turning off the power supply at a position out of the range where the absolute position is restorable, establish the home position again by the home position reset function or the home position return, and store the home position information (home position multiple revolution data and home position within 1 revolution position) to the user program side.

App. 4 Supplementary explanation for the use of multiple-axis servo amplifier (MR-J4W□-□B)

App. 4.1 Q173SCCF

The software versions of the Q173SCCF that can be connected with a multiple-axis servo amplifier (MR-J4W□-□B) are as follows.

C Controller interface module	Software version
Q173SCCF	A3 or later

App. 4.2 Utility software

The utility software versions supporting Q173SCCF are as follows.

Utility software	Software version
SW1DNC-QSCCF-B	Ver. 1.50 or later

App. 4.3 Servo amplifier

For detailed specifications of a multiple-axis servo amplifier (MR-J4W□-□B), refer to the Servo Amplifier Instruction Manual for your servo amplifier.

POINT
<ul style="list-style-type: none"> ▪ When the control cycle is 0.22ms, MR-J4W3-□B cannot be used. ▪ The fully closed loop system can be used for the servo amplifier MR-J4(W□)-□B whose software version is A3 or later.

App. 4.4 Operations and functions of the servo amplifier

(1) Startup procedure

With one multiple-axis servo amplifier (MR-J4W□-□B), a rotary servo motor, linear servo motor, fully closed loop system, and direct drive motor can be used in combination.

For the use of a rotary servo motor, refer to Section 4.1.

For the use of a linear servo motor, refer to App. 1. For the use of the fully closed loop system, refer to App. 2. For the use of the direct drive motor, refer to App. 3.

POINT
<ul style="list-style-type: none"> ▪ For the all axes used with the multiple-axis servo amplifier (MR-J4W□-□B), always set "Controlled" to the control option 1 (parameter No.0200). When "Not controlled" is set, the system cannot start properly. ▪ For a multiple-axis servo amplifier (MR-J4W□-□B), the number of axis used can be changed using the control axis invalid switch (SW2). Deactivate unused axes.

(2) Operation from the Q173SCCF

Positioning operation using the Q173SCCF is basically the same as operation for using a rotary servo motor. For the use of a linear servo motor, refer to App. 1. For the use of the direct drive motor, refer to App. 3.

(a) Parameters

For servo parameters, control parameters, and system parameters, set them in the same way as the operation mode to be used (rotary motor, linear, fully closed loop system, and direct drive).

App. 5 Supplementary explanation for the use of servo amplifier (MR-JE-□B)

App. 5.1 Q173SCCF

The software versions of the Q173SCCF that can use servo amplifier (MR-JE-□B) are as follows.

C Controller interface module	Software version
Q173SCCF	A7 or later

App. 5.2 Utility software

The utility software versions supporting Q173SCCF are as follows.

Utility software	Software version
SW1DNC-QSCCF-B	Ver. 1.70 or later

App. 5.3 Servo amplifier

For detailed specifications of a servo amplifier (MR-JE-□B), refer to the Servo Amplifier Instruction Manual for your servo amplifier.

POINT
<ul style="list-style-type: none"> ▪ Servo amplifier (MR-JE-□B) does not support SSCNETⅢ communication. Use the servo amplifier in an SSCNETⅢ/H system. ▪ Control cycle 0.22ms is not supported. When the system is start with the control cycle as 0.22ms and a servo amplifier (MR-JE-□B) connected, the system is on standby for start and a communication cycle error (system error E40E) occurs. ▪ Servo amplifier (MR-JE-□B) can connect up to 16 axes on 1 line with SSCNETⅢ/H. When using 17 axes or more, up to 20 axes can be controlled on 1 line by using MR-JE-□B together with MR-J4(W□)-□B.

APPENDIX

App. 5.4 System configuration

App. 5.4.1 System configuration diagram

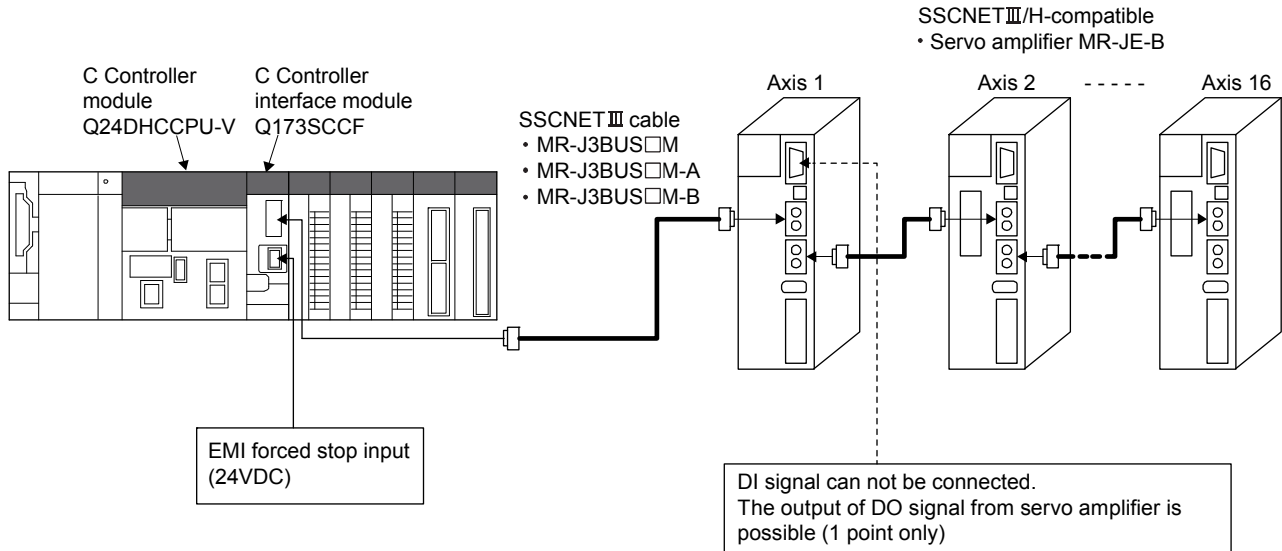

POINT
<ul style="list-style-type: none"> DI signals (LSP/LSN/DOG) cannot be input to servo amplifier (MR-JE-□B). When using sensor input, set a value other than "1: Driver input" to sensor input option (parameter No.0219). When inputting the sensor input from dual port (setting "4: Dual port memory input" to sensor input option), periodically updating the input status is necessary. Also, to take into consideration when the C Controller module is hangup, use together with the user watchdog function. Refer to Section 6.28 and Section 7.7 for details.

APPENDIX

App. 5.5 Axis No. setting

App. 5.5.1 Servo amplifier setting

Axis No. of MR-JE-□B is set by the axis selection rotary switch (SW1) on the servo amplifier. Servo amplifier axis No. and rotary switch setting are correlated as shown on the table below. Set the axis No. of the servo amplifier so that it will not duplicate in the same line. If it is duplicated, the "An axis that has not been mounted exists" (system error E400) will occur at the time of system startup (system command code: 000Ah).

Servo amplifier axis No.	Axis selection rotary switch	Servo amplifier display (3-digit, 7-segment indicator)
d1	0	01
d2	1	02
d3	2	03
d4	3	04
d5	4	05
d6	5	06
d7	6	07
d8	7	08
d9	8	09
d10	9	10
d11	A	11
d12	B	12
d13	C	13
d14	D	14
d15	E	15
d16	F	16

APPENDIX

App. 5.6 Parameter setting

App. 5.6.1 System option 1 setting

SSCNET communication method and control cycle is set by System option 1 (parameter No.0001).

SSCNET communication method is used for communication between a Q173SCCF and connected units such as servo amplifiers and SSCNETⅢ/H method and SSCNETⅢ method are available. When using MR-JE-□B servo amplifiers, make sure to select the SSCNETⅢ/H method.

Control cycle is a cycle in which the Q173SCCF conducts command import, position control, status output, and communication with servo amplifier. To set this cycle, use the control cycle (parameter No.0001). Servo amplifier (MR-JE-□B) does not support control cycle 0.22ms. When using servo amplifier (MR-JE-□B), make sure to select a control cycle other than 0.22ms.

The following shows the number of controllable axes according to the control cycle.

Control cycle	Max. No. of axes connected		Max. No. of axes connected for each line	Controllable axis No.
	Using MR-JE-□B only	Using together with MR-J4(W)-□B		
0.88ms	16 axes	20 axes	20 axes (Note)	Axis 1 to 20
0.44ms	16 axes	16 axes	16 axes	Axis 1 to 16

Note. When using 17 axes or more, use MR-JE-□B together with MR-J4(W□)-□B.

APPENDIX

Control cycle settings are imported during system startup (system command code: 000Ah), and cannot be changed during system running (system command code: 000Ah).

(1) System parameters

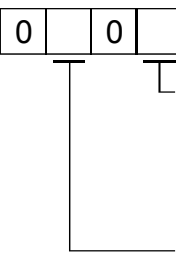
Parameter No.	Abbreviation	Name	Function
0001	*SYSOP1	System option 1	 <p>Control cycle setting 0: 0.88ms 1: 0.44ms 2: 0.22ms (Not use) Make sure to set a value other than "2: 0.22ms".</p> <p>SSCNET communication method Set the SSCNET communication method. 0: SSCNETⅢ/H 1: SSCNETⅢ (Not use) Make sure to set "0: SSCNETⅢ/H".</p>

(2) SSCNET communication method

Address	Name	Description
0008	SSCNET communication method	1: SSCNETⅢ
0009		2: SSCNETⅢ/H

App. 5.7 Axis No. assignment

With Axis No. assignment, the axis No. (on the Q173SCCF) can be assigned by the axis No. on the servo amplifier. Refer to Section 4.4.6 for details on axis No. assignment.

POINT

- | |
|---|
| <ul style="list-style-type: none">▪ When using servo amplifier (MR-JE-□B), the 17th servo amplifier axis No. and after cannot be set. |
|---|

APPENDIX

App. 5.8 Sensor input option setting

External signal (sensor) is connected by setting sensor input options (parameter No.0219). The servo amplifier (MR-JE-□B) does not support servo amplifier general input. When using servo amplifier (MR-JE-□B), set a value other than "1: Driver input" to sensor input system. Refer to Section 4.4.7 for details on sensor input options setting.

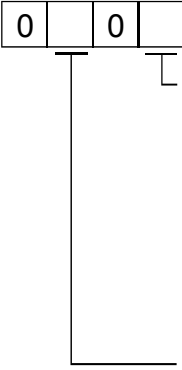
Parameter No.	Abbreviation	Name	Initial Value	Units	Setting range	Function
0219	*SOP	Sensor input options	0000h		0000h to 0304h	 <p>Sensor input system Set the input system of the sensor (LSP, LSN, DOG). 0: Not use 1: Driver input (prohibited) 2: Digital or input device input 3: Not connected (does not detect LSP, LSN, DOG) 4: Dual port memory input Make sure to set a value other than "1: Driver input".</p> <p>Limit switch signal selection Set valid/invalid of limit switch. 0: LSP/LSN are valid 1: LSP is valid, LSN is invalid 2: LSP is invalid, LSN is valid 3: LSP/LSN are invalid</p>

POINT
<ul style="list-style-type: none"> When "1: Driver input" is set in sensor input system, a parameter error (servo alarm 37) occurs for parameter No.11C2 to parameter No.11C4 (servo parameter PD03 to PD05).

APPENDIX

App. 5.9 Vendor ID and type code setting

When using servo amplifier (MR-JE-□B) set 1200h to the type code.

(1) Control parameters

Parameter No.	Abbreviation	Name	Function
021D	*VEND	Vendor ID	Set the vendor ID. 0000h: Mitsubishi Electric
021E	*CODE	Type code	Set the type code. 1200h: MR-JE-□B

APPENDIX

App. 5.10 Supported functions

Some functions and operation of the servo amplifier (MR-JE-□B) differ from those of the servo amplifier MR-J4(W□)-□B. This section mainly describes functions and operations different from those of the servo amplifier MR-J4(W□)-□B. For the specification items not described in this section, refer to the specifications of servo amplifier MR-J4(W□)-□B.

Supported function list

Function type	Function		Supported	Remarks	
Operational functions	JOG operation		○		
	Incremental feed		○		
	Automatic operation		○		
	Linear interpolation		○		
	Home position return		○		
	Home position reset function (data set function)		○		
Application functions	Command units	Electronic gear	○		
	Speed units	Speed units	○		
		Speed units multiplication factor	○		
		Speed limit	○		
	Acceleration/deceleration	Linear acceleration/deceleration		○	
		Smoothing filter		○	
		Start up speed validity		○	
		S-pattern acceleration/deceleration (Sine acceleration/deceleration)		○	
	Servo off		○		
	Forced stop		○		
	Stop operation		○		
	Rapid stop		○		
	Limit switch (stroke end)		○		
	Software limit		○		
	Interlock		○		
	Rough match output		○		
	Torque limit		○		
	Command change	Speed change		○	
		Change of time constants		○	
		Position change		○	
	Backlash		○		
	Position switch		○		
	Completion of operation signal		○		
	Interference check function		○		
	Home position search limit		○		
	Gain changing		○		
	PI-PID switching		○		
	Absolute position detection system		○		
	Home position return request		○		
	Other axes start		○		
	High response I/F		○		
	In-position signal		○		
	Digital I/O		○		
I/O device		○			
Servo amplifier general I/O		△	General input cannot be used. One point only can be used for general output.		
Dual port memory exclusive control		○			

APPENDIX

Function type	Function	Supported	Remarks
Application functions	Pass position interrupt	○	
	Mark detection	×	
	Continuous operation to torque control	○	
	SSCNET III/H head module connection	○	
	Sensing module connection	○	
Auxiliary function	Reading/writing parameters	○	
	Changing parameters at the servo	○	
	Alarm and system error	○	
	Monitor function	○	
	High speed monitor function	○	
	Interrupt	○	
	User watchdog function	○	
	Software reboot function	○	
	Parameter backup	○	
	Test mode	○	
	Reconnect/disconnect function	○	If MR-JE-□B is reconnected in a system with a 0.22ms control cycle, reconnection error (RCE) turns ON, and reconnection/disconnection error code 0006h (communication cycle error) occurs.
	Sampling	○	
	Log	○	
	Operation cycle monitor function	○	
	Servo amplifier disconnect	○	Operate with the following motor specifications. Number of encoder pulses per revolution: 131072[pulse] Motor maximum revolution speed: 6000[r/min]
	Alarm history function	○	
External forced stop disabled	○		
Transient transmit	○		
Hot line forced stop	○		
Tandem drive	Tandem drive	○	
Interface mode	Position control mode	○	
	Speed control mode	○	
	Torque control mode	○	

Note. ○: Supported △: With restrictions ×: Unsupported

App. 5.10.1 Application functions

(1) Servo amplifier general I/O

For the specification of the servo amplifier general I/O, refer to the following table.

(a) Compatible servo amplifier

Model	Remarks
Servo amplifier MR-JE-□B	Input: Not supported Output: 1 point/axis

(b) Destination connector

1) General input

Cannot be used.

2) General output

Signal Name	Destination connector pin No.	Abbreviation
DI_□□0	CN3-13	MBR
DI_□□1	—	—
DI_□□2	—	—

(c) Servo parameters

Parameter No.	MR-JE-B Parameter No.	Abbreviation	Name	Setting value
0176	PD07	*DO1	Output device selection 1	0021h

App. 5.10.2 Auxiliary function

(1) Hot line forced stop function

Refer to Section 7.19 for the hot line forced stop function.

APPENDIX

App. 5.11 Table map

For the table map, refer to the table map of when servo amplifier (MR-J4(W□)-□B) is used.

App. 5.12 Parameters

Concerning the parameters for which the parameter name shows that it is set by manufacturer, do not use other than the default values. If erroneous values are set, unexpected operation can occur. For the specification items not described in this section, refer to the specifications of servo amplifier MR-J4(W□)-□B.

Classification	Parameter No. (Note)	Remarks
System parameters	No. 0001 to 007F	
Servo parameters	No. 0100 to 01FF	Each axis
Control parameters	No. 0200 to 02FF	Each axis

Note. Parameter numbers are given in hexadecimal.

App. 5.12.1 System parameters

For system parameters, only the additions and changes are listed.

POINT
<ul style="list-style-type: none"> The settings for the parameters with a * mark at the front of the abbreviation are validated when the system is restarted.

Parameter No.	Symbol	Name	Initial Value	Units	Setting range	Function
0001	*SYSOP1	System option 1	0000h		0000h to 0102h	<div style="display: flex; align-items: center;"> <div style="border: 1px solid black; padding: 2px; margin-right: 10px;">0</div> <div style="border: 1px solid black; padding: 2px; margin-right: 10px;">0</div> <div style="border: 1px solid black; padding: 2px; margin-right: 10px;">0</div> <div style="border: 1px solid black; padding: 2px; margin-right: 10px;">0</div> </div> <p>Control cycle setting 0: 0.88ms 1: 0.44ms 2: 0.22ms (Not use) Make sure to set a value other than "2: 0.22ms".</p> <p>SSCNET communication method Set the SSCNET communication method. 0: SSCNETⅢ/H 1: SSCNETⅢ (Not use) Make sure to set "0: SSCNETⅢ/H"</p>

APPENDIX

App. 5.12.2 Servo parameters

When using servo amplifier MR-JE-□B, initial values for the following parameters are different to MR-J4(W□)-□B. Set the initial value to each parameter when using it. For details, refer to the Servo Amplifier Instruction Manual on your servo amplifier.

POINT
<ul style="list-style-type: none"> ▪ The parameters with a * mark in front of the parameter abbreviation become valid according to the following conditions. *: The setting value for the system startup or the SSCNET reconnection is valid. The parameter change after the system startup is invalid. ** : The setting value for the system startup or the SSCNET reconnection is valid. However, after the system startup, turn off the power supply of the servo amplifier once, and it is necessary to turn on it again. The parameter change after the system startup is invalid.

Parameter No.	MR-JE-B Parameter No.	Symbol	Name	Initial Value	Units
1109	PA10	INP	In-position range	100	pulse
110E	PA15	/	For manufacturer setting	0	/
110F	PA16			0	
1112	PA19	*BLK	Parameter writing inhibit	00AAh	/
1183	PC04	**COP1	Function selection C-1	0020h	/
1189	PC10	/	For manufacturer setting	0000h	/
11C2	PD03				
11C3	PD04	/	For manufacturer setting	0000h	/
11C4	PD05			0000h	
11C7	PD08			0000h	
11C8	PD09			0000h	
1202	PE03			/	
1203	PE04	0			
1204	PE05	0			
1205	PE06	0			
1206	PE07	0			
1207	PE08	0			
1221	PE34	0			
1222	PE35	0			
1226	PE39	0			
1245	PF06	*FOP5	Function selection F-5		0003h
1251	PF18	**STOD	STO diagnosis error detection time	0	s

App. 5.12.3 Control parameters

For control parameters, only the additions and changes are listed.

Parameter No.	Symbol	Name	Initial value	Unit	Setting range	Function	When tandem drive is being used
021E	*CODE	Type code	1000h	/	0000h to FFFFh	Set the type code. 1200h: MR-JE-□B	Same value

APPENDIX

App. 5.13 Monitor

For the monitor, refer to the monitor list of when MR-J4(W□)-□B is used.

App. 5.14 System alarm

For the alarm No., only the additions and changes are listed.

App. 5.14.1 Servo alarm

The servo alarms of MR-JE-□B are shown in the following table. For details, refer to the Servo Amplifier Instruction Manual.

Alarm

Alarm No.	Name
10	Undervoltage
12	Memory error 1 (RAM)
13	Clock error
14	Control process error
15	Memory error 2 (EEP-ROM)
16	Encoder initial communication error 1
17	Board error
19	Memory error 3 (FLASH-ROM)
1A	Servo motor combination error
1E	Encoder initial communication error 2
1F	Encoder initial communication error 3
20	Encoder normal communication error 1
21	Encoder normal communication error 2
24	Main circuit error
25	Absolute position erased
30	Regenerative error
31	Overspeed
32	Overcurrent
33	Overvoltage
34	SSCNET receive error 1
35	Command frequency error
36	SSCNET receive error 2

Alarm No.	Name
37	Parameter error
39	Program error
3E	Operation mode error
45	Main circuit device overheat
46	Servo motor overheat
47	Cooling fan error
50	Overload 1
51	Overload 2
52	Error excessive
54	Oscillation detection
56	Forced stop error
61	Operation error
8A	USB communication time-out/serial communication time-out error/Modbus-RTU communication time-out error
8E	USB communication error/serial communication error/Modbus-RTU communication error
888/ 88888	Watchdog

Warning

Alarm No.	Name
90	Home position return incomplete warning
91	Servo amplifier overheat warning
92	Battery cable disconnection warning
96	Home position setting warning
97	Program operation disabled/next station position warning
98	Software limit warning
99	Stroke limit warning
9B	Error excessive warning
9F	Battery warning
E0	Excessive regeneration warning
E1	Overload warning 1
E3	Absolute position counter warning
E4	Parameter warning

Alarm No.	Name
E6	Servo forced stop warning
E7	Controller forced stop warning
E8	Cooling fan speed reduction warning
E9	Main circuit off warning
EC	Overload warning 2
ED	Output watt excess warning
F0	Tough drive warning
F2	Drive recorder – Miswriting warning
F3	Oscillation detection warning
F5	Simple cam function - Cam data miswriting warning
F6	Simple cam function - Cam control warning

Note. For the specific servo alarm numbers, refer to the specifications of MR-JE-□B.

APPENDIX

App. 6 Cables

In this cable connection diagram, maker names of connectors are omitted. Refer to "App. 7.2 Connectors" for makers of connectors.

App. 6.1 SSCNETⅢ cables

Generally use the SSCNETⅢ cables available as our products.

Refer to App.6.3 for long distance cable up to 100(328.08)[m(ft.)] and ultra-long bending life cable.

(1) Model explanation

Numerals in the column of cable length on the table is a symbol put in the "□" part of cable model. Cables of which symbol exists are available.

Cable model	Cable length [m(ft.)]											Flex life	Application/ remark
	0.15 (0.49)	0.3 (0.98)	0.5 (1.64)	1 (3.28)	3 (9.84)	5 (16.40)	10 (32.81)	20 (65.62)	30 (98.43)	40 (131.23)	50 (164.04)		
MR-J3BUS□M	015	03	05	1	3	/	/	/	/	/	/	Standard	Standard cord for inside panel
MR-J3BUS□M-A	/	/	/	/	/	5	10	20	/	/	/	Standard	Standard cable for outside panel
MR-J3BUS□M-B (Note 1)	/	/	/	/	/	/	/	/	30	40	50	Long flex	Long distance cable

Note 1. For the cable of less than 30[m](98.43[ft.]), contact your nearest Mitsubishi Electric sales representative.

(2) Specifications

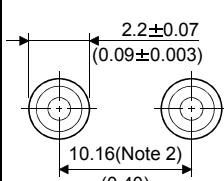
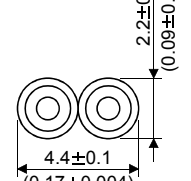
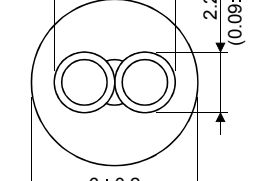
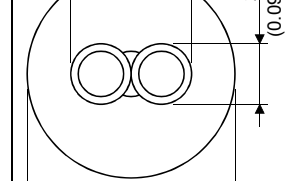
		Description				
SSCNETⅢ cable model		MR-J3BUS□M		MR-J3BUS□M-A	MR-J3BUS□M-B	
SSCNETⅢ cable length [m(ft.)]		0.15 (0.49)	0.3 to 3 (0.98 to 9.84)	5 to 20 (16.40 to 65.62)	30 to 50 (98.43 to 164.04)	
Optical cable (Cord)	Minimum bend radius [mm(inch)]	25(0.98)			Enforced covering cord: 50 (1.97) Cord: 25 (0.98)	Enforced covering cord: 50 (1.97) Cord: 30(1.18)
	Tension strength [N]	70	140	420 (Enforced covering cord)	980 (Enforced covering cord)	
	Temperature range for use [°C(°F)] (Note 1)	-40 to 80 (-40 to 176)				-20 to 70 (-4 to 158)
	Ambient	Indoors (no direct sunlight), No solvent or oil				
	External appearance [mm(inch)]					

Note 1. This temperature range for use is the value for optical cable (cord) only.

Note 2. Dimension of connector fiber insert location. The distance of two cords is changed by how to bend it.

POINT
<ul style="list-style-type: none"> ▪ If the end face of cord tip for the SSCNETⅢ cable is dirty, optical transmission is interrupted and it may cause malfunctions. If it becomes dirty, wipe with a bonded textile, etc. Do not use solvent such as alcohol. ▪ Do not add impossible power to the connector of the SSCNETⅢ cable. ▪ When incinerating the SSCNETⅢ cable (optical fiber), hydrogen fluoride gas or hydrogen chloride gas which is corrosive and harmful may be generated. For disposal of the SSCNETⅢ cable (optical fiber), request for specialized industrial waste disposal services who has incineration facility for disposing hydrogen fluoride gas or hydrogen chloride gas.

(a) MR-J3BUS□M

1) Model explanation

Type: MR-J3BUS□M-*

Symbol	Cable type
None	Standard cord for inside panel
A	Standard cable for outside panel
B	Long distance cable

Symbol	Cable length [m(ft.)]
015	0.15(0.49)
03	0.3(0.98)
05	0.5(1.64)
1	1(3.28)
3	3(9.84)
5	5(16.40)
10	10(32.81)
20	20(65.62)
30	30(98.43)
40	40(131.23)
50	50(164.04)

2) Exterior dimensions

- MR-J3BUS015M

[Unit: mm(inch)]

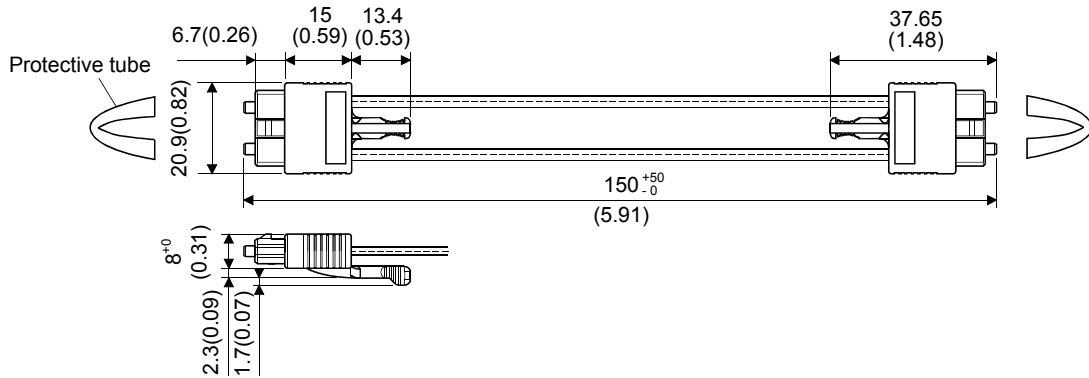

- MR-J3BUS03M to MR-J3BUS3M

Refer to the table of this section (1) for cable length (L).

[Unit: mm(inch)]

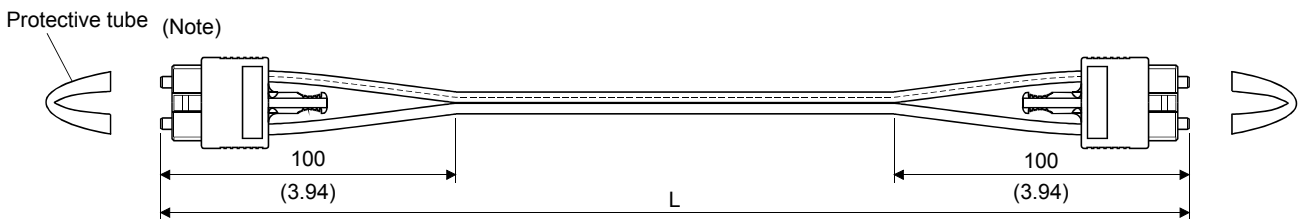

Note. Dimension of connector part is the same as that of MR-J3BUS015M.

- MR-J3BUS5M-A to MR-J3BUS20M-A, MR-J3BUS30M-B to MR-J3BUS50M-B

Refer to the table of this section (1) for cable length (L).

SSCNET III cable	Variation [mm(inch)]	
	A	B
MR-J3BUS5M-A to MR-J3BUS20M-A	100(3.94)	30(1.18)
MR-J3BUS30M-B to MR-J3BUS50M-B	150(5.91)	50(1.97)

[Unit: mm(inch)]

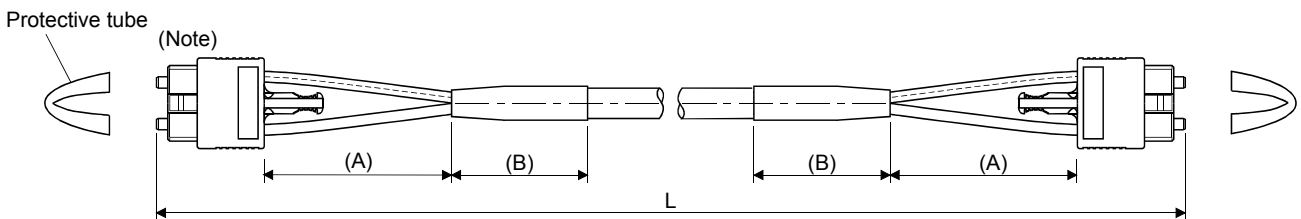

Note. Dimension of connector part is the same as that of MR-J3BUS015M.

POINT
<ul style="list-style-type: none"> • Keep the cap and the tube for protecting light cord end of SSCNET III cable in a plastic bag with a zipper of SSCNET III cable to prevent them from becoming dirty.

App. 6.2 Forced stop input cable

Fabricate the forced stop input cable on the customer side.
 Make the forced stop input cable within 30m(98.43ft.).

(1) Connection diagram

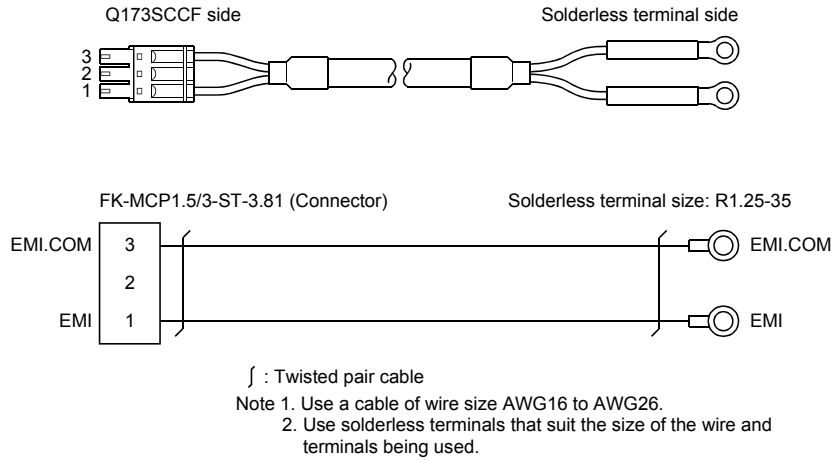

APPENDIX

App. 6.3 SSCNETⅢ cables (SC-J3BUS□M-C) manufactured by Mitsubishi Electric System & Service Co., Ltd.

POINT
<ul style="list-style-type: none">▪ For the details of the SSCNETⅢ cables, contact your local sales office.▪ Do not look directly at the light generated from CN1A/CN1B connector of servo amplifier or the end of SSCNETⅢ cable. The light can be a discomfort when it enters the eye.

The cable is available per 1[m] up to 100[m]. The number of the length (1 to 100) will be in the □ part in the cable model.

Cable model	Cable length [m(ft.)]	Bending life	Application/remark
	1 to 100 (3.28 to 328.08)		
SC-J3BUS□M-C	1 to 100	Ultra-long bending life	Long distance cable

APPENDIX

App. 7 Exterior dimensions

App. 7.1 C Controller interface module (Q173SCCF)

[Unit: mm(inch)]

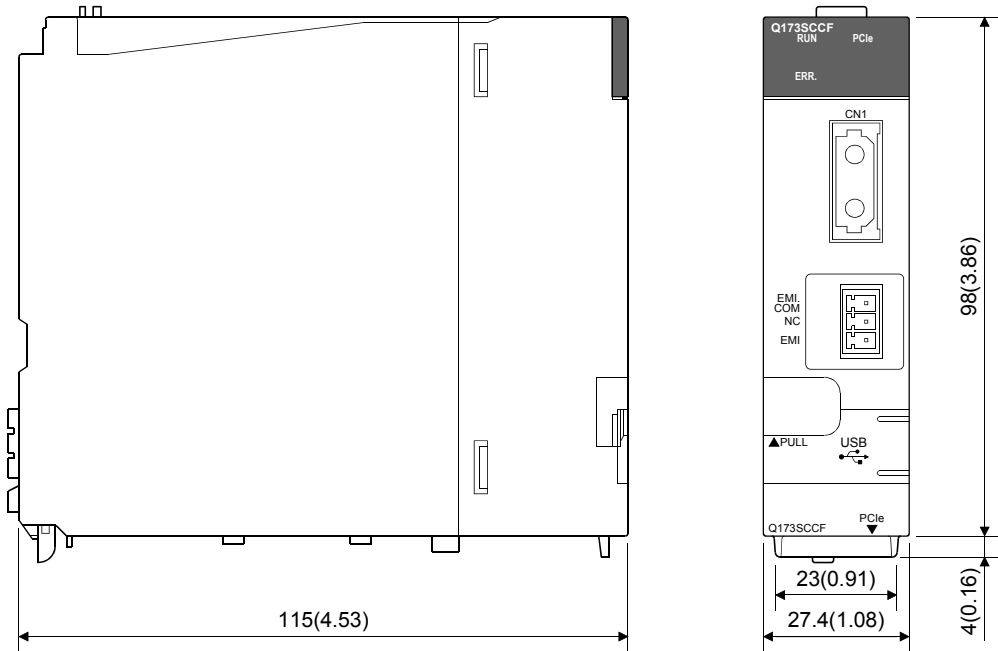

APPENDIX

App. 7.2 Connectors

(1) SSCNETIII cable connector

[Unit: mm(inch)]

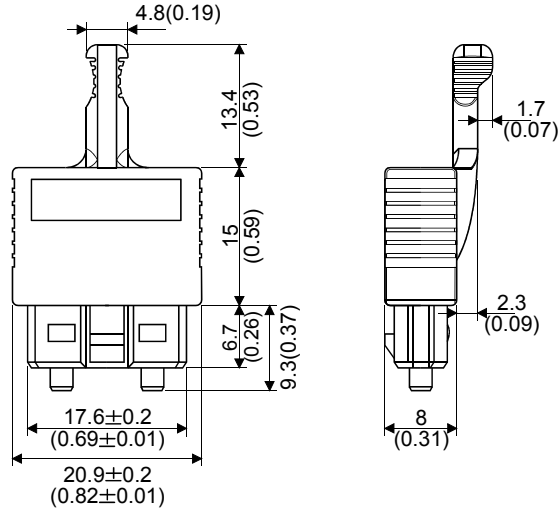

(2) Forced stop input connector (PHOENIX CONTACT make)

Type Connector: FK-MCP1.5/3/ST-3.81

[Unit: mm(inch)]

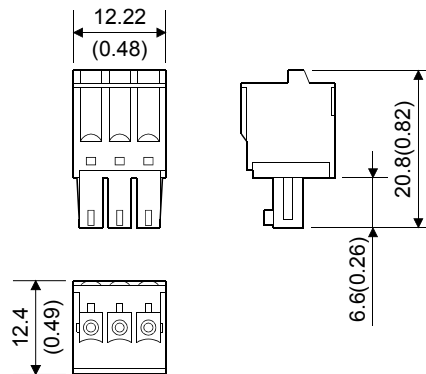

WARRANTY

Please confirm the following product warranty details before using this product.

1. Gratis Warranty Term and Gratis Warranty Range

We will repair any failure or defect hereinafter referred to as "failure" in our FA equipment hereinafter referred to as the "Product" arisen during warranty period at no charge due to causes for which we are responsible through the distributor from which you purchased the Product or our service provider. However, we will charge the actual cost of dispatching our engineer for an on-site repair work on request by customer in Japan or overseas countries. We are not responsible for any on-site readjustment and/or trial run that may be required after a defective unit are repaired or replaced.

[Gratis Warranty Term]

The term of warranty for Product is thirty six (36) months after your purchase or delivery of the Product to a place designated by you or forty two (42) months from the date of manufacture whichever comes first "Warranty Period". Warranty period for repaired Product cannot exceed beyond the original warranty period before any repair work.

[Gratis Warranty Range]

- (1) You are requested to conduct an initial failure diagnosis by yourself, as a general rule.
It can also be carried out by us or our service company upon your request and the actual cost will be charged. However, it will not be charged if we are responsible for the cause of the failure.
- (2) This limited warranty applies only when the condition, method, environment, etc. of use are in compliance with the terms and conditions and instructions that are set forth in the instruction manual and user manual for the Product and the caution label affixed to the Product.
- (3) Even during the term of warranty, the repair cost will be charged on you in the following cases;
 - 1) A failure caused by your improper storing or handling, carelessness or negligence, etc., and a failure caused by your hardware or software problem
 - 2) A failure caused by any alteration, etc. to the Product made on your side without our approval
 - 3) A failure which may be regarded as avoidable, if your equipment in which the Product is incorporated is equipped with a safety device required by applicable laws and has any function or structure considered to be indispensable according to a common sense in the industry
 - 4) A failure which may be regarded as avoidable if consumable parts designated in the instruction manual, etc. are duly maintained and replaced
 - 5) Any replacement of consumable parts (battery, relay, fuse, etc.)
 - 6) A failure caused by external factors such as inevitable accidents, including without limitation fire and abnormal fluctuation of voltage, and acts of God, including without limitation earthquake, lightning and natural disasters
 - 7) A failure generated by an unforeseeable cause with a scientific technology that was not available at the time of the shipment of the Product from our company
 - 8) Any other failures which we are not responsible for or which you acknowledge we are not responsible for

2. Onerous Repair Term after Discontinuation of Production

- (1) We may accept the repair at charge for another seven (7) years after the production of the product is discontinued.
The announcement of the stop of production for each model can be seen in our Sales and Service, etc.
- (2) Please note that the Product (including its spare parts) cannot be ordered after its stop of production.

3. Service in overseas countries

Our regional FA Center in overseas countries will accept the repair work of the Product; However, the terms and conditions of the repair work may differ depending on each FA Center. Please ask your local FA center for details.

4. Exclusion of Loss in Opportunity and Secondary Loss from Warranty Liability

Regardless of the gratis warranty term, Mitsubishi shall not be liable for compensation to:

- (1) Damages caused by any cause found not to be the responsibility of Mitsubishi.
- (2) Loss in opportunity, lost profits incurred to the user by Failures of Mitsubishi products.
- (3) Special damages and secondary damages whether foreseeable or not, compensation for accidents, and compensation for damages to products other than Mitsubishi products.
- (4) Replacement by the user, maintenance of on-site equipment, start-up test run and other tasks.

5. Change of Product specifications

Specifications listed in our catalogs, manuals or technical documents may be changed without notice.

6. Precautions for Choosing the Products

(1) For the use of our C Controller interface module, its applications should be those that may not result in a serious damage even if any failure or malfunction occurs in C Controller interface module, and a backup or fail-safe function should operate on an external system to C Controller interface module when any failure or malfunction occurs.

(2) Our C Controller interface module is designed and manufactured as a general purpose product for use at general industries.

Therefore, applications substantially influential on the public interest for such as atomic power plants and other power plants of electric power companies, and also which require a special quality assurance system, including applications for railway companies and government or public offices are not recommended, and we assume no responsibility for any failure caused by these applications when used.

In addition, applications which may be substantially influential to human lives or properties for such as airlines, medical treatments, railway service, incineration and fuel systems, man-operated material handling equipment, entertainment machines, safety machines, etc. are not recommended, and we assume no responsibility for any failure caused by these applications when used.

We will review the acceptability of the abovementioned applications, if you agree not to require a specific quality for a specific application. Please contact us for consultation.

Microsoft, Windows, Windows Vista, and Windows XP are either registered trademarks or trademarks of Microsoft Corporation in the United States and/or other countries.

VxWorks and Wind River are either registered trademarks or trademarks of Wind River Systems, Inc.

Ethernet is a registered trademark of Fuji Xerox Corporation in Japan.

PCI Express is a registered trademark or trademark of PCI-SIG.

The company names, system names and product names mentioned in this manual are either registered trademarks or trademarks of their respective companies.

In some cases, trademark symbols such as '™' or '®' are not specified in this manual.

IB(NA)-0300217-D(1704)MEE

MODEL: Q173SCCF-U-S-E

MODEL CODE: 1XB964

MITSUBISHI ELECTRIC CORPORATION

HEAD OFFICE : TOKYO BUILDING, 2-7-3 MARUNOUCHI, CHIYODA-KU, TOKYO 100-8310, JAPAN
NAGOYA WORKS : 1-14, YADA-MINAMI 5-CHOME, HIGASHI-KU, NAGOYA, JAPAN

When exported from Japan, this manual does not require application to the
Ministry of Economy, Trade and Industry for service transaction permission.

Specifications subject to change without notice.