

Programmable Controller

**MELSEC iQ-R**  
series

# MELSEC iQ-R Motion Controller Programming Manual (Machine Control)

---

-R16MTCPU  
-R32MTCPU  
-R64MTCPU





# SAFETY PRECAUTIONS



---

(Read these precautions before using this product.)

Before using this product, please read this manual and the relevant manuals carefully and pay full attention to safety to handle the product correctly.

The precautions given in this manual are concerned with this product only. Refer to MELSEC iQ-R Module Configuration Manual for a description of the PLC system safety precautions.

In this manual, the safety precautions are classified into two levels: "  WARNING" and "  CAUTION".

 <b>WARNING</b>	Indicates that incorrect handling may cause hazardous conditions, resulting in death or severe injury.
 <b>CAUTION</b>	Indicates that incorrect handling may cause hazardous conditions, resulting in minor or moderate injury or property damage.

Under some circumstances, failure to observe the precautions given under "  CAUTION" may lead to serious consequences.

Observe the precautions of both levels because they are important for personal and system safety.

Make sure that the end users read this manual and then keep the manual in a safe place for future reference.

## [Design Precautions]

---

### **WARNING**

- Configure safety circuits external to the programmable controller to ensure that the entire system operates safely even when a fault occurs in the external power supply or the programmable controller. Failure to do so may result in an accident due to an incorrect output or malfunction.
    - (1) Emergency stop circuits, protection circuits, and protective interlock circuits for conflicting operations (such as forward/reverse rotations or upper/lower limit positioning) must be configured external to the programmable controller.
    - (2) When the programmable controller detects an abnormal condition, it stops the operation and all outputs are:
      - Turned off if the overcurrent or overvoltage protection of the power supply module is activated.
      - Held or turned off according to the parameter setting if the self-diagnostic function of the CPU module detects an error such as a watchdog timer error.
    - (3) All outputs may be turned on if an error occurs in a part, such as an I/O control part, where the CPU module cannot detect any error. To ensure safety operation in such a case, provide a safety mechanism or a fail-safe circuit external to the programmable controller. For a fail-safe circuit example, refer to "General Safety Requirements" in the MELSEC iQ-R Module Configuration Manual.
    - (4) Outputs may remain on or off due to a failure of a component such as a relay and transistor in an output circuit. Configure an external circuit for monitoring output signals that could cause a serious accident.
  - In an output circuit, when a load current exceeding the rated current or an overcurrent caused by a load short-circuit flows for a long time, it may cause smoke and fire. To prevent this, configure an external safety circuit, such as a fuse.
  - Configure a circuit so that the programmable controller is turned on first and then the external power supply. If the external power supply is turned on first, an accident may occur due to an incorrect output or malfunction.
-

## [Design Precautions]

---

### **WARNING**

- Configure a circuit so that the external power supply is turned off first and then the programmable controller. If the programmable controller is turned off first, an accident may occur due to an incorrect output or malfunction.
  - For the operating status of each station after a communication failure, refer to manuals for the network used. For the manuals, please consult your local Mitsubishi representative. Incorrect output or malfunction due to a communication failure may result in an accident.
  - When connecting an external device with a CPU module or intelligent function module to modify data of a running programmable controller, configure an interlock circuit in the program to ensure that the entire system will always operate safely. For other forms of control (such as program modification, parameter change, forced output, or operating status change) of a running programmable controller, read the relevant manuals carefully and ensure that the operation is safe before proceeding. Improper operation may damage machines or cause accidents. When a Safety CPU is used, data cannot be modified while the Safety CPU is in SAFETY MODE.
  - Especially, when a remote programmable controller is controlled by an external device, immediate action cannot be taken if a problem occurs in the programmable controller due to a communication failure. To prevent this, configure an interlock circuit in the program, and determine corrective actions to be taken between the external device and CPU module in case of a communication failure.
  - Do not write any data to the "system area" and "write-protect area" of the buffer memory in the module. Also, do not use any "use prohibited" signals as an output signal from the CPU module to each module. Doing so may cause malfunction of the programmable controller system. For the "system area", "write-protect area", and the "use prohibited" signals, refer to the user's manual for the module used. For areas used for safety communications, they are protected from being written by users, and thus safety communications failure caused by data writing does not occur.
  - If a communication cable is disconnected, the network may be unstable, resulting in a communication failure of multiple stations. Configure an interlock circuit in the program to ensure that the entire system will always operate safely even if communications fail. Failure to do so may result in an accident due to an incorrect output or malfunction. When safety communications are used, an interlock by the safety station interlock function protects the system from an incorrect output or malfunction.
  - Configure safety circuits external to the programmable controller to ensure that the entire system operates safely even when a fault occurs in the external power supply or the programmable controller. Failure to do so may result in an accident due to an incorrect output or malfunction.
  - If safety standards (ex., robot safety rules, etc.,) apply to the system using the module, servo amplifier and servo motor, make sure that the safety standards are satisfied.
  - Construct a safety circuit externally of the module or servo amplifier if the abnormal operation of the module or servo amplifier differs from the safety directive operation in the system.
  - Do not remove the SSCNETⅢ cable while turning on the control circuit power supply of modules and servo amplifier. Do not see directly the light generated from SSCNETⅢ connector of the module or servo amplifier and the end of SSCNETⅢ cable. When the light gets into eyes, you may feel something wrong with eyes. (The light source of SSCNETⅢ complies with class 1 defined in JISC6802 or IEC60825-1.)
-

## [Design Precautions]

---

### **CAUTION**

- Do not install the control lines or communication cables together with the main circuit lines or power cables. Doing so may result in malfunction due to electromagnetic interference. Keep a distance of 100mm or more between those cables.
  - During control of an inductive load such as a lamp, heater, or solenoid valve, a large current (approximately ten times greater than normal) may flow when the output is turned from off to on. Therefore, use a module that has a sufficient current rating.
  - After the CPU module is powered on or is reset, the time taken to enter the RUN status varies depending on the system configuration, parameter settings, and/or program size. Design circuits so that the entire system will always operate safely, regardless of the time.
  - Do not power off the programmable controller or reset the CPU module while the settings are being written. Doing so will make the data in the flash ROM and SD memory card undefined. The values need to be set in the buffer memory and written to the flash ROM and SD memory card again. Doing so also may cause malfunction or failure of the module.
  - When changing the operating status of the CPU module from external devices (such as the remote RUN/STOP functions), select "Do Not Open by Program" for "Opening Method" of "Module Parameter". If "Open by Program" is selected, an execution of the remote STOP function causes the communication line to close. Consequently, the CPU module cannot reopen the line, and external devices cannot execute the remote RUN function.
- 

## [Security Precautions]

---

### **WARNING**

- To maintain the security (confidentiality, integrity, and availability) of the programmable controller and the system against unauthorized access, denial-of-service (DoS) attacks, computer viruses, and other cyberattacks from external devices via the network, take appropriate measures such as firewalls, virtual private networks (VPNs), and antivirus solutions.
- 

## [Installation Precautions]

---

### **WARNING**

- Shut off the external power supply (all phases) used in the system before mounting or removing the module. Failure to do so may result in electric shock or cause the module to fail or malfunction.
-

## [Installation Precautions]

---

### CAUTION

- Use the programmable controller in an environment that meets the general specifications in the Safety Guidelines (IB-0800525). Failure to do so may result in electric shock, fire, malfunction, or damage to or deterioration of the product.
  - To mount a module, place the concave part(s) located at the bottom onto the guide(s) of the base unit, and push in the module until the hook(s) located at the top snaps into place. Incorrect interconnection may cause malfunction, failure, or drop of the module.
  - To mount a module with no module fixing hook, place the concave part(s) located at the bottom onto the guide(s) of the base unit, push in the module, and fix it with screw(s). Incorrect interconnection may cause malfunction, failure, or drop of the module.
  - When using the programmable controller in an environment of frequent vibrations, fix the module with a screw.
  - Tighten the screws within the specified torque range. Undertightening can cause drop of the component or wire, short circuit, or malfunction. Overtightening can damage the screw and/or module, resulting in drop, short circuit, or malfunction. For the specified torque range, refer to the MELSEC iQ-R Module Configuration Manual.
  - When using an extension cable, connect it to the extension cable connector of the base unit securely. Check the connection for looseness. Poor contact may cause malfunction.
  - When using an SD memory card, fully insert it into the SD memory card slot. Check that it is inserted completely. Poor contact may cause malfunction.
  - Securely insert an extended SRAM cassette or a battery-less option cassette into the cassette connector of the CPU module. After insertion, close the cassette cover and check that the cassette is inserted completely. Poor contact may cause malfunction.
  - Beware that the module could be very hot while power is on and immediately after power-off.
  - Do not directly touch any conductive parts and electronic components of the module, SD memory card, extended SRAM cassette, battery-less option cassette, or connector. Doing so can cause malfunction or failure of the module.
- 

## [Wiring Precautions]

---

### WARNING

- Shut off the external power supply (all phases) used in the system before installation and wiring. Failure to do so may result in electric shock or cause the module to fail or malfunction.
- After installation and wiring, attach a blank cover module (RG60) to each empty slot before powering on the system for operation. Also, attach an extension connector protective cover<sup>\*1</sup> to each unused extension cable connector as necessary. Directly touching any conductive parts of the connectors while power is on may result in electric shock.

\*1 For details, please consult your local Mitsubishi Electric representative.

---

## [Wiring Precautions]

---

### CAUTION

- Individually ground the FG and LG terminals of the programmable controller with a ground resistance of 100 ohms or less. Failure to do so may result in electric shock or malfunction.
  - Use applicable solderless terminals and tighten them within the specified torque range. If any spade solderless terminal is used, it may be disconnected when the terminal screw comes loose, resulting in failure.
  - Check the rated voltage and signal layout before wiring to the module, and connect the cables correctly. Connecting a power supply with a different voltage rating or incorrect wiring may cause fire or failure.
  - Connectors for external devices must be crimped or pressed with the tool specified by the manufacturer, or must be correctly soldered. Incomplete connections may cause short circuit, fire, or malfunction.
  - Securely connect the connector to the module. Poor contact may cause malfunction.
  - Do not install the control lines or communication cables together with the main circuit lines or power cables. Doing so may result in malfunction due to noise. Keep a distance of 100mm or more between those cables.
  - Place the cables in a duct or clamp them. If not, dangling cables may swing or inadvertently be pulled, resulting in malfunction or damage to modules or cables.  
In addition, the weight of the cables may put stress on modules in an environment of strong vibrations and shocks.  
Do not clamp the extension cables with the jacket stripped. Doing so may change the characteristics of the cables, resulting in malfunction.
  - Check the interface type and correctly connect the cable. Incorrect wiring (connecting the cable to an incorrect interface) may cause failure of the module and external device.
  - Tighten the terminal screws or connector screws within the specified torque range. Undertightening can cause drop of the screw, short circuit, fire, or malfunction. Overtightening can damage the screw and/or module, resulting in drop, short circuit, fire, or malfunction.
  - When disconnecting the cable from the module, do not pull the cable by the cable part. For the cable with connector, hold the connector part of the cable. For the cable connected to the terminal block, loosen the terminal screw. Pulling the cable connected to the module may result in malfunction or damage to the module or cable.
  - Prevent foreign matter such as dust or wire chips from entering the module. Such foreign matter can cause a fire, failure, or malfunction.
  - When a protective film is attached to the top of the module, remove it before system operation. If not, inadequate heat dissipation of the module may cause a fire, failure, or malfunction.
  - Programmable controllers must be installed in control panels. Connect the main power supply to the power supply module in the control panel through a relay terminal block. Wiring and replacement of a power supply module must be performed by qualified maintenance personnel with knowledge of protection against electric shock. For wiring, refer to the MELSEC iQ-R Module Configuration Manual.
  - For Ethernet cables to be used in the system, select the ones that meet the specifications in the user's manual for the module used. If not, normal data transmission is not guaranteed.
-

## [Startup and Maintenance Precautions]

---

### **WARNING**

- Do not touch any terminal while power is on. Doing so will cause electric shock or malfunction.
  - Correctly connect the battery connector. Do not charge, disassemble, heat, short-circuit, solder, or throw the battery into the fire. Also, do not expose it to liquid or strong shock. Doing so will cause the battery to produce heat, explode, ignite, or leak, resulting in injury and fire.
  - Shut off the external power supply (all phases) used in the system before cleaning the module or retightening the terminal screws, connector screws, or module fixing screws. Failure to do so may result in electric shock.
- 

## [Startup and Maintenance Precautions]

---

### **CAUTION**

- When connecting an external device with a CPU module or intelligent function module to modify data of a running programmable controller, configure an interlock circuit in the program to ensure that the entire system will always operate safely. For other forms of control (such as program modification, parameter change, forced output, or operating status change) of a running programmable controller, read the relevant manuals carefully and ensure that the operation is safe before proceeding. Improper operation may damage machines or cause accidents.
  - Especially, when a remote programmable controller is controlled by an external device, immediate action cannot be taken if a problem occurs in the programmable controller due to a communication failure. To prevent this, configure an interlock circuit in the program, and determine corrective actions to be taken between the external device and CPU module in case of a communication failure.
  - Do not disassemble or modify the modules. Doing so may cause failure, malfunction, injury, or a fire.
  - Use any radio communication device such as a cellular phone or PHS (Personal Handy-phone System) more than 25cm away in all directions from the programmable controller. Failure to do so may cause malfunction.
  - Shut off the external power supply (all phases) used in the system before mounting or removing the module. Failure to do so may cause the module to fail or malfunction.
  - Tighten the screws within the specified torque range. Undertightening can cause drop of the component or wire, short circuit, or malfunction. Overtightening can damage the screw and/or module, resulting in drop, short circuit, or malfunction.
  - After the first use of the product, do not perform each of the following operations more than 50 times (IEC 61131-2/JIS B 3502 compliant).  
Exceeding the limit may cause malfunction.
    - Mounting/removing the module to/from the base unit
    - Inserting/removing the extended SRAM cassette or battery-less option cassette to/from the CPU module
    - Mounting/removing the terminal block to/from the module
    - Connecting/disconnecting the extension cable to/from the base unit
  - After the first use of the product, do not insert/remove the SD memory card to/from the CPU module more than 500 times. Exceeding the limit may cause malfunction.
  - Do not touch the metal terminals on the back side of the SD memory card. Doing so may cause malfunction or failure of the module.
  - Do not touch the integrated circuits on the circuit board of an extended SRAM cassette or a battery-less option cassette. Doing so may cause malfunction or failure of the module.
-



## [Startup and Maintenance Precautions]

---

### CAUTION

- Do not drop or apply shock to the battery to be installed in the module. Doing so may damage the battery, causing the battery fluid to leak inside the battery. If the battery is dropped or any shock is applied to it, dispose of it without using.
  - Startup and maintenance of a control panel must be performed by qualified maintenance personnel with knowledge of protection against electric shock. Lock the control panel so that only qualified maintenance personnel can operate it.
  - Before handling the module, touch a conducting object such as a grounded metal to discharge the static electricity from the human body. Wearing a grounded antistatic wrist strap is recommended. Failure to discharge the static electricity may cause the module to fail or malfunction.
  - Use a clean and dry cloth to wipe off dirt on the module.
  - Before testing the operation, set a low speed value for the speed limit parameter so that the operation can be stopped immediately upon occurrence of a hazardous condition.
  - Confirm and adjust the program and each parameter before operation. Unpredictable movements may occur depending on the machine.
  - When using the absolute position system function, on starting up, and when the module or absolute position motor has been replaced, always perform a home position return.
  - Before starting the operation, confirm the brake function.
  - Do not perform a megger test (insulation resistance measurement) during inspection.
  - After maintenance and inspections are completed, confirm that the position detection of the absolute position detection function is correct.
  - Lock the control panel and prevent access to those who are not certified to handle or install electric equipment.
- 

## [Operating Precautions]

---

### CAUTION

- When changing data and operating status, and modifying program of the running programmable controller from an external device such as a personal computer connected to an intelligent function module, read relevant manuals carefully and ensure the safety before operation. Incorrect change or modification may cause system malfunction, damage to the machines, or accidents.
  - Do not power off the programmable controller or reset the CPU module while the setting values in the buffer memory are being written to the flash ROM in the module. Doing so will make the data in the flash ROM and SD memory card undefined. The values need to be set in the buffer memory and written to the flash ROM and SD memory card again. Doing so also may cause malfunction or failure of the module.
  - Note that when the reference axis speed is specified for interpolation operation, the speed of the partner axis (2nd, 3rd, or 4th axis) may exceed the speed limit value.
  - Do not go near the machine during test operations or during operations such as teaching. Doing so may lead to injuries.
-

## [Disposal Precautions]

---

### **CAUTION**

---

- When disposing of this product, treat it as industrial waste.
  - When disposing of batteries, separate them from other wastes according to the local regulations. For details on battery regulations in EU member states, refer to the MELSEC iQ-R Module Configuration Manual.
- 

## [Transportation Precautions]

---

### **CAUTION**

---

- When transporting lithium batteries, follow the transportation regulations. For details on the regulated models, refer to the MELSEC iQ-R Module Configuration Manual.
  - The halogens (such as fluorine, chlorine, bromine, and iodine), which are contained in a fumigant used for disinfection and pest control of wood packaging materials, may cause failure of the product. Prevent the entry of fumigant residues into the product or consider other methods (such as heat treatment) instead of fumigation. The disinfection and pest control measures must be applied to unprocessed raw wood.
-

# CONDITIONS OF USE FOR THE PRODUCT

---

- (1) MELSEC programmable controller ("the PRODUCT") shall be used in conditions;
- i) where any problem, fault or failure occurring in the PRODUCT, if any, shall not lead to any major or serious accident; and
  - ii) where the backup and fail-safe function are systematically or automatically provided outside of the PRODUCT for the case of any problem, fault or failure occurring in the PRODUCT.
- (2) The PRODUCT has been designed and manufactured for the purpose of being used in general industries. MITSUBISHI ELECTRIC SHALL HAVE NO RESPONSIBILITY OR LIABILITY (INCLUDING, BUT NOT LIMITED TO ANY AND ALL RESPONSIBILITY OR LIABILITY BASED ON CONTRACT, WARRANTY, TORT, PRODUCT LIABILITY) FOR ANY INJURY OR DEATH TO PERSONS OR LOSS OR DAMAGE TO PROPERTY CAUSED BY THE PRODUCT THAT ARE OPERATED OR USED IN APPLICATION NOT INTENDED OR EXCLUDED BY INSTRUCTIONS, PRECAUTIONS, OR WARNING CONTAINED IN MITSUBISHI ELECTRIC USER'S, INSTRUCTION AND/OR SAFETY MANUALS, TECHNICAL BULLETINS AND GUIDELINES FOR the PRODUCT.
- ("Prohibited Application")
- Prohibited Applications include, but not limited to, the use of the PRODUCT in;
- Nuclear Power Plants and any other power plants operated by Power companies, and/or any other cases in which the public could be affected if any problem or fault occurs in the PRODUCT.
  - Railway companies or Public service purposes, and/or any other cases in which establishment of a special quality assurance system is required by the Purchaser or End User.
  - Aircraft or Aerospace, Medical applications, Train equipment, transport equipment such as Elevator and Escalator, Incineration and Fuel devices, Vehicles, Manned transportation, Equipment for Recreation and Amusement, and Safety devices, handling of Nuclear or Hazardous Materials or Chemicals, Mining and Drilling, and/or other applications where there is a significant risk of injury to the public or property.
- Notwithstanding the above restrictions, Mitsubishi Electric may in its sole discretion, authorize use of the PRODUCT in one or more of the Prohibited Applications, provided that the usage of the PRODUCT is limited only for the specific applications agreed to by Mitsubishi Electric and provided further that no special quality assurance or fail-safe, redundant or other safety features which exceed the general specifications of the PRODUCTS are required. For details, please contact the Mitsubishi Electric representative in your region.
- (3) Mitsubishi Electric shall have no responsibility or liability for any problems involving programmable controller trouble and system trouble caused by DoS attacks, unauthorized access, computer viruses, and other cyberattacks.

## INTRODUCTION

---

Thank you for purchasing the Mitsubishi Electric MELSEC iQ-R series programmable controllers.

This manual describes the dedicated signals, parameters, data, and functions required for performing machine control of the relevant products listed below.

Before using this product, please read this manual and the relevant manuals carefully and develop familiarity with the functions and performance of the MELSEC iQ-R series programmable controller to handle the product correctly.

When applying the program examples provided in this manual to an actual system, ensure the applicability and confirm that it will not cause system control problems.

Please make sure that the end users read this manual.

### Relevant products

---

R16MTCPU, R32MTCPU, R64MTCPU

# CONTENTS

SAFETY PRECAUTIONS .....	1
CONDITIONS OF USE FOR THE PRODUCT .....	9
INTRODUCTION .....	9
RELEVANT MANUALS .....	12
TERMS .....	13
MANUAL PAGE ORGANIZATION .....	14
<b>CHAPTER 1 OVERVIEW</b> .....	<b>17</b>
1.1 Machine Control Overview .....	17
1.2 Performance Specifications .....	19
<b>CHAPTER 2 STARTING UP THE SYSTEM</b> .....	<b>20</b>
2.1 Starting Up the Machine Control System .....	20
2.2 Machine Control System Positioning Controls .....	21
Machine program operation start. ....	21
Machine JOG operation. ....	21
2.3 Machine Control System Stop Operation .....	22
2.4 Machine Control System Device Assignment Method .....	22
<b>CHAPTER 3 MACHINES</b> .....	<b>23</b>
3.1 Overview of a Machine .....	23
Machine Position .....	23
<b>CHAPTER 4 MACHINE CONTROL DEDICATED SIGNALS</b> .....	<b>25</b>
4.1 Internal Relays .....	26
Machine common command signals .....	26
Machine command signals .....	27
Machine status .....	31
4.2 Data Registers .....	34
Machine control device .....	34
Machine monitor device .....	37
<b>CHAPTER 5 MACHINE CONTROL PARAMETERS</b> .....	<b>46</b>
5.1 Machine Common Parameter .....	46
Point block setting .....	46
5.2 Machine Parameter .....	47
Machine basic setting .....	49
Joint axis structure .....	49
Arm length setting .....	49
Machine speed setting .....	49
XYZ stroke limit setting .....	50
Base transformation (install coordinate offset) .....	50
Tool transformation .....	52
Option setting A .....	52
Option setting B .....	52
5.3 Motion Control Parameter of Machine Configuration Axes .....	53
Axis setting parameter .....	53

<b>CHAPTER 6 MACHINE CONTROL DATA</b>	<b>54</b>
<b>6.1 Machine Positioning Data</b> .....	<b>54</b>
<b>6.2 Point Block Data</b> .....	<b>62</b>
Structure of point block data .....	62
<b>CHAPTER 7 POSITIONING CONTROL</b>	<b>65</b>
<b>7.1 Basics of Positioning Control</b> .....	<b>65</b>
Positioning speed .....	65
Positioning speed at the interpolation control .....	66
Interpolation operation and acceleration/deceleration processing .....	70
Control units during machine control .....	72
Control when control unit is "degree" .....	73
Stop processing and restarting after stop .....	74
Operation at home position return incomplete .....	74
<b>7.2 Machine Program Operation</b> .....	<b>75</b>
Linear interpolation/joint interpolation .....	76
Circular interpolation .....	77
Sequential coordinate command control .....	80
Speed switching during instruction .....	84
<b>CHAPTER 8 MANUAL CONTROL</b>	<b>85</b>
<b>8.1 JOG Operation</b> .....	<b>85</b>
<b>8.2 Manual Pulse Generator Operation</b> .....	<b>85</b>
<b>8.3 Machine JOG Operation</b> .....	<b>86</b>
<b>CHAPTER 9 AUXILIARY AND APPLIED FUNCTIONS</b>	<b>89</b>
<b>9.1 Relationship between Machine Control and Each Function</b> .....	<b>89</b>
<b>9.2 Proximity Pass Function</b> .....	<b>90</b>
JOINT remaining distance method (end point distance) .....	90
<b>9.3 Speed Restriction Function</b> .....	<b>98</b>
Joint interpolation speed limit .....	98
Servo motor maximum speed check .....	99
<b>9.4 Base/Tool Transformation Change Function</b> .....	<b>100</b>
<b>9.5 WAIT-ON/OFF</b> .....	<b>103</b>
<b>9.6 Point Arrival Notification</b> .....	<b>105</b>
<b>APPENDICES</b>	<b>107</b>
<b>Appendix 1 Sample Program of Machine Control</b> .....	<b>107</b>
<b>Appendix 2 Machine Control Error Details Codes</b> .....	<b>112</b>
Machine error details codes .....	112
<b>Appendix 3 Machine Control Event Details Codes</b> .....	<b>117</b>
Machine event details codes .....	117
REVISIONS .....	118
WARRANTY .....	119
TRADEMARKS .....	120

# RELEVANT MANUALS

Manual Name [Manual Number]	Description	Available form
MELSEC iQ-R Motion Controller Programming Manual (Machine Control) [IB-0300309] (This manual)	This manual explains the dedicated instructions to use machine control by machine control parameters, machine positioning data, device lists, etc.	Print book e-Manual PDF
MELSEC iQ-R Motion Controller User's Manual [IB-0300235]	This manual explains specifications of the Motion CPU modules, SSCNETⅢ cables, synchronous encoder, troubleshooting, etc.	Print book e-Manual PDF
MELSEC iQ-R Motion Controller Programming Manual (Common) [IB-0300237]	This manual explains the Multiple CPU system configuration, performance specifications, common parameters, auxiliary/applied functions, error lists, etc.	Print book e-Manual PDF
MELSEC iQ-R Motion Controller Programming Manual (Program Design) [IB-0300239]	This manual explains the functions, programming, debugging for Motion SFC, etc.	Print book e-Manual PDF
MELSEC iQ-R Motion Controller Programming Manual (Positioning Control) [IB-0300241]	This manual explains the servo parameters, positioning instructions, device lists, etc.	Print book e-Manual PDF
MELSEC iQ-R Motion Controller Programming Manual (Advanced Synchronous Control) [IB-0300243]	This manual explains the dedicated instructions to use synchronous control by synchronous control parameters, device lists, etc.	Print book e-Manual PDF
MELSEC iQ-R Motion Controller Programming Manual (G-Code Control) [IB-0300371]	This manual explains the dedicated instructions to use G-code control by G-code control parameters and G-code programs.	Print book e-Manual PDF

## Point

e-Manual refers to the Mitsubishi FA electronic book manuals that can be browsed using a dedicated tool.

e-Manual has the following features:

- Required information can be cross-searched in multiple manuals.
- Other manuals can be accessed from the links in the manual.
- The hardware specifications of each part can be found from the product figures.
- Pages that users often browse can be bookmarked.

# TERMS

Unless otherwise specified, this manual uses the following terms.

Term	Description
R64MTCPU/R32MTCPU/R16MTCPU or Motion CPU (module)	Abbreviation for MELSEC iQ-R series Motion controller
MR-J5(W)-□B	Servo amplifier model MR-J5-□B/MR-J5W-□B
MR-J4(W)-□B	Servo amplifier model MR-J4-□B/MR-J4W-□B
MR-J3(W)-□B	Servo amplifier model MR-J3-□B/MR-J3W-□B
AMP or Servo amplifier	General name for "Servo amplifier model MR-J5-□B/MR-J5W-□B/MR-J4-□B/MR-J4W-□B/MR-J3-□B/MR-J3W-□B"
RnCPU, PLC CPU or PLC CPU module	Abbreviation for MELSEC iQ-R series CPU module
Multiple CPU system or Motion system	Abbreviation for "Multiple PLC system of the R series"
CPU <sub>n</sub>	Abbreviation for "CPU No.n (n = 1 to 4) of the CPU module for the Multiple CPU system"
Operating system software	General name for "SW10DNC-RMTFW"
Engineering software package	General name for MT Developer2/GX Works3
MELSOFT MT Works2	General product name for the Motion controller engineering software "SW1DND-MTW2"
MT Developer2	Abbreviation for the programming software included in the "MELSOFT MT Works2" Motion controller engineering software
GX Works3	General product name for the MELSEC PLC software package "SW1DND-GXW3"
Serial absolute synchronous encoder or Q171ENC-W8	Abbreviation for "Serial absolute synchronous encoder (Q171ENC-W8)"
SSCNETⅢ/H <sup>*1</sup>	High speed synchronous network between Motion controller and servo amplifier
SSCNETⅢ <sup>*1</sup>	
SSCNETⅢ(/H)	General name for SSCNETⅢ/H, SSCNETⅢ
Absolute position system	General name for "system using the servo motor and servo amplifier for absolute position"
Intelligent function module	General name for module that has a function other than input or output such as A/D converter module and D/A converter module.
SSCNETⅢ/H head module <sup>*1</sup>	Abbreviation for "MELSEC-L series SSCNETⅢ/H head module (LJ72MS15)"
Optical hub unit or MR-MV200	Abbreviation for SSCNETⅢ/H Compatible Optical Hub Unit (MR-MV200)
Sensing module	General name for SSCNETⅢ/H compatible sensing module MR-MT2000 series
Sensing SSCNETⅢ/H head module <sup>*1</sup> or MR-MT2010	Abbreviation for SSCNETⅢ/H head module (MR-MT2010)
Sensing extension module	General name for I/O module (MR-MT2100), pulse I/O module (MR-MT2200), analog I/O module (MR-MT2300), encoder I/F module (MR-MT2400)
Sensing I/O module or MR-MT2100	Abbreviation for I/O module (MR-MT2100)
Sensing pulse I/O module or MR-MT2200	Abbreviation for pulse I/O module (MR-MT2200)
Sensing analog I/O module or MR-MT2300	Abbreviation for analog I/O module (MR-MT2300)
Sensing encoder I/F module or MR-MT2400	Abbreviation for encoder I/F module (MR-MT2400)

\*1 SSCNET: Servo System Controller NETwork

# MANUAL PAGE ORGANIZATION

## Representation of numerical values used in this manual

### ■Axis No. representation

In the positioning dedicated signals, "n" in "M3200+20n", etc. indicates a value corresponding to axis No. as shown in the following table.

Axis No.	n	Axis No.	n	Axis No.	n	Axis No.	n	Axis No.	n	Axis No.	n	Axis No.	n	Axis No.	n
1	0	9	8	17	16	25	24	33	32	41	40	49	48	57	56
2	1	10	9	18	17	26	25	34	33	42	41	50	49	58	57
3	2	11	10	19	18	27	26	35	34	43	42	51	50	59	58
4	3	12	11	20	19	28	27	36	35	44	43	52	51	60	59
5	4	13	12	21	20	29	28	37	36	45	44	53	52	61	60
6	5	14	13	22	21	30	29	38	37	46	45	54	53	62	61
7	6	15	14	23	22	31	30	39	38	47	46	55	54	63	62
8	7	16	15	24	23	32	31	40	39	48	47	56	55	64	63

- The range of axis No.1 to 16 (n=0 to 15) is valid in the R16MTCPU. The range of axis No.1 to 32 (n=0 to 31) is valid in the R32MTCPU.
- Calculate as follows for the device No. corresponding to each axis.

**Ex.**

For axis No. 32 in Q series Motion compatible device assignment

M3200+20n ([Rq.1140] Stop command)=M3200+20×31=M3820

M3215+20n ([Rq.1155] Servo OFF command)=M3215+20×31=M3835

In the positioning dedicated signals, "n" in "M10440+10n", etc. of the "Synchronous encoder axis status", "Synchronous encoder axis command signal", "Synchronous encoder axis monitor device" and "Synchronous encoder axis control device" indicates a value corresponding to synchronous encoder axis No. as shown in the following table.

Synchronous encoder axis No.	n	Synchronous encoder axis No.	n	Synchronous encoder axis No.	n
1	0	5	4	9	8
2	1	6	5	10	9
3	2	7	6	11	10
4	3	8	7	12	11

- Calculate as follows for the device No. corresponding to each synchronous encoder.

**Ex.**

For synchronous encoder axis No.12 in Q series Motion compatible device assignment

M10440+10n ([St.320] Synchronous encoder axis setting valid flag)=M10440+10×11=M10550

D13240+20n ([Md.320] Synchronous encoder axis current value)=D13240+20×11=D13460



## ■Machine No. representation

In the positioning dedicated signals, "m" in "M43904+32m", etc. indicates a value corresponding to machine No. as shown in the following table.

Machine No.	m	Machine No.	m
1	0	5	4
2	1	6	5
3	2	7	6
4	3	8	7

- Calculate as follows for the device No. corresponding to each machine.

**Ex.**

For machine No.8 in MELSEC iQ-R Motion device assignment

M43904+32m ([St.2120] Machine error detection)  $M43904+32 \times 7 = M44128$

D53168+128m ([Md.2020] Machine type)  $= M53168+28 \times 7 = D54064$

## ■Line No. representation in G-code control

In the positioning dedicated signals, "s" in "D54496+128s", etc. indicates a value corresponding to line No. as shown in the following table.

Line No.	s
1	0
2	1

- Calculate as follows for the device No. corresponding to each line.

**Ex.**

For line No.2 in MELSEC iQ-R Motion device assignment

D54440.0+4s ([St.3208] During G-code control)  $= D54440.0+4 \times 1 = D54444.0$

D54496+128s ([Md.3016] Number of axes on line)  $= D54496+128 \times 1 = D54624$

## ■Line No. and axis No. representation in G-code control

In the positioning dedicated signals, "sn" in "D54278+16sn", etc. indicates a value corresponding to line No. and axis No. as shown in the following table.

Line No.	Axis No.	sn	Line No.	Axis No.	sn
1	1	0	2	1	8
	2	1		2	9
	3	2		3	10
	4	3		4	11
	5	4		5	12
	6	5		6	13
	7	6		7	14
	8	7		8	15

- Calculate as follows for the device No. corresponding to each line.

**Ex.**

For line No.2, axis No. 8 in MELSEC iQ-R Motion device assignment

D54448.0+2sn ([St.3076] Smoothing zero)  $= D54448.0+2 \times 15 = D54478.0$

D54754+32sn ([Md.3146] Rotating axis setting status)  $= D54754+32 \times 15 = D55234$

## Representation of device No. used in this manual

The "R" and "Q" beside the device No. of positioning dedicated signals such as "[Rq.1140] Stop command (R: M34480+32n/ Q: M3200+20n)" indicate the device No. for the device assignment methods shown below. When "R" and "Q" are not beside the device No., the device No. is the same for both device assignment methods.

Symbol	Device assignment method
R	MELSEC iQ-R Motion device assignment
Q	Q series Motion compatible device assignment

# 1 OVERVIEW

## 1.1 Machine Control Overview

- Machine control is the controlling of a simplified robot (link configuration) with a Motion CPU.

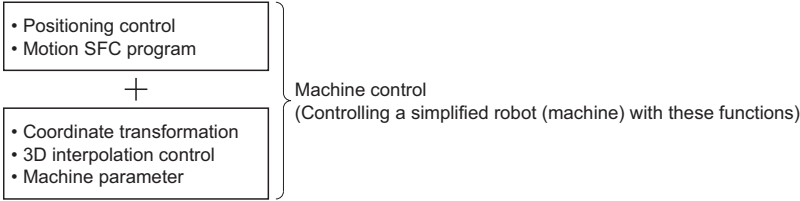

- The specified positioning coordinates (X, Y, Z, A, B, C, FL1) are converted by a coordinate transformation machine library specific to the machine type, which outputs the coordinates to each servo amplifier that makes up the robot.

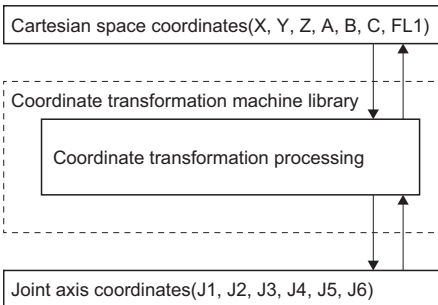

- Various types of articulated robots can be controlled by installing a machine library (add-on library) that matches the robot configuration.

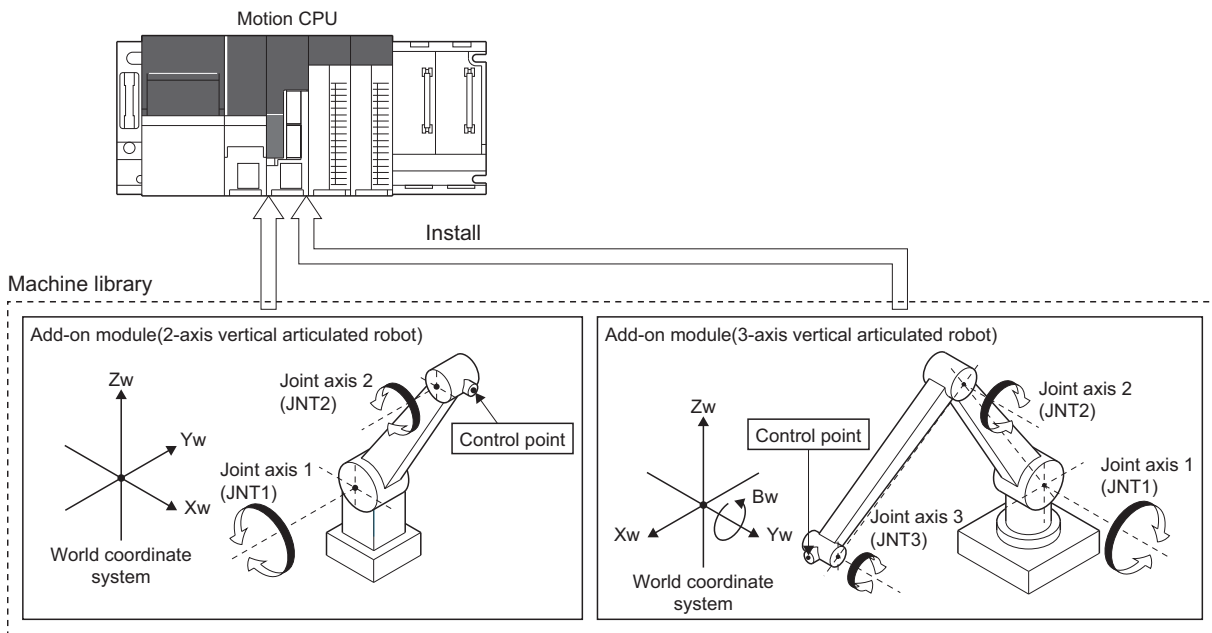

- In machine control, parameters for machine control are set and the multiple axes that make up the robot are controlled together as a machine. A maximum of eight machines can be controlled.

Articulated robot (3-axis configuration)

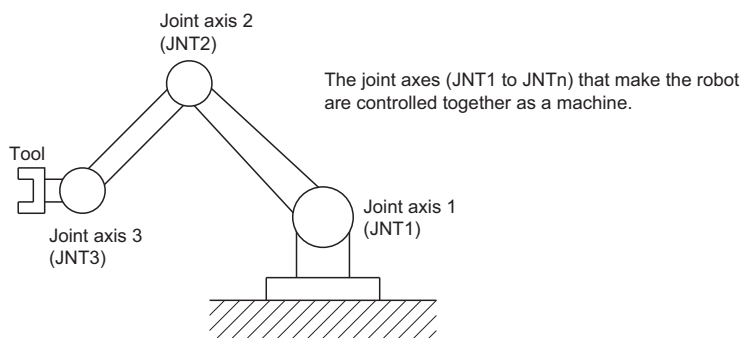

[Machine configuration example]

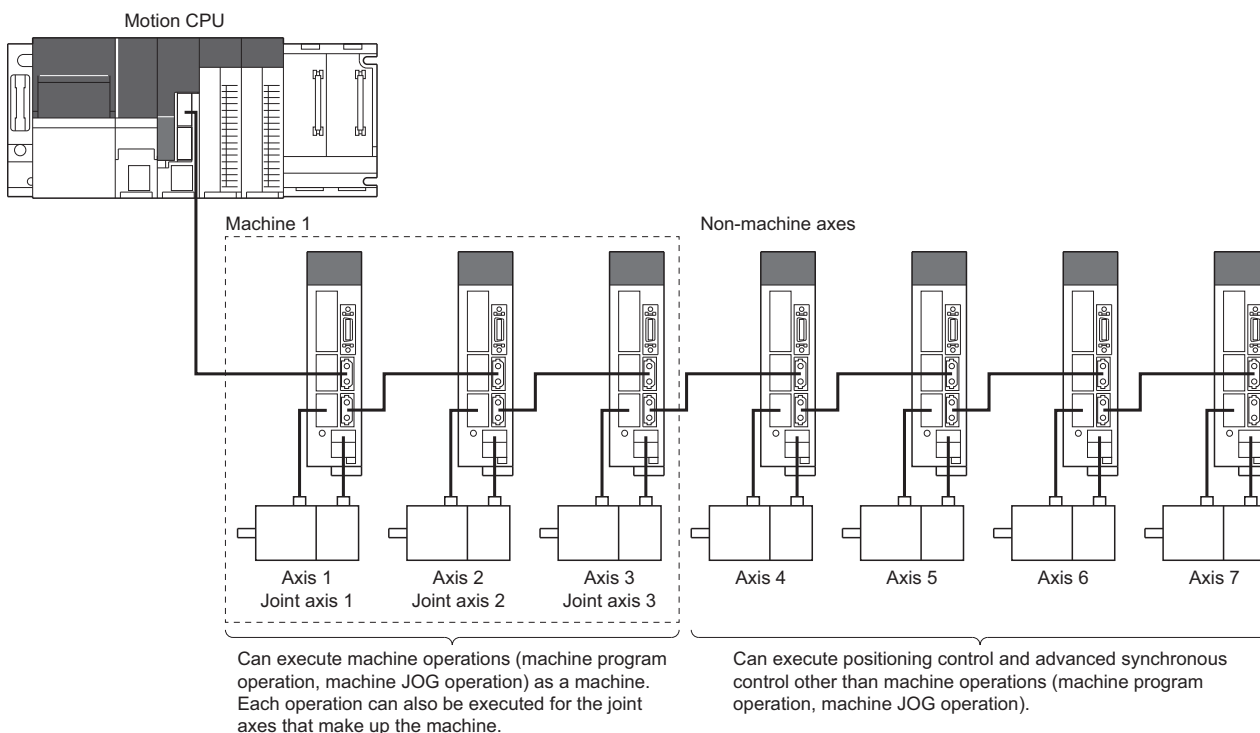

- Machine control uses the machine positioning data set to the devices of the PLC CPU or Motion CPU to start the program operations of the machine control system. Refer to machine positioning data for the details of machine positioning data. (Page 54 Machine Positioning Data)

# 1.2 Performance Specifications

## Machine control specifications

Item		Specifications	
Control axes per machine		Up to 4 axes per machine	
Machine configuration	Number of control machines	8 machines	
	Supported machine types	Each machine type is supported by the machine library (add-on library)	
	Base/tool transformation	Base transformation (X, Y, Z, A, B, C), tool transformation (X, Y, Z) (The enabled coordinate components differ according to machine type.)	
	Operation range setting	Stroke limit for each joint axis, XYZ stroke limit	
Machine control	Coordinate system	World coordinate, base coordinate, tool coordinate, joint coordinate	
	Interpolation functions	3D linear interpolation (up to 4 axes), joint interpolation (up to 4 axes), 3D circular interpolation (up to 4 axes), sequential coordinate command control (up to 4 axes)	
	Control method	3D interpolation control	
	Acceleration/deceleration processing	Trapezoidal acceleration/deceleration, S-curve acceleration/deceleration	
Machine program operation	Program format	Motion profile table format (point data, set control data to device and startup)	
	Number of positioning points	Motion dedicated PLC instruction (M(P).MCNST/D(P).MCNST)	Up to 128 points/program
		Motion dedicated function (MCNST)	Up to 256 points/program <sup>*1</sup>
	Point data	Up to 8192 points (depends on parameter settings) (Position type (POSE)/Joint type (JOINT) specification available)	
	Start method	Motion dedicated PLC instruction (M(P).MCNST/D(P).MCNST), Motion dedicated function (MCNST)	
Machine JOG operation function		World coordinate system, tool coordinate system (The enabled coordinate components differ according to machine type.)	
Machine manual pulse generator function		None	
Teaching operation		None (point data on the devices, program can be changed by converting control data)	
Auxiliary functions of machine operation	M-code function	M-code output function provided	
	Servo motor maximum speed check	Provided (Motors of joint axes are stopped when maximum motor speed is exceeded)	
	Speed adjustment function	Joint interpolation speed limit	
	WAIT-ON/OFF	WAIT-ON/OFF establishment function provided	
	Point arrival notification	Set the arrival rate to the end of each point (can be set in each point)	
	Override function	Provided	
	Proximity function (proximity range specification method)	JOINT remaining distance method (end point distance)	
	Acceleration/deceleration time change	Not available (ignored in machine control)	
Control change during machine operation	Current value change (CHGA)	Not available (Current value change of machine configuration axes is not available during machine operation)	
	Speed change (CHGV)	Not available (ignored in machine operation)	
	Torque limit value change (CHGT)	Provided	
	Target position change (CHGP)	Not available (change of machine program operation positioning point is not available)	
Functions at start-up adjustment		Machine JOG operation with XYZ stroke limit disabled	
Acceleration/deceleration after interpolation (speed smoothing filter on each axis)		Uses vibration suppression command filter	
Simultaneous start (START)		None	

\*1 For operating system software version "09" or earlier, up to 128 points/program.

# 2 STARTING UP THE SYSTEM

The procedure for machine control positioning control is shown below.

## 2.1 Starting Up the Machine Control System

The procedure to start up for machine control system is shown below.

Preparation

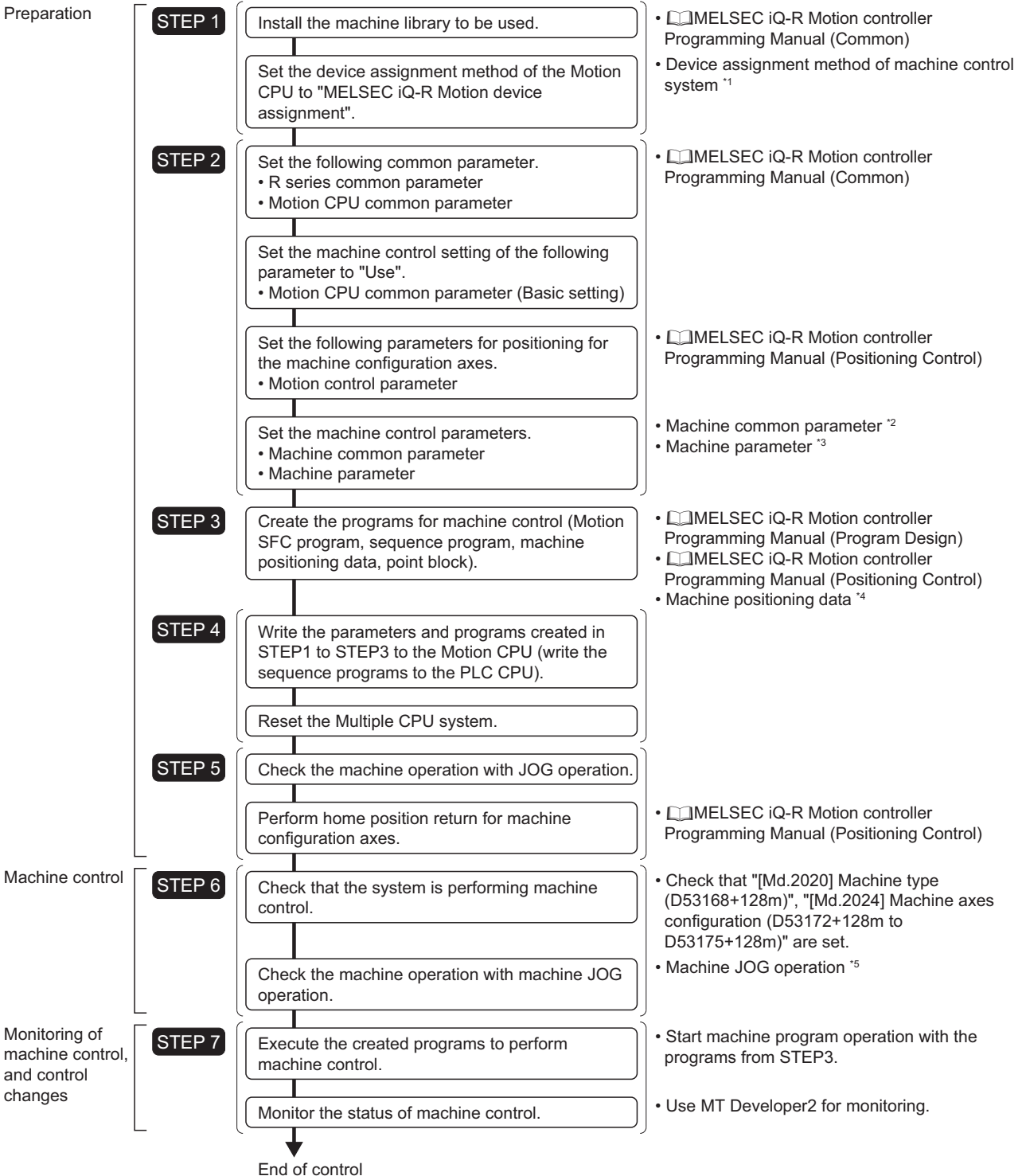

\*1 Machine control system device assignment method( [↗](#) Page 22 Machine Control System Device Assignment Method)

\*2 Machine common parameter( [↗](#) Page 46 Machine Common Parameter)

\*3 Machine parameter( [↗](#) Page 47 Machine Parameter)

\*4 Machine positioning data( [↗](#) Page 54 Machine Positioning Data)

\*5 Machine JOG operation( [↗](#) Page 86 Machine JOG Operation)

## 2.2 Machine Control System Positioning Controls

---

The following positioning controls can be performed in a machine control system.

### Machine program operation start

---

The following two methods are available for machine program start.

#### Machine program operation start by sequence program

By executing the Motion dedicated PLC instruction (machine program operation start request: M(P).MCNST/D(P).MCNST) with a PLC CPU sequence program, the machine program operation of the machine control system starts using the machine positioning data set to the devices of the PLC CPU.

Refer to the following for details of Motion dedicated PLC instructions.

📖 MELSEC iQ-R Motion Controller Programming Manual (Program Design)

#### Machine program operation start by Motion SFC program

By executing the Motion dedicated function (MCNST) with a Motion SFC program, the machine program operation of the machine control system starts using the machine positioning data set to the devices of the Motion CPU.

Refer to the following for details of Motion SFC programs.

📖 MELSEC iQ-R Motion Controller Programming Manual (Program Design)

### Machine JOG operation

---

Machine JOG operation is performed by controlling the JOG dedicated device of the Motion CPU. Refer to machine JOG operation for details of machine JOG operation. (📖 Page 86 Machine JOG Operation)

## 2.3 Machine Control System Stop Operation

When one of the following stop causes occurs in a machine configuration axis during machine control, after the stop processing of all machine configuration axes, "[St.2127] Machine start accept flag (M43911+32m)" turns OFF, and machine control ends.

Stop cause	Stop processing
Multiple CPU system reset operation	Immediate stop
Multiple CPU system power supply OFF	
Motion CPU WDT error	
Forced stop (forced stop by Motion controller (device))	
Forced stop (servo amplifier forced stop input terminal)	
Servo error occurrence	
Servo amplifier control circuit power supply turns OFF	
Software stroke limit error occurrence for each axis	
XYZ stroke limit error occurrence	
Operation outside of range error/Indefinite solutions error	
Input from external input signals (STOP/FLS/RLS) (Deceleration processing on STOP input: Deceleration stop)	
Motion CPU RUN→STOP	
Stop command input	
Machine stop command input	
Servo motor maximum speed check	
Input from external input signals (STOP/FLS/RLS) (Deceleration processing on STOP input: Rapid stop)	Rapid stop
Rapid stop command input	
Machine rapid stop command input	

### Point

Refer to the following for details of stop processing.

 MELSEC iQ-R Motion Controller Programming Manual (Positioning Control)

## 2.4 Machine Control System Device Assignment Method

"MELSEC iQ-R Motion device assignment" is the recommended device assignment method when using machine control. Refer to the following for details of device assignment methods.

 MELSEC iQ-R Motion Controller Programming Manual (Common)

Refer to machine control dedicated signals for devices used by machine control. ( Page 25 MACHINE CONTROL DEDICATED SIGNALS)

### Cautions

When performing machine control with R32MTCPU/R16MTCPU in "Q series Motion compatible device assignment", set the points of the internal relay(M) and data register(D) to the points below or more in [R Series Common Parameter] ⇒ [Motion CPU Module] ⇒ [CPU Parameter] ⇒ "Device Related Setting" ⇒ "Device Points/Latch Setting". If machine control is performed with the default device points a moderate error (error code: 30FBH) occurs and machine control cannot be performed.

Device	Minimum points setting when using machine control
Internal relay (M)	44160 points
Data register (D)	54192 points

Refer to the following for details on device points/latch setting.

 MELSEC iQ-R Motion Controller Programming Manual (Common)



# 3 MACHINES

## 3.1 Overview of a Machine

A machine can be used by installing machine library (add-on library) for the machine type to be used to the Motion CPU module.

For details on each machine type, refer to the instruction manual of the machine library.

Refer to the following for details on installing the machine library.

📖 MELSEC iQ-R Motion Controller Programming Manual (Common)



For details of the machine library, please contact with our sales representative.

### Machine Position

Machine position is expressed by position type, or joint type. Data of position type uses the reference position data of the world coordinate system, as well as the position data of base coordinate system and tool coordinate system.

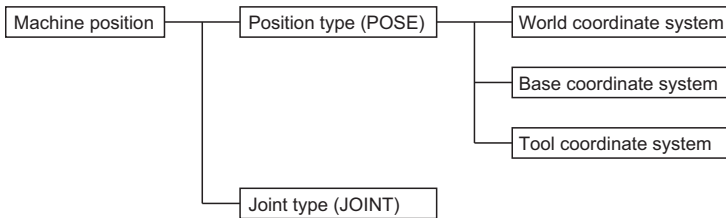

### Position type

#### ■ Basic format

Position type format is shown below.

(X coordinate, Y coordinate, Z coordinate, A coordinate, B coordinate, C coordinate) (Structure flag 1)

Position component	Details	Command range/operation range *1
X	Position (distance) to move in the X direction	-2147483648 to 2147483647( $\times 10^{-1}$ [ $\mu\text{m}$ ])
Y	Position (distance) to move in the Y direction	
Z	Position (distance) to move in the Z direction	
A	Angle to rotate the A coordinate	-2147483648 to 2147483647( $\times 10^{-5}$ [degree])
B	Angle to rotate the B coordinate	
C	Angle to rotate the C coordinate	
FL1	Structure flag 1	H0000 to HFFFF

\*1 Command range/operation range differs by machine type. For details, refer to the machine library instruction manual.

## Coordinate system

Robot coordinate systems are shown below.

Coordinate system	Details	Remarks
World coordinate system	The coordinate system set to the ground or the floor.	When specifying end point with an absolute value command, normally, command is by the world coordinate system.
Base coordinate system	The coordinate system set to the base of the robot.	The relationship between the positions of the world coordinate system and the base coordinate system are set by the base transformation.
Tool coordinate system	The coordinate system with the control point as the home position.	The relationship between the positions of the mechanical interface (tool mounting position) and the control point are set by the tool transformation.

Ex.

Coordinate system for a 3-axis vertical articulated robot

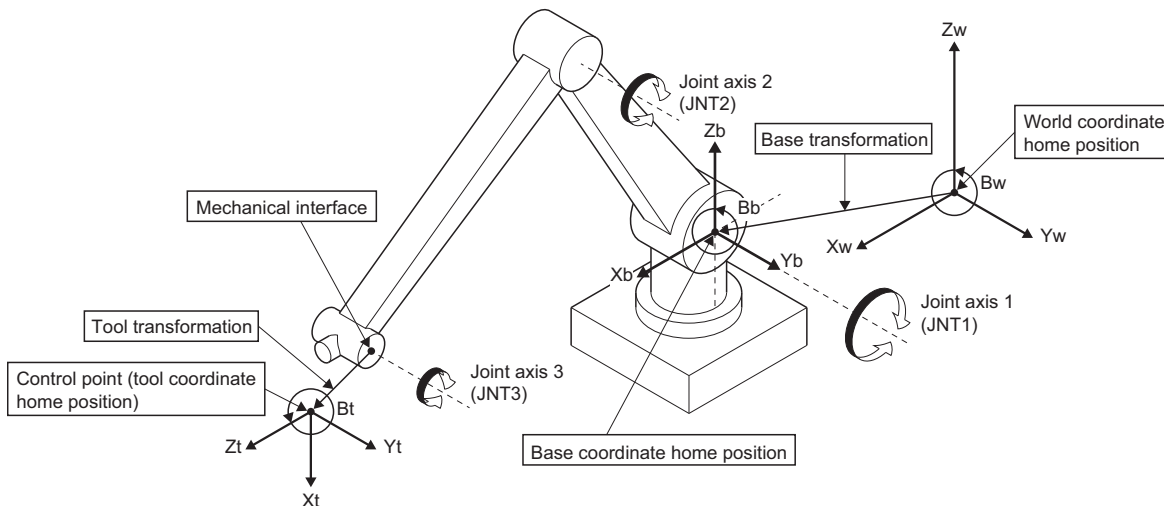

## Joint type

### Basic format

Joint type format is shown below.

Position component	Details	Command range/operation range <sup>*1*2</sup>
J1	Position (distance) for moving JNT1	<ul style="list-style-type: none"> <li>• mm: -2147483648 to 2147483647(<math>\times 10^{-1}</math>[<math>\mu\text{m}</math>])</li> <li>• degree: -72000000 to 72000000(<math>\times 10^{-5}</math>[degree])</li> </ul>
J2	Position (distance) for moving JNT2	
J3	Position (distance) for moving JNT3	
J4	Position (distance) for moving JNT4	
J5	Position (distance) for moving JNT5	
J6	Position (distance) for moving JNT6	

\*1 Command range/operation range differs by machine type. For details, refer to the machine library instruction manual.



\*2 The unit is the unit setting for each joint axis.

# 4 MACHINE CONTROL DEDICATED SIGNALS

Machine control devices used for machine control are shown below.

Device	Device range	
	MELSEC iQ-R Motion device assignment	Q series Motion compatible device assignment
Internal relay (M)	M43584 to M44159 (576 points)	
Data register (D)	D52880 to D54191 (1312 points)	

## Point

- When using R32MTCPU/R16MTCPU in Q series Motion compatible device assignment, the device range must be changed in device points/latch setting so that it is the minimum setting range or more for using machine control. If machine control is performed with the default device points a moderate error (error code: 30FBH) occurs. (  Page 22 Machine Control System Device Assignment Method)
- This manual only explains the internal relays and data registers used for machine control. Refer to the following for the devices that are not explained in this manual.  
 MELSEC iQ-R Motion Controller Programming Manual (Positioning Control)

# 4.1 Internal Relays

## Machine common command signals

Device No.		Symbol	Signal name	Refresh cycle	Fetch cycle	Signal type
MELSEC iQ-R Motion device assignment	Q series Motion compatible device assignment					
M43584		Rq.2200	Real current value monitor enable flag	—	Operation cycle	Command signal
M43585		—	Unusable	—	—	—
M43586						
M43587						
M43588						
M43589						
M43590						
M43591						
M43592						
M43593						
M43594						
M43595						
M43596						
M43597						
M43598						
M43599						
M43600						
M43601						
M43602						
M43603						
M43604						
M43605						
M43606						
M43607						
M43608						
M43609						
M43610						
M43611						
M43612						
M43613						
M43614						
M43615						

### [Rq.2200] Real current value monitor enable flag (M43584)

- This flag monitors the real coordinate values.
- When "[Rq.2200] Real current value monitor enable flag (M43584)" is ON, the real coordinate values are stored in the "[Md.2084] to [Md.2090] Real current value (world coordinate system) (X to FL1) (D53278+128m to D53290+128m)" monitor device.
- When "[Rq.2200] Real current value monitor enable flag (M43584)" is OFF, real coordinate values are not updated.

**Point** 

If the real coordinate values are monitored, the operation cycle increases. When operation cycle over is detected, change the operation cycle setting to a larger value.

# Machine command signals

Device No.		Signal name
MELSEC iQ-R Motion device assignment	Q series Motion compatible device assignment	
M43616 to M43647		Machine 1 machine command signal
M43648 to M43679		Machine 2 machine command signal
M43680 to M43711		Machine 3 machine command signal
M43712 to M43743		Machine 4 machine command signal
M43744 to M43775		Machine 5 machine command signal
M43776 to M43807		Machine 6 machine command signal
M43808 to M43839		Machine 7 machine command signal
M43840 to M43871		Machine 8 machine command signal

• Details for each machine

Device No.		Symbol	Signal name	Refresh cycle	Fetch cycle	Signal type	
MELSEC iQ-R Motion device assignment	Q series Motion compatible device assignment						
M43616+32m		Rq.2240	Machine error reset command	—	Main cycle	Command signal	
M43617+32m		—	Unusable	—	—	—	
M43618+32m							
M43619+32m		Rq.2243	Machine XYZ stroke limit disable command	—	At machine JOG start	Command signal	
M43620+32m		Rq.2244	Base/tool translation change command		Operation cycle		
M43621+32m		Rq.2245	Machine stop command				
M43622+32m		Rq.2246	Machine rapid stop command				
M43623+32m		Rq.2247	Execute point switching command				
M43624+32m		—	Unusable	—	—	—	
M43625+32m							
M43626+32m							
M43627+32m							
M43628+32m							
M43629+32m							
M43630+32m							
M43631+32m							
M43632+32m		Rq.2250	Machine forward rotation JOG start command	—	Main cycle	Command signal	
M43633+32m		Rq.2251					X
M43634+32m		Rq.2252					Y
M43635+32m		Rq.2253					Z
M43636+32m		Rq.2254					A
M43637+32m		Rq.2255					B
M43638+32m		—	Unusable	—	—	—	
M43639+32m							
M43640+32m		Rq.2256	Machine reverse rotation JOG start command	—	Main cycle	Command signal	
M43641+32m		Rq.2257					X
M43642+32m		Rq.2258					Y
M43643+32m		Rq.2259					Z
M43644+32m		Rq.2260					A
M43645+32m		Rq.2261					B
M43646+32m		—	Unusable	—	—	—	
M43647+32m							

## [Rq.2240] Machine error reset command (M43616+32m)

This command is used to clear the "[Md.2023] Machine warning code (D53171+128m)" and "[Md.2022] Machine error code (D53170+128m)" of an axis for "[St.2120] Machine error detection (M43904+32m)": ON, and reset the "[St.2120] Machine error detection (M43904+32m)". At the same time, it also resets all error statuses and monitor devices related to machine configuration axes.

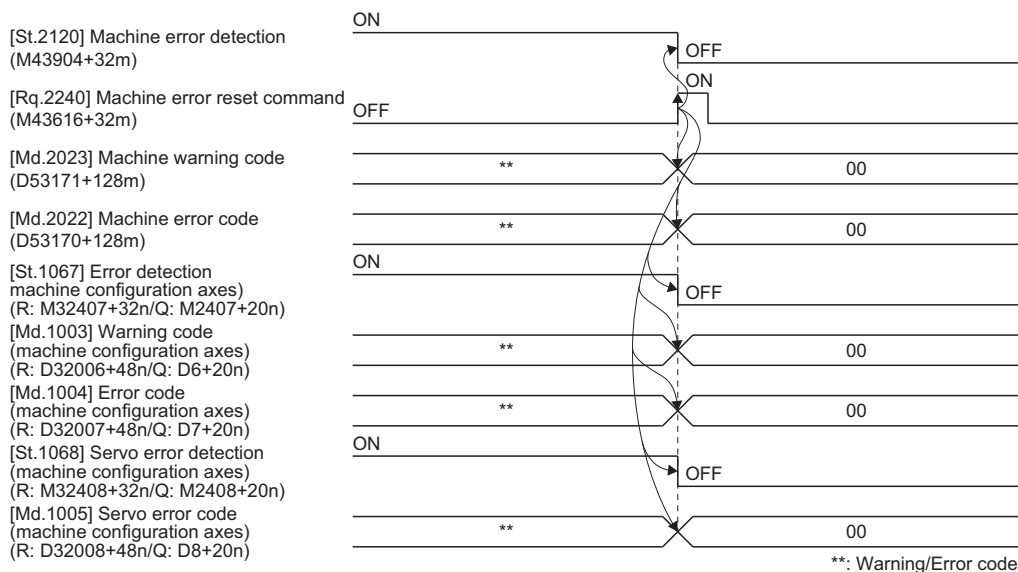

### Point

Refer to the following for details on the warning code, error code, and servo error code storage registers.

MELSEC iQ-R Motion Controller Programming Manual (Common)

## [Rq.2243] Machine XYZ stroke limit disable command (M43619+32m)

- This signal is used to disable the XYZ stroke limit check set in [Motion Control Parameter] ⇒ [Machine Control Parameter] ⇒ [Machine Parameter] ⇒ "XYZ Stroke Limit Setting". Turn it ON when disabling the XYZ stroke limit.

Setting value	Description
ON	XYZ stroke limit disabled. XYZ stroke limit check is not performed.
OFF	XYZ stroke limit enabled. XYZ stroke limit check is performed.

- The "[Rq.2243] Machine XYZ stroke limit disable command (M43619+32m)" can only disable the XYZ stroke limit check during machine JOG operation.
- When using the XYZ stroke limit disable command, turn ON "[Rq.2243] Machine XYZ stroke limit disable command (M43619+32m)" before starting machine JOG operation. (The setting value is loaded at the start.)
- During machine JOG operation, XYZ stroke limit enable/disable cannot be changed even if "[Rq.2243] Machine XYZ stroke limit disable command (M43619+32m)" is changed.
- The software stroke limit (fixed parameter) of each axis cannot be disabled with "[Rq.2243] Machine XYZ stroke limit disable command (M43619+32m)".

## CAUTION

- When using an absolute position system, only use "[Rq.2243] Machine XYZ stroke limit disable command (M43619+32m)" to disable XYZ stroke limit range check temporarily in cases such as a brand new startup, or after replacing a controller or absolute position compatible motor.
- When disabling the XYZ stroke limit range check, install stopping equipment to secure safety on the machinery.

### [Rq.2244] Base/tool translation change command (M43620+32m)

- After setting "[Cd.2163] Base/tool translation change method (D52901+32m)", and "[Cd.2164] to [Cd.2169] Base/tool translation setting (X to C) (D52902+32m to D52913+32m)", the "[Rq.2244] Base/tool translation change command (M43620+32m)" changes the base/tool transformation values at the leading edge (OFF→ON).
- When the machine configuration axes are in operation, a minor error (error code: 1FE7H) occurs, and base/tool transformation change is not performed.
- Refer to base/tool transformation change for details the base/tool transformation change function. (☞ Page 100 Base/Tool Transformation Change Function)

### [Rq.2245] Machine stop command (M43621+32m)

- This command is a signal which stops a running machine and is effective at leading edge (OFF→ON) of the signal.
- Machines with the machine stop command turned ON cannot be started for machine operation.
- The machine stop command is only enabled for machine operation. To stop machine configuration axes for anything other than machine operation, use "[Rq.1140] Stop command (R: M34480+32n/Q: M3200+20n).
- Machine stop command is invalid in dwell time of the end point. (After dwell time, "[St.1040] Start accept flag (R: M30080+n/Q: M2001+n)", and "[St.2127] Machine start accept flag (M43911+32m)" turn OFF, and "[St.1061] Positioning complete (R: M32401+32n/Q: M2401+20n)" turns ON.)
- The details of stop processing for when machine stop command turns ON are shown in the table below.

Machine operation being executed	Processing when machine stop command turns ON	
	During control	During deceleration stop processing
Machine program operation	The machine decelerates to a stop in the deceleration time set in the parameter block or machine positioning data.	The deceleration stop processing is continued.
Machine JOG operation	The machine decelerates to a stop in the deceleration time set in the parameter block.	

### [Rq.2246] Machine rapid stop command (M43622+32m)

- This command performs a rapid stop from an external source and becomes effective at leading edge (OFF→ON) of the signal.
- Machines with the machine rapid stop command turned ON cannot be started for machine operation.
- The machine rapid stop command is only enabled for machine operation. To stop machine configuration axes for anything other than machine operation, use "[Rq.1141] Rapid stop command (R: M34481+32n/Q: M3201+20n).
- Machine rapid stop command is invalid in dwell time of the end point. (After dwell time, "[St.1040] Start accept flag (R: M30080+n/Q: M2001+n)", and "[St.2127] Machine start accept flag (M43911+32m)" turn OFF, and "[St.1061] Positioning complete (R: M32401+32n/Q: M2401+20n)" turns ON.)
- The details of stop processing when machine rapid stop command turns ON are shown in the table below.

Machine operation being executed	Processing when machine rapid stop command turns ON	
	During control	During deceleration stop processing
Machine program operation	The machine decelerates to a stop in the rapid stop deceleration time set in the parameter block or machine positioning data.	Deceleration processing is stopped and rapid stop processing is executed.
Machine JOG operation	The machine decelerates to a stop in the rapid stop deceleration time set in the parameter block.	

### [Rq.2247] Execute point switching command (M43623+32m)

This command switches execute point during sequential coordinate command control of machine program operation and becomes effective at leading edge (OFF→ON) of the signal.

## **[Rq.2250 to 2255] Machine forward rotation JOG start command (X to C) (M43632+32m to M43637+32m)**

- This command executes machine JOG operation (world coordinate machine JOG, tool coordinate machine JOG) in each coordinate of machine control.
- Machine JOG operation to the address increase direction is executed while "[Rq.2250] to [Rq.2255] Machine forward rotation JOG start command (X to C) (M43632+32m to M43637+32m)" is ON.
- When "[Rq.2250] to [Rq.2255] Machine forward rotation JOG start command (X to C) (M43632+32m to M43637+32m)" is turned OFF, a deceleration stop is executed in the deceleration time set in the parameter block.
- The coordinate system for executing machine JOG operation is specified by "[Cd.2162] Machine JOG coordinate system setting (D52900+32m)".
- The machine JOG operation speed is specified by "[Cd.2160] Machine JOG speed setting(mm) (D52896+32m, D52897+32m)", and "[Cd.2161] Machine JOG speed setting (degree)(D52898+32m, D52899+32m)".
- The machine JOG operation speed limit value is the speed limit value set in [Motion Control Parameter] ⇒ [Machine Control Parameter] ⇒ [Machine Parameter] ⇒ "Machine JOG Speed Limit Value (mm)", or "Machine JOG Speed Limit Value (degree)".
- The machine JOG operation acceleration/deceleration time is the acceleration time and deceleration time of the parameter block set in [Motion Control Parameter] ⇒ [Machine Control Parameter] ⇒ [Machine Parameter] ⇒ "Parameter Block Designation".
- Refer to machine JOG operation for details of machine JOG operation. (  Page 86 Machine JOG Operation)
- The coordinates for which machine JOG operation are possible differ by machine type. Refer to the instruction manual of the machine library for details of machine type.

### **Point**

Take an interlock so that the "[Rq.2250] to [Rq.2255] Machine forward rotation JOG start command (X to C) (M43632+32m to M43637+32m)" and "[Rq.2256] to [Rq.2261] Machine reverse rotation JOG start command (X to C) (M43640+32m to M43645+32m)" may not turn ON simultaneously.

## **[Rq.2256 to 2261] Machine reverse rotation JOG start command (X to C) (M43640+32m to M43645+32m)**

- This command executes machine JOG operation (world coordinate machine JOG, tool coordinate machine JOG) in each coordinate of machine control.
- Machine JOG operation to the address decrease direction is executed while "[Rq.2256] to [Rq.2261] Machine reverse rotation JOG start command (X to C) (M43640+32m to M43645+32m)" is ON.
- When "[Rq.2256] to [Rq.2261] Machine reverse rotation JOG start command (X to C) (M43640+32m to M43645+32m)" is turned OFF, a deceleration stop is executed in the deceleration time set in the parameter block.
- The coordinate system for executing machine JOG operation is specified by "[Cd.2162] Machine JOG coordinate system setting (D52900+32m)".
- The machine JOG operation speed is specified by "[Cd.2160] Machine JOG speed setting(mm) (D52896+32m, D52897+32m)", and "[Cd.2161] Machine JOG speed setting (degree)(D52898+32m, D52899+32m)".
- The machine JOG operation speed limit value is the speed limit value set in "Machine JOG speed limit value (mm)", or "Machine JOG speed limit value (degree)" of the machine parameters.
- The machine JOG operation acceleration/deceleration time is the acceleration time and deceleration time of the parameter block set in "Parameter block designation".
- Refer to machine JOG operation for details of machine JOG operation. (  Page 86 Machine JOG Operation)
- The coordinates for which machine JOG operation are possible differ by machine type. Refer to the instruction manual of the machine library for details of machine type.

### **Point**

Take an interlock so that the "[Rq.2250] to [Rq.2255] Machine forward rotation JOG start command (X to C) (M43632+32m to M43637+32m)" and "[Rq.2256] to [Rq.2261] Machine reverse rotation JOG start command (X to C) (M43640+32m to M43645+32m)" may not turn ON simultaneously.



# Machine status

Device No.		Signal name
MELSEC iQ-R Motion device assignment	Q series Motion compatible device assignment	
M43904 to M43935		Machine 1 machine status
M43936 to M43967		Machine 2 machine status
M43968 to M43999		Machine 3 machine status
M44000 to M44031		Machine 4 machine status
M44032 to M44063		Machine 5 machine status
M44064 to M44095		Machine 6 machine status
M44096 to M44127		Machine 7 machine status
M44128 to M44159		Machine 8 machine status

• Details for each machine

Device No.		Symbol	Signal name	Refresh cycle	Fetch cycle	Signal type
MELSEC iQ-R Motion device assignment	Q series Motion compatible device assignment					
M43904+32m		St.2120	Machine error detection	Immediate	—	Status signal
M43905+32m		—	Unusable	—	—	—
M43906+32m		St.2122	Machine WAIT	Operation cycle	—	Status signal
M43907+32m		St.2123	Joint interpolation velocity limiting			
M43908+32m		St.2124	Base/tool translation change complete			
M43909+32m		—	Unusable	—	—	—
M43910+32m						
M43911+32m		St.2127	Machine start accept flag	Operation cycle	—	Status signal
M43912+32m		St.2128	Machine servo ready			
M43913+32m		—	Unusable	—	—	—
M43914+32m						
M43915+32m						
M43916+32m						
M43917+32m						
M43918+32m						
M43919+32m						
M43920+32m						
M43921+32m						
M43922+32m						
M43923+32m						
M43924+32m						
M43925+32m						
M43926+32m						
M43927+32m						
M43928+32m						
M43929+32m						
M43930+32m						
M43931+32m						
M43932+32m						
M43933+32m						
M43934+32m						
M43935+32m						

## [St.2120] Machine error detection (M43904+32m)

- This signal turns on with detection of a machine related warning or error, and can be used to judge whether there is a warning or error or not. The applicable warning code is stored in the "[Md.2023] Machine warning code (D53171+128m)" with detection of a machine related warning. The applicable error code is stored in the "[Md.2022] Machine error code (D53170+128m)" with detection of a machine related error. Refer to the following for details of warning codes and error codes.

📖 MELSEC iQ-R Motion Controller Programming Manual (Common)

- The signal turns OFF when the "[Rq.2240] Machine error reset command (M43616+32m)" turns ON.

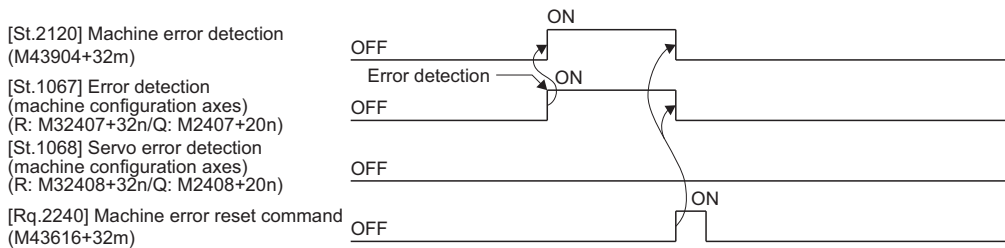

## [St.2122] Machine WAIT (M43906+32m)

- This signal turns ON when waiting for the conditions to turn ON/OFF the bit device specified by WAIT-ON/OFF.
- When the specified bit device is turned ON/OFF due to conditions being established, "[St.2122] Machine WAIT (M43906+32m)" turns OFF, and positioning is executed.
- When a stop factor such as an error occurs while waiting for the conditions to turn the specified bit device ON/OFF, "[St.2122] Machine WAIT (M43906+32m)" turns OFF, and the waiting for conditions status is cancelled.
- When vibration suppression command filter (acceleration/deceleration process after interpolation) is set while waiting for the conditions to turn the specified bit device ON/OFF, "[St.2122] Machine WAIT (M43906+32m)" turns ON before the actual positioning operation is completed because of the delay caused by the filter.
- Refer to WAIT-ON/OFF for details of WAIT-ON/OFF. (📖 Page 103 WAIT-ON/OFF)

## ⚠ CAUTION

The machine WAIT signal should not be turned ON/OFF by the user.

- If the machine WAIT signal is turned OFF using the program or by a user operation, no error will occur but the condition of the devices and the machine are not reliable. Depending on the program settings, unpredictable operations can occur.

## [St.2123] Joint interpolation velocity limiting (M43907+32m)

- This signal turns ON while speed is adjusted by the joint interpolation speed limit function during machine program operation.
- When speed is adjusted by the joint interpolation speed limit function, this signal turns ON at positioning start completion and at the start of each point. From then onwards, the signal turns OFF by either switching to a control method other than joint interpolation or a joint interpolation control that does not use the joint interpolation speed limit function to adjust speed, or by positioning completion or by stop completion due to a stop cause.

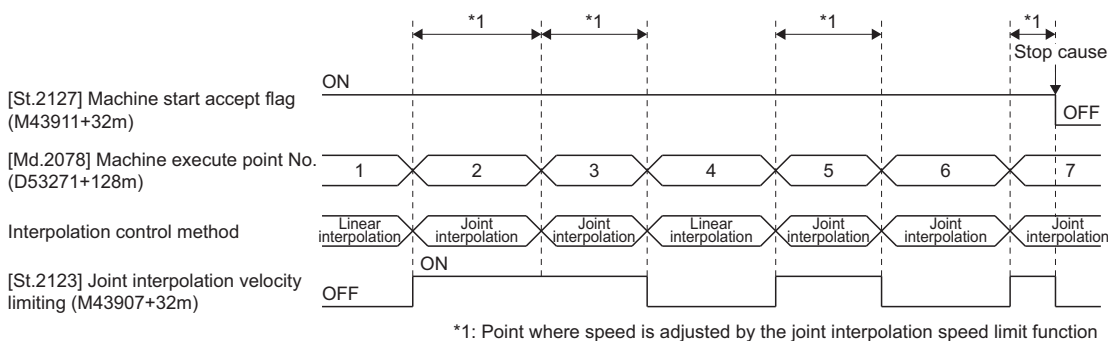

- Refer to joint interpolation speed limit for details of the joint interpolation speed limit function. (📖 Page 98 Joint interpolation speed limit)

### [St.2124] Base/tool translation change complete (M43908+32m)

This signal turns ON with the completion of base/tool transformation change. The signal turns OFF at the trailing edge (ON→OFF) of "[Rq.2244] Base/tool translation change command (M43620+32m)".

Refer to base/tool transformation change function for details on base/tool transformation change. (☞ Page 100 Base/Tool Transformation Change Function)

### [St.2127] Machine start accept flag (M43911+32m)

- This flag turns ON when the machine is started. The machine start accept flag, and "[St.1040] Start accept flag (R: M30080+n/Q: M2001+n)" of the machine configuration axes turns ON. "[St.2127] Machine start accept flag (M43911+32m)" also turns ON when any of the machine configuration axes is started.
- The machine start accept flag turns ON when the following controls are being executed.

	Control
Machine operation	<ul style="list-style-type: none"> <li>• Machine program operation</li> <li>• Machine JOG operation</li> </ul>
Other than machine operation (Machine configuration axis)	<ul style="list-style-type: none"> <li>• Servo program</li> <li>• Direct positioning control by the Motion dedicated PLC instruction (M(P).SVSTD/D(P).SVSTD)</li> <li>• JOG operation</li> <li>• Manual pulse generator operation</li> <li>• Speed-torque control</li> <li>• Synchronous control operation (output axis)</li> <li>• Current value change</li> <li>• Pressure control</li> </ul>

- A current value change by servo program CHGA instruction to the machine configuration axes, or by the Motion dedicated PLC instruction (M(P).CHGA/D(P).CHGA), turns ON "[St.1040] Start accept flag (R: M30080+n/Q: M2001+n)", and "[St.2127] Machine start accept flag (M43911+32m)" of the axes that execute the current value change.
- A base/tool transformation change by "[Rq.2244] Base/tool translation change command (M43620+32m)" does not turn ON "[St.1040] Start accept flag (R: M30080+n/Q: M2001+n)" of the machine configuration axes, and "[St.2127] Machine start accept flag (M43911+32m)".

## ⚠ CAUTION

Do not turn the machine start accept flags ON/OFF in the user side.

- If the machine start accept flag is turned OFF using the program or user operation while this flag is ON, no error will occur but the positioning operation will not be reliable. Depending on the type of machine, unpredictable operations can occur.
- If the machine start accept flag is turned ON using the program or user operation while this flag is OFF, no error will occur but the "start accept on error" will occur at the next starting and cannot be started.

### [St.2128] Machine servo ready (M43912+32m)

- When "[St.1075] Servo ready (R: M32415+32n/Q: M2415+20n)" of all axes that make up the machine are turned ON, "[St.2128] Machine servo ready (M43912+32m)" turns ON.
- When "[St.1075] Servo ready (R: M32415+32n/Q: M2415+20n)" of one of the configuration axes turns OFF, "[St.2128] Machine servo ready (M43912+32m)" turns OFF.

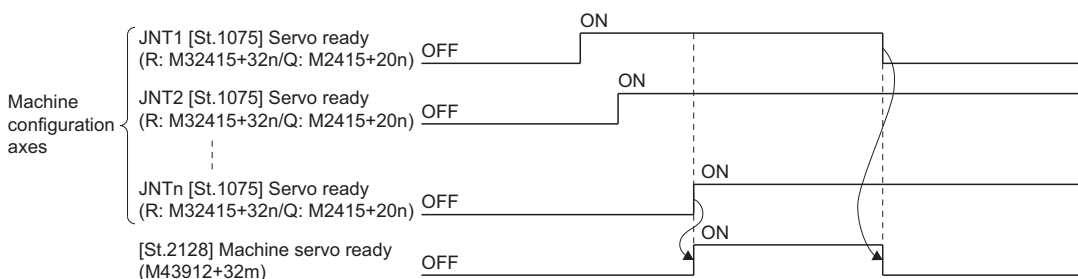

## 4.2 Data Registers

### Machine control device

Device No.		Signal name
MELSEC iQ-R Motion device assignment	Q series Motion compatible device assignment	
D52896 to D52927		Machine 1 machine control device
D52928 to D52959		Machine 2 machine control device
D52960 to D52991		Machine 3 machine control device
D52992 to D53023		Machine 4 machine control device
D53024 to D53055		Machine 5 machine control device
D53056 to D53087		Machine 6 machine control device
D53088 to D53119		Machine 7 machine control device
D53120 to D53151		Machine 8 machine control device

• Details for each machine

Device No.		Symbol	Signal name	Refresh cycle	Fetch cycle	Signal type
MELSEC iQ-R Motion device assignment	Q series Motion compatible device assignment					
D52896+32m		Cd.2160	Machine JOG speed setting(mm)	—	At machine JOG start	Command device
D52897+32m						
D52898+32m		Cd.2161	Machine JOG speed setting(degree)			
D52899+32m						
D52900+32m		Cd.2162	Machine JOG coordinate system setting			
D52901+32m		Cd.2163	Base/tool translation change method		At base/tool translation change command ON	
D52902+32m		Cd.2164	Base/tool translation setting	X		
D52903+32m						
D52904+32m		Cd.2165		Y		
D52905+32m						
D52906+32m		Cd.2166		Z		
D52907+32m						
D52908+32m		Cd.2167		A		
D52909+32m						
D52910+32m		Cd.2168		B		
D52911+32m						
D52912+32m		Cd.2169		C		
D52913+32m						
D52914+32m		—	Unusable	—	—	—
D52915+32m						
D52916+32m						
D52917+32m						
D52918+32m						
D52919+32m						
D52920+32m						
D52921+32m						
D52922+32m						
D52923+32m						
D52924+32m						
D52925+32m						
D52926+32m						

Device No.		Symbol	Signal name	Refresh cycle	Fetch cycle	Signal type
MELSEC iQ-R Motion device assignment	Q series Motion compatible device assignment					
D52927+32m		—	Unusable	—	—	—

### [Cd.2160] Machine JOG speed setting (mm)(D52896+32m, D52897+32m)

- This register stores the JOG speed at the JOG operation.
- Set the speed for machine JOG operation for a coordinate system in "mm". Setting range of the machine JOG operation speed is shown below.

Item	Setting range
Machine JOG speed	1 to 600000000( $\times 10^{-2}$ [mm/min])

- The machine JOG speed is the value stored in the "[Cd.2160] Machine JOG speed setting (mm) (D52896+32m, D52897+32m)" at the leading edge (OFF→ON) of the machine JOG start command.
- Even if data is changed during the machine JOG operation, machine JOG speed cannot be changed.
- When machine JOG speed setting is started as "0", a minor error (error code: 1FE0H(details code: 00E1H)) occurs and operation does not start.
- Refer to machine JOG operation for details of machine JOG operation. (  Page 86 Machine JOG Operation)

### [Cd.2161] Machine JOG speed setting (degree)(D52898+32m, D52899+32m)

- This register stores the JOG speed at the JOG operation.
- Set the speed for machine JOG operation for a coordinate system in "degree". Setting range of the machine JOG operation speed is shown below.

Item	Setting range
Machine JOG speed	1 to 2147483647( $\times 10^{-3}$ [degree/min])

- The machine JOG speed is the value stored in the "[Cd.2161] Machine JOG speed setting (degree) (D52898+32m, D52899+32m)" at the leading edge (OFF→ON) of the machine JOG start command.
- Even if data is changed during the machine JOG operation, machine JOG speed cannot be changed.
- When machine JOG speed setting is started as "0", a minor error (error code: 1FE0H(details code: 00E1H)) occurs and operation does not start.
- Refer to machine JOG operation for details of machine JOG operation. (  Page 86 Machine JOG Operation)

### [Cd.2162] Machine JOG coordinate system setting (D52900+32m)

- This register stores the coordinate system executed during machine JOG operation.

Setting value	Coordinate system
0	World coordinate system
2	Tool coordinate system

- When an invalid value is set, a minor error (error code: 1FE0H(details code: 00E0H)) occurs and operation does not start.
- The machine JOG coordinate system is the value stored in the "[Cd.2162] Machine JOG coordinate system setting (D52900+32m)" at the leading edge (OFF→ON) of the machine JOG start command.
- Even if data is changed during the machine JOG operation, machine JOG coordinate system cannot be changed.
- Refer to machine JOG operation for details of machine JOG operation. (  Page 86 Machine JOG Operation)

## [Cd.2163] Base/tool translation change method (D52901+32m)

- This register stores the change method when the value of base transformation/tool transformation changes.

Setting value	Changing data	Details
0	Base transformation	The base transformation value changes to the value of "[Cd.2164] to [Cd.2169] Base/tool translation setting (X to C) (D52902+32m to D52913+32m)".
1		The base transformation value changes to the initial base transformation value.*1
2	Tool transformation	The base transformation value changes to the value of "[Cd.2164] to [Cd.2169] Base/tool translation setting (X to C) (D52902+32m to D52913+32m)".
3		The tool transformation value changes to the initial tool transformation value.*2

\*1 The initial base transformation value is the base transformation value set in the machine parameter.

\*2 The initial tool transformation value is the tool transformation value set in the machine parameter.

- The base/tool transformation change method is the value stored in "[Cd.2164] to [Cd.2169] Base/tool translation setting (X to C) (D52902+32m to D52913+32m)" at the leading edge (OFF→ON) of "[Rq.2244] Base/tool translation change command (M43620+32m)".
- Refer to base/tool transformation change for details of base/tool transformation change. (☞ Page 100 Base/Tool Transformation Change Function)

## [Cd.2164 to 2169] Base/tool translation setting (X to C) (D52902+32m to D52913+32m)

- This register stores the setting value of position type (POSE) when the value of base transformation/tool transformation changes.

Coordinate	Setting range*1
X	-2147483648 to 2147483647( $\times 10^{-1}$ [ $\mu\text{m}$ ])
Y	
Z	
A	-35999999 to 35999999( $\times 10^{-5}$ [degree])
B	
C	

\*1 The setting range differs by machine type. Refer to the instruction manual of the machine library for details.

- The base/tool transformation setting is the value stored in "[Cd.2164] to [Cd.2169] Base/tool translation setting (X to C) (D52902+32m to D52913+32m)" at the leading edge (OFF→ON) of "[Rq.2244] Base/tool translation change command (M43620+32m)".
- Refer to base/tool transformation change for details of base/tool transformation change. (☞ Page 100 Base/Tool Transformation Change Function)

# Machine monitor device

Device No.		Signal name
MELSEC iQ-R Motion device assignment	Q series Motion compatible device assignment	
D53168 to D53295		Machine 1 machine monitor device
D53296 to D53423		Machine 2 machine monitor device
D53424 to D53551		Machine 3 machine monitor device
D53552 to D53679		Machine 4 machine monitor device
D53680 to D53807		Machine 5 machine monitor device
D53808 to D53935		Machine 6 machine monitor device
D53936 to D54063		Machine 7 machine monitor device
D54064 to D54191		Machine 8 machine monitor device

• Details for each machine

Device No.		Symbol	Signal name	Refresh cycle	Fetch cycle	Signal type	
MELSEC iQ-R Motion device assignment	Q series Motion compatible device assignment						
D53168+128m		Md.2020	Machine type	At power ON	—	Monitor device	
D53169+128m		Md.2021	Machine operating range type	Immediate			
D53170+128m		Md.2022	Machine error code				
D53171+128m		Md.2023	Machine warning code				
D53172+128m		Md.2024	Machine axes configuration	At power ON			
D53173+128m							
D53174+128m							
D53175+128m							
D53176+128m		Md.2025	Feed current value (world coordinate system)	X			Operation cycle
D53177+128m		Md.2026		Y			
D53178+128m				Md.2027	Z		
D53179+128m		Md.2028			A		
D53180+128m					Md.2029	B	
D53181+128m				Md.2030		C	
D53182+128m					Md.2031	FL1	
D53183+128m							
D53184+128m							
D53185+128m							
D53186+128m							
D53187+128m							
D53188+128m							
D53189+128m		—	Unusable	—	—	—	
D53190+128m		Md.2033	Feed current value (joint coordinate system)	J1	Operation cycle	Monitor device	
D53191+128m		Md.2034		J2			
D53192+128m				Md.2035			J3
D53193+128m		Md.2036					J4
D53194+128m							Md.2037
D53195+128m		Md.2038		J6			
D53196+128m							
D53197+128m							
D53198+128m							
D53199+128m							
D53200+128m							
D53201+128m							

Device No.		Symbol	Signal name		Refresh cycle	Fetch cycle	Signal type
MELSEC iQ-R Motion device assignment	Q series Motion compatible device assignment						
D53202+128m		Md.2039	Command coordinate value (world coordinate system)	X	Operation cycle	—	Monitor device
D53203+128m							
D53204+128m		Md.2040		Y			
D53205+128m							
D53206+128m		Md.2041		Z			
D53207+128m							
D53208+128m		Md.2042		A			
D53209+128m							
D53210+128m		Md.2043		B			
D53211+128m							
D53212+128m		Md.2044		C			
D53213+128m							
D53214+128m		Md.2045		FL1			
D53215+128m		—	Unusable		—	—	—
D53216+128m		Md.2047	Command coordinate value (joint coordinate system)	J1	Operating cycle	—	Monitor device
D53217+128m							
D53218+128m		Md.2048		J2			
D53219+128m							
D53220+128m		Md.2049		J3			
D53221+128m							
D53222+128m		Md.2050		J4			
D53223+128m							
D53224+128m		Md.2051		J5			
D53225+128m							
D53226+128m		Md.2052		J6			
D53227+128m							
D53228+128m		Md.2053		Feed current value (base coordinate system)			
D53229+128m							
D53230+128m		Md.2054	Y				
D53231+128m							
D53232+128m		Md.2055	Z				
D53233+128m							
D53234+128m		Md.2056	A				
D53235+128m							
D53236+128m		Md.2057	B				
D53237+128m							
D53238+128m		Md.2058	C				
D53239+128m							
D53240+128m		Md.2059	FL1				
D53241+128m		—	Unusable		—	—	—



Device No.		Symbol	Signal name		Refresh cycle	Fetch cycle	Signal type
MELSEC iQ-R Motion device assignment	Q series Motion compatible device assignment						
D53242+128m		Md.2061	Base translation	X	Operation cycle	—	Monitor device
D53243+128m							
D53244+128m		Md.2062		Y			
D53245+128m							
D53246+128m		Md.2063		Z			
D53247+128m							
D53248+128m		Md.2064		A			
D53249+128m							
D53250+128m		Md.2065		B			
D53251+128m							
D53252+128m		Md.2066		C			
D53253+128m							
D53254+128m		—	Unusable		—	—	—
D53255+128m							
D53256+128m		Md.2069	Tool translation	X	Operation cycle	—	Monitor device
D53257+128m							
D53258+128m		Md.2070		Y			
D53259+128m							
D53260+128m		Md.2071	Z				
D53261+128m							
D53262+128m		—	Unusable		—	—	—
D53263+128m							
D53264+128m							
D53265+128m							
D53266+128m							
D53267+128m							
D53268+128m							
D53269+128m							
D53270+128m		Md.2077	Machine execute program No.		At start	—	Monitor device
D53271+128m		Md.2078	Machine execute point No.		Operation cycle		
D53272+128m		Md.2079	Positioning point block No.				
D53273+128m		Md.2080	Machine M-code				
D53274+128m		Md.2081	Arrival rate				
D53275+128m		—	Unusable		—	—	—
D53276+128m		Md.2083	Machine program operation target speed		Operation cycle	—	Monitor device
D53277+128m							
D53278+128m		Md.2084	Real current value (world coordinate system)	X			
D53279+128m							
D53280+128m		Md.2085		Y			
D53281+128m							
D53282+128m		Md.2086		Z			
D53283+128m							
D53284+128m		Md.2087		A			
D53285+128m							
D53286+128m		Md.2088		B			
D53287+128m							
D53288+128m		Md.2089		C			
D53289+128m							
D53290+128m		Md.2090		FL1			

Device No.		Symbol	Signal name	Refresh cycle	Fetch cycle	Signal type
MELSEC iQ-R Motion device assignment	Q series Motion compatible device assignment					
D53291+128m		—	Unusable	—	—	—
D53292+128m						
D53293+128m						
D53294+128m						
D53295+128m						

### [Md.2020] Machine type (D53168+128m)

The machine type set in [Motion Control Parameter] ⇒ [Machine Control Parameter] ⇒ [Machine Parameter] ⇒ "Machine Type" is stored.

When the machine type setting is incorrect, or has not been set, "0" is stored.

Monitor value	Details
0	No machine setting
1 to 100	Machine type

### [Md.2021] Machine operating range type (D53169+128m)

The operating range type set in [Motion Control Parameter] ⇒ [Machine Control Parameter] ⇒ [Machine Parameter] ⇒ "Operating Range Type" is stored.

### [Md.2022] Machine error code (D53170+128m)

- This register stores the corresponding error code at the machine error occurrence. If another error occurs after error code storing, the previous error code is overwritten by the new error code.
- Machine error codes can be cleared by "[Rq.2240] Machine error reset command (R: M43616+32m)" or "Error reset (SM50)".

#### Point

Refer to the following for details of the error codes.

 MELSEC iQ-R Motion Controller Programming Manual (Common)

### [Md.2023] Machine warning code (D53171+128m)

- This register stores the corresponding warning code at the machine warning occurrence. If another warning occurs after warning code storing, the previous warning code is overwritten by the new warning code.
- Machine warning codes can be cleared by "[Rq.2240] Machine error reset command (R: M43616+32m)" or "Error reset (SM50)".

#### Point

Refer to the following for details of the warning codes.

 MELSEC iQ-R Motion Controller Programming Manual (Common)

## [Md.2024] Machine axes configuration (D53172+128m to D53175+128m)

The machine configuration axes sets in [Motion Control Parameter] ⇒ [Machine Parameter] ⇒ "Joint Axis JNT1" to "Joint Axis JNT6" are stored.

When the machine type setting is incorrect, or has not been set, "0" is stored.

[Md.2024] Machine axes configuration	D53172+128m	b15	b14	b13	b12	b11	b10	b9	b8	b7	b6	b5	b4	b3	b2	b1	b0
		Axis 16	Axis 15	Axis 14	Axis 13	Axis 12	Axis 11	Axis 10	Axis 9	Axis 8	Axis 7	Axis 6	Axis 5	Axis 4	Axis 3	Axis 2	Axis 1
	D53173+128m	Axis 32	Axis 31	Axis 30	Axis 29	Axis 28	Axis 27	Axis 26	Axis 25	Axis 24	Axis 23	Axis 22	Axis 21	Axis 20	Axis 19	Axis 18	Axis 17
	D53174+128m	Axis 48	Axis 47	Axis 46	Axis 45	Axis 44	Axis 43	Axis 42	Axis 41	Axis 40	Axis 39	Axis 38	Axis 37	Axis 36	Axis 35	Axis 34	Axis 33
	D53175+128m	Axis 64	Axis 63	Axis 62	Axis 61	Axis 60	Axis 59	Axis 58	Axis 57	Axis 56	Axis 55	Axis 54	Axis 53	Axis 52	Axis 51	Axis 50	Axis 49

\*1: Machine configuration axes store 0/1.

0: Non-configuration axis

1: Configuration axis

\*2: The following range is valid.

R16MTCPU: Axis No.1 to 16, R32MTCPU: Axis No.1 to 32

## [Md.2025 to 2031] Feed current value (world coordinate system) (X to FL1) (D53176+128m to D53188+128m)

This register stores the target coordinate value output to the servo amplifier on the basis of the positioning end point/ movement amount specified by the machine positioning data of the world coordinate system. When the machine type setting is incorrect, or has not been set, "0" is stored.

Coordinate	Storage value*1
X	-2147483648 to 2147483647( $\times 10^{-1}$ [ $\mu\text{m}$ ])
Y	
Z	
A	-2147483648 to 2147483647( $\times 10^{-5}$ [degree])
B	
C	
FL1	H0000 to HFFFF

\*1 The storage value differs by machine type. Refer to the instruction manual of the machine library for details.



When the feed coordinate value of a joint type machine type is lower than the minimum unit that a joint axis can express an angle, an operation error in the coordinate value may occur. Consequently, the feed coordinate value and command coordinate value may not match even after positioning to the command position is complete.

## [Md.2033 to 2038] Feed current value (joint coordinate system) (J1 to J6) (D53190+128m to D53201+128m)

This register stores the target coordinate value output to the servo amplifier on the basis of the positioning end point/movement amount specified by the machine positioning data of the joint coordinate system. When the machine type setting is incorrect, or has not been set, "0" is stored.

Position component	Storage value <sup>*1*2</sup>
J1	<ul style="list-style-type: none"> <li>• mm: -2147483648 to 2147483647(<math>\times 10^{-1}</math>[<math>\mu\text{m}</math>])</li> <li>• degree: -72000000 to 72000000(<math>\times 10^{-5}</math>[degree])</li> </ul>
J2	
J3	
J4	
J5	
J6	

\*1 The storage value differs by machine type. Refer to the instruction manual of the machine library for details.

\*2 The unit is the unit setting for each joint axis.

### Point

When the feed coordinate value of a joint type machine type is lower than the minimum unit that a joint axis can express an angle, an operation error in the coordinate value may occur. Consequently, the feed coordinate value and command coordinate value may not match even after positioning to the command position is complete.

## [Md.2039 to 2045] Command coordinate value (world coordinate system) (X to FL1) (D53202+128m to D53214+128m)

This register stores the coordinate value of the positioning end point in the machine positioning data of the world coordinate system. When the machine type setting is incorrect, or has not been set, "0" is stored.

Coordinate	Storage value <sup>*1</sup>
X	-2147483648 to 2147483647( $\times 10^{-1}$ [ $\mu\text{m}$ ])
Y	
Z	
A	-2147483648 to 2147483647( $\times 10^{-5}$ [degree])
B	
C	
FL1	H0000 to HFFFF

\*1 The storage value differs by machine type. Refer to the instruction manual of the machine library for details.

## [Md.2047 to 2052] Command coordinate value (joint coordinate system) (J1 to J6) (D53216+128m to D53227+128m)

This register stores the coordinate value of the positioning end point in the machine positioning data of the joint coordinate system. When the machine type setting is incorrect, or has not been set, "0" is stored.

Position component	Storage value <sup>*1*2</sup>
J1	<ul style="list-style-type: none"> <li>• mm: -2147483648 to 2147483647(<math>\times 10^{-1}</math>[<math>\mu\text{m}</math>])</li> <li>• degree: -72000000 to 72000000(<math>\times 10^{-5}</math>[degree])</li> </ul>
J2	
J3	
J4	
J5	
J6	

\*1 The storage value differs by machine type. Refer to the instruction manual of the machine library for details.

\*2 The unit is the unit setting for each joint axis.

### [Md.2053 to 2059] Feed current value (base coordinate system) (X to FL1) (D53228+128m to D53240+128m)

This register stores the target coordinate value output to the servo amplifier on the basis of the positioning end point/movement amount specified by the machine positioning data of the base coordinate system. When the machine type setting is incorrect, or has not been set, "0" is stored.

Coordinate	Storage value*1
X	-2147483648 to 2147483647( $\times 10^{-1}$ [ $\mu\text{m}$ ])
Y	
Z	
A	-2147483648 to 2147483647( $\times 10^{-5}$ [degree])
B	
C	
FL1	
FL1	H0000 to HFFFF

\*1 The storage value differs by machine type. Refer to the instruction manual of the machine library for details.

#### Point

When the feed coordinate value of a joint type machine type is lower than the minimum unit that a joint axis can express an angle, an operation error in the coordinate value may occur. Consequently, the feed coordinate value and command coordinate value may not match even after positioning to the command position is complete.

### [Md.2061 to 2066] Base translation (X to C) (D53242+128m to D53253+128m)

This register stores the value for the shift amount of the base coordinate system in relation to the world coordinate system. When the Multiple CPU system power supply is turned ON the value set in the machine parameter is stored. When "[Rq.2244] Base/tool translation change command (M43620+32m)" is used to set the value, the changed value is stored. When the machine type setting is incorrect, or has not been set, "0" is stored.

### [Md.2069 to 2071] Tool translation (X to Z) (D53256+128m to D53261+128m)

This register stores the value for the shift amount for the control point from the mechanical interface. When the Multiple CPU system power supply is turned ON the value set in the machine parameter is stored. When "[Rq.2244] Base/tool translation change command (M43620+32m)" is used to set the value, the changed value is stored. When the machine type setting is incorrect, or has not been set, "0" is stored.

### [Md.2077] Machine execute program No. (D53270+128m)

- This register stores the applicable program No. when machine program operation is executed.
- In the following cases, the values below are stored.

Item	Monitor value
Power supply turned ON	FF00H
Machine program start request from Motion dedicated PLC instruction (MCNST instruction)	FFE2H
Machine program start request from Motion SFC program (MCNST instruction)	FFE3H
Machine JOG operation	FFE4H

- The execute program No. is also stored in "[Md.1008] Execute program No. (R: D32012+48n/Q: D12+20n)" of the machine configuration axis that is performing interpolation control.
- The value does not change when the machine configuration axis executes any operation other than machine operation.

### [Md.2078] Machine execute point No. (D53271+128m)

- This register stores the point No. being executed during machine program operation.
- The value does not change when machine JOG operation is executed, or when the machine configuration axis executes any operation other than machine operation.

### [Md.2079] Positioning point block No. (D53272+128m)

- This register stores the point block No. being executed during machine program operation.
- The value does not change when machine JOG operation is executed, or when the machine configuration axis executes any operation other than machine operation.

### [Md.2080] Machine M-code (D53273+128m)

- During machine program operation, this register stores the M-code set in the positioning data at positioning start completion and at the start of each point.
- The M-code is also stored in "[Md.25] M-code (R: D32013+48n/Q: D13+20n)" of the machine configuration axis that is performing interpolation control.
- The value does not change when operation arrives at a point where M-code is not set.
- The value does not change when the machine configuration axis executes any operation other than machine operation.
- The value is "0" at the leading edge of "[Rq.1120] PLC ready flag (R: M30000/Q: M2000)".

#### Point

Refer to the following for M-code.

 MELSEC iQ-R Motion Controller Programming Manual (Positioning Control)

### [Md.2081] Arrival rate (D53274+128m)

- This register stores the arrival rate (0 to 100.00[%]) to the end of the movement instruction being executed during machine program operation.
- The arrival rate is calculated with a command value.
- Refer to point arrival notification for operation examples of arrival rate. ( Page 105 Point Arrival Notification)

#### Point

- When proximity pass is enabled, even if "[Md.2081] Arrival rate (D53274+128m)" is less than 100.00[%], when proximity pass is started, "[Md.2081] Arrival rate (D53274+128m)" becomes 100.00[%], and the next positioning operation is started.
- When vibration suppression command filter (acceleration/deceleration process after interpolation) is set, "[Md.2081] Arrival rate (D53274+128m)" becomes 100.00[%] before arriving at the set coordinates because of the delay caused by the filter.
- "[Md.2081] Arrival rate (D53274+128m)" cannot be used in sequential coordinate command control. When positioning with sequential coordinate command control, "[Md.2081] Arrival rate (D53274+128m)" is 100.00[%] until proceeding to the next positioning operation.

## CAUTION

- When a stop factor such as an error occurs during machine program operation, "[Md.2081] Arrival rate (D53274+128m)" is updated according to the command value until the machine configuration axes decelerate to a stop.

### [Md.2083] Machine program operation target speed (D53276+128m, D53277+128m)

- During machine program operation, this register stores the command speed at positioning start completion and at the start of each point.
- The speed after change is stored when command speed does not change at a point midway through operation, or when the speed is changed by the override function.
- The value does not change when machine JOG operation is executed, or when the machine configuration axis executes any operation other than machine operation.

## [Md.2084 to 2090] Real current value (world coordinate system) (X to FL1) (D53278+128m to D53290+128m)

This register stores the coordinate value transformed from the feedback position (pulse units) of the motor encoder of the world coordinate system. When the machine type setting is incorrect, or has not been set, "0" is stored.

Coordinate	Storage value <sup>*1</sup>
X	-2147483648 to 2147483647( $\times 10^{-1}$ [ $\mu\text{m}$ ])
Y	
Z	
A	-2147483648 to 2147483647( $\times 10^{-5}$ [degree])
B	
C	
FL1	H0000 to HFFFF

\*1 The storage value differs by machine type. Refer to the instruction manual of the machine library for details.

### Point

- Values are stored to the real coordinate value monitor device when "[Rq.2200] Real current value monitor enable flag (M43584)" is ON.
- When stopped, "feed coordinate value = real coordinate value".

# 5 MACHINE CONTROL PARAMETERS

This chapter describes the parameters used for machine control.

Refer to the following for R series common parameters, and Motion CPU common parameters.

📖 MELSEC iQ-R Motion Controller Programming Manual (Common)

Refer to the following for Motion control parameters.

📖 MELSEC iQ-R Motion Controller Programming Manual (Positioning Control)

**Point** 🔍

When using machine control, set "Use" in [Motion CPU Common Parameter] ⇒ [Basic Setting] ⇒ "Machine Control Setting". If "Use" is not set machine control cannot be performed.

## 5.1 Machine Common Parameter

The machine common parameters set the point block data used for the positioning control of the machine.

### Point block setting

Assign devices to the point block No. of point block data to be used by the machine program operation.

The size of point block data is 14[word/point block].

🔗 [Motion Control Parameter] ⇒ [Machine Control Parameter] ⇒ [Machine Common Parameter]

#### Window

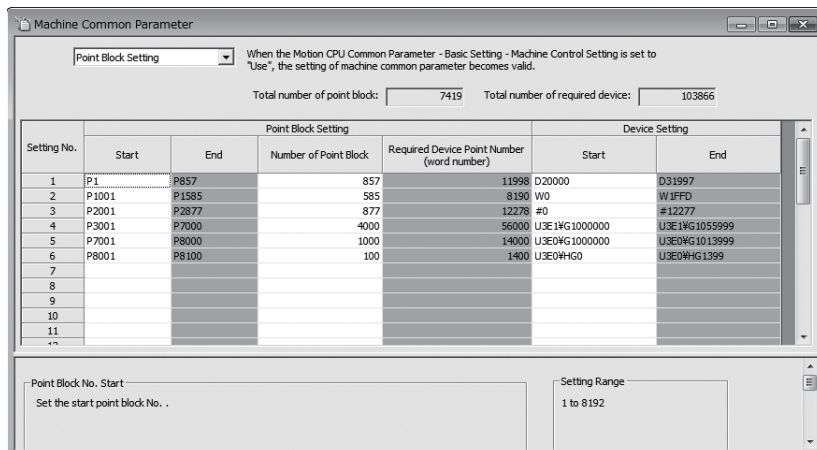

Classification	Item	Description	Setting/display value	Restriction
Display	Setting No.	Indicates the No. for the setting which assigns devices to the point block No.	Setting 1 to Setting 32 (Up to 32)	
User setting	Point block setting	Start	Set the start point block No.	Range: 1 to 8192
		Number of point block	Set the number of point blocks.	Range: 1 to 8192
	Device setting	Start	Set the device to assign to the point block.	Usable devices: D, W, #, U3E□/G, U3E□/HG, U□/G

**Point** 🔍

- When changing the device settings of point block data, enable the changes by turning the Multiple CPU system power supply OFF and ON, or by reset.
- The data of each point block can be retained by a latch setting on the set device. Point block data is retained even if the Multiple CPU system power supply turns OFF→ON, or if a power failure longer than permissible momentary power failure time occurs.



## 5.2 Machine Parameter

The machine parameters set the machine configuration settings for performing machine control, and the parameters used in positioning control of the machine.

 [Motion Control Parameter] ⇒ [Machine Control Parameter] ⇒ [Machine Parameter]

No.	Item	Default value	Setting range	Direct setting <sup>*1</sup>	Indirect setting <sup>*2</sup>		Reference section	
				Valid/invalid	Valid/invalid (Required size)	Fetch cycle		
1	Machine basic setting	Machine type	0	0: No machine 1 to 100: Machine type	○	×	—	Page 49
2		Operating range type	0	0 to 65535	○	×	—	
3	Joint axis structure	Joint axis JNT1	0	0: Unused axis 1 to 64: Axis No.	○	×	—	Page 49
4		Joint axis JNT2	0					
5		Joint axis JNT3	0					
6		Joint axis JNT4	0					
7		Joint axis JNT5	0					
8		Joint axis JNT6	0					
9	Arm length setting	Arm length L1	0( $\times 10^{-1}$ [ $\mu\text{m}$ ])	-1000000000 to 1000000000( $\times 10^{-1}$ [ $\mu\text{m}$ ])	○	×	—	Page 49
10		Arm length L2	0( $\times 10^{-1}$ [ $\mu\text{m}$ ])					
11		Arm length L3	0( $\times 10^{-1}$ [ $\mu\text{m}$ ])					
12		Arm length L4	0( $\times 10^{-1}$ [ $\mu\text{m}$ ])					
13		Arm length L5	0( $\times 10^{-1}$ [ $\mu\text{m}$ ])					
14		Arm length L6	0( $\times 10^{-1}$ [ $\mu\text{m}$ ])					
15	Machine speed setting	Parameter block designation	1	1 to 64	○	×	—	Page 49
16		Machine JOG speed limit value (mm)	1500000 ( $\times 10^{-2}$ [mm/min])	1 to 600000000 ( $\times 10^{-2}$ [mm/min])	○	×	—	
17		Machine JOG speed limit value (degree)	1500000 ( $\times 10^{-3}$ [degree/min])	1 to 2147483647 ( $\times 10^{-3}$ [degree/min])	○	×	—	
18	XYZ stroke limit setting	XYZ stroke limit X coordinate upper limit value	0( $\times 10^{-1}$ [ $\mu\text{m}$ ])	-2147483648 to 2147483647( $\times 10^{-1}$ [ $\mu\text{m}$ ])	○	×	—	Page 50
19		XYZ stroke limit X coordinate lower limit value	0( $\times 10^{-1}$ [ $\mu\text{m}$ ])					
20		XYZ stroke limit Y coordinate upper limit value	0( $\times 10^{-1}$ [ $\mu\text{m}$ ])					
21		XYZ stroke limit Y coordinate lower limit value	0( $\times 10^{-1}$ [ $\mu\text{m}$ ])					
22		XYZ stroke limit Z coordinate upper limit value	0( $\times 10^{-1}$ [ $\mu\text{m}$ ])					
23		XYZ stroke limit Z coordinate lower limit value	0( $\times 10^{-1}$ [ $\mu\text{m}$ ])					

No.	Item	Default value	Setting range	Direct setting <sup>*1</sup>	Indirect setting <sup>*2</sup>		Reference section	
				Valid/invalid	Valid/invalid (Required size)	Fetch cycle		
24	Base transformation (install coordinate offset)	Base transformation X coordinate	0( $\times 10^{-1}$ [ $\mu\text{m}$ ])	-2147483648 to 2147483647( $\times 10^{-1}$ [ $\mu\text{m}$ ])	○	×	—	Page 50
25		Base transformation Y coordinate	0( $\times 10^{-1}$ [ $\mu\text{m}$ ])					
26		Base transformation Z coordinate	0( $\times 10^{-1}$ [ $\mu\text{m}$ ])					
27	Base transformation A rotating axis angle	Base transformation A rotating axis angle	0( $\times 10^{-5}$ [degree])	-35999999 to 35999999 ( $\times 10^{-5}$ [degree])	○	×	—	
28		Base transformation B rotating axis angle	0( $\times 10^{-5}$ [degree])					
29		Base transformation C rotating axis angle	0( $\times 10^{-5}$ [degree])					
30	Tool transformation	Tool transformation X coordinate	0( $\times 10^{-1}$ [ $\mu\text{m}$ ])	-2147483648 to 2147483647( $\times 10^{-1}$ [ $\mu\text{m}$ ])	○	×	—	Page 52
31		Tool transformation Y coordinate	0( $\times 10^{-1}$ [ $\mu\text{m}$ ])					
32		Tool transformation Z coordinate	0( $\times 10^{-1}$ [ $\mu\text{m}$ ])					
33	Option setting A	Option setting A1	H0000000000000000	H0000000000000000 to HFFFFFFFFFFFFFFFF <sup>*3</sup>	○	○ (4 word) <sup>*3</sup>	*3	Page 52
34		Option setting A2	H0000000000000000					
35		Option setting A3	H0000000000000000					
36		Option setting A4	H0000000000000000					
37		Option setting A5	H0000000000000000					
38		Option setting A6	H0000000000000000					
39		Option setting A7	H0000000000000000					
40		Option setting A8	H0000000000000000					
41		Option setting A9	H0000000000000000					
42		Option setting A10	H0000000000000000					
43	Option setting B	Option setting B1	H0000000000000000	H0000000000000000 to HFFFFFFFFFFFFFFFF <sup>*3</sup>	○	○ (4 word) <sup>*3</sup>	*3	Page 52
44		Option setting B2	H0000000000000000					
45		Option setting B3	H0000000000000000					
46		Option setting B4	H0000000000000000					
47		Option setting B5	H0000000000000000					
48		Option setting B6	H0000000000000000					
49		Option setting B7	H0000000000000000					
50		Option setting B8	H0000000000000000					
51		Option setting B9	H0000000000000000					
52		Option setting B10	H0000000000000000					

\*1 For direct setting using MT Developer2, use the decimal format instead of the exponential format.

\*2 Refer to the following for the range of devices used for indirect setting.

MELSEC iQ-R Motion Controller Programming Manual (Common)

\*3 The fetch cycle differs by machine type. Refer to the instruction manual of the machine library for details.

## Machine basic setting

### Machine type

Set the machine type that suits the type of machine to be controlled. When not using a machine, set "0". Refer to the instruction manual of the machine library for details on supported machine types.

### Operating range type

Set the operating range for joint axes.

The setting range differs by machine type. Refer to the instruction manual of the machine library for details.

## Joint axis structure

### Joint axis JNT1 to joint axis JNT6

Set the axis No. that is set in the amplifier setting to each joint axis (JNT1 to JNT6) to suit the machine type to be controlled. Set "0" to axes that are not used. When axis No. is outside of the setting range or duplicated, a moderate error (error code: 30FAH) occurs and the machine does not start. The setting range differs by machine type. Refer to the instruction manual of the machine library for details.

#### Ex.

Allocating axis 3 to JNT1, axis 4 to JNT2, and axis 8 to JNT3

Item	Setting value
Joint axis JNT1	3
Joint axis JNT2	4
Joint axis JNT3	8
Joint axis JNT4	0
Joint axis JNT5	0
Joint axis JNT6	0

## Arm length setting

### Arm length L1 to arm length L6

Set the arm length and arm shift amount for the robot set in the machine type. Set "0" to arm lengths that are not used. When arm lengths are outside of the setting range, a moderate error (error code: 30FAH) occurs and the machine does not start. The setting range differs by machine type. Refer to the instruction manual of the machine library for details.

## Machine speed setting

### Parameter block designation

Set the number of the parameter block to be used in the positioning control of the machine. This setting is used in machine JOG operation and machine program operation. When not setting a parameter block to machine positioning data with the Motion SFC program Motion dedicated function (MCNST) or the Motion dedicated PLC instruction (M(P).MCNST/D(P).MCNST), operation is controlled using the parameter block from this setting. When the interpolation unit of the designated parameter block and the interpolation control unit of the machine do not match, a moderate error (error code: 30FAH) occurs, and the machine does not start. The interpolation control unit differs by machine type. Refer to the instruction manual of the machine library for details.

### Machine JOG speed limit value (mm)

Set the speed limit value for performing machine JOG operation in a "mm" unit coordinate system.

## Machine JOG speed limit value (degree)

Set the speed limit value for performing machine JOG operation in a "degree" unit coordinate system.

## XYZ stroke limit setting

### XYZ stroke limit X to Z coordinate upper/lower limit value

Set the movable range of the control point in the base coordinate system. When not using upper and lower limit values, set "0".

The XYZ stroke limit check is only performed in machine program operation and machine JOG operation. When upper limit  $\leq$  lower limit, or when "[Rq.2243] Machine XYZ stroke limit disable command (M43619+32m)" is turned ON, the XYZ stroke limit check is not performed. When a XYZ stroke limit error is detected, a minor error (error code: 1FE5H) occurs, and operation stops immediately.

#### Ex.

When the setting values of base transformation are the following

X coordinate=800000

Y coordinate=0

Z coordinate=700000

A rotating axis angle=0

B rotating axis angle=0

C rotating axis angle=0

Item	Setting value	World coordinate position
XYZ stroke limit X coordinate upper limit value	2000000( $\times 10^{-1}$ [ $\mu\text{m}$ ])	2800000( $\times 10^{-1}$ [ $\mu\text{m}$ ])
XYZ stroke limit X coordinate lower limit value	-3000000( $\times 10^{-1}$ [ $\mu\text{m}$ ])	-2200000( $\times 10^{-1}$ [ $\mu\text{m}$ ])
XYZ stroke limit Y coordinate upper limit value	0( $\times 10^{-1}$ [ $\mu\text{m}$ ])	0( $\times 10^{-1}$ [ $\mu\text{m}$ ])
XYZ stroke limit Y coordinate lower limit value	0( $\times 10^{-1}$ [ $\mu\text{m}$ ])	0( $\times 10^{-1}$ [ $\mu\text{m}$ ])
XYZ stroke limit Z coordinate upper limit value	2000000( $\times 10^{-1}$ [ $\mu\text{m}$ ])	2700000( $\times 10^{-1}$ [ $\mu\text{m}$ ])
XYZ stroke limit Z coordinate lower limit value	500000( $\times 10^{-1}$ [ $\mu\text{m}$ ])	1200000( $\times 10^{-1}$ [ $\mu\text{m}$ ])

## Base transformation (install coordinate offset)

If the base transformation parameters are set, the base coordinate system can be shifted against the world coordinate system. Base transformation can be set as the default values, but can also be set using "[Rq.2244] Base/tool translation change command (M43620+32m)".

When the base transformation setting is outside of the setting range, a moderate error (error code: 30FAH) occurs and the machine does not start.

The setting range differs by machine type. Refer to the instruction manual of the machine library for details.

### Base transformation X coordinate/Y coordinate/Z coordinate

Set the base position as viewed from the world coordinates at the Multiple CPU system power supply ON, or reset.

## Base transformation A rotating axis angle/B rotating axis angle/C rotating axis angle

Set the rotating axis angle of the base coordinate as viewed from the world coordinates at the Multiple CPU system power supply ON, or reset.

The definition of a coordinate rotating axis angle is shown below. The clockwise rotation of a coordinate axis is the forward direction.

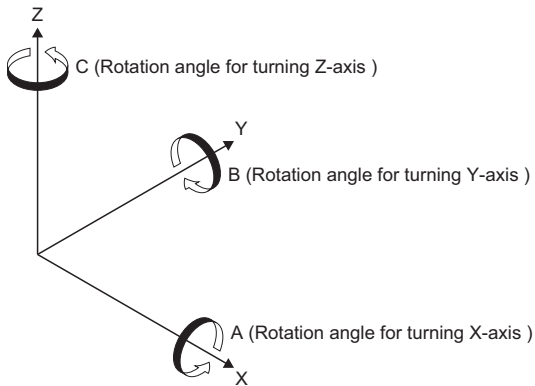

### Setting example

The following example is for when the setting values of base transformation are as follows.

Item	Setting value
Base transformation X coordinate	800000( $\times 10^{-1}$ [ $\mu\text{m}$ ])
Base transformation Y coordinate	700000( $\times 10^{-1}$ [ $\mu\text{m}$ ])
Base transformation Z coordinate	0( $\times 10^{-1}$ [ $\mu\text{m}$ ])
Base transformation A rotating axis angle	0( $\times 10^{-5}$ [degree])
Base transformation B rotating axis angle	0( $\times 10^{-5}$ [degree])
Base transformation C rotating axis angle	9000000( $\times 10^{-5}$ [degree])

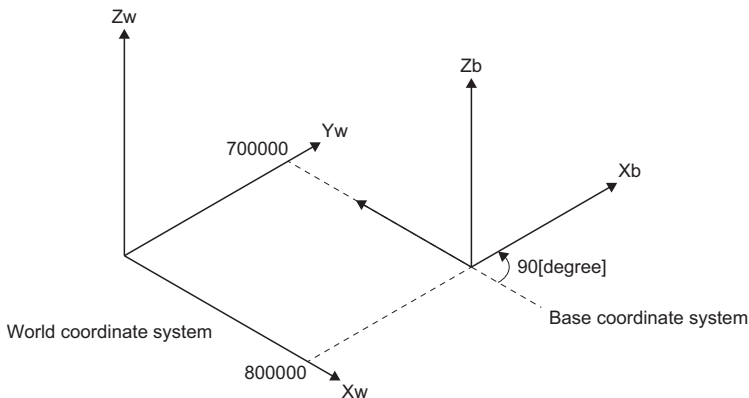

**Point**

If base transformation is set, the base coordinate system can be shifted against the world coordinate system. Because the position of the robot (base coordinate system) does not change, the programs and positions are used as they are and all positioning coordinates (world coordinate system) are shifted together equally. If "X coordinate=10, Y coordinate=20, Z coordinate=30, A rotating axis angle=0, B rotating axis angle=0, C rotating axis angle=0" is set to base transformation, the world coordinates as viewed from the base coordinate system are shifted to "X coordinate=-10, Y coordinate=-20, Z coordinate=-30, A rotating axis angle=0, B rotating axis angle=0, C rotating axis angle=0".

## Tool transformation

---

If the tool transformation parameters are set, the position of the control point as viewed from the mechanical interface can be shifted. Tool transformation can be set as the default values, but can also be set using "[Rq.2244] Base/tool translation change command (M43620+32m)".

When the tool transformation setting is outside of the setting range, a moderate error (error code: 30FAH) occurs and the machine does not start. The setting range differs by machine type. Refer to the instruction manual of the machine library for details.

### Tool transformation X coordinate/Y coordinate/Z coordinate

---

Set the position of the control point as viewed from the mechanical interface at the Multiple CPU system power supply ON, or reset.

## Option setting A

---

This is for setting items for options that are used in each machine type.

The setting range differs by machine type. Refer to the instruction manual of the machine library for details.

## Option setting B

---

This is for setting items for options that are used in each machine type.

The setting range differs by machine type. Refer to the instruction manual of the machine library for details.

## 5.3 Motion Control Parameter of Machine Configuration Axes

### Axis setting parameter

Set the axis setting parameters of axes defined as joint axes in accordance with the instruction manual of the machine library. Refer to the following for details on axis setting parameters.

📖 MELSEC iQ-R Motion Controller Programming Manual (Positioning Control)

#### Point

When "speed control 10 × multiplier setting for degree axis" is enabled, a warning (error code: 0EE1H) occurs at Multiple CPU system power supply ON, or reset. Disable "speed control 10 × multiplier setting for degree axis" for joint axes.

### Fixed parameter

When setting fixed parameters to axes that are set in the joint axis structure of the machine parameter, set the machine configuration axis unit setting to "mm" or "degree".

The moving range (upper/lower stroke limit) that can be set to each axis is -1500000000 to 1500000000[control units].

### Expansion parameter

The servo motor maximum speed check parameter from expansion parameter can be set to axes set in the joint axis structure of machine parameter.

Refer to the following for details of the servo motor maximum speed check parameter.

📖 MELSEC iQ-R Motion Controller Programming Manual (Positioning Control)

The servo motor maximum speed check parameter is used in the following functions.

- Joint interpolation speed limit (📖 Page 98 Joint interpolation speed limit)
- Servo motor maximum speed check (📖 Page 99 Servo motor maximum speed check)



# 6 MACHINE CONTROL DATA

## 6.1 Machine Positioning Data

The machine positioning data area used in machine program operation is shown below.

Offset <sup>*1</sup>	Name	Description	Setting range	Data type	
+0	Number of positioning points	Set the number of positioning points.	<ul style="list-style-type: none"> <li>■When starting with Motion dedicated PLC instruction (M(P).MCNST/ D(P).MCNST) 1 to 128</li> <li>■When starting with Motion dedicated function (MCNST) 1 to 256<sup>2</sup></li> </ul>	16-bit integer (signed)	
+1	Machine No.	Set the control target machine No.	1 to 8	16-bit integer (signed)	
+2	Positioning data items	Positioning data item settings	Set positioning data. Set enable/disable in bit units.	0: Invalid 1: Valid (☞ Page 56 Positioning data item settings)	
+3					
+4		Positioning data item 1	Set the setting values of positioning data in 2 words.	Range of the data items set to "1: Valid" in positioning data item settings (☞ Page 56 Positioning data item settings)	
+5					
⋮					
+34					Positioning data item 16
+35					
+36					Positioning point 1
+37	Coordinate system setting	Set the coordinate system of the positioning point.	0: World coordinate system 1: Base coordinate system 2: Tool coordinate system 3: Joint coordinate system	16-bit integer (signed)	
+38	Command speed	Set the positioning speed.	0: Take speed from previous point 1 to 2147483647: Command speed	32-bit integer (signed)	
+39					
+40	Point block No.	Set the point block No. of the positioning point.	1 to 8192	16-bit integer (signed)	
+41	Auxiliary point/central point block No.	Set the point block No. of the auxiliary point/central point during circular interpolation.	0: Not used 1 to 8192: Point block No.	16-bit integer (signed)	
+42	Unusable	Set to 0.	0	—	
+43					
+44	Expansion point item settings	Set the expansion point data to be used by each positioning point. Set enable/disable in bit units.	0: Invalid 1: Valid (☞ Page 57 Expansion point item settings)	16-bit (bit string)	
+45	Unusable	Set to 0.	0	—	
+46	Expansion point data item 1	Set the setting values of expansion point data in 2 words.	Range of the data items set to "1: Valid" in expansion point data items. (☞ Page 57 Expansion point item settings)	32-bit integer (signed)	
+47					
⋮					
+76					
+77					
⋮	⋮	⋮	⋮	⋮	



Offset*1	Name	Description	Setting range	Data type
+ (42R-6)	Positioning point (R)	Control method	 Page 56 Control method	16-bit integer (signed)
+ (42R-5)		Coordinate system setting	0: World coordinate system 1: Base coordinate system 2: Tool coordinate system 3: Joint coordinate system	16-bit integer (signed)
+ (42R-4)		Command speed	0: Take speed from previous point 1 to 2147483647: Command speed	32-bit integer (signed)
+ (42R-3)				
+ (42R-2)		Point block No.	1 to 8192	16-bit integer (signed)
+ (42R-1)		Auxiliary point/central point block No.	0: Not used 1 to 8192: Point block No.	16-bit integer (signed)
+ (42R)		Unusable	0	—
+ (42R+1)				
+ (42R+2)		Expansion point item settings	0: Invalid 1: Valid (  Page 57 Expansion point item settings)	16-bit (bit string)
+ (42R+3)		Unusable	0	—
+ (42R+4)				
+ (42R+5)		Expansion point data item 1	Range of the data items set to "1: Valid" in expansion point data items. (  Page 57 Expansion point item settings)	32-bit integer (signed)
:		:		
+ (42R+34)		Expansion point data item 16		
+ (42R+35)				

\*1 The "R" of "+(42R+35)" in the machine positioning data area explanation indicate the following items for the offset values.

- R: Positioning point
- Calculate the offset value for each item as follows.
- (Example) When positioning point is "10"
- $+(42R+35)=+(42 \times 10+35)=+455$

\*2 For operating system software version "09" or earlier, 1 to 128.

## Number of positioning points

Set the number of positioning points for performing machine program operation.

Set the following ranges according to the program that starts the machine program.

Machine program operation start	Number of positioning points
Start by Motion dedicated PLC instruction (M(P).MCNST/D(P).MCNST)	1 to 128
Start by the Motion SFC program Motion dedicated function (MCNST)	1 to 256*1

\*1 For operating system software version "09" or earlier, 1 to 128.

## Machine No.

Set the machine No. (1 to 8) for machine program operation.

## Positioning data item settings

- Set the positioning data items used at the execution of the instruction. Turn the bit of the item to be set ON(1: Valid). Items that are turned OFF (0: Invalid) use the data of the parameter block No. set in the machine parameter to start positioning.

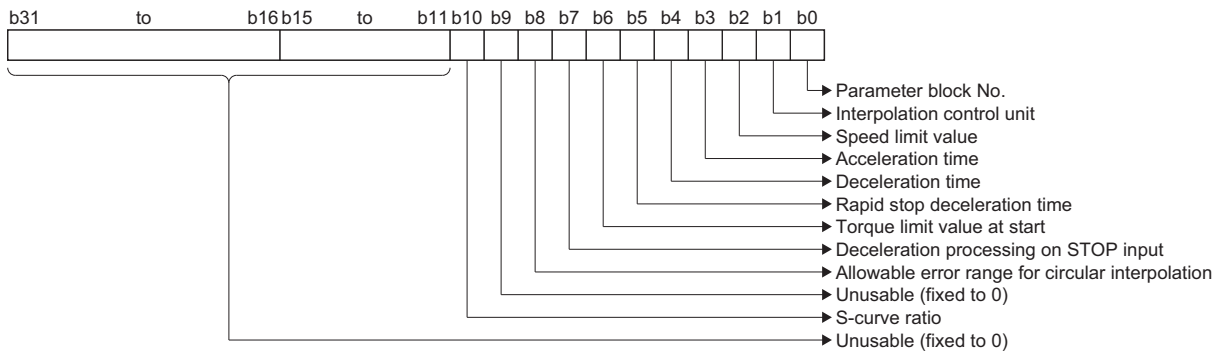

\*: Positioning data items setting value is 0 or 1.  
 • 0: Not possible  
 • 1: Possible

- The data set to ON(1: Valid) is loaded in order from "Positioning data item 1" to "Positioning data item 16". For positioning data items in "Positioning data item 1" to "Positioning data item 16" that are not used, set "0". Positioning data items use 2 words per item.
- Refer to the following for the contents of positioning data items.

MELSEC iQ-R Motion Controller Programming Manual (Positioning Control)

## Control method

Set the control method at the positioning point.

Control method		Instruction symbol	Control	Setting value
NOP instruction		NOP	No operation	0000H
3D linear interpolation control		ABS-	Absolute 3D linear interpolation control	0100H
		INC-	Incremental 3D linear interpolation control	0200H
Joint interpolation control		ABS/	Absolute joint interpolation control	1000H
		INC/	Incremental joint interpolation control	1100H
3D circular interpolation control	Auxiliary point-specified	ABS ↺	Absolute auxiliary point-specified 3D circular interpolation control	2000H
		INC ↺	Incremental auxiliary point-specified 3D circular interpolation control	2100H
	Central point-specified	ABS ↻	Absolute central point-specified 3D circular interpolation control ( $\theta < 180^\circ$ )	3000H
		INC ↻	Incremental central point-specified 3D circular interpolation control ( $\theta < 180^\circ$ )	3100H
		ABS ↻	Absolute central point-specified 3D circular interpolation control ( $\theta > 180^\circ$ )	3200H
		INC ↻	Incremental central point-specified 3D circular interpolation control ( $\theta > 180^\circ$ )	3300H
Sequential coordinate command control		—	Positioning with the sequentially changed coordinate values as the target position.	5000H

## Coordinate system setting

Set the coordinate system of the point blocks at each positioning point.

## Command speed

Set the command speed at each positioning point. The unit of the set command speed is matched with the unit of interpolation control for the machine to be controlled. When command speed is set to "0" from positioning point 2 onwards, the command speed set in the previous positioning point is taken for the command speed. However, when the previous positioning points are NOP instructions or sequential coordinate command control only, a minor error (error code: 1FE0H) occurs.

## Point block No.

Set the point block No. used in the positioning point. Refer to point block setting for details on point block No. setting.

( Page 46 Point block setting)

Refer to point block data for details on point block data. ( Page 62 Point Block Data)

## Auxiliary point/central point block No.

Set the point block No. to be used at the auxiliary point/central point of 3D circular interpolation control (auxiliary point-specified, central point-specified). For control other than 3D circular interpolation control (auxiliary point-specified, central point-specified), set "0".

## Expansion point item settings

- Set the expansion point data items to be used in each positioning point. Turn the bit of the item to be set ON(1: Valid).

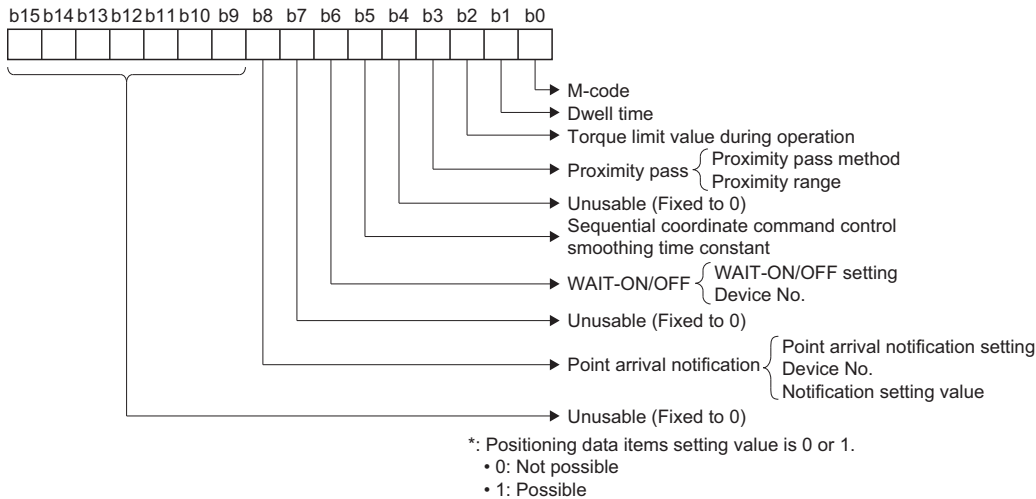

- The data set to ON(1: Valid) is loaded in order from "Expansion point data item 1" to "Expansion point data item 16". For expansion point data items in "Positioning data item 1" to "Positioning data item 16" that are not used, set "0". Expansion point data items use 2 words per item.

### ■M-code

Refer to the following for the contents of data set in M-code.

📖 MELSEC iQ-R Motion Controller Programming Manual (Positioning Control)

## ■Dwell time

The operation when dwell time is set is shown below. Refer to the following for the contents of data set in dwell time.

📖MELSEC iQ-R Motion Controller Programming Manual (Positioning Control)

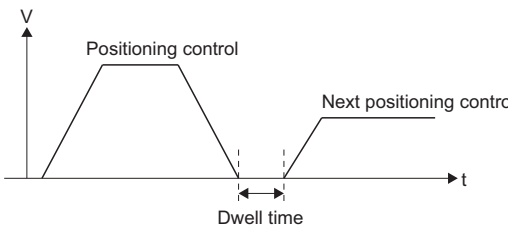
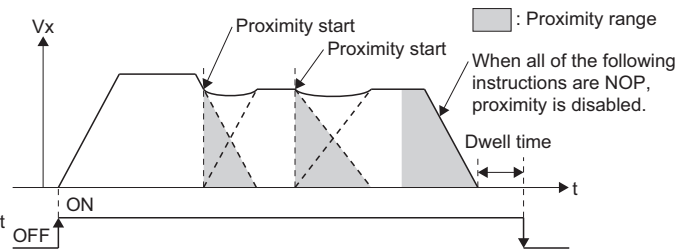
Item	Operation
When dwell time is set the end point	Positioning is completed after waiting for the set time to elapse. (After dwell time has elapsed, "[St.1040] Start accept flag (R: M30080+n/Q: M2001+n)" and "[St.2127] Machine start accept flag (M43911+32m)" turn OFF, and "[St.1061] Positioning complete (R: M32401+32n/Q: M2401+20n)" turns ON.)
When dwell time is set to a point midway through operation	<ul style="list-style-type: none"> <li>• Wait until the set time has elapsed.</li> <li>• When the set dwell time has elapsed, the next positioning control starts.</li> </ul> 
When proximity pass is set	<ul style="list-style-type: none"> <li>• Dwell time is ignored even if set.</li> <li>• Proximity pass is disabled at the end point, and wait until set time has elapsed.</li> </ul> <p>(Example) In the case below, positioning point 4 and positioning point 5 contain NOP instructions therefore positioning point 3 is the end point, and from there proximity pass becomes invalid, and dwell time becomes valid.</p> <div style="display: flex; align-items: center;"> <div style="flex: 1;"> <pre> START     Positioning point 1   Control method=Linear interpolation   Proximity pass is set     Positioning point 2   Control method=Linear interpolation   Proximity pass is set   Dwell time=set     Positioning point 3   Control method=Circular interpolation   Proximity pass is set   Dwell time=set     Positioning point 4   Control method=NOP     Positioning point 5   Control method=NOP   END                     </pre> </div> <div style="flex: 1;"> <ul style="list-style-type: none"> <li>• Because of proximity passing, dwell time is ignored.</li> <li>• When all of the following instructions are NOP, proximity pass is invalid.</li> <li>• After dwell time has elapsed, "[St.2127] Machine start accept flag (M43911+32m)" turns OFF.</li> </ul> </div> </div> 

## ■Torque limit value during operation

Refer to the following for the contents of data set in torque limit value during operation.

📖MELSEC iQ-R Motion Controller Programming Manual (Positioning Control)

## ■Proximity pass

Proximity pass uses two expansion point data items (proximity pass method and proximity range). Refer to proximity pass function for details of proximity pass. (👉 Page 90 Proximity Pass Function)

Proximity pass method	Proximity range
0: Invalid	0
1: JOINT remaining distance method (end point distance)	0 to 2147483647[interpolation control units]

### Sequential coordinate command control smoothing time constant

The sequential coordinate command control smoothing time constant sets the averaged time when changing position command during sequential coordinate command control. However, a delay equivalent to the set time constant in [ms] occurs. The time constant can only be used for sequential coordinate command control. The setting is ignored for controls other than sequential coordinate command control.

If the sequential coordinate command control smoothing time constant is not set when performing sequential coordinate command control, the smoothing time constant is "0[ms]". When a value outside of the setting range is set, a warning (error code: 0EE0H) occurs, and the smoothing time constant is "0[ms]". Refer to sequential coordinate command control for details on sequential coordinate command control. (☞ Page 80 Sequential coordinate command control)

Item	Setting value
Sequential coordinate command control smoothing time constant	0 to 5000[ms]

### WAIT-ON/OFF

WAIT-ON/OFF uses two expansion point data items (WAIT-ON/OFF setting and device No.). Refer to WAIT-ON/OFF for details of WAIT-ON/OFF. (☞ Page 103 WAIT-ON/OFF)

• WAIT-ON/OFF setting (first expansion point data item)

Select the condition to be used (WAIT-ON or WAIT-OFF), and set the type of device that is allocated, bit specification of the word device, and the unit No.

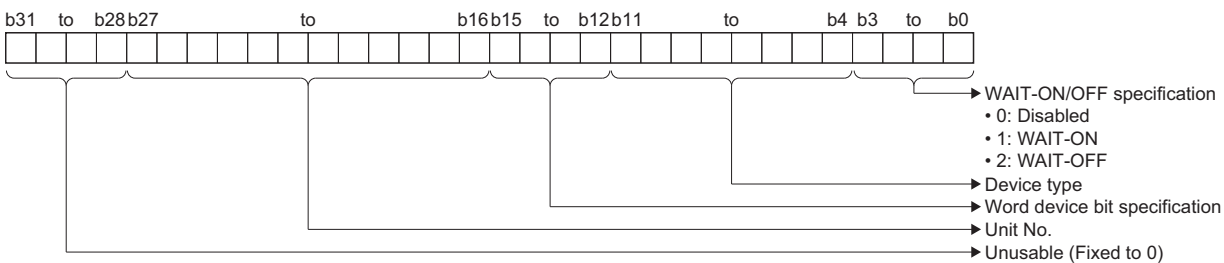

• Device No. (second expansion point data item)

Set the No. of the device allocated to WAIT-ON/OFF.

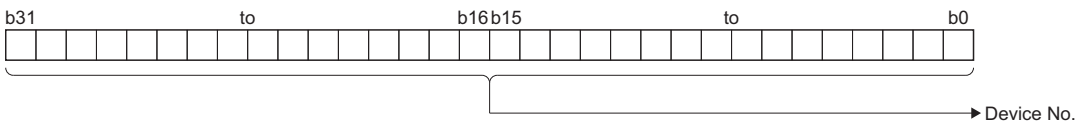

Device type		Word device bit specification	Unit No.	Device No.
Value	Device name			
01H	Input (X)	—	—	0 to 12287
02H	Output (Y)			0 to 12287
03H	Internal relay (M)			0 to 49151 <sup>*1</sup>
04H	Link relay (B)			0 to 8191 <sup>*1</sup>
05H	Annunciator (F)			0 to 2047 <sup>*1</sup>
06H	Data register (D)	0H to FH	—	0 to 57343 <sup>*1</sup>
07H	Link register (W)			0 to 8191 <sup>*1</sup>
08H	Motion register (#)			0 to 12287 <sup>*1</sup>
09H	Special relay (SM)	—	—	0 to 4095
0AH	Special register (SD)			0H to FH
0BH	CPU buffer memory access device	—	3E0H to 3E3H(U3E0\G to U3E3\G)	0 to 2097151 <sup>*2</sup>
0CH	CPU buffer memory access device (fixed scan communication area)		3E0H to 3E3H(U3E0\HG to U3E3\HG)	0 to 12287
0DH	Module access device	—	000H to 0FFH(U0\G to UFF\G)	0 to 268435455 <sup>*3</sup>

\*1 By changing the number of points used for each device with the device points/latch setting, the device Nos. can be expanded. Refer to the following for device points/latch setting.

☞ MELSEC iQ-R Motion Controller Programming Manual (Common)

\*2 The maximum number of points that a CPU buffer memory access device can use varies with the CPU module.

\*3 The accessible range varies with the module. Refer to the manual of the module being used.

- When WAIT-ON/OFF is set to "0: Disabled", WAIT-ON/OFF is disabled.
- When the value of the WAIT-ON/OFF specification is outside of range, a minor error (error code: 1FE0H (details code: 003EH)) occurs, and operation does not start.
- When a device outside of the setting range is set, a minor error (error code: 1FE0H (details code: 003FH)) occurs, and operation does not start.

### Point arrival notification

Point arrival notification uses three expansion point data items (point arrival notification setting, device No., and notification setting value). Refer to point arrival notification for details of point arrival notification. (Page 105 Point Arrival Notification)

- Point arrival notification setting (first expansion point data item)

Select the notification method (device ON/OFF), and set the type of notification device, bit specification of the word device, and the unit No.

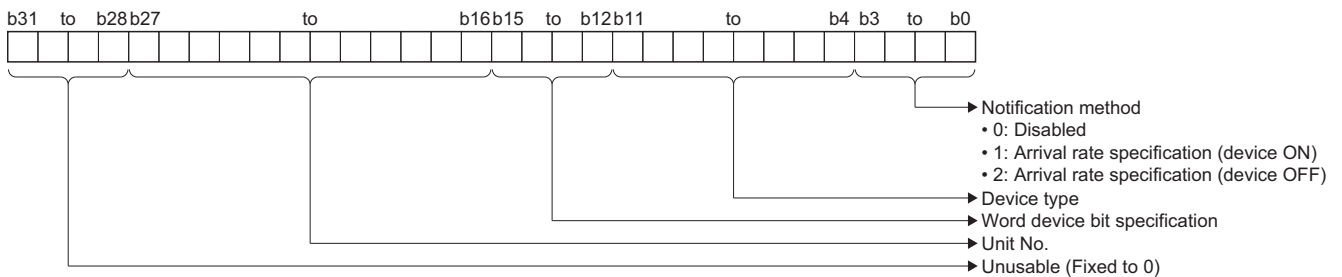

- Device No. (second expansion point data item)

Set the No. of the device for notification.

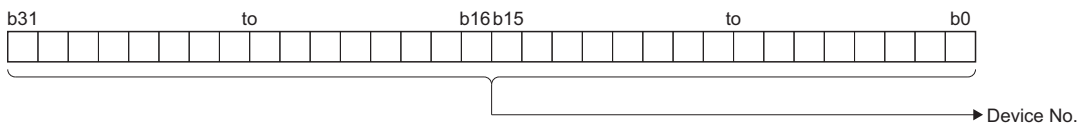

Device type		Word device bit specification	Unit No.	Device No.	
Value	Device name				
01H	Input (X)	—	—	0 to 12287	
02H	Output (Y)			0 to 12287	
03H	Internal relay (M)			0 to 49151 <sup>*1</sup>	
04H	Link relay (B)			0 to 8191 <sup>*1</sup>	
05H	Annunciator (F)			0 to 2047 <sup>*1</sup>	
06H	Data register (D)	0H to FH	—	0 to 57343 <sup>*1</sup>	
07H	Link register (W)			0 to 8191 <sup>*1</sup>	
08H	Motion register (#)			0 to 12287 <sup>*1</sup>	
09H	Special relay (SM)	—	—	0 to 4095	
0AH	Special register (SD)			0H to FH	0 to 4095
0BH	CPU buffer memory access device			3E0H to 3E3H(U3E0\G to U3E3\G) <sup>*2</sup>	0 to 2097151 <sup>*3</sup>
0CH	CPU buffer memory access device (fixed scan communication area)			3E0H to 3E3H(U3E0\HG to U3E3\HG) <sup>*2</sup>	0 to 12287
0DH	Module access device	—	000H to 0FFH(U0\G to UFF\G)	0 to 268435455 <sup>*4</sup>	

\*1 By changing the number of points used for each device with the device points/latch setting, the device Nos. can be expanded. Refer to the following for device points/latch setting.

MELSEC iQ-R Motion Controller Programming Manual (Common)

\*2 Only the unit No. of the self-CPU can be set. When the unit No. of other CPUs are set, a minor error (error code: 1FE0H (details code: 0041H)) occurs.

\*3 The maximum number of points that a CPU buffer memory access device can use varies with the CPU module.

\*4 The accessible range varies with the module. Refer to the manual of the module being used.

- Notification setting value (third expansion point data item)

Set the value for turning ON/OFF the notification device.

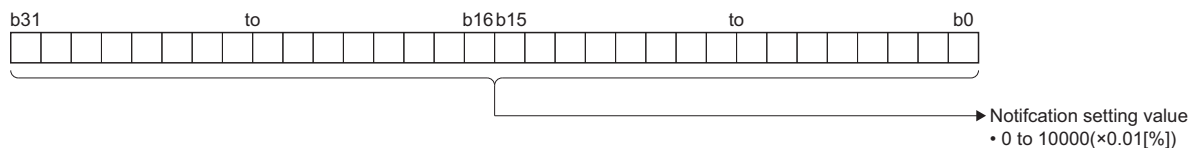

**Point** 

- When notification method is set to "0: Disabled", point arrival notification is disabled.
- When the notification method or notification setting value are set outside of the setting range, a minor error (error code: 1FE0H (details code: 0040H)) occurs, and operation does not start.
- When the device type, bit specification of word device, unit No. or device No. are outside of the setting range, a minor error (error code: 1FE0H (details code: 0041H)) occurs, and operation does not start.

## 6.2 Point Block Data

Set the point block data to be used by machine program operation.

When setting point block data, set the devices to be allocated to the point block No. by selecting [Motion Control Parameter]

⇒ [Machine Control Parameter] ⇒ [Machine Common Parameter] ⇒ "Point Block Setting".

Refer to point block setting for details of point block setting. (  Page 46 Point block setting)

### Structure of point block data

The point block data structure is shown below.

The size of each point block data is 14[words/point blocks].

#### Point block

##### ■Position type (POSE)

Offset	Point block No.	Item	Description	Data type	Setting range			
+0	P(k)	X	Position (distance) to move in the X direction	32-bit integer (signed)	-2147483648 to 2147483647( $\times 10^{-1}$ [ $\mu\text{m}$ ])			
+1		Y				Position (distance) to move in the Y direction		
+2								
+3		Z	Position (distance) to move in the Z direction					
+4								
+5		A	Angle to rotate the A coordinate			16-bit integer (Unsigned)	H0000 to HFFFF	
+6								
+7								
+8								
+9		B	Angle to rotate the B coordinate					
+10								
+11		C	Angle to rotate the C coordinate					
+12								
+13	FL1	Structure flag 1	—	0				
:	:	:	:	:	:			
+14(v-1)	P(k+v-1)	X	The point blocks set in "Number of point blocks" are valid.	32-bit integer (signed)	-2147483648 to 2147483647( $\times 10^{-1}$ [ $\mu\text{m}$ ])			
+14(v-1)+1		Y						
+14(v-1)+2								
+14(v-1)+3		Z						
+14(v-1)+4								
+14(v-1)+5		A					16-bit integer (Unsigned)	H0000 to HFFFF
+14(v-1)+6								
+14(v-1)+7								
+14(v-1)+8								
+14(v-1)+9		B						
+14(v-1)+10								
+14(v-1)+11		C						
+14(v-1)+12								
+14(v-1)+13		FL1			—	0		

\*1 The "k" and "v" of "P(k+v-1)" and "+14(v-1)+13" in the point block explanation indicate the following items for the offset values.

- k: Start point block No.
- v: Number of point blocks

Calculate the offset value for each item as follows.

(Example) When start point block No. is "100", and number of point blocks is "200"

P(k+v-1)=P(100+200-1)=P299 (Point block No.)

+14(v-1)+13)=+14(200-1)+13)=+2799 (Offset)



## ■ Joint type (JOINT)

Offset	Point block No.	Item	Description	Data type	Setting range	
+0	Pk	J1	Position (distance) for moving JNT1	32-bit integer (signed)	mm: -2147483648 to 2147483647( $\times 10^{-1}$ [ $\mu\text{m}$ ]) degree: -72000000 to 72000000( $\times 10^{-5}$ [degree])	
+1						
+2		J2	Position (distance) for moving JNT2			
+3						
+4		J3	Position (distance) for moving JNT3			
+5						
+6		J4	Position (distance) for moving JNT4			
+7						
+8		J5	Position (distance) for moving JNT5			
+9						
+10		J6	Position (distance) for moving JNT6			
+11						
+12		—	Unusable			—
+13						
⋮	⋮	⋮	⋮	⋮	⋮	
+14(v-1)	P(k+v-1)	J1	The point blocks set in "Number of point blocks" are valid.	32-bit integer (signed)	mm: -2147483648 to 2147483647( $\times 10^{-1}$ [ $\mu\text{m}$ ]) degree: -72000000 to 72000000( $\times 10^{-5}$ [degree])	
+(14(v-1)+1)						
+(14(v-1)+2)		J2				
+(14(v-1)+3)						
+(14(v-1)+4)		J3				
+(14(v-1)+5)						
+(14(v-1)+6)		J4				
+(14(v-1)+7)						
+(14(v-1)+8)		J5				
+(14(v-1)+9)						
+(14(v-1)+10)		J6				
+(14(v-1)+11)						
+(14(v-1)+12)		—				
+(14(v-1)+13)						

\*1 The "k" and "v" of "P(k+v-1)" and "+14(v-1)+13" in the point block explanation indicate the following items for the offset values.

- k: Start point block No.
- v: Number of point blocks

Calculate the offset value for each item as follows.

(Example) When start point block No. is "100", and number of point blocks is "200"

$P(k+v-1)=P(100+200-1)=P299$  (Point block No.)

$+14(v-1)+13=+14(200-1)+13=+2799$  (Offset)

## Point block data setting

A setting example for point block data is shown below.

### ■Setting data to X and Y of P201

- Point block setting

Item	Point block No.	
	P201	
	Device	Setting value
X	D22800, D22801	1000000( $\times 10^{-1}$ [ $\mu\text{m}$ ])
Y	D22802, D22803	1500000( $\times 10^{-1}$ [ $\mu\text{m}$ ])
Z	D22804, D22805	0
A	D22806, D22807	0
B	D22808, D22809	0
C	D22810, D22811	0
FL1	D22812	0
—	D22813	0

- Motion SFC program

[F11] 

```
//Set point block P201
FMOV D22800,K0,K14 //Point block P201 (14 words) 0 clear
D22800L=K1000000 //Point block data (X)
D22802L=K1500000 //Point block data (Y)
```

### ■Setting data to P1 to P3

- Point block setting

Item	Point block No.					
	P1		P2		P3	
	Device	Setting value	Device	Setting value	Device	Setting value
X	D20000, D20001	0	D20014, D20015	1000000( $\times 10^{-1}$ [ $\mu\text{m}$ ])	D20028, D20029	1000000( $\times 10^{-1}$ [ $\mu\text{m}$ ])
Y	D20002, D20003	0	D20016, D20017	0	D20030, D20031	0
Z	D20004, D20005	0	D20018, D20019	0	D20032, D20033	0
A	D20006, D20007	0	D20020, D20021	0	D20034, D20035	0
B	D20008, D20009	0	D20022, D20023	0	D20036, D20037	0
C	D20010, D20011	0	D20024, D20025	0	D20038, D20039	3000000( $\times 10^{-5}$ [degree])
FL1	D20012	0	D20026	0	D20040	0
—	D20013	0	D20027	0	D20041	0

- Motion SFC program

[F12] 

```
//Set point block P1 to P3
FMOV D20000,K0,K14 //0 clear P1 (14 words)
FMOV D20014,K0,K14 //0 clear P2 (14 words)
D20014L=K1000000 //Set (X)
FMOV D20028,K0,K14 //0 clear P3 (14 words)
D20028L=K1000000 //Set (X)
D20038L=K3000000 //Set (C)
```

# 7 POSITIONING CONTROL

This chapter explains the positioning methods.

## 7.1 Basics of Positioning Control

This section describes the common items for positioning control (machine control), which is described in detail after Section 7.2. (☞ Page 75 Machine Program Operation)

### Positioning speed

The positioning speed is set using machine positioning data.

Refer to machine positioning data for details of the machine positioning data. (☞ Page 54 Machine Positioning Data)

The real positioning speed is set in the positioning speed and speed limit value using the machine positioning data shown below:

- If the positioning speed setting is less than speed limit value, the positioning is executed with the set positioning speed.
- If the positioning speed setting is greater than speed limit value, the positioning is executed with the speed limit value.

**Ex.**

(Example 1) If the speed limit value is 120000 [mm/min] and the positioning speed setting is 100000 [mm/min]

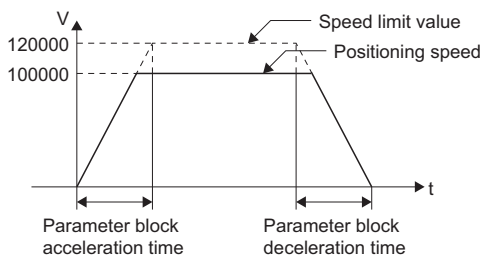

(Example 2) If the speed limit value is 100000 [mm/min] and the positioning speed setting is 120000 [mm/min]

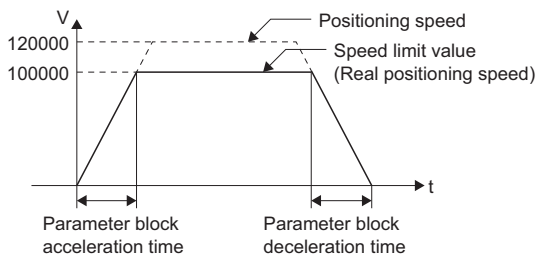

## Positioning speed at the interpolation control

The positioning speed of the Motion CPU sets the movement speed of the control system.

In machine control, the unit for the positioning speed is determined by the interpolation control unit of the parameter block specified in the machine parameter.

### When there is movement amount in the XYZ space

The specified positioning speed is the composite speed on the XYZ space. The speed of A, B, and C coordinates is determined so that they operate in the movement time for that speed.

$$\text{Positioning speed } \vec{V} = \vec{V}_X + \vec{V}_Y + \vec{V}_Z$$

Linear interpolation control of the X and Y axes is as follows.

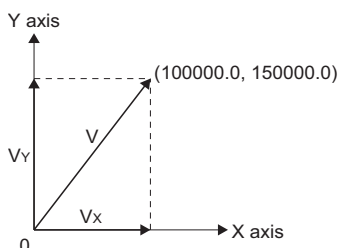

Setting item	Setting value
Movement amount of the X axis (D <sub>1</sub> )	100000.0[μm]
Movement amount of the Y axis (D <sub>2</sub> )	150000.0[μm]
Composite speed (V)	42000.00[mm/min]

For the above conditions, the Motion CPU calculates the positioning speed of each axis with the following formulas.

Setting axis	Formula
Positioning speed of the X axis	$V_X = V \times D_1 / \sqrt{D_1^2 + D_2^2}$
Positioning speed of the Y axis	$V_Y = V \times D_2 / \sqrt{D_1^2 + D_2^2}$

#### Point

In the case of using the machine library when there is no movement amount of the XYZABC coordinate axes and only changing the attitude flag (FL1), use the servo instruction for linear interpolation control (ABS-2 to ABS-4(Absolute method)).

### CAUTION

- Because the composite speed is calculated in the XYZ space, when the movement amount is minute on the XYZ space and large on the rotating coordinate axes, the rotating coordinate axes movement speed can be excessive. To avoid excessive speeds, set a maximum speed on the joint axes with the servo motor maximum speed check parameter.

### When there is no movement amount in the XYZ space

The specified positioning speed[mm/min] unit is converted from the units of the A, B, and C coordinates. The positioning speed is converted to [degree/min] by the formula below.

$$\text{Positioning speed[degree/min]} = (\text{specified positioning speed}) \times 0.1$$

#### Ex.

When the machine type interpolation control unit is [mm]

When 30.00[mm/min] is set to positioning speed and the A coordinate is operated, it operates at 3.000[degree/min].

## Speed at joint interpolation

The movement time of each joint axis is determined by the specified positioning speed. (The same movement time as linear interpolation)

The speed of each moving joint axis is determined so that they operate in that movement time.

For articulated robots, the speed of the control point is not fixed.

## Program example

### ■ Program for machine 1 linear interpolation to positioning point P201 at command speed 42000.00[mm/min]

- Point block

Setting item	P201
X	100000.0[μm]
Y	150000.0[μm]
Z	0
A	0
B	0
C	0
FL1	0

- Machine positioning data

Setting item	Device	Number of words
Number of positioning points	D2000	1
Machine No.	D2001	1
Positioning data item settings	D2002 to D2035	34
Positioning point 1	D2036 to D2077	42

- Workpiece for positioning point settings

Setting item	Device	Number of words
Workpiece for positioning point settings	#0 to #41	42

- Motion SFC program

```
[F 11]
// Set machine positioning data 1
// Number of points, Machine No.
D2000=K1 // Number of positioning points(1)
D2001=K1 // Machine No.
```

```
[F 12]
// Set machine positioning data 2
// Positioning data items
D2002L=K0 // Positioning data items setting (all disabled)
FMOV D2004,K0,K32 // Positioning data items (32 words)
                (Not use(0))
```

```
[F 13]
// Set data of positioning point 1
#0=H0100 // Control method (linear interpolation (ABS))
#1=K0 // Positioning point setting (World coordinate system
        setting)
#2L=K4200000 // Command speed=42000.00[mm/min]
#4=K201 // Point block No.(P201)
#5=K0 // auxiliary/central point block data (Not use (0))
#6L=K0 // Radius (Not use(0))
#8=K0 // Expansion point item setting (all disabled)
#9=K0 // Empty area (0)
FMOV #10,K0,K32 // Expansion point item setting value
                (32 words)(Not use(0))
BMOV D2036,#0,K42 // Batch-transfer 42 words from #0 to
                positioning point 1.
```

## ■ Moving machine 1 to positioning points P1 to P3 at command speed 1800.00[mm/min]

When only moving degree unit coordinate axes when the interpolation control unit of positioning point 3 is mm.

Positioning point	Point block No.	Operation
1	P1	Move to P1(start point)
2	P2	Move to P2 (move X coordinate only)
3	P3	Move to P3 (move B coordinate only)

### • Machine

Machine type=R5(3 rotating axes, world coordinate system(XZB+FL1))

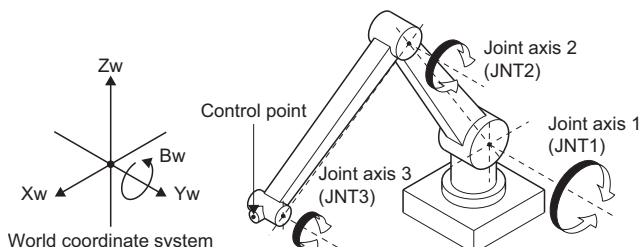

### • Point block

Setting item	P1	P2	P3
X	1000000.0[μm]	1500000.0[μm]	15000000.0[μm]
Y	0	0	0
Z	500000.0[μm]	500000.0[μm]	500000.0[μm]
A	0	0	0
B	90.00000[degree]	90.00000[degree]	140.00000[degree]
C	0	0	0
FL1	0	0	0
FL2	0	0	0

### • Machine positioning data

Setting item	Device	Number of words
Number of positioning points	D2000	1
Machine No.	D2001	1
Positioning data item settings	D2002 to D2035	34
Positioning point 1	D2036 to D2077	42
Positioning point 2	D2078 to D2119	42
Positioning point 3	D2120 to D2161	42

### • Workpiece for positioning point settings

Setting items	Device	Number of words
Workpiece for positioning point settings	#0 to #41	42

• Motion SFC program

```
[F 21]
// Set machine positioning data 1
// Number of points, Machine No.
D2000=K3 // Number of positioning points (3)
D2001=K1 // Machine No.
```

```
[F 22]
// Set machine positioning data 2
// Positioning data items
D2002L=K0 // Positioning data items setting (all disabled)
FMOV D2004,K0,K32 // Positioning data items (32 words)
(Not use(0))
```

```
[F 23]
// Set data of positioning point 1
// Move to start point
FMOV #0,K0,K42 // Point data area (42 words) 0 clear
#0=H0100 // Control method (linear interpolation(ABS))
#1=K0 // Positioning point setting (World coordinate system
setting)
#2L=K180000 // Command speed=1800.00[mm/min]
#4=K1 // Point block No. (P1)
BMOV D2036,#0,K42 // Batch-transfer 42 words from #0 to
positioning point 1.
```

```
[F 24]
// Set data of positioning point 2
// Move X axis only
// X axis positioning speed=1800.00[mm/min]
FMOV #0,K0,K42 // Point data area (42 words) 0 clear
#0=H0100 // Control method (linear interpolation(ABS))
#1=K0 // Positioning point setting (World coordinate system
setting)
// #2L=K0 // Command speed=0 (Take previous command
speed)
#4=K2 // Point block No. (P2)
BMOV D2078,#0,K42 // Batch-transfer 42 words from #0 to
positioning point 2.
```

```
[F 25]
// Set data of positioning point 2
// Move C axis only
// C axis positioning speed=180.000[degree/min]
FMOV #0,K0,K42 // Point data area (42 words) 0 clear
#0=H0100 // Control method (linear interpolation(ABS))
#1=K0 // Positioning point setting (World coordinate system
setting)
#2L=K180000 // Command speed=180.000[degree/min]
#4=K3 // Point block No. (P3)
BMOV D2120,#0,K42 // Batch-transfer 42 words from #0 to
positioning point 2.
```

# Interpolation operation and acceleration/deceleration processing

This section explains interpolation operation processing.

## Flowchart of interpolation operation and acceleration/deceleration processing

Machine interpolation operation and acceleration/deceleration are processed as follows.

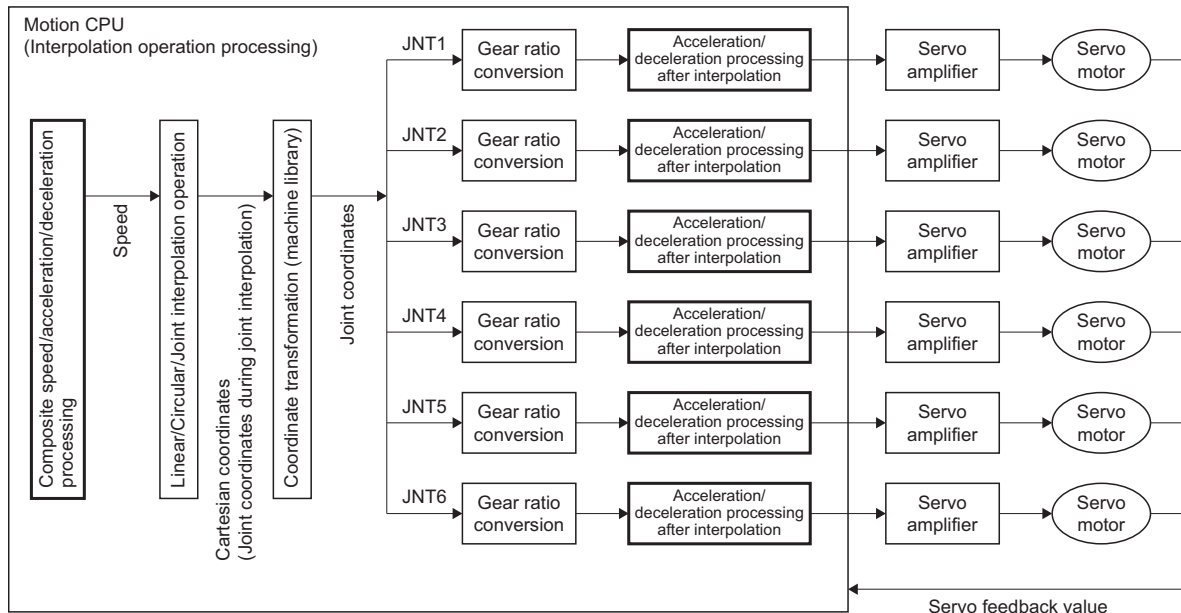

## Composite speed and acceleration/deceleration processing

Acceleration/deceleration is performed according to the composite speed.

The following two methods are available for acceleration/deceleration processing.

### ■Trapezoidal acceleration/deceleration processing

A conventional processing method performing linear rapid acceleration and rapid stops.

### ■S-curve acceleration/deceleration processing

By setting the S-curve ratio as a parameter, acceleration/deceleration is processed in a smoother manner compared to trapezoidal acceleration/deceleration processing.

Acceleration/deceleration time and S-curve ratio settings can be made in the parameter block or in machine positioning data.

#### Point

- Refer to the following for details on trapezoidal acceleration/deceleration processing and S-curve acceleration/deceleration processing.  
 📖 MELSEC iQ-R Motion Controller Programming Manual (Positioning Control)
- In machine control, advanced S-curve acceleration/deceleration cannot be used. When advanced S-curve acceleration/deceleration is set, trapezoidal acceleration/deceleration is processed.



## Acceleration/deceleration after interpolation (speed smoothing filter of each axis)

When smoothing the movement amount to each joint axis after coordinate transformation, set a smoothing filter by vibration suppression command filter. With the vibration suppression command filter, extreme changes in the speed of the joint axes can be managed. When the operation cycle is set to 7.111[ms], the vibration suppression command filter is disabled. Refer to the following for vibration suppression command filter.

📖 MELSEC iQ-R Motion Controller Programming Manual (Positioning Control)

### ■ Setting example

An example for setting a smoothing filter of time constant 125[ms] to joint axes JNT1 to JNT3(axis 3 to 5) is shown below.

- Set the following to "Vibration suppression command filter 1" of vibration suppression command filter data.

Setting item		Setting value		
		Axis 3	Axis 4	Axis 5
Vibration suppression filter 1	Mode selection device	#10000	#10000	#10000
	Frequency	8.00[Hz]	8.00[Hz]	8.00[Hz]
	Depth	0: -40dB	0: -40dB	0: -40dB

🖱️ [Motion Control Parameter] ⇒ [Axis Setting Parameter] ⇒ "Vibration Suppression Command Filter Data"

### Window

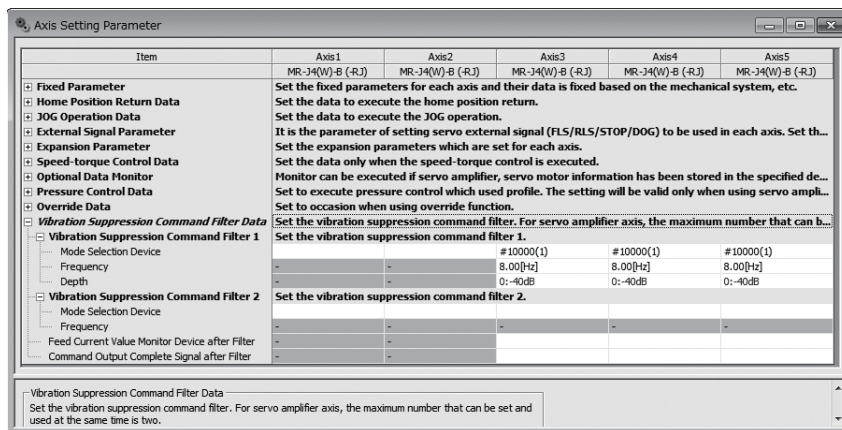

- Before starting machine positioning control, set "1: Smoothing filter" to the value of the device set to "Mode Selection Device".

### Cautions

- For joint robots, because trajectory accuracy deteriorates, use a time constant that is as small as possible.
- If the values set in the smoothing filter of each joint axis are different, the positioning timing of each joint axis becomes inconsistent. Thus, set the same time constant (frequency) to each joint axis of the robot.
- When acceleration/deceleration processing after interpolation is disabled, the time to positioning completion becomes longer due to the delay caused by the filter.
- When errors that cause stops, rapid stops, and immediate stops occur, the time to stop completion becomes longer due to the delay caused by the filter.
- In the maximum speed check, the command speed of joint axes before the acceleration/deceleration processing after interpolation is checked. For this reason, when using acceleration/deceleration processing after interpolation, a minor error (error code: 1FE2H (details code: 0007H)) may occur for command speeds less than the set speed.

## Control units during machine control

The interpolation control unit specified in the parameter block is checked with the interpolation control unit of the machine at the Multiple CPU system power supply ON/reset, and at the start of machine program operation. The interpolation control unit of the parameter block is set according to the specifications of the machine library.

### At the Multiple CPU system power supply ON/Reset

When the interpolation control unit of the parameter block set in [Motion Control Parameter] ⇒ [Machine Control Parameter] ⇒ [Machine Parameter] ⇒ "Machine Speed Setting" ⇒ "Parameter Block Designation" and the interpolation control unit of the machine are different, a moderate error (error code: 30FAH) occurs and the machine does not start.

### At the machine program operation start

When the interpolation control unit of the parameter block and interpolation control unit of the machine set in the machine positioning data are different, a minor error (error code: 1FE0H) occurs and machine program operation does not start.

	Interpolation control unit of parameter block				Starting method
	mm	inch	degree	pulse	
Normal start	Interpolation control units of the machine are [mm].	—	—	—	<ul style="list-style-type: none"> <li>Starts when interpolation control units of the machine and parameter block are the same</li> <li>Units are not converted when the interpolation control units are different.</li> </ul>
Units not matched (Minor error (error code: 1FE0H))	When interpolation control unit of the machine do not match the interpolation control unit of the parameter block.				Does not start when interpolation control units of the machine and parameter block are different.

# Control when control unit is "degree"

This section explains machine control when the control unit (coordinate axis unit) is "degree".

## Machine configuration axes with "degree" control unit

- Refer to the following for details of axes with "degree" control unit.
  - MELSEC iQ-R Motion Controller Programming Manual (Positioning Control)
- Unlimited rotation axes cannot be used for machine configuration axes. Set the upper limit value/lower limit value of the stroke limit and enable the stroke limit.
- The setting range of the upper limit value/lower limit value of the stroke limit differs by machine type. Refer to the instruction manual of the machine library for details of the settings.
- The "[Md.20] Feed current value (R: D32000+48n, D32001+48n/Q: D0+20n, D1+20n)" of each axis monitor device is a ring address of 0 to 360°.

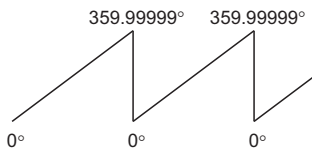

## Joint type (JOINT)

- The value of joint axes can be monitored with "[Md.2033] to [Md.2038] Feed current value (joint coordinate system)(J1 to J6)(D53190+128m to D53201+128m)". When the unit is "degree", the monitor value is a ring address of 0 to 360°.
- When the unit is "degree", the joint type (JOINT) command range is as follows.

Coordinate	Absolute method	Incremental method
J1	0 to 35999999( $\times 10^{-5}$ [degree])	-72000000 to 72000000( $\times 10^{-5}$ [degree])
J2		
J3		
J4		
J5		
J6		

- The setting range, and end point compensation processing in the absolute method (shortcut processing, movement direction compensation for commands outside the stroke limit range etc.) differ by machine type. Refer to the instruction manual of the machine library for details.

## Position type (POSE)

- The value of joint axes can be monitored with "[Md.2025] to [Md.2031] Feed current value (world coordinate system)(X to FL1)(D53176+128m to D53188+128m)", and "[Md.2053] to [Md.2059] Feed current value (base coordinate system)(X to FL1)(D53228+128m to D53240+128m)". When the unit is "degree", the monitor value is a ring address of 0 to 360°.
- When the unit is "degree", the position type (POSE) command range is as follows.

Coordinate	Absolute method	Incremental method
A	0 to 35999999( $\times 10^{-5}$ [degree])	-72000000 to 72000000( $\times 10^{-5}$ [degree])
B		
C		

- The setting range, and end point compensation processing in the absolute method (shortcut processing, movement direction compensation for commands outside the stroke limit range etc.) differ by machine type. Refer to the instruction manual of the machine library for details.

## Stop processing and restarting after stop

---

During machine control, if a stop command (stop cause) occurs in the machine or machine configuration axis, stop processing is performed for the machine.

Refer to the following for details of stop processing when a stop cause occurs during positioning and restarting after a stop.

📖 MELSEC iQ-R Motion Controller Programming Manual (Positioning Control)

## Operation at home position return incomplete

---

When "[St.1069] Home position return request (R: M32409+32n/Q: M2409+20n)" is turned ON, machine program operation or machine JOG operation cannot be started. If machine program operation or machine JOG operation are started with "[St.1069] Home position return request (R: M32409+32n/Q: M2409+20n)" turned ON, a minor error (error code: 1FE2H (details code: 0004H)) occurs. Additionally, the error occurs regardless of the setting in [Motion Control Parameter] ⇒ [Axis Setting Parameter] ⇒ "Home Position Return Data" ⇒ "Operation for HPR Incompletion".

## 7.2 Machine Program Operation

Positioning is performed to a predetermined passing point by the specified positioning method and positioning speed, with one start only. The positioning method and positioning speed can be changed for each pass point.

The positioning method and positioning speed are set with machine positioning data.

Refer to machine positioning data for details of machine positioning data. (  Page 54 Machine Positioning Data)

- Machine program operation repeats acceleration and deceleration for each point. After the completion of command output to the servo amplifier, the next point starts.

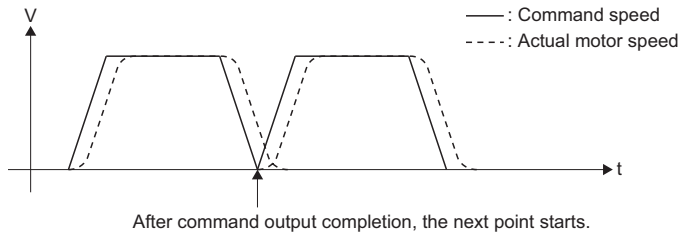

- The connection between points can be controlled smoothly by using the proximity pass function. Refer to proximity pass function for details of proximity pass function. (  Page 90 Proximity Pass Function)

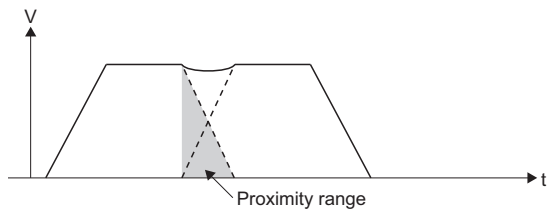

# Linear interpolation/joint interpolation

## Linear interpolation

- Linear interpolation operation performs interpolation control that makes the trajectory from the start point (point of the start of movement) to the end point a straight line.
- The point block data of the positioning point is specified by position type (POSE) of the following coordinate systems. Joint type (JOINT) cannot be specified.
  - World coordinate system
  - Base coordinate system
  - Tool coordinate system

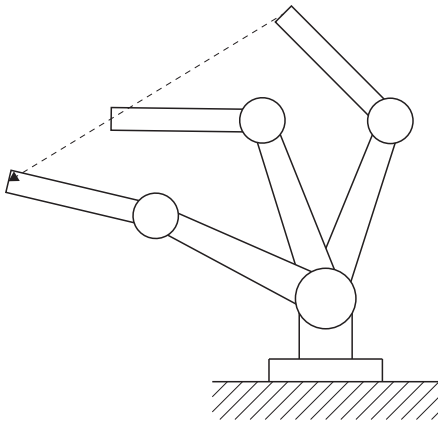

### Point

When specifying the target position in tool coordinate system, the target address is calculated based on the previous point block data.

The tool coordinate system is a coordinate system with the control point as the home position. Therefore, the end point is the same regardless of absolute method specification and incremental method specification.

## Joint interpolation

- Joint interpolation operation performs interpolation control with joints starting movement, and completing movement at the same time from the start point (point of the start of movement) to the end point.
- When moving at high-speeds without considering trajectory, use joint interpolation.
- Point block data of positioning points are specified by position type (POSE), or joint type (JOINT).

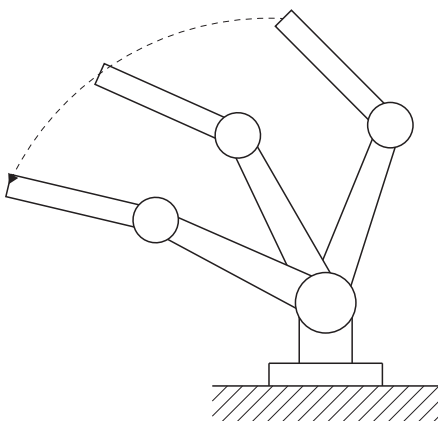

# Circular interpolation

- Circular interpolation operation controls with 3D circular interpolation by auxiliary point specification, and 3D circular interpolation by central point specification.
- Positioning points and auxiliary point/central point of point block data are specified by position type (POSE) of the world coordinate system or base coordinate system. The tool coordinate system and joint type (JOINT) cannot be specified.
- For auxiliary point/central point of point block data, only the coordinate values (X, Y, Z) are valid. Other coordinate values are ignored.
- The maximum arc radius is  $2^{31}-1$ . When an end point, and auxiliary point/central point that requires a radius larger than  $2^{31}-1$  is set, a minor error (error code: 1FE0H) occurs, and circular interpolation is not started. When a minor error (error code: 1FE0H) occurs at a point midway through a machine program operation that is already running, the system comes to a deceleration stop.

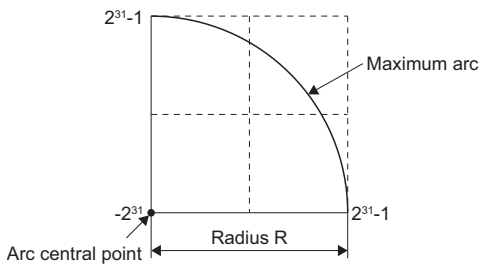

## Circular interpolation (auxiliary point-specified)

3D circular interpolation control by specification of the end point and auxiliary point for circular interpolation is executed. Auxiliary point-specified 3D circular interpolation control uses ABS (absolute data method) and INC (incremental data method).

- An arc is drawn on the plane that the start point, auxiliary point, and end point passes.
- The movement direction is start point→auxiliary point→end point.
- When the start point, auxiliary point, and end point are on a straight line, a minor error (error code: 1FE0H) occurs.
- When end point=auxiliary point, a minor error (error code: 1FE0H) occurs.
- A true circle cannot be drawn.

### ■Control using ABS (Absolute method)

3D circular interpolation control from the current stop position (point before positioning) based on the home position through the specified auxiliary point, and to the end point is executed. The center of the arc is the point of intersection of the perpendicular bisectors of the start point (current stop position) to the auxiliary point, and the auxiliary point to the end point.

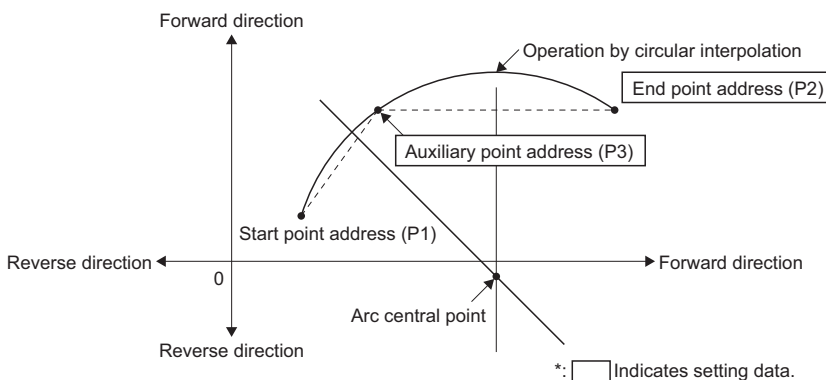

## ■Control using INC ↺ (Incremental method)

3D circular interpolation control from the current stop position through the specified auxiliary point, and to the end point is executed. The center of the arc is the point of intersection of the perpendicular bisectors of the start point (current stop point) and the auxiliary point, and the auxiliary point to the end point.

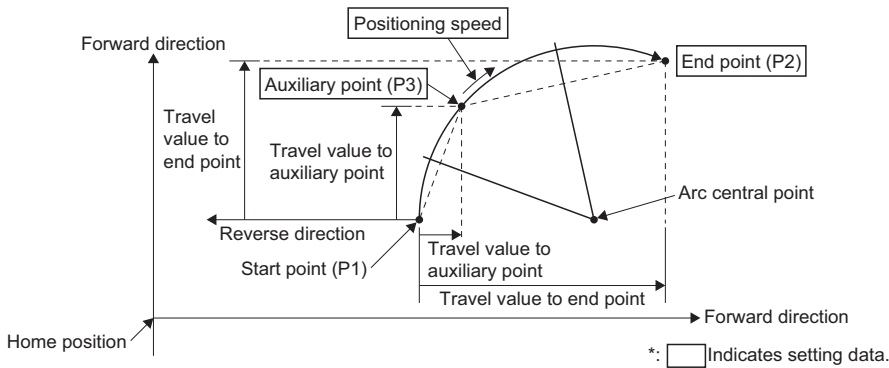

## Circular interpolation (central point-specified)

3D circular interpolation control by specification of the end point for circular interpolation and an arc central point is executed. Central point-specified circular interpolation control uses the following control methods.

Instruction	Maximum controllable angle of arc	Positioning path
ABS ↺	$0^\circ < \theta < 180^\circ$	
INC ↺		
ABS ↻	$180^\circ < \theta < 360^\circ$	
INC ↻		

- An arc is drawn on the plane that the start point, central point, and end point passes.
- When the start point, central point, and end point are on a straight line, a minor error (error code: 1FE0H) occurs.
- When end point=central point, a minor error (error code: 1FE0H) occurs.
- A true circle, and an arc with an arc angle of  $180^\circ$  cannot be drawn.
- The trajectory of the arc calculated from the start point and central point, and the position of the set end point can differ. The allowable range for errors is set in the allowable error range for circular interpolation of the parameter block. When the error is within the allowable range, circular interpolation to the set end point address is executed while also executing error compensation by means of spiral interpolation. When it exceeds the setting range, a minor error (error code: 1FE0H) occurs.



### ■Control using ABS, ABS (Absolute method)

3D circular interpolation of an arc with a radius equivalent to the distance between the start point and central point, between the current stop position (point before positioning) based on the home position and the specified end point.

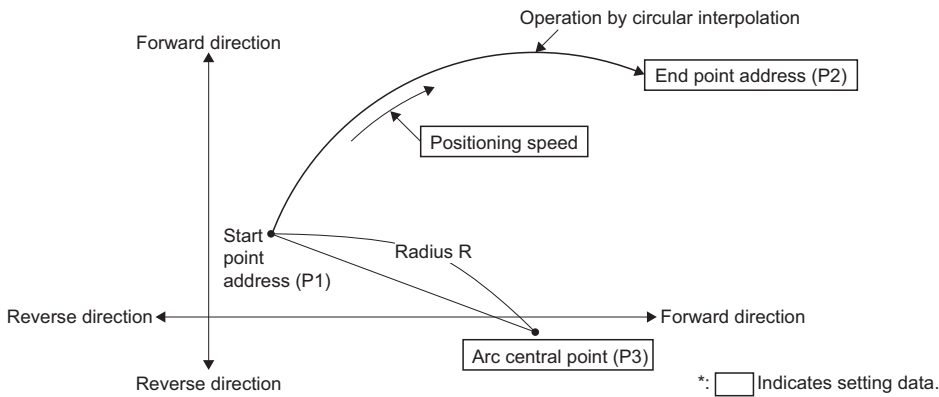

### ■Control using INC, INC (Incremental method)

3D circular interpolation from the current stop point with a radius equivalent to the distance between the start point and central point.

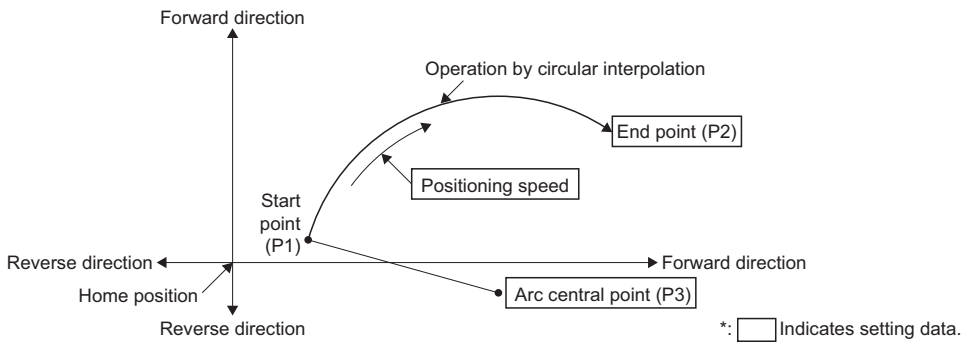

# Sequential coordinate command control

Sequential coordinate command control performs positioning by making the coordinate values specified in the point block No. as the target position, and outputting the command for the movement amount from the current position in one operation cycle. From the start of the sequential coordinate command control positioning point until the leading edge (OFF→ON) of "[Rq.2247] Execute point switching command (M43623+32m)" the operation is in a follow-up state, and if any values of the word devices assigned to a point block No. are changed during this time, the successively changed coordinate values are made the target position for positioning. The command speed is ignored even if set to a positioning point. From the leading edge (OFF→ON) of "[Rq.2247] Execute point switching command (M43623+32m)", the execute point is switched after moving from the current position to the target position.

By setting the sequential coordinate command control smoothing time constant, a moving average filter for the command to the target position can smoothen the command. However, a delay equivalent to the set time constant in [ms] occurs.

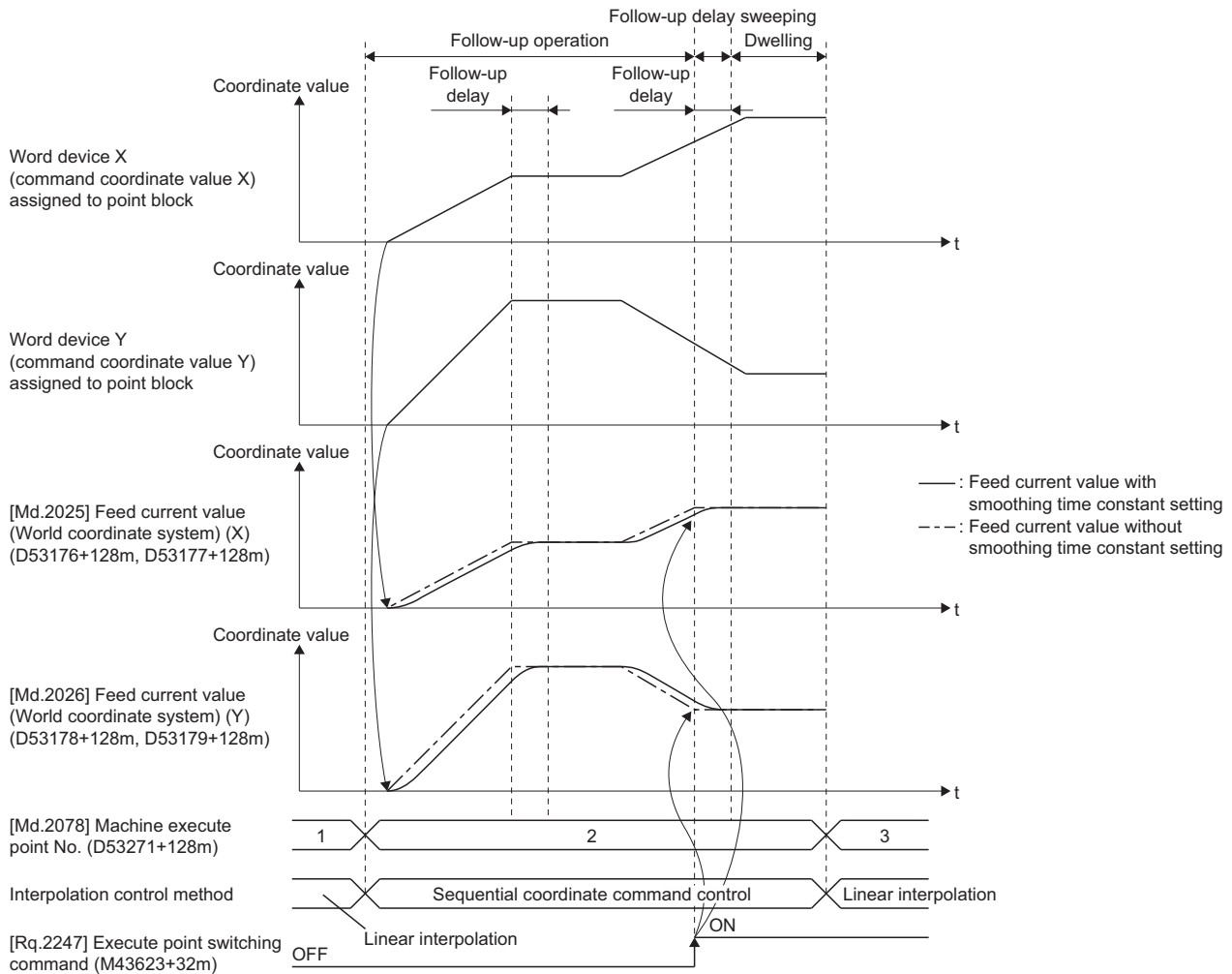

## Cautions

- When starting, preset the position data for the start of sequential coordinate command control by SFC program in the sequential coordinate command control point block data. If a position away from the position before start is set, the motor may operate suddenly when starting the execute point.
- In sequential coordinate command control, the following parameters are not used. However, if the setting values of the positioning data items are abnormal, a warning (error code: 0EE0H) occurs.
  - Speed limit value
  - Acceleration time
  - Deceleration time
  - Rapid stop deceleration time
  - S-curve ratio
  - Deceleration processing on STOP input
- Positioning points are specified by position type (POSE) data of the world coordinate system or base coordinate system. They cannot be specified by the tool coordinate system and joint type (JOINT) data.
- In sequential coordinate command control, the attitude flag (FL1) cannot perform a switching operation. If a switching setting is made, a minor error (error code: 1FE1H) occurs. Perform the switching operation of attitude flag with joint interpolation.
- In the execute points before sequential coordinate command control, and the execute points for sequential coordinate command control, the proximity pass function is disabled regardless of the settings.
- The control methods available to use following the execute points for sequential coordinate command control are absolute method linear interpolation (excluding the tool coordinate system) and sequential coordinate command control only. When a control method other than the usable control methods is set, a minor error (error code: 1FE0H) occurs.
- During sequential coordinate command control, when a stop factor occurs, the command is stopped.
- During sequential coordinate command control, if the movement amount for each coordinate exceeds the range of 32-bit integer (signed) data type, a minor error (error code: 1FE0H) occurs.

## Setting data

When executing sequential coordinate command control, the data set to positioning points are as follows.

Refer to machine positioning data for details of positioning points. (☞ Page 54 Machine Positioning Data)

Offset	Name	Setting value	Remarks
+ (0)	Control method	5000H	
+ (1)	Coordinate system specification	0: World coordinate system 1: Base coordinate system	"2: Tool coordinate system" and "3: Joint coordinate system" cannot be used.
+ (2)	Command speed	—	Not used. When set, the setting value is ignored.
+ (3)			
+ (4)	Point block No.	1 to 8192	
+ (5)	Auxiliary point/central point block No.	—	Not used. When set, the setting value is ignored.
+ (6)	Unusable	0	Set 0.
+ (7)			
+ (8)	Expansion point setting items	b0: M-code b1: Dwell time b2: Torque limit value during operation b5: Sequential coordinate command control smoothing time constant	"b3: Proximity pass" cannot be used. When set, it is ignored.
+ (9)	Unusable	0	Set 0.
+ (10)	Expansion point setting item 1	The range of data items which are set to "1: Valid" in expansion point data items.	
+ (11)			
⋮			
+ (40)	Expansion point setting item 16		
+ (41)			

## Program example

The program for following the synchronous encoder axis current value per cycle of synchronous encoder axis 1 is explained as an example.

Point	Positioning operation	M-code	
1	P1→P2	Positioning (linear interpolation (ABS)) from start point (P1) to follow-up starting position (P2)	10
2	P2→P3(End)	Follow-up processing (sequential coordinate command) with synchronous encoder axis 1 position (P3)	20
3	P3(End)→(P4)	Positioning (linear interpolation (ABS)) from follow-up end position (P3) to the standby position (P4)	30
4	P4→P1	Positioning (joint interpolation (ABS)) from the standby position (P4) to start point (P1)	40

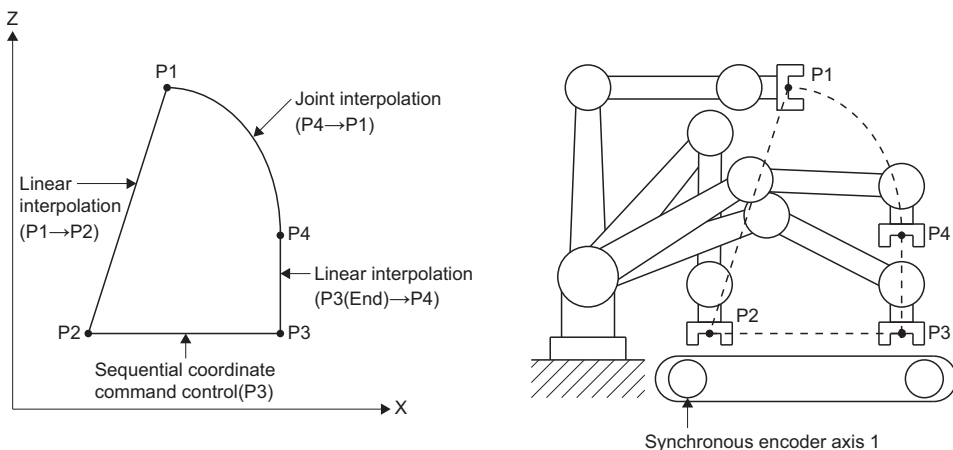

## Operation timing

The operation timing of sequential coordinate command control is shown in the figure below.

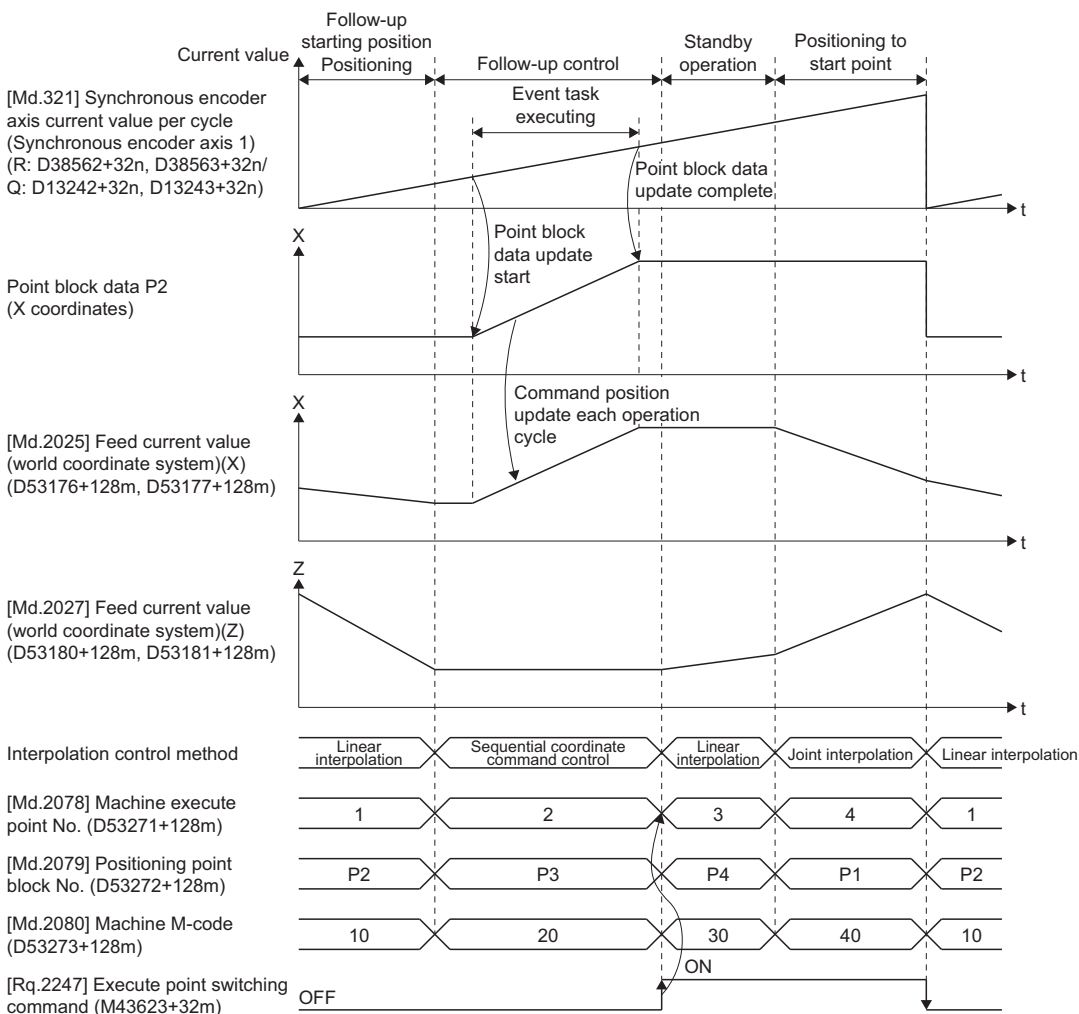

## Program example

- Program for machine program operation start (task type: Normal task)

ProgStart

```
[F1]
//Set point block data
FMOV #6000,K0,K64 //Clear point block P1 to P4
//P1(start point) setting
#6000L=1000000L //P1.X coordinate=100000.0[μm]
#6004L=2000000L //P1.Z coordinate=200000.0[μm]
//P2(follow-up starting position) setting
#6014L=800000L //P2.X coordinate=80000.0[μm]
#6018L=500000L //P2.Z coordinate=50000.0[μm]
//P3(position during follow-up control) setting
(preset starting position)
#6028L=800000L //P3.X coordinate=80000.0[μm]
#6032L=500000L //P3.Z coordinate=50000.0[μm]
//P4(standby position) setting
#6042L=2000000L //P4.X coordinate=200000.0[μm]
#6046L=700000L //P4.Z coordinate=70000.0[μm]
```

```
[F2]
//Set positioning data
FMOV #0,K0,K36 //Clear positioning data (work area)
#0=K4 //Set positioning points number of points
#1=K1 //Set target machine No.
#2=H0000 //Disable all positioning data item settings
BMOV D20000,#0,K36 //Transfer positioning data
//Set positioning point 1
FMOV #0,K0,K42 //Clear positioning point data (work area)
#0=H0100 //Control method: 3D linear interpolation
control(ABS)
#1=K0 //Coordinate system specification: World
coordinate system
#2L=K200000L //Command speed: 2000.00mm/min
#4=K2 //Positioning point block P2
#8=H0001 //Expansion point setting items b0: M-code
enabled
#10L=K10L //Expansion point data item 1(M-code)10
BMOV D20036,#0,K42 //Transfer positioning point 1
//Set positioning point 2
FMOV #0,K0,K42 //Clear positioning point data (work area)
#0=H5000 //Control method: Sequential coordinate
command control
#1=K0 //Coordinate system specification: World
coordinate system
#4=K3 //Positioning point block P3
#8=H0001 //Expansion point setting items b0: M-code
enabled
#10L=K20L //Expansion point data item 1(M-code)20
BMOV D20078,#0,K42 //Transfer positioning point 2
//Set positioning point 3
FMOV #0,K0,K42 //Clear positioning point data (work area)
#0=H0100 //Control method: Linear interpolation
control(ABS)
#1=K0 //Coordinate system specification: World
coordinate system
#2L=K200000L //Command speed: 2000.00mm/min
#4=K4 //Positioning point block P4
#8=H0001 //Expansion point setting items b0: M-code
enabled
#10L=K30L //Expansion point data item 1(M-code)30
BMOV D20120,#0,K42 //Transfer positioning point 3
//Set positioning point 4
FMOV #0,K0,K42 //Clear positioning point data (work area)
#0=H1000 //Control method: Joint interpolation
control(ABS)
#1=K0 //Coordinate system specification: World
coordinate system
#2L=K200000L //Command speed: 2000.00mm/min
#4=K1 //Positioning point block P1
#8=H0001 //Expansion point setting items b0: M-code
enabled
#10L=K40L //Expansion point data item 1(M-code)40
BMOV D20162,#0,K42 //Transfer positioning point 4
```

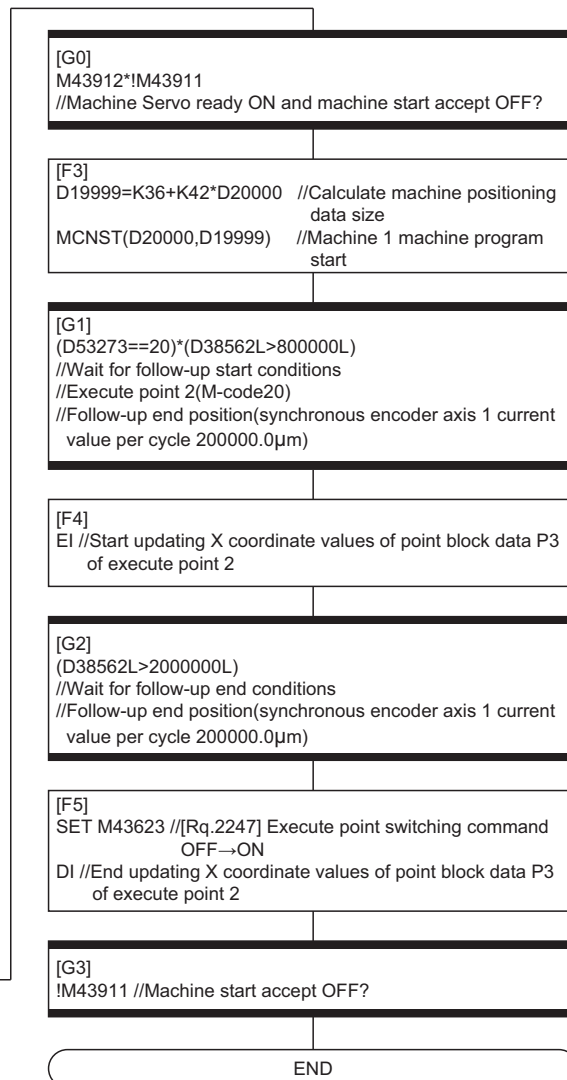

- Program for point block data update (task type: Event task (fixed-cycle: 0.444ms), number of consecutive transitions: 1)

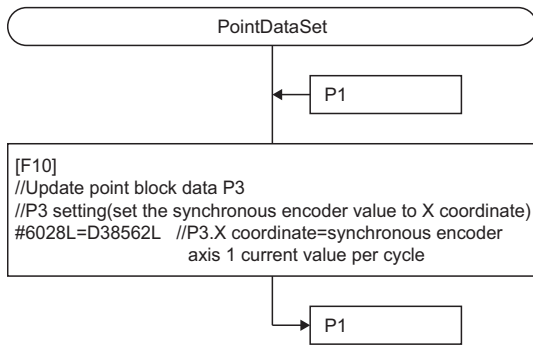

## Speed switching during instruction

---

During machine program operation, switching the speed of machine positioning data is possible.

Speed commands are set to each point.

# 8 MANUAL CONTROL

---

This chapter describes the manual control methods for a machine control system.

## 8.1 JOG Operation

---

For machine configuration axes, JOG operation of a specified axis can be performed.

Refer to the following for details of JOG operation.

📖 MELSEC iQ-R Motion Controller Programming Manual (Positioning Control)

## 8.2 Manual Pulse Generator Operation

---

For machine configuration axes, manual pulse generator operation of a specified axis can be performed.

Refer to the following for details of manual pulse generator operation.

📖 MELSEC iQ-R Motion Controller Programming Manual (Positioning Control)

## 8.3 Machine JOG Operation

Machine JOG operation for each machine is started by specifying the coordinate system (world coordinate system, base coordinate system, tool coordinate system) and coordinates axes (X, Y, Z, A, B, C) of the machine. Machine JOG operation cannot be started simultaneously with the specified machine or the specified axes.

Start the machine JOG operation of the specified machine. Machine JOG operation is performed with the machine JOG start commands shown below.

- [Rq.2250] Machine forward rotation JOG start command X (M43632+32m)
- [Rq.2251] Machine forward rotation JOG start command Y (M43633+32m)
- [Rq.2252] Machine forward rotation JOG start command Z (M43634+32m)
- [Rq.2253] Machine forward rotation JOG start command A (M43635+32m)
- [Rq.2254] Machine forward rotation JOG start command B (M43636+32m)
- [Rq.2255] Machine forward rotation JOG start command C (M43637+32m)
- [Rq.2256] Machine reverse rotation JOG start command X (M43640+32m)
- [Rq.2257] Machine reverse rotation JOG start command Y (M43641+32m)
- [Rq.2258] Machine reverse rotation JOG start command Z (M43642+32m)
- [Rq.2259] Machine reverse rotation JOG start command A (M43643+32m)
- [Rq.2260] Machine reverse rotation JOG start command B (M43644+32m)
- [Rq.2261] Machine reverse rotation JOG start command C (M43645+32m)

The coordinate system to perform machine JOG operation is set by the Machine JOG coordinate system setting shown below. The coordinates for which machine JOG operation are possible differ by machine type. Refer to the instruction manual of the machine library for details.

- [Cd.2162] Machine JOG coordinate system setting (D52900+32m)

### Setting data

#### ■Machine parameter (Machine speed setting)

Parameter block, machine JOG speed limit value (mm), and machine JOG speed limit value (degree) are set in the machine speed setting of machine parameter. Acceleration and deceleration are controlled based on the acceleration time/deceleration time of the specified parameter block, and the data of the machine JOG speed limit value (mm)/machine JOG speed limit value (degree).

Refer to machine parameter for details of machine parameter. (☞ Page 47 Machine Parameter)

#### ■Machine JOG speed

Set the speed used by machine JOG with "[Cd.2160] Machine JOG speed setting(mm) (D52896+32m, D52897+32m)", "[Cd.2161] Machine JOG speed setting(degree) (D52898+32m, D52899+32m)". The machine JOG operation speed setting value that matches the unit of the coordinates for performing machine JOG operation is used.

The setting range for "[Cd.2160] Machine JOG speed setting(mm) (D52896+32m, D52897+32m)", and "[Cd.2161] Machine JOG speed setting(degree) (D52898+32m, D52899+32m)" is shown below.

Device name	Setting range
[Cd.2160] Machine JOG speed setting(mm) (D52896+32m, D52897+32m)	1 to 600000000( $\times 10^{-2}$ [mm/min])
[Cd.2161] Machine JOG speed setting(degree) (D52898+32m, D52899+32m)	1 to 2147483647( $\times 10^{-3}$ [degree/min])

#### ■Machine JOG operation speed limit value

When machine JOG speed setting exceeds the speed limit value during machine JOG operation, an error (error code: 0EE0H (details code: 00E1H)) occurs, and the speed limit value is used as the machine JOG speed. Use the following parameters for the speed limit value.

Coordinate unit	Setting item
mm	Machine JOG speed limit value (mm)
degree	Machine JOG speed limit value (degree)



## Machine JOG coordinate system setting

Set the coordinate system to execute machine JOG operation with "[Cd.2162] Machine JOG coordinate system setting (D52900+32m)". When a value outside the setting range is input, a minor error (error code: 1FE0H (details code: 00E0H)) occurs, and operation does not start.

The setting range for "[Cd.2162] Machine JOG coordinate system setting (D52900+32m)" is shown below.

Setting value	Coordinate system
0	World coordinate system
2	Tool coordinate system

### Point

- Machine JOG operation cannot be started outside of the fixed parameter stroke limit range. Move inside the stroke limit range by JOG operation.
- Machine JOG operation cannot be started outside of the machine parameter XYZ stroke limit range. When outside of the XYZ stroke limit range, temporarily disable the XYZ stroke limit check and move inside the XYZ stroke limit range. To disable the XYZ stroke limit, turn ON "[Rq.2243] Machine XYZ stroke limit disable command (M43619+32m)".

## Processing details

- When the machine JOG start command is turned ON, machine JOG operation is performed with the value of the machine JOG speed set in "[Cd.2160] Machine JOG speed setting(mm) (D52896+32m, D52897+32m)", or "[Cd.2161] Machine JOG speed setting(degree) (D52898+32m, D52899+32m)". When the machine JOG start command is turned OFF, a deceleration stop is performed. Acceleration/deceleration are controlled based on the data set in "Machine Speed Setting" of machine parameter.

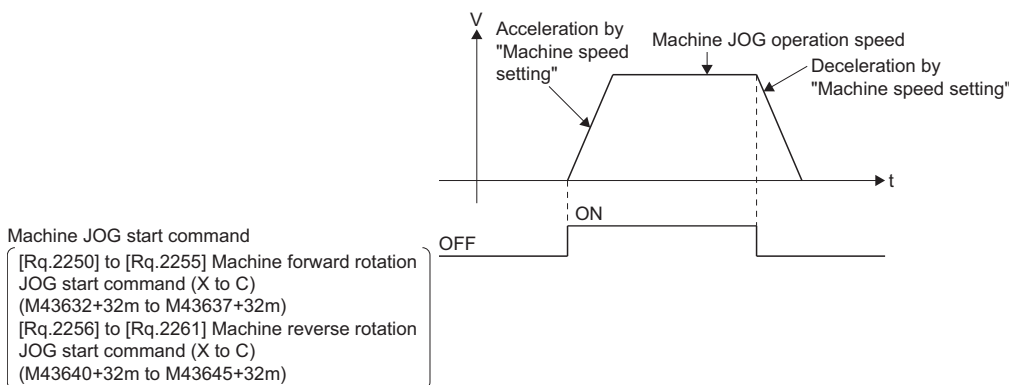

## Precautions

- Starting multiple coordinate axes of the same machine simultaneously is not possible. When multiple machine JOG start commands are turned ON, a minor error (error code: 1FE3H (details code: 0003H)) occurs, and machine JOG operation does not start.
- When "machine forward rotation JOG start command" and "machine reverse rotation JOG start command" are both turned ON in the same machine, a minor error (error code: 1FE3H (details code: 0003H)) occurs and machine JOG operation does not start.
- When the machine JOG start command is turned ON while machine configuration axes are started, a minor error (error code: 1FE2H (details code: 0003H)) occurs, and machine JOG operation does not start.
- Machine JOG operation does not start by STOP→RUN of the Motion CPU with the machine JOG start command turned ON.
- When starting with a coordinate axis that cannot be set with the machine type, a minor error (error code: 1FE0H (details code: 00E2H)) occurs, and machine JOG operation cannot start.

- When "[St.1069] Home position return request (R: M32409+32n/Q: M2409+20n)" is turned ON, machine JOG operation cannot be started. When machine JOG operation is started with "[St.1069] Home position return request (R: M32409+32n/Q: M2409+20n)" turned ON, a minor error (error code: 1FE2H (details code: 0004H)) occurs. Additionally, the error occurs regardless of the setting of "Operation for HPR Incompletion" in [Motion Control Parameter] ⇒ [Axis Setting Parameter] ⇒ "Home Position Return Data".
- If machine JOG operation is started from a singularity, a warning (error code: 0EE2H) will occur. Although execution of machine JOG operation will continue even when a warning occurs, adjust the machine JOG operation starting coordinate value so that it is not a singularity in the event that the machine configuration axis does not operate. When there is a singularity during machine JOG operation with tool coordinate system specified, a minor error (error code: 1FE1H (details code: 0502H)) occurs, and the machine JOG operation stops.

## Program example

The program for performing machine JOG operation moving in the X coordinate direction is explained as an example. This program example is explained in the "MELSEC iQ-R Motion device assignment" device assignment method.

### Machine JOG operation conditions

Item		Machine JOG operation conditions	
Joint axis structure	Joint axis 1	Axis 1	
	Joint axis 2	Axis 2	
	Joint axis 3	Axis 3	
Machine No.		1	
Machine JOG operation speed		100000(1000.00[mm/min])	
Machine JOG start command	Forward rotation JOG start	X coordinate	X1 is ON

### Motion SFC program

The Motion SFC program for executing JOG operation is shown below.

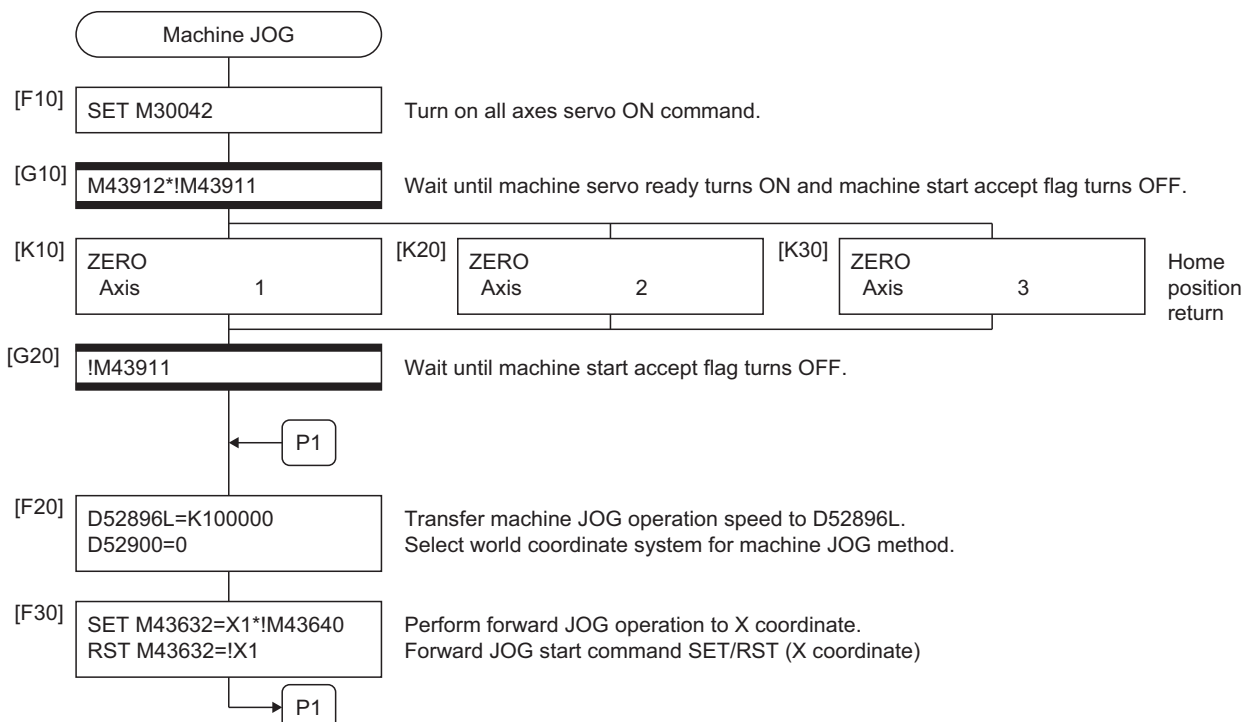

\*1 Example of the above Motion SFC program is started using the automatic start or sequence program.

## 9.1 Relationship between Machine Control and Each Function

The relationship between machine control and each function is shown below.

○: Valid, —: Invalid

Function	Machine control	Details	
Torque limit function	○	Torque limit value can be changed by torque limit value change instruction(M(P).CHGT/D(P).CHGT, CHGT).	
Hardware stroke limit	○	The same as positioning control.	
Forced stop	○	The same as other positioning methods.	
Control change	Current value change	○	The same as other positioning methods.
	Speed change	—	Ignored.
	Torque limit value	○	The same as positioning control.
	Target position change	—	Ignored.
Absolute position system	○	The same as other positioning methods.	
M-code output function	○	M-code is stored in "[Md.2080] Machine M-code (D53273+128m)" and "[Md.25] M-code (R: D32013+48n/Q: D13+20n)" of the machine configuration axis.	
Backlash compensation function	○	The same as other positioning methods.	
Speed control (II)	○	When machine configuration axes are in positioning control mode machine coordinates are refreshed. *: For modes other than positioning control mode, the position of joint axes becomes an abnormal value, coordinates for the machine cannot be created correctly, and the updating of machine coordinates stops.	
Speed-torque control	○		
Pressure control	○		
Advanced synchronous control	○	Advanced synchronous control can be used. During advanced synchronous control, machine coordinates are updated according to the values of the joint axis.	
File transmission at boot function	○	Machine common parameter, and machine parameter can be transmitted at boot.	
Parameter change function	○	Machine common parameter, and machine parameter can be changed.	
Override function	○	Speed change by override is available.	
Vibration suppression command filter	○	The same as other positioning methods.	
Servo motor maximum speed check	○	The servo motor maximum speed is checked for each axis during machine JOG operation, and machine program operation.	
Each axis device	—	<ul style="list-style-type: none"> <li>At the start completion of machine program operation "[St.1060] Positioning start complete (R: M32400+32n/Q: M2400+20n)" turns ON. It does not turn ON at start of machine JOG operation.</li> <li>At the command output completion to the positioning address of machine program operation "[St.1061] Positioning complete (R: M32401+32n/Q: M2401+20n)" turns ON. It does not turn ON when stopped midway.</li> <li>At the start of machine JOG operation or when stopped, "[St.1061] Positioning complete (R: M32401+32n/Q: M2401+20n)" does not turn ON.</li> <li>During machine program operation, "[St.1062] In-position (R: M32402+32n/Q: M2402+20n)" is always updated.</li> <li>From start of machine JOG operation until start of deceleration, "[St.1062] In-position (R: M32402+32n/Q: M2402+20n)" is turned OFF.</li> <li>During machine program operation "[St.1063] Command in-position (R: M32403+32n/Q: M2403+20n)" is not output.</li> <li>When executing the end positioning point in machine program operation, "[St.1048] Automatic decelerating flag (R: M30208+n/Q: M2128+n)" is ON while automatic deceleration is processing.</li> </ul>	

## 9.2 Proximity Pass Function

The proximity pass function is for smooth continuous operation between interpolation operations when performing consecutive interpolation operations. For the operation of the proximity pass function, set proximity pass(b3) of the expansion point item setting ON, and set the proximity pass method, and proximity range in the machine positioning data of each point. Proximity pass method and setting range are shown below. Refer to machine positioning data for proximity pass. (Page 54 Machine Positioning Data)

Proximity pass method	Proximity range
0: Invalid	0
1: JOINT remaining distance method (end point distance)	0 to 2147483647[interpolation control units]

### JOINT remaining distance method (end point distance)

#### Control

- When performing JOINT remaining distance method proximity pass, set "1: JOINT remaining distance method (end point distance)" to proximity pass method, and "radius(proximity range) of the arc that determines movement trajectory" to the proximity range.

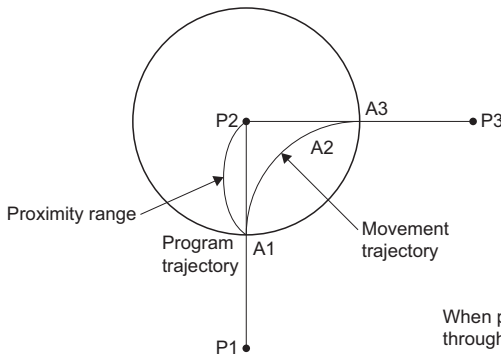

When proximity pass is enabled in a program that passes through P1-P2-P3, movement to P3 starts from point A1.

- When the proximity range is set to "0", the proximity range set at the previous point is used. However, when there is no setting for proximity range from the start of the program, "proximity range=0" and proximity pass is not performed.

Proximity pass method	Proximity range	Operation
0: Invalid	0	Proximity operation is not performed.
1: JOINT remaining distance method (end point distance)	0	The proximity range set at the previous point is used.
	1 to 2147483647[interpolation control units]	The proximity range set at the passing point is used.

- When the proximity range setting is outside of range, a warning (error code: 0EE0H(details code: 003CH)) occurs, and machine program operation continues using the proximity range setting from the previous point.
- When not using proximity pass, set the proximity pass method to "0: Invalid".

#### Restriction

Set the proximity range (radius of the arc) so that it does not overlap with the proximity range of other points. If the proximity range settings overlap, the movement amounts are composited and the control may pass through an unintended trajectory.

- Points with no proximity pass setting (expansion point item setting proximity pass(b3): OFF) take the setting from the previous point. However, when there is no setting for proximity pass from the start of the program, proximity pass method is "0: Invalid" and proximity pass method is not performed. Also, for points after sequential coordinate command control, proximity pass method is "0: Invalid". When using the proximity pass function at points after sequential coordinate command control, the proximity pass method must be set. However, the proximity range setting value is taken from the previous point.

**Ex.**

When the following machine positioning data is set in the program that passes (linear interpolation) between P1-P2-P3-P4-P5-P6-P7-P8

Point No.	Machine positioning data				Operation
	Positioning point block No.	Expansion point item setting	Expansion point data item		
		Proximity pass	Proximity pass method	Proximity range	
1	P2	OFF	—	—	No proximity pass
2	P3	ON	1: JOINT remaining distance method (end point distance)	100000	Proximity pass (Proximity range=100000)
3	P4	ON	1: JOINT remaining distance method (end point distance)	50000	Proximity pass (Proximity range=50000)
4	P5	OFF	—	—	Proximity pass (Proximity range=50000)
5	P6	ON	0: Invalid	0	No proximity pass
6	P7	ON	1: JOINT remaining distance method (end point distance)	0	Proximity pass (Proximity range=50000)
7	P8	OFF	—	—	End point, thus no proximity pass

Movement trajectory of P1-P2-P3-P4-P5-P6-P7-P8 (linear interpolation)

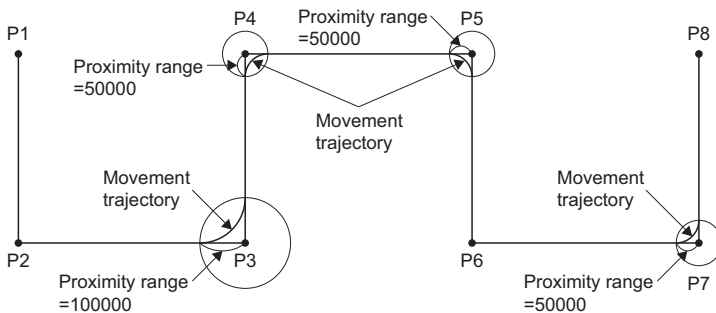

- When proximity pass is invalid, dwell time settings are invalid.
- Proximity pass is invalid at the end point.

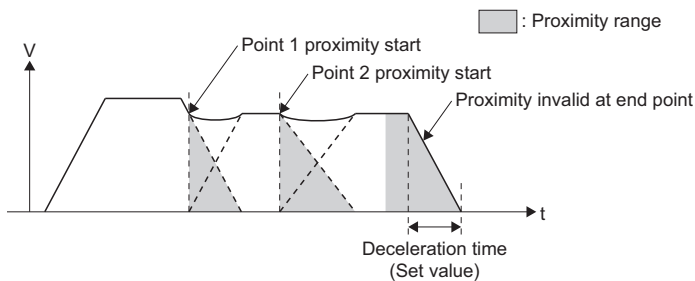

- Also, when the control method is set to NOP for all points after the point where proximity pass is set, proximity pass becomes invalid.

**Ex.**

When positioning point 4 and positioning point 5 are NOP instructions

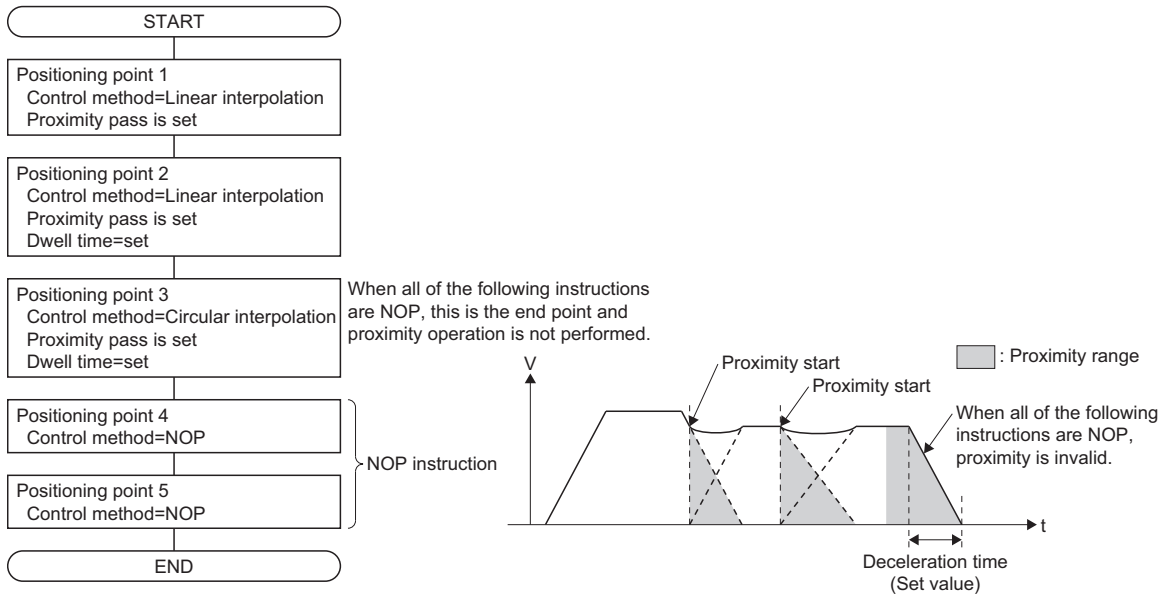

- The proximity start position is determined by the composite movement amount of all coordinate components (X, Y, Z, A, B, C).

$$\text{Composite movement amount} = \sqrt{DX^2 + DY^2 + DZ^2 + DA^2 + DB^2 + DC^2}$$

D: Distance to target position of each coordinate

**Ex.**

When proximity pass setting value is "30000.0[μm]"

When there is no movement amount for attitude coordinates (A, B, C) (only movement for XYZ), proximity starts when entering the spherical range of 30000.0[μm] from the end point.

When there is movement for attitude coordinates (A, B, C), the proximity start position is less than 30000.0[μm] from the end point.

- When the composite movement amount is less than two times proximity range, proximity pass is performed at half the movement amount.

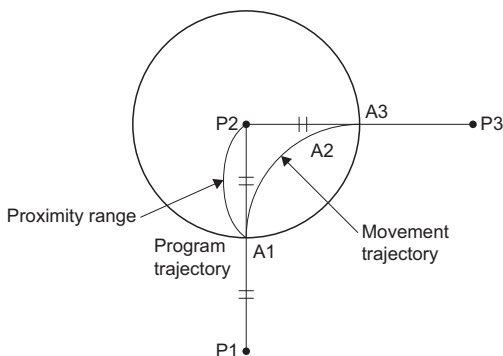

- The proximity start point for circular interpolation is within the proximity range after half of the arc distance has been passed.

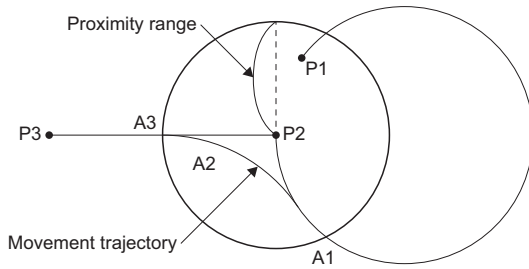

When proximity pass is valid for a program that passes through P1-P2-P3, movement to P3 starts from the point A1. Even if P1 is inside the proximity range, proximity operation will not start until half of the arc distance has been travelled.

- When the initial composite movement amount of the program is less than the proximity range, proximity pass is not performed.

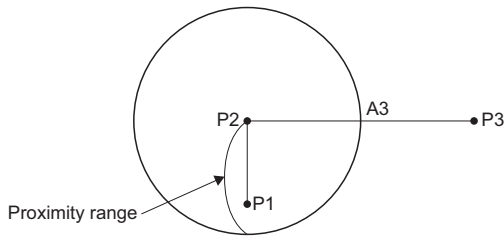

Even if proximity pass is valid for a program that passes through P1-P2-P3, when the composite movement amount for P1-P2 is less than the proximity range, a linear operation is made between P1-P2-P3.

## Time of deceleration stop by proximity

When proximity is started, the point being executed starts deceleration processing. The time of deceleration stop by proximity is calculated by the following methods.

- Calculate the deceleration time from the remaining movement amount at the time of proximity start and the current speed.  
Deceleration time at the current proximity=(remaining movement amount $\times$ 2 $\div$ current speed)
- When decelerating by the previous proximity, add the deceleration time.  
Time of deceleration stop by proximity=the longer of the deceleration time at the current proximity and the remaining deceleration time from the previous proximity.
- The coordinate system (components) used for remaining movement amount and current speed differs by control method.

Control method	Remaining movement amount <sup>*1</sup> /current speed of the coordinate system(components)	Remarks
Linear interpolation	World coordinate (Valid XYZABC components)	
Circular interpolation	World coordinate (arc length, and valid ABC components)	The movement amount of the XYZ components of circular interpolation is the arc length.
Joint interpolation	Joint axis coordinate (Valid J1 to J6 components)	

\*1 The remaining movement amount is the square root of the sum of the squares of each valid component.

### Operation example

The machine in the table below is shown as an operation example.

Point	Details
Machine	Cartesian type (J1=X, J2=Y)
Point 1	Only X coordinate moves (Linear interpolation)
Point 2	Only Y coordinate moves (Linear interpolation)

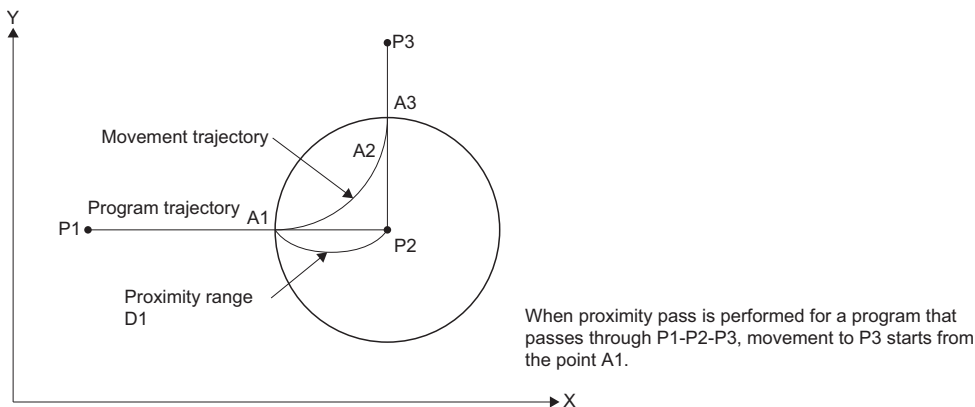

- An example for when remaining movement amount at proximity start (proximity range(D1)) is "10000.0[ $\mu$ m](=10.0000[mm])", and speed at proximity start (V1) is "4800.00[mm/min] (=80.00[mm/s])" is shown below.

Time of deceleration stop by proximity(T1)=(10.0000[mm] $\times$ 2 $\div$ 80.00[mm/s])=0.25[s]

When starting proximity before deceleration start, the "time of deceleration stop by proximity(T1)" becomes longer than the deceleration time set in the program.

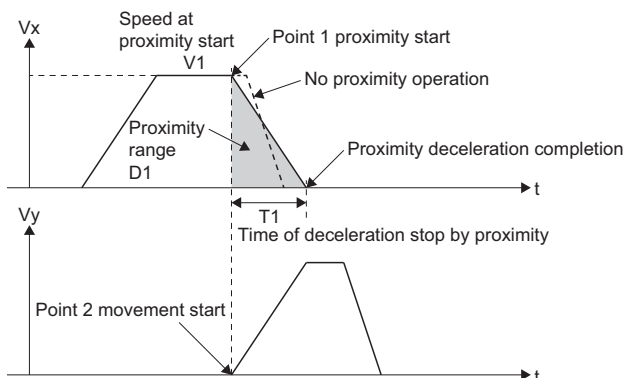



## Adjustment of acceleration time by proximity

Acceleration time can be adjusted with the time of deceleration stop by proximity and acceleration time of the next point as follows.

Condition	Time of deceleration stop by proximity < acceleration time of next point (When "time of deceleration stop by proximity" is short)	Time of deceleration stop by proximity ≥ acceleration time of next point (When "time of deceleration stop by proximity" is long)
Deceleration operation of point 1 (Point of proximity pass )	<ul style="list-style-type: none"> <li>When starting proximity during deceleration, operation transfers to deceleration operation by proximity.</li> <li>When starting proximity before deceleration start, deceleration by proximity starts. The "time of deceleration stop by proximity" becomes longer than the deceleration time set in the program.</li> </ul>	
Acceleration operation of point 2 (Next point)	<ul style="list-style-type: none"> <li>Acceleration by the set acceleration time.</li> <li>Refer to operation example 1 (Page 95 Operation example 1)</li> <li>Refer to operation example 2 (Page 96 Operation example 2)</li> </ul>	<ul style="list-style-type: none"> <li>Acceleration by "time of deceleration stop by proximity"</li> <li>Refer to operation example 3 (Page 96 Operation example 3)</li> </ul>

The machine in the table below is shown as an operation example.

Point	Details
Machine	Cartesian type (J1=X, J2=Y)
Point 1	Only X coordinate moves (Linear interpolation)
Point 2	Only Y coordinate moves (Linear interpolation)

### Operation example 1

Time of deceleration stop by proximity < acceleration time of next point (when proximity range is small)

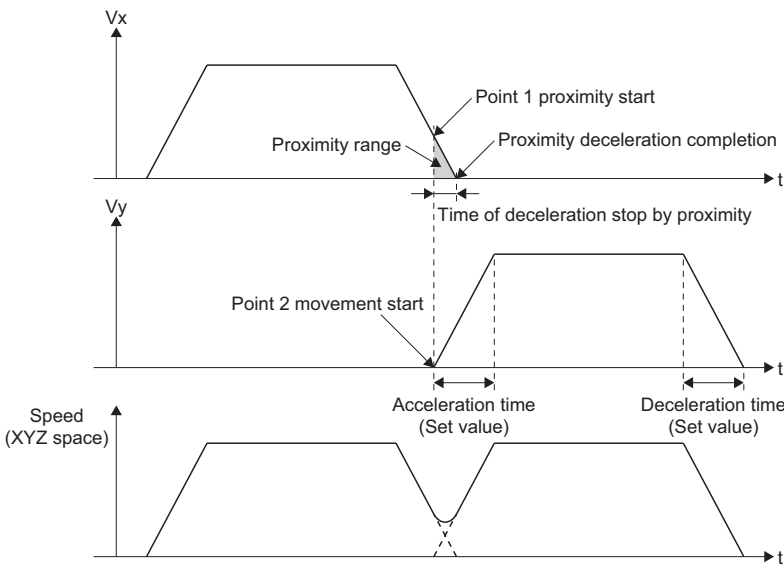

#### Point

Operation example 1 is an example for a Cartesian robot.

In articulated robots, the deceleration stop operation after proximity start is different for each joint axis. (When the remaining distance of the joint axis coordinate is large at start of deceleration stop by proximity in linear interpolation and circular interpolation of an articulated robot, joint speed may increase.)

### ■ Operation example 2

Time of deceleration stop by proximity < acceleration time of next point (setting value of acceleration time of next point is long)

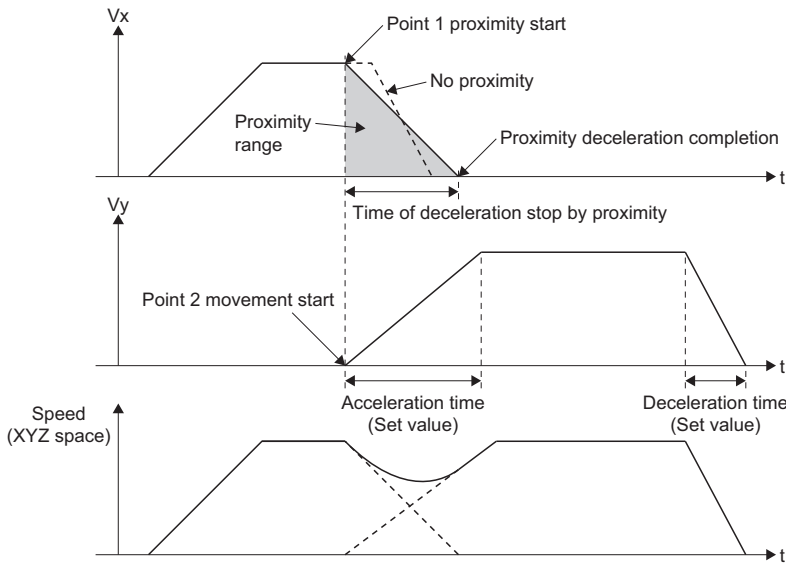

### ■ Operation example 3

Time of deceleration stop by proximity  $\geq$  acceleration time of next point (when proximity range is large)

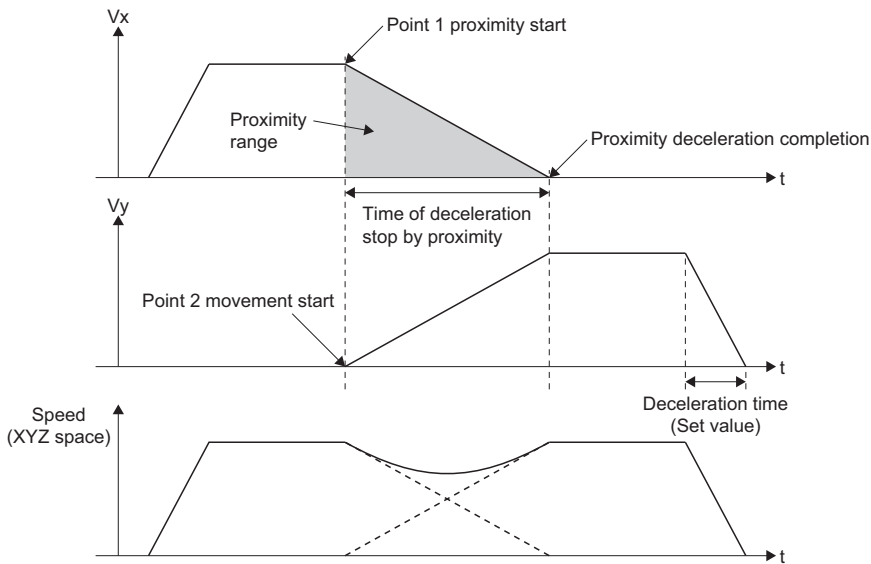

## Stop causes

When a stop/rapid stop event occurs in the proximity section, a deceleration stop is performed as shown below. Upon proximity processing, and the stopping of the point being executed, "[St.2127] Machine start accept flag (M43911+32m)" turns OFF.

Point	Operation
Point during proximity	Deceleration operation by proximity processing is continued. (After the stop of point being executed, deceleration by proximity processing continues.)
Point being executed	Deceleration stop is performed by the set deceleration time (rapid stop deceleration time).

### Operation example

The machine in the table below is shown as an operation example.

Point	Details
Machine	XYZ Cartesian type (J1=X, J2=Y)
Point 1	Only X coordinate moves
Point 2	Only Y coordinate moves

- When stop command is turned ON during proximity processing of the machine program operation

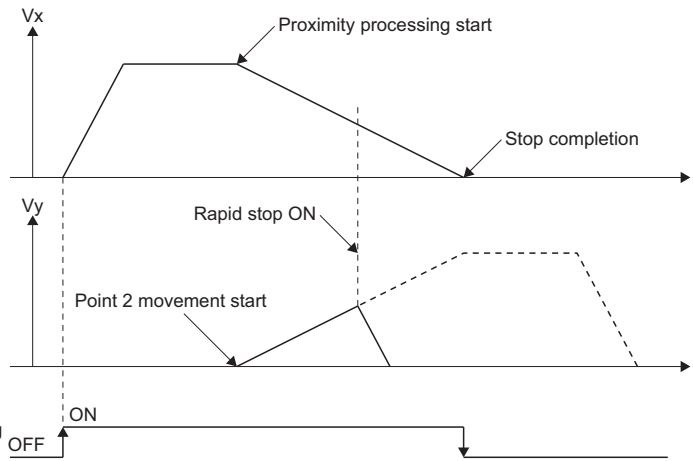

- When forced stop is performed in the proximity section (immediate stop).

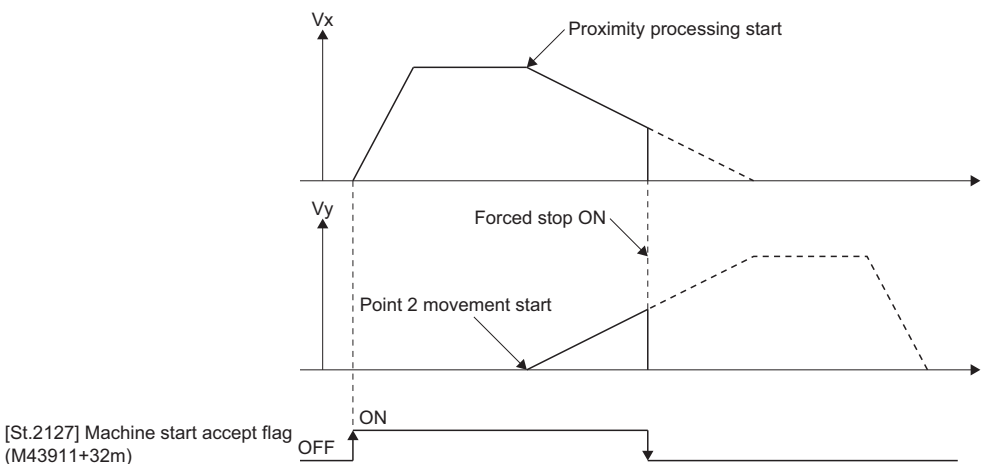

## 9.3 Speed Restriction Function

Depending on the control classification, the function of the speed restriction is different. The valid speed restriction functions in positioning control are shown below.

○: Valid, ×: Invalid

Control details	Basic operation	Control details	Control classification				Reference
			Joint interpolation	Linear interpolation	Circular interpolation	Sequential coordinate command	
Command speed limit value	Limits command speed during operation.	Controls with the speed limit value of the parameter block set in the machine positioning data or machine parameters.	○	○	○	×	Page 65 Positioning speed
Joint interpolation speed limit	Automatically adjusts movement speed during operation.	Automatically adjusts the servo motor speeds of each joint axis during joint interpolation so that they do not become excessive. Valid when movement amount on the XYZ space is small.	○	×	×	×	Page 98 Joint interpolation speed limit
Servo motor maximum speed check	Monitors the servo motor speed, and stops operation.	Monitors the servo motor speed of joint axes, and stops joint axes.	○	○	○	○	Page 99 Servo motor maximum speed check

### Joint interpolation speed limit

During joint interpolation, speed is automatically adjusted so that the servo motor speeds of each joint axis do not become excessive.

The servo motor speed of each joint axis is set in the servo motor maximum speed of each axis in [Motion Control Parameter] ⇒ [Axis Setting Parameter] ⇒ "Expansion Parameter" ⇒ "Servo Motor Max. Speed Check Parameter". Refer to the following for details of servo motor maximum speed check parameter.

📖 MELSEC iQ-R Motion Controller Programming Manual (Positioning Control)

- When the setting value of the servo motor maximum speed check parameter (servo motor maximum speed) is not "0", during joint interpolation (ABS/, INC/), the servo motor speed of joint axes is automatically adjusted so that it does not exceed the following.

Acceleration/deceleration processing	Formula
Trapezoidal acceleration/deceleration	(Servo motor speed)=(Servo motor maximum speed) × 99.9[%]
S-curve acceleration/deceleration	(Servo motor speed)=(Servo motor maximum speed) × 90.0[%]

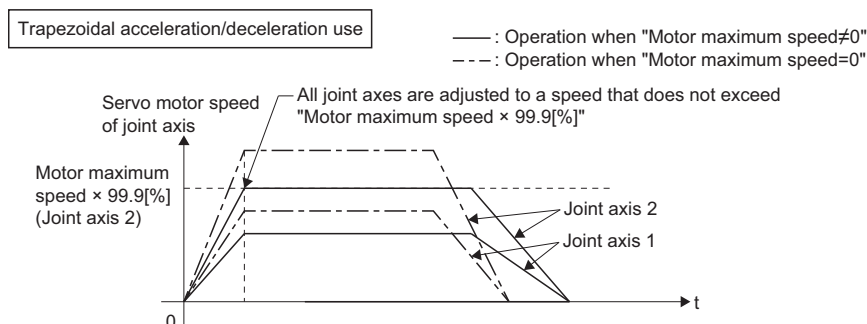

- When joint interpolation speed is automatically adjusted by the speed restriction function, the acceleration/deceleration is "time-fixed acceleration/deceleration".
- When the setting value of servo motor maximum speed check parameter (servo motor maximum speed) is "0", this function is invalid.

- Because the joint interpolation speed restriction function adjusts the command speed set at program analysis, when override function is used, the joint interpolation speed restriction function operation is as follows.

Command speed	Operation
Automatically adjusted by joint interpolation speed restriction function	Automatically adjusted speed operates at a speed for override ratio 100.0[%]. If a value exceeding 100.0[%] is set to the override ratio, a warning (error code: 0EE0H) occurs, and operation is at override ratio of 100.0[%].
Not automatically adjusted by joint interpolation speed restriction function	The command speed operates at a speed for override ratio 100.0[%]. The joint interpolation speed restriction is not performed for speeds changed by the override function therefore if a value exceeding 100.0[%] is set to the override ratio, the operation is stopped by error with the servo motor maximum speed check.

- When speed is adjusted by the joint interpolation speed limit function, "[St.2123] Joint interpolation velocity limiting (M43907+32m)" turns ON during positioning point execution.

## Servo motor maximum speed check

During machine program operation or machine JOG operation, the servo motor speeds of joint axes are monitored, and when the setting value for servo motor maximum speed is exceeded, all joint axes come to a deceleration stop.

The servo motor speed of each joint axis is set in [Motion Control Parameter] ⇒ [Axis Setting Parameter] ⇒ "Expansion Parameter" ⇒ "Servo Motor Max. Speed Check Parameter" ⇒ "Servo Motor Maximum Speed" of each axis. Refer to the following for details on servo motor maximum speed check parameter.

📖 MELSEC iQ-R Motion Controller Programming Manual (Positioning Control)

- When the command value to the servo amplifier exceeds the setting value of servo motor maximum speed, a minor error (error code: 1FE2H(details code: 0007H)) occurs and operation stops. The time from the servo motor maximum speed until stopping is set in [Motion Control Parameter] ⇒ [Axis Setting Parameter] ⇒ "Expansion Parameter" ⇒ "Servo Motor Max. Speed Check Parameter" ⇒ "Deceleration Time Constant" (0 to 20000[ms]). When deceleration time constant value is set to "0", the deceleration stop is performed according to the deceleration time constant set in the parameter block.
- When using a linear servo motor, the speed limit is converted from [mm/min] to [rpm] units.
- When used together with coordinate transformation, operation stops temporarily, therefore use the smoothing filter of the vibration suppression command filter function. When the smoothing filter is not set during machine program operation, a warning (error code: 0EE0H(details code: 00F0H)) occurs. Refer to the following for details on the vibration suppression command filter function.

📖 MELSEC iQ-R Motion Controller Programming Manual (Positioning Control)

- The operation for when joint axis 1 and 2 are in interpolation operation, and a servo motor maximum speed over is detected for joint axis 1 is shown below. When one joint axis exceeds the "servo motor maximum speed", all joint axes are stopped.

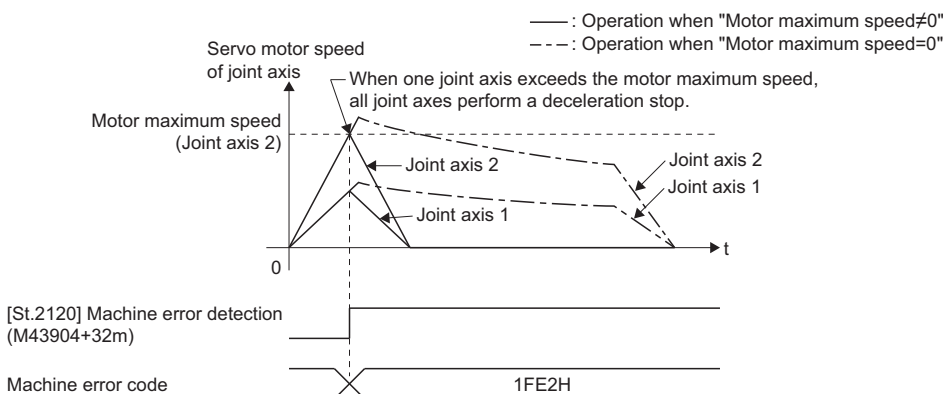

- When the setting value of the servo motor maximum speed check parameter (servo motor maximum speed) is "0", this function is invalid.

# 9.4 Base/Tool Transformation Change Function

This function changes the base transformation value and tool transformation value of the machine. When the base transformation value and tool transformation value are changed, the machine coordinate values (world coordinates, base coordinates) are changed.

○: Change value, —: Do not change value

Base/tool transformation change method	Machine monitor device			
	[Md.2061] to [Md.2066] Base translation (X to C) (D53242+128m to D53253+128m)	[Md.2069] to [Md.2071] Tool translation (X to Z) (D53256+128m to D53261+128m)	[Md.2025] to [Md.2031] Feed current value (world coordinate system)(X to FL1)(D53176+128m to D53188+128m)	[Md.2053] to [Md.2059] Feed current value (base coordinate system)(X to FL1)(D53228+128m to D53240+128m)
Set base transformation value	○	—	○	—
Set tool transformation value	—	○	○	○

## Base/tool transformation data setting

### ■Base/tool transformation

Set the transformation value for base/tool transformation in [Motion Control Parameter] ⇒ [Machine Parameter]. The base transformation and tool transformation set in machine parameter are the initial base transformation value and initial tool transformation value.

Refer to machine parameter for details of machine parameter. (📖 Page 47 Machine Parameter)

### ■Base/tool transformation change method

Set the change method for changing base/tool transformation in "[Cd.2163] Base/tool translation change method (D52901+32m)".

Setting value	Changing data	Details
0	Base transformation	Change the base transformation value to the value of "[Cd.2164] to [Cd.2169] Base/tool translation setting (X to C)(D52902+32m to D52913+32m)".
1		Change the base transformation value to the initial base transformation value.*1
2	Tool transformation	Change the tool transformation value to the value of "[Cd.2164] to [Cd.2169] Base/tool translation setting (X to C)(D52902+32m to D52913+32m)".
3		Change the tool transformation value to the initial tool transformation value.*2

\*1 The initial base transformation value is the base transformation value set in the machine parameter.

\*2 The initial tool transformation value is the tool transformation value set in the machine parameter.

### ■Base/tool transformation setting

Set the position type (POSE) value that changes the value of base transformation/tool transformation to the base/tool transformation change setting register.

Coordinate	Base/tool transformation setting register	Setting range*1
X	[Cd.2164] Base/tool translation setting (D52902+32m, D52903+32m)	-2147483648 to 2147483647(×10 <sup>-1</sup> [μm])
Y	[Cd.2165] Base/tool translation setting (D52904+32m, D52905+32m)	
Z	[Cd.2166] Base/tool translation setting (D52906+32m, D52907+32m)	
A	[Cd.2167] Base/tool translation setting (D52908+32m, D52909+32m)	-35999999 to 35999999(×10 <sup>-5</sup> [degree])
B	[Cd.2168] Base/tool translation setting (D52910+32m, D52911+32m)	
C	[Cd.2169] Base/tool translation setting (D52912+32m, D52913+32m)	

\*1 The setting range differs by machine type. Refer to the instruction manual of the machine library.

## Base/tool transformation change procedure

The change procedure for base/tool transformation is shown below.

1. Set the change method to "[Cd.2163] Base/tool translation change method (D52901+32m)", and the change values to "[Cd.2164] to [Cd.2169] Base/tool translation setting (X to C)(D52902+32m to D52913+32m)".
2. After checking that "[St.2124] Base/tool translation change complete (M43908+32m)" is turned OFF, turn "[Rq.2244] Base/tool translation change command (M43620+32m)" OFF→ON.
3. At the change completion of base/tool transformation, "[St.2124] Base/tool translation change complete (M43908+32m)" turns ON.
4. After checking that "[St.2124] Base/tool translation change complete (M43908+32m)" is turned ON, turn "[Rq.2244] Base/tool translation change command (M43620+32m)" ON→OFF.
5. "[St.2124] Base/tool translation change complete (M43908+32m)" turns OFF.
6. After checking that "[St.2124] Base/tool translation change complete (M43908+32m)" is turned OFF, execute base/tool transformation change again.

## Operation timing

### ■ Changing tool transformation

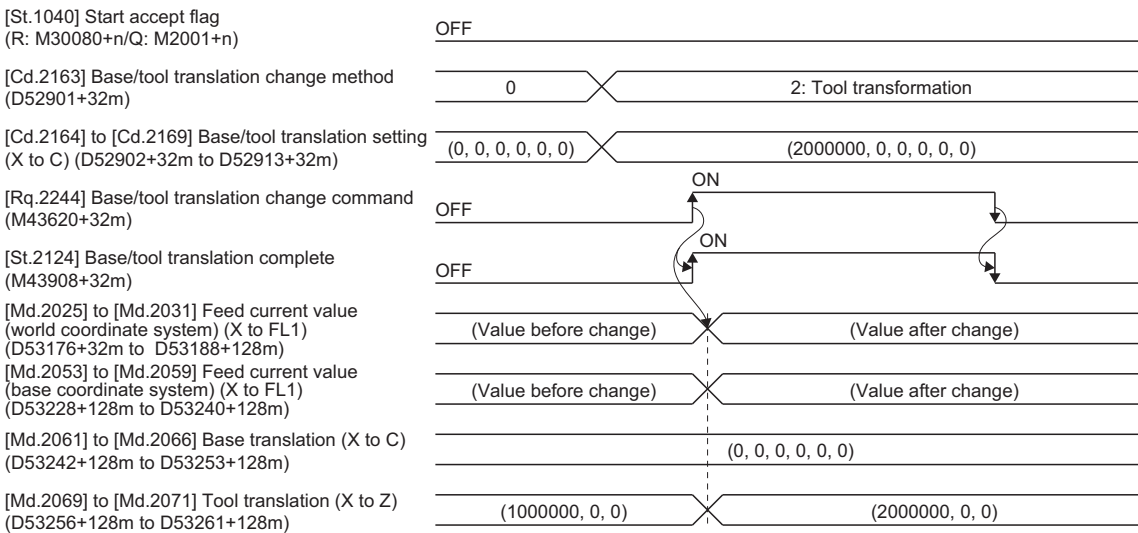

## ■When an error occurs at base transformation change

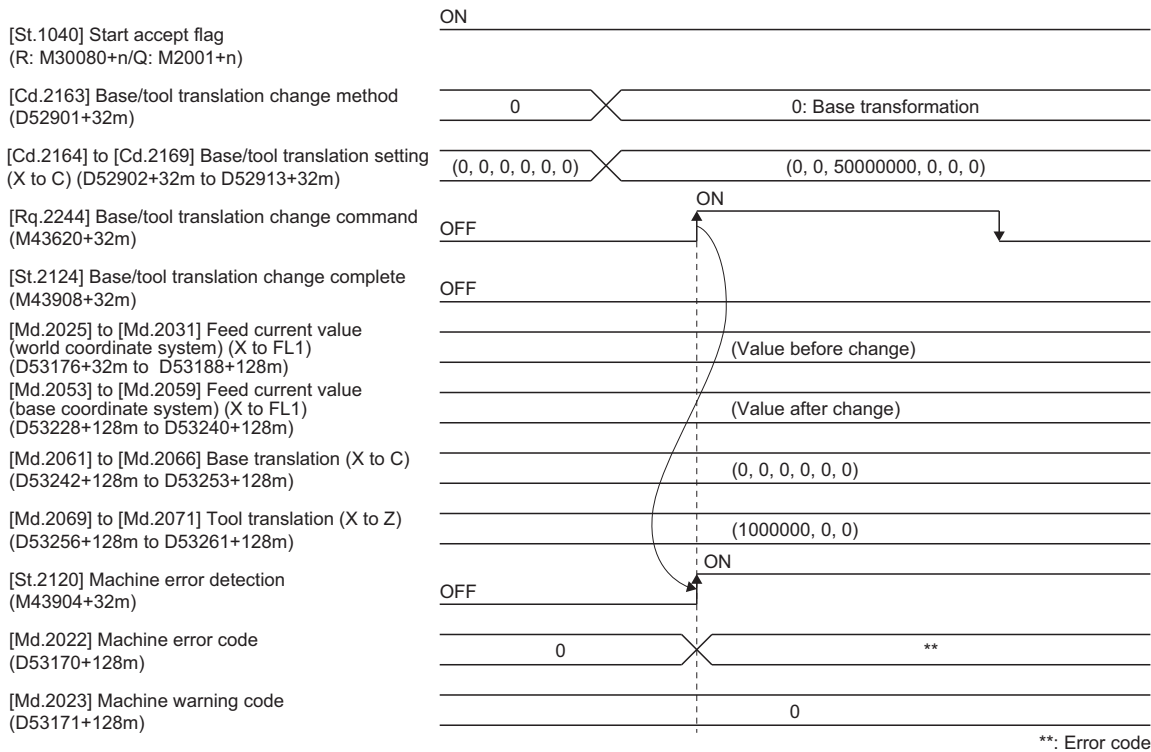

## Cautions

- Base/tool transformation change cannot be executed during machine operation, or during machine configuration axis start. When "[Rq.2244] Base/tool translation change command (M43620+32m)" turns ON during machine configuration axis start, a minor error (error code: 1FE7H) occurs and base/tool transformation change is not performed.
- When "[Rq.2244] Base/tool translation change command (M43620+32m)" turns ON while machine configuration axes are in a servo OFF state, base/tool transformation change is executed.
- When "[Cd.2163] Base/tool translation change method (D52901+32m)", and "[Cd.2164] to [Cd.2169] Base/tool translation setting (X to C)(D52902+32m to D52913+32m)" are outside of setting range, a minor error (error code: 1FE1H) occurs, and base/tool transformation change is not performed.
- The base/tool transformation change command is only valid at the leading edge(OFF→ON) of the device. Base/tool transformation change is not executed by STOP→RUN of the Motion CPU with the base/tool transformation change command turned ON.



# 9.5 WAIT-ON/OFF

The WAIT-ON/OFF function starts/pauses the positioning for points that are set, depending on the bit device status. For WAIT-ON/OFF operation, set the expansion point item setting (b6) to ON, and set the WAIT-ON/OFF setting and device No. for each point of machine positioning. WAIT-ON/OFF is set in the machine positioning data. (Page 54 Machine Positioning Data)

## Operation example

When WAIT-ON and dwell time are set to the second positioning point, WAIT-OFF is set to the third positioning point, and M-codes "10 to 30" are set to each positioning point.

"[St.2122] Machine WAIT (M43906+32m)" turns ON when each point is waiting for the conditions to be established.

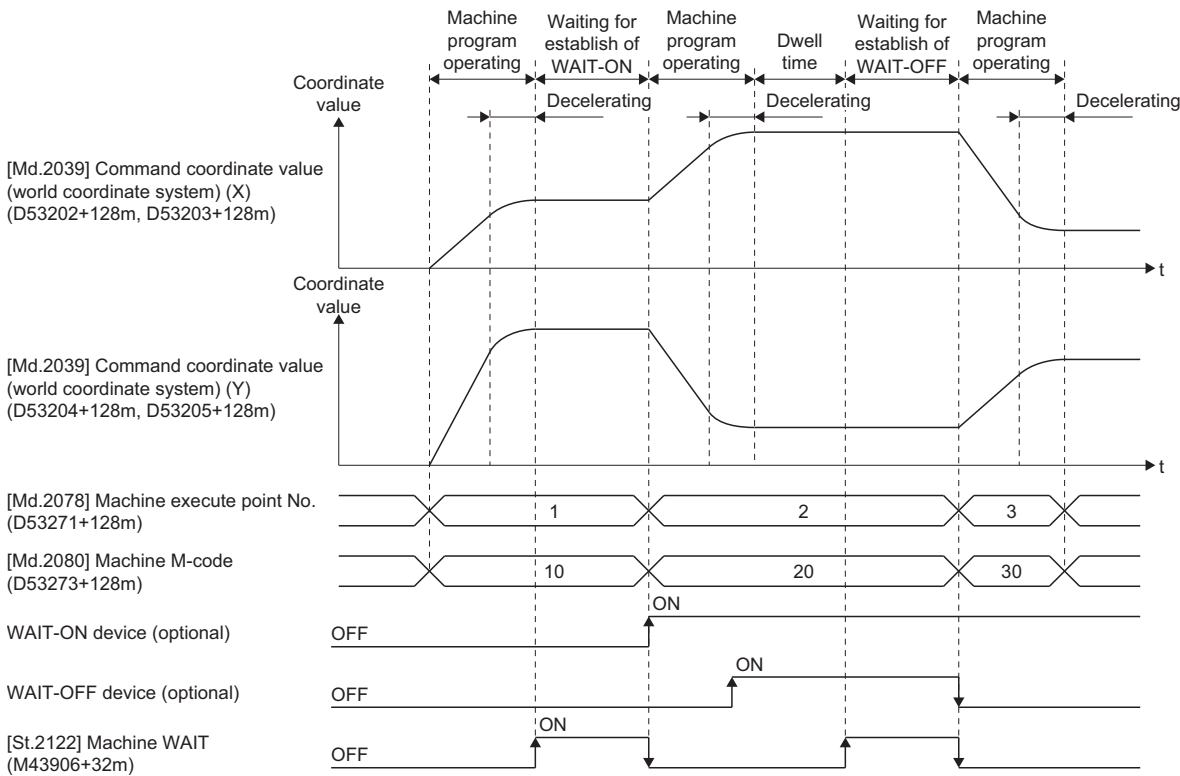

**Point**

- WAIT-ON/OFF controls the start and pause of positioning for the positioning points that have WAIT-ON/OFF set to them. In the example above, WAIT-ON is set to positioning point 2, and the operation stops at the position of the point block set in positioning point 1 when waiting for the conditions to be established.
- The WAIT-ON/OFF set to the first positioning point where machine program operation started is disabled. When executing WAIT-ON/OFF at the first positioning point, set a transition program describing the wait conditions with an Motion SFC program directly before the machine program operation.
- When the value for the establishment of WAIT-ON/OFF conditions is updated during the decelerating of the positioning point directly before, the updated values are used for WAIT-ON/OFF conditions, or positioning to the next positioning point starts.
- When dwell time is set to the positioning point directly before the positioning point with WAIT-ON/OFF set, the establishment of conditions/waiting for the conditions to be established for WAIT-ON/OFF is enabled after the dwell time of the positioning point directly before has elapsed.
- When M-code is set to the positioning point with WAIT-ON/OFF set, and waiting for the WAIT-ON/OFF conditions to be established, the M-code does not change until the conditions are established.

## Using with the proximity pass function

When proximity pass is set to the positioning point with WAIT-ON/OFF set, the operation pattern of proximity pass changes with the timing of when the WAIT-ON/OFF condition value is updated. The operations for when proximity pass is set to a positioning point with WAIT-ON/OFF set are shown below. Set the programs so that the appropriate operation pattern for the operation is used.

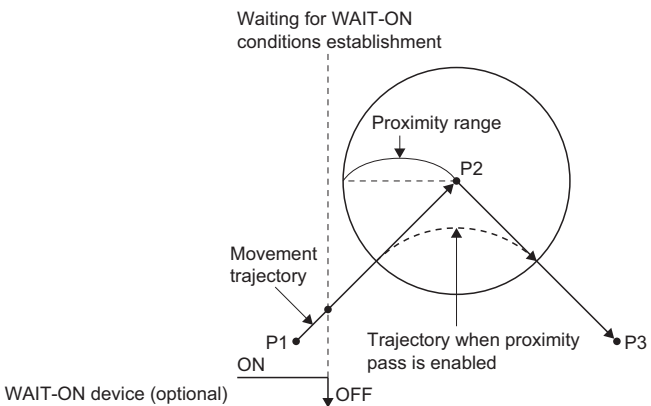
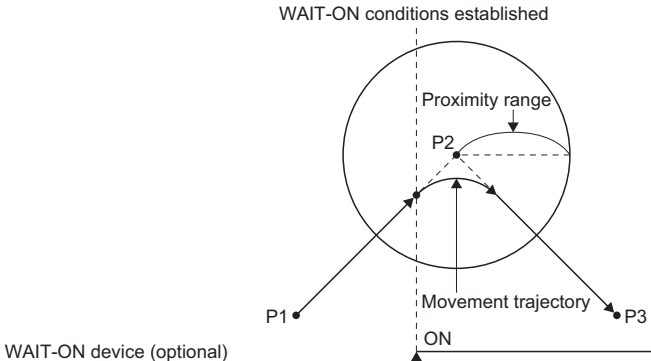
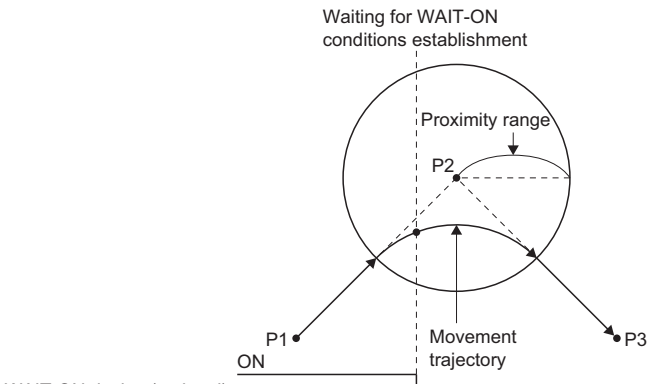
Item	Operation
<p>When WAIT-ON is set to positioning point (P3), and proximity pass is set to positioning point (P2), and waiting for the WAIT-ON conditions to be established before reaching the proximity range</p>	<p>Without performing proximity pass, WAIT-ON is waiting for the conditions to be established after performing positioning to positioning point (P2). After waiting for conditions establishment, positioning to positioning point (P3) starts when the WAIT-ON conditions are established.</p> 
<p>When WAIT-ON is set to positioning point (P3), and proximity pass is set to positioning point (P2), and the WAIT-ON conditions are established in the proximity range</p>	<p>Proximity pass starts at the timing of when conditions are established. However, when proximity pass is started immediately after arriving in the proximity range, because the actual proximity range is smaller, the time it takes to arrive at positioning point (P3) becomes longer.</p> 
<p>When WAIT-ON is set to positioning point (P3), and proximity pass is set to positioning point (P2), and waiting for the WAIT-ON conditions to be established after proximity pass has started</p>	<p>Without performing WAIT-ON, proximity pass continues with positioning to positioning point (P3).</p> 

## 9.6 Point Arrival Notification

The point arrival notification turns bit devices ON/OFF at coordinate positions during positioning to indicate the arrival at points.

For point arrival notification operation, set the expansion point item setting (b8) to ON, and set the notification method, device No., and notification setting value for each point of machine positioning. Point arrival notification is set in the machine positioning data. (Page 54 Machine Positioning Data)

### Operation example

When the following settings are made to each positioning point, and "[Md.2081] Arrival rate (D53274+128m)" arrives at the value set to notification setting value, the notification device turns ON/OFF.

Positioning point	Expansion point item setting	Setting value
First positioning point	Dwell time	1: Enabled
	Point arrival notification	Notification method: 1: Arrival rate specification (device ON) Notification setting value: 7000 ( $\times 0.01[\%]$ )
Second positioning point	Point arrival notification	Notification method: 2: Arrival rate specification (device OFF) Notification setting value: 3000 ( $\times 0.01[\%]$ )

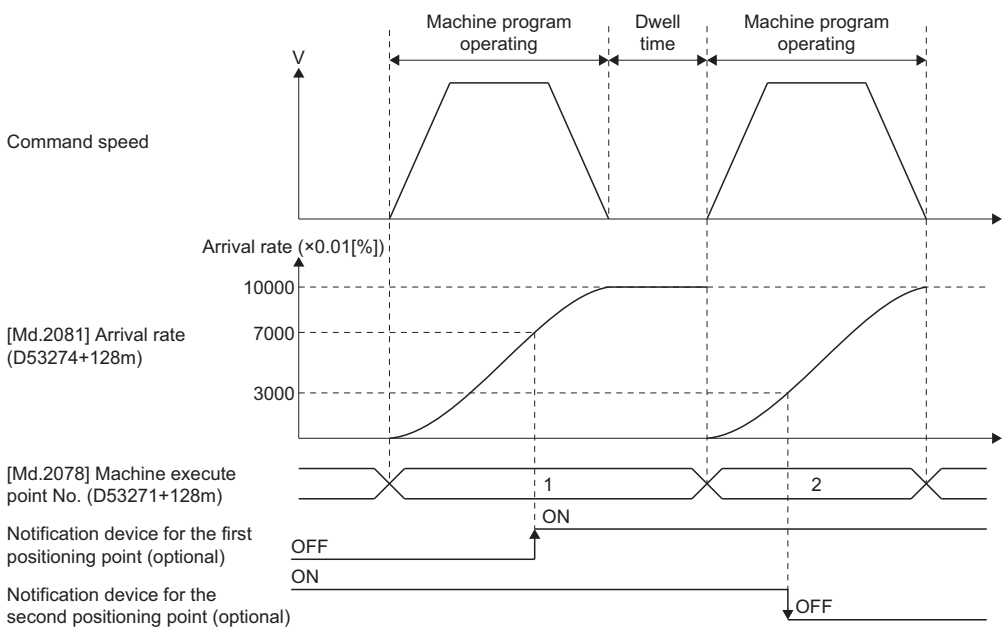

#### Point

- Set the initial status of the notification device with the user program.  
(Example)  
When "1: Arrival rate specification (device ON)" is set, set the device status to OFF with a user program before changing points.
- When positioning with sequential coordinate command control, point arrival notification is disabled regardless of the setting.

### CAUTION

- The devices for notification are turned ON/OFF when the notification setting value is exceeded while decelerating to a stop due to a stop factor such as an error.

## Using with the proximity pass function

When proximity pass is set to positioning points that have point arrival notification set, the timing of when the notification device turns ON changes depending on the proximity pass start position and the notification setting value.

The operation for when proximity pass is set to a positioning point that has point arrival notification (notification method: Arrival rate specification (device ON), notification setting value: 7000 ( $\times 0.01[\%]$ )) set is shown below. Set the programs so that the notification device turns ON/OFF at the appropriate timing.

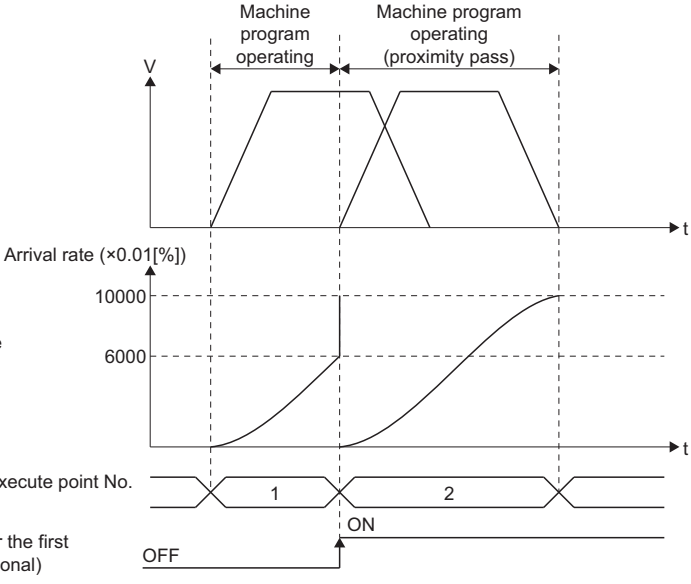
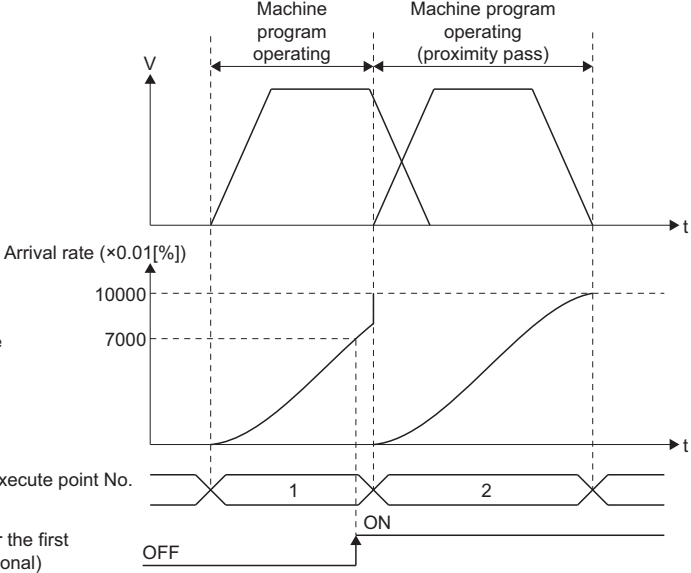
Item	Operation
<p>When the start position for proximity pass is before arriving at the notification setting value</p>	<p>The notification device turns ON when proximity pass starts. Proximity pass starts at the coordinates where "[Md.2081] Arrival rate (D53274+128m)" is "6000(<math>\times 0.01[\%]</math>)".</p>  <p>*: When WAIT-ON/OFF is set to the second positioning point, and proximity pass is started later than the notification setting value of point arrival notification, the notification device turns ON at a timing as if arriving at the notification setting amount of when "proximity pass start position is after arriving at the notification setting value".</p>
<p>When the start position for proximity pass is after arriving at the notification setting value</p>	<p>The notification device turns ON when "[Md.2081] Arrival rate (D53274+128m)" arrives at the notification setting value. Proximity pass starts at the coordinates where "[Md.2081] Arrival rate (D53274+128m)" is "8000(<math>\times 0.01[\%]</math>)".</p> 

# APPENDICES

## Appendix 1 Sample Program of Machine Control

The following shows a sample program for machine control with axis 1 to 3 of R64MTCPU as machine No.1. This program example is explained in the "MELSEC iQ-R Motion device assignment" device assignment method.

1. Set MR-J4(W)-B on the axis 1 to 3 in the servo network setting.

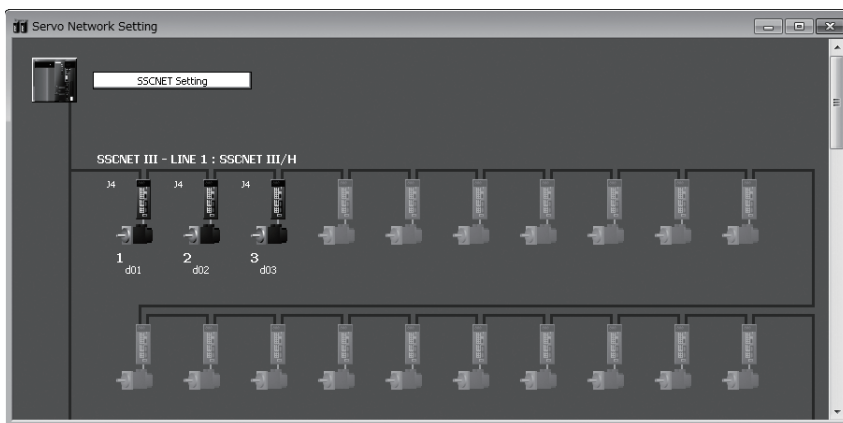

Item		Setting value		
		Axis 1	Axis 2	Axis 3
Amplifier information	Amplifier model	MR-J4(W)-B(-RJ)		
	Amplifier operation mode	Standard		
Axis information	Axis No.	1	2	3
	Station No.d	1	2	3

2. In basic setting, set machine control setting to "Used".

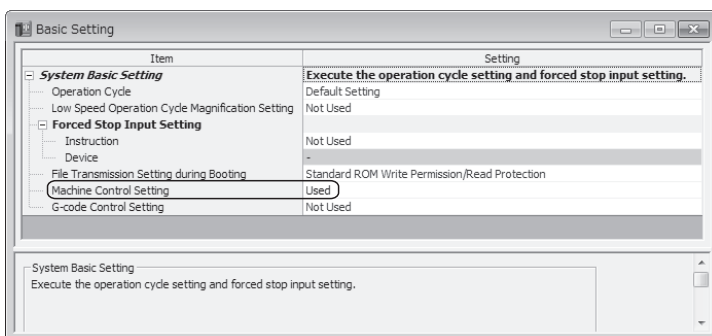

Item	Setting value
Machine control setting	Used

A

### 3. Set machine No.1 in machine parameter.

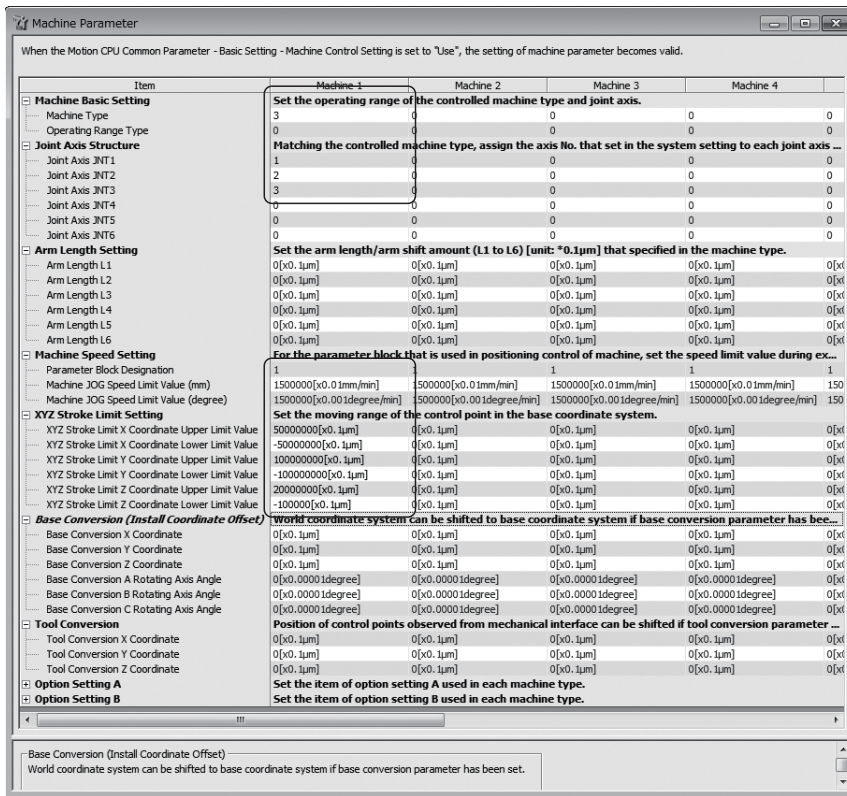

Item	Machine 1	
Machine basic setting	Machine type	3
	Operation range type	0
Joint axis structure	Joint axis JNT1	1
	Joint axis JNT2	2
	Joint axis JNT3	3
Machine speed setting	Parameter block designation	1
	Machine JOG speed limit value (mm)	1500000[×0.01mm/min]
	Machine JOG speed limit value (degree)	1500000[×0.001degree/min]
XYZ stroke limit setting	XYZ stroke limit X coordinate upper limit value	50000000[×0.1μm]
	XYZ stroke limit X coordinate lower limit value	-5000000[×0.1μm]
	XYZ stroke limit Y coordinate upper limit value	100000000[×0.1μm]
	XYZ stroke limit Y coordinate lower limit value	-100000000[×0.1μm]
	XYZ stroke limit Z coordinate upper limit value	20000000[×0.1μm]
	XYZ stroke limit Z coordinate lower limit value	-100000[×0.1μm]

4. Set the axis setting parameter of axis 1 to 3 to match the machine configuration.

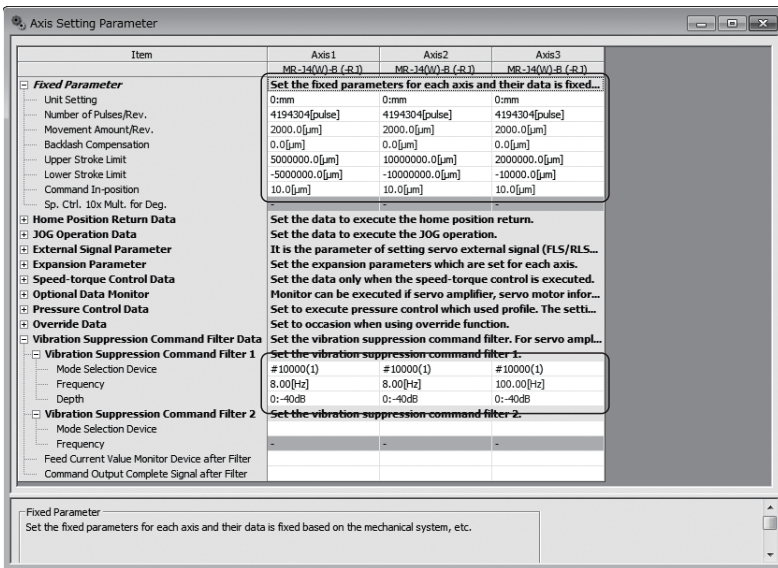

Item	Setting value			
	Axis 1	Axis 2	Axis 3	
Fixed parameter	Unit setting	0: mm		
	Number of pulses/rev.	4194304[pulse]		
	Movement amount/rev.	2000.0[μm]		
	Backlash compensation	0.0[μm]		
	Upper stroke limit	5000000.0[μm]	10000000.0[μm]	2000000.0[μm]
	Lower stroke limit	-5000000.0[μm]	-10000000.0[μm]	-10000.0[μm]
Vibration suppression command filter data	Vibration suppression command filter 1	Mode selection device	#10000	
		Frequency	8.00[Hz]	
		Depth	0: -40dB	

5. Set the parameter block No.1 that is set in machine parameter.

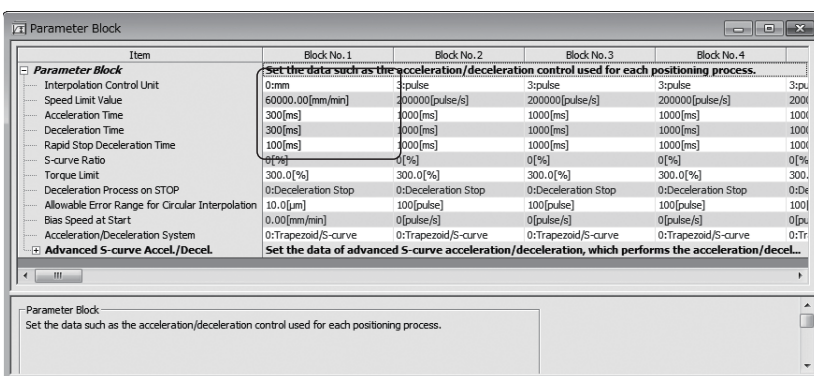

Item	Block No.1	
Parameter block	Interpolation control unit	0: mm
	Speed limit value	60000.00[mm/min]
	Acceleration time	300[ms]
	Deceleration time	300[ms]
	Rapid stop deceleration time	100[ms]

6. Set the point block setting in machine common parameter.

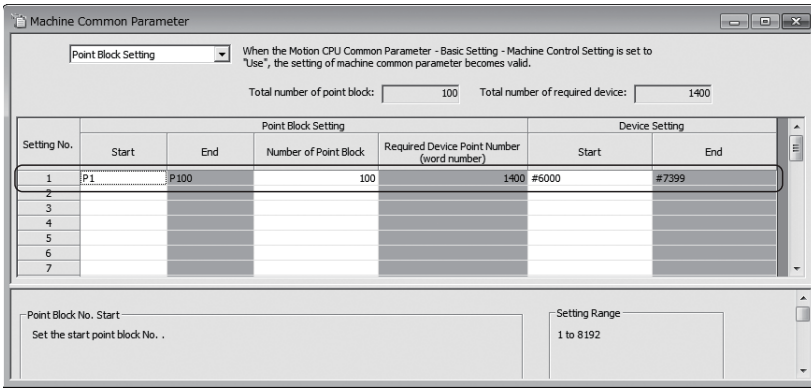

Setting No.	Point block setting				Device setting	
	Start	End	Number of point block	Required device point number (word number)	Start	End
1	P1	P100	100	1400	#6000	#7399



**7.** Create the Motion SFC program to start machine control. (Executed after home position return completion)

- Machine program operation when M100 turns ON
- Point 1: Linear interpolation(ABS), dwell time=500ms
- Point 2: Central point-specified circular interpolation(ABS, angle of arc<180°)

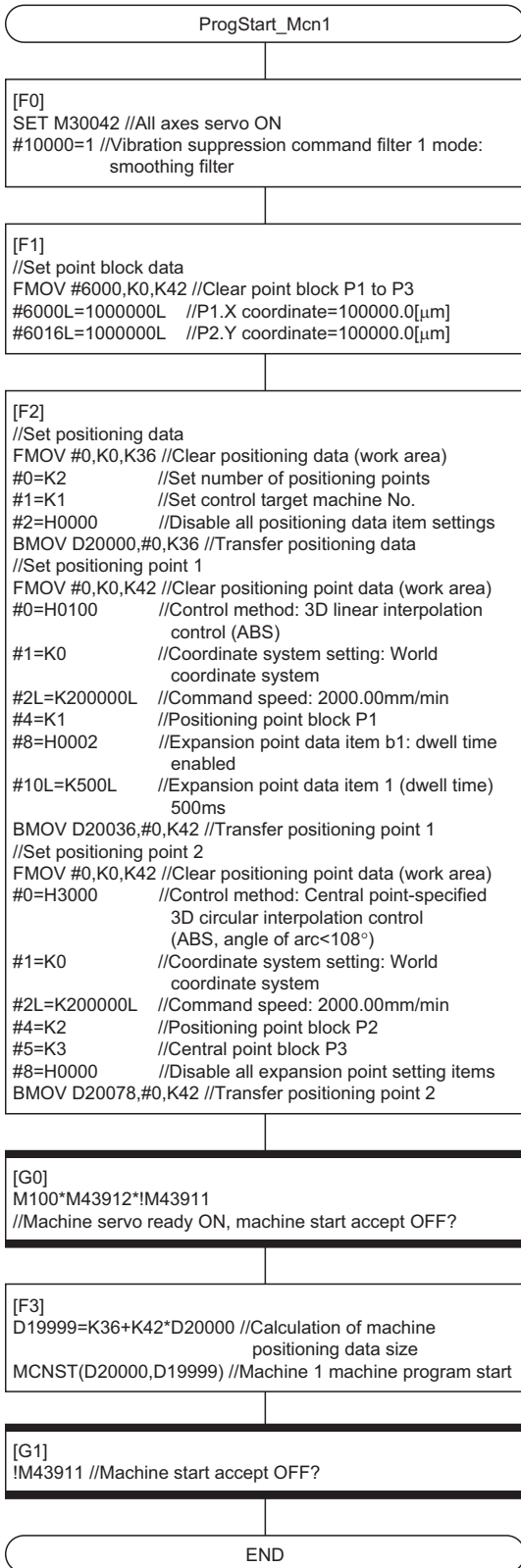

# Appendix 2 Machine Control Error Details Codes

## Machine error details codes

The details codes when a machine error is detected are shown below.

### Detailed information 1

#### ■Machine control setting data warning (warning (error code: 0EE0H)), machine control setting data incorrect (minor error (error code: 1FE0H))

The details codes for when machine control setting data warning (warning (error code: 0EE0H)), and machine control setting data incorrect(minor error (error code: 1FE0H)) are detected are shown below.

Details code	Description	Error details and cause	Corrective action
0003H	Parameter block No. outside range	The parameter block No. specification is outside the range of 1 to 64.	Set within the range of 1 to 64.
0004H	Interpolation control unit incorrect	<ul style="list-style-type: none"> <li>The control unit specified in parameter block does not match the control unit of the machine.</li> <li>The control unit of positioning data does not match the control unit of the machine.</li> </ul>	<ul style="list-style-type: none"> <li>Match the control unit specified in parameter block with the control unit of the machine.</li> <li>Match the control unit of positioning data with the control unit of the machine.</li> </ul>
0005H	Speed limit value setting outside range	The speed limit value is set outside of range.	Set the speed limit value within the range.
0006H	Acceleration time setting outside range	The acceleration time is outside the range.	Acceleration/Deceleration Time and Command torque time constant 1 Word Setting Function "2 Words Setting": <ul style="list-style-type: none"> <li>Set the acceleration time within the range of 1 to 8388608[ms].</li> </ul> Acceleration/Deceleration Time and Command torque time constant 1 Word Setting Function "1 Word Setting": <ul style="list-style-type: none"> <li>Set the acceleration time within the range of 1 to 65535[ms].</li> </ul>
0007H	Deceleration time setting outside range	The deceleration time is outside the range.	Acceleration/Deceleration Time and Command torque time constant 1 Word Setting Function "2 Words Setting": <ul style="list-style-type: none"> <li>Set the deceleration time within the range of 1 to 8388608[ms].</li> </ul> Acceleration/Deceleration Time and Command torque time constant 1 Word Setting Function "1 Word Setting": <ul style="list-style-type: none"> <li>Set the deceleration time within the range of 1 to 65535[ms].</li> </ul>
0008H	Rapid stop deceleration time setting outside range	The rapid stop deceleration time is outside the range.	Acceleration/Deceleration Time and Command torque time constant 1 Word Setting Function "2 Words Setting": <ul style="list-style-type: none"> <li>Set the rapid stop deceleration time within the range of 1 to 8388608[ms].</li> </ul> Acceleration/Deceleration Time and Command torque time constant 1 Word Setting Function "1 Word Setting": <ul style="list-style-type: none"> <li>Set the rapid stop deceleration time within the range of 1 to 65535[ms].</li> </ul>
0009H	Torque limit value at start setting outside range	The setting for torque limit value at start is outside the range of 1 to 10000[×0.1%].	Set the torque limit value within the range of 1 to 10000[×0.1%].
000BH	Circular interpolation allowable range setting outside range	The circular interpolation allowable range is outside the setting range.	Set the circular interpolation allowable range within the range.
000DH	S-curve ratio setting outside range	At S-curve acceleration/deceleration specification, the S-curve ratio is outside the range of 0 to 100[%].	Set the S-curve ratio within the range of 0 to 100[%].
0031H	Control method incorrect	A control method that cannot be used is set.	Set the correct control method.
0032H	Coordinate system specification incorrect	A coordinate system specification that cannot be used is set.	Set the correct coordinate system specification.
0033H	Command speed outside range	The command speed that is outside the range of 1 to speed limit value is set.	Set the command speed within the range of 1 to speed limit value.

Details code	Description	Error details and cause	Corrective action
0034H	Point block No. error	A point block No. that has not been assigned has been set to the point block No. of the positioning point.	Set a point block No. assigned by the point block setting of the point block No. of the positioning point.
0035H	Auxiliary point/central point block No. error	A point block No. that has not been assigned has been set to the auxiliary point/central point at circular interpolation.	Set a point block No. assigned by the point block setting of the point block No. of the auxiliary point/central point of circular interpolation.
0038H	M-code setting outside range	The M-code setting is outside the range of 0 to 32767.	Set the M-code within the range of 0 to 32767.
0039H	Dwell time setting outside range	The dwell time setting is outside the range of 0 to 5000[ms].	Set the dwell time setting within the range of 0 to 5000[ms].
003AH	Torque limit value during operation setting outside range	The torque limit value during operation setting is outside the range of 1 to 10000[×0.1%].	Set the torque limit value setting within the range of 1 to 10000[×0.1%].
003BH	Proximity pass method incorrect	A proximity pass method that cannot be used is set.	Set the correct proximity pass method.
003CH	Proximity range setting outside range	The proximity range setting is outside the range of 0 to 2147483647[interpolation control units].	Set the proximity range within the range of 0 to 2147483647[interpolation control units].
003DH	Sequential coordinate command control smoothing time constant setting outside range	The sequential coordinate command control smoothing time constant setting is outside the range of 0 to 5000[ms].	Set the sequential coordinate command control smoothing time constant within the range of 0 to 5000[ms].
003EH	WAIT-ON/OFF setting incorrect	A WAIT-ON/OFF specification that cannot be used is set.	Set the correct WAIT-ON/OFF specification.
003FH	WAIT-ON/OFF setting device outside of range	The device No. of the device set to WAIT-ON/OFF is outside the range.	Correct the program so that the device No. is within the range.
0040H	Point arrival notification setting value outside of range	Either the notification method or notification setting value set to point arrival notification is outside the range.	Correct the program so that the notification method and notification setting value are within the range.
0041H	Point arrival notification setting device outside of range	Either the device type or device No. set to point arrival notification is outside the range.	Correct the program so that the device type and device No. are within the range.
0062H	Control method/coordinate system specification combination incorrect	A coordinate system specification that cannot be used with the control method set by the positioning data is set.	Set a coordinate system specification that can be used with the control method.
0063H	Rapid stop deceleration time setting exceeds deceleration time	The rapid stop deceleration time setting is larger than the setting value of deceleration time.	Set the rapid stop deceleration time within the range of 1 to deceleration time setting value.
0064H	Auxiliary point/end point setting error (auxiliary point circular)	The address specification does not make an arc at 3D circular interpolation control with auxiliary point specification. <ul style="list-style-type: none"> <li>• Start point = auxiliary point</li> <li>• End point = auxiliary point</li> <li>• Start point = end point</li> <li>• Three points lie on a straight line</li> </ul>	Correct the point block address specified to the end point/auxiliary point.
0065H	Central point/end point setting error (central point circular)	The address specification does not make an arc at 3D circular interpolation control with central point specification. <ul style="list-style-type: none"> <li>• Start point = auxiliary point</li> <li>• End point = auxiliary point</li> <li>• Start point = end point</li> </ul>	Correct the point block address specified to the end point/central point.
0066H	Auxiliary point/central point overflow	The auxiliary point/central point of circular interpolation control is world coordinate system or base coordinate system, and the specified address is outside the range for 32-bit integer (signed).	Correct the point block address specified to the auxiliary point/central point, or the setting of the base transformation value.
0068H	Movement amount overflow	During sequential coordinate command control, the movement amount of each coordinate in one operation cycle exceeded the range for 32-bit integer (signed).	Set the data so that the movement amount of each coordinate in one operation cycle is within the range for 32-bit integer (signed).
0069H	Control method incorrect (sequential coordinate command control)	A control method that cannot be used in the next point of sequential coordinate command control is set.	Set a control method that can be used in the next point of sequential coordinate command control.
00E0H	Machine JOG operation method incorrect	A machine JOG operation method that cannot be used is set.	Set the correct machine JOG operation method.

Details code	Description	Error details and cause	Corrective action
00E1H	Machine JOG speed outside range	The set machine JOG speed is outside the range of 1 to machine JOG speed limit value.	Set the machine JOG speed within the range of 1 to machine JOG speed limit value.
00E2H	Machine JOG start command incorrect	A machine JOG operation of a coordinate axis that cannot be operated by the machine type was started.	Start a machine JOG operation of a coordinate axis that can be operated.
00F0H	Servo motor maximum speed setting outside range	The servo motor maximum speed setting is outside the range of 0 to 10000000[×0.01r/min].	Set the servo motor maximum speed setting within the range of 0 to 10000000[×0.01r/min].
00F1H	Vibration suppression command smoothing filter not set	During machine control, the vibration suppression command filter has not been set.	Set the vibration suppression command filter during machine control.
00F2H	Override ratio setting outside range	<ul style="list-style-type: none"> <li>• At the start, the value set to the override ratio setting device is outside the range of 0 to 3000[×0.1%].</li> <li>• While starting, the value after change of the override ratio setting device is outside the range of 0 to 3000[×0.1%].</li> </ul>	Set the override ratio within the range of 0 to 3000[×0.1%].
00F3H	Speed restriction value over	<ul style="list-style-type: none"> <li>• The speed of "command speed × override ratio" is outside the range of 0 to speed limit value.</li> <li>• When speed is restricted by the joint interpolation speed restriction function, the value set to the override ratio setting device is outside the range of 0 to 1000[×0.1%].</li> </ul>	<ul style="list-style-type: none"> <li>• Correct the command speed or override ratio so the speed of "command speed × override ratio" is within the range of the speed limit value.</li> <li>• When speed is restricted by the joint interpolation speed restriction function, set the override ratio within the range of 0 to 1000[×0.1%].</li> </ul>

## ■Machine control machine library error (minor error (error code: 1FE1H)), machine configuration error (moderate error (error code: 30FAH))

The details codes for when machine control machine library error (minor error(error code: 1FE1H)), and machine configuration error (moderate error(error code: 30FAH)) are detected are shown below.

Details code	Description	Error details and cause	Corrective action
0102H	Machine type setting incorrect	Machine type setting in machine basic setting is incorrect.	<ul style="list-style-type: none"> <li>Install the applicable machine library.</li> <li>Set the machine type for the installed machine library.</li> </ul>
0103H	Parameter block specification incorrect	The specification of the parameter block No. of the machine speed setting is outside the range of 1 to 64.	Set the parameter block specification within the range of 1 to 64.
0104H	Machine JOG speed limit value incorrect	The machine JOG speed limit value of the machine speed setting is outside of the range.	Set the speed limit value within the range.
0105H	Operating range type incorrect	The operating range type setting in machine basic setting is incorrect.	Set the operating range type that matches the machine type. Refer to the instruction manual of the machine library for the setting range.
0106H	Joint axis structure incorrect	The joint axis structure setting is incorrect.	Set the axis No. of machine configuration axis that matches the machine type. Refer to the instruction manual of the machine library for the setting range.
0107H	Arm length setting incorrect	The arm length setting is incorrect.	Set the arm length that matches the machine type. Refer to the instruction manual of the machine library for the setting range.
0108H	XYZ stroke limit setting incorrect	The XYZ stroke limit setting is incorrect.	Set the XYZ stroke limit that matches the machine type. Refer to the instruction manual of the machine library for the setting range.
0109H	Option setting A incorrect	The option setting A setting is incorrect.	Set option setting A that matches the machine type. Refer to the instruction manual of the machine library for the setting range.
010AH	Option setting B incorrect	The option setting B setting is incorrect.	Set option setting B that matches the machine type. Refer to the instruction manual of the machine library for the setting range.
010BH	Unit setting incorrect	The unit setting of machine configuration axis is incorrect.	Set the unit of machine configuration axis that matches the machine type. Refer to the instruction manual of the machine library for the setting range.
010CH	Stroke limit upper value/lower value incorrect	The stroke limit upper value/lower value of machine configuration axis is incorrect.	Set the stroke limit upper value/lower value of machine configuration axis that matches the machine type. Refer to the instruction manual of the machine library for the setting range.
0201H	Base transformation value setting outside range	The base transformation value setting is incorrect.	Set the base transformation value that matches the machine type. Refer to the instruction manual of the machine library for the setting range.
0301H	Tool transformation value setting outside range	The tool transformation value setting is incorrect.	Set the tool transformation value that matches the machine type. Refer to the instruction manual of the machine library for the setting range.
0501H	End point incorrect (singularity)	At the end point, singularity of the machine is set.	Correct the address of the point block being specified to the end point.
0502H	Operating outside range	<ul style="list-style-type: none"> <li>At the end point, a machine operating outside of range is set.</li> <li>During control, the movement trajectory of the machine is outside the operating range.</li> <li>There is a singularity during machine JOG operation control with tool coordinate system specified.</li> <li>The feed current value (world coordinate system) overflowed (outside the range for 32-bit integer (signed)) during machine JOG operation control with tool coordinate system specified.</li> </ul>	Perform positioning within the operating range.
0601H	Attitude flag incorrect	In linear interpolation, circular interpolation, or sequential coordinate command, the current attitude differs to the attitude of the positioning point block.	When positioning to an attitude that differs from the current attitude, use joint interpolation.
0603H	End point overflow	The point block specified in the positioning point is world coordinate system, base coordinate system, or tool coordinate system, and the specified address is outside the range for 32-bit integer (signed).	Correct the address of the point block specified in the positioning point, or correct the base translation value setting.

Details code	Description	Error details and cause	Corrective action
0604H	Address outside range	The address or movement amount of the point block specified in the positioning point is outside the setting range.	Set the address or movement amount of the point block that matches the machine type. Refer to the instruction manual of the machine library for the setting range.
0A01H to 0D00H	Error inherent to machine type	Settings inherent to machine are incorrect.	Refer to the instruction manual of the machine library.
0D01H	iQ Monozukuri license not authenticated	An iQ Monozukuri dedicated machine library was used without license authentication of the iQ Monozukuri application package.	Authenticate the iQ Monozukuri license. (Refer to the instruction manual of iQ Monozukuri for license authentication.)

# Appendix 3 Machine Control Event Details Codes

## Machine event details codes

The details codes when a machine event is detected are shown below.

### Detailed information 1

#### ■Machine control system information (information (event code: 07FB))

The details codes for when machine control system information (information (event code: 07FB)) are detected are shown below.

Details code	Description	Details
0001H	Override ratio "0"	At the start, the override ratio was set to "0". During control, the override ratio was updated to "0".

# REVISIONS

\* The manual number is given on the bottom left of the back cover

Revision date	*Manual number	Description
February 2016	IB(NA)-0300309-A	First edition
June 2016	IB(NA)-0300309-B	<ul style="list-style-type: none"> <li>■ Added functions</li> <li>Sequential coordinate command control</li> <li>■ Added or modified parts</li> <li>SAFETY PRECAUTIONS, INTRODUCTION, Section 1.2, 4.1, 4.2, 6.1, 7.2, 9.1, 9.3, Appendix 2</li> </ul>
September 2016	IB(NA)-0300309-C	<ul style="list-style-type: none"> <li>■ Added or modified parts</li> <li>TERMS, Section 1.2, 2.2, 4.1, 4.2, 5.2, 9.2, 9.3</li> </ul>
December 2016	IB(NA)-0300309-D	<ul style="list-style-type: none"> <li>■ Added or modified parts</li> <li>SAFETY PRECAUTIONS, Section 1.2, 6.1, Appendix 1</li> </ul>
December 2017	IB(NA)-0300309-E	<ul style="list-style-type: none"> <li>■ Added or modified parts</li> <li>SAFETY PRECAUTIONS, RELEVANT MANUALS, MANUAL PAGE ORGANIZATION, Section 3.1, Chapter 4, Section 4.1, 4.2, 7.2, Appendix 1, 2, 3</li> </ul>
June 2018	IB(NA)-0300309-F	<ul style="list-style-type: none"> <li>■ Added functions</li> <li>Point arrival notification, WAIT-ON/OFF</li> <li>■ Added or modified parts</li> <li>SAFETY PRECAUTIONS, Section 1.2, 4.1, 4.2, 6.1, 9.5, 9.6, Appendix 2</li> </ul>
December 2018	IB(NA)-0300309-G	<ul style="list-style-type: none"> <li>■ Added or modified parts</li> <li>SAFETY PRECAUTIONS, Section 7.2, 9.2</li> </ul>
February 2020	IB(NA)-0300309-H	<ul style="list-style-type: none"> <li>■ Added or modified parts</li> <li>Section 8.3</li> </ul>
June 2023	IB(NA)-0300309-J	<ul style="list-style-type: none"> <li>■ Added or modified parts</li> <li>SAFETY PRECAUTIONS, CONDITIONS OF USE FOR THE PRODUCT, TERMS, Section 1.2, 2.3, 4.1, 4.2, 6.1, 7.2, 8.3, Appendix 2</li> </ul>

Japanese manual number: IB-0300308-J

This manual confers no industrial property rights of any other kind, nor does it confer any patent licenses. Mitsubishi Electric Corporation cannot be held responsible for any problems involving industrial property rights which may occur as a result of using the contents noted in this manual.

©2016 MITSUBISHI ELECTRIC CORPORATION



# WARRANTY

---

Please confirm the following product warranty details before using this product.

## **1. Gratis Warranty Term and Gratis Warranty Range**

If any faults or defects (hereinafter "Failure") found to be the responsibility of Mitsubishi occurs during use of the product within the gratis warranty term, the product shall be repaired at no cost via the sales representative or Mitsubishi Service Company.

However, if repairs are required onsite at domestic or overseas location, expenses to send an engineer will be solely at the customer's discretion. Mitsubishi shall not be held responsible for any re-commissioning, maintenance, or testing on-site that involves replacement of the failed module.

[Gratis Warranty Term]

The gratis warranty term of the product shall be for one year after the date of purchase or delivery to a designated place. Note that after manufacture and shipment from Mitsubishi, the maximum distribution period shall be six (6) months, and the longest gratis warranty term after manufacturing shall be eighteen (18) months. The gratis warranty term of repair parts shall not exceed the gratis warranty term before repairs.

[Gratis Warranty Range]

- (1) The range shall be limited to normal use within the usage state, usage methods and usage environment, etc., which follow the conditions and precautions, etc., given in the instruction manual, user's manual and caution labels on the product.
- (2) Even within the gratis warranty term, repairs shall be charged for in the following cases.
  1. Failure occurring from inappropriate storage or handling, carelessness or negligence by the user. Failure caused by the user's hardware or software design.
  2. Failure caused by unapproved modifications, etc., to the product by the user.
  3. When the Mitsubishi product is assembled into a user's device, Failure that could have been avoided if functions or structures, judged as necessary in the legal safety measures the user's device is subject to or as necessary by industry standards, had been provided.
  4. Failure that could have been avoided if consumable parts (battery, backlight, fuse, etc.) designated in the instruction manual had been correctly serviced or replaced.
  5. Failure caused by external irresistible forces such as fires or abnormal voltages, and Failure caused by force majeure such as earthquakes, lightning, wind and water damage.
  6. Failure caused by reasons unpredictable by scientific technology standards at time of shipment from Mitsubishi.
  7. Any other failure found not to be the responsibility of Mitsubishi or that admitted not to be so by the user.

## **2. Onerous repair term after discontinuation of production**

- (1) Mitsubishi shall accept onerous product repairs for seven (7) years after production of the product is discontinued. Discontinuation of production shall be notified with Mitsubishi Technical Bulletins, etc.
- (2) Product supply (including repair parts) is not available after production is discontinued.

## **3. Overseas service**

Overseas, repairs shall be accepted by Mitsubishi's local overseas FA Center. Note that the repair conditions at each FA Center may differ.

## **4. Exclusion of loss in opportunity and secondary loss from warranty liability**

Regardless of the gratis warranty term, Mitsubishi shall not be liable for compensation to:

- (1) Damages caused by any cause found not to be the responsibility of Mitsubishi.
- (2) Loss in opportunity, lost profits incurred to the user by Failures of Mitsubishi products.
- (3) Special damages and secondary damages whether foreseeable or not, compensation for accidents, and compensation for damages to products other than Mitsubishi products.
- (4) Replacement by the user, maintenance of on-site equipment, start-up test run and other tasks.

## **5. Changes in product specifications**

The specifications given in the catalogs, manuals or technical documents are subject to change without prior notice.

# TRADEMARKS

---

Microsoft, Microsoft Access, Excel, SQL Server, Visual Basic, Visual C++, Visual Studio, Windows, Windows NT, Windows Server, Windows Vista, and Windows XP are either registered trademarks or trademarks of Microsoft Corporation in the United States and/or other countries.

The company names, system names and product names mentioned in this manual are either registered trademarks or trademarks of their respective companies.

In some cases, trademark symbols such as <sup>™</sup> or <sup>®</sup> are not specified in this manual.



IB(NA)-0300309-J(2306)MEE

MODEL: RMT-P-MCN-E

MODEL CODE: 1XB024

## **MITSUBISHI ELECTRIC CORPORATION**

HEAD OFFICE: TOKYO BLDG., 2-7-3, MARUNOUCHI, CHIYODA-KU, TOKYO 100-8310, JAPAN  
NAGOYA WORKS: 1-14, YADA-MINAMI 5-CHOME, HIGASHI-KU, NAGOYA 461-8670, JAPAN

When exported from Japan, this manual does not require application to the  
Ministry of Economy, Trade and Industry for service transaction permission.

Specifications subject to change without notice.