

PLC Positioning

This course is for participants who will configure a positioning control system for the first time.

Introduction Purpose of the Course

This course is intended for users who will configure a positioning control system for the first time. By taking this course, a participant will learn the basics of the MELSEC-Q Series positioning module and will obtain the necessary knowledge to configure a simple positioning control system.

The contents of this course are as follows.
We recommend that you start from Chapter 1.

Chapter 1 - Understanding the Positioning Module "QD75"

Learn the basics of the positioning module "QD75" and terms and knowledge that you will need to use the positioning module.

Chapter 2 - System Configuration

Learn about the typical system configuration procedure and the control method and machine specification of the sample system.

Chapter 3 - Preparation for Positioning Parameters

Learn how to set positioning parameters.

Chapter 4 - Positioning Data Preparation

Learn how to set positioning data.

Chapter 5 - Sequence Program Preparation

Learn how to execute positioning data using a sequence program.

Chapter 6 - Test Operation of System

Learn about test operation performed before actual operation.

Chapter 7 - Bringing System into Service





Learn about troubleshooting and operation confirmation methods using monitors.

Final Test

Passing grade: 60% or higher.

Introduction How to Use This e-Learning Tool



Go to the next page		Go to the next page.
Back to the previous page		Back to the previous page.
Move to the desired page		"Table of Contents" will be displayed, enabling you to navigate to the desired page.
Exit the learning		Exit the learning. Window such as "Contents" screen and the learning will be closed.

Safety precautions

When you learn by using actual products, please carefully read the safety precautions in the corresponding manuals.

Precautions in this course

- The displayed screens of the software version that you use may differ from those in this course.

This course uses the following software version:

- GX Works2 Version 1.493P

Chapter 1 Understanding the Positioning Module "QD75"

This course explains how to configure a positioning control system based on the MELSEC-Q series programmable controller positioning module.

In Chapter 1, you will learn the features and functionality of the QD75 positioning module. The basic terms and knowledge required for handling the positioning module are also given in this chapter.

- 1.1 Positioning Module "QD75" Features and Functionality
- 1.2 Positioning Module "QD75" Lineup
- 1.3 Positioning Module "QD75"
- 1.4 Positioning Control System Basic Configuration
- 1.5 Connecting the Positioning Module "QD75" to a Servo Amplifier
- 1.6 Number of Control Axes
- 1.7 Current Feed Value and Machine Feed Value
- 1.8 Positioning Module "QD75" Setting Method
- 1.9 Summary

1.1

Positioning Module "QD75" Features and Functionality

Suppose you build a system which incorporates a positioning control function, that system, in most cases, will need more than a simple positioning control.

Look at the material handling system shown in the diagram below.

This system which categorizes the boxes proportional to its size and distributes them to the correct conveyor. This type of system cannot be easily realized just by using a standard control system. A dedicated positioning system which synchronizes the proximity sensor inputs and determines the box sizes are required, in addition to the central control system.

The positioning module "QD75" used in this course is an intelligent function module which is part of programmable controller system.

It has special features to ensure synchronization between the sequence program and positioning.

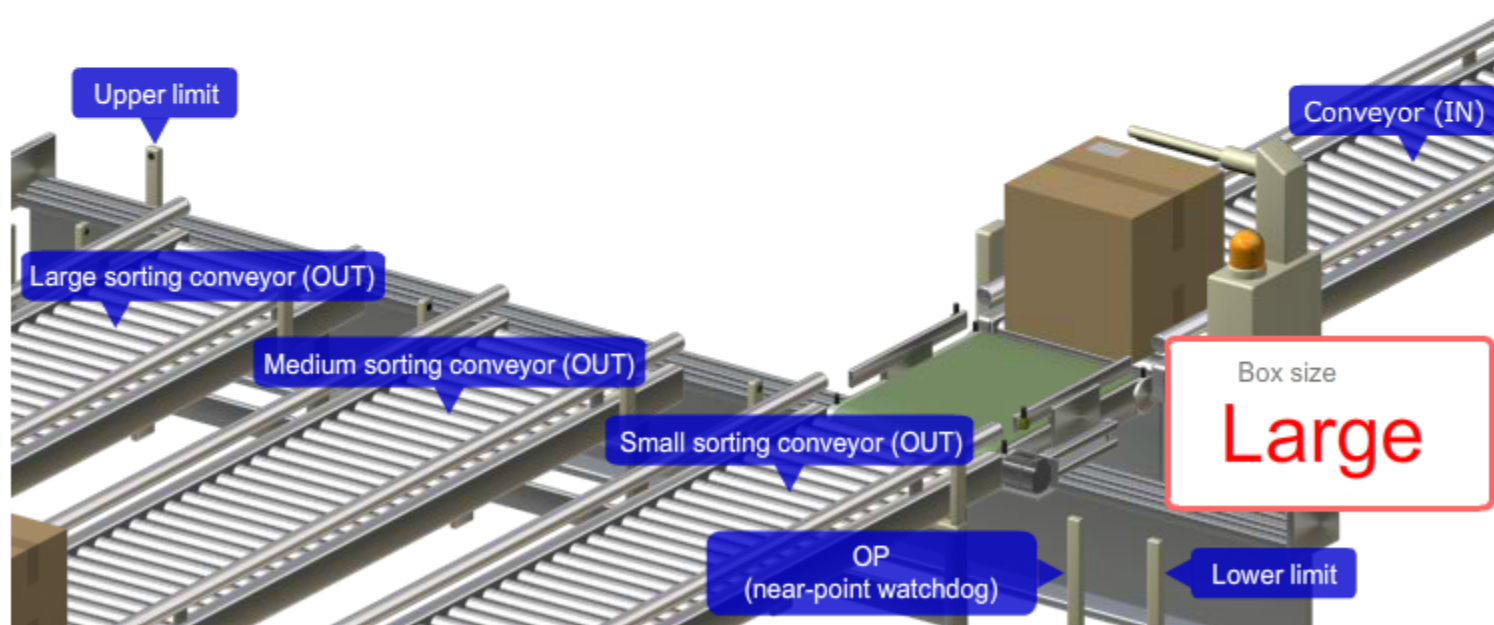

The table below shows the positioning module "QD75" series lineup and features.

Positioning module "QD75" series list

	QD75P	QD75D	QD75M	QD75MH
Interface	General-purpose interface	General-purpose interface	SSCNET interface	SSCNETIII/H interface
	Open collector	Differential driver		
Connection with 3rd party servo amplifiers	Yes	Yes	No	No
Wiring	Extensive	Extensive	Easy	Easy
Communication with servo	Yes	Yes	No	No
Distance between servo and QD75	2m	10m	30m	50m
Speed	Low	Low	Medium	High
Noise immunity	Standard	Good	Good	Excellent

This course uses a differential driver type "QD75D", which has a general-purpose interface, is compatible with 3rd party servo amplifiers, and good immunity to noise.

1.3 Positioning Module "QD75"

This section explains the names and functions of the positioning module's components.
The "QD75D1N" is used as an example in this course.
It is an intelligent function module which controls one servo amplifier-motor axis.

Component names and functionality

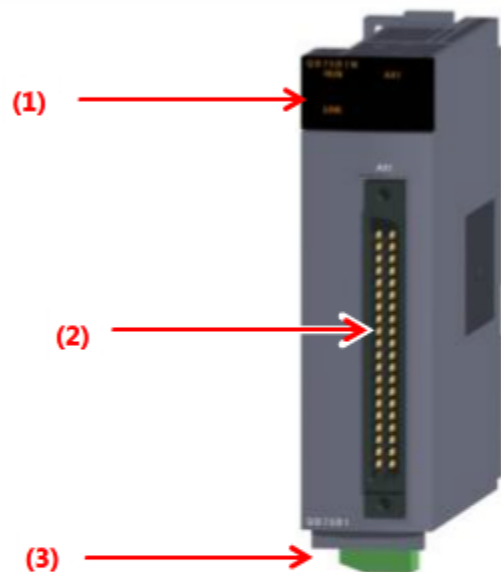

No.	Name	Function
(1)	LED indicator	The operating state of the positioning module is displayed.
(2)	External connector	Connector for establishing a connection with a servo amplifier, mechanical-system input, or manual pulse generator.
(3)	Differential driver common terminal	For connection to the servo amplifiers differential receiver common terminal. Used in applications where a potential difference occurs between the common terminal on the differential driver and one on the servo amplifier-side differential receiver.

1.4

Positioning Control System Basic Configuration

Shown here is the basic configuration of a positioning control system using the positioning module and a servo control system (amplifier + motor).

Device names and functionality

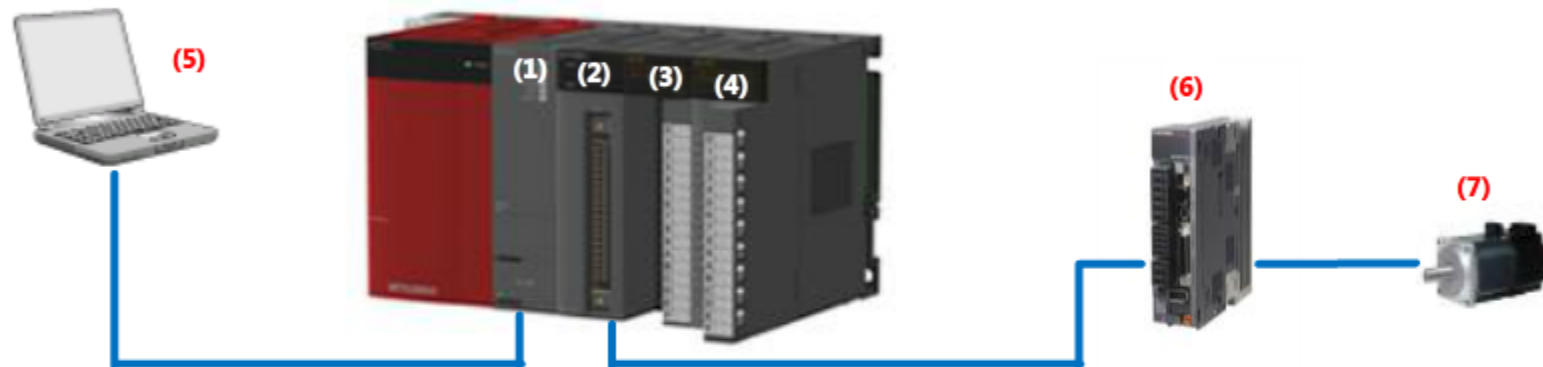

No.	Component devices	Model name	Role
(1)	CPU module	Q06UDHCPU	Controls the positioning module via a sequence programs.
(2)	Positioning module	QD75D1N	Based on parameter and positioning data, output commands are sent to the corresponding servo amplifier.
(3)	Input module	QX40	Input signal from an external device to the CPU module.
(4)	Output module	QY40P	Output signal from the CPU module to an external device.
(5)	Personal computer	-	Used for setting the positioning data via GX Works2.
(6)	Servo amplifier	MR-J4-10A	Drives a servo motor upon receiving command pulses from the positioning module.
(7)	Servo motor	HG-KR053	Moves the carriage along the rails.

1.5

Connecting the Positioning Module "QD75" to a Servo Amplifier

In this course, the positioning module "QD75D" is connected to a servo amplifier via the differential driver interface. The "QD75D" is versatile enough to be connected to 3rd party servo amplifiers. It also has the advantage of being immune to noise, compared with an open collector output.

For more information about the connecting method, check the corresponding manual of the positioning module and servo amplifier.

Connection between the positioning module "QD75D" and servo amplifier

Positioning Module



Servo amplifier



Servo motor



Command pulse output



Differential driver
(General-purpose interface)



1.6

Number of Control Axes

Number of controlled axes represents the number of servo motors that can be driven by the positioning module. It is expressed in axes per module.

In this course, "QD75D1N", which controls "one axis", is used.

The "QD75D" lineup consists of modules which are capable of controlling one axis, 2 axes or 4 axes.

QD75D1N: Single-axis control (one serve motor)

Positioning module



Servo amplifier **Axis No.1**



Servo motor



QD75D2N: 2-axes control (2 serve motors)

Positioning module



Servo amplifier **Axis No.1**



Axis No.1

Servo motor



Servo amplifier **Axis No.2**



Axis No.2

Servo motor



The positioning module retains the current value (address) of the workpiece at any time. Current values retained are of the following two types.

Current feed value	Uses an address established upon "machine original position return (machine OPR)" as the reference. Performing the present value change function results in an address change.
Machine feed value	Uses an address established upon "machine OPR" as the reference at all times. Changing a current value does not allow you to change the address.

Machine OPR: An operation to establish an original position (OP) address. More detail is given in Section 6.3.

Present value change: A function which allows the user to change the present value.

1.8

Positioning Module "QD75" Setting Method

To perform a positioning control, it is necessary to set a variety of parameters/data in the positioning module.

Module settings can be made from the following:

- From the positioning parameters in the engineering software "GX Works2".
- Directly from the sequence program using a positioning module-dedicated instruction.

In this course, you will learn the method based on "GX Works2".

GX Works2 has the following features:

- Parameter/data setting function with a user interface.
- Test operation function that runs when desired (manual operation, machine OPR, and positioning test) .
- State of operation and conditions at the occurrence of an error can be monitored.
- Sequence program comes in a simplified form (programming time is reduced) .

Item	
Basic parameters 1	
Unit setting	0:mm
No. of pulses per rotation	20000 pulse
Movement amount per rotation	2000.0 um
Unit magnification	1:x1 Times
Pulse output mode	1: CW/CCW Mode
Rotation direction setting	0: Increase Present Value by Forward
Bias speed at start	0.00 mm/min
Basic parameters 2	
Speed limit value	2000.00 mm/min
Acceleration time 0	1000 ms
Deceleration time 0	1000 ms

Positioning parameter setting area

In this chapter, you have learned:

- Positioning module "QD75" features and functionality
- Positioning module "QD75" lineup
- Positioning module "QD75"
- Positioning control system basic configuration
- Connecting the positioning module "QD75" to a servo amplifier
- Number of control axes
- Current feed value and machine feed value
- Positioning module "QD75" setting method

Important points

The roles and functions of the positioning module	You have learned the important points in choosing a programmable controller's positioning module and relationship between a programmable controller and the positioning module.
The lineup and specifications/functions of the positioning module	You have learned the basic system configuration and the role of each component.
The principal terms of the positioning control	You have learned the principal terms relating to the positioning control.

Chapter 2 System Configuration

In Chapter 2, you will learn how to configure an example system (the procedure from designing the system to placing it in operation) .

2.1 System Configuration Procedure

2.2 System Configuration

2.3 Mechanical Specifications/Functionality of Sample System

2.4 Summary

2.1

System Configuration Procedure

The following figure shows the steps used to configure an example system.

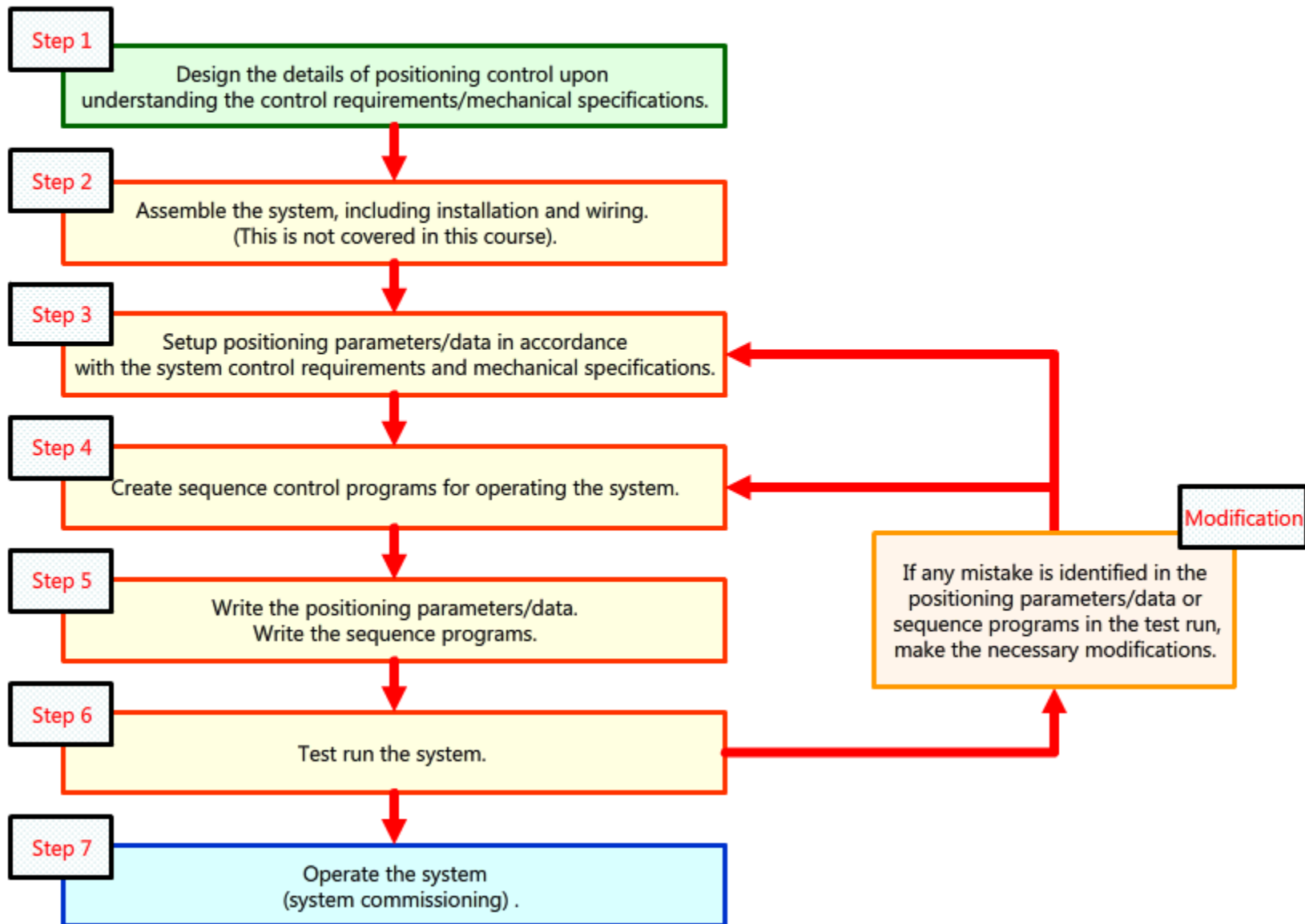

2.2

System Configuration

In this course, a material handling system is used to understand positioning control featuring the positioning module.

The example material handling system is a system which:

- 1) classifies boxes received along a conveyor into three group sizes - large, medium, & small, and
- 2) uses a sliding conveyor to distribute the boxes according to their size to the specific outgoing lanes.

In the system, positioning control is used to control the speed and movement accuracy (start/stop) of the sliding conveyor.

See the animation below and understand how the control is exercised in the sample baggage handling system.



Click the "Back" or "Next" button to have the control proceed forward or backward while checking each action.

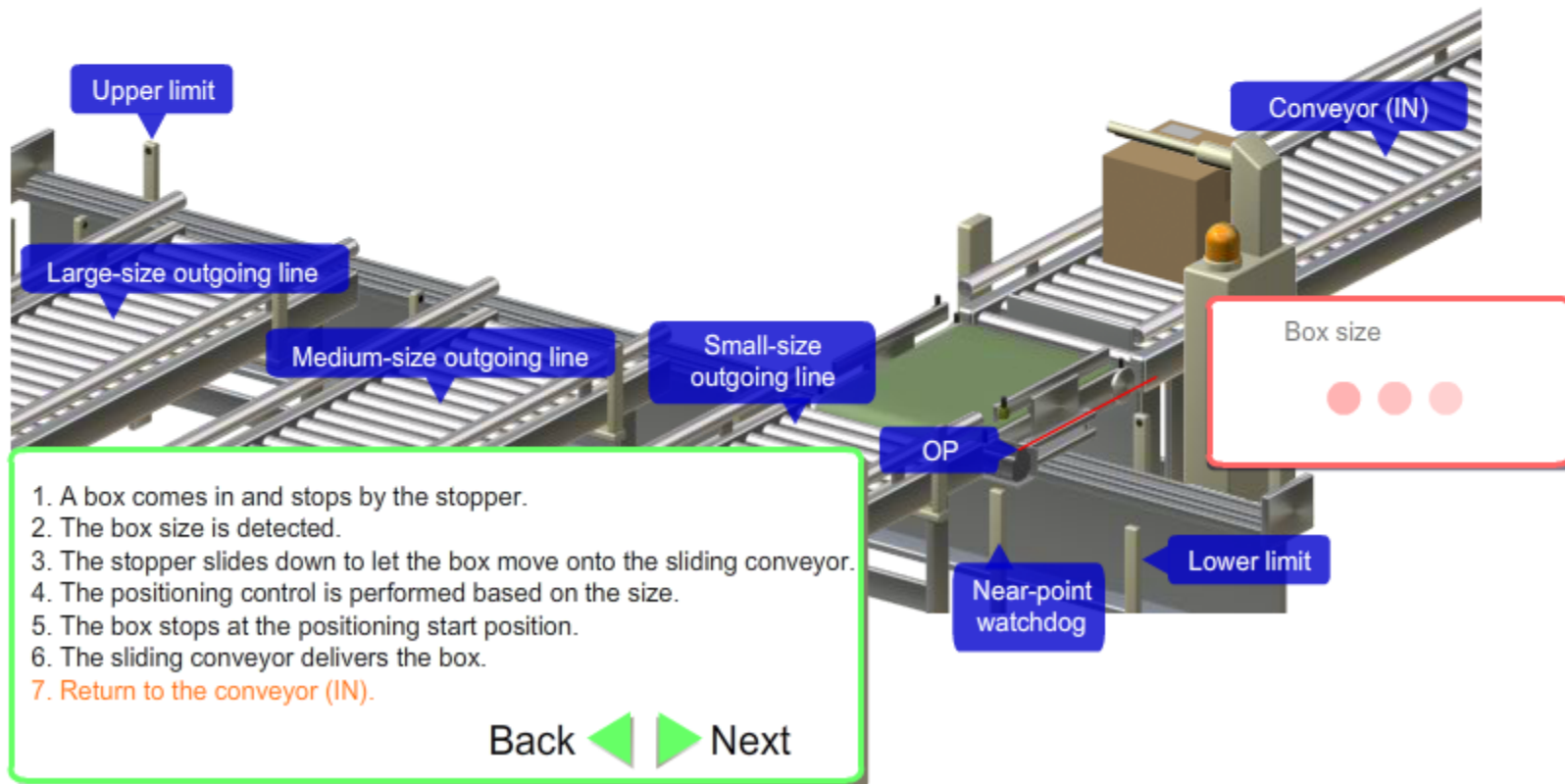

Prior to designing the positioning control, it is imperative to understand the mechanical specifications/performance of the system.

Shown below are the mechanical specifications of the example material handling system and the specifications/performance each device.

Mechanical specifications of the material handling system

Device name	Mechanical specifications		Description
Transfer conveyors	Machine's OP	0 mm (0 μm)	Reference position for positioning control
	Position of incoming line	500 mm (500,000 μm)	All values are distances from the machine's OP.
	Position of small-size outgoing line	500 mm (500,000 μm)	
	Position of medium-size outgoing line	1,500 mm (1,500,000 μm)	
	Position of large-size outgoing line	2,500 mm (2,500,000 μm)	
Sliding conveyor (workpiece)	Servo motor— Movement amount per rotation	250 mm (250,000 μm)	-
	Speed limit	60,000 mm/min	Applicable to all types of positioning control
	Moving speed	60,000 mm/min	
	Acceleration/deceleration time	1,000 ms	

Specifications/Performance of devices used in the material handling system

Device name	Type name	Description
Positioning module	QD75D1N	Number of controlled axes: 1 Connection with servo amplifier: Differential driver output
Servo amplifier	MR-J4-10A	MR-J4-A series
Servo motor	HG-KR053	Rated output capacity: 50 W Rated speed of rotation: 3,000 r/min Encoder resolution: 4,194,304 pulses/rev

In this chapter, you have learned:

- System Configuration Procedure
- System Configuration
- Mechanical Specifications/Functionality of Sample System

Important points

Procedure for configuring a system	You have learned a generally-applicable procedure for configuring a system.
How control is exercised in the system	You have learned how the sample material handling system works.
Mechanical specifications of the system, specifications/performance of the system's devices	You have learned the mechanical specifications of the sample system and the specifications/performance of the devices.

Chapter 3 Preparation for Positioning Parameters

In Chapter 3, you will learn how to make parameter settings which are required to operate the positioning module.

3.1 Setup of Positioning Parameters

3.2 Setup of the Servo Amplifier

3.3 Summary

Type of parameters		Parameters used for the sample system
Positioning parameters	Basic parameter 1	<ul style="list-style-type: none"> • Unit settings • Number of pulses per rotation • Movement amount per rotation • Unit magnification • Pulse output mode • Rotating direction settings
	Basic parameter 2	<ul style="list-style-type: none"> • Speed limit • Acceleration time: 0 • Deceleration time: 0
	Detailed parameter 1	<ul style="list-style-type: none"> • Software stroke limit, upper limit • Software stroke limit, lower limit • Software stroke limit selection • Software stroke limit, valid/invalid settings • Output signal logic selection

3.1 Setup of Positioning Parameters

The positioning parameters are required for the operation of the positioning module. Any mistakes can result in the controlled equipment to behave out of scope, or for the actual module to become inoperative.

Positioning parameters structure

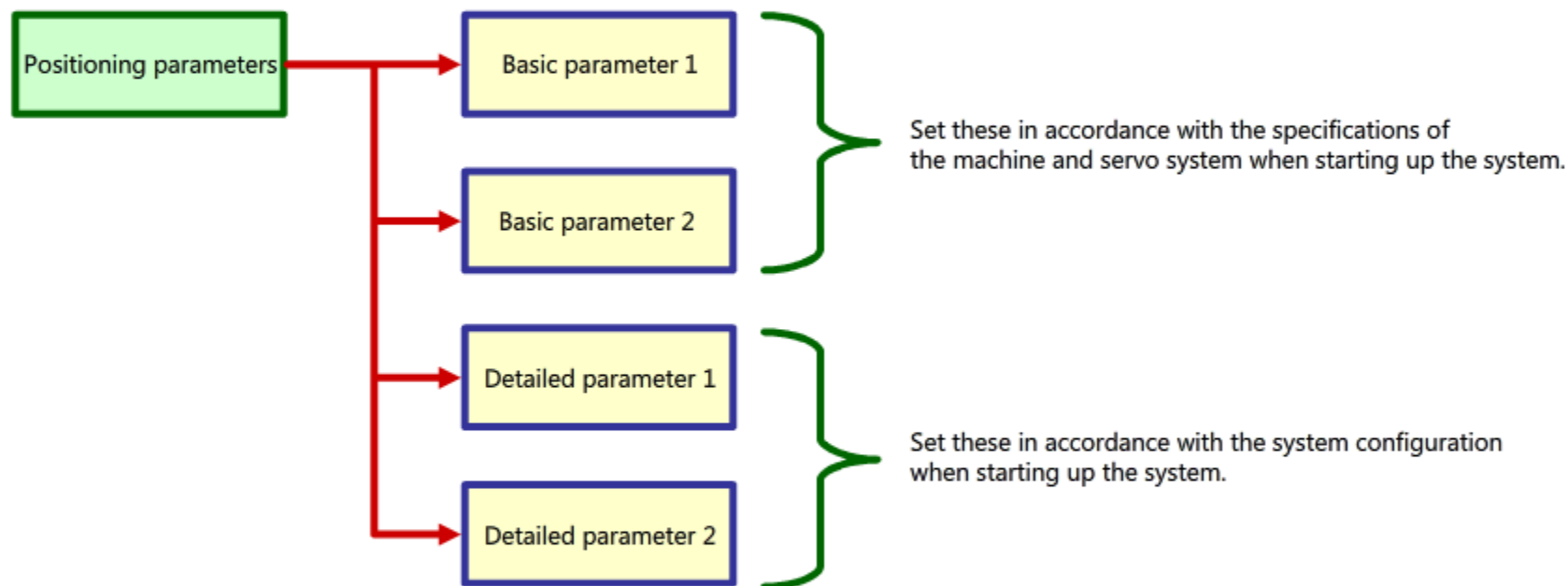

3.1.1 Positioning parameter setting

Set the positioning parameters in GX Works2.

To set parameters and data in GX Works2, first add the positioning module by selecting "Project" - "Intelligent Function Module".

When adding a module, specify its description and module name, and location on the base unit.

New Module

Module Selection

Module Type: QD75 Type Positioning Module

Module Name: QD75D1N

Mount Position

Base No.: - Mounted Slot No.: 0 Acknowledge I/O Assignment

Specify start XY address: 0000 (H) 1 Slot Occupy [32 points]

Title setting

Title:

OK Cancel

New Module window

3.1.1 Positioning parameter setting

To open the positioning parameter setting window, launch GX Works2 and select "Project" - "Intelligent Function Module" - "QD75D1N" - "Parameter".

Project

- Parameter
- Intelligent Function Module
 - 0000:QD75D1N
 - Parameter
 - Positioning_Axis_#1_Data
 - Stop_Axis_#1_Block_Data
- Global
- Project
- Parameter
- Device Memory
- Device Initial Value

Double clicking "Parameter" opens the window shown right.

Display Filter: Display All

Item	Axis #1
Basic parameters 1	Set according to the machine and applicable motor when system is started (This parameter become valid when the PLC READY signal [Y0] turns from 0 to 1)
Unit setting	3:pulse
No. of pulses per rotation	20000 pulse
Movement amount per rotation	20000 pulse
Unit magnification	1:x1 Times
Pulse output mode	1: CW/CCW Mode
Rotation direction setting	0: Increase Present Value by Forward Pulse Output
Bias speed at start	0 pulse/s
Basic parameters 2	Set according to the machine and applicable motor when system is started (This parameter become valid when the PLC READY signal [Y0] turns from 0 to 1)
Speed limit value	200000 pulse/s
Acceleration time 0	1000 ms
Deceleration time 0	1000 ms
Detailed parameters 1	Set according to the system configuration when the system is started up. (This parameter become valid when the PLC READY signal [Y0] turns from 0 to 1)
Backlash compensation amount	0 pulse
Software stroke limit upper limit value	2147483647 pulse
Software stroke limit lower limit	-2147483648 pulse

Positioning parameter setting area

3.1.2

Setting command unit for positioning module



Forward

For the operation of the positioning module, the unit of measurement must also be set for the positioning address (movement amount), speed, and time.

Select a unit of measurement from among mm, inch, degree, and pulse according to the machine specifications. In general, mm or inch is used for linear or circular control while degree is used for rotary control. The parameter input unit and input range vary with the unit settings.

Item	Axis #1
Basic parameters 1	Set according to the machine and applicable motor when system is started up. (This parameter become valid when the PLC READY signal [Y0] turns from OFF to ON)
Unit setting	0:mm
No. of pulses per rotation	65535 pulse
Movement amount per rotation	2500.0 μ m
Unit magnification	100:x100 Times

Positioning parameter setting area

For the sample material handling system, the unit "mm" is used (used since the system's mechanical design stage).

Selecting "mm" changes the units to the following set values as shown below.

Item	Set value unit
Address (moving amount)	μ m (micrometer)
Time	ms (millisecond)
Speed	mm/min (millimeter/minute)

When the unit setting is "mm", the unit for address input (moving amount) is " μ m".

If "mm" was being used in the design stage, the value must be converted into " μ m" (1 mm = 1,000 μ m).

3.1.3

Electronic gear function settings for positioning module

The electronic gear function converts address (moving amount) and speed settings made in mm, inch, etc. into a number of command pulses or command pulse frequency to the servo amplifier.

The electronic gear function eliminates the need for the user to convert the value to a number of pulses before delivering a command.

This function also corrects errors in the stop position, adjusts the unit in which the moving amount is expressed, etc.

To ensure correct operation of the electronic gear function, enter appropriate values in the following:

- Number of pulses per rotation
- Moving amount per rotation
- Unit magnification

The relationship between setting items and the electronic gear is given by the following equation:

$$\text{Electronic gear} = \text{number of pulses per rotation} / (\text{movement amount per rotation} \times \text{unit magnification})$$

NOTE:

The servo amplifier is equipped with an electronic gear.

An electronic gear in the servo amplifier operates differently from the one in the positioning module.

Therefore, it is important not to be confused between the two technologies. Further information of the electronic gear in the servo amplifier is contained in the "FA Equipment for Beginners (Positioning) Course".

3.1.3

Electronic gear function settings for positioning module

This section explains parameters for the electronic gear function.

(1) Number of pulses per rotation

Set the number of command pulses required for the servo motor to complete one rotation.

Normally, set a resolution value of the encoder contained within the servo motor. For the sample material handling system, set the maximum selectable value ("65,535 pulses/rev") of QD75D1N since QD75D1N cannot output the encoder resolution of the servo motor.

(2) Movement amount per rotation

Set the amount by which the workpiece moves by one rotation of the servo motor.

The amount varies depending on the mechanical linkage (cam, belt, chain, ball screw, etc) between the servo motor and the workpiece. In the sample material handling system, the sliding conveyor moves "250,000 μm (250 mm)" in one rotation of the servo motor. However, the maximum moving amount for QD75D1N is "6,553.5 μm (6.5535 mm)" with the unit ("mm"). If the moving amount exceeds the maximum selectable value, just like this sample system, adjust using the unit magnification as explained below.

(3) Unit magnification

Use the unit magnification if the movement amount per rotation exceeds the maximum selectable value. The value is converted by the following equation before it is sent to the servo amplifier.

$$\text{Actual moving amount of the workpiece per motor rotation} = \text{"specified moving amount"} \times \text{"unit magnification (1 time, 10 times, 100 times, or 1000 times)"}$$

Because the moving amount for the sample material handling system exceeds the maximum selectable value of "250,000 μm (250 mm)", set "2,500 μm ", which is equal to one-hundredth of the actual movement amount, and specify " $\times 100$ (100 times)" as the unit magnification.

Item	Axis #1
<input type="checkbox"/> Basic parameters 1	Set according to the machine and applicable motor when system is s (This parameter become valid when the PLC READY signal [Y0] turns
Unit setting	0:mm
No. of pulses per rotation	65535 pulse
Movement amount per rotation	2500.0 μm
Unit magnification	100: $\times 100$ Times

(1)

(2)

(3)

3.1.4 Making settings conforming to servo system specification

This section explains about parameters to be set in accordance with the specification of the servo system.

(1) Pulse output mode

Set a signaling method for command pulse and rotation direction so that they correspond to the connected servo amplifier. For the sample system, "CW/CCW Mode" is used.

Unit magnification	100:x100 Times
Pulse output mode	1: CW/CCW Mode
Rotation direction setting	0: Increase Present Value by Fo
Bias speed at start	0.00 mm/min

Positioning parameter setting area

Mode	Characteristic	Pulse (with negative logic* being used)
PULSE/SIGN	On- or Off-state of direction sign (SIGN), independently of command pulse (PULSE), controls the direction of rotation.	<p>Moving in "+" direction Moving in "-" direction</p>
CW/CCW	Command pulse is outputted for each direction of rotation. <ul style="list-style-type: none"> Forward rotation Output feed pulse (PULSE F) for forward rotation Reverse rotation Output feed pulse (PULSE R) for reverse rotation 	
A Phase/ B Phase (4 Multiply)	Rotation direction is controlled by a phase difference between A-phase (Aφ) and B-phase (Bφ). <ul style="list-style-type: none"> Forward rotation when B-phase is 90° behind A-phase. Reverse rotation when B-phase is 90° ahead of A-phase. 	Forward rotation Reverse rotation Command 1 pulse output Command 1 pulse output <p>B-phase is 90° behind A-phase. A-phase is 90° behind B-phase.</p>
A Phase/ B Phase (1 Multiply)	Multiple setting (4 Multiply/1 Multiply) <ul style="list-style-type: none"> 4 Multiply : When the command 1 pulse output is 1 pulse/s, the pulse rises and falls 4x per second. 1 Multiply : When the command 1 pulse output is 1 pulse/s, the pulse rises and falls each second. 	

* Positive or negative logic can be set for output signals. For details of the positive and negative logics, refer to the next page.

3.1.4 Making settings conforming to servo system specification

(2) Output signal logic selection

Set the output signal logic according to the connected servo amplifier.

Logic	Voltage level and command
Positive logic	L: Without command H: With command
Negative logic	H: Without command L: With command

Input signal logic selection:Near-point signal	0:Negative Logic
Input signal logic selection:Manual pulse generator input	0:Negative Logic
Output signal logic selection:Command pulse signal	0:Negative Logic
Output signal logic selection:Deviation counter clear	0:Negative Logic
Manual pulse generator input selection	0:A Phase/B Phase Mode(4 Multiply)

(2)

Positioning parameter setting area

For the sample system, set "Negative logic" for both the command pulse signal and the deviation counter clear signal.

(3) Rotation direction setting

In the sample system, the work-piece moves in a forward rotation (positive address increments) upon receiving a forward run pulse signal from the servo amplifier.

To make this movement, select "Increase Present Value by Forward Pulse Output".

Unit magnification	100:x100 Times
Pulse output mode	1:CW/CCW Mode
Rotation direction setting	0:Increase Present Value by Forward Pulse Output
Bias speed at start	0.00 mm/min

(3)

Positioning parameter setting area

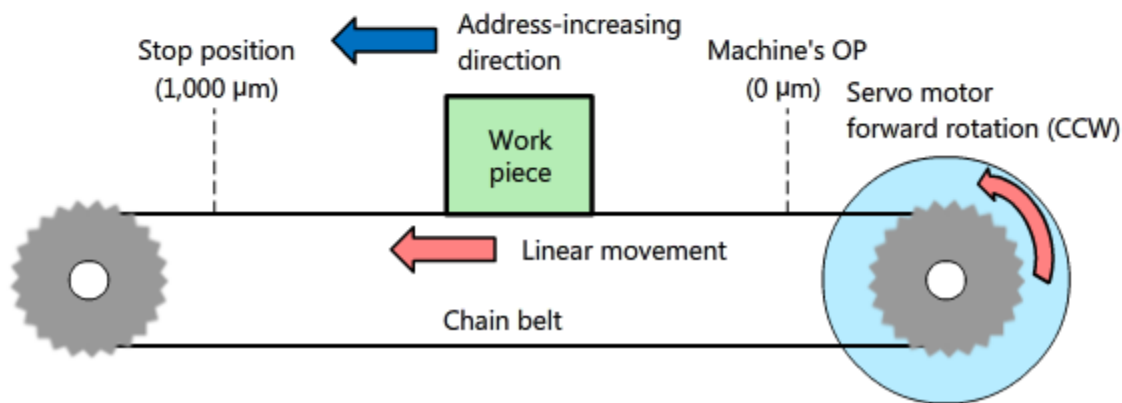

Precautions for rotation direction settings

If the rotation direction is wrongly specified, the workpiece would move in the direction opposite to the one indicated by the command. Test run should always be performed to check beforehand that the workpiece moves as indicated by the command. More details on the test run will be given in Chapter 6.

3.1.5 Workpiece acceleration rate settings

The acceleration/deceleration rate of the workpiece determines the positioning speed, but the rate also affects the stopping accuracy. To determine a proper acceleration rate, take into account the mechanical specification, inertia acting on the workpiece, performance of the servo motor, etc.

Rapid acceleration/deceleration of the workpiece can cause vibration and overrun of the workpiece position and vibration. In contrast, under accelerating/decelerating can cause a reduced positioning speed.

Basic parameters 2		Set according to the machine and applicable motor when system is started up.
(1)	Speed limit value	60000.00 mm/min
(2)	Acceleration time 0	1000 ms
	Deceleration time 0	1000 ms

(1) Speed limit value

Positioning parameter setting area

Set a maximum speed permitted in positioning control. If a speed exceeding the limit is commanded, the specified speed limit is applied. To determine a proper speed limit, take into account the rated rotation speed of the servo motor and the moving speed of the workpiece. For the sample material handling system, set "60,000 mm/min" as the speed limit.

(2) Acceleration time 0, Deceleration time 0

- Acceleration time
Time it takes for the workpiece in stopped state to accelerate to the set speed limit
- Deceleration time
Time it takes for the workpiece travelling at the speed limit to decelerate to a stop.

The diagram on the right shows the relationship between the respective parameters. If the positioning speed lower than the speed limit is specified, the actual acceleration time and deceleration time will be shorter than the values that have been specified.

For the sample material handling system, set the acceleration and deceleration time at "1,000 ms (1 second)".

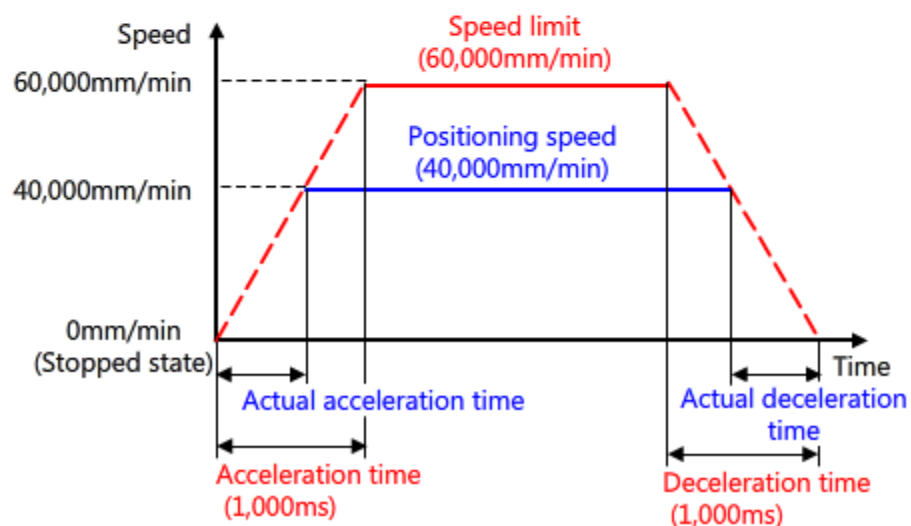

3.1.6 Workpiece movable range settings

If the workpiece overruns during the operation of the system, a system breakdown or other accident may occur. To prevent this, the movable range of the workpiece can be limited. The following methods are available to limit movable ranges.

Limit the movable range by using the software stroke limit function

To the positioning module, set the movable range's upper/lower limit address, which will be processed by the software. If the "current feed value" or "machine feed value" exceeds the upper-/lower-limit address, the workpiece will be decelerated to a stop. Also, if an over-the-range positioning command is given, this will be ignored.

Limit the movable range by using the hardware stroke limit function

Physically limit the workpiece movement by installing emergency stop limit switches at the upper and lower limits of the movable range. If either of the emergency stop limit switches is triggered by an approaching workpiece, the positioning module decelerates the workpiece to a controlled stop. For further information regarding the connection between the emergency stop limit switch and the positioning module, please refer to the positioning module manual.

Click the "Play" button shown below to visualize the operation of the software/hardware stroke limit functionality.

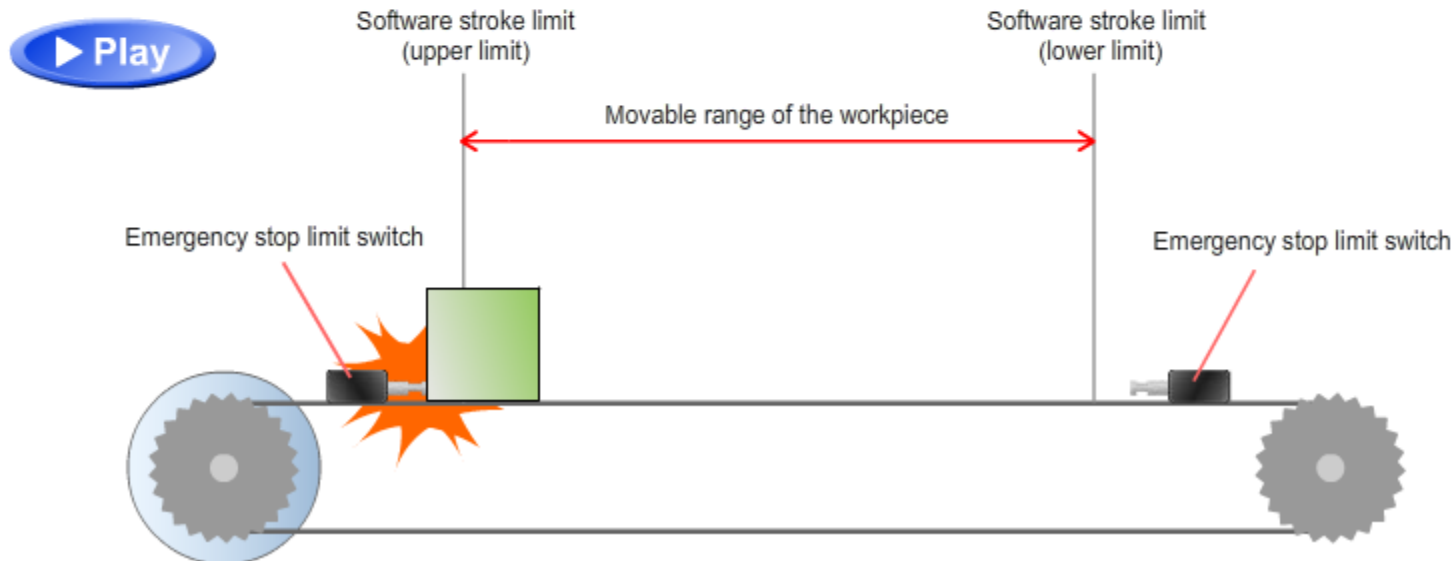

The servo system stops.

3.1.6 Workpiece movable range settings

In the sample material handling system, both the software and hardware stroke limit functions are used. The software stroke limit function does not operate properly if the current value retained in the positioning module differs from the workpiece's current value. Thus, using the software stroke limit function alone may not completely limit the movement of the workpiece. Emergency stop limit switches are installed at both ends of the movable range, ensuring a physical means to stop the workpiece even when the software's stroke limit function falls short of doing that.

Refer to the animation below to check the movements of the workpiece with the software/hardware stroke limit function(s) enabled/disabled.

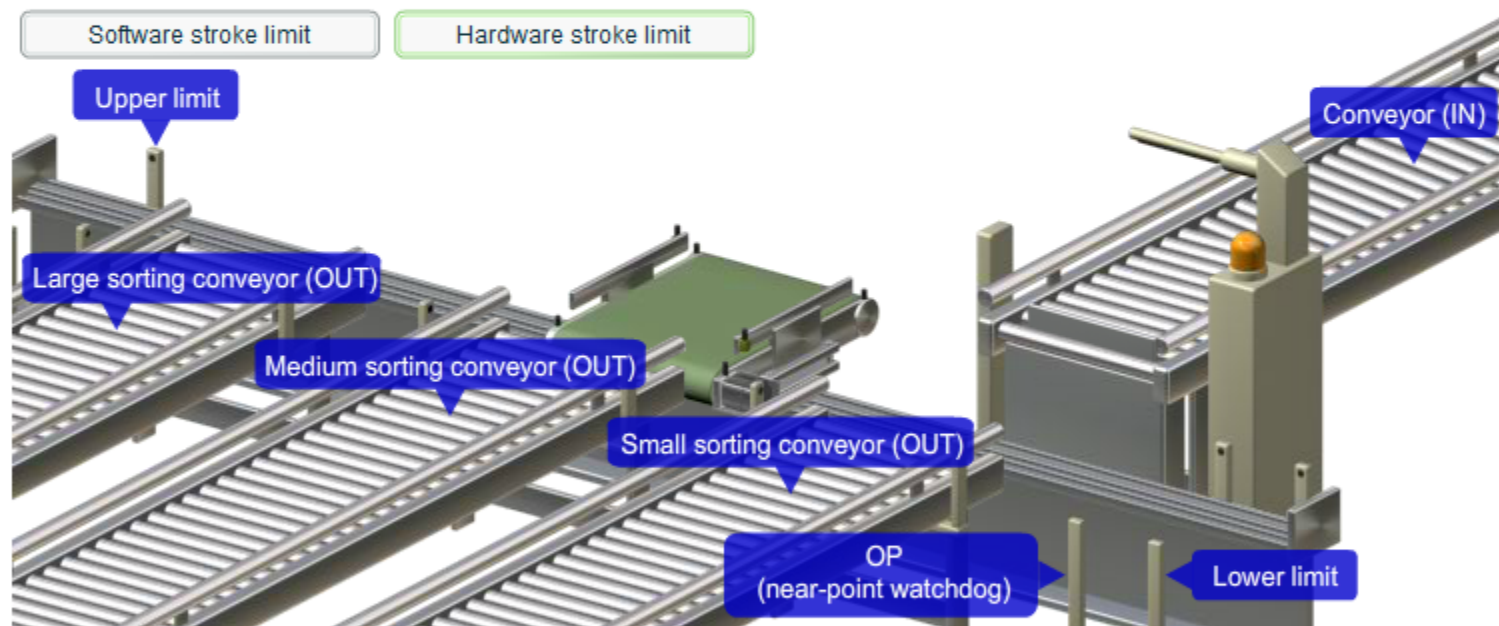

3.1.6 Workpiece movable range settings

This section explains about parameters related to the software stroke limit function.

Detailed parameters 1		Set according to the system configuration when the system is started up. (This parameter become valid when the PLC READY signal [Y0] turns from OFF to ON)
Backlash compensation amount		0.0 μm
Software stroke limit upper limit value		2700000.0 μm
Software stroke limit lower limit value		-200000.0 μm
Software stroke limit selection		1:Set Software Limit to Sending Machine Value
Software stroke limit valid/invalid setting		1:Invalid

Positioning parameter setting area

(1) Software stroke limit upper/lower limit values

Set the upper/lower limit address of the movable range.

In general, the machine OP is set at the upper or lower limit of the software stroke limit.

For the sample material handling system, set the upper and lower limits at "2,700,000 μm " and "-200,000 μm ", respectively.

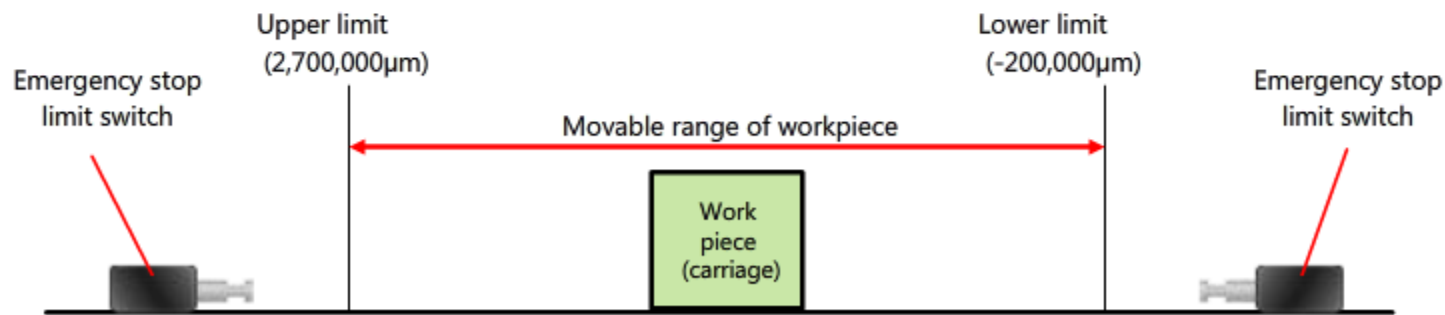

3.1.6

Workpiece movable range settings

Detailed parameters 1		Set according to the system configuration when the system is started up. (This parameter become valid when the PLC READY signal [Y0] turns from OFF to ON)
Backlash compensation amount		0.0 um
Software stroke limit upper limit value		2700000.0 um
Software stroke limit lower limit value		-200000.0 um
Software stroke limit selection		1:Set Software Limit to Sending Machine Value
Software stroke limit valid/invalid setting		1:Invalid

Positioning parameter setting area

(2) Software stroke limit selection

Select a current value type to be used for limiting the movable range between the following two options:

Machine feed value	The movable range is absolutely defined with reference to the machine OP.
Current feed value	The movable range is defined relative to a current feed value.

The sample material handling system has its movable range limited by the machine feed value.

(3) Software stroke limit valid/invalid setting

The software stroke limiting function can be disabled during manual operation. Even if the software stroke limit function is disabled with this setting, it still operates (enabled) for normal positioning control.

For the sample material handling system, select "invalid" to prevent the software stroke limit function from being activated while manually performing an operation test on the hardware stroke limit function (emergency-stop sensors).

3.2

Setup of the Servo Amplifier

Set the servo amplifier's operation.

The sample system uses the Mitsubishi "MR-J4" series servo amplifier, which is setup by the dedicated software, "MR Configurator2".

This software also enables checking of the servo motor operation alone and anti-vibration tuning.

When connecting the positioning module to a 3rd party servo, please refer to the corresponding servo amplifier manual.

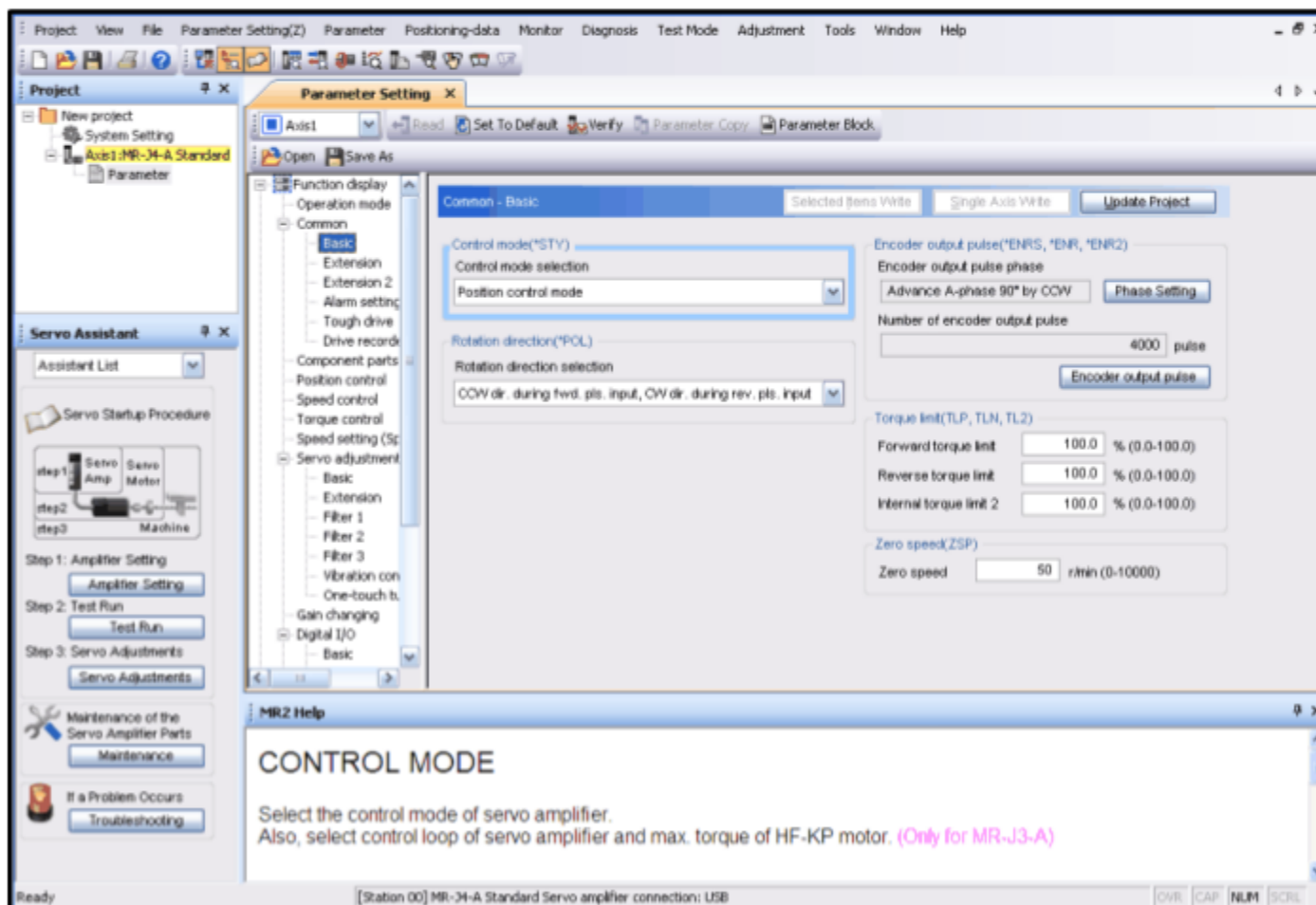

In this chapter, you have learned:

- Setup of positioning parameters
- Setup of the servo amplifier

Important points

Positioning parameter settings	<ul style="list-style-type: none">• Setup of positioning parameters (divided by functions).• The units of the setting values may differ from the units in use and may require conversion.• Roles of positioning module's electronic gear.• Acceleration/deceleration speed is set as time.• Types and concept behind stroke limits which are a safety measure.
Servo amplifier settings	<ul style="list-style-type: none">• The connected servo amplifier must be set.• Use "MR Configurator2" to set Mitsubishi "MR-J4" series servo amplifier.

Chapter 4 Positioning Data Preparation

In Chapter 4, you will learn how to create positioning control commands by using GX Works2.

The positioning command can be setup as positioning data. Up to 600 pieces of data can be set. The set positioning data is identified by the "data No."

A single positioning data can be executed individually, several positioning data can be executed in sequence.

4.1 Positioning Data Settings

4.2 Writing Positioning Parameters/Data

4.3 Summary

No.	Operation pattern	Control system	Axis to be interpolated	Acceleration time No.	Deceleration time No.	Positioning address	Arc address
1	0:END <Positioning Comment>To the medium-size outgoing line	01h:ABS line 1	-	0:1000	0:1000	1500000.0 um	0.0 um
2	0:END <Positioning Comment>To the large-size outgoing line	01h:ABS line 1	-	0:1000	0:1000	2500000.0 um	0.0 um
3	0:END <Positioning Comment>To the incoming line	01h:ABS line 1	-	0:1000	0:1000	500000.0 um	0.0 um

Positioning data setting area

4.1

Positioning Data Settings

The sample material handling system requires three types of positioning control commands. These are set as No.1 through No.3 positioning data, respectively.

The table below shows positioning control commands required for the material handling system.

No.	Positioning start address	Positioning stop address	Positioning speed	Description of control
1	Conveyor (IN) (500,000 μm)	Medium sorting conveyor (OUT) (1,500,000 μm)	60,000 mm/min	Positioning control for the movement from the incoming line to the medium-size outgoing line
2	Conveyor (IN) (500,000 μm)	Large sorting conveyor (OUT) (2,500,000 μm)		Positioning control for the movement from the incoming line to the large-size outgoing line
3	Medium/large sorting conveyor (OUT) stop position	Conveyor (IN) (500,000 μm)		Positioning control for the movement from the individual outgoing line to the incoming line

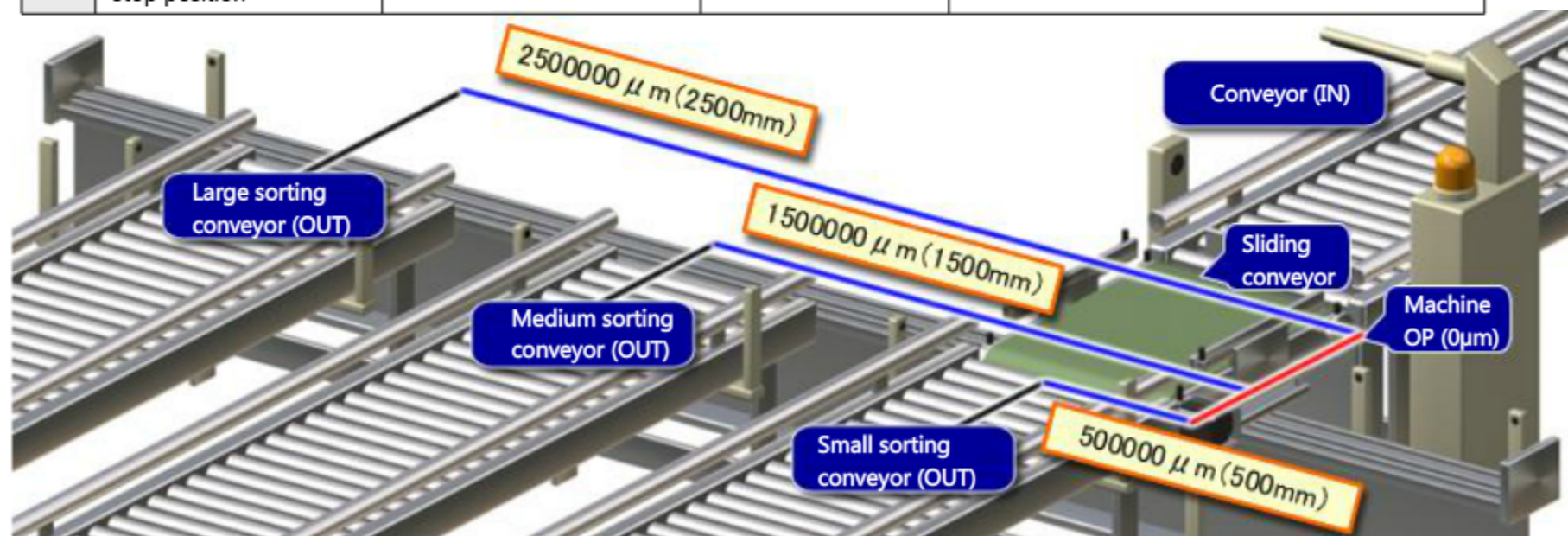

4.1 Positioning Data Settings

This section explains the items to be set as positioning data.

No.	Operation pattern	Control system	Axis to be interpolated	Acceleration time No.	Deceleration time No.	Positioning address	Arc address	Command speed	Dwell time	M code
1	0:END <Positioning Comment>To the medium-size outgoing line	01h:ABS line 1	-	0:1000	0:1000	1500000.0 um	0.0 um	60000.00 mm/min	0 ms	0
2	0:END <Positioning Comment>To the large-size outgoing line	01h:ABS line 1	-	0:1000	0:1000	2500000.0 um	0.0 um	60000.00 mm/min	0 ms	0
3	0:END <Positioning Comment>To the incoming line	01h:ABS line 1	-	0:1000	0:1000	500000.0 um	0.0 um	60000.00 mm/min	0 ms	0

Positioning data setting area

(1) Positioning data No.

This is a number which identifies the positioning data.

When executing positioning by using a dedicated instruction or when performing a test operation, specify the specific data number.

(2) Operation pattern

Set the operation pattern for each positioning data.

The sample material handling system executes No. 1 through No.3 positioning data by using "Exit (End)" operation pattern.

Operation pattern	Feature
Exit (0: END)	Only the positioning data of the specified number will be executed, and complete the positioning.
Continuous positioning control (1: CONT)	The positioning data of the specified number will be executed. After that, the system decelerates and stops the workpiece once, then executes the next positioning data, up to the number specified for "independent positioning control".
Continuous path control (LOCATION)	The positioning data of the specified number will be executed. After that, the system executes the next positioning data without decelerating, up to the number specified for "independent positioning control". The workpiece's moving speed is directly changed to the speed set in the next positioning data, allowing several positioning control commands to be executed smoothly.

4.1

Positioning Data Settings

(3)

No.	Operation pattern	Control system	Axis to be interpolated	Acceleration time No.	Deceleration time No.	Positioning address	Arc address	Command speed	Dwell time	M code
1	0:END <Positioning Comment>To the medium-size outgoing line	01h:ABS line 1	-	0:1000	0:1000	1500000.0 um	0.0 um	60000.00 mm/min	0 ms	0
2	0:END <Positioning Comment>To the large-size outgoing line	01h:ABS line 1	-	0:1000	0:1000	2500000.0 um	0.0 um	60000.00 mm/min	0 ms	0
3	0:END <Positioning Comment>To the incoming line	01h:ABS line 1	-	0:1000	0:1000	500000.0 um	0.0 um	60000.00 mm/min	0 ms	0

Positioning data setting area

(3) Control system

Set the positioning control system method. Each method consists of the number of control axes together with the address format (ABS or INC).

Control system (path of workpiece)	Number of controlled axes				Addressing		Feature of control
	One axis	2 axes	3 axes	4 axes	ABS	INC	
Linear control (linear interpolation control)	○	○	○	○	○	○	This method, by using 1 to 4 servo motor axes, controls the movement of the workpiece in a simple one-dimensional linear control or in a more complex 2-dimensional or 3-dimensional linear control.
Circular interpolation control		○			○	○	This method, by using 2 servo motor axes, controls the movement of the workpiece through a circular path.
Constant-feed control	○	○	○	○		○	A positioning control which lets the workpiece move a fixed distance repeatedly.

In the sample material handling system, the workpiece travels to the address specified by the ABS method (absolute addressing method) by one-axis linear control. Therefore, set "Axis #1 linear control (ABS)" in No. 1 through No. 3 positioning data.

4.1

Positioning Data Settings

No.	Operation pattern	Control system	Axis to be interpolated	Acceleration time No. (4)	Deceleration time No. (5)	Positioning address (5)	Arc address	Command speed (6)	Dwell time	M code
1	0:END <Positioning Comment>To the medium-size outgoing line	01h:ABS line 1	-	0:1000	0:1000	1500000.0 um	0.0 um	60000.00 mm/min	0 ms	0
2	0:END <Positioning Comment>To the large-size outgoing line	01h:ABS line 1	-	0:1000	0:1000	2500000.0 um	0.0 um	60000.00 mm/min	0 ms	0
3	0:END <Positioning Comment>To the incoming line	01h:ABS line 1	-	0:1000	0:1000	500000.0 um	0.0 um	60000.00 mm/min	0 ms	0

Positioning data setting area

(4) Acceleration time No. and Deceleration time No.

Select the acceleration time and deceleration time from among four patterns, No. 0 through No. 3. For the sample material handling system, select "No. 0 (1,000ms)" for No. 1 through No. 3 positioning data.

(5) Positioning address

Set either a positioning address (ABS method) or for the movement amount (INC or constant-feed method). For the sample material handling system, set the positioning address as specified by the ABS method.

No.	Positioning destination	Positioning address	Description of control
1	Medium-size conveyor (out)	1,500,000μm (1,500mm)	Used for positioning from the incoming conveyor to the medium-size outgoing conveyor
2	Large-size conveyor (out)	2,500,000μm (2,500mm)	Used for positioning from the incoming conveyor to the large-size outgoing conveyor
3	conveyor (in)	500,000μm (500mm)	Used for returning from the large-/medium-size outgoing conveyor to the incoming conveyor

(6) Command speed

Set a positioning speed (speed at constant-speed movement).

Any speed exceeding the speed limit (Section 3.1.4) cannot be set.

For the sample material handling system, set "60,000 mm/min" in No. 1 through No. 3 positioning data.

4.2

Writing Positioning Parameters/Data

Write the parameters and data, which set in GX Works2, into the positioning module.

Connect the CPU module with the personal computer, on which GX Works2 is operating, by a USB cable. After connecting, make connection settings in "Transfer Setup" of GX Works2.

Upon establishing the connection successfully, write parameter data into the positioning module from "Write to PLC" of GX Works2. On the Online Data Operation window, select the PLC Module tab, and select parameters. On the Intelligent Function Module tab, select the target positioning module.

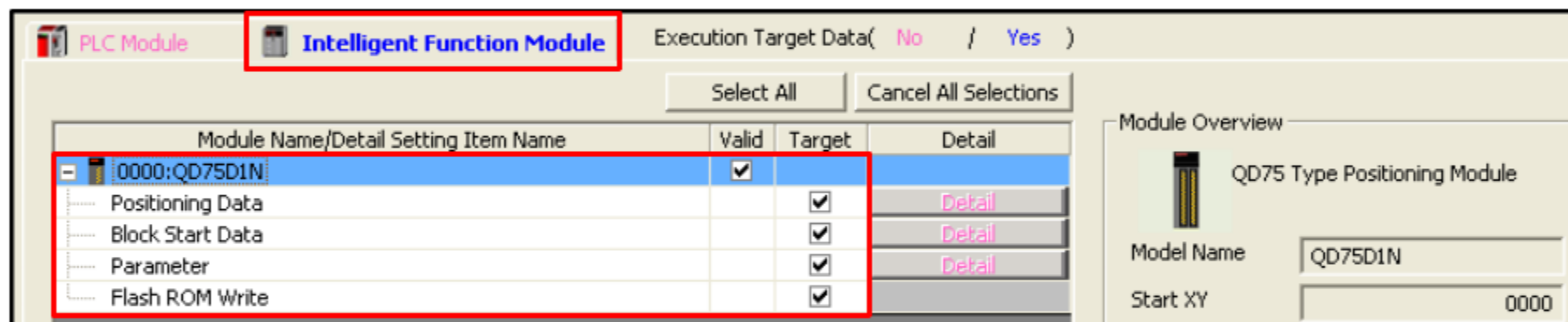

PLC write window

Writing parameters/data into flash ROM

In the sample material handling system, parameters/data are written into a CPU module's flash ROM simultaneously. The information held in the buffer memory of the positioning module is cleared when the power to the module is turned off.

However, the information written into the CPU module's flash ROM is held even after the power to the module is turned off and will be copied to the positioning module's buffer memory when the power is turned on again. The flash ROM can be used as a backup for the buffer memory.

Initializing the positioning module

If you want to reset the positioning module to the factory setting, initialize the module. For details about this process, please refer to the corresponding GX Works2 manual.

In this chapter, you have learned:

- Positioning data settings
- Writing positioning parameters/data

Important points

Designing and setting positioning data	You have learned about necessary positioning data for the machine specification and how to perform settings.
Specifying a connection destination and performing a communication test	You have learned how to check the connection between the positioning module and GX Works2.
Writing positioning parameters/data	You have learned how to write the positioning parameters/data settings into a positioning module.

Chapter 5 Sequence Program Preparation

In Chapter 5, you will learn how to execute positioning data from a sequence program.

When you configure a system, you will notice that not many systems can be realized only with positioning control. Mainly as fundamentally a control systems requires synchronization of I/O signals by the programmable controller.

To realize such a system, the positioning module is designed to handle dedicated instructions, which are used to execute specific positioning data in a sequence program.

For example, positioning data is used as below in the material handling system:

- 1) The size of a box is detected by a sensor (small, medium, or large) and the information is sent to the programmable controller,
- 2) The programmable controller executes the positioning data No. corresponding to the information received, and
- 3) The sliding conveyor delivers the box according to the executed positioning data.

5.1 Executing Positioning Data from the Sequence Program

5.2 Summary

5.1

Executing Positioning Data from the Sequence Program

"ZP.PSTRT□" instruction is an instruction dedicated to executing positioning data of the number specified in a sequence program.

Positioning control start instruction

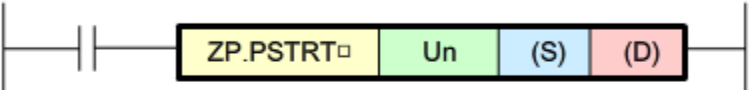
Instruction symbol	Condition for execution	Circuit
ZP.PSTRT□		

Enter the number of the axis (axes) (1 through 4) into "□" part of the instruction. (ZP.PSTRT1 to ZP.PSTRT4)

Data setting

Data setting	Description	Data type
Un	Start I/O number for QD75D (00 to FE: The first 2 digits where the I/O number is expressed in 3 digits)	BIN16 bit
(S)	Start number for a device in which control data* is stored.	Device
(D)	Start number for a bit device which is turned on for one scan cycle upon the completion of the instruction. In the case of abnormal completion, ((D) + 1) turns on as well.	Bit

* Control data will be explained on the next page.

The sample material handling system uses "ZP.PSTRT1" instruction.

Control data

Set the following control data used in the ZP.PSTRT□ instruction to the sequential devices. The results of executing the instruction are also written into the devices.

For the control data "Start number", set the number of the positioning data to be executed.

Device	Item	Data setting	Range of setting
(S) +0	System area	–	–
(S) +1	Ending status	Status at completion of instruction is stored. <ul style="list-style-type: none"> • 0: Normal end • Other than 0: Abnormal end (error code) 	–
(S) +2	Start number	Set the data No. to be executed by the ZP.PSTRT□ instruction: <ul style="list-style-type: none"> • Number of positioning data: 1 to 600 • Block start: 7000 to 7004 • Machine OPR: 9001 • High-speed OPR: 9002 • Current value change: 9003 • Simultaneous execution at plural axes: 9004 	1 to 600 7000 to 7004 9000 to 9004

5.1

Executing Positioning Data from the Sequence Program

The following diagram shows an example of sequence program that uses a dedicated instruction. In this program, positioning data No. 1 is executed when X100 turns on.

Devices D30 to D32 are used for control data, and devices M32 and M33 are used for completing the positioning data execution.

(The following example program is different from a sequence program applied to the sample material handling system.)

Positioning start program

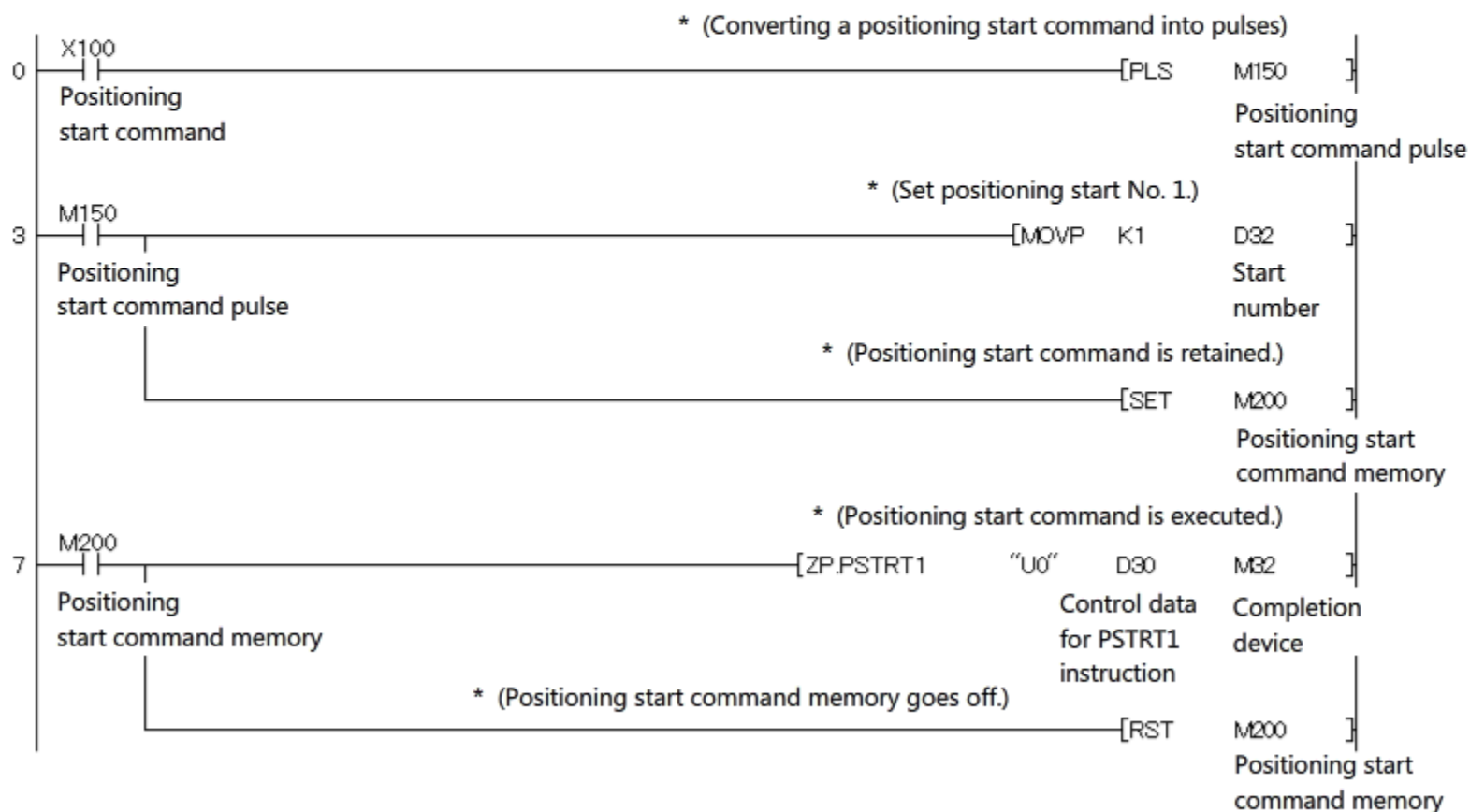

5.2

Summary

In this chapter, you have learned:

- Executing positioning data from the sequence program

Important point

How to use the dedicated instruction
"ZP.PSTRT□"

You have learned how to use the dedicated instruction "ZP.PSTRT□" which allows you to start any given positioning data in a sequence program.

Chapter 6 Test Operation of System

In Chapter 6, you will learn how to check the system by performing a test operation before bringing it into service.

Mistakes made in the design, poor assembly of the equipment, or incorrect parameterization may cause the system to fail which could result in an accident.

Therefore, make sure to check the operation of the system by performing a test operation before bringing it into service.

The following points should be checked in the test operation:

- The machine design of a positioning control system is accurate.
- Assembly (including installation and connection) of a positioning control system is accurate.
- Workpiece (sliding conveyor) moves correctly in a correct direction.
- Software/hardware stroke limits operate normally.
- Execution of positioning data results in an operation consistent with the design.

6.1 Test Operation of System

6.2 Manual Test Operation for Workpiece

6.3 Initialization of Positioning Start Position

6.4 Operation Check of Positioning Data

6.5 Summary

6.1 Test Operation of System

Positioning test

For a test operation, use the positioning test function of GX Works2.

The positioning test function is a useful function that allows you to perform a manual operation, machine OPR, and positioning data execution using GX Works2 while monitoring the operation status during each operation. No input device or sequence program is required.

Operation procedure

- (1) On the GX Works2 menu, select "Tool" - "Intelligent Function Module Tool" - "QD75/LD75 Positioning Module" - "Positioning Test".
- (2) Select a positioning module to be tested.
- (3) Positioning Test window appears.

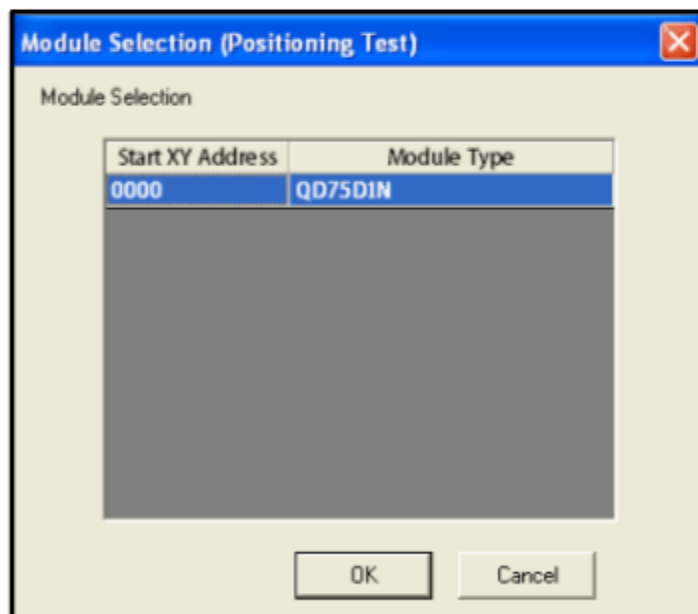

Module Selection (Positioning Test) window

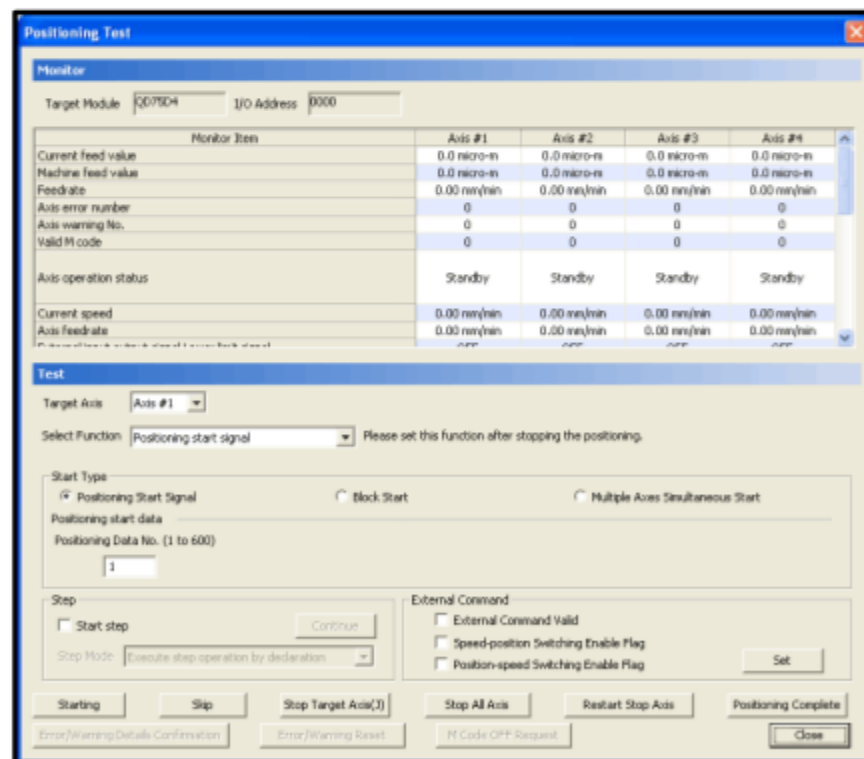

Positioning Test window

6.2

Manual Test Operation for Workpiece

Perform a test operation on the workpiece.

In the sample material handling system,

- 1) check the operation of the "carriage" (workpiece),
- 2) check the moving direction (rotation direction of the motor), and
- 3) check the operation of hardware stroke limits manually.

Be sure to manually check the operation before performing automatic operation by sequence programs and positioning data.

An assembly fault or incorrectly set parameters may be left unnoticed and cause the workpiece to make an unexpected motion that can result in a system fault or an accident.

For the sample material handling system, use "JOG operation" to test the operation of the carriage.

The JOG operation is a manual operation that rotates a servo motor in the forward/reverse direction at a fixed speed.

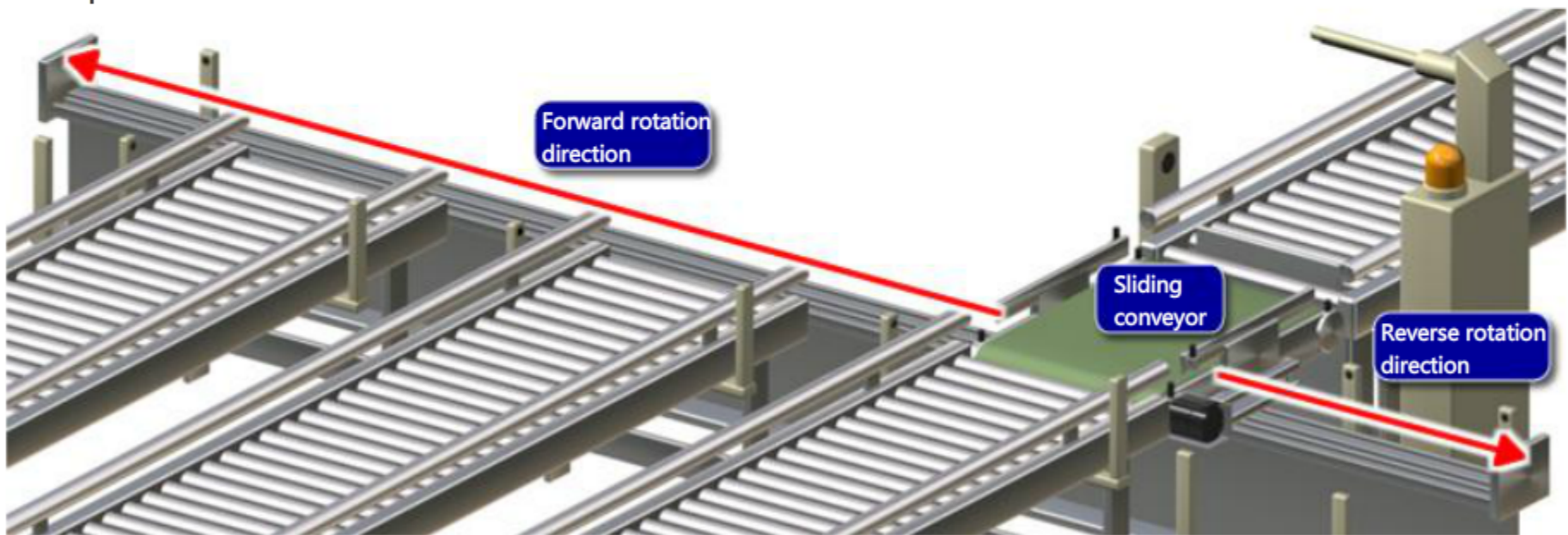

6.2.1

Parameter setting for JOG operation

This section explains the parameter settings required for execution of JOG operation.

(1) JOG speed limit value

Set the maximum speed during JOG operation.
JOG operation speed will be limited to the set value.

For the sample material handling system, set "3,000 mm/min".

(2) JOG operation acceleration time selection / JOG operation deceleration time selection

Select the acceleration time and deceleration time during JOG operation from among four patterns, No. 0 through No. 3.

For the sample material handling system, set "0: 1,000".

Item	
Detailed parameters 2	Set according to the system configuration when (Set as required.)
Acceleration time 1	1000 ms
Acceleration time 2	1000 ms
Acceleration time 3	1000 ms
Deceleration time 1	1000 ms
Deceleration time 2	1000 ms
Deceleration time 3	1000 ms
JOG speed limit value	3000.00 mm/min
JOG operation acceleration time selection	0:1000
JOG operation deceleration time selection	0:1000
Acceleration/deceleration process selection	0:Trapezoidal Acceleration/Deceleration Processing
S-curve ratio	100 %
Sudden stop deceleration time	1000 ms
Stop group 1 sudden stop selection	0:Normal Deceleration Stop
Stop group 2 sudden stop selection	0:Normal Deceleration Stop
Stop group 3 sudden stop selection	0:Normal Deceleration Stop
Positioning complete signal output time	300 ms
Allowable circular interpolation error width	10.0 um
External command function selection	0:External Positioning Start

(1)

(2)

Positioning parameter setting area

6.2.2 Test operation by JOG operation

Use JOG operation to check that the carriage and the hardware stroke limits in the sample material handling system operate normally.

To execute a JOG operation, go to "Positioning Test" and select "JOG/Manual Pulse Generator/OPR" at **Select Function**.

JOG Speed

Set the moving speed during JOG operation. A speed exceeding a limit cannot be set.

For the sample material handling system, set "50 mm/min".

Inching Moving Amount

When performing JOG operation, make sure to set "0".

If a value exceeding "0" is set as the inching moving amount, the operation will change to the inching operation automatically.

Monitor Item	Axis #1
Current feed value	0 micro-m
Machine feed value	0 micro-m
Feedrate	0 mm/min
Axis error number	0
Axis warning No.	0
Valid M code	0
Axis operation status	Standby
Current speed	0.00 mm/min
Axis feedrate	0 mm/min
External input status	OFF

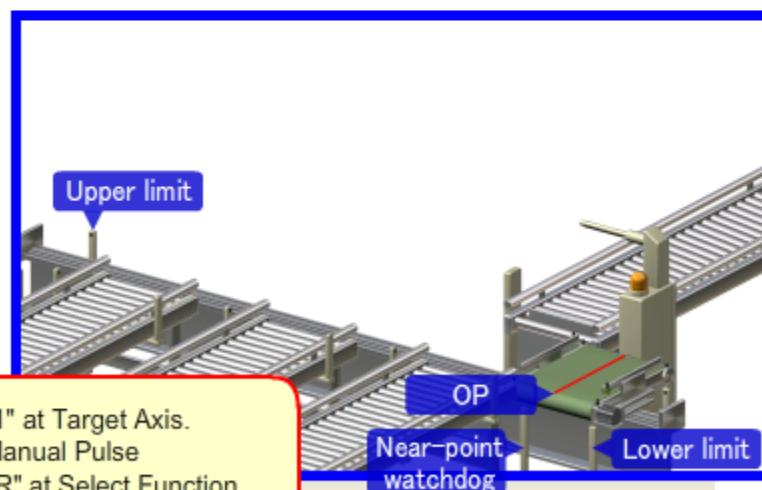

Target Axis

Select Function

Select "Axis #1" at Target Axis.
Select "JOG/Manual Pulse Generator/OPR" at Select Function.

JOG

JOG Speed mm/min (0.01 to 20000000.00)

Inching Movement Amount micro-m (0.0 to 6553.5)

Forward RUN

Reverse RUN

Move the carriage by pressing the Forward RUN or Reverse RUN button until it reaches the upper/lower limit.

6.3

Initialization of Positioning Start Position

The positioning start position must be initialized (OPR must be performed) before checking the operation of positioning control.

By initializing the positioning start position, the machine OP saved in the positioning module, and the machine OP of the actual workpiece are synchronized. If it is not synchronized, a difference may arise in stop positions. This initialization process is called "machine OPR".

Machine OPR should always be performed at every start because a stop position may have been shifted due to an external pressure, disturbance, etc. while the system is in stop. If such a situation is likely to occur, create a sequence program that performs machine OPR after the power is supplied to the system (after startup).

To perform a machine OPR by a sequence program, use the "ZP.PSTRT□" instruction explained in Chapter 5.

A machine OPR can be performed by setting "9001" to the starting number of control data. For details, please refer to the corresponding positioning module manual.

Positioning module



Machine feed value: 0 μm
Current feed value: 0 μm

=

Match the current feed value and machine feed value saved in the positioning module with the original position of the workpiece.

Workpiece (carriage)

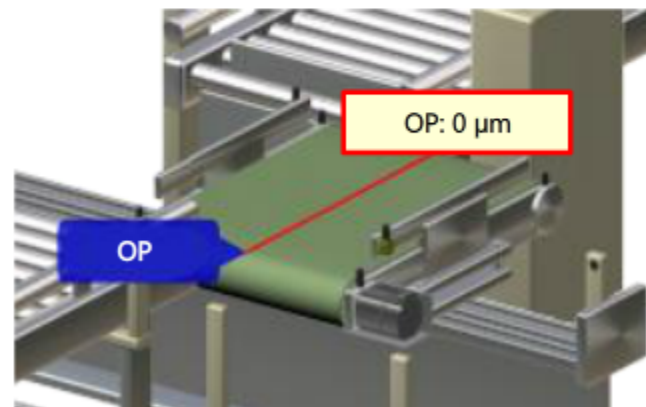

6.3.1 OPR parameter settings

This section explains the parameter settings required for execution of machine OPR.

(1) OPR method

Select a machine OPR method.

For the sample material handling system, select "Near-point Dog Method".

In the "Near-point Dog Method", when a workpiece near the original position (near point) is detected by a sensor, the movement of the workpiece is decelerated to a speed level called "creep speed" in order to improve its stop accuracy.

The accuracy of OPR is increased and at the same time the impact on the machine is reduced.

OPR basic parameters	Set the values required for carrying out OPR control. (This parameter become valid when the PLC READY signal is ON.)
OPR method	0:Near-point Dog Method
OPR direction	1:Reverse Direction(Address Decrease Direction)
OP address	0.0 um
OPR speed	3000.00 mm/min
Creep speed	300.00 mm/min
OPR retry	0:Do not retry OPR with limit switch

Positioning parameter setting area

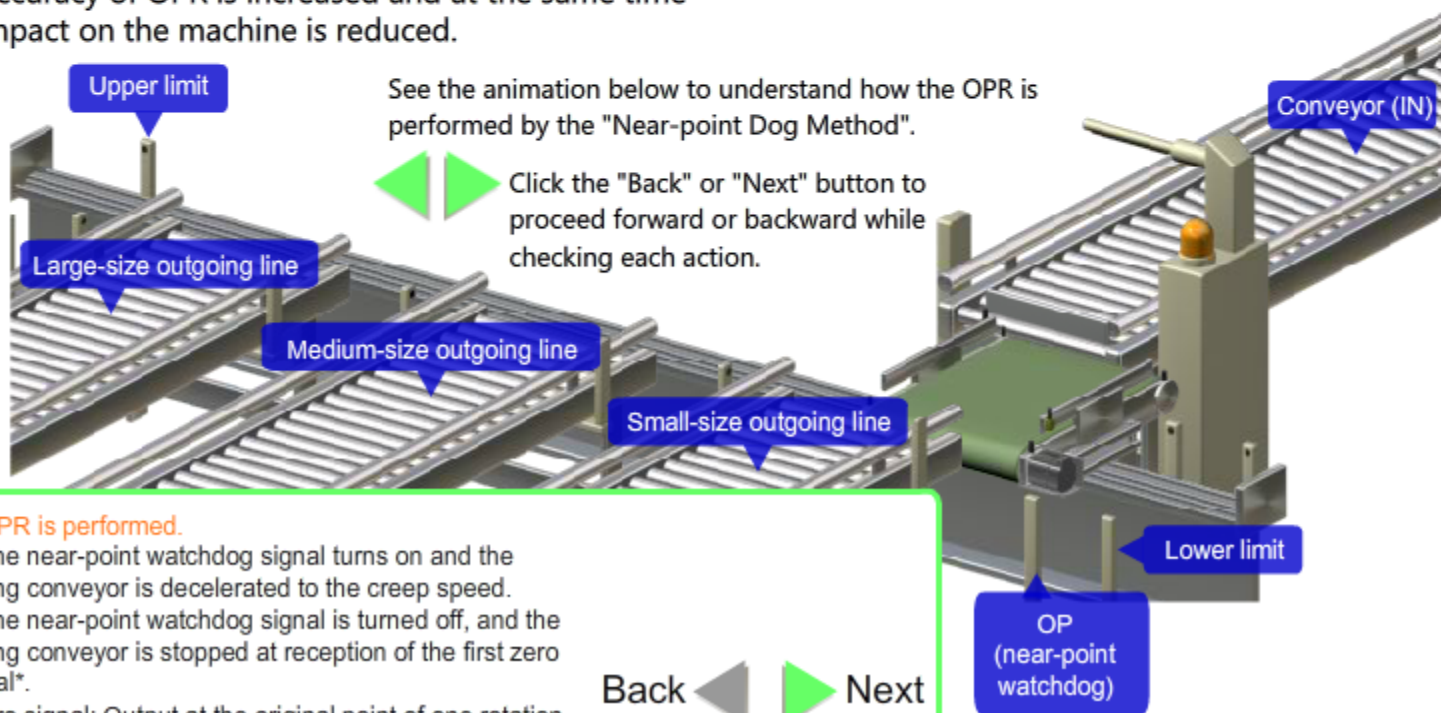

1. OPR is performed.

2. The near-point watchdog signal turns on and the sliding conveyor is decelerated to the creep speed.

3. The near-point watchdog signal is turned off, and the sliding conveyor is stopped at reception of the first zero signal*.

* Zero signal: Output at the original point of one rotation. It is output once per motor rotation.

Back ◀ ▶ Next

6.3.1 OPR parameter settings

(2) OP address

Set the machine OP address.

In an OPR, the OP address is initialized to the "machine feed value" and "current feed value", which are saved in the positioning module.

For the sample material handling system, set "0 μm " which is easy to remember.

OPR basic parameters		Set the values required for carrying out OPR control. (This parameter become valid when the PLC READY signal is ON.)
OPR method		0:Near-point Dog Method
OPR direction		1:Reverse Direction(Address Decrease Direction)
OP address		0.0 μm
OPR speed		3000.00 mm/min
Creep speed		300.00 mm/min
OPR retry		0:Do not retry OPR with limit switch

Positioning parameter setting area

(3) OPR direction

Set the direction in which the workpiece moves during OPR.

The direction is determined by the system machine structures, and specification and settings of the servo system, etc.

In the material handling system, the sliding conveyor moves away from the machine OP, increasing its address. If it were to return to its original position, it has to be moved to the opposite direction, decreasing its address. Therefore, set "Reverse Direction (Address Decrease Direction)" at OPR direction.

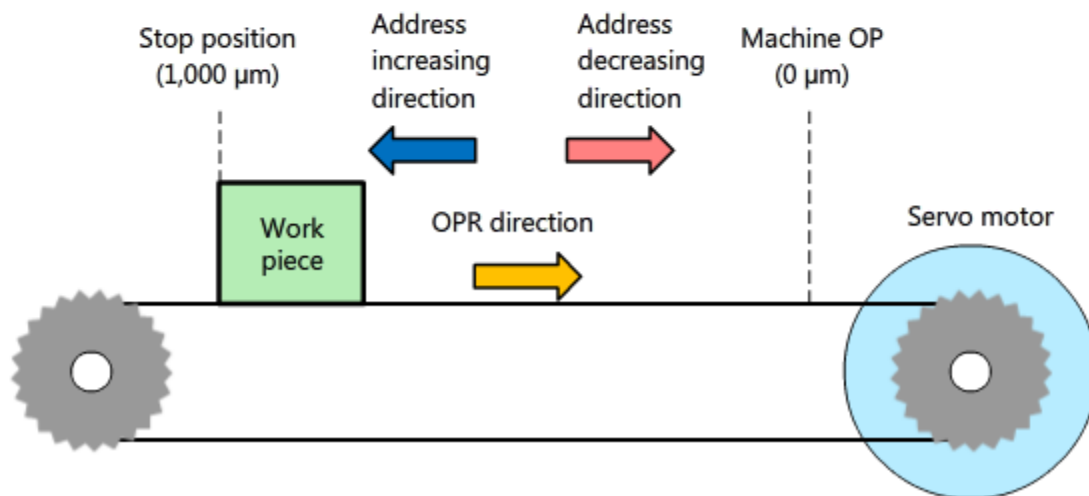

6.3.1 OPR parameter settings

(4) OPR speed

Set the moving speed during OPR.
The workpiece is moved at the set speed from the OPR start until the input signal of near-point watchdog turns on.

For the sample material handling system, set "3,000 mm/min" to OPR speed.

<input type="checkbox"/> OPR basic parameters	Set the values required for carrying out OPR (This parameter become valid when the PLC
OPR method	0:Near-point Dog Method
OPR direction	1:Reverse Direction(Address Decrease Direction)
OP address	0.0 um
(4) OPR speed	3000.00 mm/min
(5) Creep speed	300.00 mm/min
OPR retry	0:Do not retry OPR with limit switch
<input type="checkbox"/> OPR detailed parameters	Set the values required for carrying out OPR
OPR dwell time	0 ms
Setting for the movement amount after near-point dog ON	0.0 um
(6) OPR acceleration time selection	0:1000
OPR deceleration time selection	0:1000

Positioning parameter setting area

(5) Creep speed

Set a speed slower than OPR speed.
Since OP serves as a reference position of positioning control, high stopping accuracy is required.
If the input signal of near-point watchdog turns on, OPR speed is lowered to the creep speed, reducing the moving speed.

For the sample material handling system, set "300 mm/min" (1/10 of OPR speed).

(6) OPR acceleration time selection / OPR deceleration time selection

Select the acceleration time and deceleration time during OPR from among four patterns, No. 0 through No.3.

For the sample material handling system, select "No. 0" (1,000 ms).

6.3.2

Execution of machine OPR

Use GX Works2 to perform machine OPR without using a sequence program.

To execute an OPR operation, go to "Positioning Test" and select "JOG/Manual Pulse Generator/OPR" at Select Function.

Monitor Item	Axis #1
Current feed value	2059732.0 micro-m
Machine feed value	2059732.0 micro-m
Feedrate	0 mm/min
Axis error number	0
Axis warning No.	0
Valid M code	0
Axis operation status	Standby
Current speed	0.00 mm/min
Axis feedrate	0 mm/min
External feed enable signal	OFF

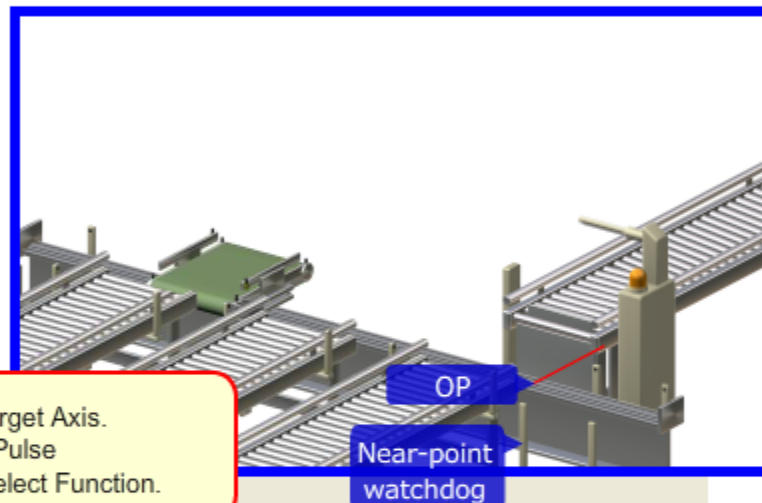

Target Axis:

Select Function:

Select "Axis #1" at Target Axis.
Select "JOG/Manual Pulse Generator/OPR" at Select Function.

JOG

JOG Speed: mm/min (0.01 to 20000000.00)

Inching Movement Amount: micro-m (0.0 to 6553.5)

Manual Pulse Generator

Manual pulse generator enable flag Manual Pulse 1 Pulse Generator Input Magnification: x (1 to 100)

OPR Operation

OPR Method:

Press the OPR button to perform machine OPR.

6.4 Operation Check of Positioning Data

Use "Positioning Start Signal" to confirm that execution of positioning data results in an operation consistent with the design.
 Any positioning data can be executed, without using a sequence program.

To execute a positioning test, go to "Positioning Test" – "Start Type"– and then select "Positioning Start Signal".

Monitor Item	Axis #1
Current feed value	0 micro-m
Machine feed value	0 micro-m
Feedrate	0 mm/min
Axis error number	0
Axis warning No.	0
Valid M code	0
Axis operation status	Standby
Current speed	0.00 mm/min
Axis feedrate	0 mm/min
External break output status (1 to 600)	OFF

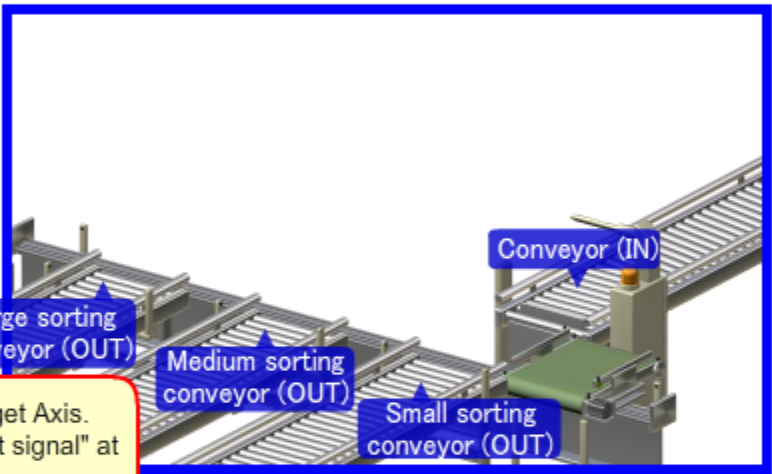

Target Axis:

Select Function:

Select "Axis #1" at Target Axis.
 Select "Positioning start signal" at Select Function.

Start Type

Positioning Start Signal Block Start Multiple Axes Simultaneous Start

Positioning start data

Positioning Data No. (1 to 600)

The No. 1 data is executed to move the carriage to the medium-size outgoing line.

Step

Start step

Step Mode:

External Command

External Command Valid

Speed-position Switching Enable Flag

Position-speed Switching Enable Flag

Click the Starting button to execute the No. 1 positioning data.

In this chapter, you have learned:

- Test operation of system
- Manual test operation for workpiece
- Initialization of positioning start position
- Operation check of positioning data

Important points

Importance of test operation	You have learned that a test operation must be performed before bringing the system into service.
Roles and procedure of manual operation	You have learned about JOG operation, which is a test operation that can be performed using GX Works2.
Roles and procedure of machine OPR	You have learned the importance and the procedure of machine OPR and OPR parameters.
Roles and procedure of positioning data operation test	You have learned how OPR is performed by the specified OP data.

Chapter 7 Bringing System into Service

In Chapter 7, you will learn how to control the system under operation.
You will learn how to check the operating status and troubleshooting using GX Works2.

- 7.1 Troubleshooting Using Operation Monitors
- 7.2 Safety Measures of System (Accident Prevention)
- 7.3 Summary

7.1

Troubleshooting Using Operation Monitors

Various troubles (warning and error) may arise during operation of a system.

In order to investigate the cause of a trouble, the warning code / error code must be checked.

An operation monitor provides the operating state of each axis and the operating status at the time of a failure while showing the warning/error codes.

The table below lists the names of operation monitors. (Example of one-axis control)

	Axis #1
(1) Current feed value	0.0 um
(2) Axis operation status	Standby
(3) Positioning data being executed running pattern	Positioning complete
(3) Positioning data being executed control method	-
(3) Positioning data being executed axis to be interpolated	-
(4) Positioning data being executed acceleration time No.	0:1000
(4) Positioning data being executed deceleration time No.	0:1000
(5) Axis error No. ...	0
(5) Axis warning No. ...	0
(6) Valid M code	0

Operation monitor area

No.	Item	Monitor detail
(1)	Current feed value	Displays the current value (address). The unit set in "Unit setting" is applied.
(2)	Axis operation status	Displays the operating status.
(3)	<ul style="list-style-type: none"> • Running pattern • Control method • Axis to be interpolated 	Displays the positioning data being executed.
(4)	<ul style="list-style-type: none"> • Acceleration time No. • Deceleration time No. 	Displays the acceleration time and deceleration time applied for the positioning data being executed.
(5)	<ul style="list-style-type: none"> • Axis error No. • Axis warning No. 	Displays the code of error/warning occurring.
(6)	Valid M code	Displays the valid M code.
(7)	Monitored values	Displays the monitored values of up to four axes simultaneously.

Positioning control moves machines and materials, and can introduce a safety risk into the manufacturing site. To avoid any danger, system failure or an accident to occur, thorough safety measures must be implemented prior to using such a control system.

Use of emergency stop function

An emergency stop function stops all the servo motor axes by an emergency stop input from an input device connected to a positioning module.

Be sure to install an emergency stop button or similar devices so that the system can be stopped at any time when a trouble occurs.

Refer to the corresponding positioning module manual for the connection method of input devices.

Additionally connect an emergency stop input to the servo amplifier.

Even if the positioning module fails, an emergency stop function can be used from the servo amplifier connected with an emergency stop input. Refer to the corresponding servo amplifier manual for the connection method.

Caution

When wiring an emergency stop input, always wire by the negative logic and use "normally open contact".
When performing an emergency stop, do not directly turn off the servo motor power supply.

Avoid approaching the system under operation

Installation of a safety fence can be considered to prevent a worker from accidentally approaching the system under operation.

A safety fence prevents workers from approaching the system, and also protects workers from the scattered debris of broken system, etc.

For example, opening/closing operation of the safety fence door and the signals from the motion sensor can be interlocked with the emergency stop input. Therefore, when a worker approaches the system under operation, the system can be shut down automatically.

In this chapter, you have learned:

- Troubleshooting using operation monitors
- Safety measures of system (accident prevention)

Important points

Troubleshooting using operation monitors	You have learned how to use the monitoring function of GX Works2 to perform primary diagnostic of the system not performing the expected operation.
Safety measures	You have learned the importance of thorough safety measure in the control involving motions.

Test**Final Test**

Now that you have completed all of the lessons of the **PLC Positioning** Course, you are ready to take the final test. If you are unclear on any of the topics covered, please take this opportunity to review those topics.

There are a total of 10 questions (31 items) in this Final Test.

You can take the final test as many times as you like.

How to score the test

After selecting the answer, make sure to click the **Answer** button. Your answer will be lost if you proceed without clicking the Answer button. (Regarded as unanswered question.)

Score results

The number of correct answers, the number of questions, the percentage of correct answers, and the pass/fail result will appear on the score page.

Correct Answers : 2

Total Questions : 9

Percentage : 22%

To pass the test, you have to answer **60%** of the questions correct.

Proceed

Review

Retry

- Click the **Proceed** button to exit the test.
- Click the **Review** button to review the test. (Correct answer check)
- Click the **Retry** button to retake the test again.

"QD75" positioning module features

The following sentences explain various features of the QD75 positioning module. Please select the appropriate sentences that correctly describe these features (Multiple answers).

- The complicated positioning control interlocked with the programmable controller can be
- Any positioning module of the "QD75" series can exchange data with the servo amplifier in both directions.
- All of the positioning module settings are performed using sequence programs.
- The amount of sequence programs is reduced by using GX Works2.
- A dedicated instruction is used in a sequence program to execute positioning data.

[Answer](#)[Back](#)

Positioning control functionality

Please select the correct function corresponding to each description contained on the left.

Description	Function name
Matches the machine OP of the workpiece and that of the positioning module.	Q1 <input type="text" value="--Select--"/>
Physically limits the movable range of the workpiece using a switch, sensor, etc. installed at both ends of the system.	Q2 <input type="text" value="--Select--"/>
Logically limits the movable range of the workpiece using the "current feed value" and "machine feed value" saved in the positioning module.	Q3 <input type="text" value="--Select--"/>
Automatically converts the positioning address and speed set in "mm" and "inch" to the number of command pulses and command pulse frequency.	Q4 <input type="text" value="--Select--"/>
Manually operates the workpiece.	Q5 <input type="text" value="--Select--"/>

[Answer](#)[Back](#)

Electronic gear function setting

If an electronic gear is required to operate a sliding table for 20mm in one motor rotation with an encoder resolution of 8192 pulses/rev. Please select the appropriate settings below. The unit of measurement is in "mm".

- (1) The number of pulses per rotation : Q1
- (2) The movement amount per rotation : Q2
- (3) Unit magnification : Q3

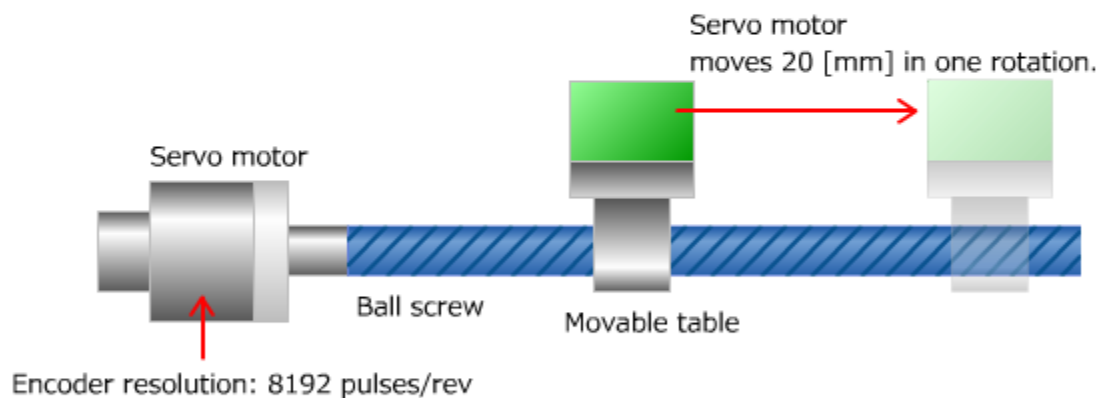

Relationship of speed and time

Select a graph that shows the correct relationship between speed and time during positioning control.

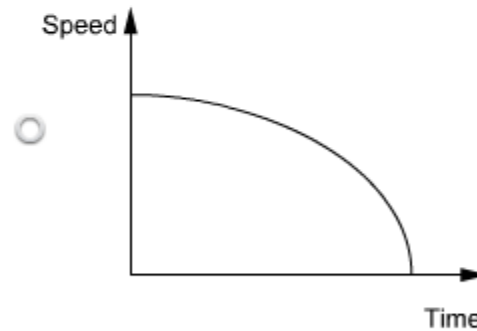
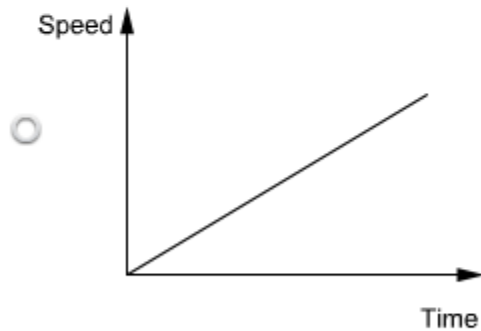
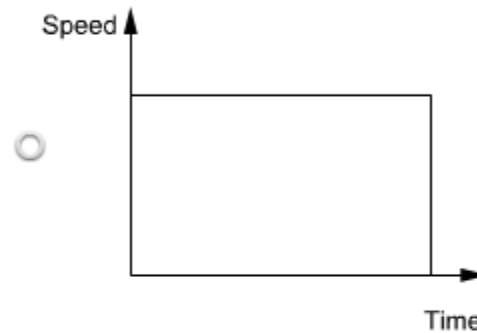
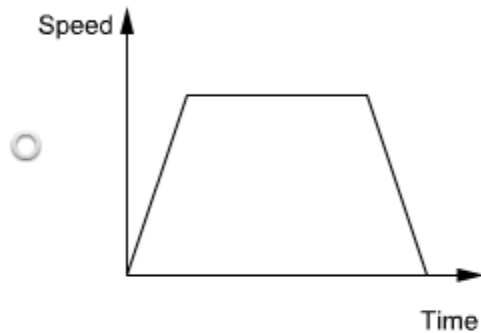

Answer

Back

Test Final Test 5

Limiting the movable range of workpiece

Select the figure that correctly shows the positions of the software stroke limits and the hardware stroke limits.

- ▼ : Software stroke limit
- ▼ : Hardware stroke limit

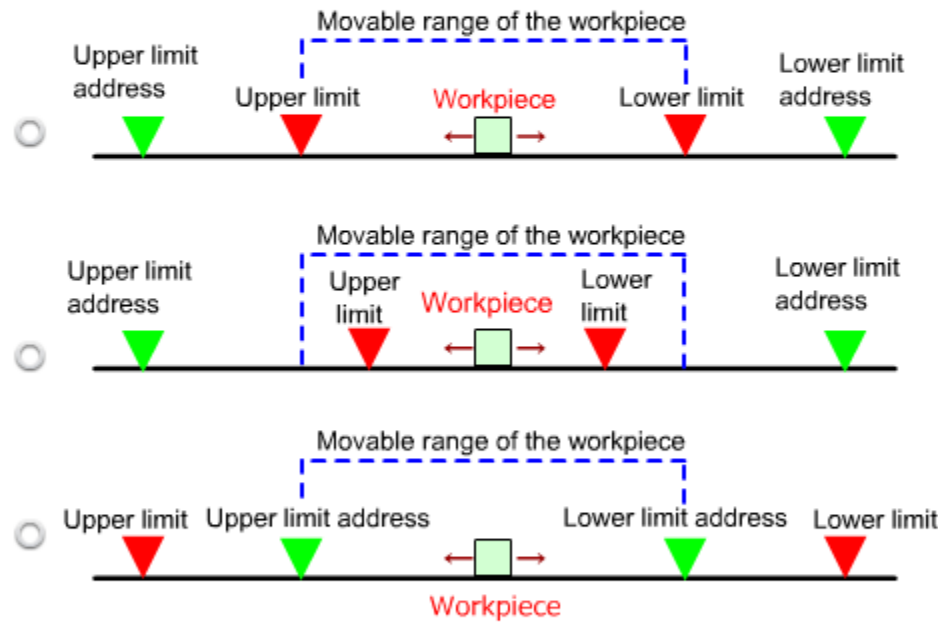

Answer Back

Test

Final Test 6



Positioning data setting

Select the appropriate values for the three positioning data (No. 1 through No. 3) as shown below.
For the input value unit, assume "mm" has been selected as the unit of measurement.

Input commands for positioning control

Acceleration/deceleration time No.

No.	Operation pattern	Control method	Positioning address	Positioning speed	Acceleration time	Deceleration time	No.	Set time
1	Single operation	Axis #1 linear control (ABS)	1500mm	3500mm/min	500ms	500ms	Acceleration time 0	1000ms
							Acceleration time 1	1500ms
							Acceleration time 2	500ms
2	Single operation	Axis #1 linear control (ABS)	3000mm	5000mm/min	1000ms	1000ms	Acceleration time 0	1000ms
							Acceleration time 1	1500ms
							Acceleration time 2	500ms
3	Single operation	Axis #1 linear control (ABS)	5000mm	7000mm/min	1500ms	1500ms	Acceleration time 0	1000ms
							Acceleration time 1	1500ms
							Acceleration time 2	500ms

Positioning data (input value unit when the command unit is "mm")

No.	Operation pattern	Control method	Acceleration time No.	Deceleration time No.	Positioning address	Command speed
1	0: END	Axis #1 linear control (ABS)	Q1 <input type="text"/>	Q2 <input type="text"/>	Q3 --Select-- <input type="text"/>	Q4 --Select-- <input type="text"/>
2	0: END	Axis #1 linear control (ABS)	Q5 <input type="text"/>	Q6 <input type="text"/>	Q7 --Select-- <input type="text"/>	Q8 --Select-- <input type="text"/>
3	0: END	Axis #1 linear control (ABS)	Q9 <input type="text"/>	Q10 <input type="text"/>	Q11 --Select-- <input type="text"/>	Q12 --Select-- <input type="text"/>

Answer

Back

Test

Final Test 7



Positioning data execution using a sequence program

The following figure shows a sequence program that executes the positioning data No. 2 when X1 is on.

Select the correct value to complete the program below.

Use devices D33 to D35 to store control data of the positioning data No. 2, and use devices M34 and M35 as completion devices. The number of control axis is "1 axis".

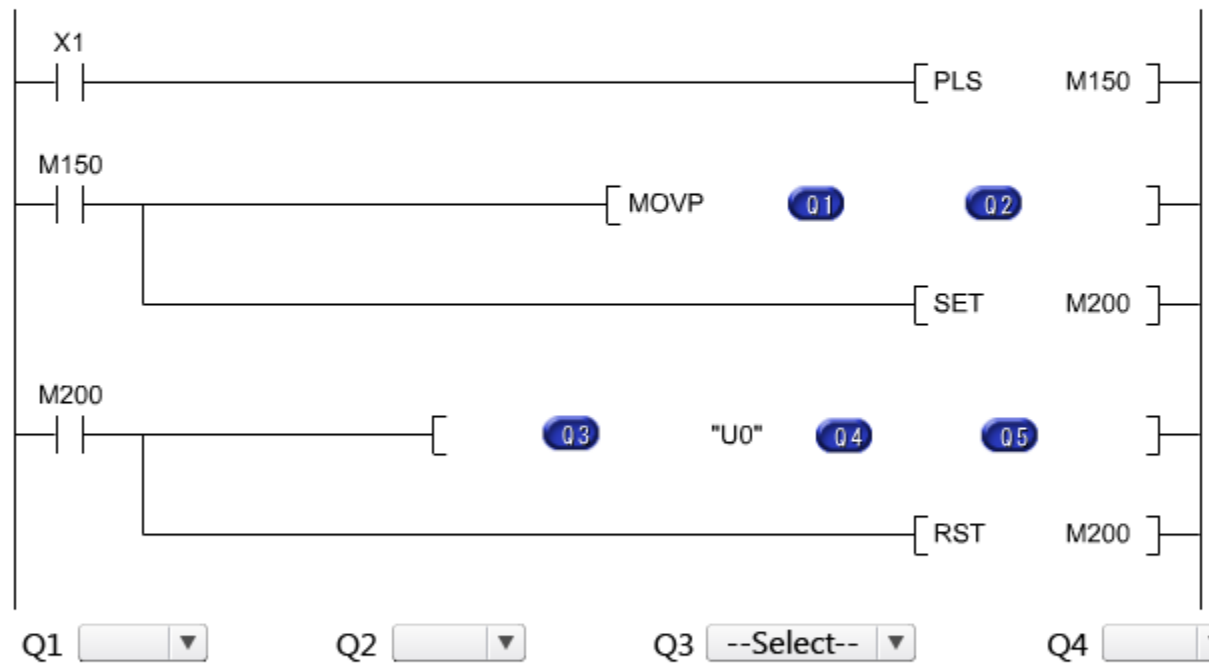

Test

Final Test 8



OPR direction of machine OPR

Select the correct "OPR direction" for the workpiece, which always moves between the work address 100 mm and 1000 mm in the positioning control. The machine OP address is "0 mm".

- Forward Direction (Address Increase Direction)
- Reverse Direction (Address Decrease Direction)

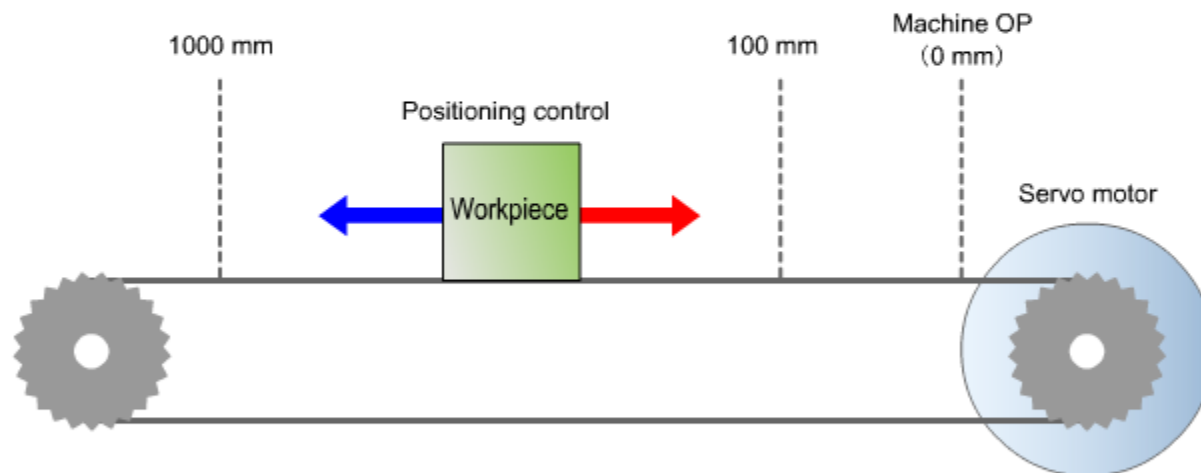

Answer

Back

System test operation

What can be tested by performing the "positioning start" of GX Works2's test function? Select the most suitable answer.

- Operation and travel (rotation) direction of the workpiece.
- Operation of the hardware/software stroke limits.
- Operation of positioning data
- Operation of positioning parameters
- Operation of sequence programs

[Answer](#)[Back](#)

System safety measures

Select the correct description for system safety measures.

- As an emergency stop method, it is safer to turn off the servo motor power supply directly rather than turning off the positioning module and servo amplifier.
- For the emergency stop wiring, it is safer for to use a "normally open contact" rather than a "normally closed contact".
- A safety fence interlocked with the emergency stop can be installed around the system to provide safety.
- An emergency stop gives a sudden impact to the system (workpiece), and therefore is safer if it is not used.
- Software stroke limits provide enough safety by limiting the movable range of a workpiece.

Answer

Back

You have completed the Final Test. Your results are as follows.
To end the Final Test, proceed to the next page.

Correct answers : 0

Total questions : 10

Percentage : 0%

Proceed

Review

Retry

You failed the test.

You have completed the **PLC Positioning** Course.

Thank you for taking this course.

We hope you enjoyed the lessons and the information you acquired in this course will be useful in the future.

You can review the course as many times as you want.

Review

Close