



INDUSTRIAL ROBOT MELFA BASIC OPERATIONS AND MAINTENANCE (F SERIES Q TYPE)

This course gives you the opportunity to learn how to carry out basic and maintenance operations on the industrial robot MELFA F series Q type.

Introduction Purpose of the Course



This course targets first-time users of the MITSUBISHI industrial robot MELFA and describes the procedures for setup, operations, and maintenance.

Introduction Course Structure

The contents of this course are as follows.
We recommend that you start from Chapter 1.

Chapter 1 - Configuration of Mitsubishi Industrial Robot MELFA

This chapter covers the configuration of the MITSUBISHI industrial robot MELFA.

Chapter 2 - Setup

This chapter covers setup procedures, such as connecting devices and setting an origin.

Chapter 3 - Programming

This chapter covers programming methods.

Chapter 4 - Robot Operation

This chapter covers robot operations with a teaching pendant.

Chapter 5 - Automatic Operation

This chapter covers the methods of carrying out automatic robot operation.

Chapter 6 - Maintenance

This chapter covers the methods of carrying out maintenance and inspection.

Final Test

This chapter checks your understanding of the contents of chapter 1 to 6.

Introduction How to Use This e-Learning Tool



Go to the next page		Go to the next page.
Back to the previous page		Back to the previous page.
Move to the desired page		"Table of Contents" will be displayed, enabling you to navigate to the desired page.
Exit the learning		Exit the learning. Window such as "Contents" screen and the learning will be closed.

>> **Introduction** **Cautions for Use**

Safety precautions

When you learn by using actual products, please carefully read the safety precautions in the corresponding manuals.

Chapter 1 Configuration of Mitsubishi Industrial Robot MELFA

This course describes basic and maintenance operations on the MITSUBISHI industrial robot MELFA.

The MITSUBISHI industrial robot MELFA is used to assemble and check electric components and electronic components and transfer automobile parts, liquid crystal display boards, and semiconductor wafers, for example. The MELFA can automate production equipment and will add a high value.



1.1

Types of Robots and Controllers

[Robot]

The MITSUBISHI industrial robot MELFA has two types: the vertical, multiple-joint type and the horizontal, multiple-joint type.

Vertical, multiple-joint type : RV-F series



Load capacity of 2 kg

RV-2F-D
RV-2F-Q

Load capacity of 4 kg

RV-4F-D
RV-4F-QLong arm with
load capacity of 4 kgRV-4FL-D
RV-4FL-Q

Load capacity of 7 kg

RV-7F-D
RV-7F-QLong arm with
load capacity of 7 kgRV-7FL-D
RV-7FL-QUltra-long arm with
load capacity of 7 kgRV-7FLL-D
RV-7FLL-Q

Load capacity of 13 kg

RV-13F-D
RV-13F-QLong arm with
load capacity of 13 kgRV-13FL-D
RV-13FL-Q

Load capacity of 20 kg

RV-20F-D
RV-20F-Q

Horizontal, multiple-joint type : RH-FH series



Load capacity of 3 kg

RH-3FH-D
RH-3FH-Q

Load capacity of 6 kg

RH-6FH-D
RH-6FH-Q

Load capacity of 12 kg

RH-12FH-D
RH-12FH-Q

Load capacity of 20 kg

RH-20FH-D
RH-20FH-Q

1.1**Types of Robots and Controllers**

[Controller]

Two types of the robot controller are available: D type (standalone robot controller) and Q type (iQ Platform-compatible controller).

The robot CPU is built in the D type controller. For linkage with a programmable controller, the robot CPU is separated from the Q type controller and mounted on a slot on the programmable controller base.

D type (CR750/CR751-D)**Q type (CR750/CR751-Q)****iQ Platform
Programmable controller****Robot CPU
(Q172DRCPU)**

1.2 Equipment (Option and Peripheral) Configuration

The following shows the equipment (option and peripheral) configuration of the Q type robot system.

Putting the mouse cursor over a piece of equipment displays the description of the function.

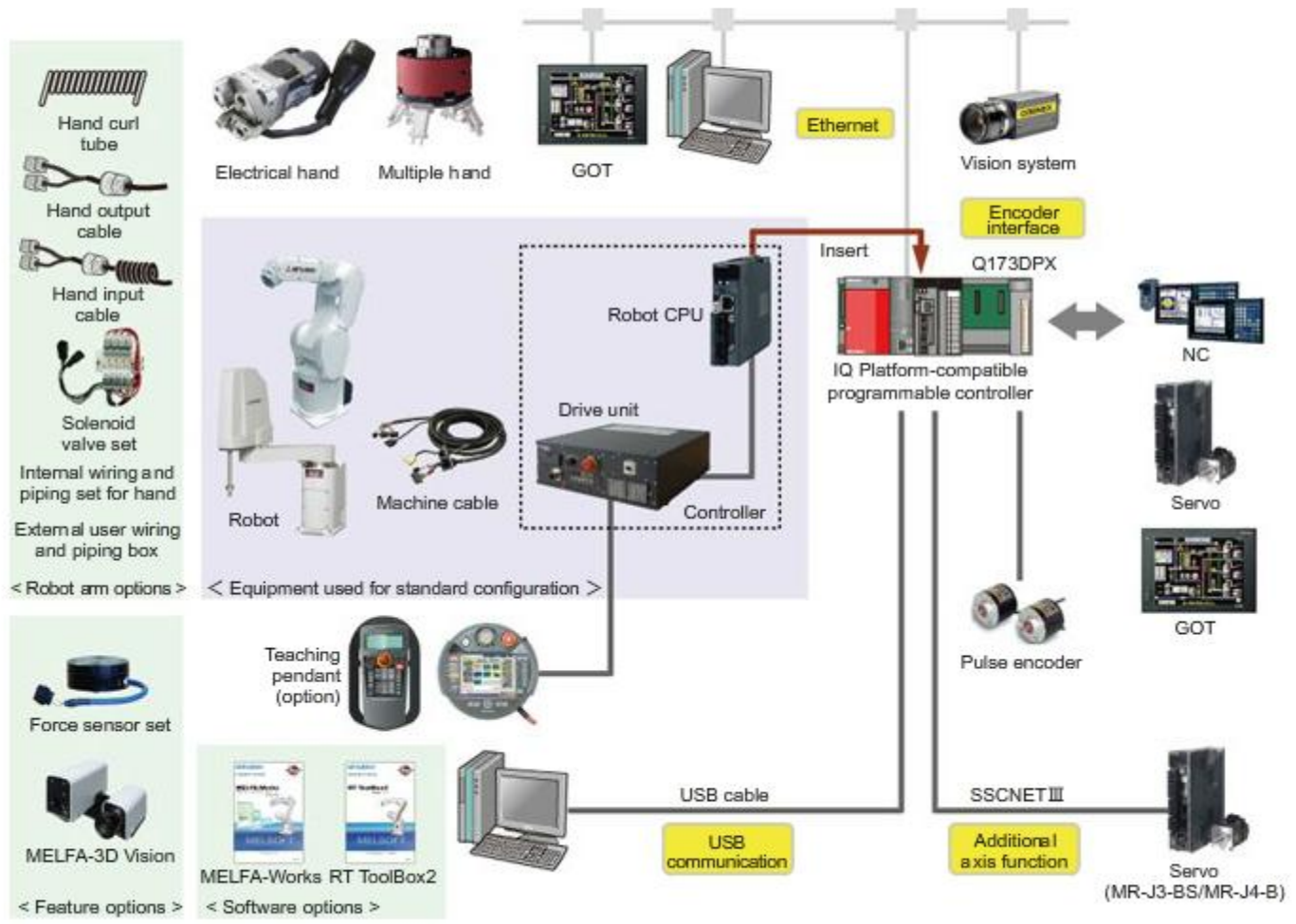

1.3**Summary**

In this chapter, you have learned:

- Lineup of MITSUBISHI industrial robot MELFA.
- Equipment (option and peripheral) configuration

Important points

The contents you learned in this chapter are listed below.

D type robot	<ul style="list-style-type: none">• Standalone robots with a robot controller central to the control system
Q type robot	<ul style="list-style-type: none">• New-concept robots with the robot CPU built in the programmable controller
Controller	<ul style="list-style-type: none">• A controller controls robots. Robots can be operated with an operation panel.• Two types are available: D type and Q type.

Chapter 2 SETUP

Chapter 2 covers the procedures for setting the MITSUBISHI industrial robot MELFA.

Chapter 2 introduces the preparations to use a robot, such as connecting devices and setting an origin with a teaching pendant.



2.1 Connecting Devices

The following shows how to connect a robot to a robot controller, and how to connect power cables and a ground cable to the robot controller.

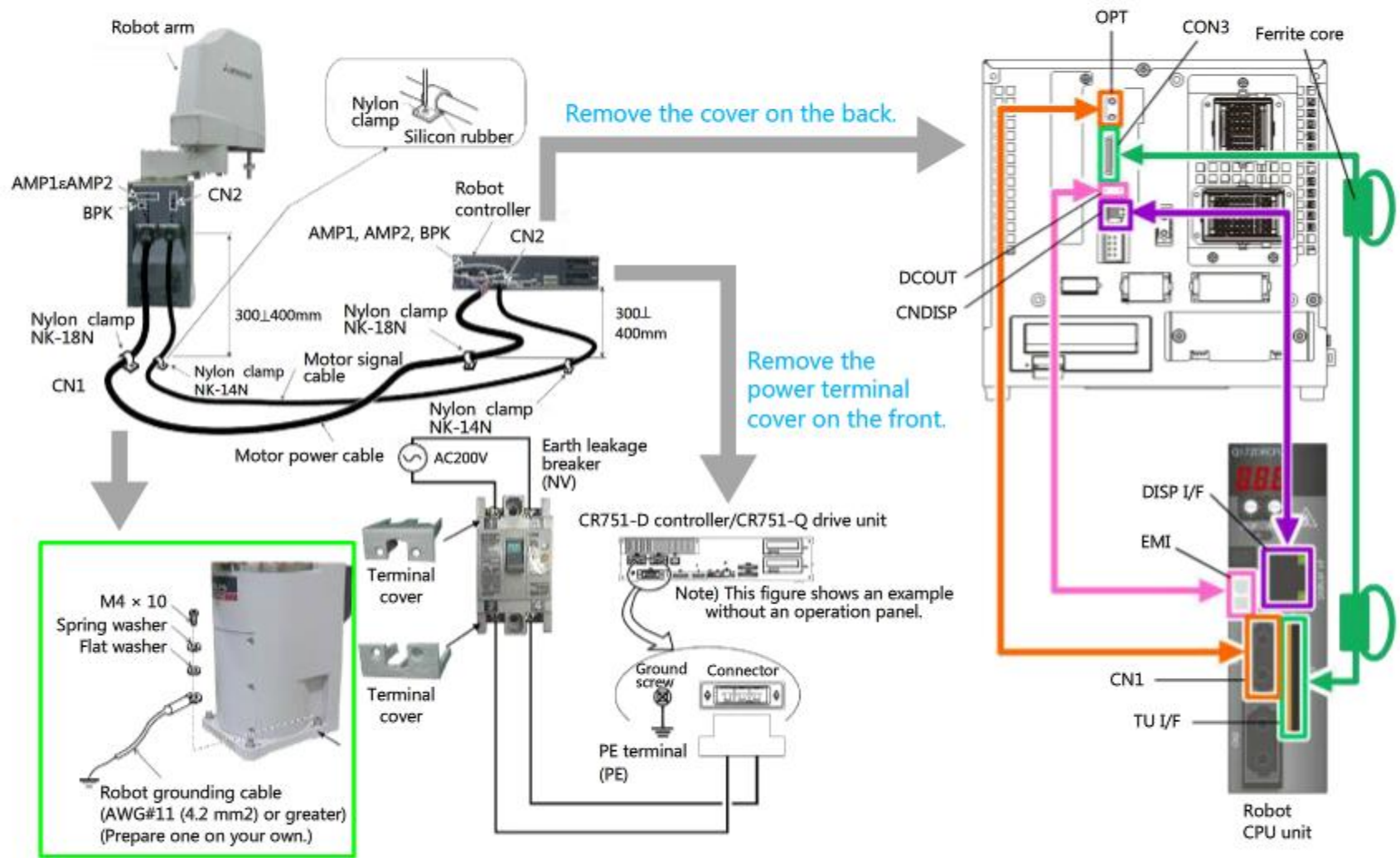

2.2

Connecting a Teaching Pendant

The teaching pendant must be connected or disconnected during power OFF.
 If the power is ON and no teaching pendant is connected, an emergency stop alarm occurs.
 To use a robot without a teaching pendant connected, connect the accompanying dummy connector instead of a teaching pendant. When connecting or disconnecting the dummy connector, hold the connector.

The following shows the procedure for connecting a teaching pendant.

1. Check that the POWER (power supply) switch of the robot controller is OFF.
2. Connect the connector of the teaching pendant to the connector for the teaching pendant on the robot controller.

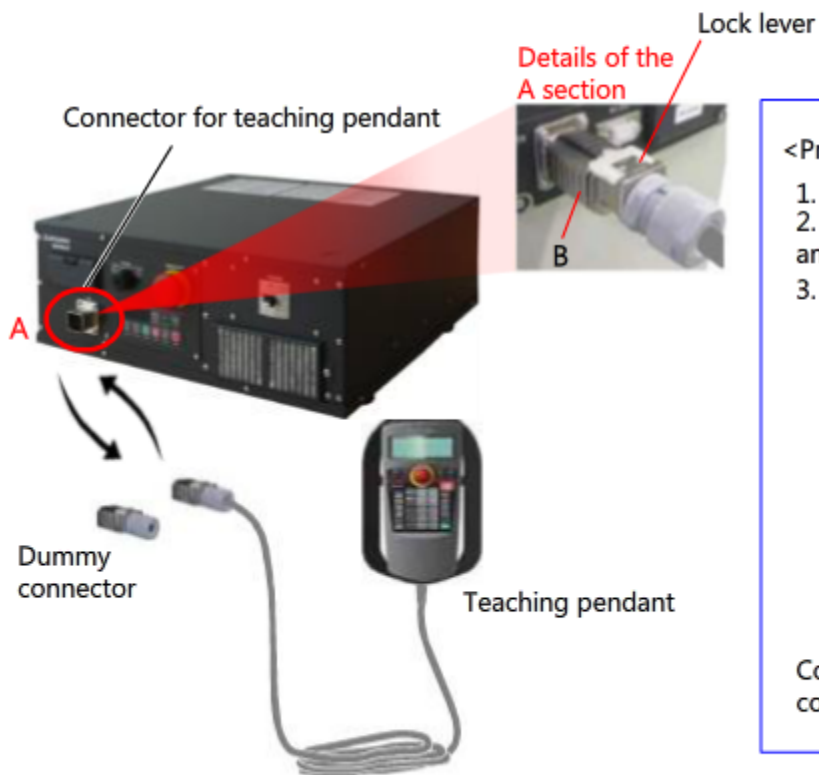

<Procedure for connecting connectors>

1. Check that the lock lever is folded down.
2. Hold the connector body of the teaching pendant, and connect it to the connector on the controller.
3. Push the connector of the teaching pendant until it clicks.

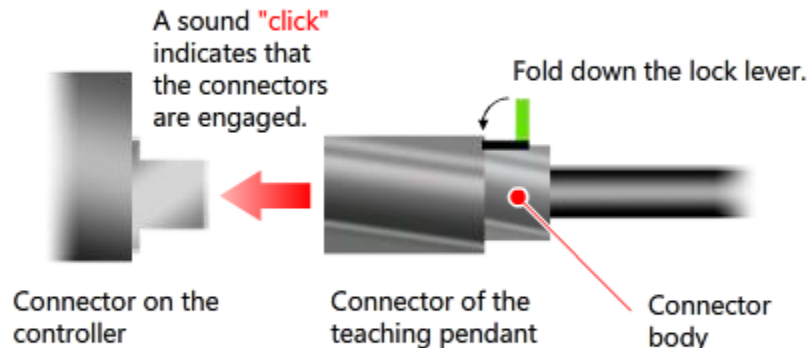

2.3 Teaching Pendant Language Setting

This section covers the procedure for setting a language for the teaching pendant. The standard teaching pendant (R32TB) is used to show how to set a language. The default language is English.

Use the following operation simulator to switch the language from English to Japanese.



1. Configuration
2. Com. Information

<1> <2> Rset

Guide

You have completed the language setting for the teaching pendant.

Click to proceed to the next screen.

Display/hide the guide

2.4

Origin Setting (Origin Data Input Method)

The origin setting is an operation to establish origins of each axis for accurate robot control. After the purchase, origins must be established. This setting is also required when the combination of the robot and controller in use is changed.

This section describes origin data input that is required when a robot is activated for the first time.

Use the following operation simulator to set an origin.



•Origin data history table (Origin Data History) Serial No.ES804008

Date	Default
D	V1%S29			
J1	06DTYY			
J2	2?HL9X			
J3	1CP55V			
J4	T6!MSY			
J5	Z2IJ%Z			
J6	A12%Z0			
Method	E	E·N·SP	E·N·SP	E·N·SP

(O: O(Alphabet), 0: Zero)

Guide

You have completed the origin setting.

Click  to proceed to the next screen.

Display/hide the guide



2.5 Example of Safety Measures

To use a robot, **safety measures are absolutely necessary**. The robot controller has two emergency-stop input circuits on the user wiring terminal block. Safety measures can be implemented.

Create a circuit as shown below for safety measures.

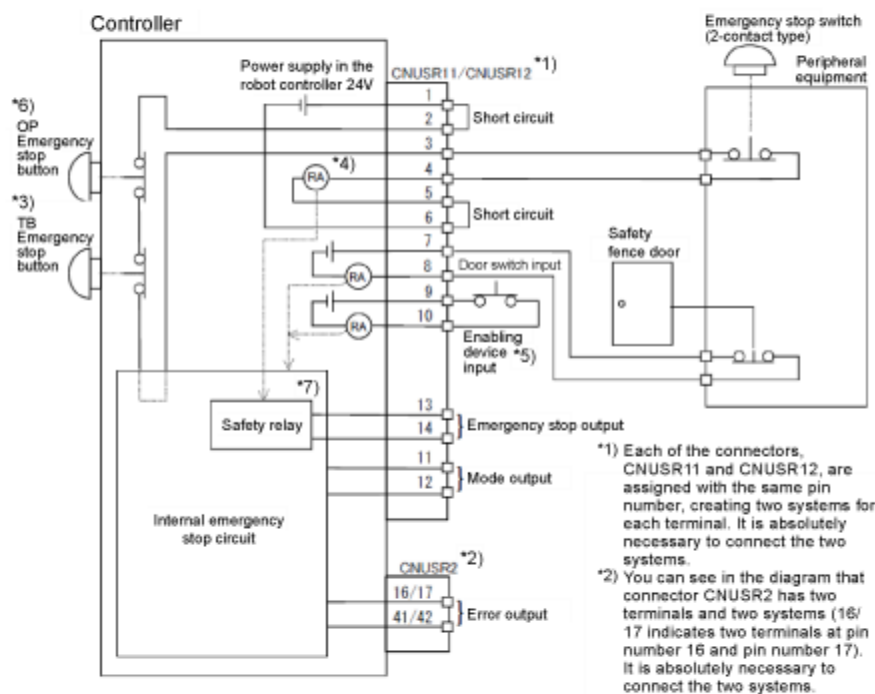

- *3) The T/B emergency stop button connected with the controller.
- *4) Emergency stop input relay.
- *5) Refer to Standard specification manual for the enabling device.
- *6) The emergency stop button of the robot controller. (Only specification with the operation panel.)
- *7) The emergency stop input detection relay is used the controller's internal safety relay control. If the emergency stop input detection relay is switched OFF, emergency stop is detected and the safety relay is also switched OFF.

- For more details, refer to the specifications of the model in use.
- Do not carry out wiring that is not shown in specifications or manuals. Otherwise, a malfunction or failure occurs.
- Part of the internal circuit is simplified.
- The circuit is a dual-redundant.

2.6**Summary**

In this chapter, you have learned:

- Connecting devices
- Connecting a teaching pendant
- Teaching pendant language setting
- Origin setting
- Example of safety measures

Important points

The contents you learned in this chapter are listed below.

Connecting devices	<ul style="list-style-type: none">• You have learned to connect devices.
Connecting a teaching pendant	<ul style="list-style-type: none">• Connect or disconnect a teaching pendant when the robot controller is OFF.
Teaching pendant language setting	<ul style="list-style-type: none">• You have learned to switch languages of the teaching pendant.
Origin setting	<ul style="list-style-type: none">• Required when a robot is activated for the first time.
Safety measures	<ul style="list-style-type: none">• To use a robot, safety measures are absolutely necessary.

Chapter 3 PROGRAMMING



3.1

Introduction of RT ToolBox2

Use the program creation and total engineering support software "RT ToolBox2" to develop programs for the MITSUBISHI industrial robot MELFA.

RT ToolBox2 is software for a personal computer and supports the phases including system setup, debug, and operation. The software enables you to create and edit programs, check the operational range before the introduction of a robot, estimate the tact time, perform debug operations at the activation of the robot, and monitor the status and errors during operations.

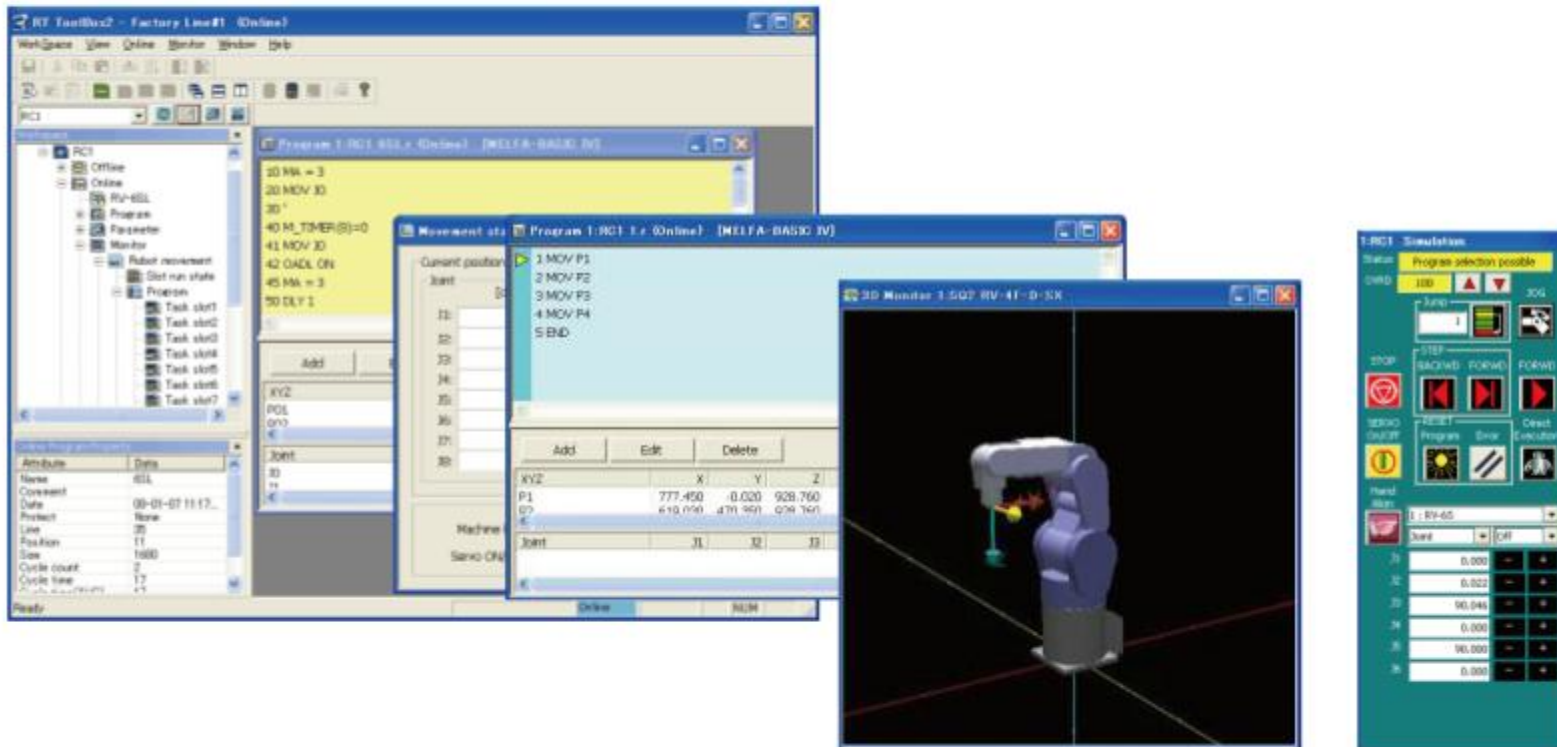

Operation windows of RT ToolBox2

3.2 Workspace Creation, Communication Setting (USB), and Connection

Workspace creation and communication settings are required to use RT ToolBox2.

This course describes the communication setting with a USB connection.

On the next page, simulate workspace creation and a communication setting using actual windows.

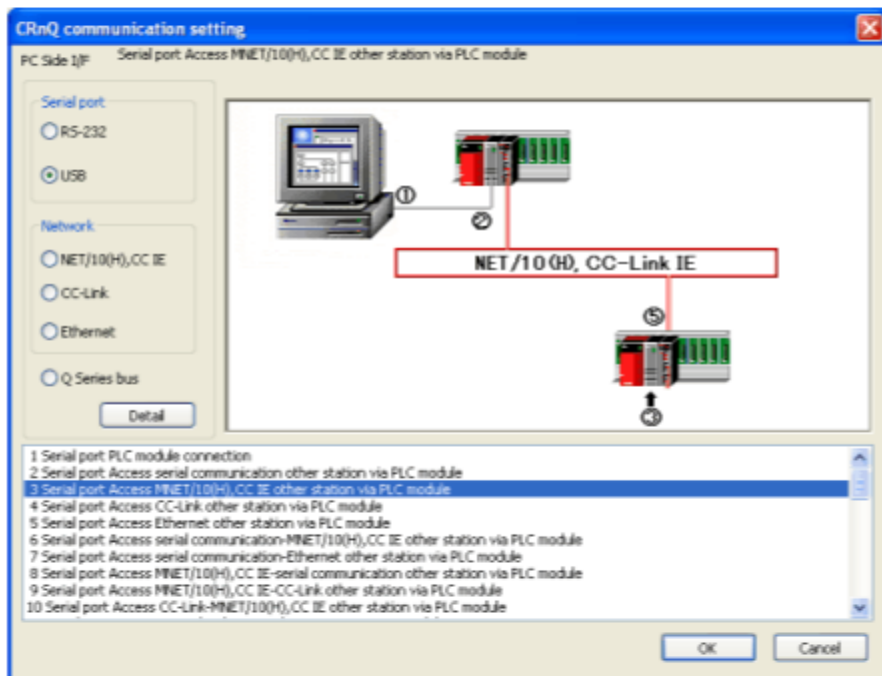

A USB driver is required to be installed before a robot controller and personal computer is connected through the USB.

For details, refer to the RT ToolBox2 manual.



3.2 Workspace Creation, Communication Setting (USB), and Connection

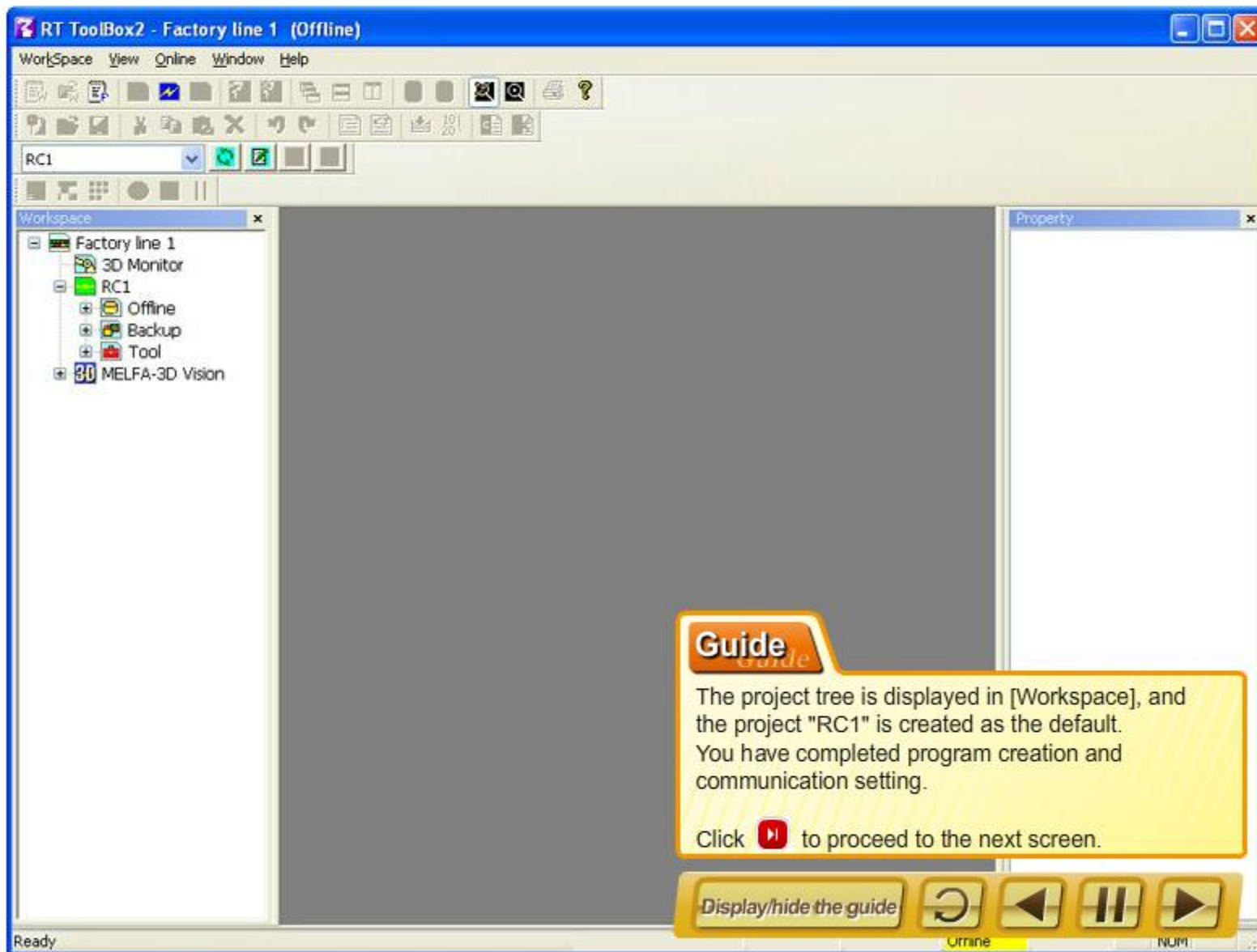

The screenshot displays the RT ToolBox2 software interface for "Factory line 1 (Offline)". The main workspace area is currently empty. On the left, a "Workspace" tree view shows the project structure:

- Factory line 1
 - 3D Monitor
 - RC1
 - Offline
 - Backup
 - Tool
 - MELFA-3D Vision

The "Property" window on the right is empty. A yellow "Guide" box is overlaid on the bottom right of the workspace, providing instructions:

Guide

The project tree is displayed in [Workspace], and the project "RC1" is created as the default. You have completed program creation and communication setting.

Click  to proceed to the next screen.

At the bottom of the interface, there is a control bar with the following elements:

- Ready
- Display/hide the guide
- Offline
- NUM

3.3

Writing and Saving Programs

Programs are written and saved with RT ToolBox2.

In this section, create a new robot program in a personal computer.

On the next page, simulate program writing and saving using actual windows.

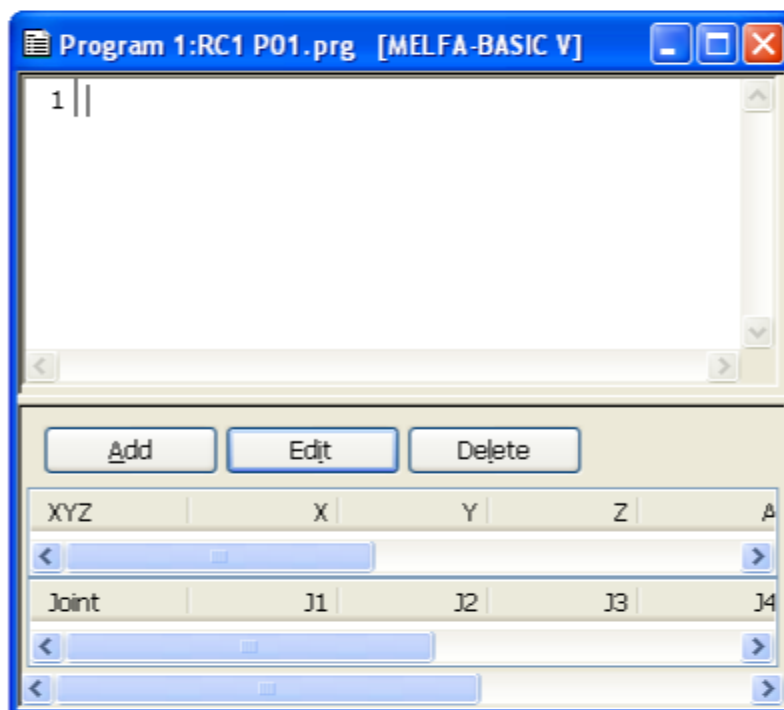

3.4

Transferring Programs to a Controller

To operate a robot, a created program needs to be saved in the robot controller. You will learn to transfer a program file from a personal computer to a robot controller using RT ToolBox2.

On the next page, simulate a program transfer using the program management window.

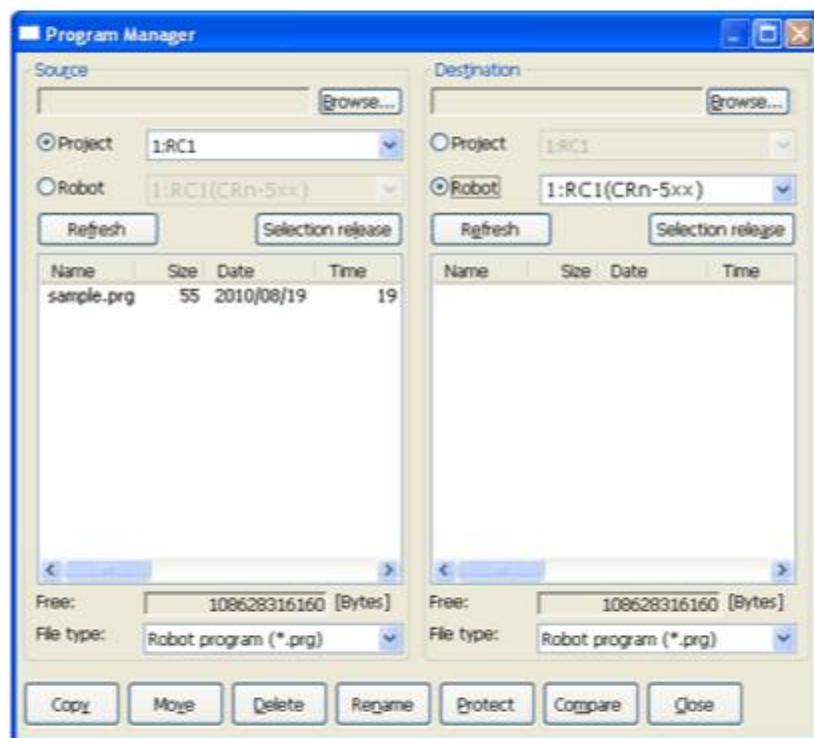

RT ToolBox2 - Factory line 1 (Online)

WorkSpace View Online Window Help

RC1

Program Manager

Source

Browse...

Project: 1:RC1

Robot: 1:RC1(CRnX-7xx)

Refresh Selection release

Name	Size	Date	Time
test.prg	55	2015/03/18	09:47:30

Free: 106164621312 [Bytes]

File type: Robot program (*.prg)

Copy Move Delete Rename Protect Compare Close

Destination

Browse...

Project: 1:RC1

Robot: 1:RC1(CRnX-7xx)

Refresh Selection release

Name	Size	Date	Time
TEST	660	15/03/18	10:35:09

Free: 104857600 [Bytes]

File type: Robot program (*.prg)

Guide

You have completed transferring a program.

Click to proceed to the next screen.

Display/hide the guide

Ready Online NUM_SURL

In this chapter, you have learned:

- Introduction of RT ToolBox2
- Workspace creation, communication setting (USB), and connection
- Writing and saving programs
- Transferring programs to a controller

Important points

The contents you learned in this chapter are listed below.

Introduction of RT ToolBox2	<ul style="list-style-type: none">• This software supports all the phases including system setup, debug, and operation.
Workspace creation, communication setting (USB), and connection	<ul style="list-style-type: none">• You have learned about workspace creation and communication setting.
Writing and saving programs	<ul style="list-style-type: none">• You have learned about writing and saving programs.
Origin setting	<ul style="list-style-type: none">• You have learned to transfer a program from a personal computer to a robot controller.

Chapter 4 ROBOT OPERATION

Chapter 4 covers robot operations with a teaching pendant.

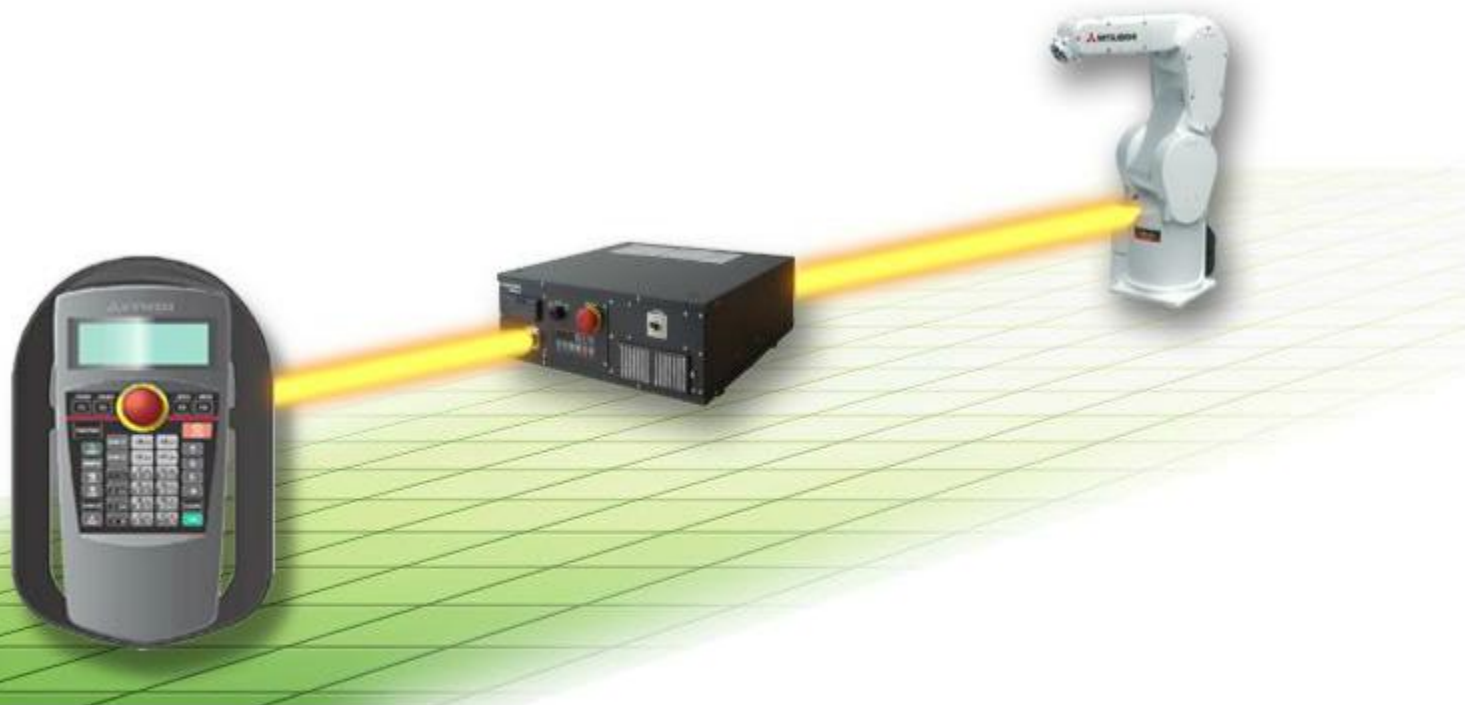

This section describes the names and functions of parts of the teaching pendant (R32TB/R33TB).

[Names and functions of parts]

Putting the mouse cursor over each part in the table or on the figure of the teaching pendant highlights the corresponding part or description.

No	Name	Description
①	[Emergency stop] switch	The robot servo turns OFF and the operation stops immediately.
②	[Enable/Disable] switch	This switch enables or disables the robot operations with the teaching pendant.
③	Enable switch (3-position switch)	When the [Enable/Disable] switch is enabled, and this key is released or pressed with force, the servo will turn OFF, and the operating robot will stop immediately.
④	LCD display panel	The robot status and various menus are displayed.
⑤	Status display lamp	Display the state of the robot or T/B.
⑥	[F1], [F2], [F3], [F4] key	Execute the function corresponding to each function currently displayed on LCD.
⑦	[FUNCTION] key	This key switches the function display, and changes the functions assigned to [F1], [F2], [F3], and [F4] keys.
⑧	[STOP] key	This stops the program and decelerates the robot to a stop.
⑨	[OVRD↑][OVRD↓] key	These keys change the speed override of the robot.
⑩	[JOG operation] key (12 keys from [-X(J1)] to [+C(J6)])	Move the robot according to jog mode. And, input the numerical value.
⑪	[SERVO] key	Pressing this key while the [Enable] switch is lightly held turns ON the robot servo.
⑫	[MONITOR] key	It becomes monitor mode and display the monitor menu.
⑬	[JOG] key	It becomes jog mode and display the jog operation.
⑭	[HAND] key	It becomes hand mode and display the hand operation.
⑮	[CHARACTER] key	This changes the edit screen, and changes between numbers and alphabetic characters.
⑯	[RESET] key	This resets the error. The program reset will execute, if this key and the [EXE] key are pressed.
⑰	[↑][↓][←][→] key	Moves the cursor each direction.
⑱	[CLEAR] key	Erase the one character on the cursor position.
⑲	[EXE] key	Input operation is fixed. And, while pressing this key, the robot moves when direct mode.
⑳	Number/Character key	Pressing this key while numerical input or character input is enabled displays a number or character.

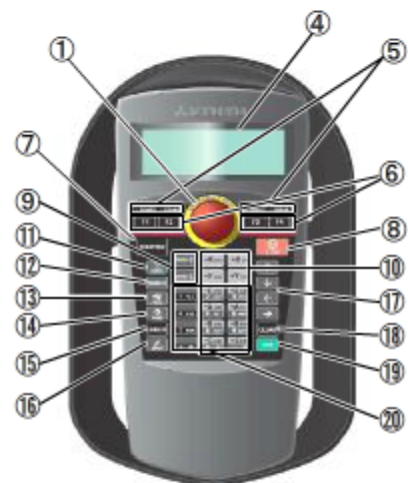

4.2

Jog Operation on the Teaching Pendant

In this section, move the robot manually using the teaching pendant to check that the robot properly operates.

The manual operation on a robot is called "jog operation". This operation includes the JOINT jog, which moves each axis, the XYZ jog, which moves the robot along the base coordinate system, the TOOL jog, which moves the robot along the tool coordinate system, and the CYLINDER jog, which moves the robot along the circular arc.

When actually operating a robot manually, hold the 3-position [Enable] switch, which is located on the back of the teaching pendant.

(Releasing or strongly pressing this switch turns OFF the robot servo. When performing jog operation, always hold this switch lightly.)

Use the following operation simulator to check each jog operation.

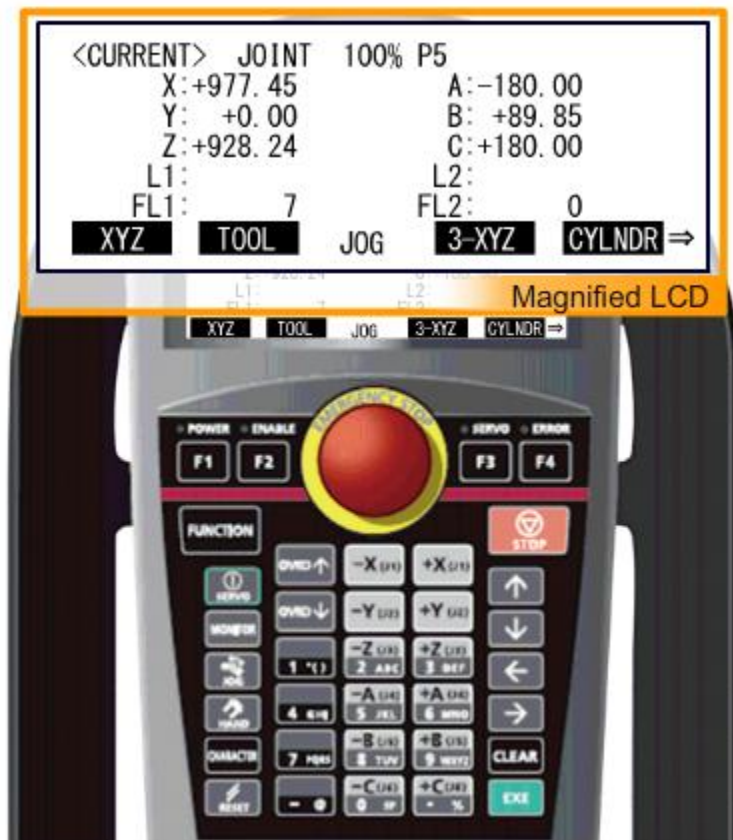

Guide

Pressing the [+Y(J2)] key moves the arm in the positive direction along Y-axis.

Pressing the [-Y(J2)] key moves the arm in the negative direction.

Check the operation, and click  at the upper right of this screen to proceed to the next page.

Display/hide the guide



4.3 Tool Setting Procedure

When a hand is attached to the robot, setting the hand tip as a control point of the robot may facilitate the operation. In such a case, setting tool data for the robot is necessary. There are three methods of setting the data.

- MEXTL parameter
- Tool instruction in the robot program
- Setting a tool number for the M_Tool variable (The values in the parameters from MEXTL1 to MEXTL4 are the tool data.)

[Operations before and after the tool setting]



Before the tool setting



After the tool setting

4.3 Tool Setting Procedure

In this section, simulate the tool setting.

Use the following operation simulator to set a parameter using the MEXTL parameter.



<PARAMETER>	NAME (MEXTL)
DATA	ELE (3)
(100.00)	
DATA	Prev 123 Next CLOSE

Guide

You have completed the tool setting.

Click  to proceed to the next screen.

Display/hide the guide    

4.4 Hand Open/Close

This section describes the open/close operations on the hand attached to a robot.

The teaching pendant can open/close four hands with the standard setting. Hand 1 is assigned to the C-axis, hand 2 to the B-axis, hand 3 to the A-axis, and hand 4 to the Z-axis. Pressing the [+] key opens the hands and the [-] key closes them.

Use the following operation simulator to open/close hand 1.

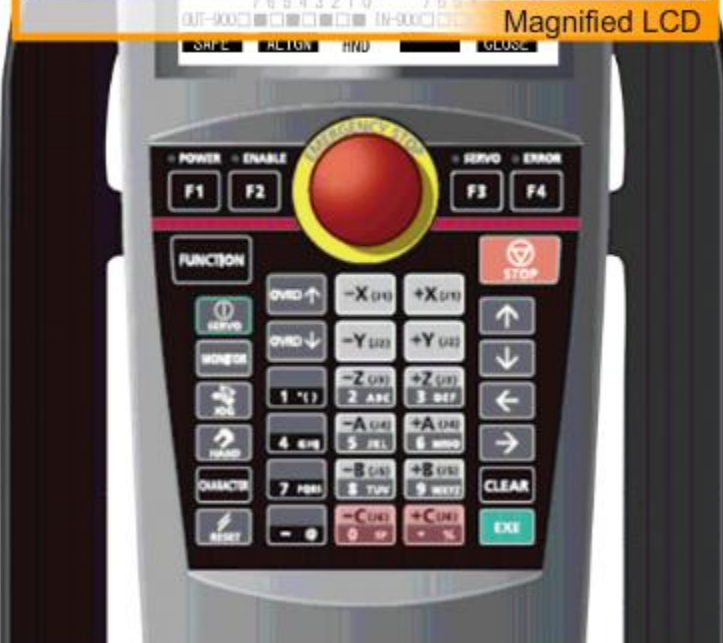
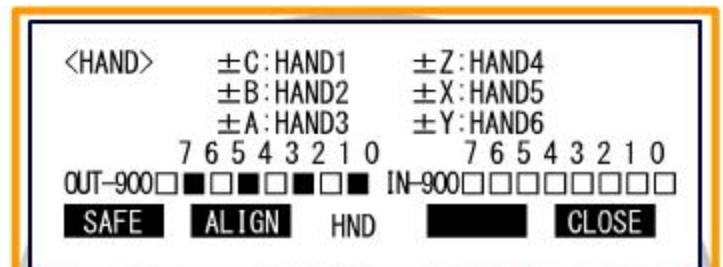

Guide

OUT-900 indicates the open/close state of the hand, and IN-900 indicates the ON/OFF state of the hand check input signal.

Press the [+C] key to open hand 1 and [-C] key to close. Check the operation, and click  at the upper right of this screen to proceed to the next page.



4.5 Hand Alignment

The posture of the hand attached to the robot can be aligned in units of 90 degrees. This feature moves the robot to the position where the A, B, and C components of the current position are set at the closest values in units of 90 degrees.

Use the following operation simulator to align a hand.



Guide

You have completed hand alignment.

Click to proceed to the next screen.

Display/hide the guide

4.6

Teaching

After a robot is moved to a position with jog operation or other methods, the position can be taught to a position variable in the program. The position is overwritten (corrected) if teaching has already been carried out. There are two methods of teaching: command edit screen and position edit screen.

Use the following operation simulator of the command edit screen to carry out teaching.

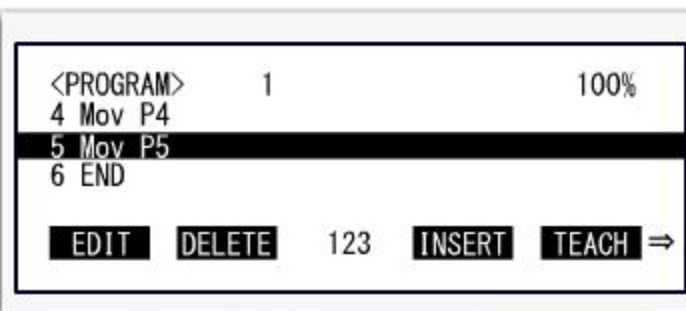

Guide

You have completed the teaching operation.

Click  to proceed to the next screen.

Display/hide the guide



4.7 Operation Check (Step Feed)

Before starting automatic operation on a robot, check the operation by executing each step of the program (step feed).

Use the following operation simulator to check the step feed operation.

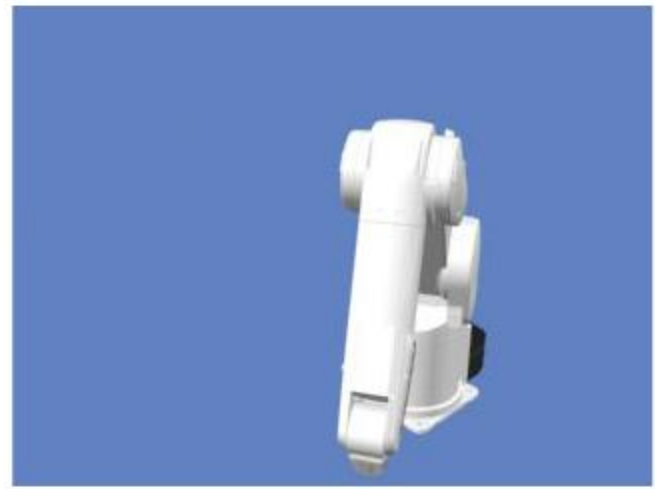

Guide

You have completed the operation check (step feed).

Click  to proceed to the next screen.

Display/hide the guide    

4.8**Summary**

In this chapter, you have learned:

- Names and functions of parts of the teaching pendant
- Jog operation on the teaching pendant
- Tool setting procedure
- Hand open/close, hand alignment
- Operation check (step feed)

Important points

The contents you learned in this chapter are listed below.

Names and functions of parts of the teaching pendant	<ul style="list-style-type: none">• You have learned about the names and functions of parts of the teaching pendant.
Jog operation on the teaching pendant	<ul style="list-style-type: none">• You have learned about the jog operation and movement with the teaching pendant.
Tool setting procedure	<ul style="list-style-type: none">• You have learned about the tool setting procedure.
Hand open/close, hand alignment	<ul style="list-style-type: none">• You have learned to open/close and align a hand.
Operation check (step feed)	<ul style="list-style-type: none">• You have learned to check the operation by step feed.

Chapter 5 AUTOMATIC OPERATION

Chapter 5 covers robot automatic operation.

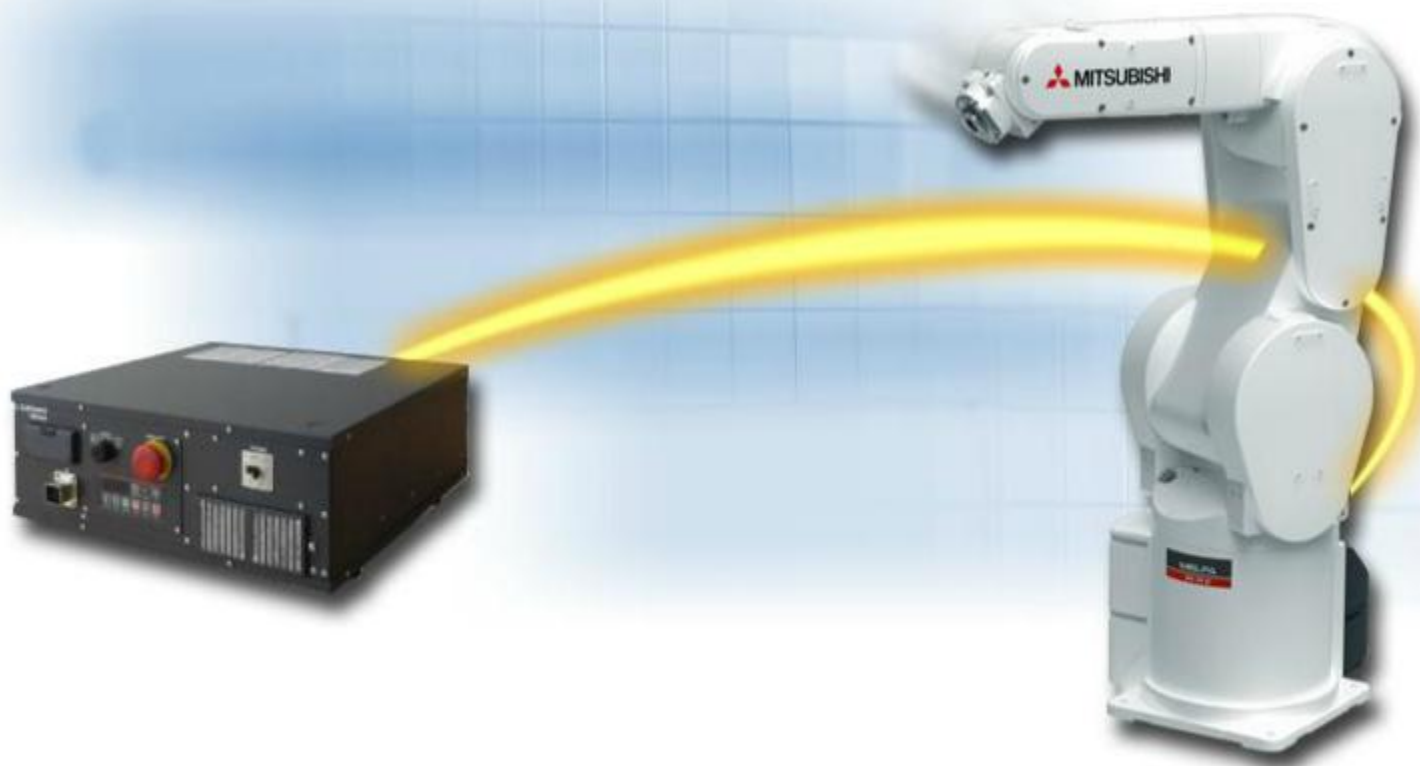

5.1

Names and Functions of Parts of the Operation Panel

This section describes the names and functions of parts of the operation panel.

[Names and functions of parts]

Putting the mouse cursor over each part in the table or on the figure of the operation panel highlights the corresponding part or description.

No	Name	Description
①	START button	This executes the program and operates the robot.
②	STOP button	This stops the robot immediately. The servo does not turn OFF.
③	RESET button	This resets the error.
④	Emergency stop switch	This switch stops the robot in an emergency state. The servo turns OFF.
⑤	CHNGDISP button	This button switches the display on the panel in the order of "override" → "line number" → "program No." → "user information" → "manufacturer information".
⑥	END button	This stops the program being executed at the last line or END statement.
⑦	SVO.ON button	This turns ON the servo power. (The servo turns ON.)
⑧	SVO.OFF button	This turns OFF the servo power. (The servo turns OFF.)
⑨	STATUS.NUMBER (Display panel)	The alarm No., program No., override value (%), etc., are displayed.
⑩	Mode key switch	This key switch changes the robot's operation mode.
⑪	UP/DOWN button	This scrolls up or down the details displayed on the "STATUS. NUMBER" display panel.
⑫	T/B connection connector	This is a dedicated connector for connecting the T/B.
⑬	Interface cover	USB interface and battery are mounted.

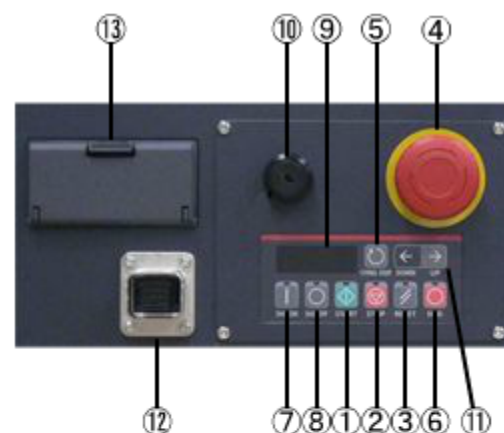

5.2

Operations on the operation panel

This section describes operations on the operation panel.

This section shows an example of how the operating speed setting is changed and the program is started.

Use the following operation simulator to start the program.

**Guide**

You have learned about operations on the operation panel.

Click  to proceed to the next screen.

Display/hide the guide



5.3**Summary**

In this chapter, you have learned:

- Names and functions of parts of the operation panel
- Operations on the operation panel

Important points

The contents you learned in this chapter are listed below.

Names and functions of parts of the operation panel	<ul style="list-style-type: none">• You have learned about the names and functions of parts of the operation panel.
Operations on the operation panel	<ul style="list-style-type: none">• You have learned about operations on the operation panel.

Chapter 6 MAINTENANCE

Chapter 6 covers maintenance and inspection required for long trouble-free service of robots.



6.1 Maintenance and Inspection

Maintenance and inspection include daily checks and periodic checks. The checks are necessary to prevent failures for safety and prolonged use.

The maintenance and inspection cycles and the check list are shown below.

[Maintenance and inspection cycle] (For RV-2F-Q/D)

< Inspection schedule >

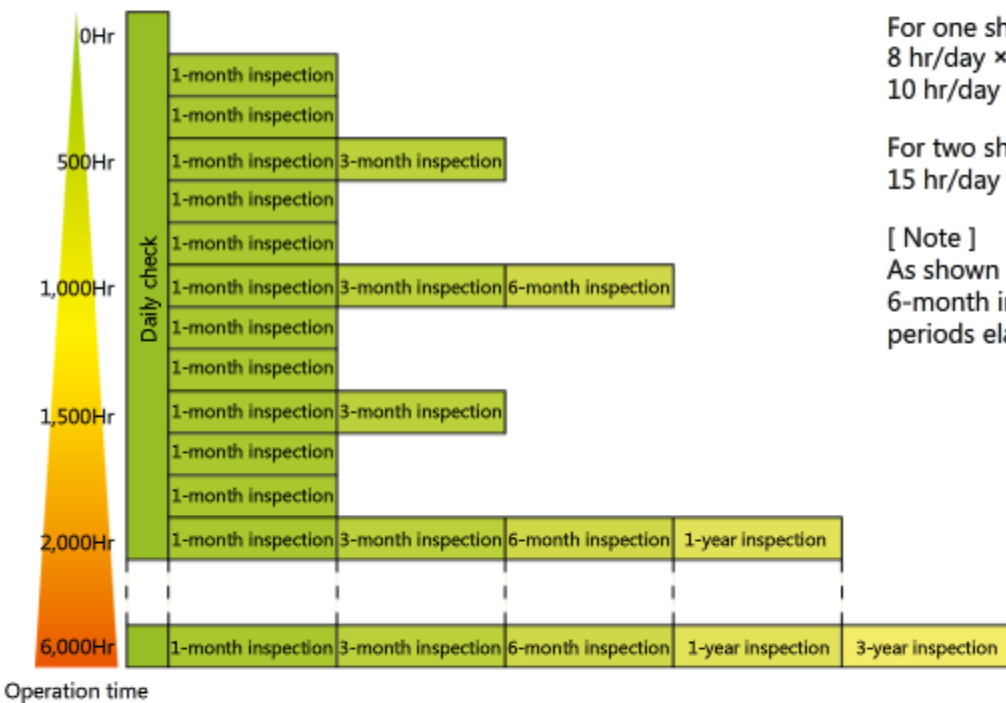

< Estimation of inspection cycle >

For one shift
 8 hr/day × 20 days/month × 3 months = approx. 500 hr
 10 hr/day × 20 days/month × 3 months = approx. 600 hr

For two shifts
 15 hr/day × 20 days/month × 3 months = approx. 1,000 hr

[Note]
 As shown above, for two shifts, carry out 3-month inspection, 6-month inspection, and 1-year inspection when half the periods elapses.

[Check item] (For RV-2F-Q/D)

< Daily check item >

Step	Check item (detail)	Remedy
Before power-ON (Check the following items before power-ON.)		
1	Check the robot for loose installation bolts. (Visual check)	Tighten the bolts securely.
2	Check the cover for loose fixing screws. (Visual check)	Tighten the screws securely.
3	Check the hand for loose fixing bolts. (Visual check)	Tighten the bolts securely.
4	Check that the power cable is securely connected. (Visual check)	Connect the cable securely.
5	Check that the cables between the robot and controller are securely connected. (Visual check)	Connect the cable securely.
6	Check that there are no cracks and foreign substances on the robot and no objects that cause interference with the robot.	Replace parts with new ones, or take temporal measures.
7	Check that no leakage of grease is found from the robot body. (Visual check)	Clean the robot, and fill grease.
8	Check that the air pressure system is in a normal condition. Check that air is not leaked, water is not collected in the drain, the hoses are not folded, and the air source is in a normal condition. (Visual check)	Take measures against water collection and air leakage (or replace parts).
After power-ON (Watch the robot when turning it ON.)		
1	Check that powering ON the robot does not cause to abnormal operation or sound.	Refer to troubleshooting.
During operation (Use your own program.)		
1	Check that the point of operation is not deviated from alignment. Check the following if a deviation occurs. 1: Check that the installation bolts are secure. 2: Check that the hand fixing bolts are secure. 3: Check that the jigs around the robot are not displaced. 4: If the position is not corrected, refer to "Troubleshooting" and carry out checking and take measures.	Refer to troubleshooting.
2	Check abnormal operation or noise. (Visual check)	Refer to troubleshooting.

6.1

Maintenance and Inspection

[Check item] (For RV-2F-Q/D)

< Periodic check list >

Step	Check item (detail)	Remedy
1-month check item		
1	Check that the bolts and screws used for the robot body are secure.	Tighten the bolts securely.
2	Check that the connector fixing screws and terminal screws on the terminal block are secure.	Tighten the screws securely.
3	Remove all covers, and check that no scratches by rubbing and foreign substances are on the cables.	Examine the cause and eliminate. If a cable is considerably damaged, contact MITSUBISHI service sector.
3-month check item		
1	Check that the tension in the timing belt is proper.	Adjust the tension if the belt is too stretched or too loosened.
6-month check item		
1	Check that the tooth part of the timing belt is not too worn out.	If the teeth are considerably chipped or worn out, replace the belt.
1-year check item		
1	Replace the backup batteries in the robot.	Refer to "Section 6.4 Battery Replacement Procedure" to replace the batteries.
3-year check item		
1	Lubricate the grease at the reduction gears for each axis.	Refer to "Section 6.3 Greasing Procedure" to carry out greasing.

6.2**Filter Inspection/Cleaning/Replacement Procedure**

A filter is installed in the controller.

The following shows the procedure for cleaning the filter.

**Guide**

You have completed filter inspection and cleaning.

Click  to proceed to the next screen.



6.3 Greasing Procedure

The following shows the locations of greasing and the replacement procedure. (For RV-2F-Q/D)
 (The procedure may differ depending on the model. For details, refer to the manual for the model in use.)

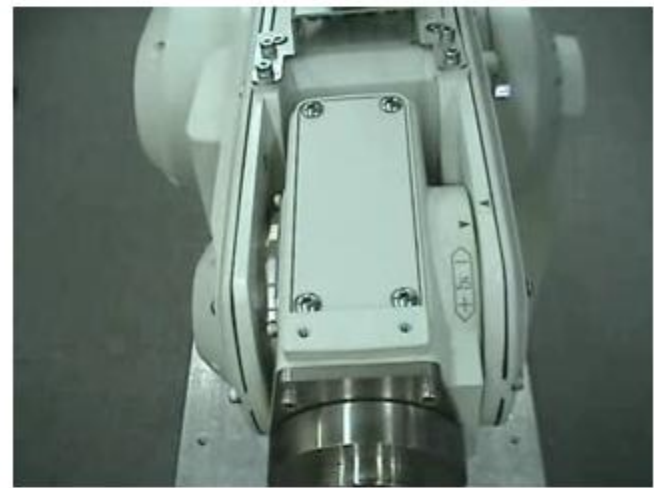
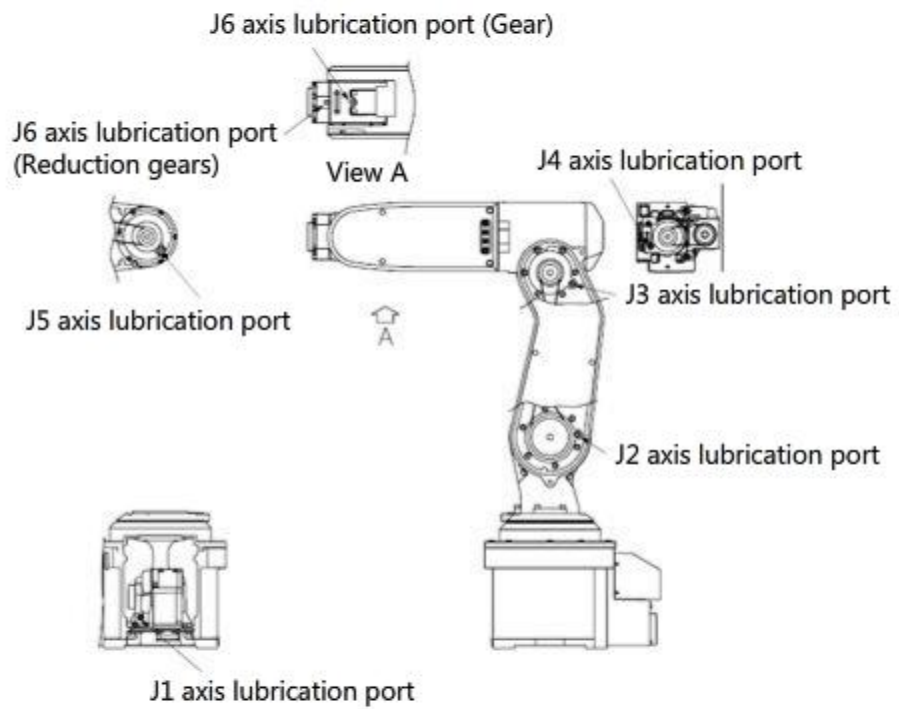

6.4 Battery Replacement Procedure

[Robot arm]

An absolute encoder is installed into the robot to detect the position on each axis.

While the power is shut OFF, the position data in the encoder is backed up by backup batteries.

The batteries are installed at production shipments. Replace these consumables approximately once a year.

If the batteries are replaced after running out, the ABS origin setting described in section 6.5 is necessary.

For the battery replacement procedure, watch the video below.

(The procedure may differ depending on the model. For details, refer to the manual for the model in use.)



6.4 Battery Replacement Procedure

[Robot CPU]

In the robot CPU, programs and parameter data are stored. While the power is shut OFF, programs and other data saved in the robot CPU are backed up by the backup battery. The battery is installed at production shipments. Replace this consumable approximately once a year.

Replace the battery shown in the figure below.

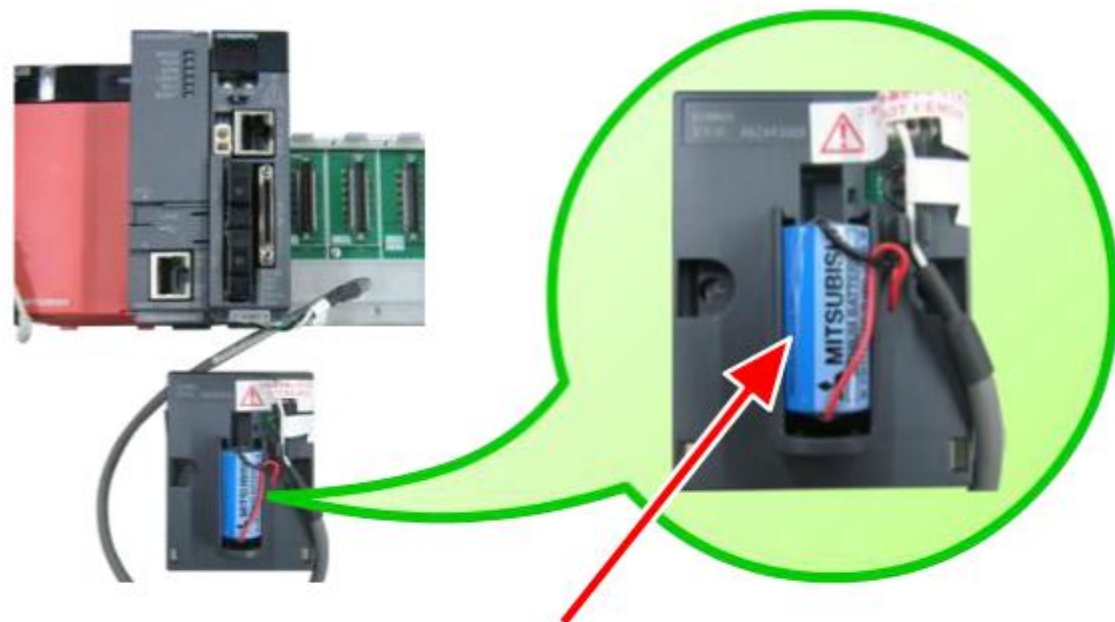

Take out here, and replace the battery.

6.5

Resetting the Origin (ABS Origin Setting)

When the origin setting of the robot is performed for the first time, the MITSUBISHI industrial robot MELFA records the angular position of the origin within one rotation of the encoder as the offset value. If the origin setting is performed using the ABS origin method, this value is used to suppress variations in the origin setting operations and to reproduce the initial origin position accurately.

If the battery goes dead and the origin data at shipment is erased, it is necessary to set the origin again. This section introduces the ABS method that is necessary for the reset.



<ABS>

J1: (0) J2: (1) J3: (1)
 J4: (1) J5: (1) J6: ()
 J7: () J8: ()

123 CLOSE

Guide

You have completed the origin setting with the ABS method.

Click  to proceed to the next screen.

Display/hide the guide



6.6

Jig-method Origin Setting

This section introduces the procedure for setting an origin using jigs.

When the motor is replaced or the robot position is misaligned, the origin needs to be set again. This section introduces the jig method that is necessary for the reset.

For the details of the origin setting with the jig method, watch the video below.

(The procedure may differ depending on the model. For details, refer to the manual for the model in use.)



In this chapter, you have learned:

- Maintenance and inspection
- Filter inspection/cleaning/replacement procedure
- Greasing procedure
- Battery replacement procedure
- ABS origin setting
- Jig-method origin setting

After-sales service

Mitsubishi Electric System & Service Co., Ltd. will be the contact for maintenance service including repairs and inspection. Please consult your local Mitsubishi Electric System & Service Co., Ltd.

Important points

The contents you learned in this chapter are listed below.

Maintenance and inspection	• You have learned about the maintenance and inspection cycles and the check items.
Filter inspection / cleaning / replacement procedure	• You have learned about the filter inspection, cleaning, and replacement procedures.
Greasing procedure	• You have learned to grease the robot.
Battery replacement procedure	• You have learned to replace batteries in the robot and robot controller.
ABS origin setting	• You have learned about the origin setting with the ABS method.
Jig-method Origin Setting	• You have learned about the origin setting with the jig method.

Now that you have completed all of the lessons of the **INDUSTRIAL ROBOT MELFA BASIC OPERATIONS AND MAINTENANCE (F SERIES Q TYPE)** Course, you are ready to take the final test. If you are unclear on any of the topics covered, please take this opportunity to review those topics.

There are a total of 12 questions (57 items) in this Final Test.

You can take the final test as many times as you like.

How to score the test

After selecting the answer, make sure to click the **Score** button. Failure to do so will not score the test. (Regarded as unanswered questions.)

Score results

The number of correct answers, the number of questions, the percentage of correct answers, and the pass/fail result will appear on the score page.

Correct answers : 3

Total questions : 10

Percentage : 30%

To pass the test, 60% of correct answers is required.

Proceed

Review

Retry

- Click the **Proceed** button to exit the test.
- Click the **Review** button to review the test. (Correct answer check)
- Click the **Retry** button to retry the test multiple times.

Configuration of MITSUBISHI industrial robot MELFA

The following text describes the configuration of the MITSUBISHI industrial robot MELFA. Fill in each gap with an appropriate option.

The MITSUBISHI industrial robot MELFA has two series: , which is the vertical, multiple-joint type, and , which is the horizontal, multiple-joint type.

Two types of the robot controller are available: , which is the standalone robot controller, and , which is the iQ Platform-compatible controller.

Robot model name

Select model names that match each specification.

Robot specifications	Model name
Vertical, multiple-joint type, D type, load capacity of 7 kg	--Select-- ▼
Horizontal, multiple-joint type, D type, load capacity of 6 kg	--Select-- ▼
Vertical, multiple-joint type, Q type, load capacity of 7 kg, long arm	--Select-- ▼
Horizontal, multiple-joint type, Q type, load capacity of 12 kg	--Select-- ▼

Answer

Back

Origin setting with the teaching pendant

The following text describes connection of the teaching pendant and the origin setting with the teaching pendant. Fill in each gap with an appropriate option.

The teaching pendant must be connected during power . If the power is and no teaching pendant is connected to the controller, an emergency stop alarm occurs.

To use a robot without a teaching pendant connected, connect the accompanying --Select-- instead of a teaching pendant.

At setup, the --Select-- (with the data input method) is required with the teaching pendant. This is an operation to establish origins of each axis for accurate robot control.

Teaching pendant language setting

The following text describes the language setting for the teaching pendant. Select an appropriate option for each gap.

1. Turn on the teaching pendant with both the [F1] key and on the teaching pendant held.
2. On the initial setting screen, press the [F1] key to select "1. Configuration".
3. On the screen displayed, select by pressing the [F1] key to display the language setting screen.
4. To select Japanese, press the [F1] or . This displays on the screen.
5. Press the to confirm the setting.
6. Press the [EXE] key to display the exit screen.
7. Press the [F1] key to the setting.
8. Pressing the [EXE] key activates the teaching pendant with the display in the set language.

Functions of RT ToolBox2

The following table lists the functions of RT ToolBox2.
Select ○ for correct descriptions and × for incorrect ones.

Function	Answer
Creating robot programs	<input type="checkbox"/>
Jog operation on robot	<input type="checkbox"/>
Checking robot operational range	<input type="checkbox"/>
Estimating tact time of robots	<input type="checkbox"/>
Switching robot operation modes between manual and automatic	<input type="checkbox"/>

Procedure for operating RT ToolBox2

The following text describes the procedure for creating a program with RT ToolBox2 and transferring the program to the robot controller. Select an appropriate option for each gap.

1. Activate .
2. Create a new .
3. In the project setting window, configure the communication setting to communicate with the robot controller.
4. Select [Offline] → [Program] from the menu, and create a new program file to a program.
5. the program on the personal computer.
6. the program from the computer to the robot controller.

Names of parts of the teaching pendant

Select the names of parts of the teaching pendant that are required to use in the operations below.

Operation	Name
Switch that turns OFF the robot servo and immediately stops the robot regardless of whether the teaching pendant is enabled or disabled	--Select-- ▼
Switch that enables or disables the robot operations with the teaching pendant.	--Select-- ▼
Releasing or strongly pressing this switch in the manual mode turns OFF the robot servo. To carry out operations that can be performed while the robot servo is ON, such as jog, this switch must be lightly held.	--Select-- ▼
These keys change the speed override of the robot.	--Select-- ▼

[Answer](#)[Back](#)

Operation check with the teaching pendant

The following text describes the procedure for checking a program with a teaching pendant. Select an appropriate option for each gap.

1. Open the for the program.
2. Press the to display "FWD" and "BWD" on the function menu at the bottom of the screen.
3. Hold the lightly and press the [SERVO] key to turn ON the robot servo.
4. The step on which the cursor is put is executed while [F1] (FWD) is held. When the key is released in the middle of the operation, the operation is interrupted.
5. During the operation, the LED of the on the operation panel is lit. When the execution of one step is complete, the LED of [Q4] turns OFF and the LED of the is lit. When the key is released, the cursor on the screen of the teaching pendant moves to the next step.

*For safety, set a small override value.
6. Check the operations by repeating this procedure step by step.

Names of parts of the operation panel

Select the names of parts of the operation panel that are required to use in the operations below.

Operation	Name
Executes programs to operate the robot. The programs run in continuous operation.	--Select--
Stops the running program at the last step or the End statement.	--Select--
Clears errors. Also, cancels a program pause and resets the	--Select--
Stops the robot immediately. The robot servo is not turned OFF.	--Select--

Answer

Back

Automatic operation procedure

The following text describes the procedure for automatic operation of a robot program.
Select an appropriate option for each gap.

1. Set the on the teaching pendant to "DISABLE", and set the [MODE] switch on the controller to .
2. Check that is displayed in the STATUS NUMBER display on the robot controller.
Press the [DOWN] button to reduce the operating speed.
3. Press the [CHANG DISP] button to display on the STATUS NUMBER display.
Press the [UP] button or [DOWN] button to displays the automatic operation target program.

*If the program name cannot be selected, press the [RESET] button to cancel the stop condition of the robot.
4. Press the [SVO ON] switch. , and the green lamp is lit.
5. Press the [START] button to start (continuous operation). If the [END] button is pressed during a continuous operation, the operation stops when one cycle ends.
6. Press the [STOP] button to decelerate and stop immediately the robot. If the [START] button pressed again, the automatic operation restarts (repetitive operation).

Check item

Select the inspection cycles for the check items below.

Check item	Inspection timing
Tension of the timing belt	--Select-- ▼
Leakage of grease from the robot body	--Select-- ▼
Replacement of backup batteries	--Select-- ▼
Cracks and foreign substances on the robot and objects that cause interference	--Select-- ▼
Greasing the reduction gear of each axis	--Select-- ▼

[Answer](#)[Back](#)

Replacement of the battery in a robot

The following texts describe the procedure for replacing the batteries in a robot. Select correct step numbers.

- Replace the old backup batteries with new ones one by one.
Replace all batteries at one time.
- Turn OFF the power.
- Install the battery cover.
- Remove the battery cover.
- Check that all backup batteries have been replaced with new ones.
If an old one is still included, it may generate heat and be damaged.

Test**Test Score**

You have completed the Final Test. Your results are as follows.
To end the Final Test, proceed to the next page.

Correct answers : **0**

Total questions : **12**

Percentage : **0%**

You failed the test.

You have completed the **INDUSTRIAL ROBOT MELFA BASIC OPERATIONS AND MAINTENANCE (F SERIES Q TYPE)** Course.

Thank you for taking this course.

We hope you enjoyed the lessons and the information you acquired in this course is useful for configuring systems in the future.

You can review the course as many times as you want.

Review

Close