



PROGRAMMABLE CONTROLLERS
MELSEC-F

Learning by Relay Sequences...

Your First PLC

Introduction

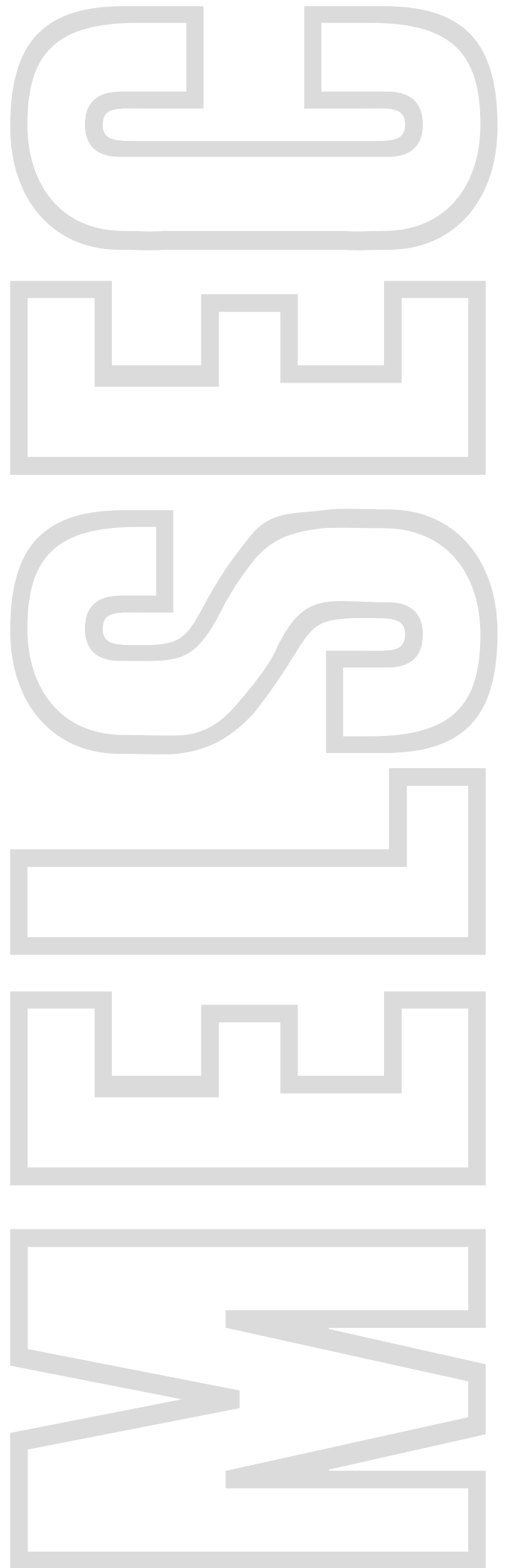

● Safety Precautions ●

(Be sure to read this before the training.)

Before designing a system, be sure to read this manual and pay close attention to safety.

During the training, pay attention to the following points to ensure correct handling.

[Precautions for Training]

WARNING

- To prevent electric shock, do not touch the terminals while they are powered ON.
- Before removing safety covers, either turn the power supply OFF or confirm safety.
- Do not put your hand into moving parts.

CAUTION

- Proceed with the training under the guidance of a teacher.
- Do not remove the training machine module or change the wiring without permission. Doing so may result in malfunction, misoperation, injury or fire.
- Before attaching or detaching the module, turn the power OFF. Attaching or detaching the module while it is still ON may cause the module to malfunction or cause an electric shock.
- If unusual sound is detected with the training machine (X/Y table, etc.) immediately turn the power switch to OFF.
- If an abnormality event occurs, immediately contact your teacher.

INTRODUCTION

This text book introduces basic knowledge you should be aware of for sequence control together with simple examples for first-time users of PLCs.

Descriptions in this text book are primarily for the teaching material FX-I/O demonstration2 model that uses the micro PLC FX3G-14MR/ES type.

The following shows related materials:

- FX3G Series main unit
 - FX3G Series Hardware Manual.....JY997D33401
 - FX3G Series User's Manual [Hardware Edition]JY997D31301

- Programming
 - FX3S/FX3G/FX3GC/FX3U/FX3UC Series Programming Manual
[Basic & Applied Instruction Edition]JY997D16601

- Handy programming panel
 - FX-30P Installation Manual.....JY997D34201
 - FX-30P Operation Manual.....JY997D34401

Registration

- Windows, Windows 7, Windows 8 are registered trademarks of Microsoft Corporation in the United States and other countries.
- All other company names and product names used in this document are trademarks or registered trademarks of their respective companies.

This document does not guarantee the implementation of industrial copyright and other rights, nor authorizes rights of implementation. Also, MITSUBISHI ELECTRIC CORPORATION cannot assume any responsibility whatsoever for problems in terms of industrial copyright that may arise by use of the content described in this document.

Contents

Chapter 1 WHAT IS "SEQUENCE CONTROL?"

1.1 What Is "Sequence Control?"	4
1.2 Devices Associated with Sequence Control	6
1.3 Items Required for Sequence Control	8
1.4 Performing Wiring Based on Sequences	12
1.5 Let's Remember Sequence Symbols	17

Chapter 2 WHAT IS A "PLC?"

2.1 What is a "PLC?"	20
2.2 How PLCs Work	21
2.3 Wiring and Programs	27
2.4 Advantages of Using PLCs	28

Chapter 3 THE OPERATION OF GX Works2

3.1 Basic knowledge for operating GX Works2	32
3.2 Starting GX Works2 and creating a new project	36
3.3 Creating a program	39
3.4 Writing programs to the PLC	45
3.5 Editing a program	50
3.6 Saving the program	60
3.7 Necessary operation for debugging a program	62
3.8 Inputting comments	69

Chapter 4 SEQUENCE INSTRUCTIONS

4.1 Let's Remember PLC Instructions	74
LD, LDI, OUT, END	
AND, ANI	
OR, ORI	
SET, RST	
4.2 About Timer Circuits	82
4.3 About Counter Circuits	83
4.4 Order of Programs	84

Chapter 5 PROGRAM TRAINING

5.1 Introductory Example 1 (Control of Escalators)	86
5.2 Introductory Example 2 (Control of Tea Dispenser)	88
5.3 Introductory Example 3 (Control of Fan)	90
5.4 Introductory Example 4 (Control of Press Machine)	92
5.5 Introductory Example 5 (Timing Chart)	94
5.6 Introductory example answers	96

Appendices

Appendix 1 The OPERATION OF THE GX Developer	97
Appendix 2 Introduction example list programs	145
Appendix 3 Handy Programming Panel	149
Appendix 4 Training Machine wiring	153

Let's Learn About Sequences

Chapter 1

WHAT IS "SEQUENCE CONTROL?"

Let's learn about sequence control

Sequence control is a word that we ordinarily do not hear often. Yet, it exists all around us and we have contact with it in our day today lives.

For example, a fully automatic washing machine is an excellent example of "sequence control."

In this chapter, we will consider what "sequence control" is and the affect it has on our daily lives.

1.1 What Is "Sequence Control?"

What does "sequence" mean?

Though the word "sequence control" may generally be unfamiliar to us, it is used very often around us, and everyone is likely to have seen or have had contact with something that is controlled by sequence control.

Dictionaries describe the word "sequence" as follows:

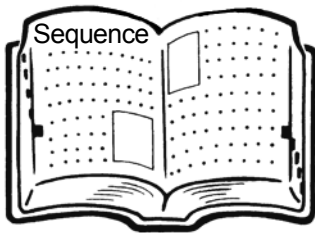

(1) State or fact of being sequent or consequent

(2) Succession

(3) Order of succession

(4) A series of things following in order, etc.

From this, we can understand that "sequence" refers to a succession or order in which events occur.

Examples of things you are familiar with

Let's consider an example of a car wash you frequently catch sight of at a gasoline stand.

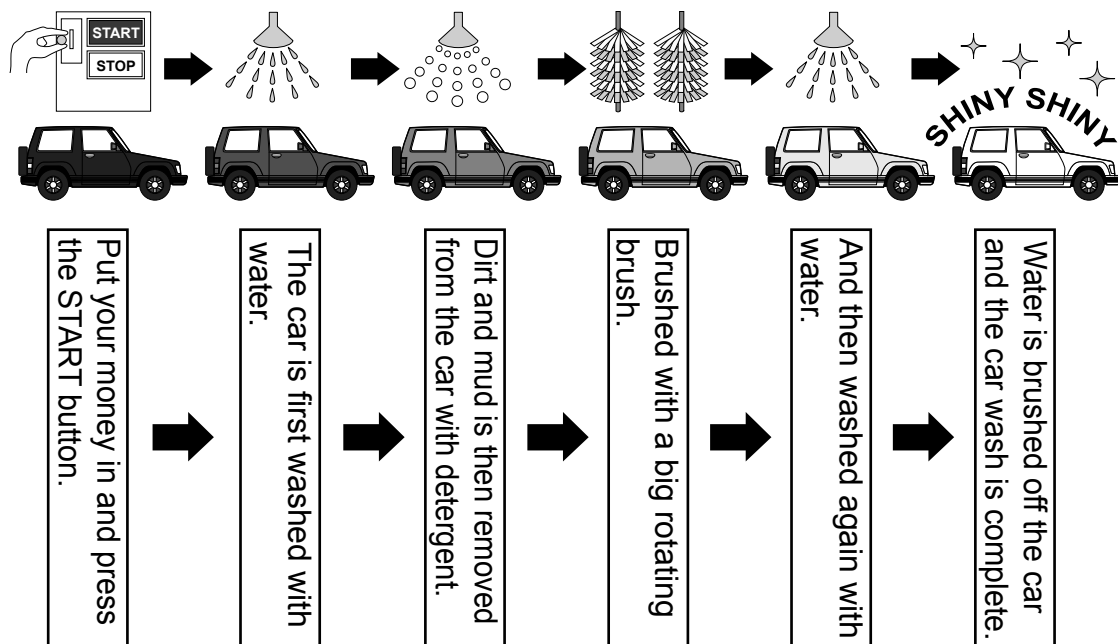

Though operation of the car wash on the previous page was described in approximate terms, this order is the basic way of thinking behind sequences, and making this sequence operate correctly and automatically countless times as intended becomes sequence control.

Sequence control is used extensively and is a vital approach in all situations and all fields.

⊙ FA (factory automation) equipment in factories

⊙ Food manufacturing/processing equipment

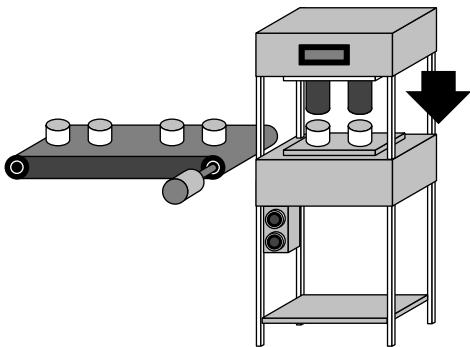

Control of conveyors, various processing machines, various assembling machines and others

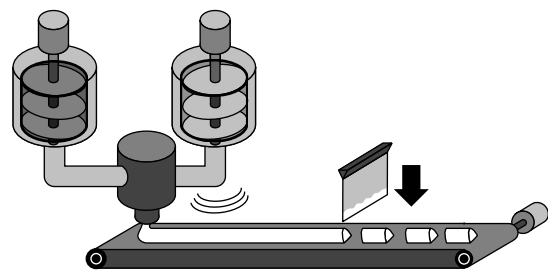

Control of various manufacturing machines for material treatment, forming, heating, cutting, packaging and others

Sequence control is used extensively in various fields.

⊙ Various equipment for professional use

⊙ For control of various automation

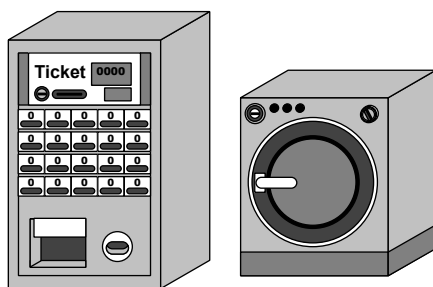

- Large washing machine
- Ticketing machine
- Individually specified equipment such as cold storage and freezing

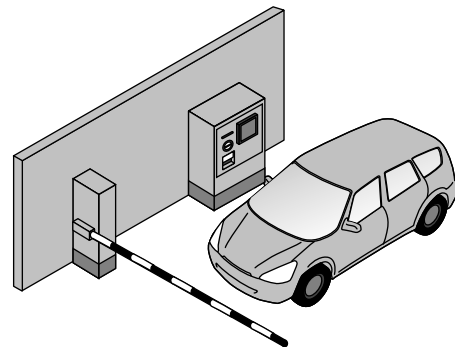

- Control of parking lots
- Control of physical distribution conveyors
- Control of floodgates
- Control of vinyl greenhouses
- Control of signals and electric spectacles
- Control of shutter doors and others

Sequence control is used not just in complex applications but also in applications very familiar to us.

1.2 Devices Associated with Sequence Control

Component devices in sequence control

The following devices are used to perform sequence control. These devices can be broadly classified as follows:

- "devices operated by personnel"
- "devices that notify personnel of machine states"
- "devices that detect machine states"
- "devices for making machines move"

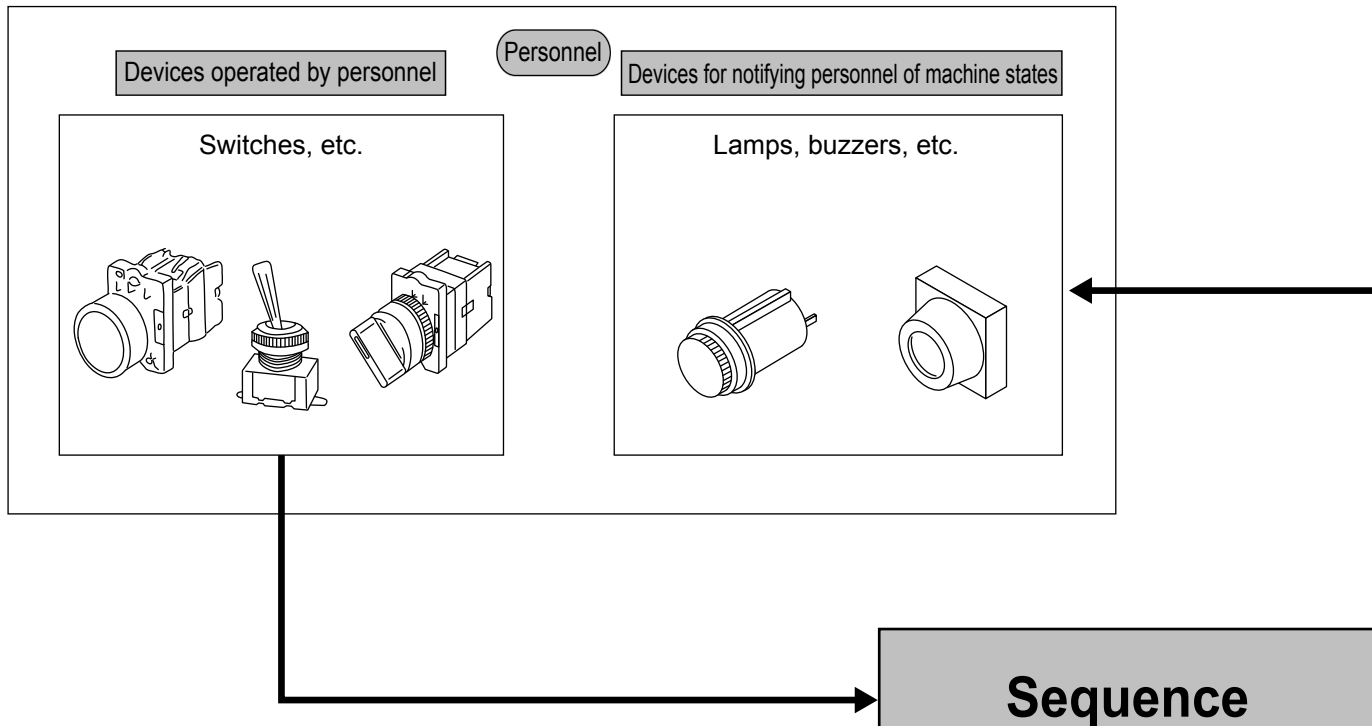

Various devices are also combined to perform sequence control in a car wash, for example.

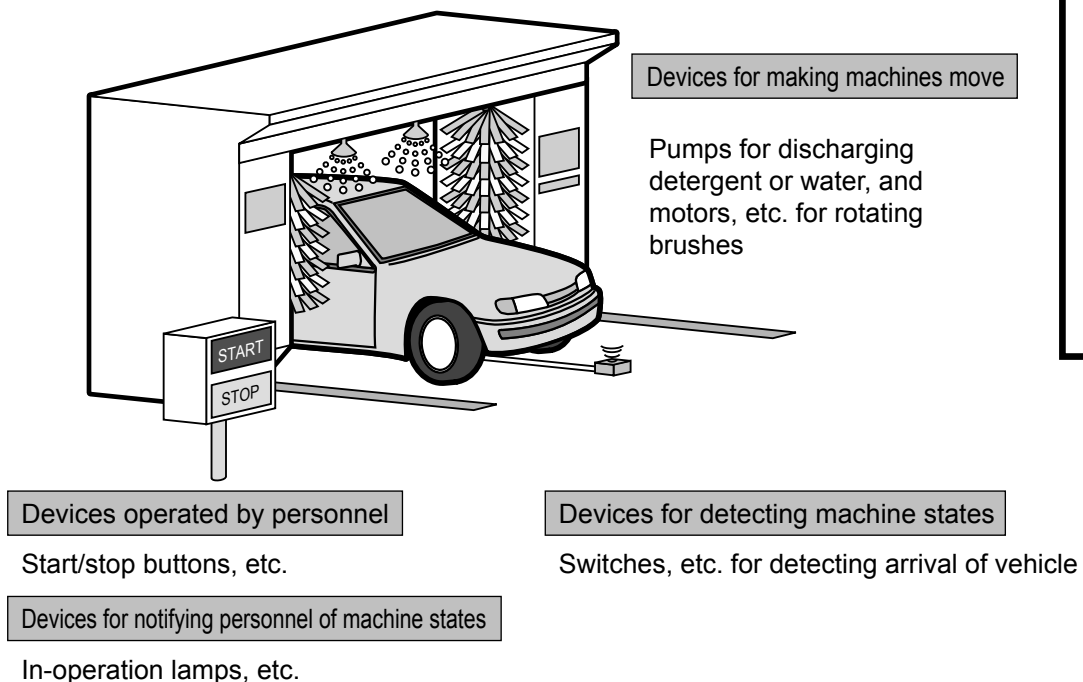

The devices shown in this figure are just examples and only a few of many such devices.

In sequence control, combinations of devices such as these are made to operate in accordance with a work procedure.

Of these devices, "devices operated by personnel" and "devices for detecting machine states" become the **conditions** for making things move in sequence control, while "devices that notify personnel of machine states" and "devices for making machines move" are the devices that **are operated** in accordance with these conditions.

Operation panel ----- A panel on which "devices operated by personnel" (pushbutton switches, selector switches, etc.) and "devices for notifying personnel of machine states" (lamps, digital displays, etc.) are installed.

Control panel ----- A panel on which devices, such as electromagnetic contactors, relays and PLCs, for controlling machine movement, are installed.

Though small-load devices such as small-size solenoid valves and pilot lamps can be driven directly by a PLC, large-load devices such as large-size solenoid valves must be driven via an electromagnetic contact or relays.

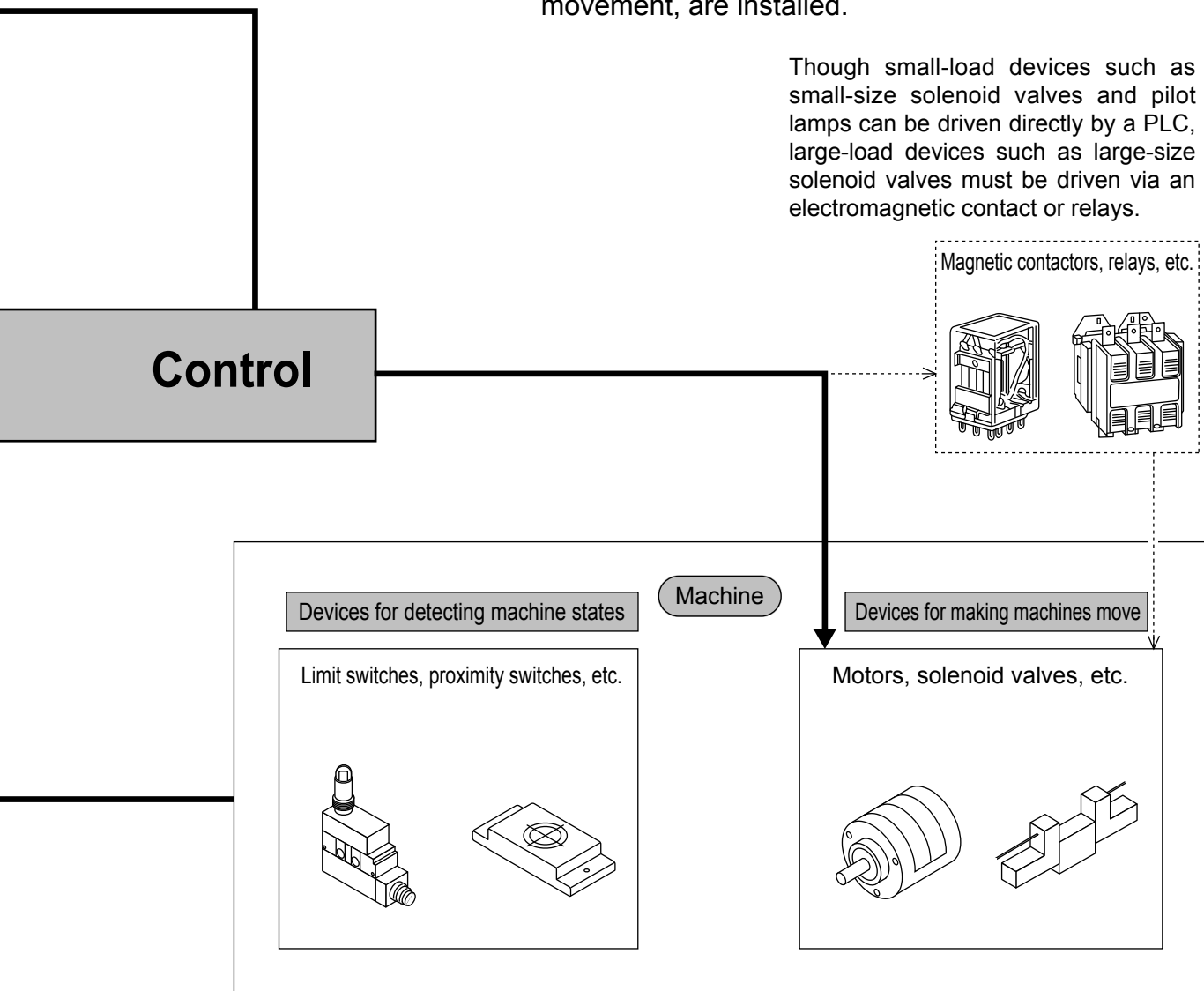

1.3 Items Required for Sequence Control

Let's actually consider sequence control.

Now, let's try actually considering sequence control based on the connection diagram below. The following also describes the terms you need to know in learning sequence control.

Example 1 The electrical circuit below is wired using a pushbutton switch and lamps (blue, red).

- **Content of sequence control**
 - (1) When the pushbutton switch is not pressed, electricity flows along route B and the blue lamp is lit.
 - (2) When the pushbutton switch is pressed, electricity flows along route A and the red lamp lights.
 - (3) When the pushbutton switch is released, the blue lamp lights again as in (1) above.
- The operations in (1) through (3) are part of sequence control.

Connection diagram

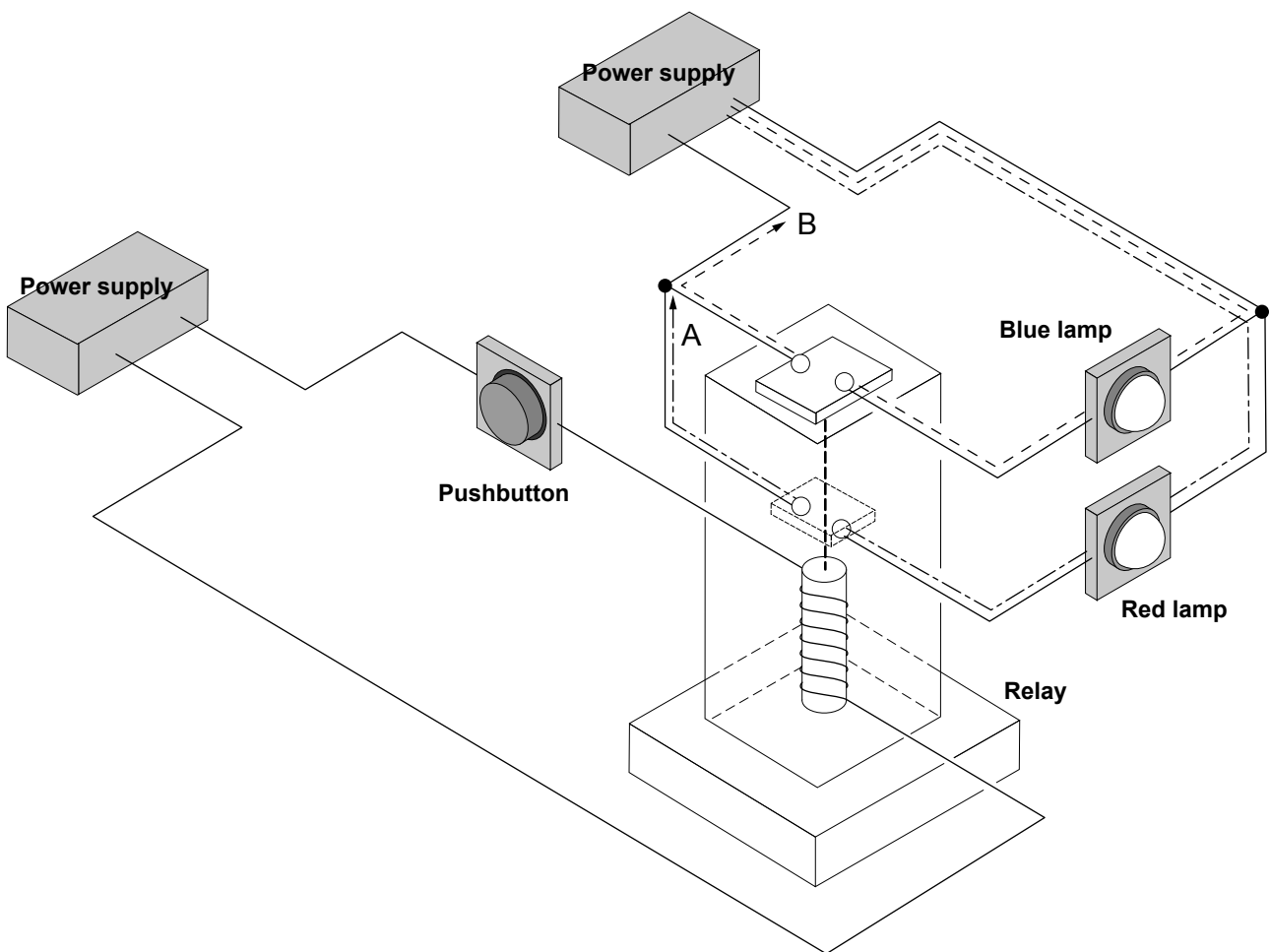

Let's learn some new terms.

- **About contacts**

Contacts perform a switching operation to allow or block the flow of electricity. The two basic contacts are N.O. contacts and N.C. contacts. Switches, relays, timers, counters and other devices have contacts

N.O. contacts

A "N.O. contact" is a "normally open" contact, and closes when the contact is actuated.

Note 1 "Actuate" here means to force operation from normal state of rest. The operation of pressing a pushbutton corresponds to actuation.

Operation: In the case of a pushbutton switch

When the pushbutton switch is not pressed, the contact is open.
When it is pressed, the contact closes.

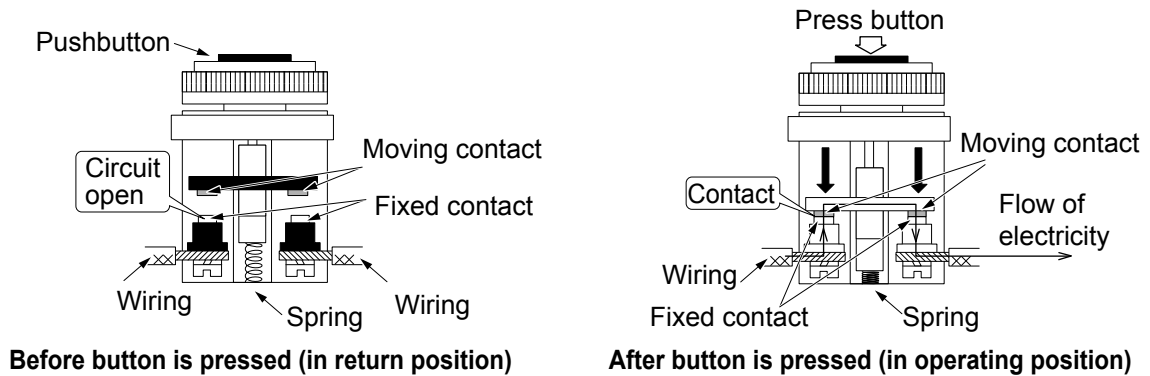

N.C. contacts

A "N.C. contact" is a "normally closed" contact, and opens when actuated.

Operation: In the case of a pushbutton switch

When the pushbutton switch is not pressed, the contact is closed.
When it is pressed, the contact opens.

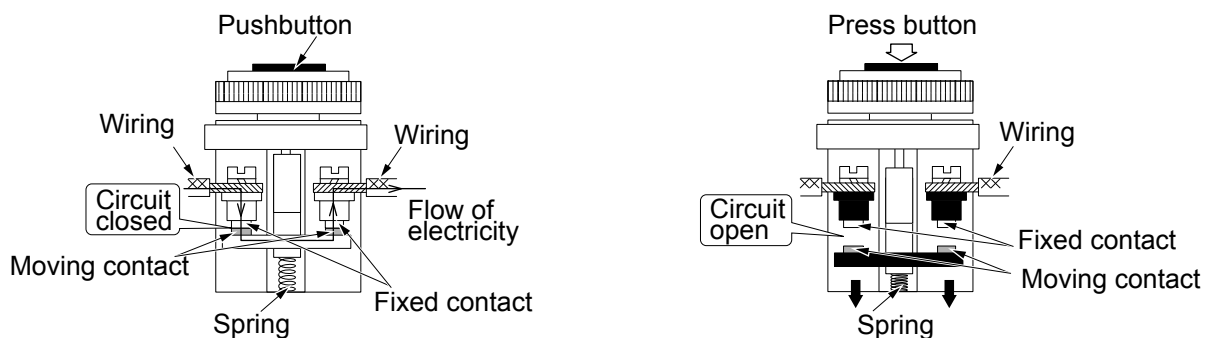

● Relays

Relays incorporate an electromagnet. By action of the electromagnet, pulls a moveable contact to open or close the contact*.

*Contacts : A contact refers to the contact area which executes the switching operation, and conducts or blocks electricity. Not only relays but also switches, timers, counters and other devices incorporate contacts. Contacts are mainly classified into N.O. (normally open) contacts and N.C. (normally closed) contacts (as described on the previous page).

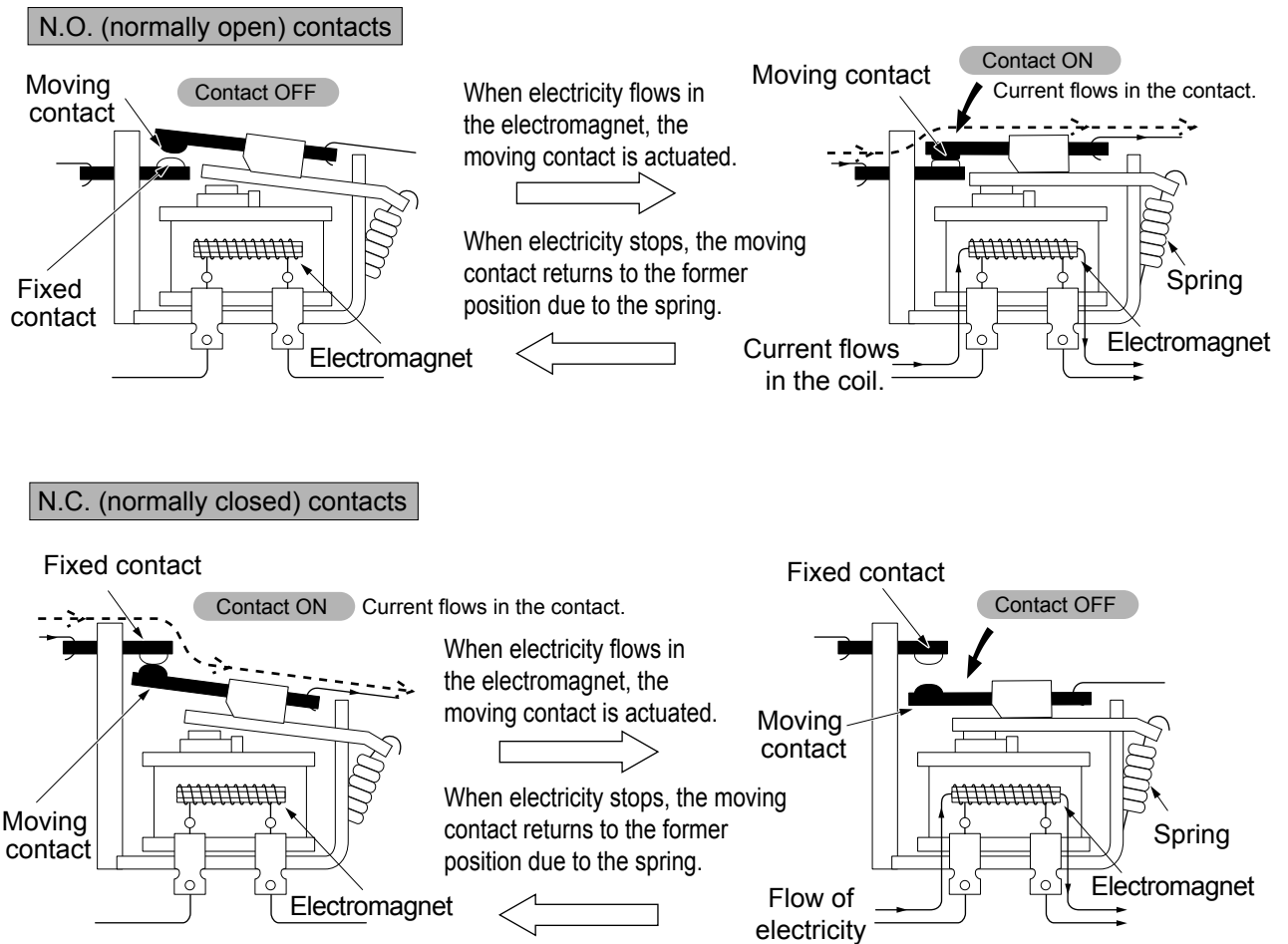

☆ **Where are relays used?**

(1) Relays can make large motors and lamps operate by using small signals.

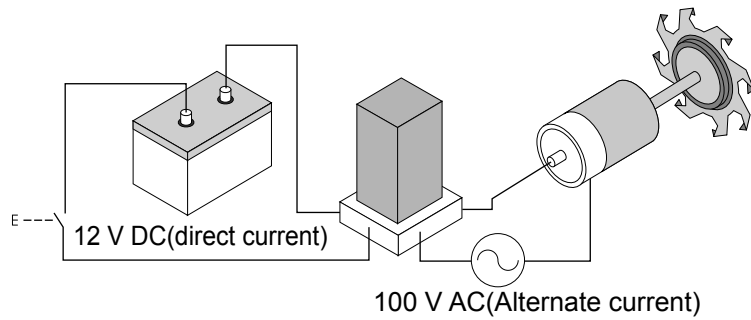

(2) Relays can make motors and lamps in remote sites operate.

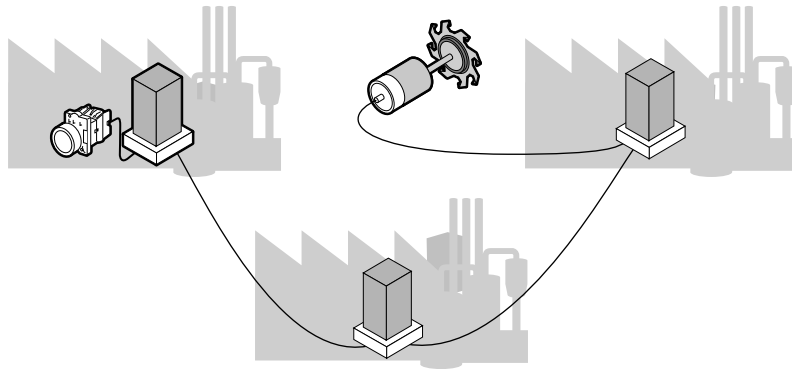

1.4 Performing Wiring Based on Sequences

Now that you've learned some new words

Let's train using Example 1 on page 8 that we studied for relay contacts.

◎ Outline of relay-wired training demonstration model

Product configuration

- Power cable 1 pc
- Pushbutton 1 pc
- Blue lamp 1 pc
- Red lamp 1 pc
- Relay 1 pc
- Wires (brown, red, orange, yellow, green, blue, purple, gray) 1 each

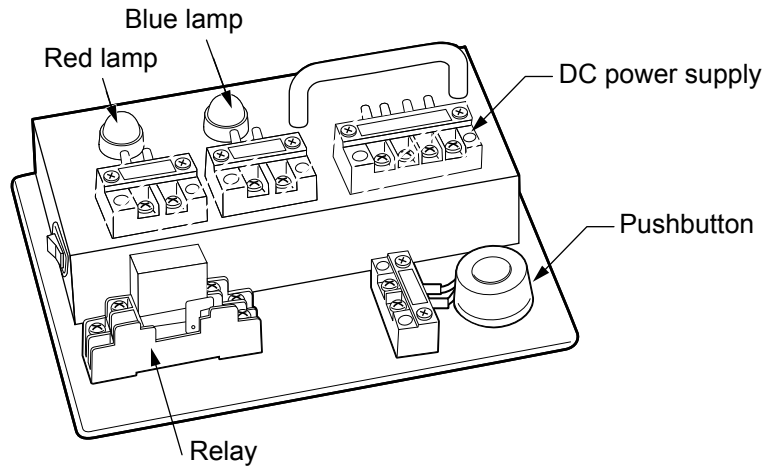

● Let's wire the training demonstration model.

1. Make sure that the training demonstration model is turned OFF.
2. Wire the blue lamp in Figure 1 by connecting the wires as follows:
 - Purple wire to No.7 terminal
 - Yellow wire to No.4 terminal
 - Gray wire to No.8 terminal
3. Wire the red lamp in Figure 2 by connecting the wires as follows:
 - Green wire to No.5 terminal
 - Blue wire to No.6 terminal
 - Brown wire to No.1 terminal
 - Red wire to No.2 terminal
 - Orange wire to No.3 terminal

Figure 1. Blue lamp

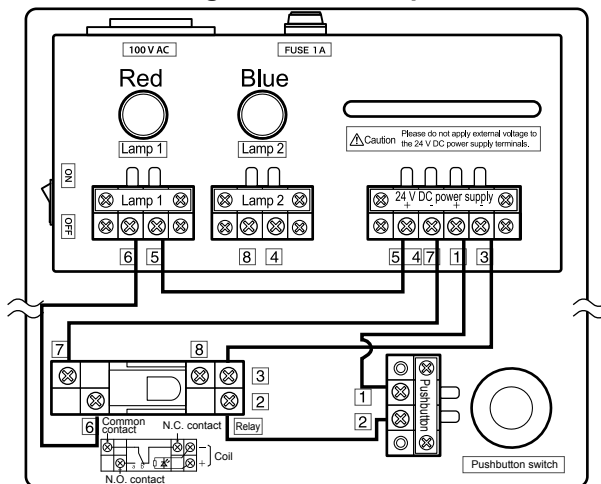

Wiring diagram *1

Figure 2. Red lamp

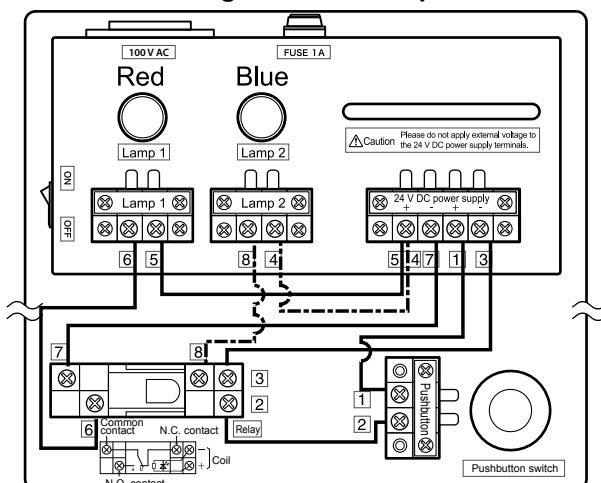

Note) In this example, power supply terminals No.4 and No.5 are common terminals.

*1 What is an "actual wiring diagram?"

This refers to a diagram that is as close as possible to the real thing and that shows circuit connections and devices used for the circuit. As wiring and the structure of devices can be accurately seen in this diagram, it is handy when actually manufacturing devices or performing maintenance.

Now that you've learned some new terms and phrases

- **Let's check operation**

Let swap the content of sequence control explanation on page 8 with the new terms and phrases you've learned.

- (1) When the power is turned ON, the N.C. contact and route B is made , and the blue lamp is turned on.
- (2) When the pushbutton switch (N.O. contact) is pressed, the action of the relay causes the N.O. contact to close. Route A is made , and the red lamp is turned on.
- (3) When the pushbutton switch is released, the blue lamp is turned on again as in (1) above.

Sequence expressed as a flow chart

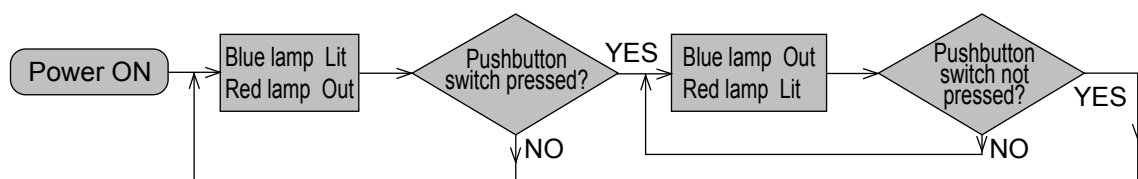

What is a "flow chart?"

With sequence control, various devices are combined to comprise a circuit. To explain, the control of these devices can become quite difficult using based methods. Therefore a flow chart is a preferred method for explaining a control sequence.

A flow chart uses rectangular symbols and arrows to more simply express the overall order of related operations.

Sequence expressed as a time chart

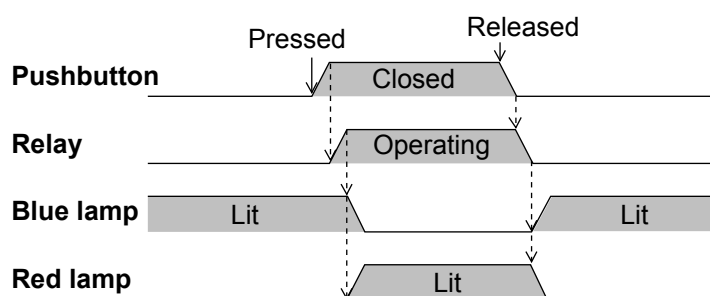

What is a "time chart?"

A time chart expresses changes in the operation sequence over time.

The devices to be controlled are drawn on the vertical axis, while changes over time are drawn on the horizontal axis. Dotted lines with arrow heads are used to show the relationship between respective devices and resulting operations.

Time charts sometimes express changes over time without the use of arrows.

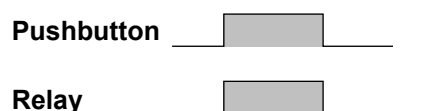

You can also learn the content of sequence control from flow charts and time charts.

Actual wiring diagram and sequence diagram

An actual wiring diagram is a diagrammatic means of making the structure of devices and wiring easy to understand. However, the operation sequence is harder to follow in actual wiring diagrams for complex electrical circuits.

Let's try swapping an actual wiring diagram with a sequence diagram to illustrate this point.

Wiring Diagram

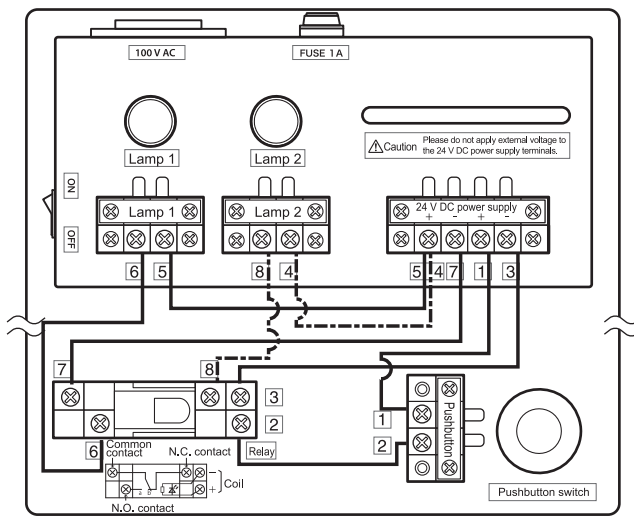

Note) With the FX-I/O demonstration2 training machine, both relays and lamps are driven by a 24 V DC power supply. However, in general, relays are driven by a 24 V DC power supply and lamps are driven by a 100 V AC power supply. This is shown in the figure below.

Sequence Diagram

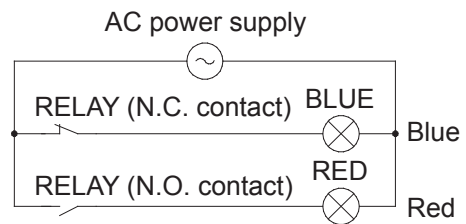
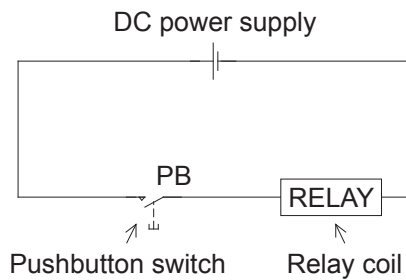

Sequence diagrams are connection diagrams intended to make the content of operation of many circuits easier to understand. Unified standards enable this diagrammatic method to be easily understood by third parties.

Let's consider another example

Example 2 Controlling the level of water in a tank

● Details of sequence control

- (1) When the operation switch is closed, the float switch limit switch 1 closes if the tank is empty, and the magnet switch MC is operated to drive the transfer pump motor.
Relay MC is designed to hold its own state even if the water level is at the mid position.
- (2) When the tank becomes full, float switch limit switch 2 opens, hold operation of the relay MC is canceled, and the transfer pump motor stops.
- (3) When the water level reaches the empty level, the motor starts to operate automatically again.

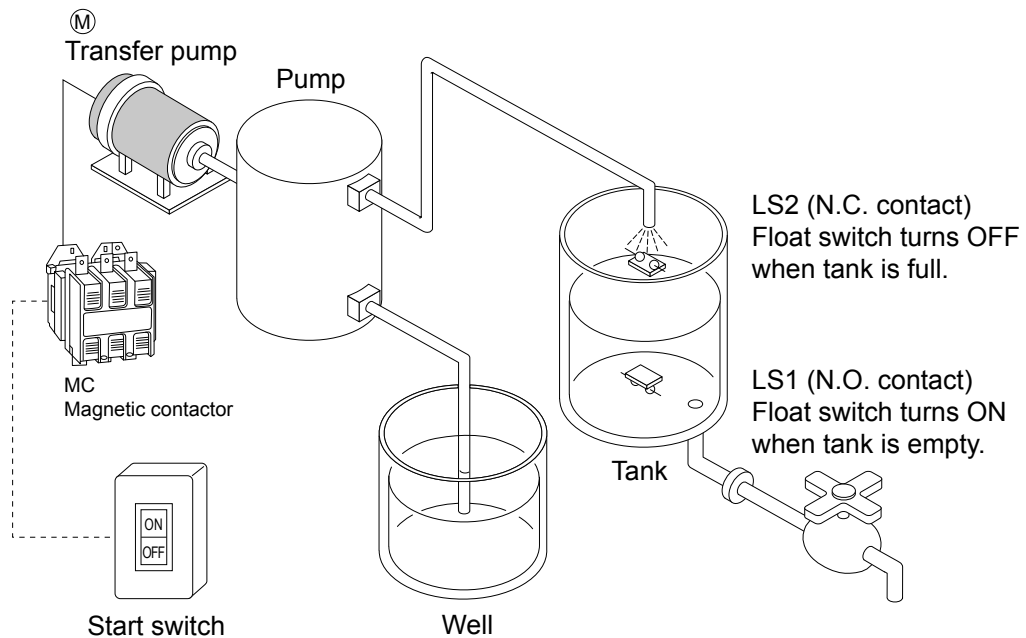

● **Sequence diagram**

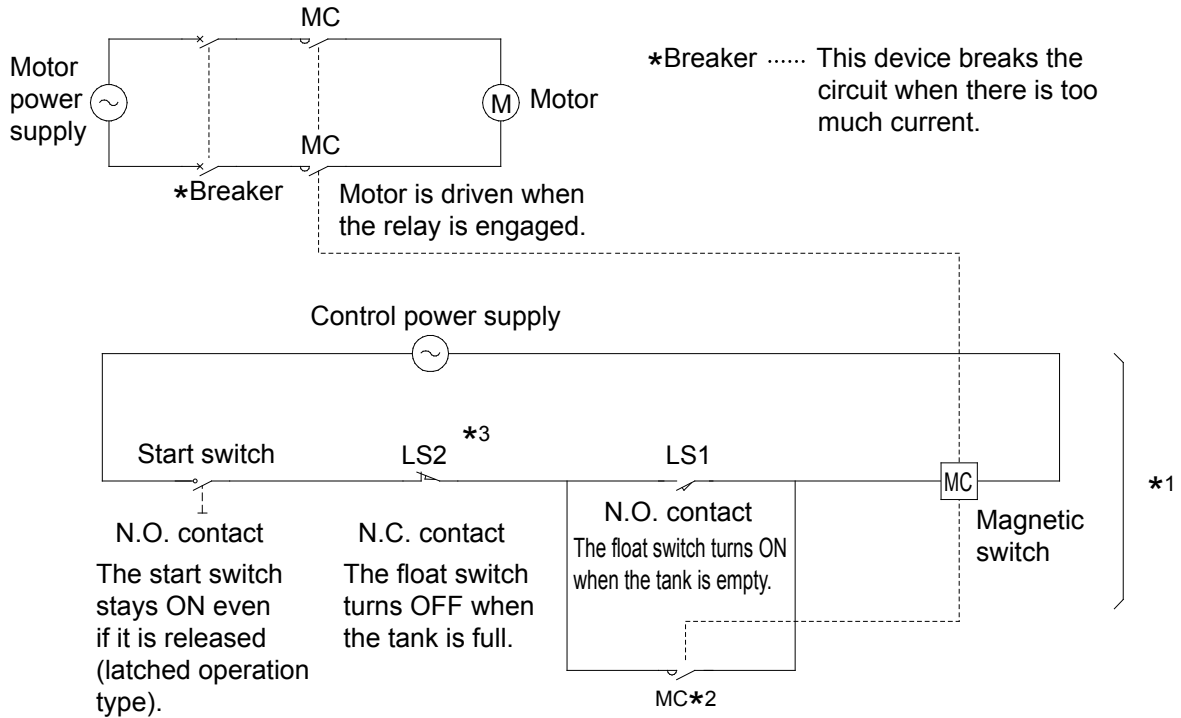

*1 The sequence in this section is generally replaced by a sequence program on a PLC.

*2 **About self-hold circuits**

A "self-hold circuit" refers to an operation circuit that bypasses signals arriving from an external relay or other device by means of the contact of the relay itself.

Self-hold circuits can also be said to have a memory function that allows them to operate continuously even if the circuit is cut by releasing a pressed pushbutton.

In this circuit, the contact of the relay (MC *2) for driving the motor is connected in parallel to float switch limit 1 (LS1). This provides an example of a "self-hold switch."

*3 Though limit switch 2 (LS2) functions to cut the self-hold circuit to stop the transfer pump motor, when limit switch 2 (LS2) is used with a N.C. contact, the switch can also be turned OFF to stop transfer of water during a switch contact failure or wiring break.



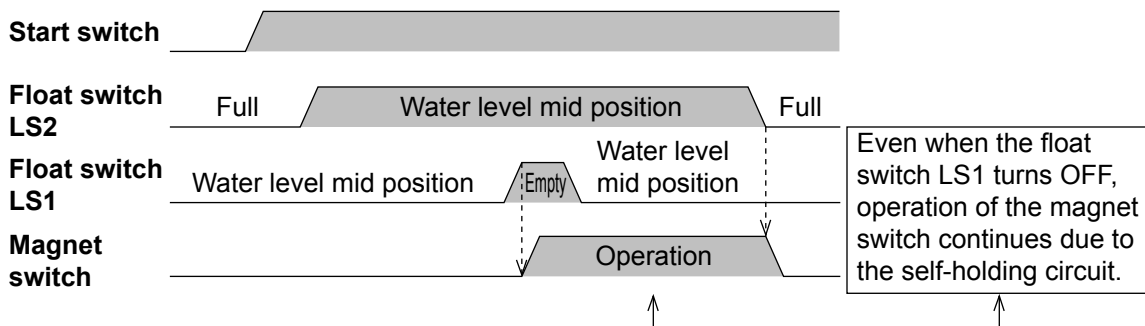







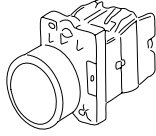



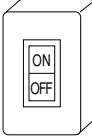



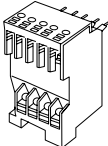





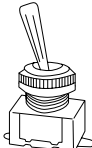



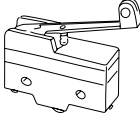











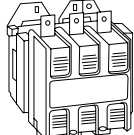

Operation of self-holding circuit (time chart)

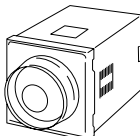

1.5 Let's Remember Sequence Symbols

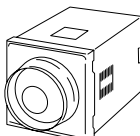
List of main sequence symbols

(JIS C 0617)

Contact Category Product Category		N.O. Contact		N.C. Contact		Drive Source	
		Horizontal format	Vertical format	Horizontal format	Vertical format		
Pushbutton switch (auto-return type)						Manual	
Pushbutton switch (latched operation type)						Manual	
Thermal relay (OCR)						Heater  Operation	
Switch (general)						Manual	
Limit switch (mechanical operation)						 Dog	 Cam
Auxiliary switch relay contact						Electromagnetic coil 	
Magnetic contactor							
Timer (ON delay)							
Timer (OFF delay)							

MEMO

Introducing You to PLCs

Chapter 2

WHAT IS A "PLC?"

What is a "PLC?"

PLC stands for "programmable controller" and is sometimes known as a "sequence controller" or SC. These are defined as electronic devices that control various devices via I/O sections and have built-in memory for storing programmable instructions.

Actually...

So far, we have performed "sequence control" by physically wiring relays and timers. This chapter considers the use of a simple PLC program to control electronic devices.

2.1 What is a "PLC?"

What do PLCs do?

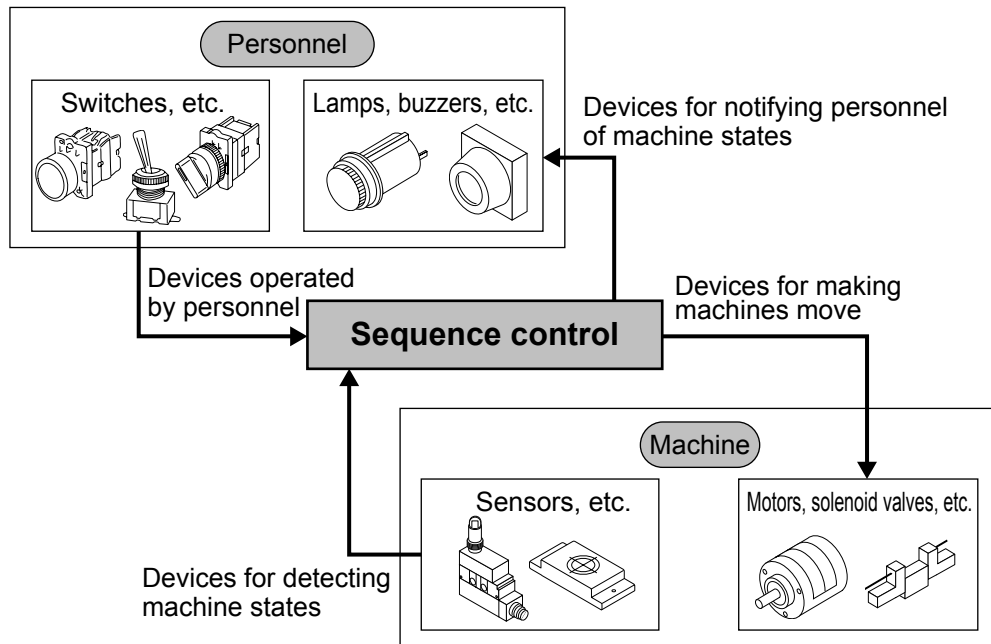

The devices that are operated by personnel or that detect machine states in sequence control are called "instruction signals" or "condition signals." Devices that notify personnel of machine states or that move machines are called "loads."

PLCs are responsible for carrying out "sequence control." The diagram above illustrates the control of these devices. Where the condition signals and loads in the devices are connected to the PLC.

2.2 How PLCs Work

How does sequence control work?

PLCs are microcomputer-controlled devices for industry.

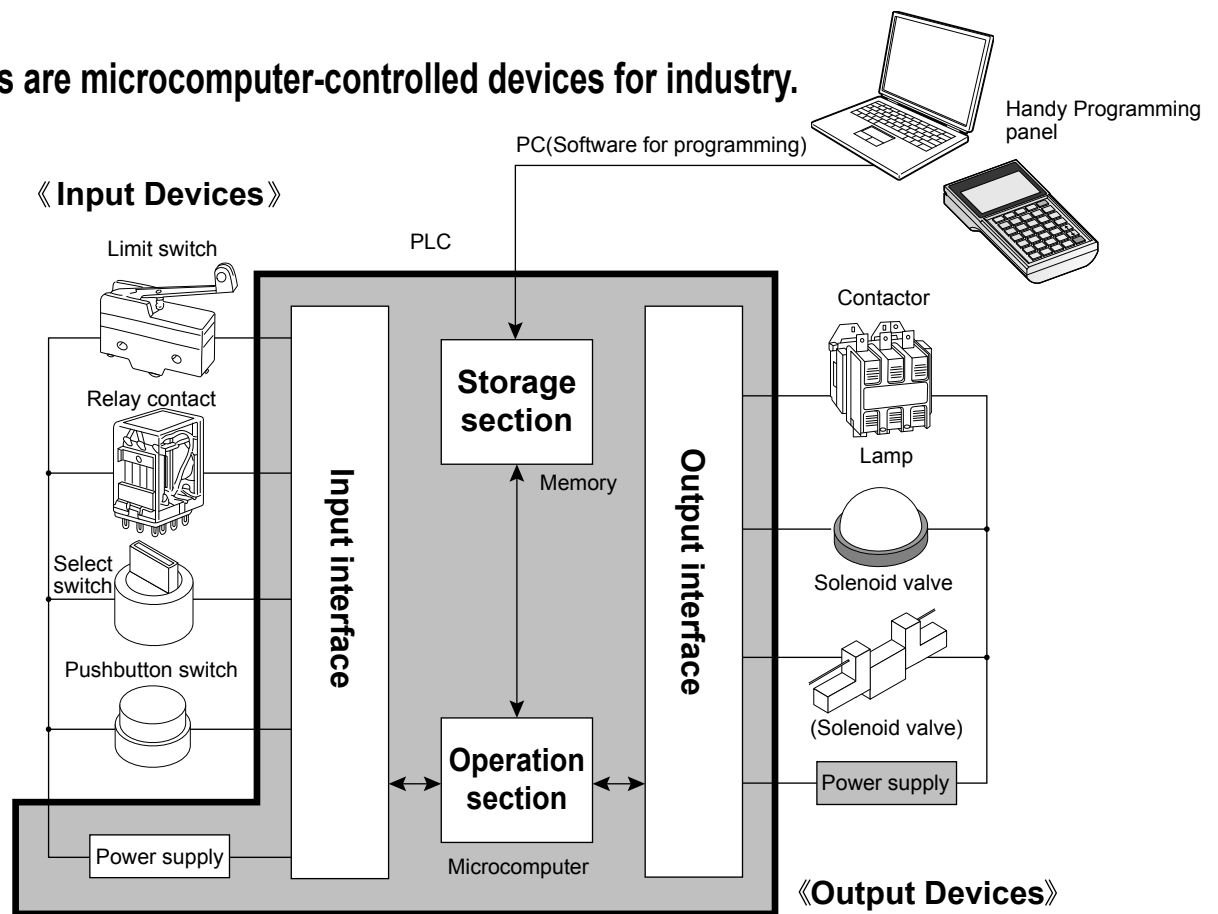

Devices connected to the input side of the PLC are called "input devices," while devices connected to the output side of the PLC are called "output devices." One device is connected to each terminal block.

One input device and one output device may merely be connected to a PLC in this way, and the connection for performing sequence control is performed electronically inside the PLC.

PLC internal connections are programmed using dedicated sequence language (instructions), and a combination of these instructions is called a "sequence program." Sequence control is performed in accordance with this program, so there is no need to wire externally.

Actually consider a PLC as a group of relays and timers

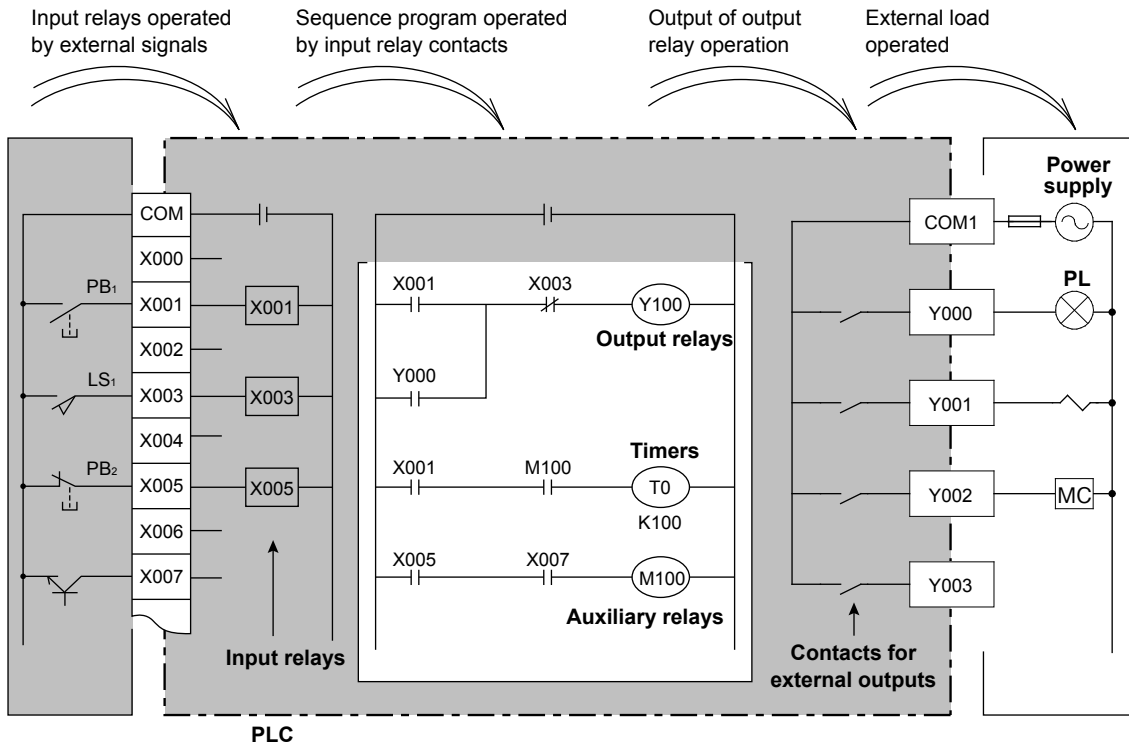

The figure above shows how the input devices, output devices and the sequence program are configured. The input devices is connected to the PLC's input relays, and the output device is controlled via contacts for external outputs.

● Input relays

The input relays convert the signals from an external device to signals for the PLC. In the above figure, the input device is designed to operate merely by connecting across the input terminal and the COM terminal. However it should be noted that PLCs have a limited number of contacts, even though, an infinite number of contacts is provided on the sequence program.

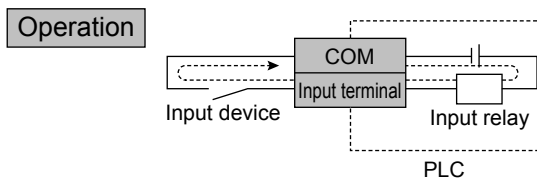

The PLC has a built-in power supply for the input relays. When the contact of the input device is conducting, current flows along the dotted line to drive the input relay.

Regardless of whether the external input device is a N.O. contact or a N.C. contact, the contact on the PLC that closes when the COM and input terminals are conducting is an N.O. contact, and the contact that opens is a N.C. contact.

● Output contacts

Output contacts are otherwise known as just outputs. These are controlled by the sequence program, and are necessary for driving an external load. Devices having a different power supply (AC or DC) can be connected to the contacts for external output.

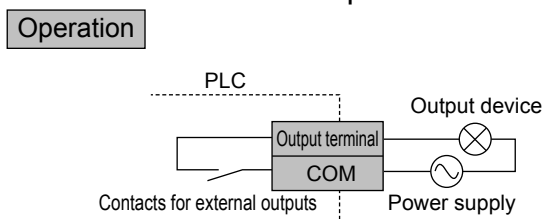

When the output relays on the sequence program are driven, the contacts for external output close. Provide a power supply for driving the external device outside the PLC.

An I/O number is assigned to each terminal to make the I/O devices connected to the input terminals and output terminals correspond to the input relays and output relays of the sequence program.

Timers and counters held internally by the PLC are also assigned to device numbers in addition to each terminal number.

☆ **Element numbers** ---- Element numbers comprise a symbol that shows what the device is and a number that categorizes individual devices.

Input relays : X000~

Input relays act as the "point of contact" for receiving signals, for example, from an input switch outside of the PLC. X is used to identify their device number. PLCs have a built-in number of input relays corresponding to the number of inputs (number of terminals).

Timers : T0~

Timers are held internally by the PLC, and function to measure time. Timers have coils and contacts. When a preset time is reached, a contact closes.

Output relays : Y000~

Output relays act as the "point of contact" for driving loads outside the PLC. Y is used to identify their device numbers. PLCs have a built-in number of output relays corresponding to the number of outputs (number of terminals).

Counters : C0~

Counters are held internally by the PLC and count numbers. When a preset number is reached, a contact closes.

Auxiliary relays : M0~

Auxiliary relays are held internally by the PLC and are also called "internal relays."

☆ The number of inputs relays, output relays, timers, counters, and other devices varies according to the model of PLC.

Reference

Decimal, Octal and Hexadecimal

As shown in the following table, octal and hexadecimal numbers are assigned as device numbers in addition to decimal numbers.

	Input relays, output relays	Auxiliary timers, timers, counters
Micro PLC FX Series	Octal	Decimal
General-purpose Q/A Series	Hexadecimal	Decimal

"Decimal" The decimal number system is used most often, and counts up numbers in units of ten in the format 0 to 9, 10 to 19, 20 to 29 and so forth.

"Octal" The octal number system counts up numbers in units of eight in the format 0 to 7, 10 to 17, 20 to 27 and so forth.

"Hexadecimal" The hexadecimal number system counts up numbers in units of 16 in the format 0 to 9, 0A, 0B, 0C, 0D, 0E, 0F, 10 to 19, 1A, 1B, 1C, 1D, 1E, 1F and so forth.

Expressions used in sequence diagrams and sequence programs

The sequence program on a PLC replaces the input device and output device connected to each of the external terminals with a circuit for performing sequence control. For details on instruction words, see Chapter 4.

The following explains how to replace a sequence diagram with a sequence program. This example shows the tank water level control described on page 15 replaced with a sequence program.

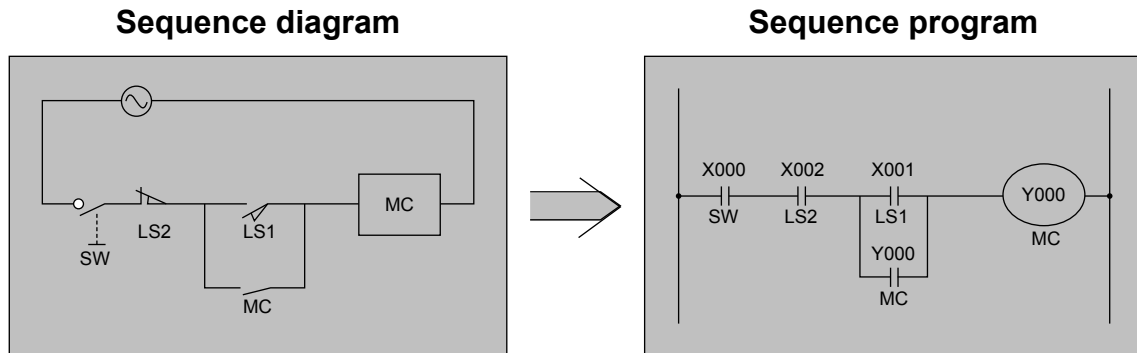

The following describes the various differences when a relay sequence program is replaced with a sequence program.

(1) How N.O. contacts and N.C. contacts are expressed

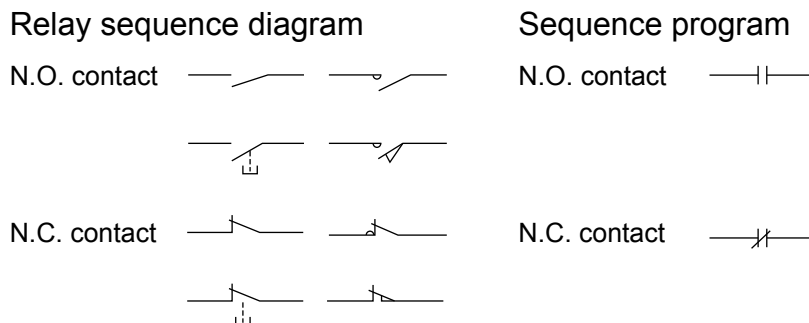

(2) The power supply circuit is not expressed.

(3) The sequence program is assigned device numbers explained in the previous page.

Important

(4) Limit switch 2 in the sequence diagram is a N.C. contact but becomes a N.O. contact in a sequence program.

This is because the role of limit switch 2 in the above sequence diagram is to break the self-hold circuit of the MC and stop the MC. So, we should consider that **it is in a conducting state at all times on the circuit.**

Next, remember the operation of the input relay on page 22. In operation of the N.O. contacts and N.C. contacts in the sequence program, **N.O. contacts turn ON** and N.C. contacts turn OFF when the input relay is electrically conducting due to a change in state of the contact on the external wiring. Due to this fact, a N.O. contact must be used on the sequence program to obtain the same operating state.

In this way, when a PLC is used, N.O. contacts and N.C. contacts can be used for each of the contacts on the sequence program.

Reference

Operation of N.O contact and N.C. contact in a PLC program

The following describes the operation of N.O contact and N.C. contact in a PLC program.

- When no current is flowing in the input devices, a N.O. contact appears as OFF in PLC program. A N.C. contact appears as ON.
- When current is flowing in the input devices, a N.O. contact appears as ON in PLC program. A N.C. contact appears as OFF.

A contact in the PLC program does not replace the physical switch. It represents the input coming into the PLC. Therefore, we use N.O. contact in the PLC program for the signal of LS2.

For details, please refer to (1) and (2) below.

[1] Reason for using limit switch 2 (X2) as an N.O. contact in the PLC program

(1) When limit switch 2 is used as N.C. contact in zsame way as the sequence diagram

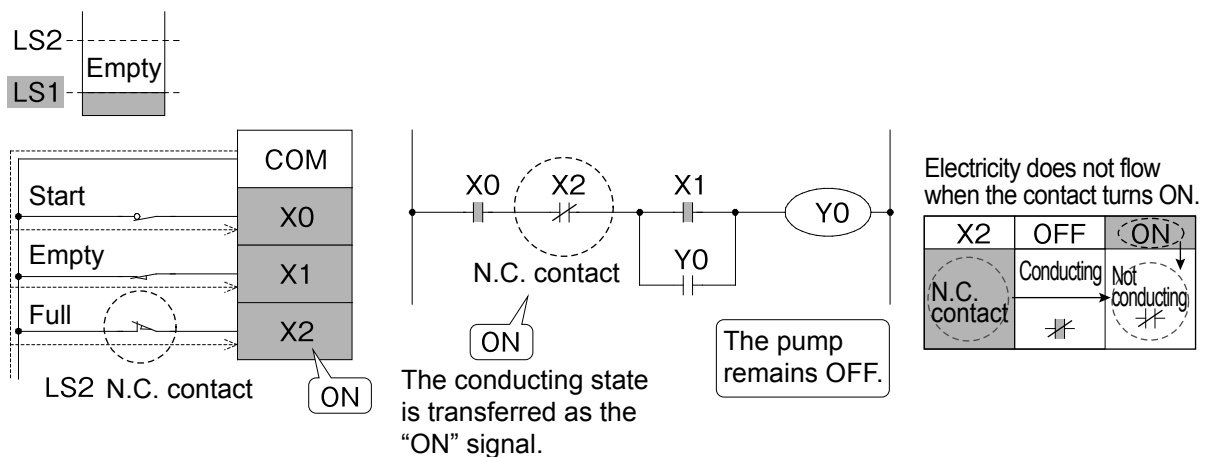

(2) When the limit switch 2 is used as an N.O. contact

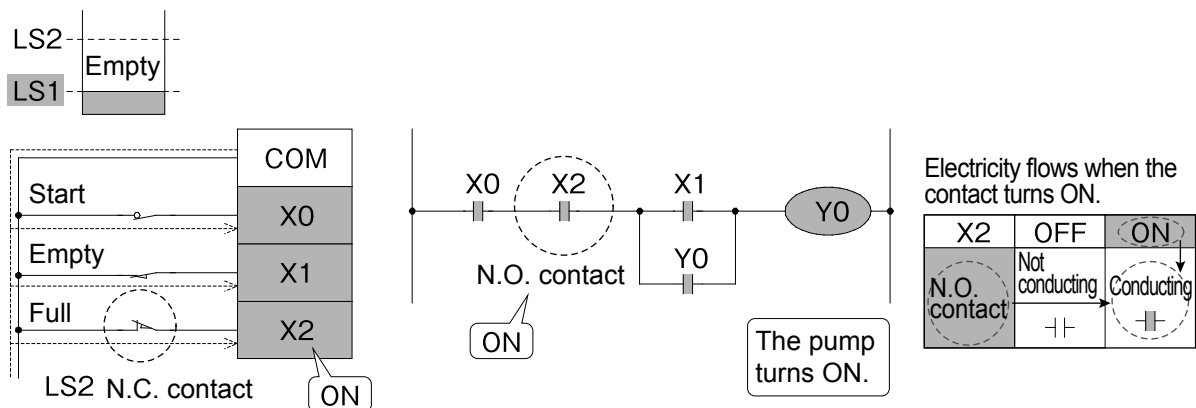

• Program concept

N.O. contacts become conductive and N.C. contacts become nonconductive when a signal is input from the outside.

[2] Flow of water level control in the tank

- The pump is OFF while the water is in the mid level.

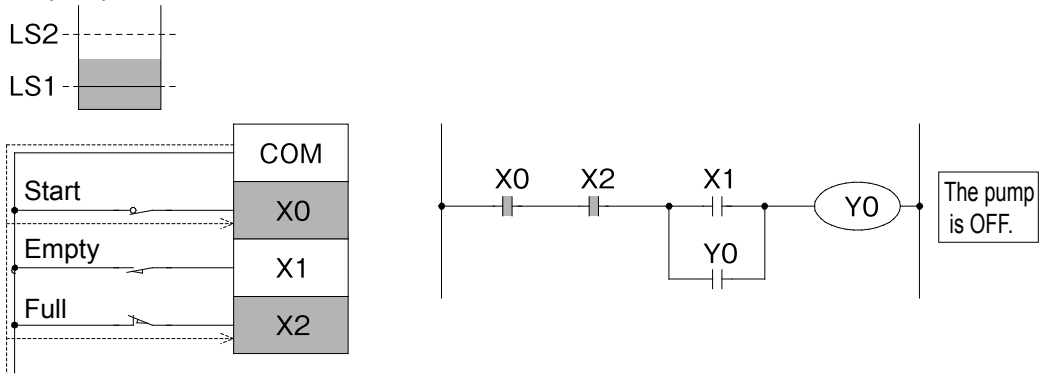

- When the water reaches the empty level

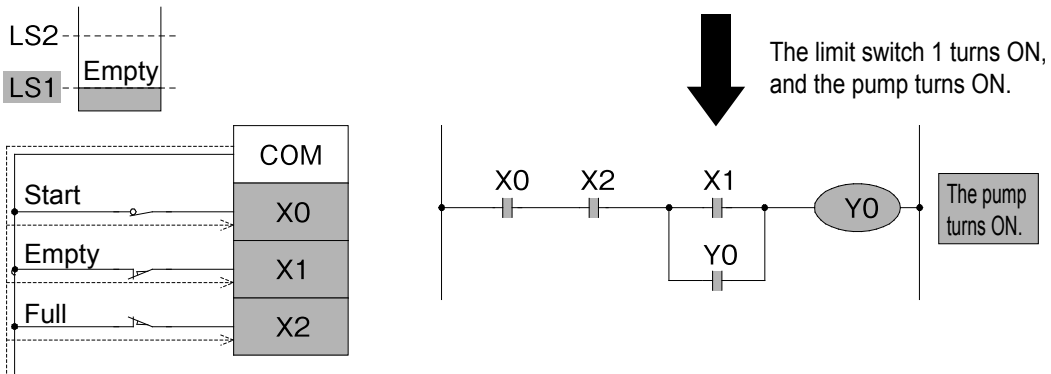

- While the pump is ON and water is supplied

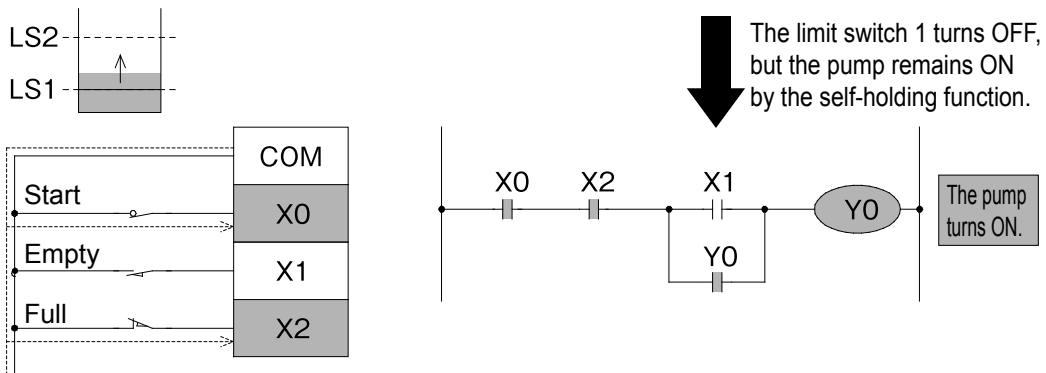

- When the water reaches the full level

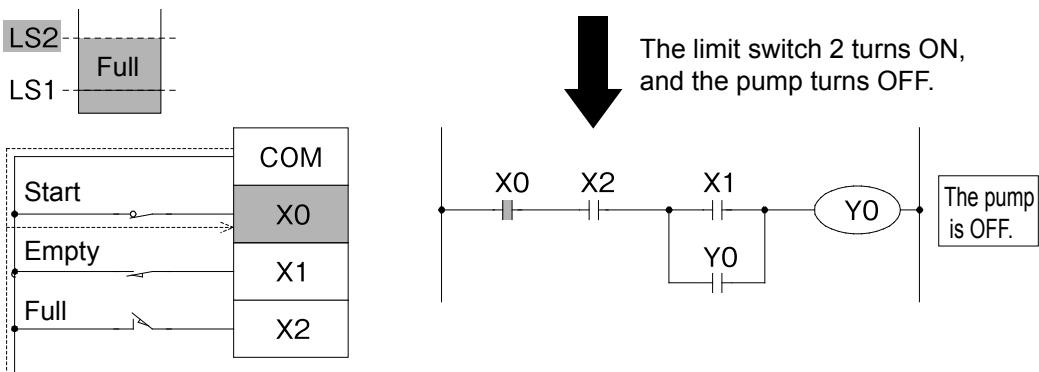

2.3 Wiring and Programs

2.3.1 What are PLC wiring and programs like?

The figure below shows the circuit on page 16.

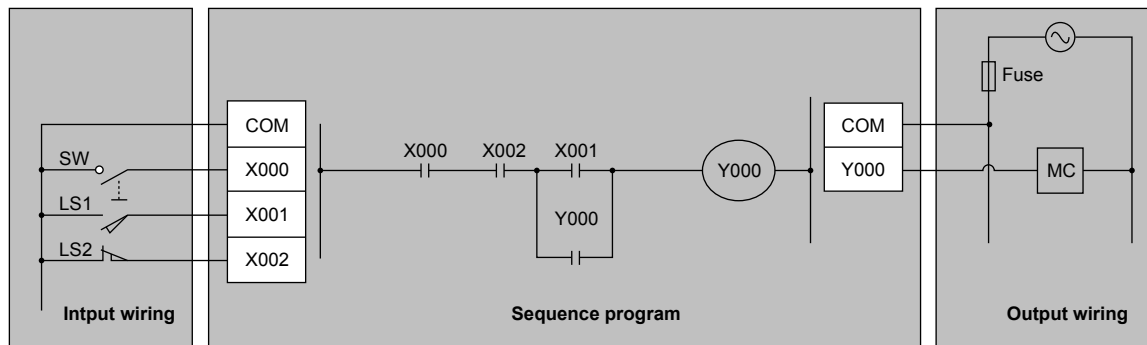

The wiring of a PLC wiring can be divided up into I/O wiring and internal wiring.

I/O wiring must be handled in the conventional way using cutting pliers and a screwdriver.

Complicated internal wiring in a PLC (sequence program), can be handled easily by operating the pushbuttons (keys) on the programming panel.

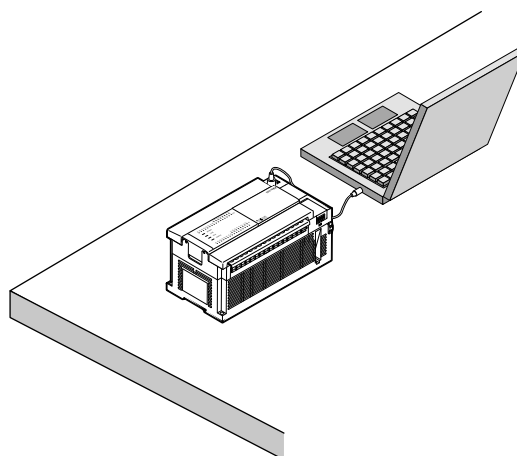
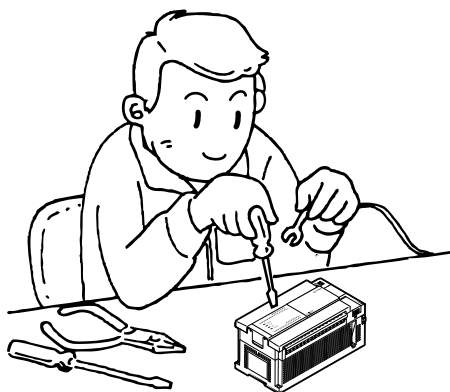

The connections between input terminals and input relay coils and between output contacts of output relays and output terminals were already established at the delivery from the factory.

2.4 Advantages of Using PLCs

2.4.1 Effective use of PLCs

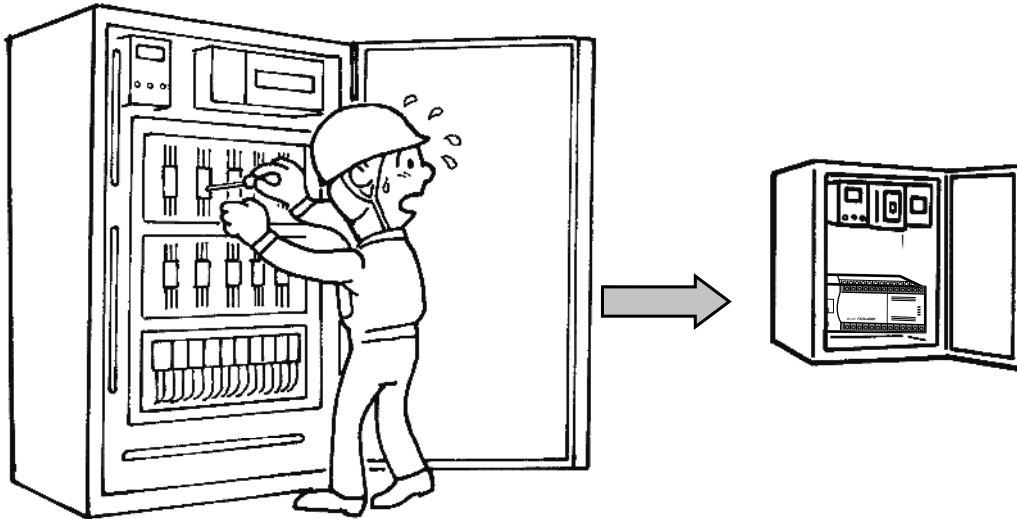

1

Economical

In general, PLC is more inexpensive than conventional control box where 10 or more relays are required.

2

Less manpower for design

Large amount of labor-saving can be achieved through simplified parts layout drawings, sequence design and pre-start-up and test procedures.

3

Short turn-around time

The turn-around time can be significantly reduced through reduction in quantity of procured parts, parallel procurement of the machinery and control box, flexibility in specification change, simplified wiring work and so forth.

4

Downsizing and standardization

Significantly reduced in size than relay boards and mass-production is possible by reusing the program.

5

Improved reliability

Troubles due to relays and timers can be reduced and the component with PLC can be used without any concern once the initial set-up of the PLC is completed.

6

Improved maintainability

Maintenance can be done in an easy manner, since few parts with life limitation are used and the PLC has a self diagnosis function.

2.4.2 Comparison with relay control

Item \ Method	Relay control	PLC control
1 Functionality	Complex control is possible by using many relays.	Control can be programmed however complex it is.
2 Changeability of control content	No other option but to change the wiring	Only the program needs to be changed, and control can be freely changed.
3 Reliability	Though there is no problem in regular use, there are restrictions in faulty contacts and service life of parts.	Reliability is higher as the center of operations is made up entirely of semiconductors.
4 Versatility	Once made, devices cannot be used for other applications.	PLCs can be used for any kind of control depending on the program.
5 Device expandability	If additions and modifications are required they are difficult.	PLCs can be freely expanded up to their full potential.
6 Ease of maintenance	Periodic inspection and limited service life parts must be replaced.	PLCs can be repaired merely by replacing modules.
7 Range of functions	Relay control only is supported.	Analog and positioning control also can be performed in addition to sequence programs.
8 Device size	Generally, large	PLCs do not increase in size even in complex, advanced control applications.
9 Design, production period	Many drawings are required, and it takes time to arrange parts and test assemblies.	Design is simple even for complex control, and it does not take time to manufacture PLCs.

Reference

A Short History of PLCs

The device "PLC" came into being in 1968 as a result of commissioned development by General Motors in the United States, and the general market for PLCs started in the United States in the following year. The first domestically produced PLC made its appearance in Japan in 1970, yet it took six years for the first general-purpose PLC to appear in 1976. MITSUBISHI ELECTRIC CORPORATION initiated the market for general-purpose PLCs in the year 1977, and has since made one-board PLC modules a familiar name on the market. Since then, it has developed the general-purpose PLC K series with integrated numeric value processing functions, which was followed by the micro PLC F series with built-in programmer. Today a variety of PLC products are available world wide that can suite an array of control applications.

MEMO

Let's use a personal computer to create programs!

Chapter 3

THE OPERATION OF GX Works2

Let's use a personal computer to create programs!

GX Works2 software provides an efficient and easy way to create and edit sequence programs for PLCs. Once the basic operations are mastered, programming often involves straightforward repetition. Beginning with the most necessary operations, let's learn how to program from the beginning.

Smoothly begin new projects and update them with ease...

It is easy to debug programs with GX Works2 and update them as necessary. The operation status of the PLC and program can be monitored with a personal computer, so if some parts are not working as planned, changes and updates can quickly be made.

Make programs easier to read

There is a "comment input function" in GX Works2 to make sequence programs easier to read.

Comments can improve the efficiency of creating and debugging ladder programs.

3.1 Basic knowledge for operating GX Works2

3.1.1 Layout of the GX Works2 screen

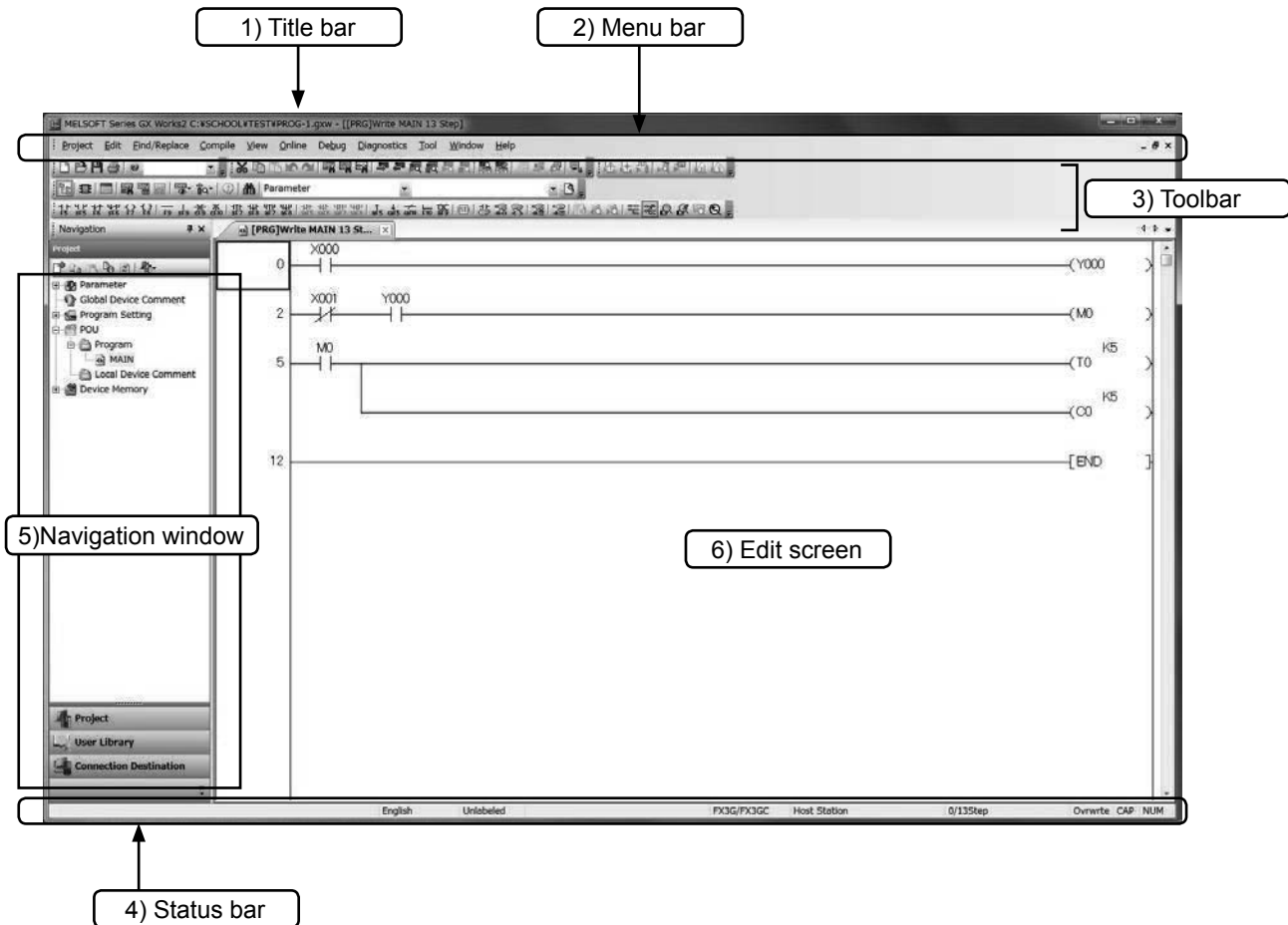

1) Title bar

The name of the opened project and the window operation icons are displayed.

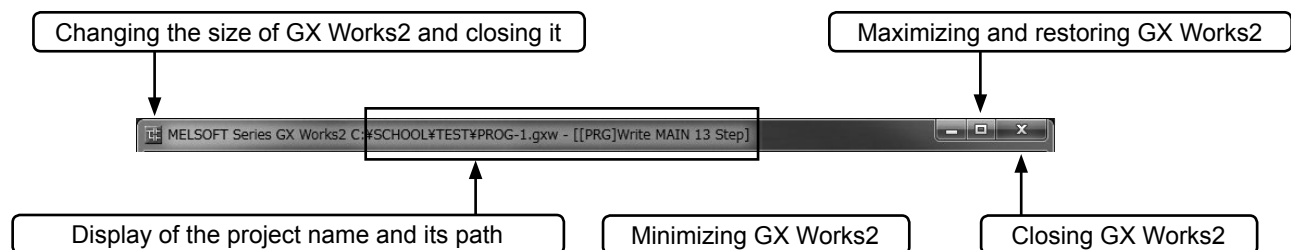

2) Menu bar

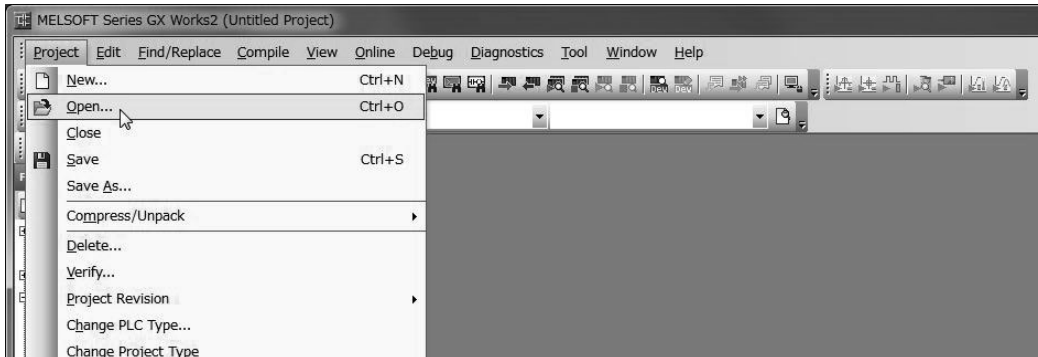

Drop down menu items are displayed when a menu is selected.

3) Toolbar*

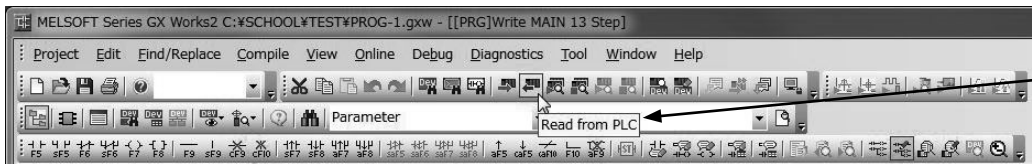

A description of the function is displayed when the mouse cursor stops over each button.

*: The contents of the toolbar can be moved, added, and removed. Therefore, the layout and items displayed depend on saved environment .

Frequently used functions are displayed with icon buttons for quick execution.

4) Status bar

The status of the operation and keyboard settings are displayed.

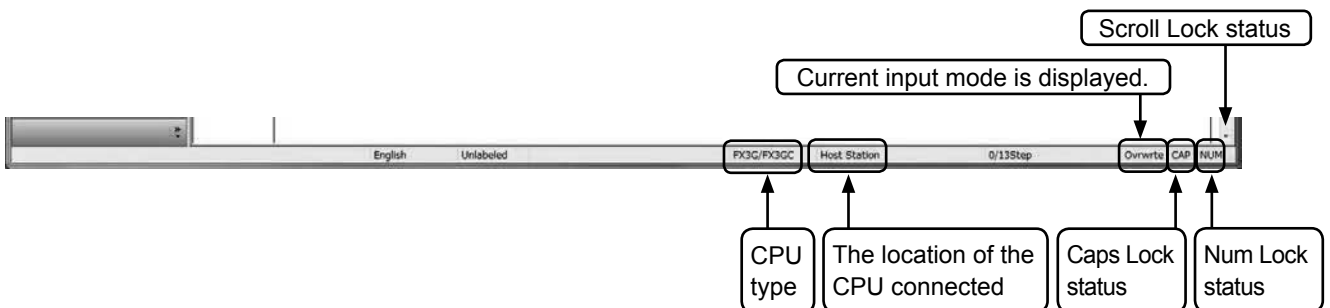

5) Navigation window

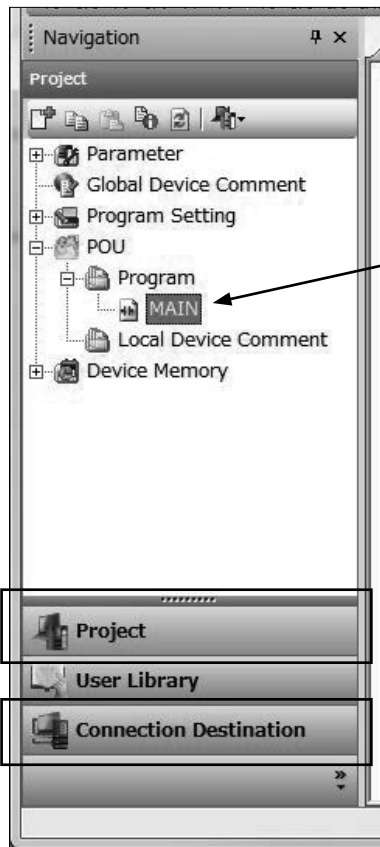

The sequence program is displayed when [POU] → [Program] → [MAIN] is clicked.

The tree structure indicating the contents of "Project" is displayed in the above area when this button is clicked.

The personal computer connection destination (PLC connection) is displayed in the above area when this button is clicked.

6) Edit screen

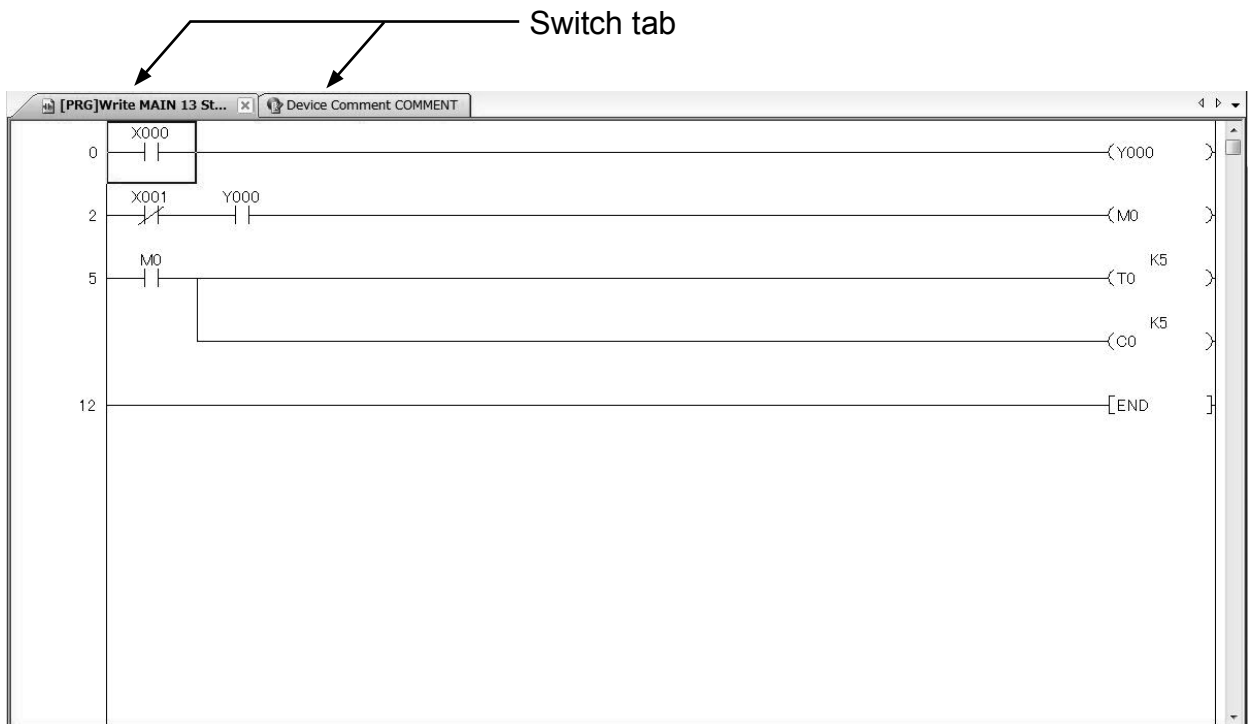

3.1.2 Workspace and project

● Workspace

GX Works2 can control multiple projects under one name.

Do not change the workspace configuration using Windows[®] Explorer or other software.

● Project

The project consists of “Program”, “Device comment”, “Parameter” and “Device memory”.

Altogether, this data is called “Project”, and saved in a folder having the workspace name.

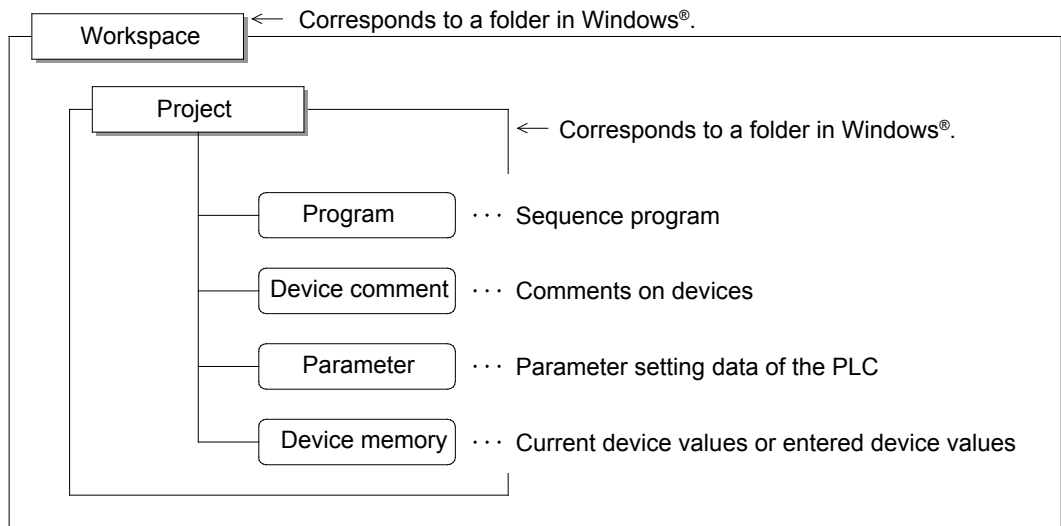

When saved in workspace format

3.2 Starting GX Works2 and creating a new project

3.2.1 Starting GX Works2

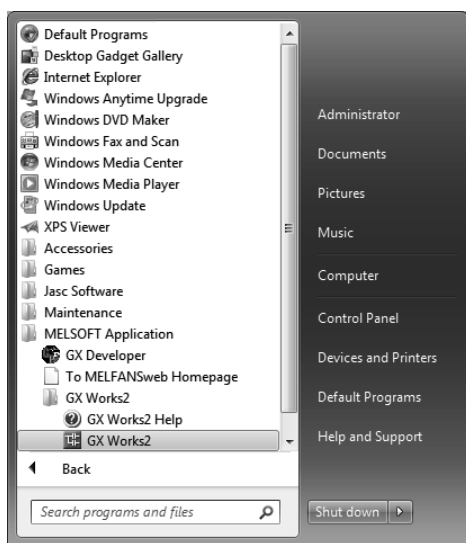

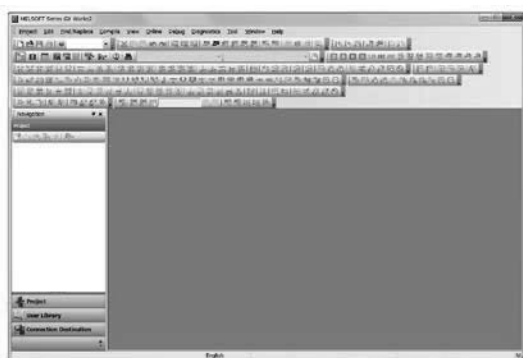
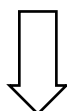
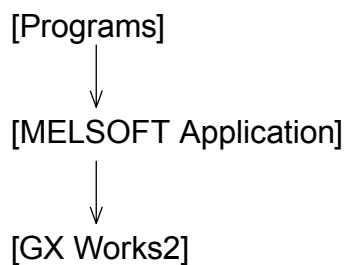

1) Start from the Start button of Windows®, and select the application as follows:

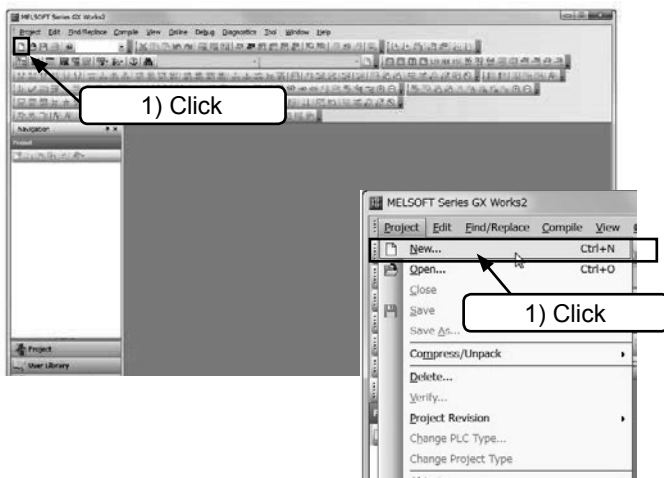

2) GX Works2 is started.

3.2.2 Creating a new project



- 1) Select  from the toolbar, or select [Project] → [New] (**Ctrl** + **N**) from the menu.

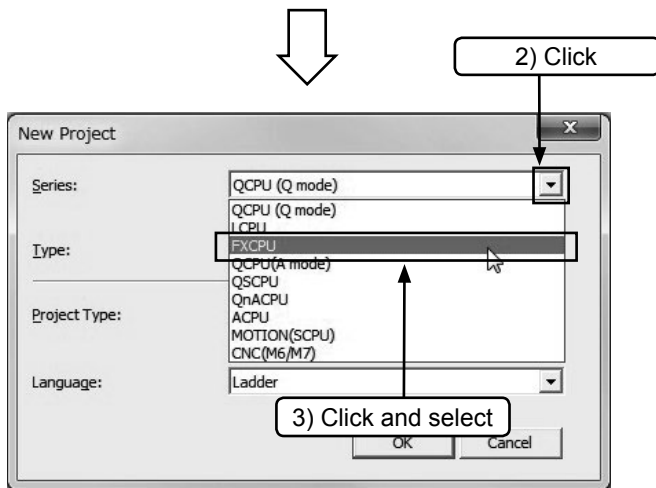

- 2) Click the [▼] button of [Series].
- 3) Select "FXCPU".

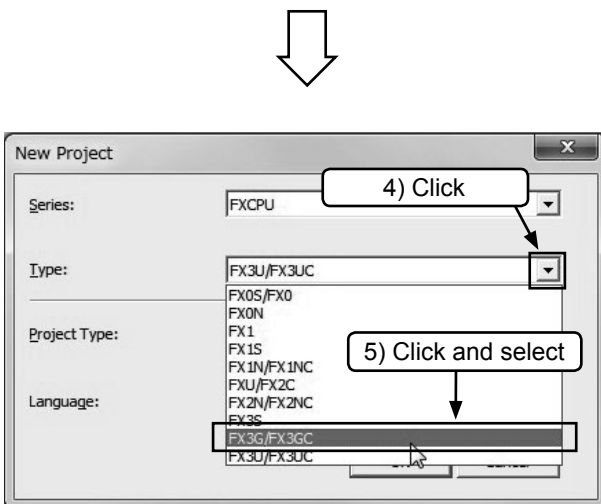

- 4) Click the [▼] button of [Type].
- 5) Select "FX3G/3GC".

(Note) Select the series name that is actually used.

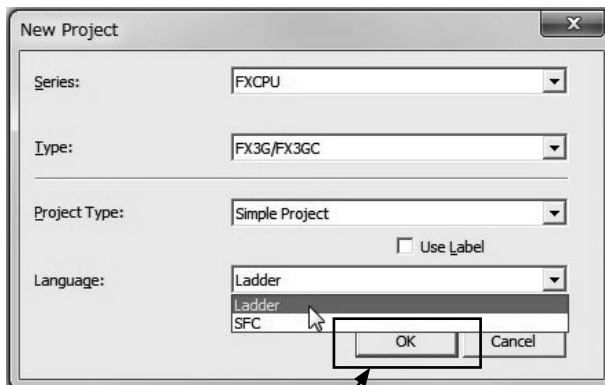

6) Click

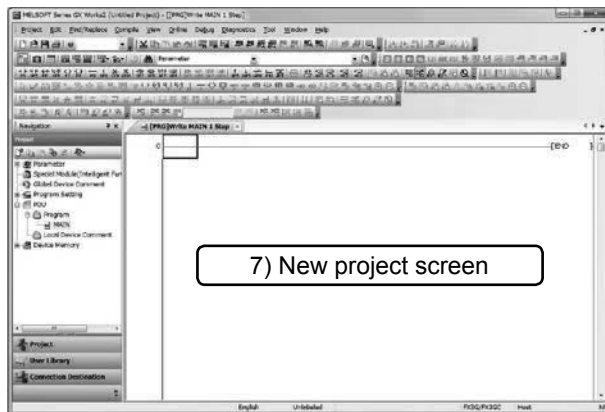
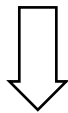

7) New project screen

6) Click .

(Note) Choose "Simple Project" for the "Project Type".

Do not check "Use Label".

Select "Ladder" in "Language".

3.3 Creating a program

3.3.1 Creating a program by using the function keys

[Program to be created]

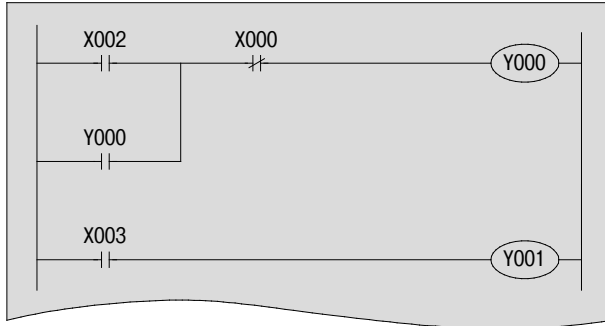

POINT

In this book, the input and output relay numbers are displayed with three digits, such as "X000," and "Y000." When using GX Works2, however, "X0," "Y0," etc. may be input.

POINT

The keyboard shortcuts for ladder elements are displayed on the buttons of the toolbar.

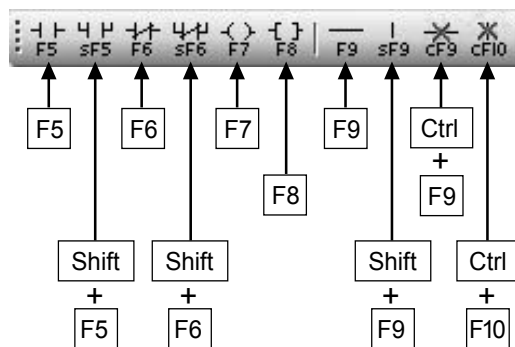

Main key operations

- "NO contact (—|)" and "Coil (—|), (—|)" can be input directly without using the keyboard shortcuts.

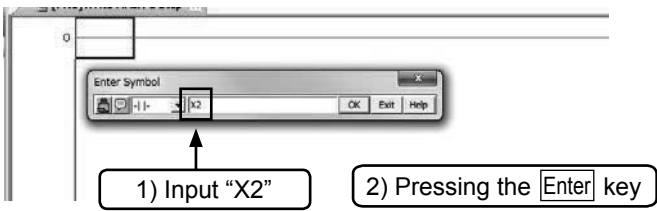

- 1) Press the **F5** (**-|+**) key.
Input "X2".



Cancel it by **ESC** or **[Exit]**.

- 2) Confirm by pressing the **Enter** key or **OK**.

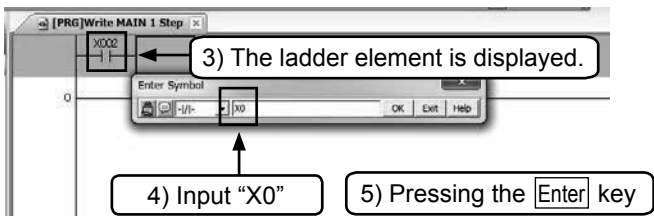
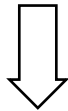

- 3) The ladder input ($\overset{X2}{-|+}$) is displayed.
- 4) Press the **F6** (**-|+**) key.
Input "X0".
- 5) Confirm by pressing the **Enter** key or **[OK]**.

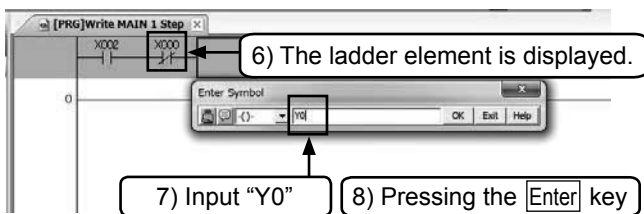
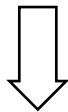

- 6) The ladder input ($\overset{X0}{-|+}$) is displayed.
- 7) Press the **F7** (**->)** key.
Input "Y0".
- 8) Confirm by pressing the **Enter** key or **[OK]**.

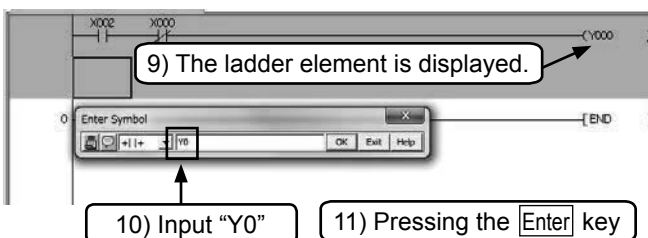
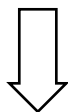

- 9) The ladder input ($-Y0-$) is displayed.
- 10) Press the **Shift + F5** (**+|+**) key.
Input "Y0".
- 11) Confirm by pressing the **Enter** key or **[OK]**.

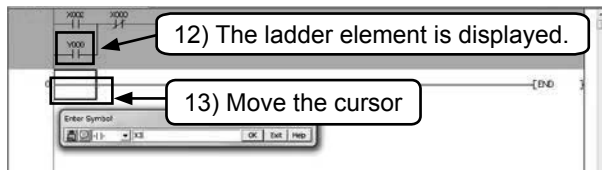

14) Input "X3" 15) Pressing the **Enter** key

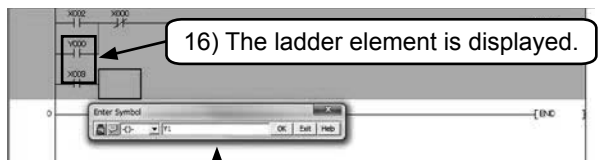
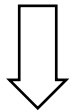

17) Input "Y1" 18) Pressing the **Enter** key

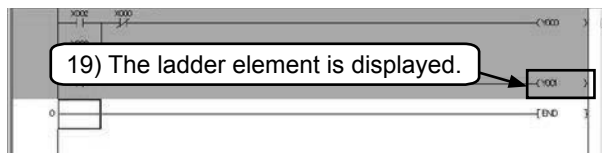
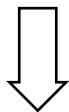

F4 (Build)

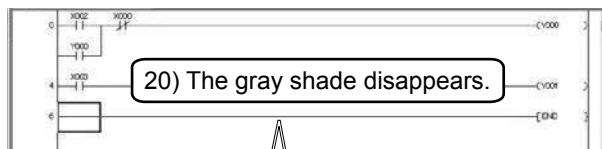

The gray shade disappears and the program is compiled.
If an error occurs, the cursor moves to the problematic part of the program. Correct the program.

- 12) The ladder input ($\text{Y}0$) Y0 is displayed.
- 13) Move the cursor to the beginning of the next line.
- 14) Press the **F5** (+) key.
Input "X3".
- 15) Confirm by pressing the **Enter** key or [OK].

- 16) The ladder input ($\text{X}3$) is displayed.
- 17) Press the **F7** (< >) key.
Input "Y1".
- 18) Confirm by pressing the **Enter** key or [OK].

19) The ladder input ($\text{Y}1$) is displayed.

20) Compile Operation [Important].

Perform the "Compile" operation to finalize ladder that not been compiled (the gray part).

Press the **F4** (Build) key.

Or select  from the toolbar, or select [Compile] → [Build] from the menu.

3.3.2 Creating a program by using the toolbar buttons

[Program to be created]

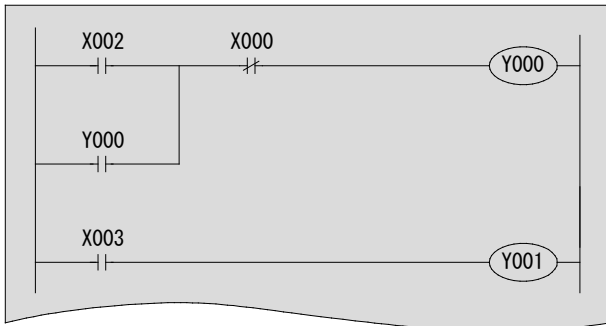

POINT

In this book, the input and output relay numbers are displayed with three digits, such as "X000," and "Y000." When using GX Works2, however, "X0," "Y0," etc. may be input.

POINT

Click the toolbar buttons to input ladder elements.

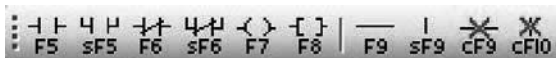

Main toolbar buttons

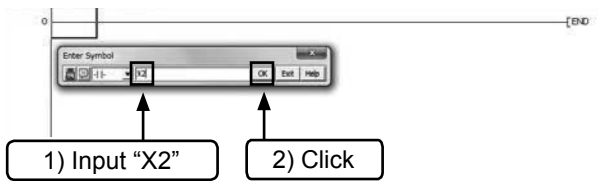

- 1) Click the toolbar button . Input "X2".



Cancel it by or .

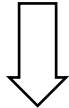

- 2) Confirm by pressing the key or .

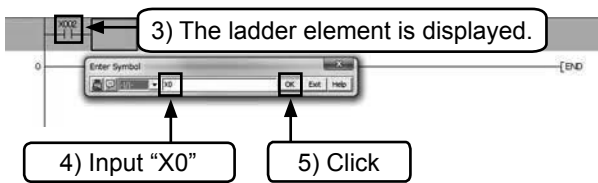

- 3) The ladder input $(\overline{X2})$ is displayed.

- 4) Press the toolbar button . Input "X0".

- 5) Confirm by pressing the key or .

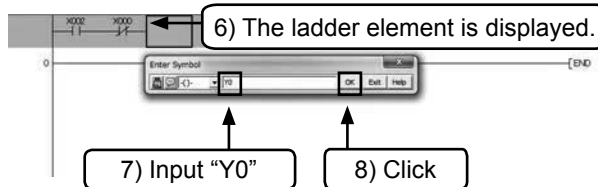
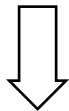

- 6) The ladder input $(\overline{X0})$ is displayed.

- 7) Click the toolbar button . Input "Y0".

- 8) Confirm by pressing the key or .

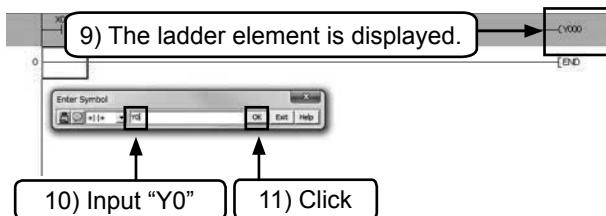
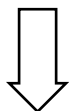

- 9) The ladder input $(\overline{Y0})$ is displayed.

- 10) Click the toolbar button . Input "Y0".

- 11) Confirm by pressing the key or .

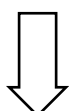

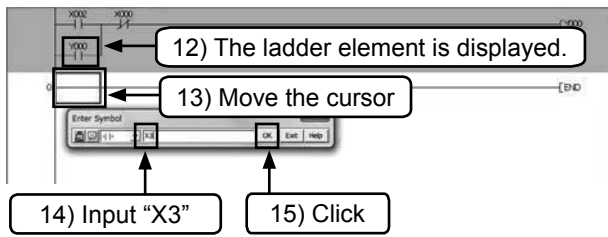

- 12) The ladder input (X000) is displayed.
- 13) Move the cursor to the beginning of the next line.
- 14) Click the toolbar button . Input "X3".
- 15) Confirm by pressing the key or [OK].

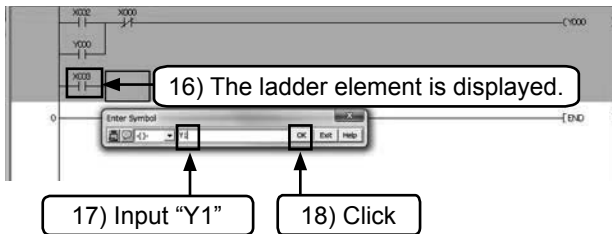
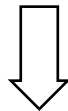

- 16) The ladder input (X000) is displayed.
- 17) Click the toolbar button . Input "Y1".
- 18) Confirm by pressing the key or [OK].

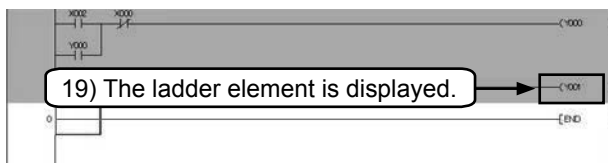
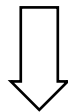

- 19) The ladder input (Y000) is displayed.

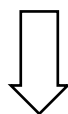

(Build)

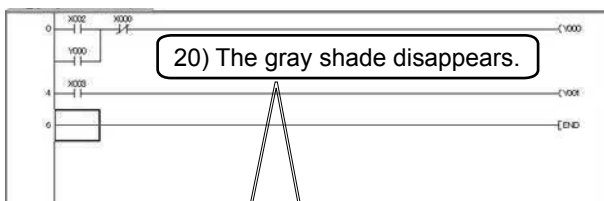

- 20) Compile Operation [Important].

Perform the "Compile" operation to finalize the ladder that has not been compiled (gray part).

Press the (Build) key.

Or select from the toolbar, or select [Compile] → [Build] from the menu.

The gray shade disappears and the program is compiled.
If an error occurs, the cursor moves to the problematic part of the program. Correct the program.

3.4 Writing programs to the PLC

Write the created sequence program to the FX PLC.

3.4.1 Connecting PC to PLC

Connecting the FX3G PLC (with a USB cable)

[Preparation on the personal computer side]

For connecting the FX3G PLC to the personal computer with a USB cable, it is necessary to install the USB driver software in the personal computer.

Install the USB driver software in accordance with the procedure described in the "GX Works2 Operating Manual (Common)".

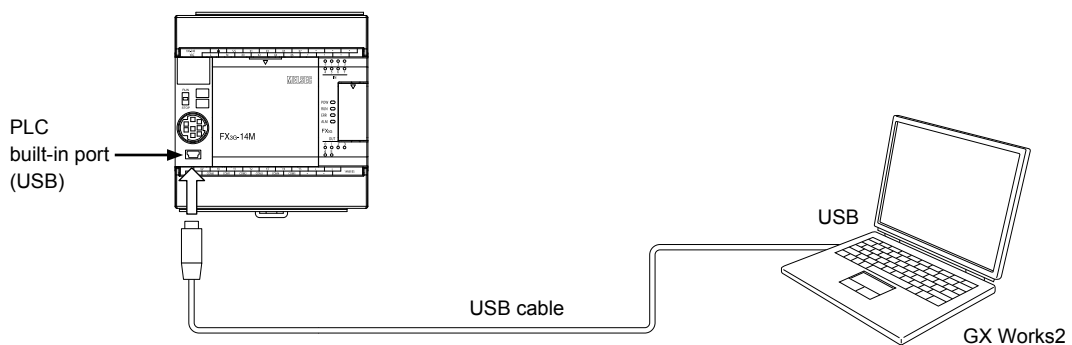

Point

USB Driver installation

<When using Windows® 7, Windows® 8>

1. Connect the personal computer and the programmable controller CPU with a USB cable, and then turn on the programmable controller CPU.
2. From Windows® Control Panel, select [System and Security] - [Device Manager]. Right-click "Unknown device" and click "Update Driver Software".
3. The Update Driver Software screen is displayed. Select "Browse my computer for driver software" and specify "Easysocket\USBdrivers" in the folder where GX Works2 has been installed on the displayed screen. If multiple MELSOFT products are installed previously, refer to their installed location.

* The USB driver installation is different when using FX3U-USB-BD and FX-USB-AW. Installation method also differs depending on the personal computer, please refer to "GX Works2 operating manual (Common)" for details.

3.4.2 "Transfer Setup" in GX Works2 and "Writing programs"

Configure the settings of GX Works2 to communicate with the PLC.

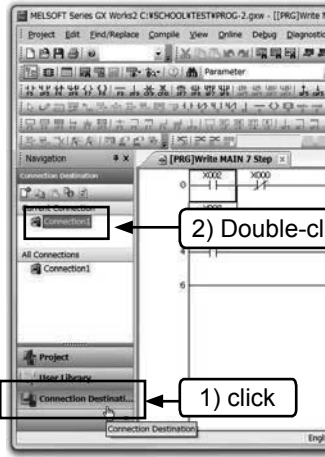

- 1) Click "Connection Destination".
- 2) Double-click "Connection1".

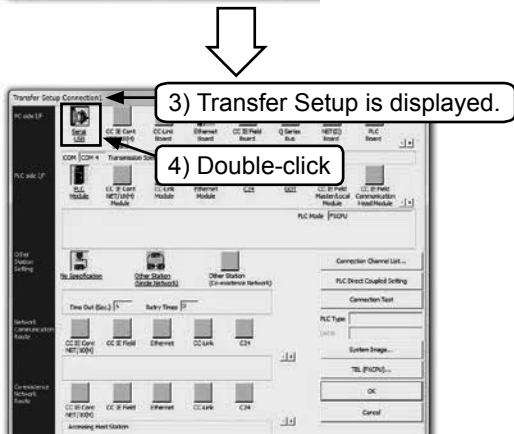

- 3) Transfer Setup is displayed.
- 4) Double-click the icon .

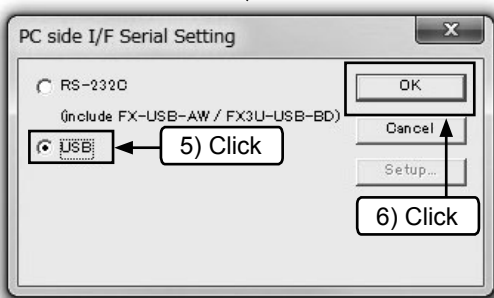

- 5) Set the communication port of the personal computer side.
 - Choose "USB" for connecting to the built-in USB port of the FX3G PLC.
- 6) Click [OK] after the setting is completed.

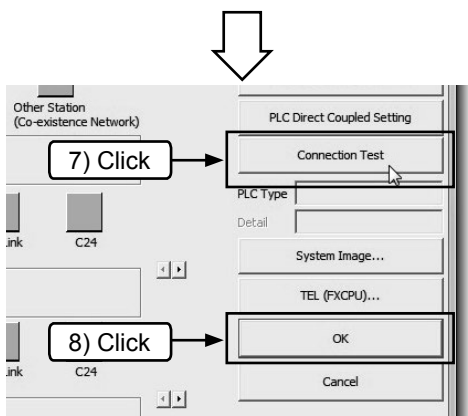

- 7) Click [Connection test], to check communication with the PLC.
- 8) After checking, click [OK] to confirm the configured setting.

9) Set the "RUN/STOP" switch of the PLC to "STOP".
 [Supplementary note: Automatic RUN/STOP function from the programming software]

- When attempting to write program while the PLC is in the RUN state, the message "The CPU status must be STOP to perform a write operation. Would you like to perform write operation?" appears after step (4).
- Click [Yes (Y)] to execute writing.
- When writing is finished, the message "The CPU status is currently STOP. Would you like to perform a remote-RUN?" appears.
- Click [Yes (Y)] to set the PLC to RUN state.

10) Select  from the toolbar, or select [Online] → [Write to PLC] from the menu.

11) Click [Param + Prog].

12) Click [Execute].

(Refer to "Supplementary note" in 9 above also).

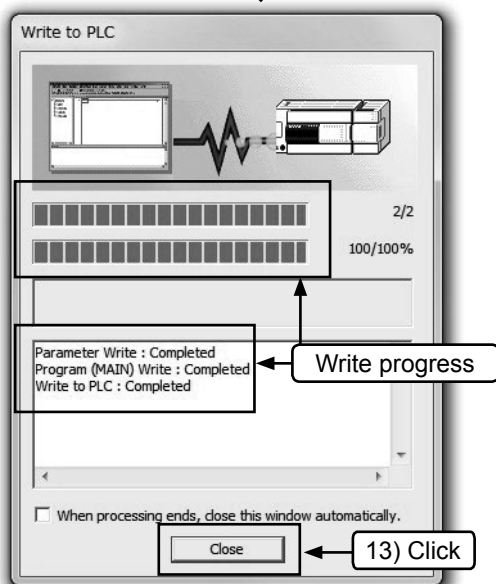
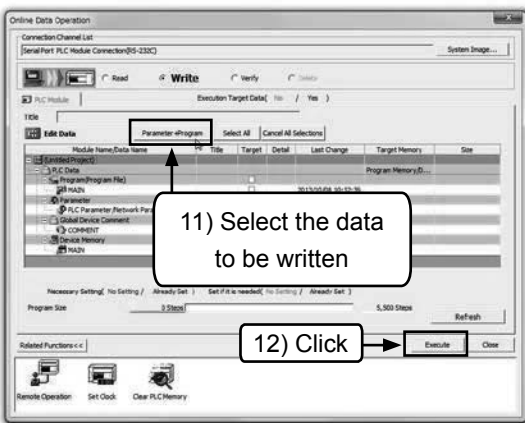
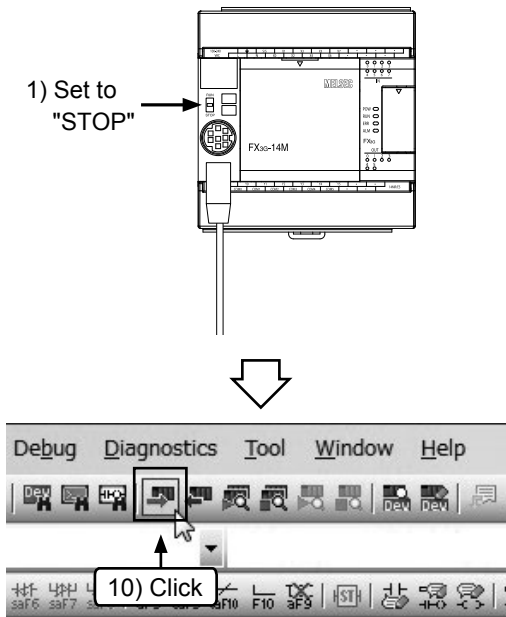

A dialog box showing the write progress is displayed.

13) Click [Close] after it is completed.

3.4.3 Monitoring PLC operation

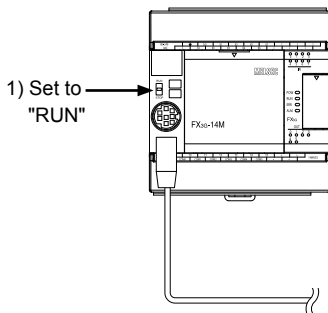

1) Set the "RUN/STOP" switch of the PLC to "RUN".

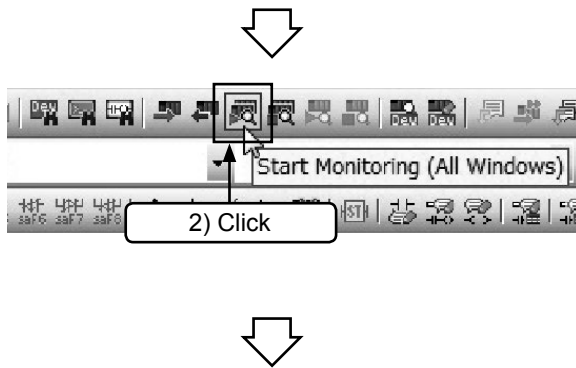

2) Perform either of the following operations:

- Click the **F3** (Monitor Mode) key.
- Click  on the toolbar.
- Select [Online] → [Monitor] → [Start Monitoring(All Windows)] from the menu.

Check operation by monitor mode

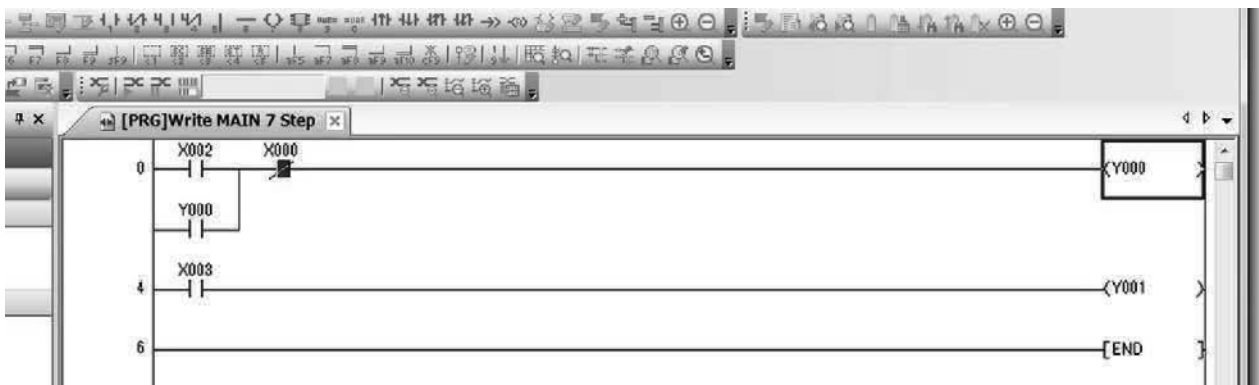

- 1) Set [Switch X002 is "ON"] and [Switch X000 is "OFF"], and then check [Output Y000 is "ON"].
- 2) Check [Output Y000 is "ON"] while [Switch X002 is "OFF"].
- 3) Set [Switch X000 is "ON"] and then check [Output Y000 is "OFF"].
- 4) Check [Output Y001 is "ON/OFF"] in accordance with [Switch X003 is "ON/OFF"].

Reference

1) The display of the monitor status dialog



1) Scan time

The maximum scan time of the sequence program is displayed.

2) PLC status

The status of the PLC is displayed.
 "▶" is displayed when PLC is in RUN, and "■" is displayed when PLC is in STOP.

3) Monitor execution status.

This icon is flashing during monitor mode.

4) Memory type

The memory type of the PLC is displayed.

2) Interpretation of the ladder monitor display

1. Contact Instruction

Type \ Input contact	X0 : OFF	X0 : ON
NO contact	X000 — — Contact open	X000 —■— Contact close
NC contact	X000 —■— Contact close	X000 — — Contact open

2. Out Instruction

Type \ Driving status	Non-execution/ Non-drive	Execution/Drive
OUT instruction	—(Y000)— —	—(Y000)■— —
SET instruction, etc.	—[SET M0]— —	—[SET M0]■— —

The ON/OFF status of the device to be reset is displayed during monitor mode using the RST instruction.

Type \ Device status	When device to be reset is OFF	When device to be reset is ON
RST instruction	—[RST M0]■— —	—[RST M0]— —

3.5 Editing a program

3.5.1 Correcting a program

Point

Switch between "Ovrwrte" and "Insert"

- Set to "Ovrwrte" when correcting and overwriting ladder.
- New ladder will be inserted when the "Insert" mode is on.

Switches between
"Ovrwrte" and "Insert"
by pressing the **Insert** key.

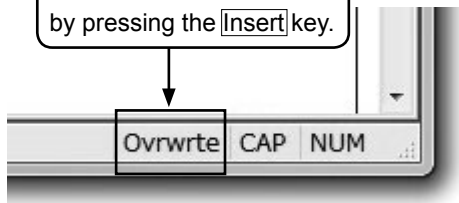

[1] Changing the OUT coils and contacts

[Program to be corrected]

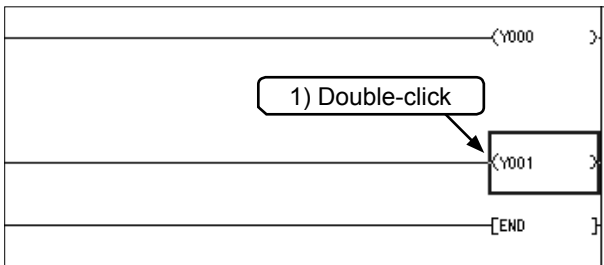
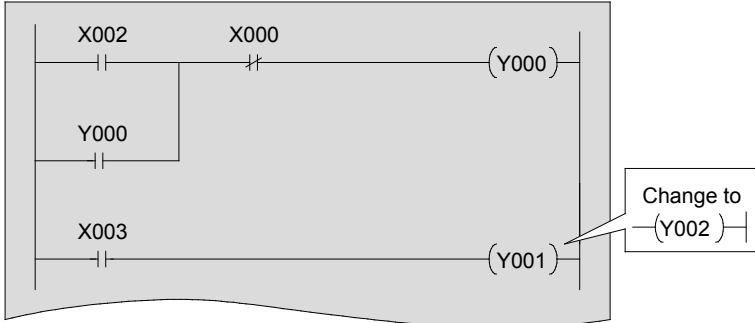

1) Double-click the part that needs to be corrected.

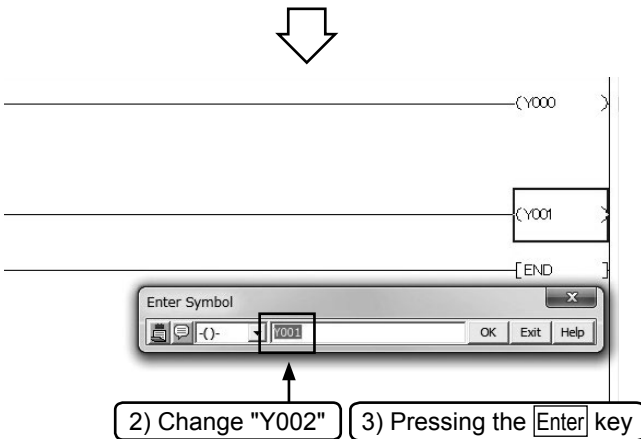

2) Change "Y001" to "Y002".
3) Confirm by pressing the key or [OK].

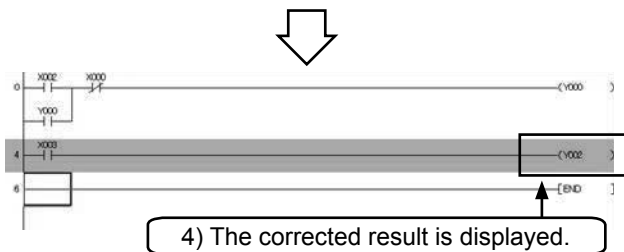

4) The corrected result is displayed and the ladder block is displayed in gray.

5) (Build)



5) Confirm the changes by pressing the (Build) key.

[2] Adding lines

[Program to be corrected]

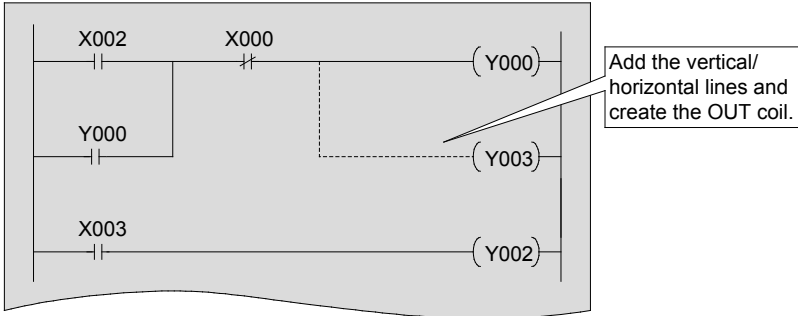

1) Click



1) Click  (F10) on the toolbar.



Locate the cursor on the upper right of the beginning of the vertical line to be added.

2) Locate the cursor on the upper right of the desired vertical line to be added, and then drag it until it reaches the desired position, and then drop it.

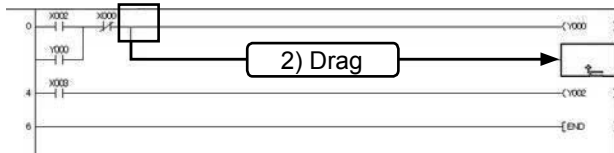

4) The position of the cursor

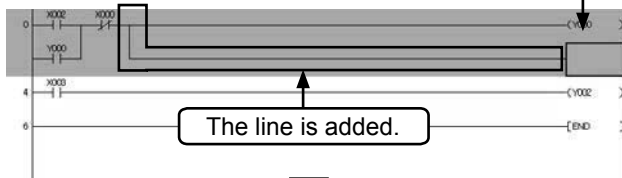

3) The line reaching the dropped position is added.

4) Locate the cursor on the position where the OUT coil is to be added and click  on the toolbar.



5) Input "Y3".

6) Confirm by pressing the **Enter** key or [OK].

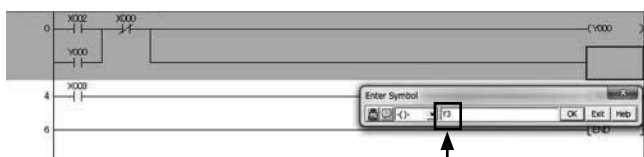

5) Change "Y3"

6) Pressing the **Enter** key



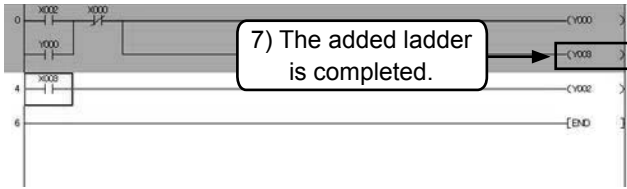



7) The added ladder is finished and the ladder block is displayed in gray.



8) **F4** (Build)

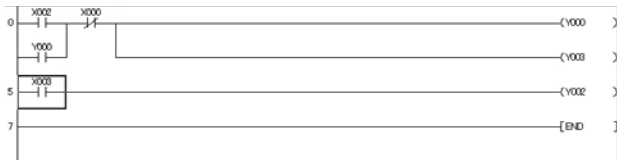



8) Confirm the changes by pressing the **F4** (Build) key.



- Click  on the toolbar again to finish the operation.

Reference

Adding lines using keys

In GX Works2, lines can be added using the **Ctrl** +  ,  ,  ,  keys.

[3] Deleting lines

[Program where lines are to be deleted]

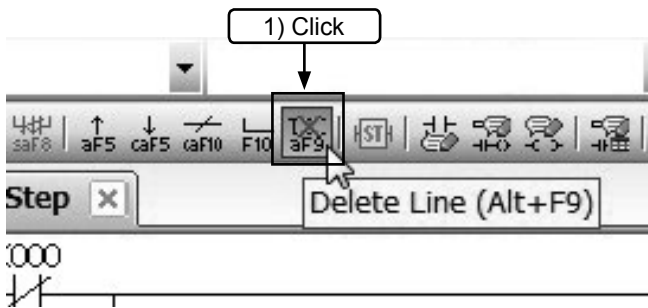
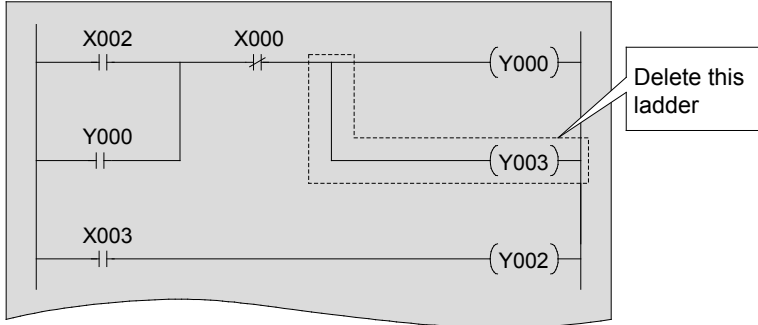

1) Click  (Alt + F9) on the toolbar.



Locate the cursor on the upper right of vertical line to be deleted.

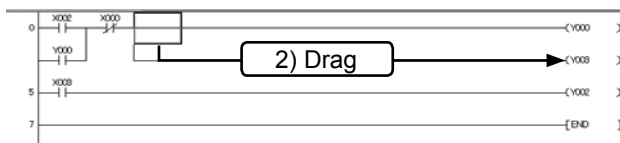

2) Locate the cursor on the upper right of the desired vertical line to be deleted, and then drag it until it reaches the desired position, and then drop it.

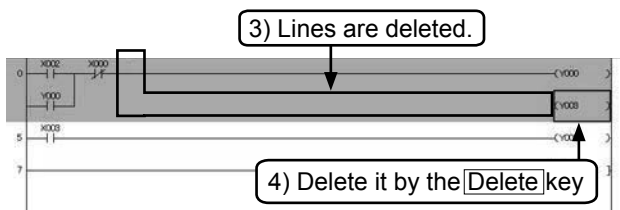

3) The lines are deleted.

4) Delete the OUT coil by pressing the **Delete** key.



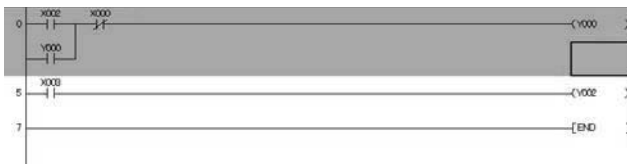



5) The deleted ladder block is displayed in gray.

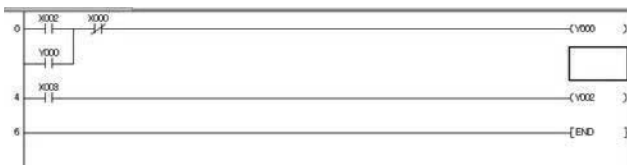

6) **F4** (Build)



6) Confirm the changes by pressing the **F4** (Build) key.

- Click  on the toolbar again to finish the operation.

Reference

Deleting lines using keys

In the GX Works2, lines can be deleted using the **Ctrl** + **→**, **←**, **↑**, **↓** keys.

3.5.2 Inserting and deleting rows

[1] Adding rows

[Program where a rung is to be inserted]

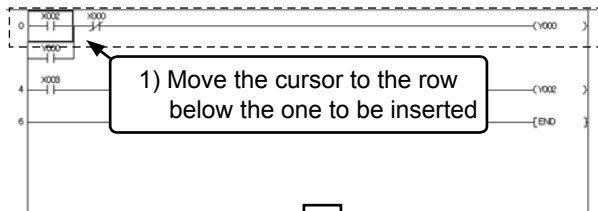
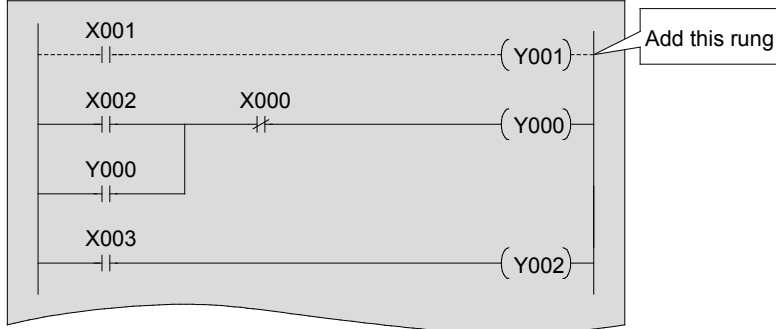

A row is inserted above the row where the cursor is located

1) Locate the cursor on the row below the one to be inserted.

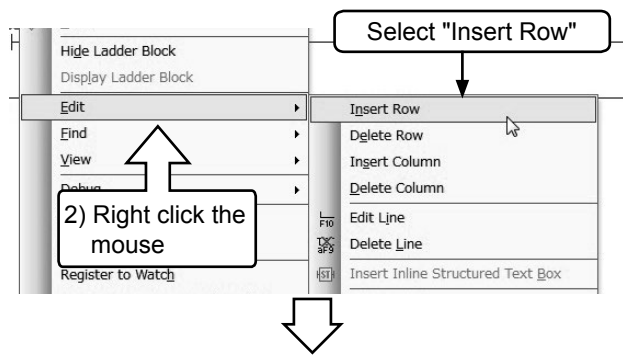

2) Right click the mouse at any place, and select [Edit] → [Insert Row].

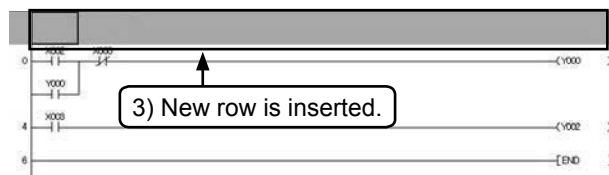

3) A row is inserted.

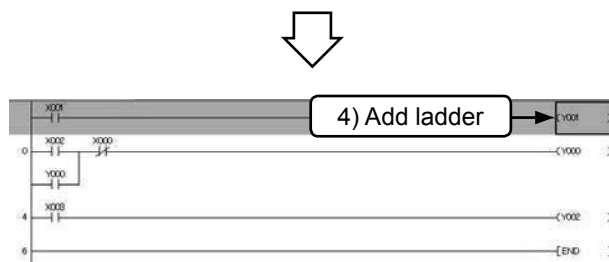

4) Add ladder in the inserted row.



5) Confirm the changes by pressing the **Build** (F4) key.

[2] Deleting rows

[Program where row is to be deleted]

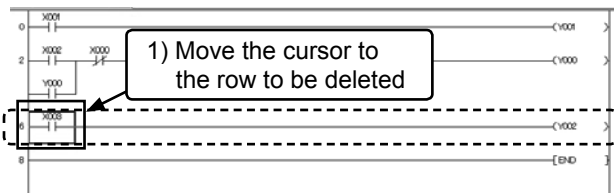
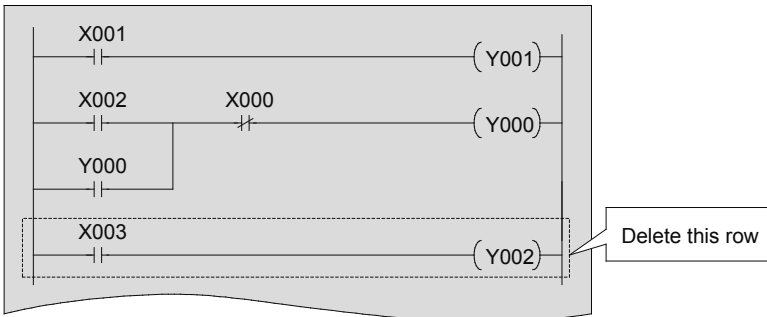

1) Move to the row to be deleted.

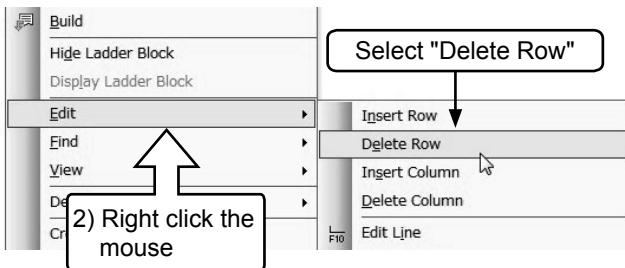

2) Right click the mouse at any place, and select [Edit] → [Delete Row].

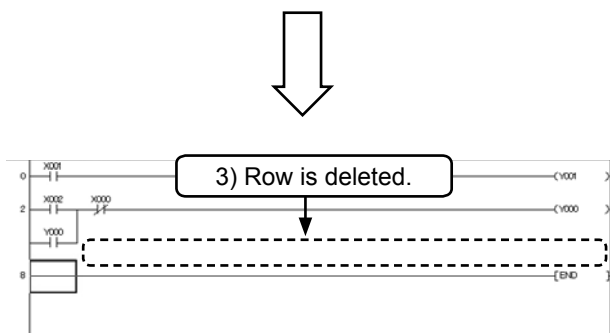

3) The row is deleted.

Point

Confirm it by pressing **Build** (F4).

3.5.3 Cutting and copying (pasting) ladder

[1] Cut

[Program to be edited]

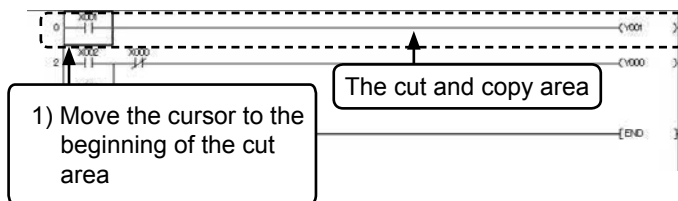
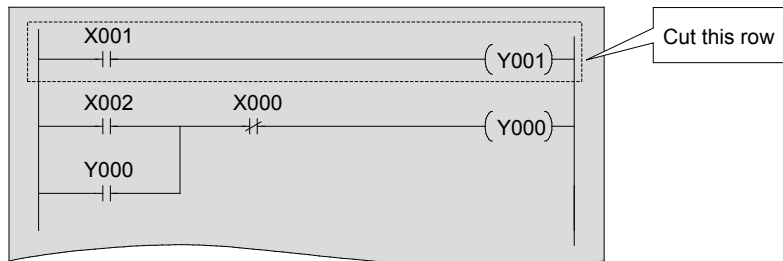

1) Move the cursor to the beginning of the ladder to be cut.

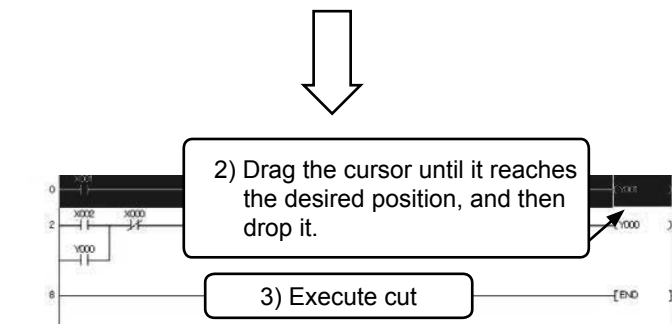

2) Drag it until it reaches the desired position, and then drop it.

3) Select  from the toolbar or select [Edit] → [Cut] (**Ctrl** + **X**) from the menu, and execute cut.

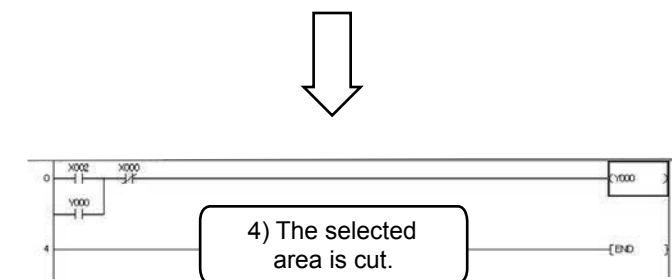

4) The selected area is cut
A gray part remains when a smaller portion of the ladder is cut. After amending the ladder, confirm the changes by pressing the **F4** (Build) key.

[2] Copy (pasting)

[Ladder to be copied (pasting)]

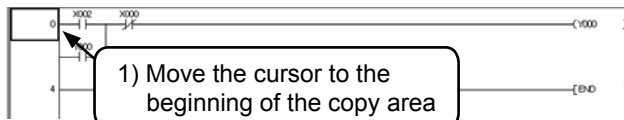
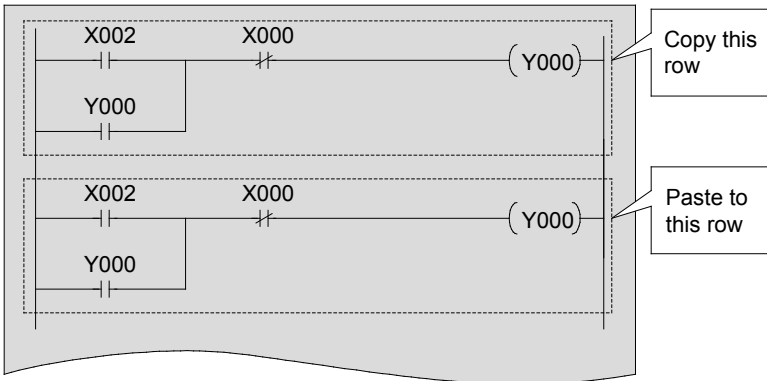

1) Move the cursor to the beginning of ladder to be copied.

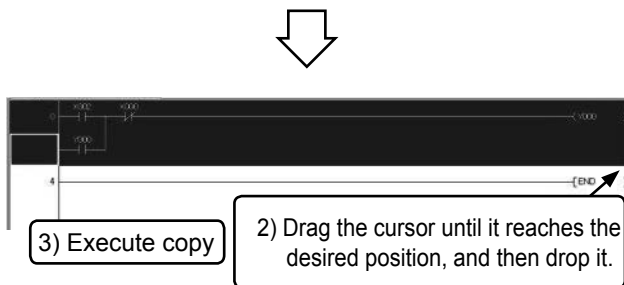

2) Drag the cursor until it reaches the desired position, and then drop it.

3) Select  from the toolbar or select [Edit] → [Copy] (**Ctrl**+**C**) from the menu.

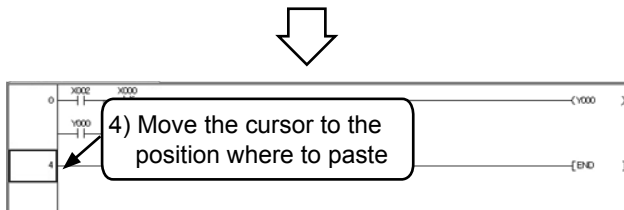

4) Move the cursor to the position where to paste.

Point
Using by the Insert key "Ovrwrte" mode : Pastes by overwriting data from the cursor position. "Insert" mode : Pastes it by inserting data at the cursor position.

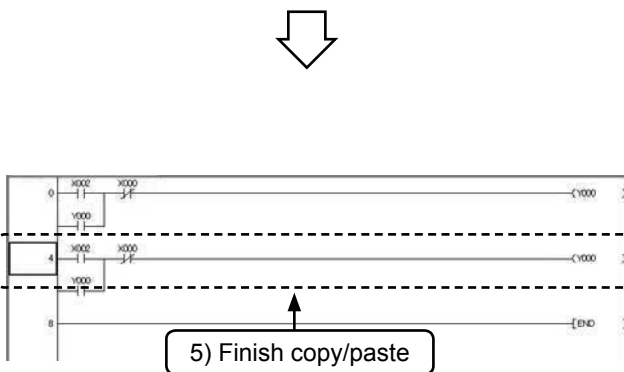

5) Select  from the toolbar or select [Edit] → [Paste] (**Ctrl**+**V**) from the menu.

A gray part remains when a smaller portion of the ladder is pasted. After amending the ladder, confirm the changes by pressing the **F4** (Build) key.

3.6 Saving the program

3.6.1 Save and Save as

Point

If there is ladder that has not been compiled, press **Build** (F4).

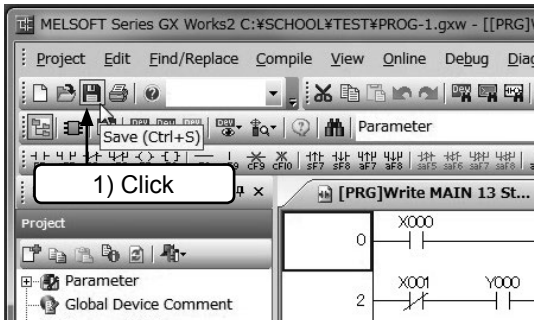

- 1) Select  from the toolbar or select [Project] → [Save] (Ctrl+S) or [Save As] from the menu.

(When it is newly saved)

(When it is saved by overwriting)

Project saving is finished.

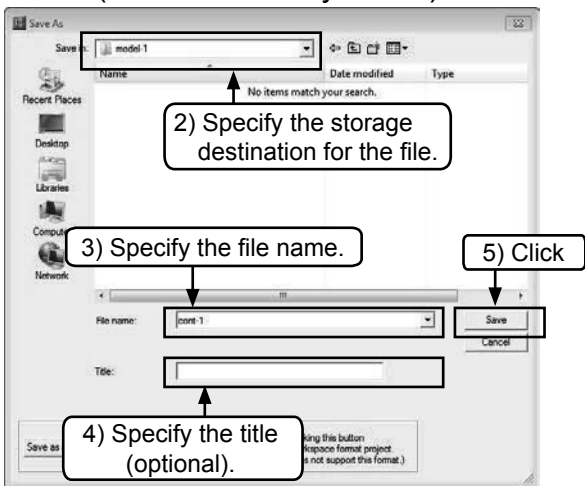

- 2) Specify the storage destination for the file.
- 3) Specify the file name.
- 4) Specify the title describing the project (optional).
- 5) Click **Save**.

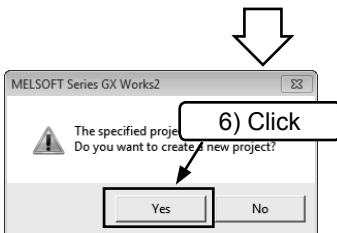



- 6) Click **Yes** in the confirmation dialog to finish.

3.6.2 Reading a project

Reference

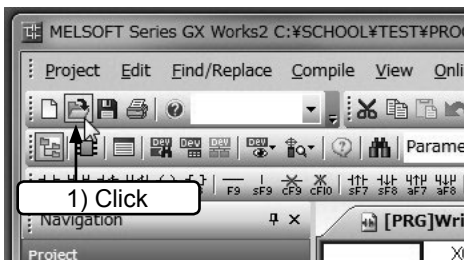
If another project is open when reading/opening a new file, the current project is closed.
If there is uncompiled ladder in the project or the project is not saved, a warning message is displayed.



- 1) Select  from the toolbar or select [Project] → [Open] (**Ctrl**+**O**) from the menu.

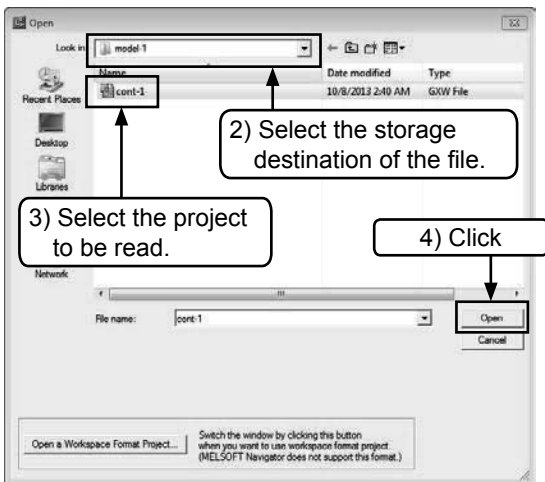

- 2) Select the storage destination of the file.
- 3) Select the project to be read.
- 4) Click **Open** to read the project.

3.7 Necessary operation for debugging a program

For connecting to the PLC and writing a program to the PLC, see "3.4 Writing programs to the PLC".

3.7.1 Ladder monitor

Display the ladder, and monitor the conduction status of the contacts and the driving status of the coils.

(See section "3.4 Writing programs to the PLC") .



- 1) Select  from the toolbar or select [Online] → [Monitor] → [Start Monitoring(All Windows)] from the menu.

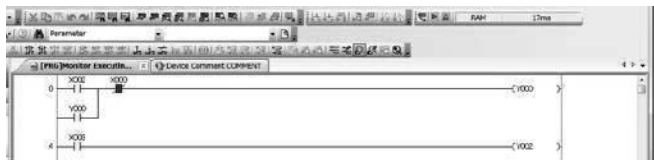
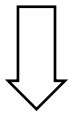

- 2) The ON/OFF status of the ladder and the current value of word devices (timer, counter and data register) are displayed in the ladder monitor window.

Reference

In GX Works2, stop monitoring by selecting the  icon (Stop Monitoring) on the toolbar or [Online] → [Monitor] → [Stop Monitoring] from the menu.
Ladder can be edited when monitoring is stopped.

3.7.2 Device registration monitor

Specify one device or a range on the ladder monitor window, and register corresponding device(s) on the watch window.

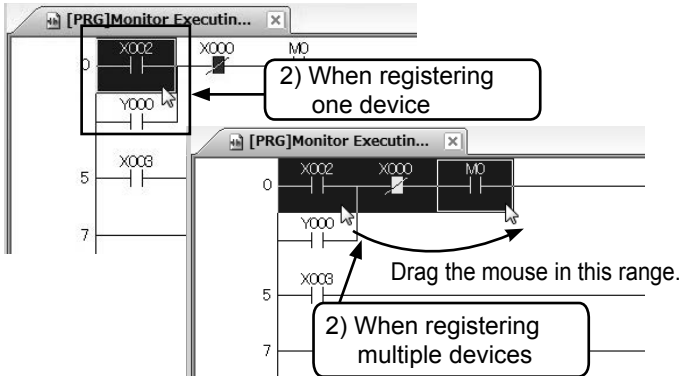

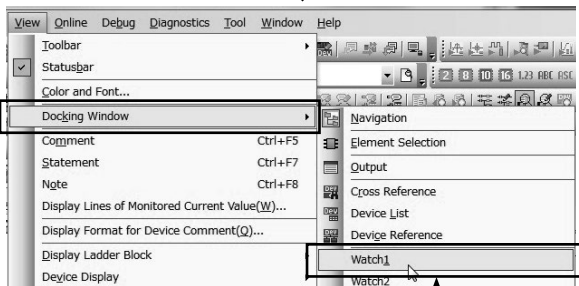

- 1) Set the ladder monitor status. (See “Ladder monitor” above).
- 2) • When registering one device, select it by clicking it.
• When registering multiple devices, click and drag to select the corresponding range.

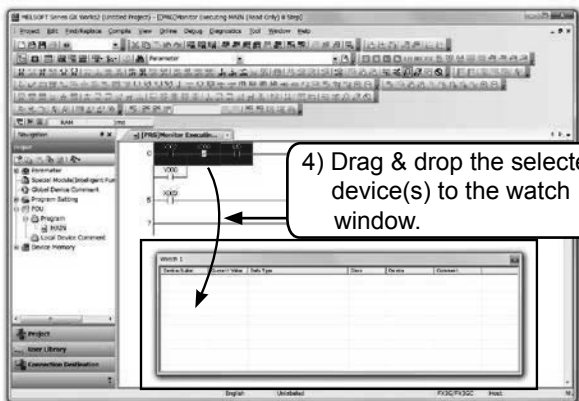

- 3) Display a watch window with [View]→[Docking Window]→[Watch 1].

3) A Watch window is displayed.



- 4) When the mouse icon changes to , drag and drop to the watch window.

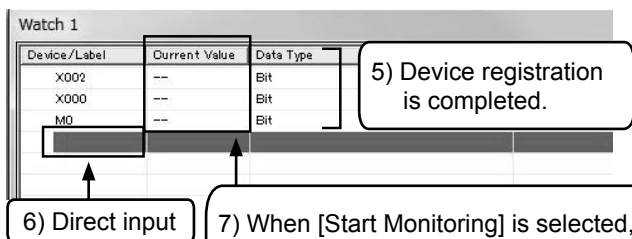

- 5) The selected device(s) is (are) registered in the watch window.

6) Direct input

7) When [Start Monitoring] is selected, the current values (Bit devices: 1 (= ON) or 0 (= OFF), word devices: current value) are displayed.

- 6) It is possible to directly input device names such as “X0”, “M0” and “D0” to blank spaces of the “Device/Label” column instead of dragging & dropping device(s).
- 7) Select [Online] → [Monitor] → [Start Monitoring] from the menu.

3.7.3 Device batch monitor

Specify a device and monitor a continuous range of devices that follow it.

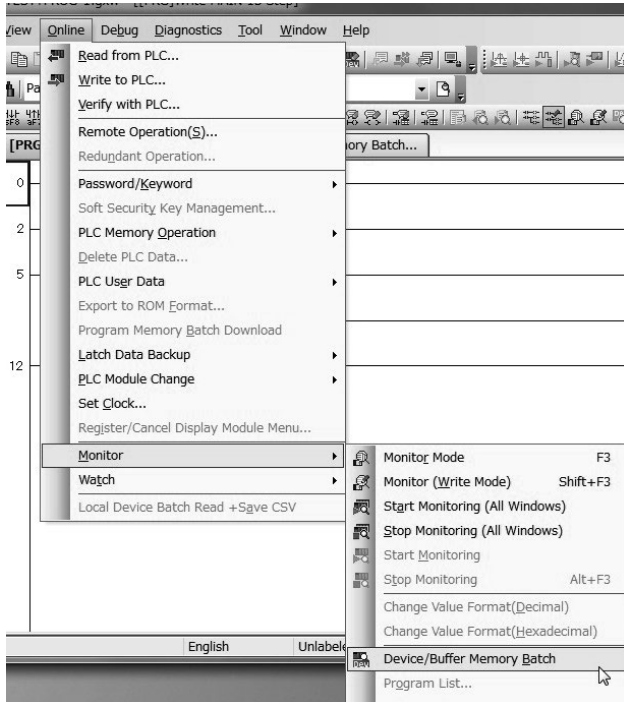

- 1) Set to monitor mode. (See Section “3.7.1. Ladder monitor”).
- 2) Select [Online] → [Monitor] → [Device/Buffer Memory Batch] from the menu. Or right click the ladder window and select [Device/Buffer Memory Batch].

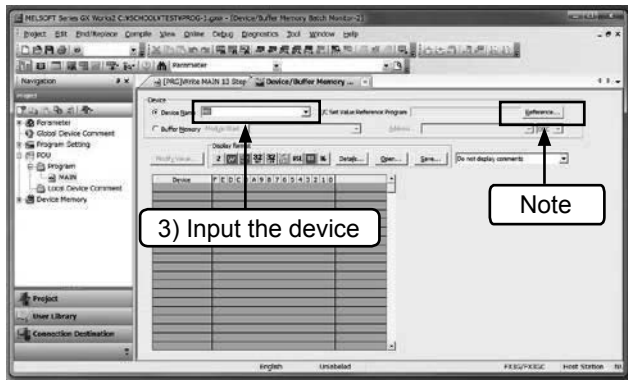

- 3) Input the first device of the devices to be monitored in the "Device/Buffer Memory Batch" window and then pressing the **Enter** key to begin monitoring.

(Note) When specifying a timer or counter, click [Reference], and specify the program “MAIN”.

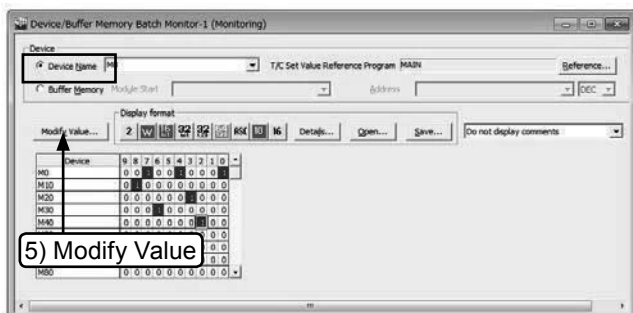

- 4) The operation state is displayed in accordance with the device type.
 - Bit devices (X, Y, M and S): 1 (= ON) or 0 (= OFF)
 - Timers and counters: ON/OFF status, set value and current value of contact/coil
 - Data registers: Current value
- 5) A bit device can be forcibly turned ON or OFF or the current value of a word device can be changed by selecting the corresponding displayed monitor data and clicking [Modify Value].

3.7.4 Device test

[1] Force ON/OFF

Using the device test screen, forcibly turn ON/OFF the bit devices of the PLC (M, Y, T, C and so on). (The forced ON/OFF function for X is not available).

When the PLC is running, the forced ON/OFF function can turn on or off specific devices.

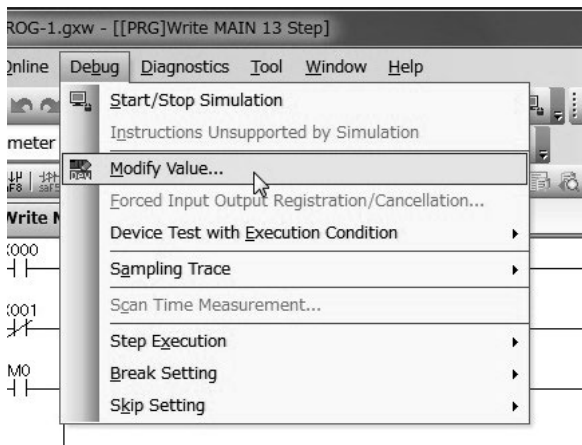

1) Set to monitor mode. (See Section “3.7.1. Ladder monitor”).

2) Select [Debug] → [Modify Value] from the menu.

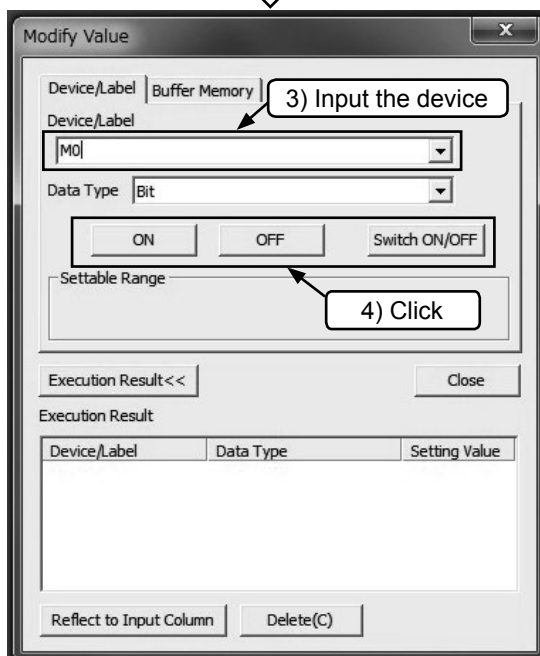

3) Input the device number to be forcibly turned on/off.

4) • [ON]: Forces device to ON.

• [OFF]: Forces device to OFF.

• [Switch ON/OFF]: Forces the device to toggle ON/OFF each time it is pressed.

Reference

Forced ON/OFF (Ladder monitor window)

Any bit device (contact and coil) can be forcibly turned on/off by double-clicking the device in the [Ladder monitor window] while pressing the [Shift] key.

[2] Changing the current value of a word device

Change the current value of the PLC's word device (T, C, D and so on).

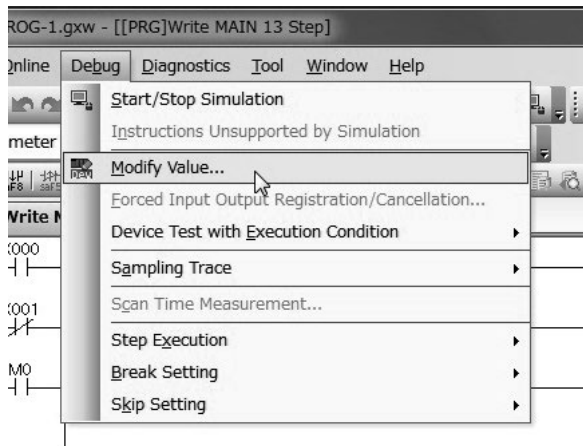

- 1) Set to monitor mode. (See Section “3.7.1. Ladder monitor”).
- 2) Select [Debug] → [Modify Value] from the menu.

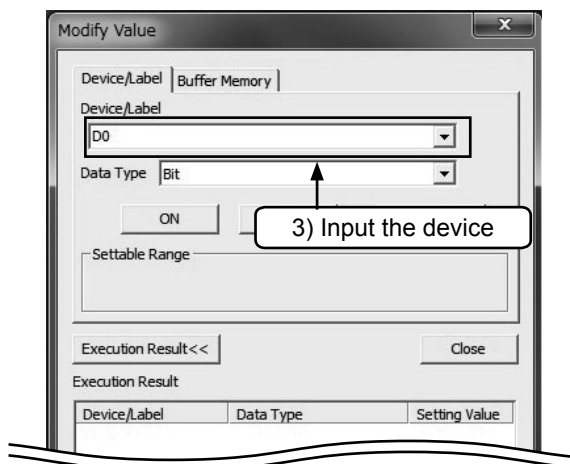

- 3) Input the device number to be changed.

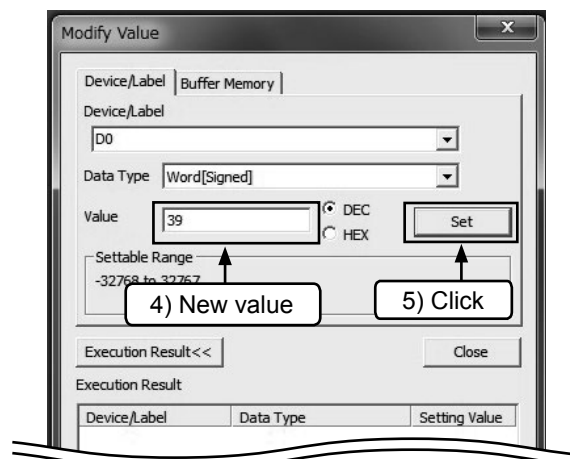

- 4) Input a new value.
- 5) Click [Set].

[3] Force ON/OFF and current value change using the watch window

It is possible to forcibly turn ON or OFF a bit device (such as M and Y) or change the current value of a word device (such as T, C and D) from the watch window.

When an input (X) is forcibly turned ON or OFF, it remains ON or OFF only in 1 scan cycle while the PLC is in the RUN state.

When checking the operation of outputs (Y), set the PLC to the STOP state.

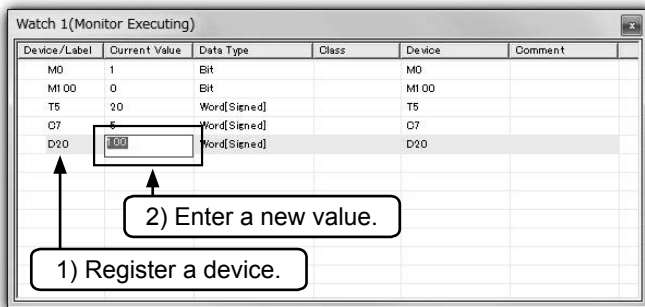

1) Enter the device number to the “Device/Label” column, and register it to the watch window.

(Note) After registering a device, select [Online] → [Watch] → [Start Watching] from the menu.

2) Enter a new value to the “Current Value” column, and pressing the key.

- Bit devices (such as X and Y): Enter “1” for “ON”, or “0” for “OFF”.
- Word devices (such as T, C and D): Enter a numeric value within the available range of the corresponding device.

3.7.5 Writing a program to the PLC during RUN

Write the corrected part of the ladder to the PLC when the PLC is running.

Less time is needed for writing during RUN since the entire program is not transferred.

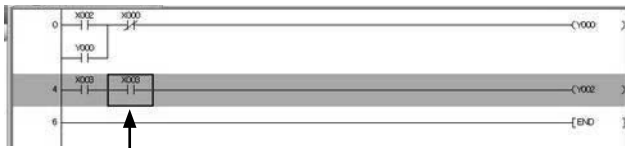
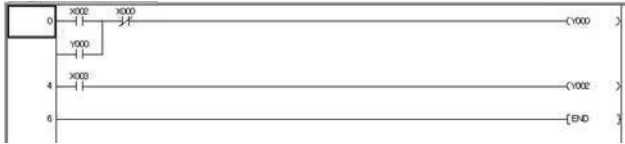

2) Add a contact

Write during RUN  [Shift]+[F4]

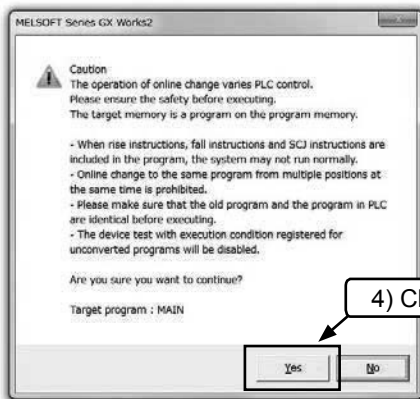

4) Click



5) Click

1) A contact will be added to the ladder on the left as an example. Within the ladder view, set the mode to write mode .

2) Add a contact.
The ladder block is displayed in gray.

3) Press [Shift] and [F4] together, or select [Compile] → [Online Program Change] from the menu.

4) Click [Yes] to confirm the warning message about PLC safety regarding online changes.

5) The message "Online change has completed." is displayed. Click [OK].

Caution

It is impossible to write the program to the PLC if the program in the PLC is different from the one in GX Works2. Verify in advance, or transfer the program first by using [Write to PLC].

3.8 Inputting comments

3.8.1 Types of comments

The following 3 types of comments can be input.

Type	Purpose	The number of characters (full-width)	Remark
1) Device comment	A comment describing the role and function of each device	16	It is necessary to set the "Comments capacity" in the parameter setting when writing to the PLC. The "Comment range setting" must also be set.
2) Statement	A comment describing the role and function of ladder blocks	32	This is a comment on GX Works2 side. (It is not downloaded to the PLC).
3) Note	A comment describing the role and function of output instructions	16	This is a comment on GX Works2 side. (It is not downloaded to the PLC).

[Comment Examples]

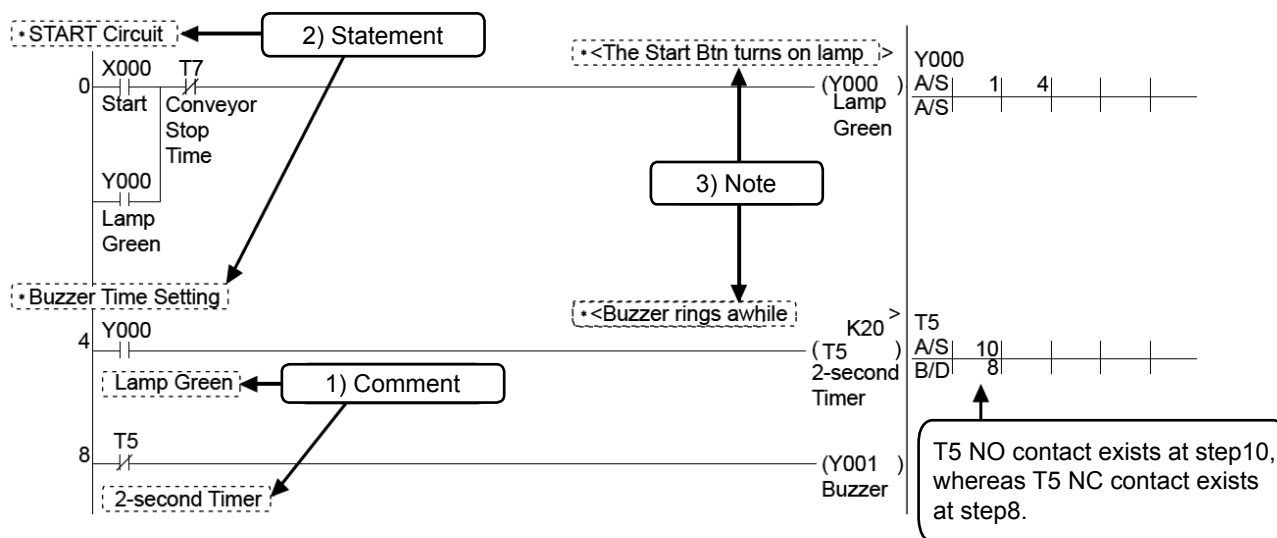

Point

How to display comments

Select [View] → [Comment] from the menu and then the comments are displayed.
Repeat the operation above to stop displaying comments.

Point

Global device comment and local device comment in the GX Works2

- Global device comment: This type of comment can be written to PLCs.
- Local device comment: By setting local device comments, it is possible to create multiple comments different from global device comments.
Local device comments can be written to Q Series PLCs, but cannot be written to the FX Series PLCs. In general, use "Global device comment".

3.8.2 Operation for creating device comments

[1] How to input device comments using a list

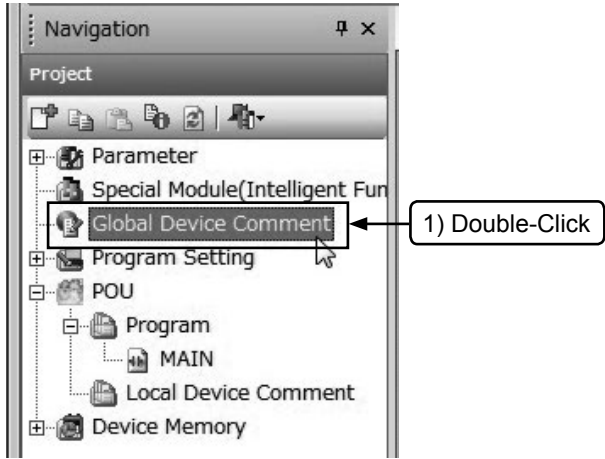

1) Double click [Global Device comment] in the project list.

2) Input the device number

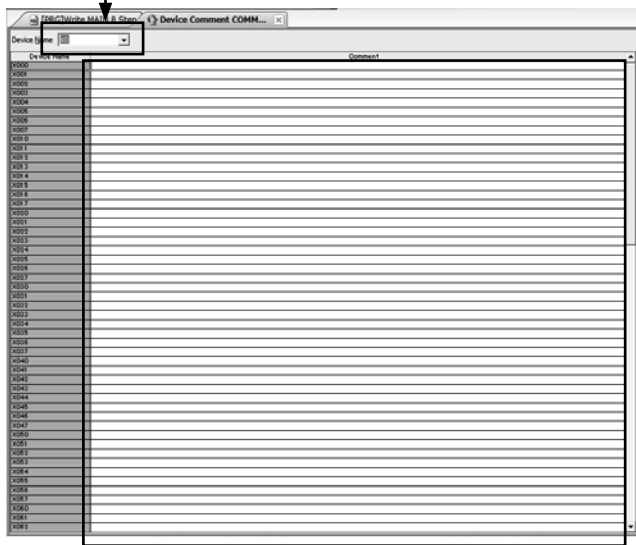

2) Input the start device of the devices to be commented in "Device Name", and press the **Enter** key.

3) Input comments in the "Comment" column.

- When inputting comments for another device, input the device number again in step 2.

3) Input comments

[2] How to input device comments in the ladder

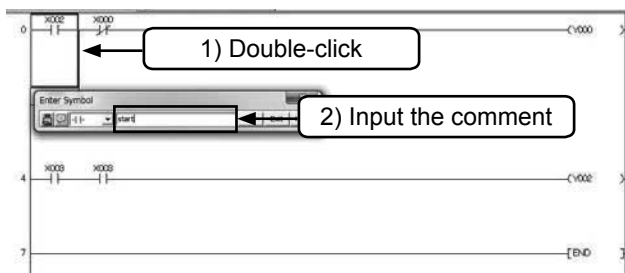

1) Click  from the toolbar and double-click the ladder element to be commented.

2) Input the comment in the "Enter symbol" window and click [OK].

- Click  on the toolbar again to finish the operation.

Point

Setting for writing the device comments to the PLC

It is necessary to set "Parameter setting" and "Comment range setting" in order to write the device comments to the PLC.

1) Parameter setting

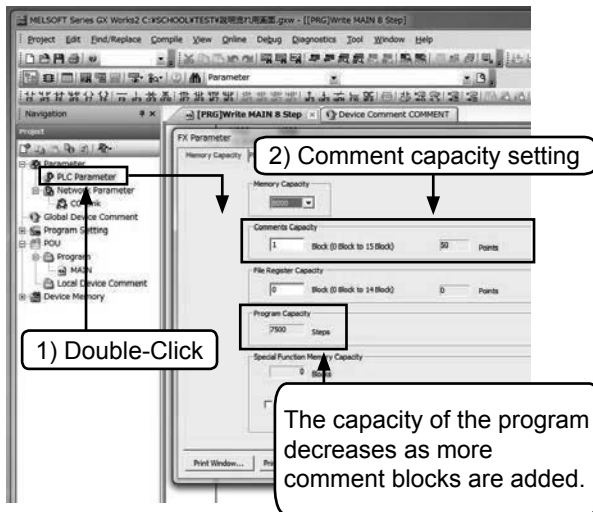

1) Double click [Parameter] → [PLC parameter] in the project list.

2) Set the "number of blocks" in the "Comments capacity" setting. One block is equivalent to 50 comments, occupying 500-steps of program memory.

2) Comment range setting

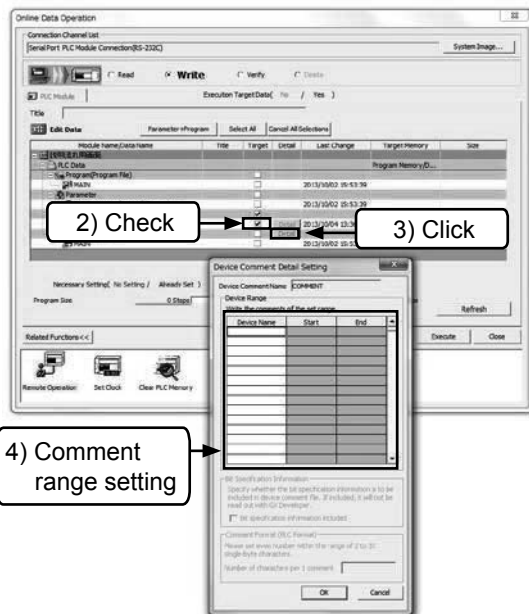

1) Choose [Online] → [Write to PLC] from the menu.

2) Check "global device comment".

3) Click [details].

4) Set the device type and range in the Device Comment Detail Setting dialog box.

Reference



How to input comments when creating a ladder



While inputting a ladder element, click the icon shown on the left to switch the input method.

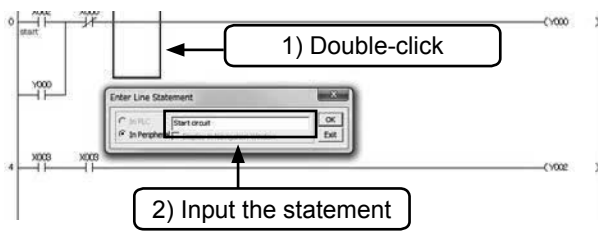

3.8.3 Operation for creating statements

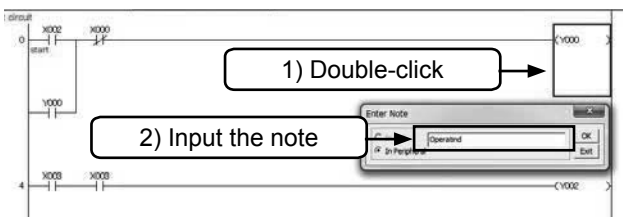

- 1) Click  from the toolbar, and double-click anywhere on the ladder block where the statement is to be written.
- 2) Input the statement in the "Enter line statement" window and click [OK].
 - Click  on the toolbar again to finish the operation.

3.8.4 Operation for creating notes



- 1) Click  from the toolbar, and double-click the output instruction symbol where the note is to be written.
- 2) Input the note in the "Enter Note" window and click [OK].
 - Click  on the toolbar again to finish the operation.

SEQUENCE INSTRUCTIONS

Chapter 4

SEQUENCE INSTRUCTIONS

What you have learned up till now

So far we have explained that PLCs are a collection of many relays, timers and counters, and that their internal sequences can be wired by key operation on a programming panel. When performing this wiring work, rules matched to contact and coil connection methods and types of coils are required. These rules are the instructions.

Instructions are programmed in the format "instruction word + devices number" or by individual instruction words.

This chapter introduces several of the basic instructions for programming a PLC.

4.1 Let's Remember PLC Instructions

4.1.1 Commands and Programs

There are two types of peripheral devices (programming devices) for entering Sequence programs: devices for drawing sequence program on screen and devices for entering programs using instruction words (that is, devices for creating a list program). These devices differ only by program input method, and the program itself is the same.

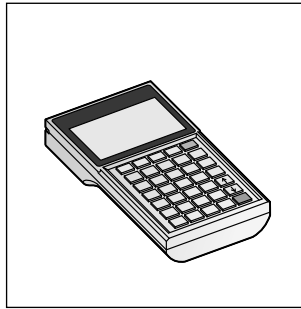

Devices used for input using instruction words

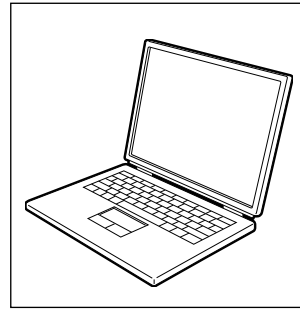

Device used for input using ladder diagrams

The following table summarizes the instructions held by a PLC, the meanings of each instruction and how the ladder is indicated in a sequence program.

Notation, Name	Function	Ladder representation
LD Load	Bus connection instruction, N.O. contact	
LDI Load inverse	Bus connection instruction, N.C. contact	
AND AND	Series connection, N.O. contact	
ANI AND inverse	Series connection, N.C. contact	
OR OR	Parallel connection, N.O. contact	
ORI OR inverse	Parallel connection, N.C. contact	
ANB AND block	Series connection between blocks	
ORB OR block	Parallel connection between blocks	
OUT Out	Coil drive instruction	
SET Set	Latch operation, coil instruction	
RST Reset	Cancel latch operation, coil instruction	
NOP No operation	No operation	For deleting program or space
END END	End of program	End of program Return to 0 step

- and used in ladder indications indicate contacts. Contacts are in two states, conducting and non-conducting, depending on the ON/OFF state of input relays or output relays, auxiliary relays, timers, and counters. and show driving of coils.

4.1.2 Program mechanics

The internal sequence for the sequence controlling is created as the sequence program with the format of circuit diagram (ladder diagram) and instruction list.

Instruction list (program list)

Step number	Instruction	
	Instruction code	Device (number) (operand)
0	LD	X001
1	OR	Y000
2	ANI	X003
3	OUT	Y000
4	LD	Y000
5	ANI	X006
6	OUT	T1 K30
9	END	

Repeat operation

Circuit diagram (ladder diagram)

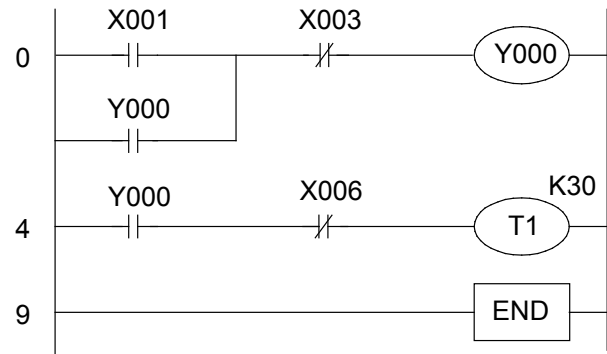

- A program is comprised of multiple instruction codes and device numbers (operand). These instructions are numbered in turn. This number is referred to as **step number**. (Step numbers are automatically controlled).
- Each "**instruction**" is comprised of "**instruction code + device number**". However, there are some instructions without devices. Also in some cases, instruction codes are just referred to as instructions.
- The max steps that can be programmed depend on the "program memory capacity" of the PLC that is used. For example, there is a program memory with the capacity of "2000" steps in FX1S PLC, "8000" steps in FX1N and FX2N, and "64000" steps in FX3U.
- PLC repeatedly performs the instruction from step 0 to the END instruction. This operation is referred to as **cyclic operation**, and the time required to perform this one cycle is referred to as **operation cycle (scan time)**.
Operation cycle will be changed according to the contents of the programs and the actual operating orders, ranging from several msec to several tens of msec.
- The PLC program created by the format of circuit diagram (ladder diagram) is also stored in the program memory of the PLC with the format of instruction list (program list).
The conversion between instruction list (program list) and circuit diagram (ladder diagram) can be done by using the programming software in personal computer.

4.1.3 N.O. contact, N.C. contact, OUR instruction, END instruction

Circuit program

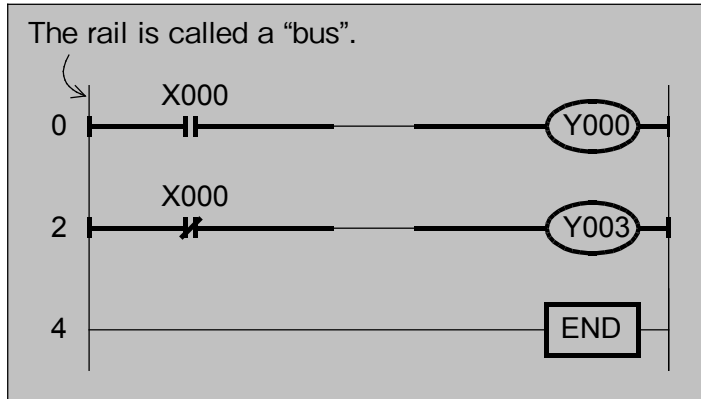

Step numbers

Step numbers indicate the order and size of a program. If you program instructions in the order of the list program, the PLC will automatically assign the step numbers.

By the above program...

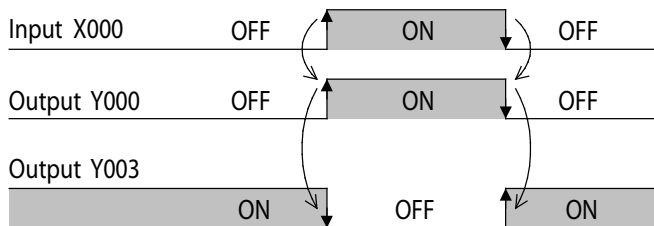

Output Y000 turns ON when input X000 is ON.
Output Y003 turns ON when input X000 is OFF.

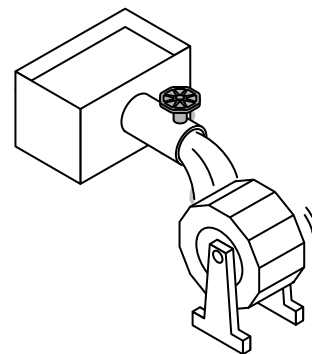

Reference

Programming by instruction list

LD

Load
Bus connection instruction for N.O. contacts

LDI

Load inverse
Bus connection instruction for N.C. contacts

OUT

Out
Coil drive instruction

END

End
Instruction used for the end of a program

List program

Step	Instruction
0	LD X000
1	OUT Y000
2	LDI X000
3	OUT Y003
4	END

The LD (Load) instruction is used for the first N.O. contact used on the bus, and the LDI (Load inverse) instruction is used for N.C. contacts. Contact instructions such as LD and LDI are used for devices such as input relays X, output relays Y, timers T, counters C, and auxiliary relays M. Coil drive instructions such as OUT are used for devices other than input relays X.

4.1.5 Parallel connection

Circuit program

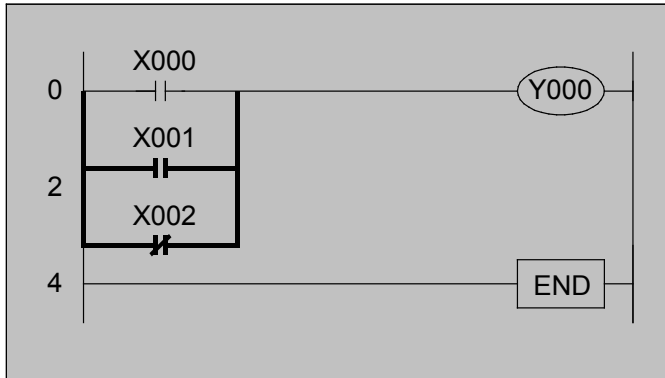

By the above program...

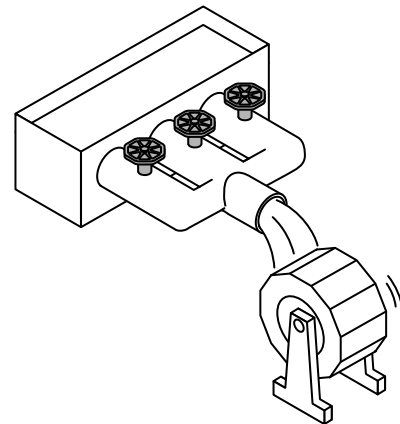
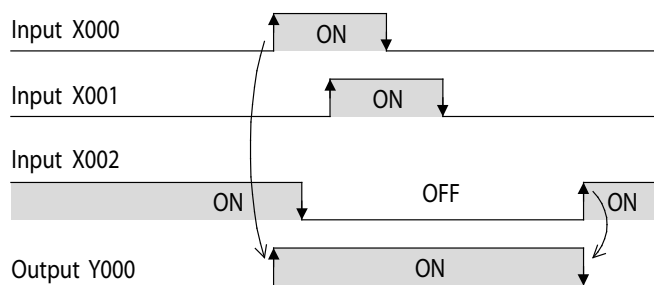

Reference

Programming by instruction list

OR

OR
Parallel connection instruction for N.O. contacts

ORI

OR inverse
Parallel connection instruction for N.C. contacts

List program

Step	Instruction
0	LD X000
1	OR X001
2	ORI X002
3	OUT Y000
4	END

The OR (OR) instruction is used for N.O. contacts and the ORI (OR Inverse) instruction is used for N.C. contacts connected in parallel following the LD and LDI instructions. Output Y000 in the figure on the left operates when even one of the contacts connected in parallel that is driving OR and ORI is conducting.

4.1.6 Series and parallel connections

Circuit program

Example program 1

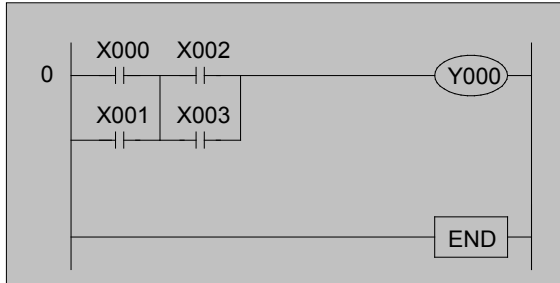

Example program 2

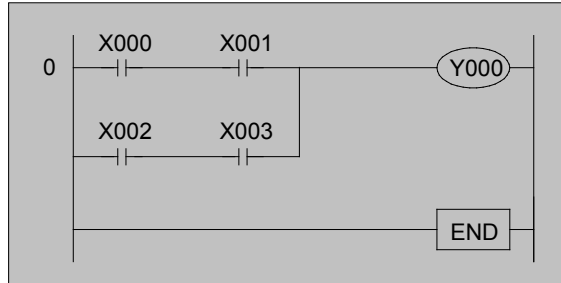

By the above program...

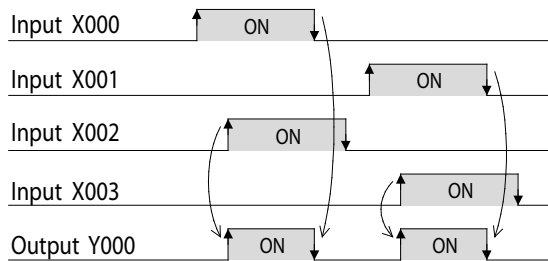

When input X000 or X001, and X002 or X003 turn on simultaneously, Y000 turns on.

By the above program...

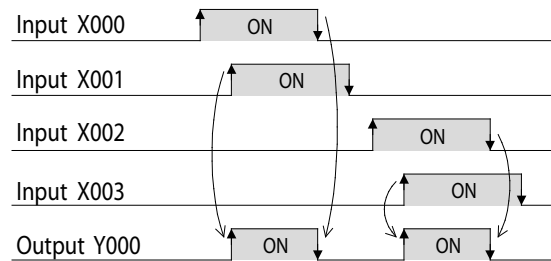

When the inputs X000 and X001 turn on simultaneously or X002 and X003 turn on simultaneously, the output Y000 turns on.

Reference

Programming by instruction list

Example program 1

List program

Step	Instruction
0	LD X000
1	OR X001
2	LD X002
3	OR X003
4	ANB
5	OUT Y000
6	END

Example program 2

List program

Step	Instruction
0	LD X000
1	AND X001
2	LD X002
3	AND X003
4	ORB
5	OUT Y000
6	END

Refer to the appendix for the details of an ANB and an ORB command.

4.1.7. SET instruction, RST instruction

SET

Set
Operation hold
output instruction

RST

Reset
Operation hold
cancel instruction

The SET/RST instructions are used for output relays Y and auxiliary relays M, for example. The RST instruction is also used for counters and retentive timers.

Circuit program

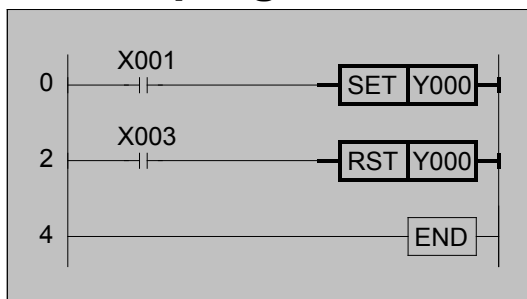

These instructions drive coils like the OUT instruction.

With the OUT instruction, coils programmed with the OUT instruction also turn OFF when the contact that drives the coil changes state from ON to OFF. However, when the SET (Set) instruction is used, the operation state of the coil is held at ON even if the state of the contact changes from ON to OFF.

The RST (Reset) instruction is used to change the state of the coil driven by the SET (Set) instruction from ON to OFF.

By the above program...

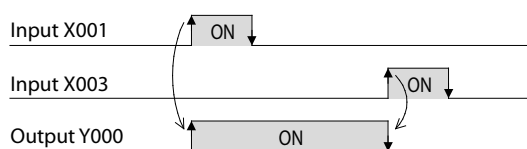

Output Y000 turns ON when input X001 is turned ON.

After this, the operation state of Y000 is held at ON even if the state of input X001 changes from ON to OFF.

Output Y000 turns OFF when input X003 is turned ON.

● Input method

[] SET Y0
F8 Space

[] RST Y0
F8 Space

Reference

Programming by instruction list

List program

Step	Instruction
0	LD X001
1	SET Y000
2	LD X003
3	RST Y000
4	END

4.1.8 About Latch Circuits

Output operation can be held or cancelled by programming a self-hold sequence.

Circuit program

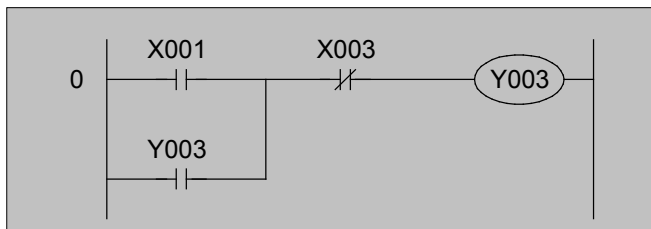

By the above program...

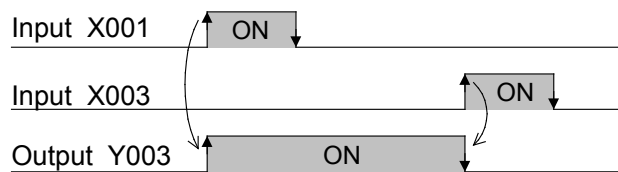

- Y003 turns ON when X003 is ON and X004 is OFF.
- Y003 continues to operate even if X003 is turned OFF. (This is "self-hold operation.") Y003 turns OFF when X004 is turned ON.

Reference

Both circuits perform the same operation.

[Output latch circuit]

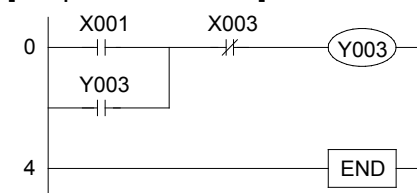

[Output SET/RST circuit]

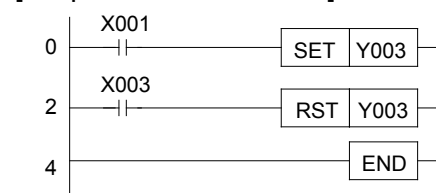

same operation

When the SET instruction is used, the output will stay ON even when the contact driving the coil turns OFF. Also, it can be used multiple times for the same output without being treated as a double coil. It is useful for directly controlling an output from multiple points in the program.

Reference

Programming by instruction list

[Output latch circuit]

Step	Instruction
0	LD X001
1	OR Y003
2	ANI X003
3	OUT Y003
4	END

[Output SET/RST circuit]

Step	Instruction
0	LD X001
1	SET Y003
2	LD X003
3	RST Y003
4	END

4.2 About Timer Circuits

Timers

Of the various timers available, this section describes how to program a digital timer that is held internally on a micro PLC.

Circuit program

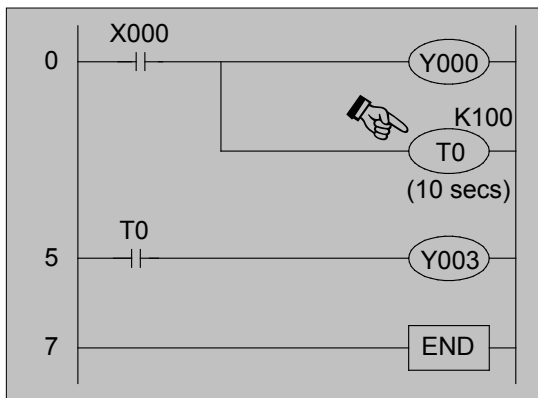

By the above program...

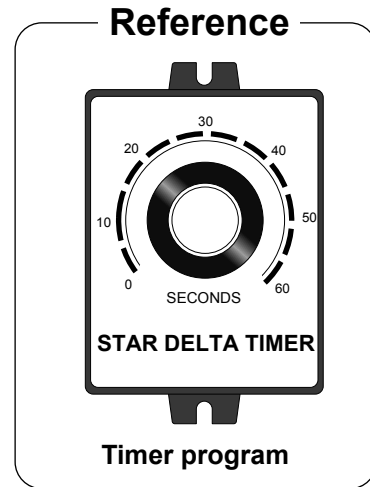
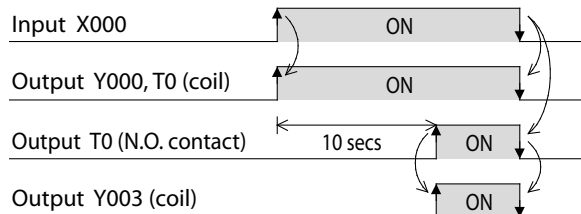

- The timer contact operates after a preset delay has elapsed after the coil has been made conductive. (ON delay timer) This preset time is called the "set value" and is expressed as K which can be set in the range 1 to 32,767. For example, K100 is a timer of ten seconds*.

- When X000 is turned OFF while the timer is being driven, the present value of the timer returns to "0" and the timer contact also turns OFF.

- Input method

`() T0 K100`
`F7` Space

* : When a 100 ms (0.1 second) timer is used

Reference

Programming by instruction list

Step	Instruction
0	LD X000
1	OUT Y000
2	OUT T0 K100

Step	Instruction
5	LD T0
6	OUT Y003
7	END

4.3 About Counter Circuits

Counters

Of the various counters available, this section describes how to program a general-purpose counter that is held internally on a micro PLC.

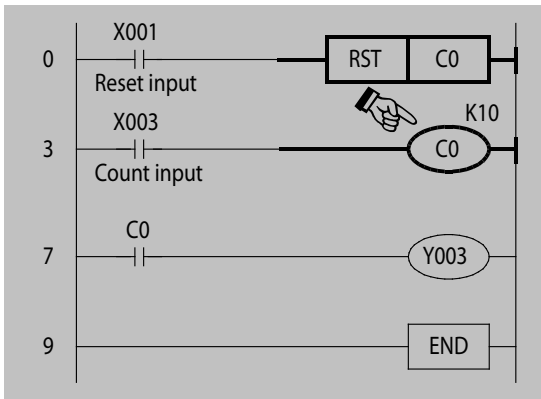
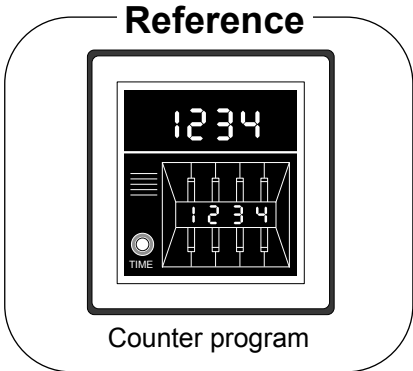

- Counters count the number of times a contact (X003) changes state from OFF to ON. This contact (X003) is called the "count input," and the value counted by the counter is called the "present value." The counter operates when the present value reaches the specified number (set value). The set value can be set a value within the range 1 to 32,767.

By the above program...

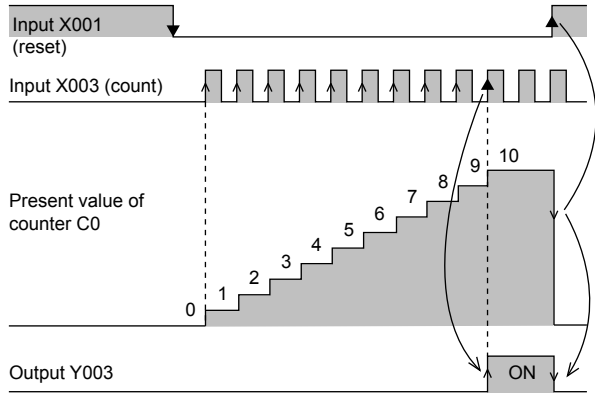

- After the counter has counted up, the present value of the counter does not change, and the output contact stays in an operating state.
- When reset input X001 turns ON, the present value of the counter returns to "0" and the counter contact also turns OFF.
- Input method

```
( ) C0 K10
F7   Space
```

Reference

Programming by instruction list

Step	Instruction
0	LD X001
1	RST C0
3	LD X003
4	OUT C0 K10

Step	Instruction
7	LD C0
8	OUT Y003
9	END

4.4 Order of Programs

Program order

Circuit diagrams are programmed from left to right and from top to bottom.

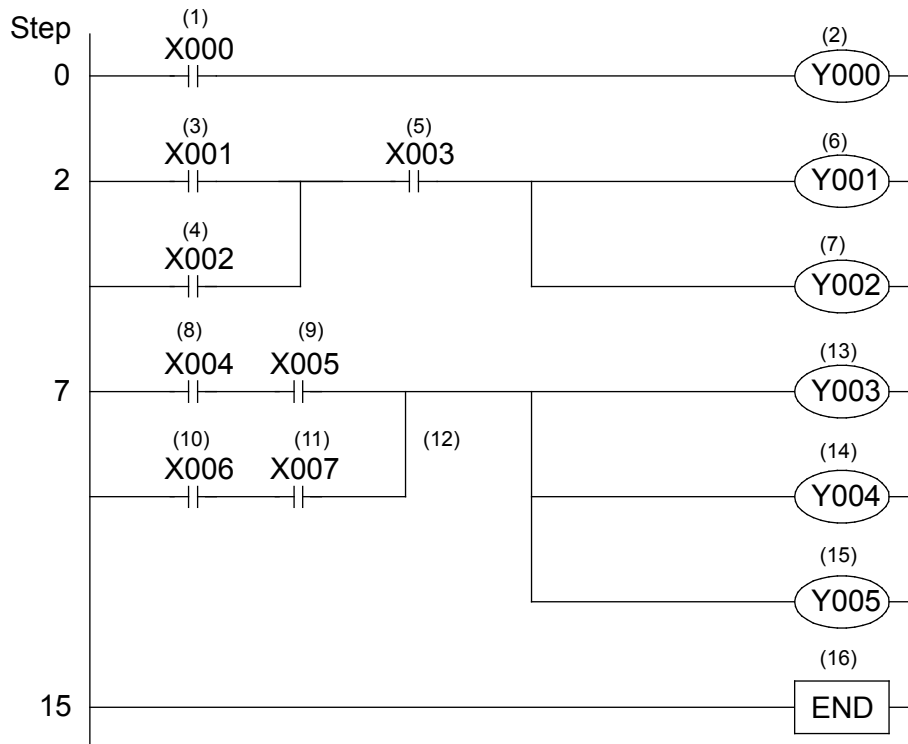

A program like the one above is made using 16 program steps, (1) to (16). The following shows the above program rewritten as a list program.

Reference

Programming by a command list

Step	Instruction	
0	LD	X000
1	OUT	Y000
2	LD	X001
3	OR	X002
4	AND	X003
5	OUT	Y001
6	OUT	Y002
7	LD	X004
8	AND	X005
9	LD	X006
10	AND	X007
11	ORB	
12	OUT	Y003
13	OUT	Y004
14	OUT	Y005
15	END	

Starting with simple programs

Chapter 5

PROGRAM TRAINING

Enough for theory, and now for practice

In this chapter, you study all about handling and operation such as programming and monitoring based on some simple examples.

5.1 Introductory Example 1 (Control of Escalators)

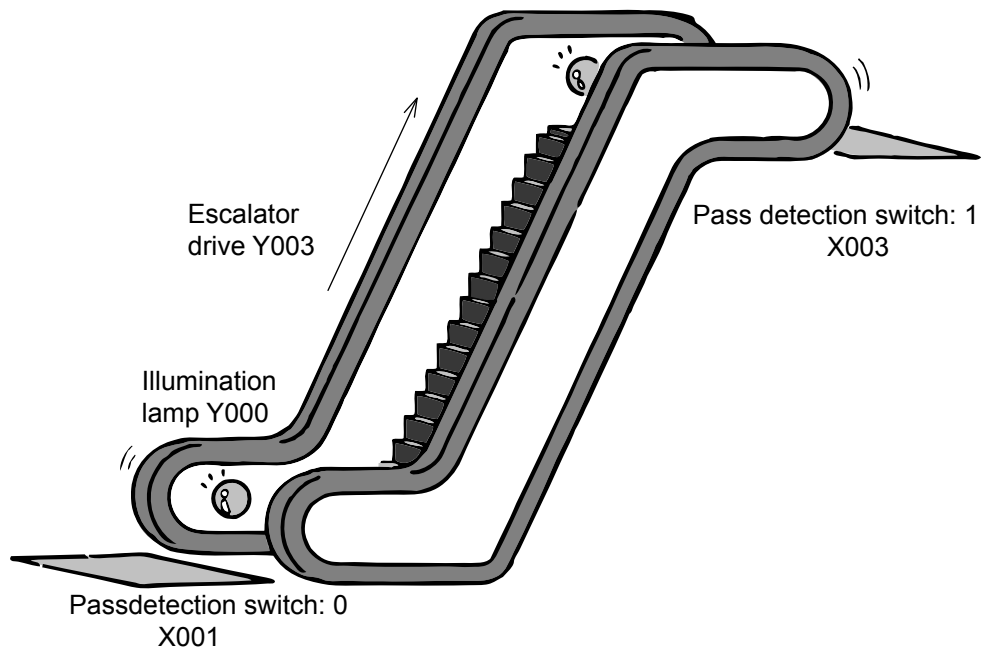

Let's consider a PLC program for an escalator.

《 I/O assignments 》

Input	Pass detection switch:0	X001
	Pass detection switch: 1	X003
Output	Illumination lamp	Y000
	Escalator drive output	Y003

《 Operation 》

- (1) Let's assume that the escalator does not move until someone approaches it.
- (2) When someone approaches the escalator and turns on pass detection switch: 0, the illumination lamp lights and the escalator starts to move. (Escalator movement is up only).
- (3) The person is carried up by the escalator, and when that person moves off the escalator, pass detection switch: 1 turns ON, and the illumination lamp and escalator return to a non-operating state.

In this example, consider both pass detection switches: 0 and 1 as non-hold type switches.

Another assumption in this example is that people do not continue to get on this escalator.

The program is configured as follows

《Circuit program : Example 1》

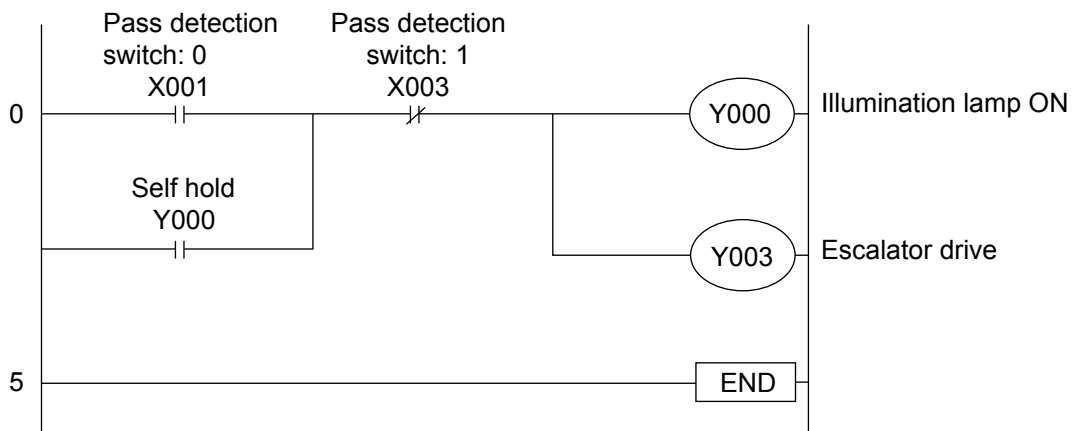

《Circuit program : Example 2》

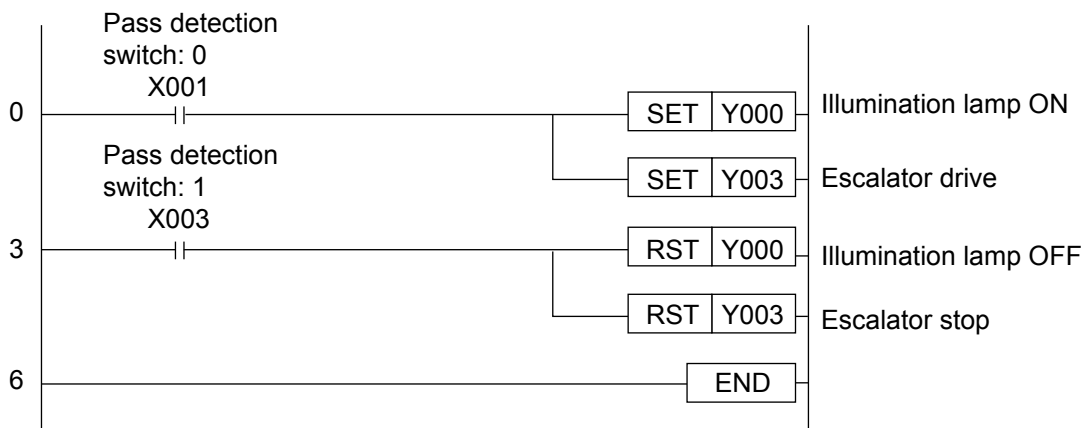

《Let's check operation》

Enter the above program on the PLC, and check program operation.

When input X001 is turned ON, outputs Y000 and Y003 operate. Next, when input X003 is turned ON, outputs Y000 and Y003 become non-operational.

Refer to the appendix 2 for a list program.

5.2 Introductory Example 2 (Control of Tea Dispenser)

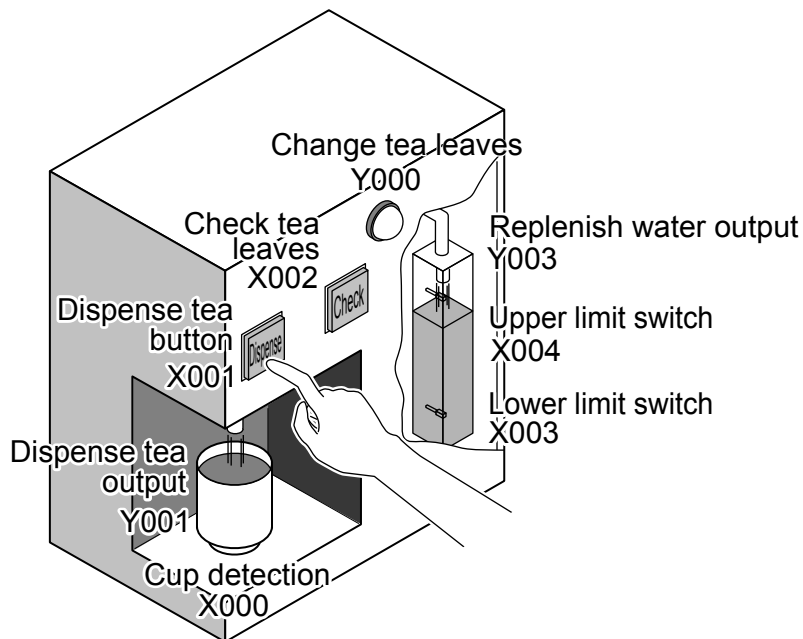

Let's consider a PLC program for a tea dispenser

《I/O assignments》

Input	Cup detection	X000 (ON when cup is present)
	Dispense tea button	X001
	Check tea leaves button	X002
	Replenish water tank lower limit switch	X003
	Replenish water tank upper limit switch	X004
output	Change tea leaves indicator lamp	Y000
	Dispense tea output	Y001
	Replenish water output	Y003

《Explanation of operation》

- (1) When cup detection X000 is ON, and dispense tea button X001 is pressed (X001 turns ON), dispense tea output Y001 operates, and hot water is poured into the cup. Hot water is poured only for the duration that the button is pressed, and stops being poured when you release your hand from the button.
When cup detection X000 is OFF, hot water is not poured even by pressing dispense tea button X001.
- (2) When water in the replenish water tank gets low, lower limit switch X003 turns ON and replenish water output Y003 operates.
When replenish water output Y003 operates and water is poured into the tank, upper limit switch X004 finally turns ON, and replenish water output Y003 becomes non-operational.
- (3) When water is replenished five times, the change tea leaves indicator lamp lights.
- (4) When the check button is pressed, the change tea leaves indicator lamp goes out.

The program is configured as follows

《Circuit program》

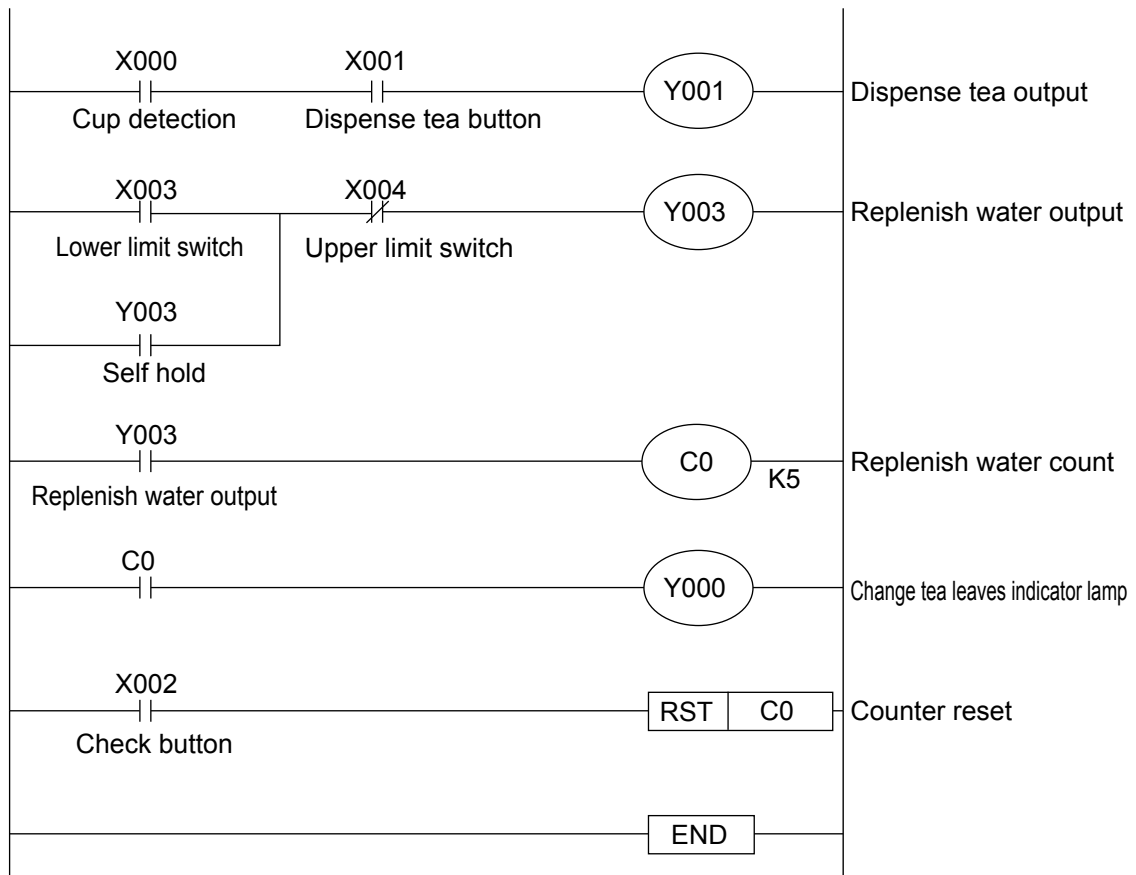

《Let's check operation》

Enter the above program on the PLC, and check program operation.

- (1) Output Y001 operates when both inputs X000 or X001 turns ON.
- (2) When input X003 turns ON, output Y003 operates, and when input X004 turns ON, output Y003 becomes non-operational.
- (3) Each time that output Y003 operates, the value of counter C0 is incremented by one. When C0 reaches "5", Y000 operates.
- (4) When input X002 turns ON, the value of counter C0 returns to "0" and output Y000 becomes non-operational.

Refer to Appendix 2 for the list program.

5.3 Introductory Example 3 (Control of Fan)

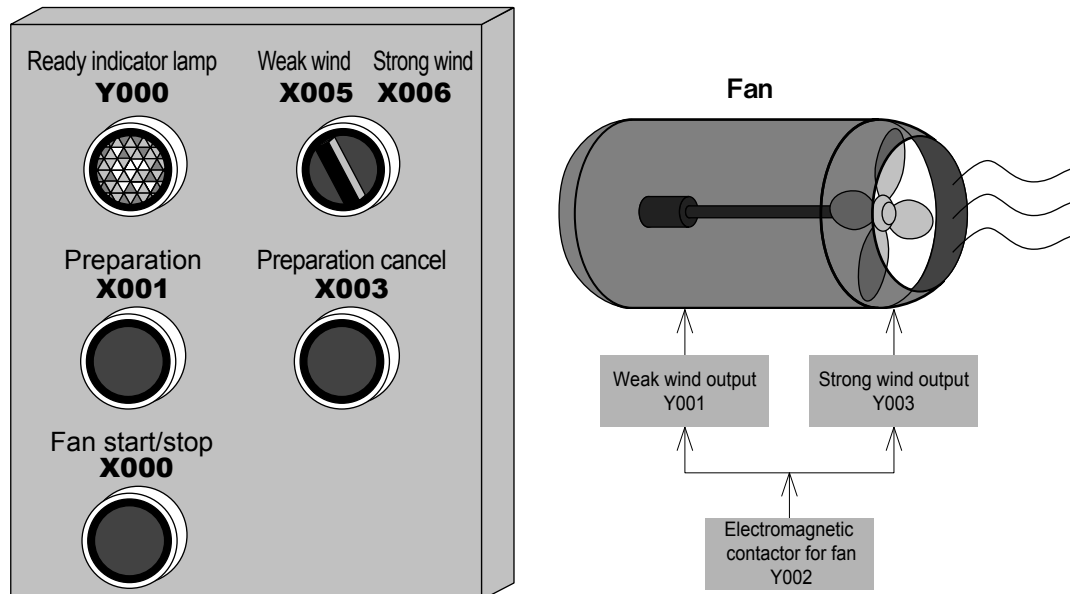

Let's consider a PLC program for a Fan.

《I/O assignments》

Input	
X000	[Fan start/stop] switch
X001	[Preparation] switch
X003	[Preparation cancel] switch
X005	[Weak wind] selection
X006	[Strong wind] selection

Output	
Y000	[Ready indicator lamp]
Y001	Weak wind output
Y002	Electromagnetic contactor for fan
Y003	Strong wind output

《Operation》

- (1) When the [Preparation] switch (X001) is turned ON, the [Ready indicator lamp] (Y000) turns ON and latched. When the [Preparation cancel] switch (X003) is turned ON, the [Ready indicator lamp] (Y000) turns OFF and unlatched.
- (2) When the [Fan start/stop] switch is pressed while the [Ready] indicator lamp (Y000) is ON, the electromagnetic contactor for the fan (Y002) is actuated and the fan starts or stops. The wind velocity of the fan can be selected by the selector switch (X005/X006).
 - When X005 is ON: The weak wind output (Y001) is ON.
 - When X006 is ON: The strong wind output (Y003) is ON.

《Circuit program》

Input required devices in blank areas, and complete the program.

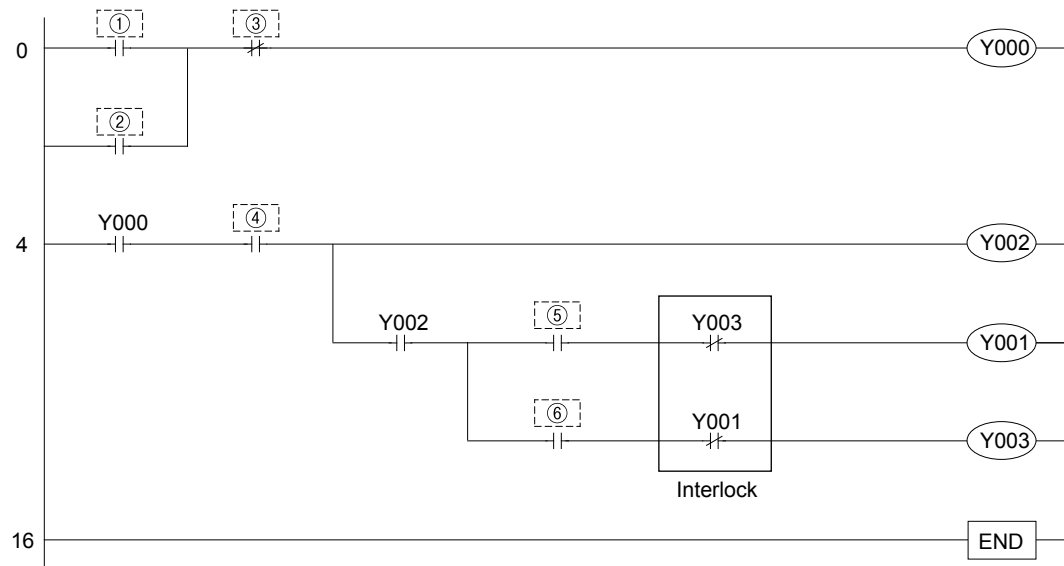

- Refer to the last page of this chapter for the solution.
- Refer to the appendix for the list program.

5.4 Introductory Example 4 (Control of Press Machine)

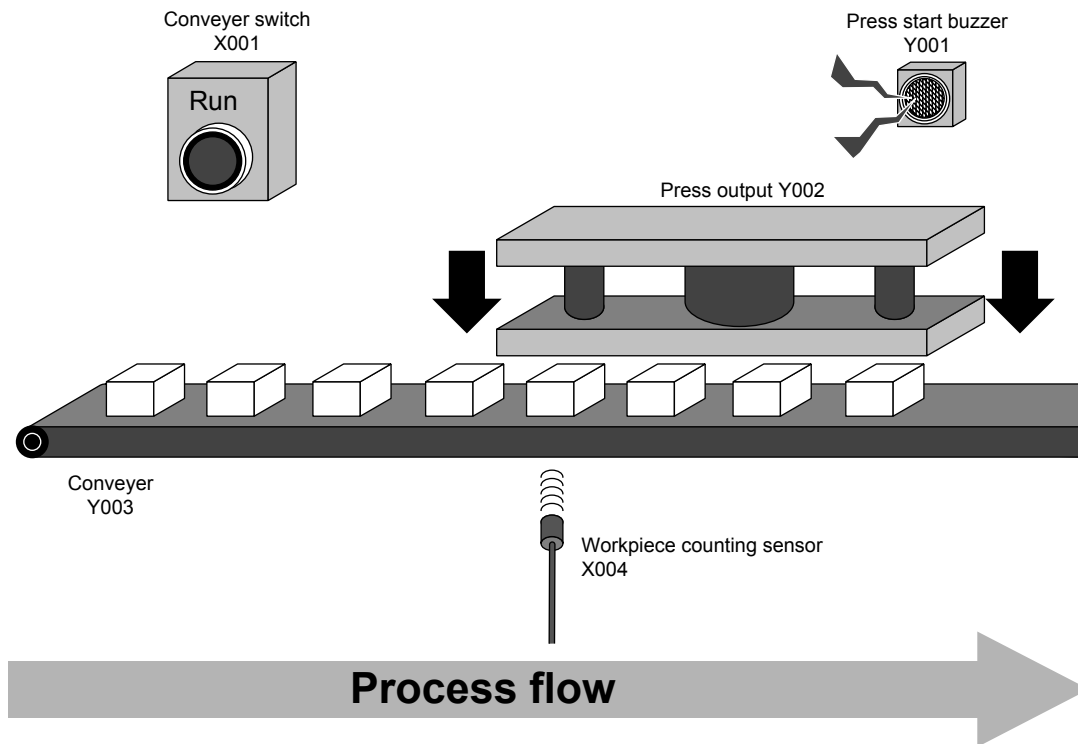

Let's consider a PLC program for a press machine.

《I/O assignments》

Input	
X001	Conveyer switch
X004	Workpiece counting sensor

Output	
Y001	Press start buzzer
Y002	Press output
Y003	Conveyer

《Operation》

- (1) When the conveyer switch [Start] (X001) is turned ON, the conveyer (Y003) turns ON and carries workpieces to the pressing position.
When 4 workpieces are detected by the workpiece counting sensor (X004), the workpiece carrying conveyer (Y003) turns OFF and stops carrying workpieces.
- (2) When the conveyer (Y003) stops, the press start buzzer (Y001) sounds.
After 1 second, the press machine will perform pressing (Y002).
- (3) The press machine completes press (Y002) in 2 seconds, the start buzzer (Y001) sounds, and the press machine stops pressing at the same time.
- (4) After pressing is completed, the press workpiece count is reset, and operation is repeated from step (1).

《Circuit program》

Input required devices in blank areas, and complete the program.

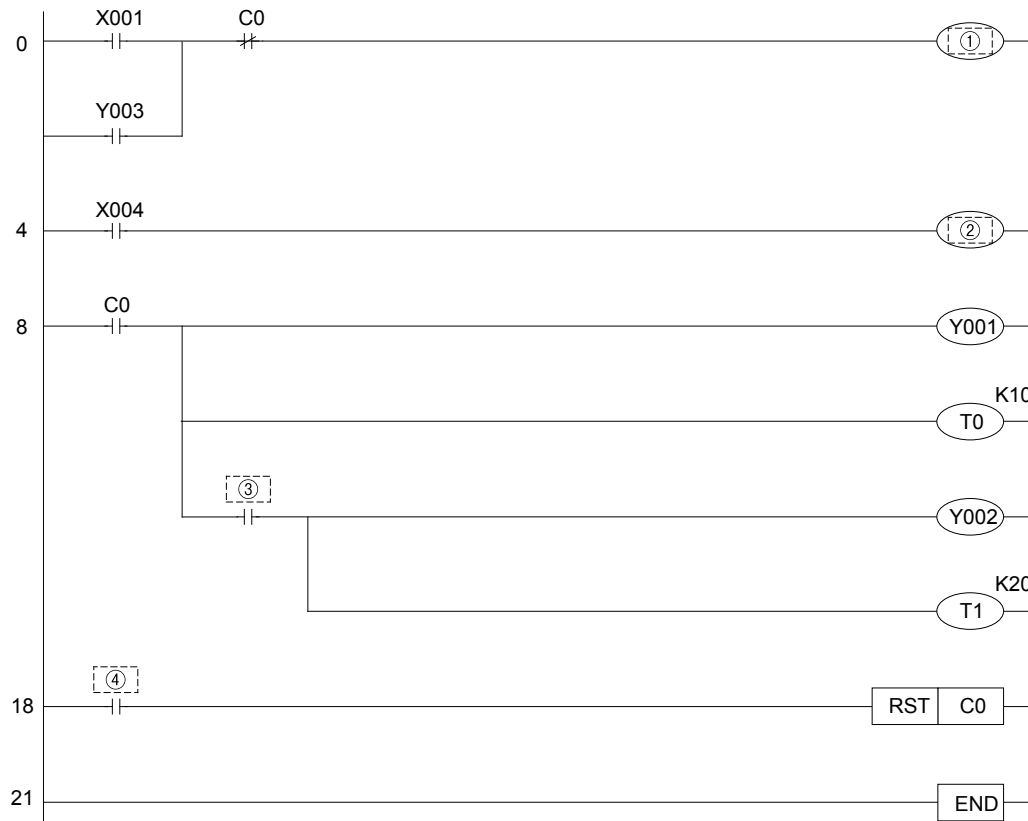

- Refer to the last page of this chapter for the solution.
- Refer to the appendix for the list program.

5.5 Introductory Example 5 (Timing Chart)

Let's consider a PLC program for the timing chart below.

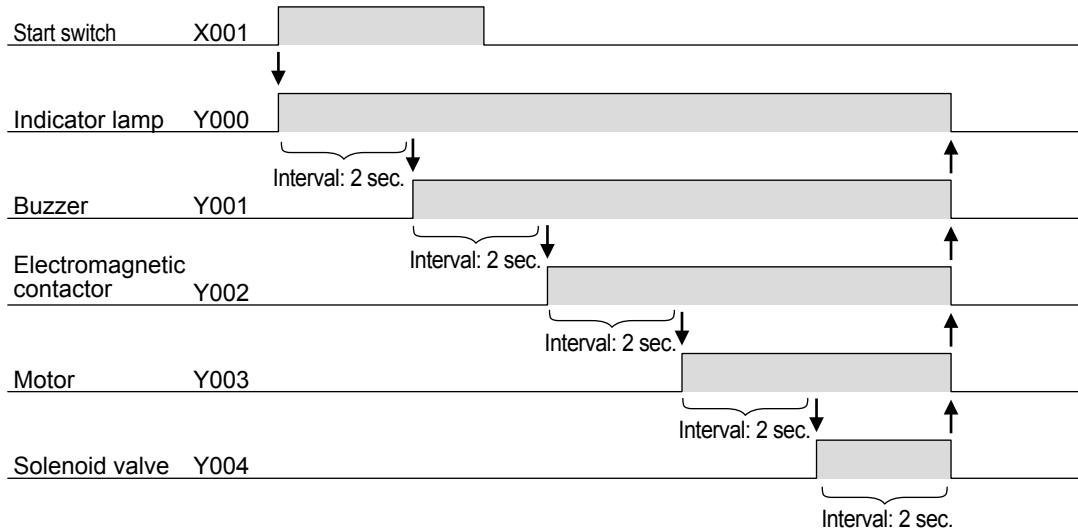

《 I/O assignments 》

Input	
X001	Start switch

Output	
Y000	Indicator lamp
Y001	Buzzer
Y002	Electromagnetic contactor
Y003	Motor
Y004	Solenoid valve

《 Operation 》

When the start switch (X001) is turned ON, the indicator lamp (Y000) turns ON and the timer (T0) starts measuring the time at the same time.

On condition that the timer (T0) reaches the set value 2 seconds later, the buzzer (Y001) turns ON and the timer (T1) starts measuring the time at the same time.

After that, the electromagnetic contactor (Y002), motor (Y003) and solenoid valve (Y004) turn ON at intervals of 2 seconds in the same way. After the last solenoid valve (Y004) remains ON for 2 seconds, all outputs turn OFF.

《Circuit program》

Input required devices in blank areas, and complete the program.

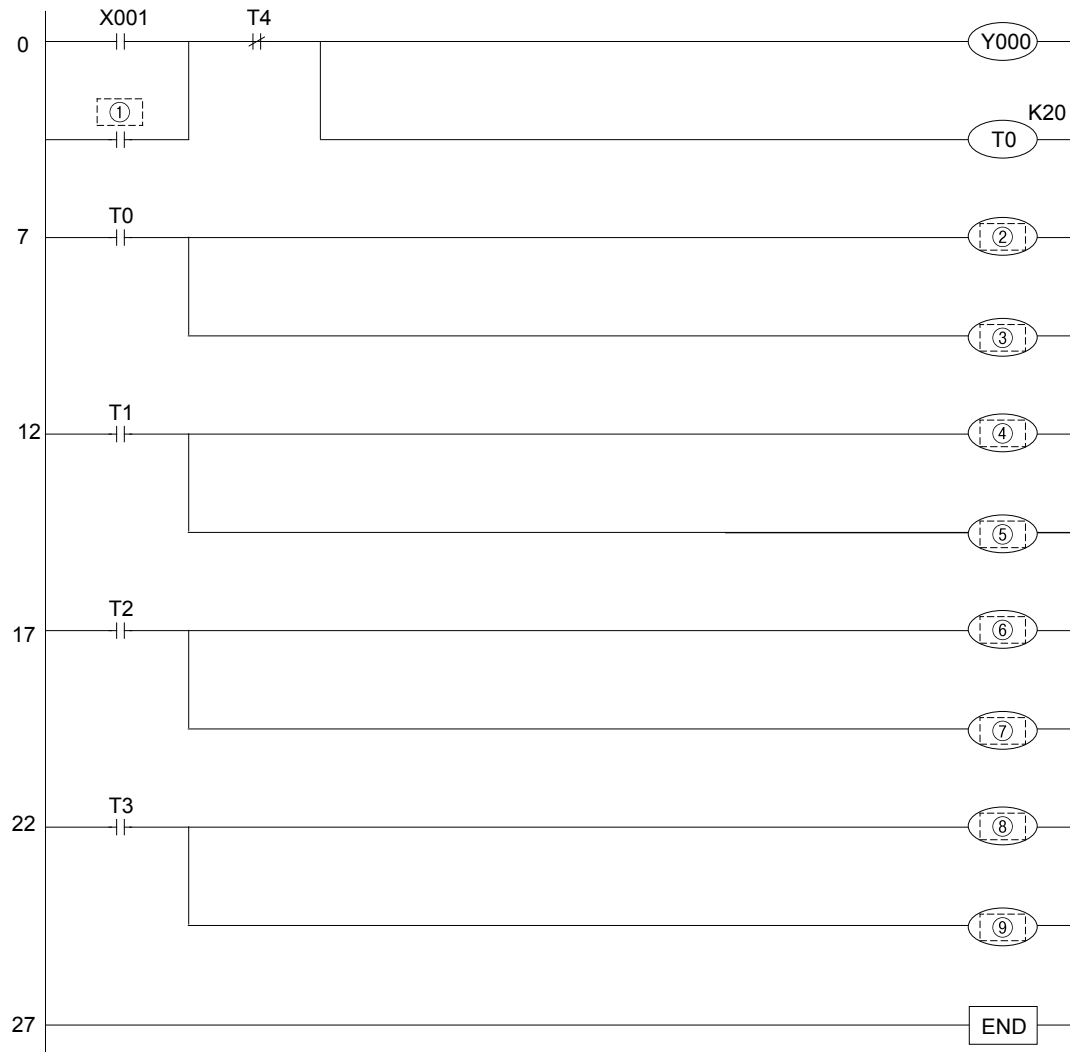

- Refer to the last page of this chapter for the solution.
- Refer to the appendix for the list program.

5.6 Introduction example answers

Introductory Example 3	
①	X001
②	Y000
③	X003
④	X000
⑤	X005
⑥	X006

Introductory Example 4	
①	Y003
②	C0 K4
③	T0
④	T1

Introductory Example 5	
①	Y000
②	Y001
③	T1 K20
④	Y002
⑤	T2 K20
⑥	Y003
⑦	T3 K20
⑧	Y004
⑨	T4 K20

Appendix 1

THE OPERATION OF THE GX Developer

Using a personal computer, sequence becomes easier...

If a personal computer software GX Developer is used to create and edit the sequence program, it becomes easier just like illustration making.

If the basic operations are mastered, it is just the repetition of them.

There are many functions easy to use in the software. Let's master them sequentially starting from the necessary operations.

Smoothly starting up and adjusting...

The program is accompanied by the debug.

The operation status of the PLC and program can be monitored on the personal computer screen, so if some parts are not working as planned, confirmation and adjustment can be conducted at once.

Make the program easy to read...

There is a "comment input function" in GX Developer to make the sequence program easy to read.

It can improve the efficiency to create and debug the program if a comment is input.

Appendix 1.1 Basic knowledge for operating GX Developer

Appendix 1.1.1 Construction of the GX Developer's screen

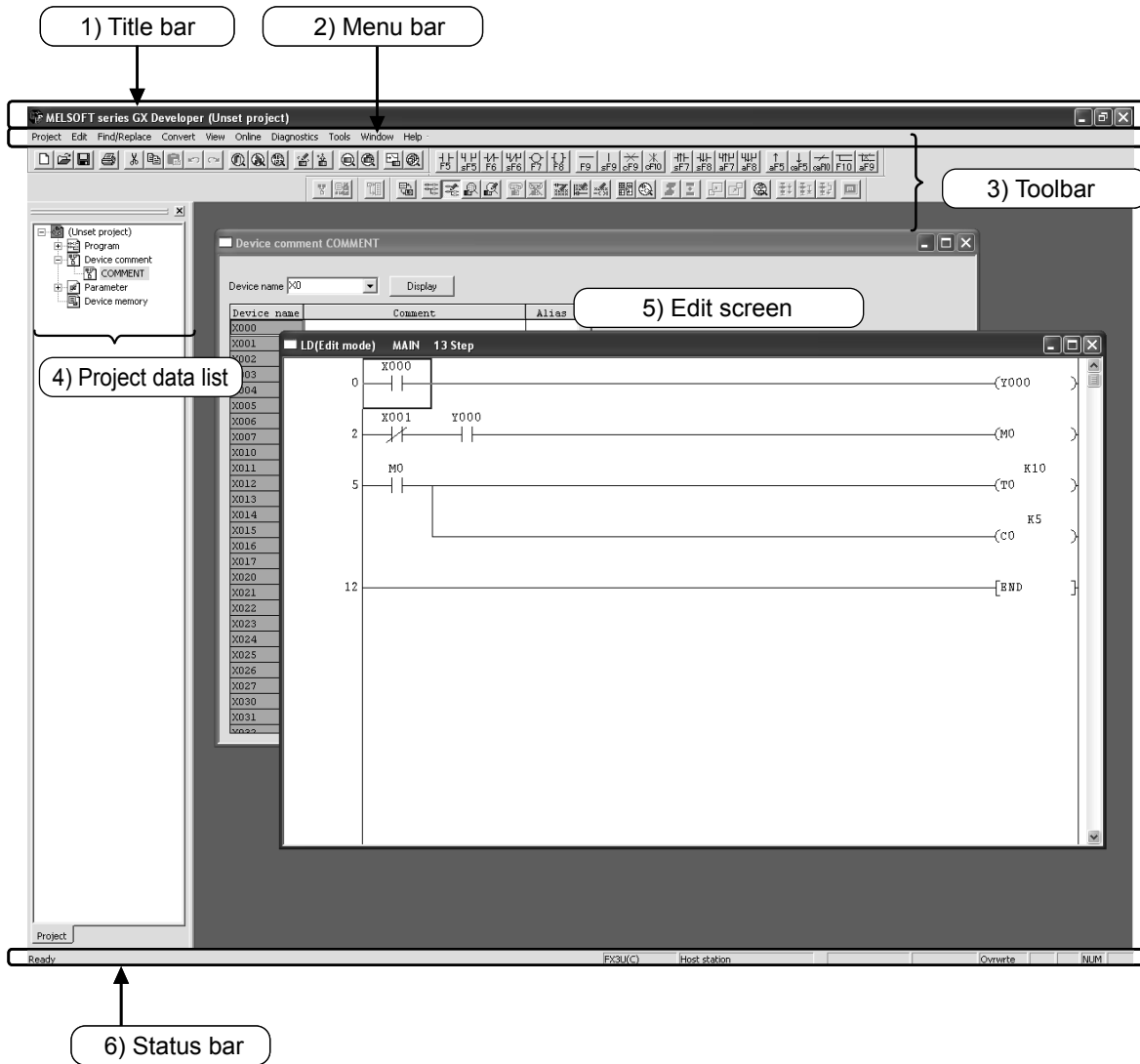

1) Title bar

The name of the opened project and the operation icon of windows are displayed.

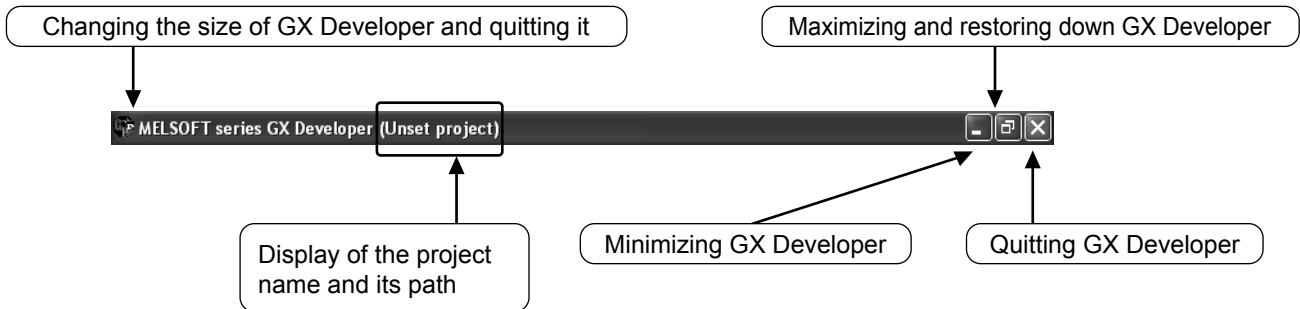

2) Menu bar

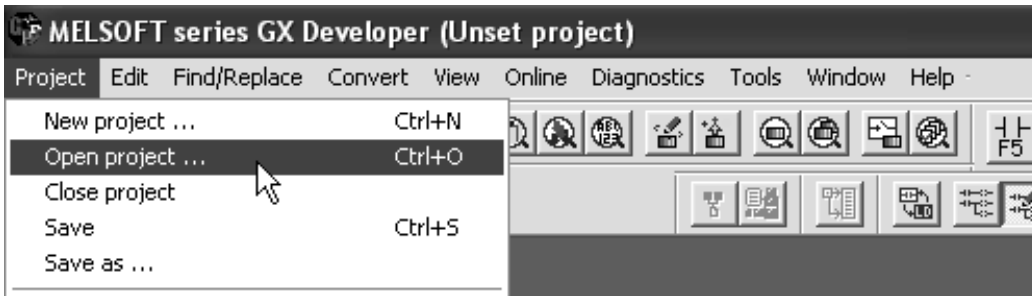

Drop down menu will be displayed after menu is selected.

3) Toolbar

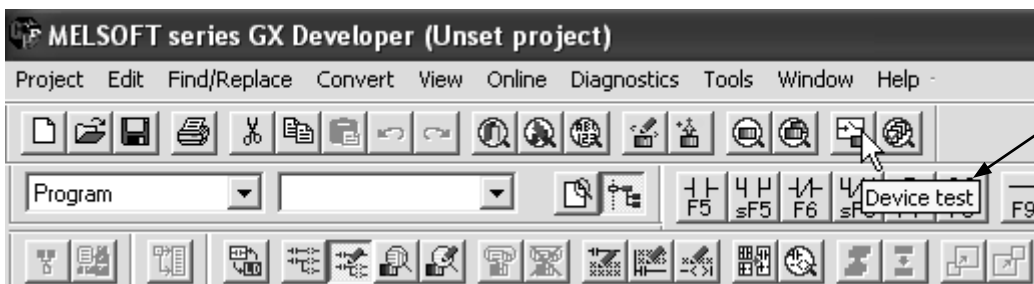

The description of the function will be displayed when the mouse cursor stops at the buttons.

* : The contents of the toolbar can be moved, added and removed, therefore the displayed items and the layouts depend on the various environments.

The frequently used functions are configured by icon buttons. Compared to selecting from the menu, the desired function can be directly executed.

4) Project data list

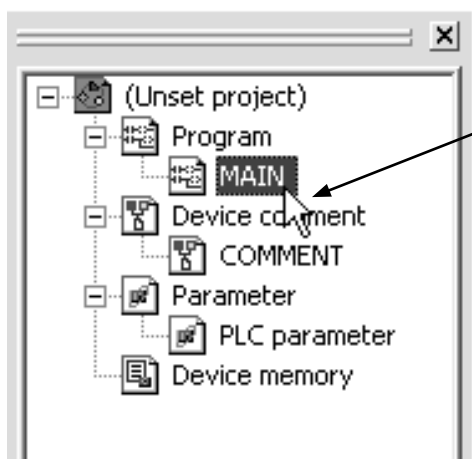

Directly specify the items displayed by mouse clicking.

Ladder creating window, parameter setting screen and so on are displayed by tree structure.

5) Edit screen

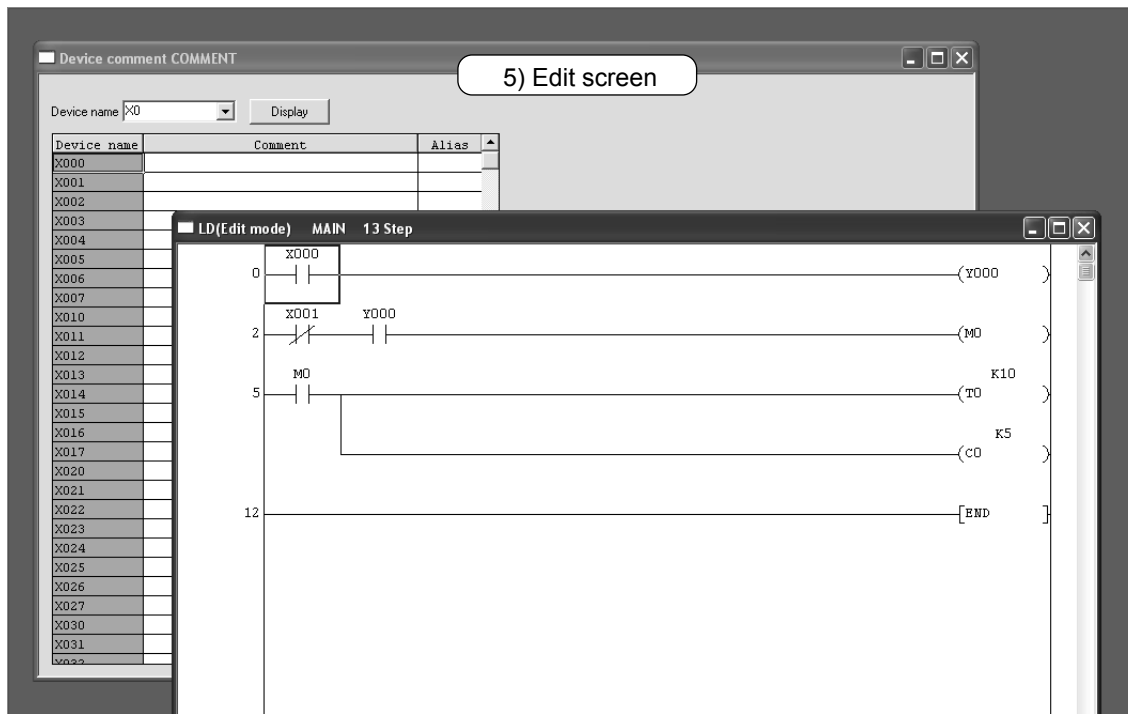

Ladder creating screen, monitor screen and so on are multiply displayed by windows.

6) Status bar

The status of the operation and setting is displayed.

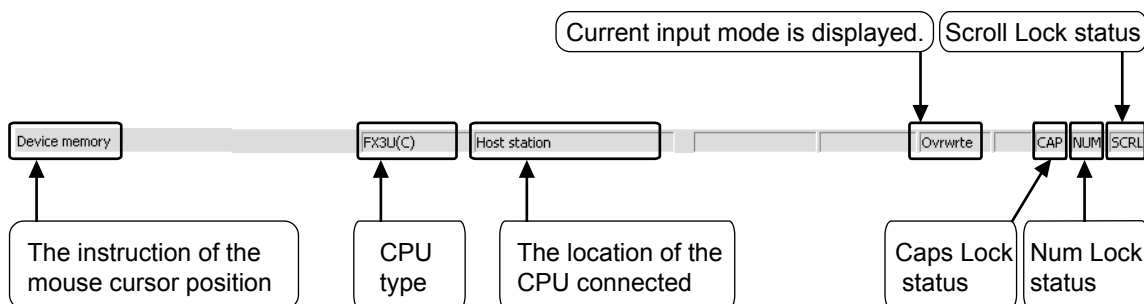

Appendix 1.1.2 About the "Project"

"Project" consists of Program, Comment, Parameter and Device Memory.
An aggregate of a series of data in GX Developer is called "Project", and stored as a folder of Windows®.

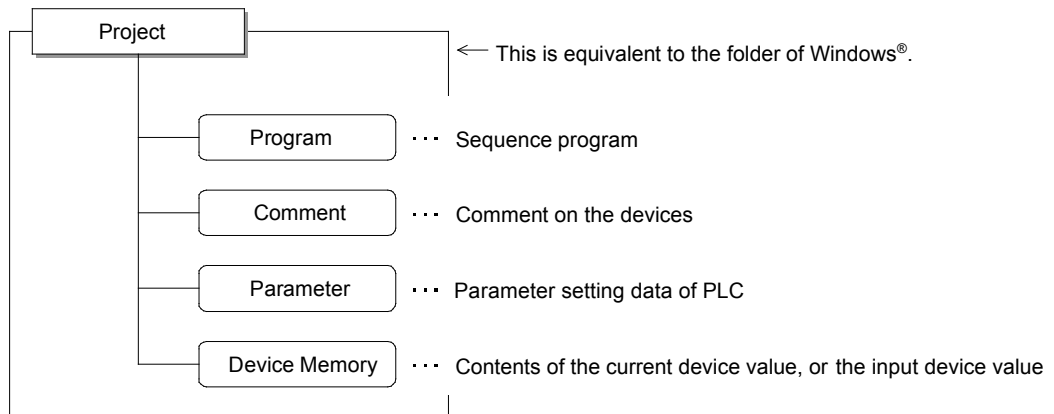

- Editing multiple projects

Start multiple GX Developer when more than one projects are to be edited.

Appendix 1.2 Starting GX Developer and creating a new project

Appendix 1.2.1 Starting GX Developer

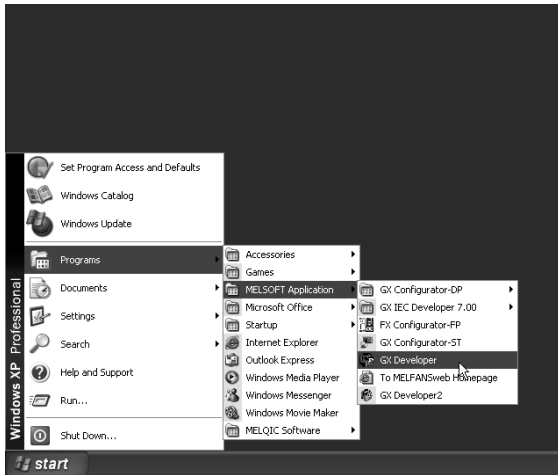

- 1) Start from the **Start** button of Windows®, and select in the following order.

[Programs]



[MELSOFT Application]



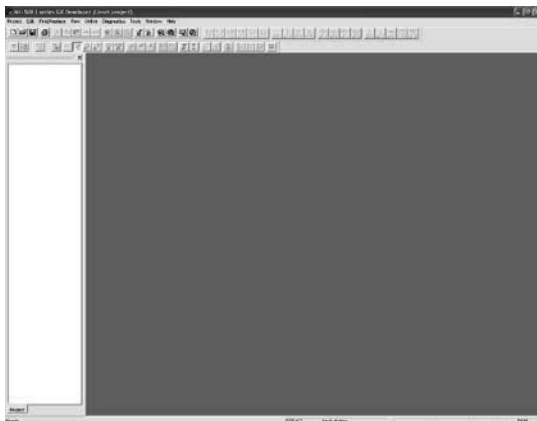
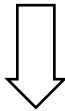

[GX Developer]

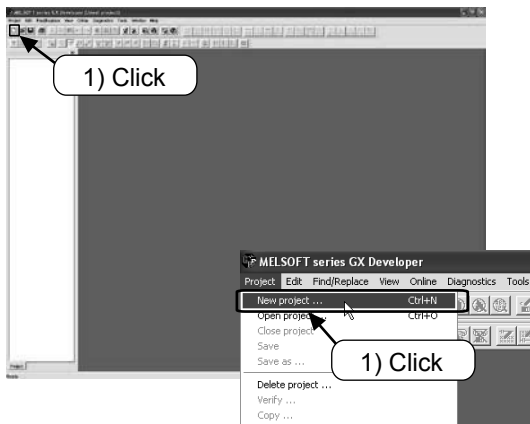

- 2) GX Developer is started.

Appendix 1.2.2 Creating a new project



- 1) Select  from the toolbar, or select [Project] → [New project] (**Ctrl** + **N**) from the menu.

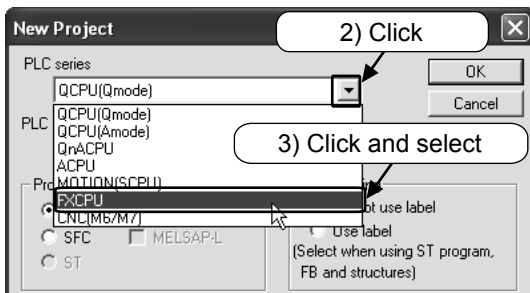
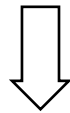

- 2) Click the [▼] button of [PLC series].
- 3) Select "FXCPU".

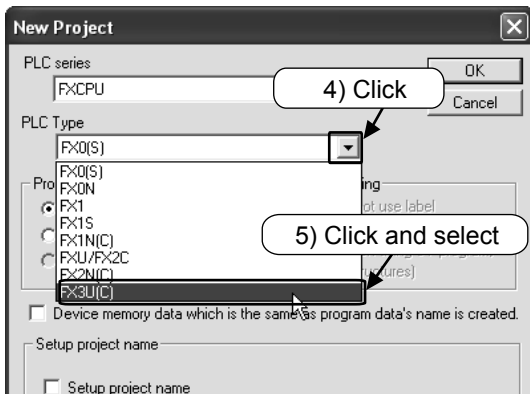
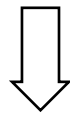

- 4) Click the [▼] button of [PLC type].
 - 5) Select "FX3U(C)".
- Note: Select the series name that is actually used.

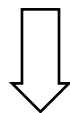

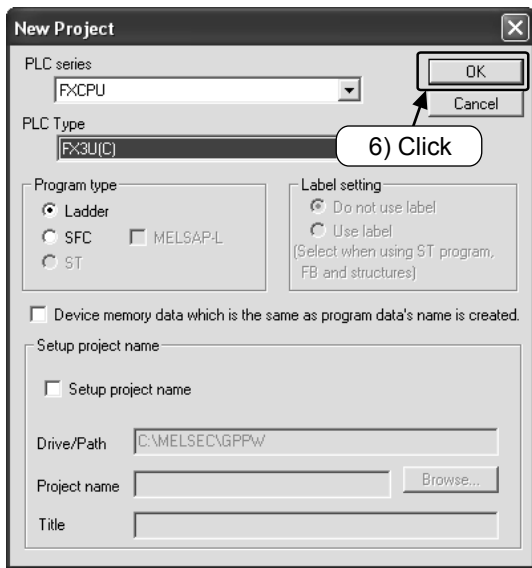

6) Click .

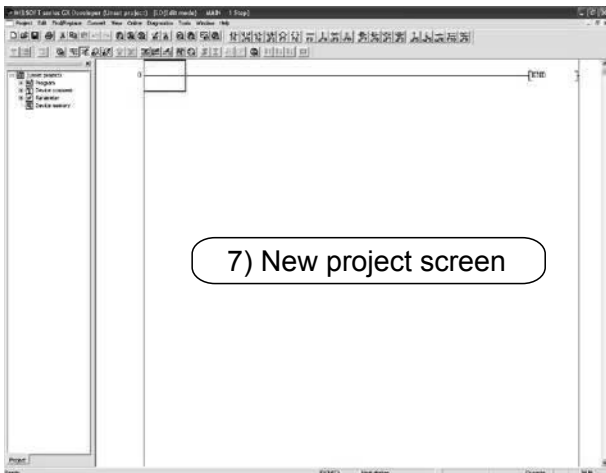
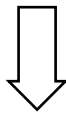

7) New project screen is displayed and the project can be input.

Appendix 1.3 Creating a program

Appendix 1.3.1 Creating a program by using the function keys

[Program to be created]

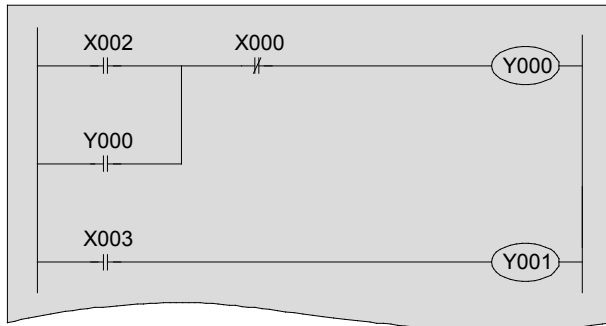

Point

In this book, the number of the input relay and output relay is displayed as "X000", "Y000" by three digits. "X0", "Y1" and the "0" on the left front can be omitted when the input is performed from GX Developer.

Point

- The keyboard shortcuts for ladder elements are displayed on the buttons of the toolbar.

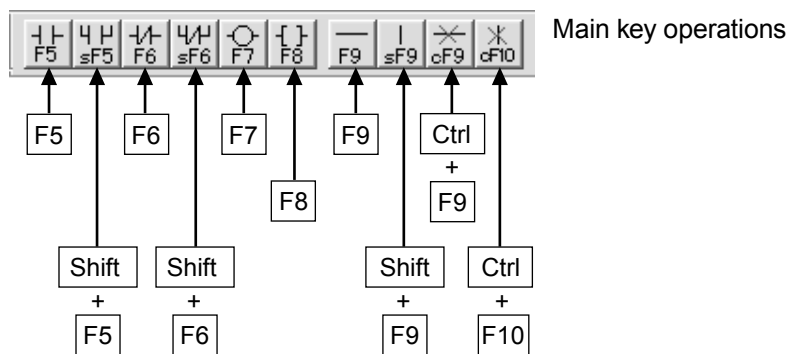

- When creating a program, make sure to set to "Write Mode".

Select from the toolbar.



Select from the menu ([Edit] → [Write mode]).

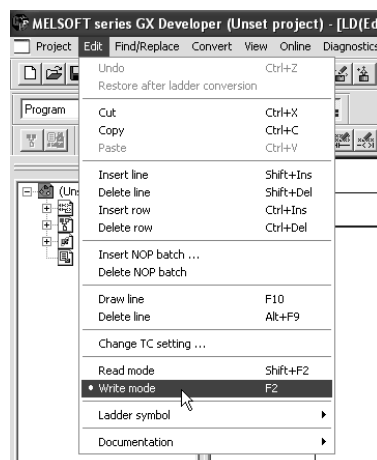

- Use half-width characters when inputting. Full-width characters are not allowed.

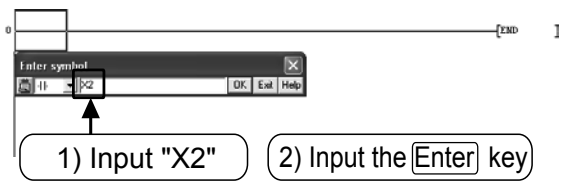

- 1) Press the **F5** (\rightarrow) key.
Input "X2".



Cancel it by **ESC** or **[Exit]**.

- 2) Confirm by pressing the **Enter** key or **[OK]**.

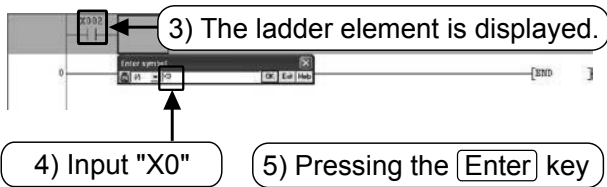

- 3) The ladder input (\rightarrow) is displayed.
- 4) Press the **F6** (\rightarrow) key.
Input "X0".
- 5) Confirm by pressing the **Enter** key or **[OK]**.

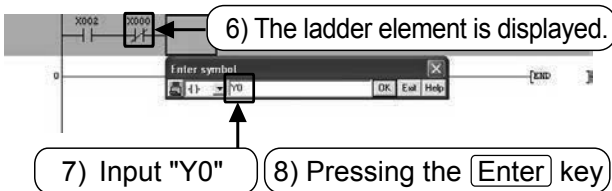

- 6) The ladder input (\rightarrow) is displayed.
- 7) Press the **F7** (\rightarrow) key.
Input "Y0".
- 8) Confirm by pressing the **Enter** key or **[OK]**.

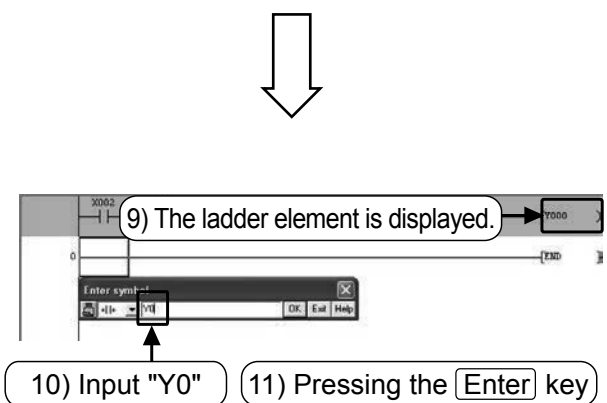

- 9) The ladder input (\rightarrow) is displayed.
- 10) Press the **Shift** + **F5** (\rightarrow) key.
Input "Y0".
- 11) Confirm by pressing the **Enter** key or **[OK]**.

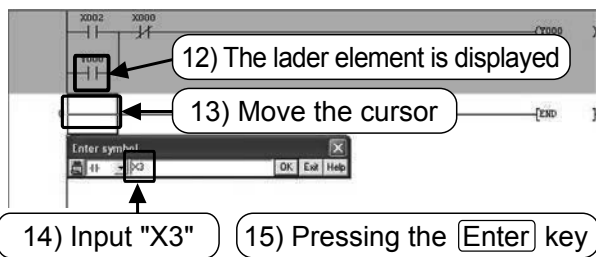

14) Input "X3"

15) Pressing the **Enter** key

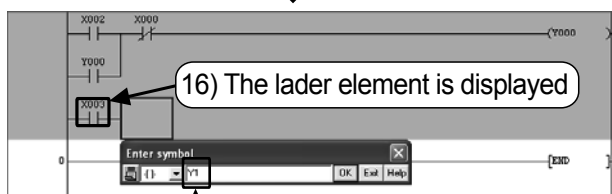
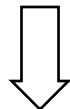

17) Input "Y1"

18) Pressing the **Enter** key

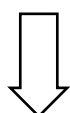
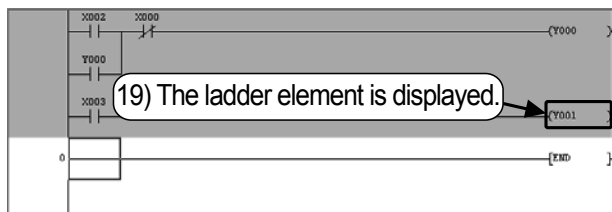
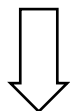

F4 (Convert)

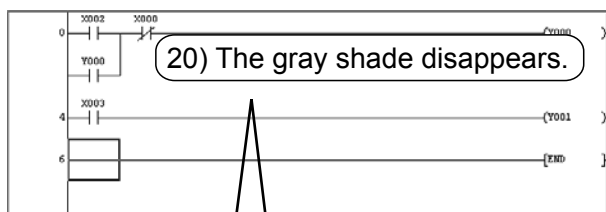

The gray shade disappears and the program is confirmed.
If an error occurs, the cursor moves to the problematic part of the program. Correct the program.

- 12) The ladder input ($\text{---} \text{Y0}$) is displayed.
- 13) Move the cursor to the beginning of the next line.
- 14) Press the **F5** ($\text{---} \text{Y0}$) key.
Input "X3".
- 15) Confirm by pressing the **Enter** key or [OK].

- 16) The ladder input ($\text{---} \text{X3}$) is displayed.
- 17) Press the **F7** ($\text{---} \text{Y1}$) key.
Input "Y1".
- 18) Confirm by pressing the **Enter** key or [OK].

- 19) The ladder input ($\text{---} \text{Y1}$) is displayed.

20) Convet Operation [Important]

Perform the "Conversion" operation to finalize ladder that not been compiled (the gray part).

Press the **F4** (Convert) key.

Or select  from the toolbar, or select [Convert] → [Convert] from the menu.

Appendix 1.3.2 Creating a program by using the toolbar buttons

[Program to be created]

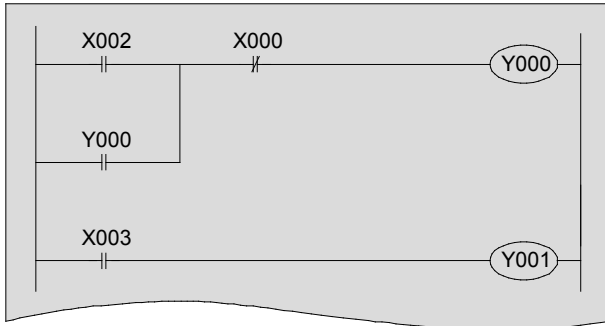

Point

In this book, the number of the input relay and output relay is displayed as "X000", "Y000" by three digits. "X0", "Y1" and the "0" in the left front can be omitted when the input is performed from GX Developer.

Point

- Click the toolbar buttons to input ladder elements.



Main toolbar buttons

- When creating a program, make sure to set to "Write Mode".

Select from the toolbar.



Select from the menu ([Edit] → [Write mode]).

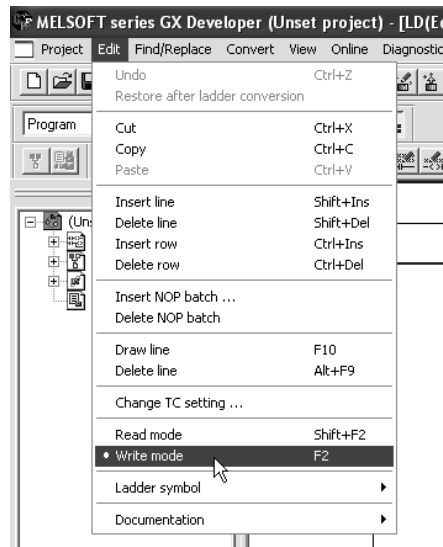

- Use half-width characters when inputting. Full-width characters are not allowed.

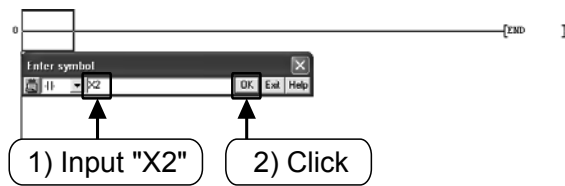



- 1) Click the tool button . Input "X2".



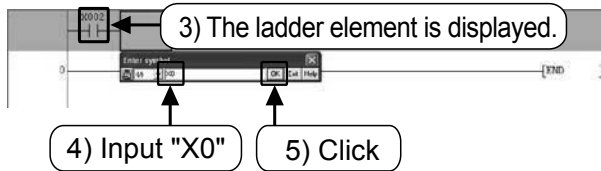
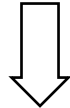

Cancel it by **[ESC]** or **[Exit]**.

- 2) Confirm by pressing the **[Enter]** key or **[OK]**.



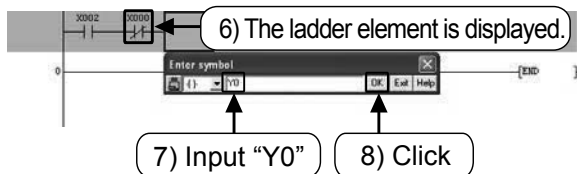
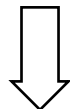

- 3) The ladder input () is displayed.
- 4) Press the tool button . Input "X0".
- 5) Confirm by pressing the **[Enter]** key or **[OK]**.

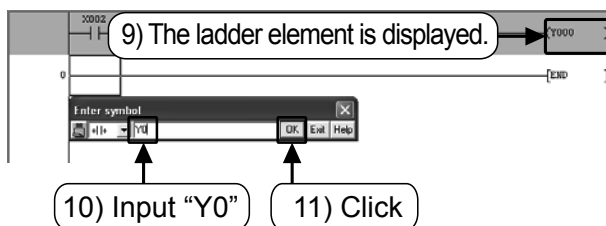
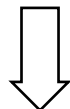

- 6) The ladder input () is displayed.
- 7) Click the tool button . Input "Y0".
- 8) Confirm by pressing the **[Enter]** key or **[OK]**.



- 9) The ladder input () is displayed.
- 10) Click the tool button . Input "Y0".
- 11) Confirm by pressing the **[Enter]** key or **[OK]**.

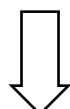

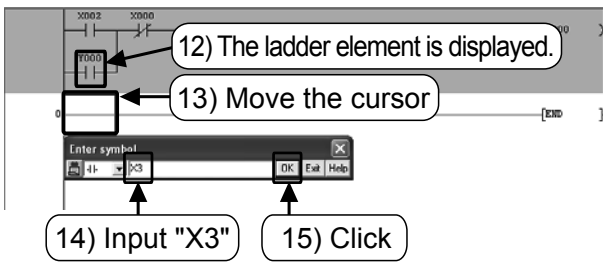

- 12) The ladder input (---|) is displayed.
- 13) Move the cursor to the beginning of the next line.
- 14) Click the tool button ---| F5 .
- 15) Confirm by pressing the key or [OK].

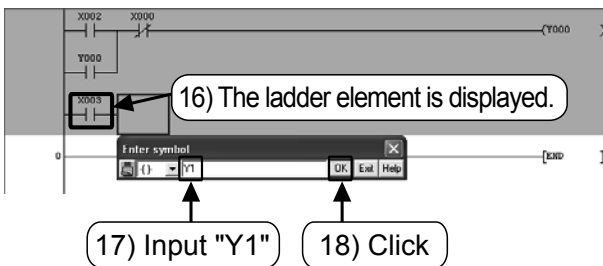
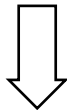

- 16) The ladder input (---|) is displayed.
- 17) Click the tool button ---| F7 .
- 18) Confirm by pressing the key or [OK].

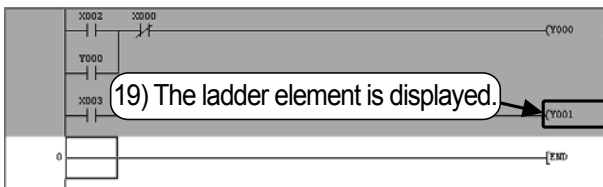
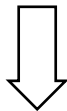

- 19) The ladder input (---|) is displayed.

(Convert)

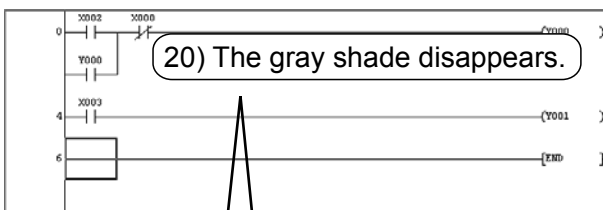

The gray shade disappears and the program is compiled.
If an error occurs, the cursor moves to the problematic part of the program. Correct the program.

Convert Operation [Important]

Perform the "Conversion" operation to finalize ladder that not been compiled (the gray part).

Press the (Convert) key.

Or select  from the toolbar, or select [Convert] → [Convert] from the menu.

Appendix 1.4 Writing programs to PLC

Write the created sequence program to FX PLC.

Appendix 1.4.1 Connecting PC to PLC

Connecting the personal computer to an FX3G PLC (with a USB cable)

[Preparation on the personal computer side]

For connecting the personal computer to an FX3G PLC with a USB cable, it is necessary to install the USB driver software in the personal computer.

Install the USB driver software in accordance with the procedure described in the “GX Developer Operating Manual (Startup)”.

[Connection diagram]

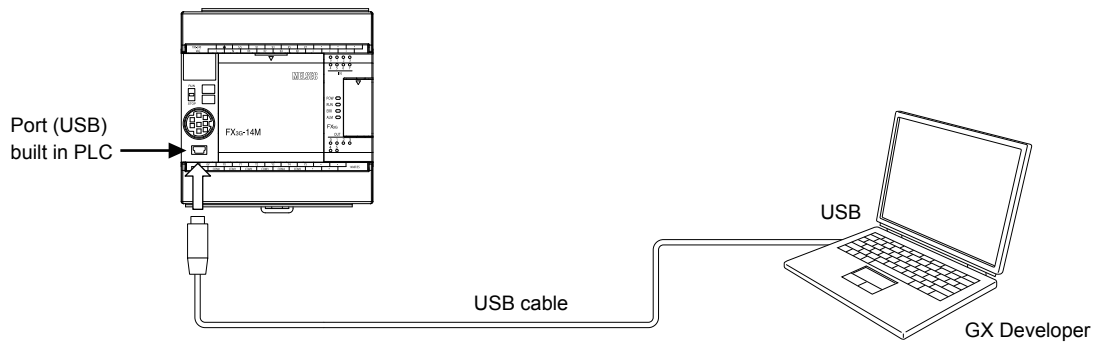

Appendix 1.4.2 "Transfer Setup" in GX Developer

Configure the settings of GX Developer to communicate with PLC.

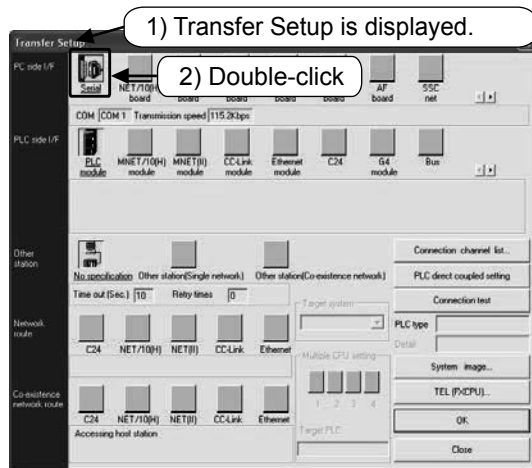

- 1) Select [Online] → [Transfer Setup].
- 2) Double-click the icon .

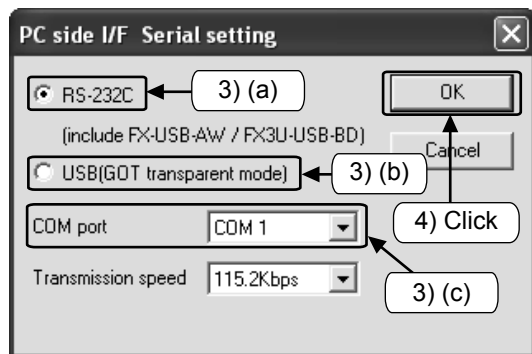
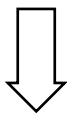

- 3) Set the communication port of personal computer side.
Choose "USB(GOT transparent mode)" for connecting to the built-in USB port of the FX3G PLC.
- 4) Click [OK] after the setting is completed.

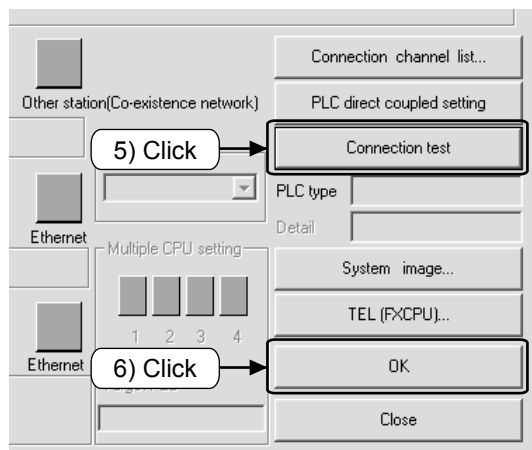
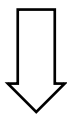

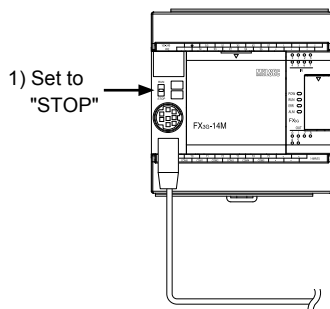

- 5) Click [Connection test], to check communication with PLC.
- 6) After checking, click [OK] to confirm the setting configured.

Appendix 1.4.3 Writing a program to the PLC

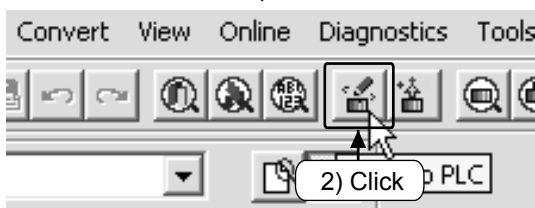

- 1) Set the "RUN/STOP" switch of PLC to "STOP".



- 2) Select  from the toolbar or select [Online] → [Write to PLC] from the menu.

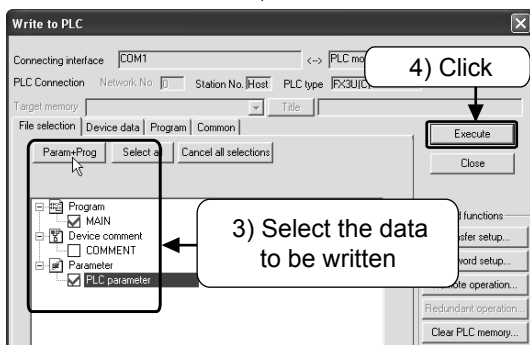

- 3) Click [Param + Prog].
- 4) Click [Execute].

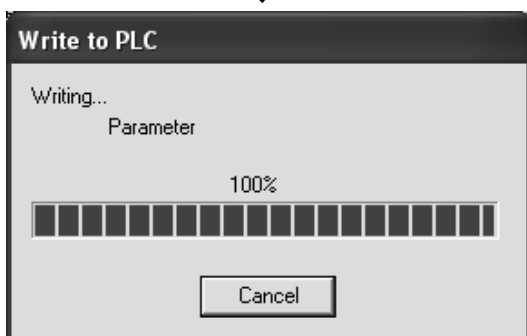

The dialog box of the progressing rate is displayed.



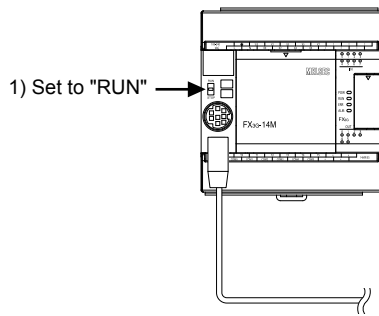

- 5) Click [OK] after it is completed.

Appendix 1.4.4 Monitoring PLC operation

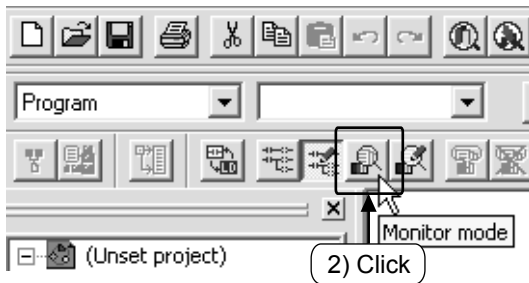

- 1) Set the "RUN / STOP" switch of PLC to "RUN".



- 2) Select  from the toolbar or select [Online] → [Monitor] → [Monitor mode] from the menu.



Check operation by monitor mode

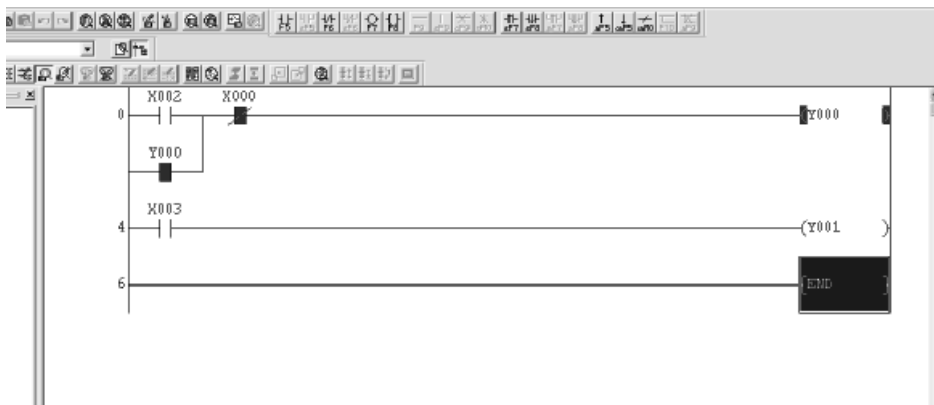

- 1) Set [Switch X002 is "ON"] and [Switch X000 is "OFF"], and then check [Output Y000 is "ON"].
- 2) Check [Output Y000 is "ON"] while [Switch X002 is "OFF"].
- 3) Set [Switch X000 is "ON"] and then check [Output Y000 is "OFF"].
- 4) Check [Output Y001 is "ON/OFF"] in accordance with [Switch X003 is "ON/OFF"].

Reference

(1) The display of the monitor status dialog

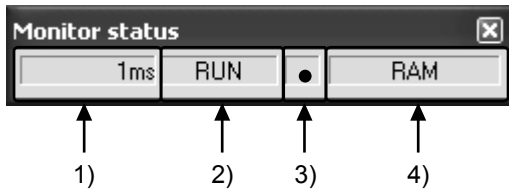

- 1) Scan time
The maximum scan time of the sequence program is displayed.
- 2) PLC status
The status of the PLC is displayed.
- 3) The execution status of the monitor
This icon flashing when the monitor is being executed.
- 4) Memory type
The memory type of the PLC is displayed.

(2) Interpretation of the ladder monitor display

1) Contact Instruction

Type \ Input contact	X0: OFF	X0: ON
NO contact	X000 ┆┆ Contact open	X000 ┆■ Contact close
NC contact	X000 ┆■ Contact close	X000 ┆┆ Contact open

2) Out Instruction

Type \ Driving status	Non-execution/ Non-drive	Execution/Drive
OUT instruction	-(Y000)-	-[Y000]
SET instruction, etc.	-[SET M0]-	-[SET M0]

The ON/OFF status of the device to be reset is displayed by the monitor using RST instruction.

Type \ Device status	When device to be reset is OFF	When device to be reset is ON
RST instruction	-[RST M0]-	-[RST M0]

Appendix 1.5 Editing a program

Appendix 1.5.1 Correcting a program

Point

- Make sure to set to "Write Mode" when amending the circuit.

Select from the toolbar.



Select from the menu ([Edit]→[Write mode]).

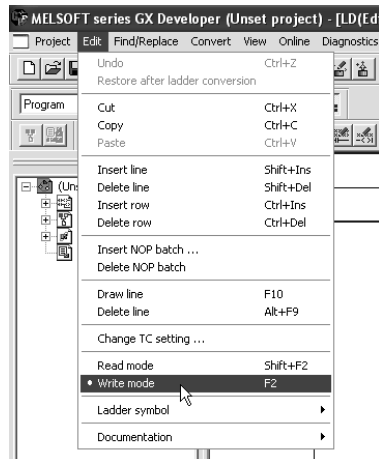

- Use half-width characters when inputting. Full-width characters are not allowed.

- Switch between "Ovrwrte" and "Insert"
 - Set to "Ovrwrte" when correcting and overwriting ladder.
 - New ladder will be inserted when the "Insert" mode is on.

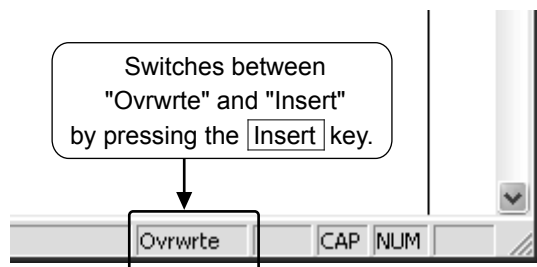

1) Changing the OUT coils and contacts

[Program to be corrected]

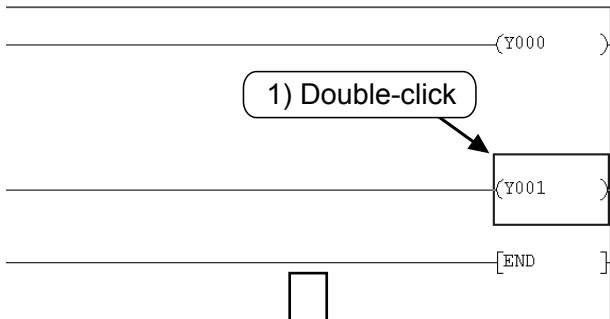
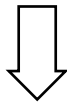
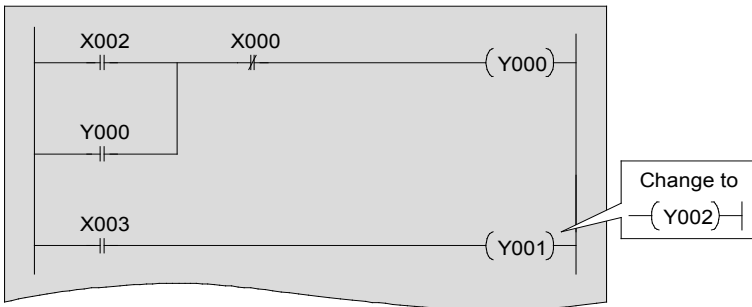

1) Double-click the part need to be corrected.

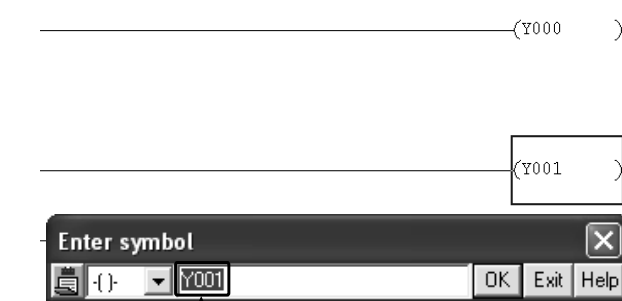
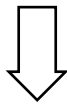

2) Change "Y001" to "Y002".

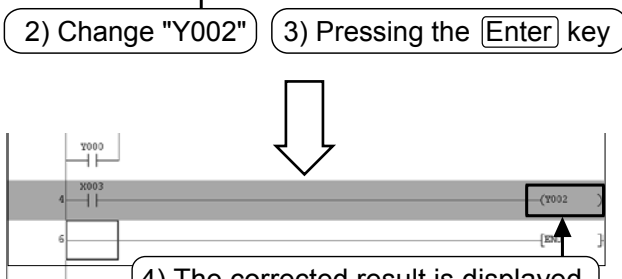

3) Confirm by pressing the [Enter] key or [OK].
4) The corrected result is displayed and the ladder block is displayed in gray.

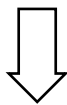

5) [F4] (Convert)

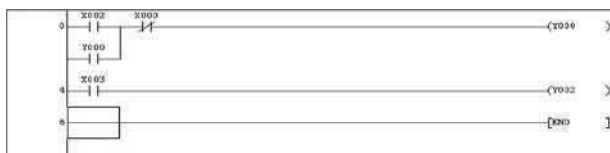

5) Confirm the changes by pressing the [F4] (Convert) key.

2) Adding lines

[Program to be corrected]

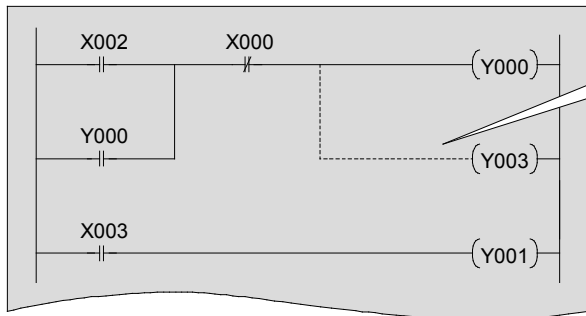

Add the vertical/
horizontal lines and
create the OUT coil.

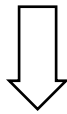

1) Click

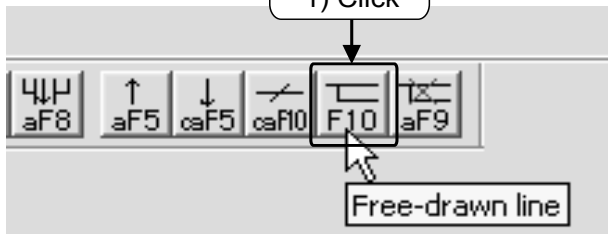

1) Click  (F10) on the toolbar.

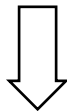

Locate the cursor on the upper right of the beginning of the vertical line to be added.

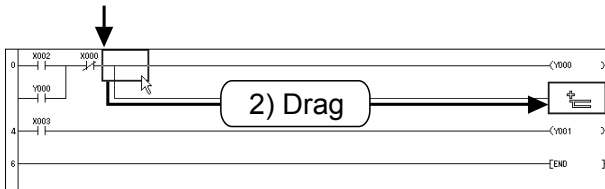

2) Locate the cursor on the upper right of the desired vertical line to be added, and then drag it until it reaches the desired position, and then drop it.

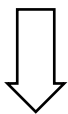

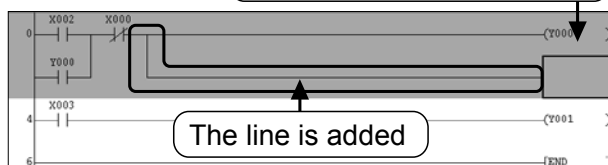

4) The position of the cursor

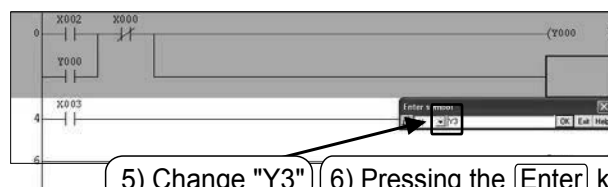
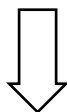

3) The line reaching the dropped position is added.
4) Locate the cursor on the position where the OUT coil is to be added to and click  on the toolbar.



5) Change "Y3" 6) Pressing the  key

5) Input "Y3".
6) Confirm by pressing the  key or [OK].

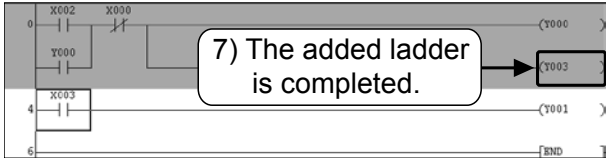
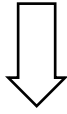

7) The added ladder is finished and the ladder block is displayed in gray.

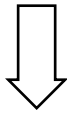

8) **F4** (Convert)

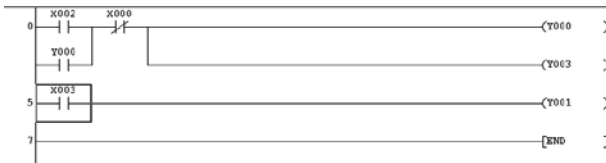





8) Confirm the changes by pressing the **F4** (Convert) key

- Click **F10** on the toolbar again to finish the operation.

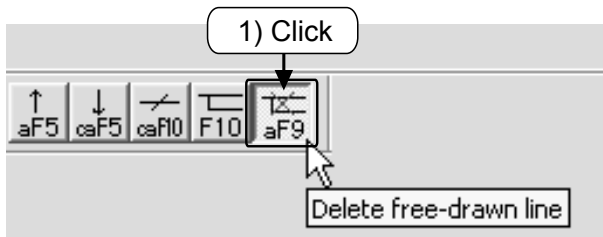
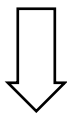
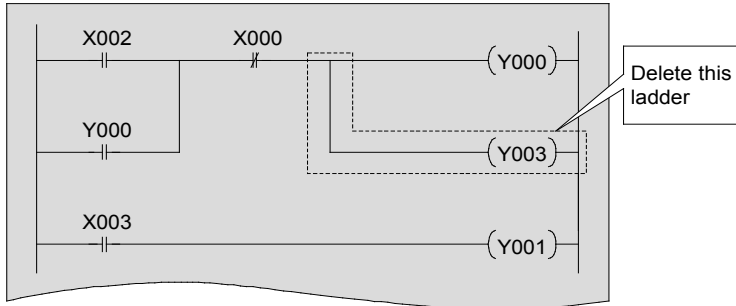
3) Deleting lines

[Program where lines are to be deleted]



1) Click   +  on the toolbar.

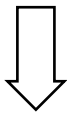

Locate the cursor on the upper right of vertical line to be deleted.

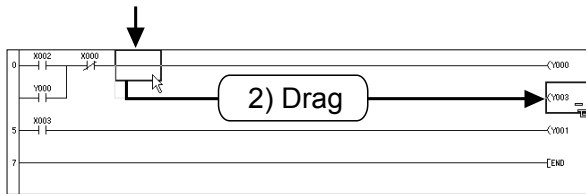

2) Locate the cursor on the upper right of the desired vertical line to be deleted, and then drag it until it reaches the desired position, and then drop it.

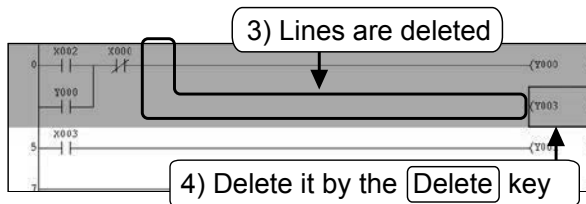
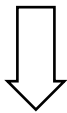

3) The lines are deleted.
4) Delete the OUT coil by the  key.

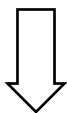

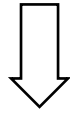
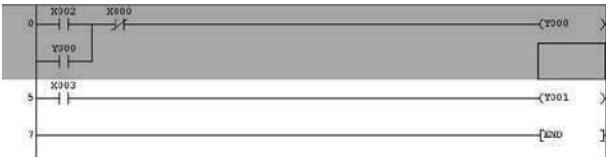

6) **F4** (Convert)



5) The deleted ladder block is displayed in gray.

6) Confirm the changes by pressing the **F4** (Convert) key.

- Click  on the toolbar again to finish the operation.

Appendix 1.5.2 Inserting and deleting rows

1) Adding rows

[Program where a rung is to be inserted]

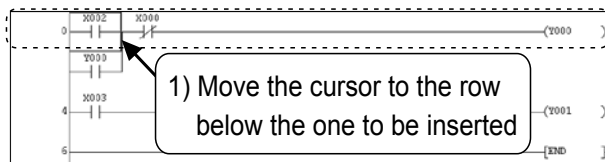
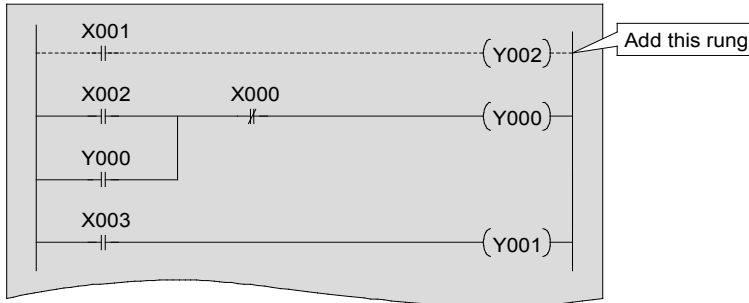

A row is inserted above the row where the cursor is located

- 1) Locate the cursor on the row below the one to be inserted.

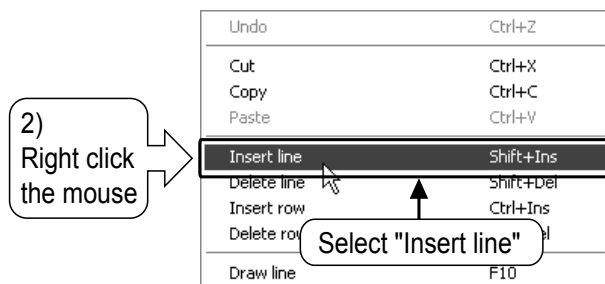
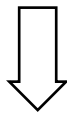

- 2) Right click the mouse at any place, and select [Insert line].

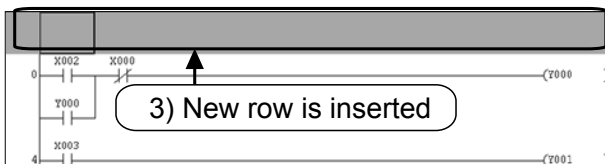
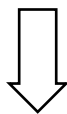

- 3) A row is inserted.

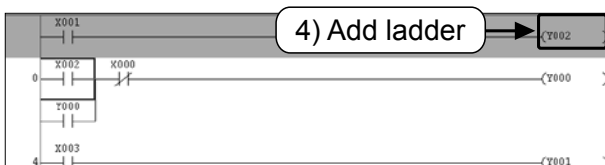
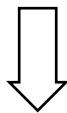

- 4) Add ladder in the inserted row.



- 5) Confirm the changes by pressing the Convert (F4) key.

2) Deleting rows

[Program where row is to be deleted]

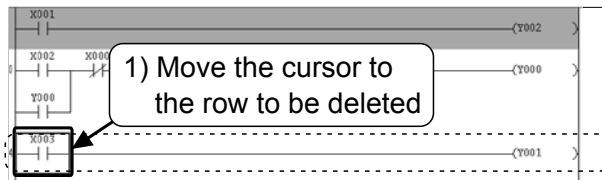
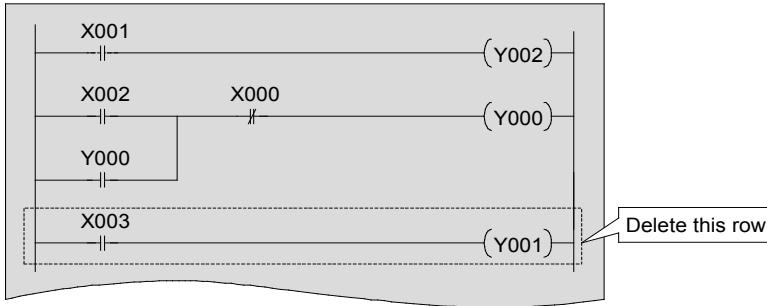

1) Move to the row to be deleted

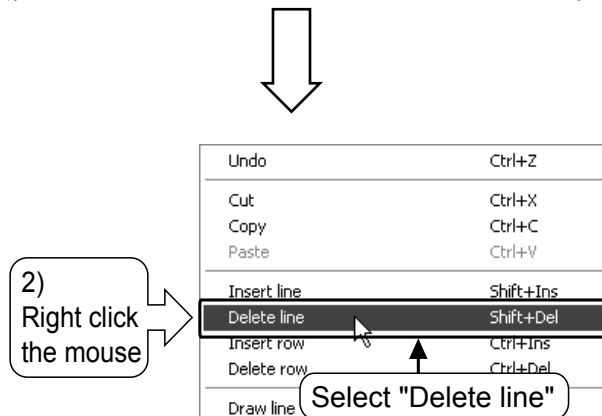

2) Right click the mouse at any place, and select [Delete line]

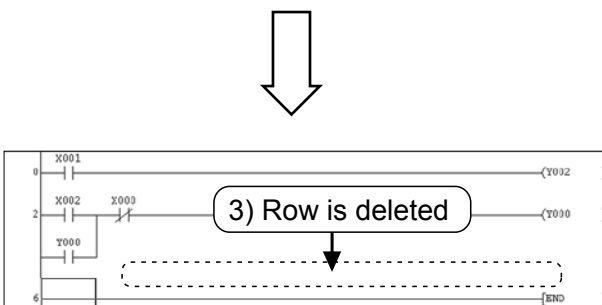

3) The row is deleted

Point

The line to be deleted is displayed in gray.
Confirm it by pressing `Convert` (F4).

Appendix 1.5.3 Cutting and copying (pasting) ladder

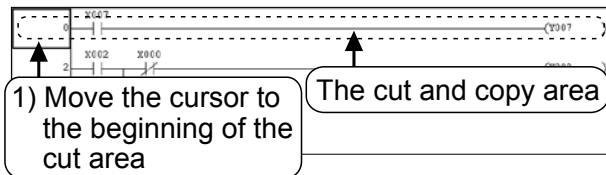
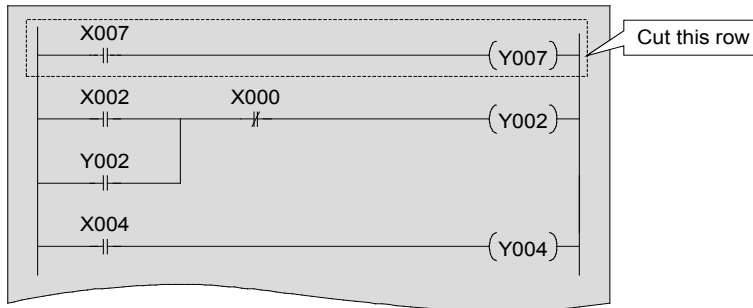

1) Cut

[Program be edited]

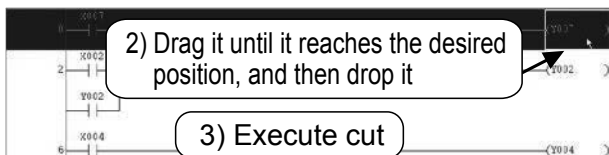

- 1) Move the cursor to the beginning of the ladder to be cut.



- 2) Drag it until it reaches the desired position, and then drop it.
- 3) Select  from the toolbar or select [Edit] → [Cut] ( + ) from the menu, and execute cut.

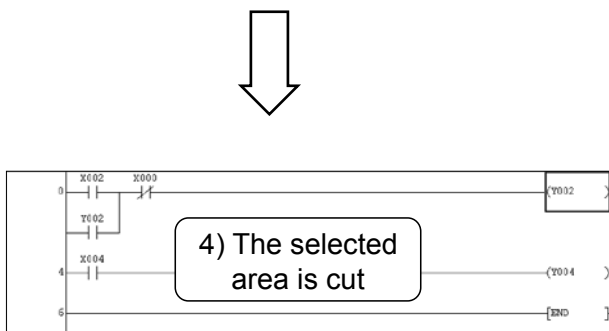



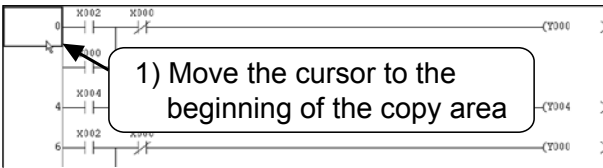
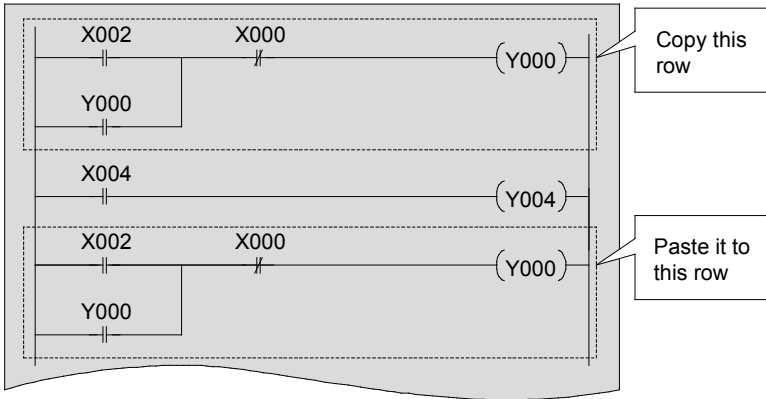

- 4) The selected area is cut
A gray part remains when a smaller portion of the ladder is cut. After amending the ladder, confirm the changes by pressing the  (Convert) key.

2) Copy(Pasting)

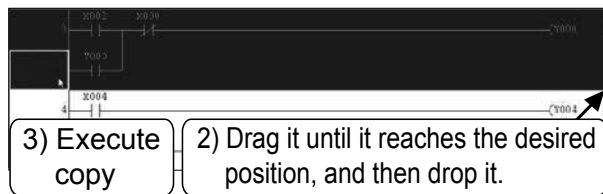
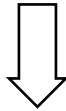

- 1) Move the cursor to the beginning of ladder to be copied.





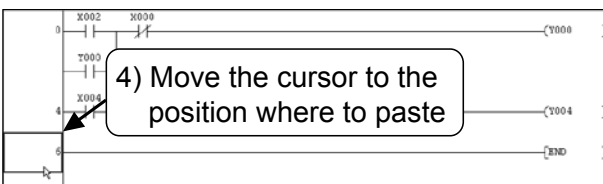
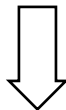

- 2) Drag it until it reaches the desired position, and then drop it.
- 3) Select  from the toolbar or select [Edit] → [Copy] ( + ) from the menu.

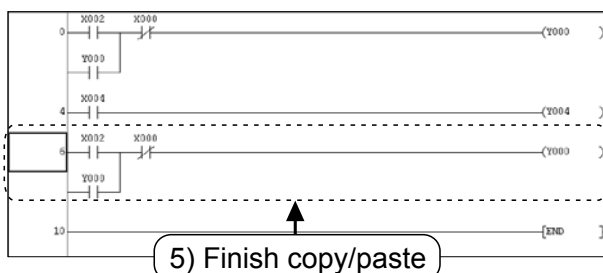
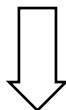

- 4) Move the cursor to the position where to paste.

Point
Switch by the  key
"Ovrwrte" mode : Pastes by overwriting data from the cursor position.
"Insert" mode : Pastes it by inserting data at the cursor position.



- 5) Select  from the toolbar or select [Edit] → [Paste] ( + ) from the menu.

A gray part remains when a smaller portion of the ladder is pasted. After amending the ladder, confirm the changes by pressing the  (Convert) key.

Appendix 1.6 Saving the program

Appendix 1.6.1 Save as and save

Point

If there is ladder that has not been compiled, press **Convert** (F4).



- 1) Select  from the toolbar or select [Project] → [Save] (**Ctrl** + **S**) from the menu.

(When it is saved by overwriting)

Project saving is finished.

(When it is newly saved)

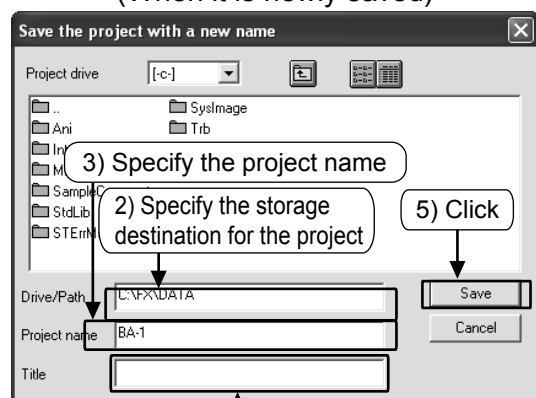

- 2) Specify the storage destination for the project.
- 3) Specify the project name.
- 4) Specify the title describing the project (optional).
- 5) Click **Save** .

4) Specify the title (optional)

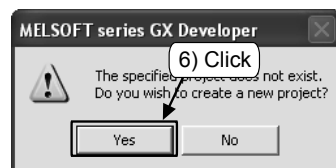

- 6) Click **Yes** in the conformation dialog to finish.

If there is not sufficient space in the floppy disk to save the project, temporarily save it to the hard disk and then move it to the other floppy disk.

Reference

- The following characters cannot be used in the project name.
/, \, >, <, *, ?, ", ' , | , : , ; (; , \ are only used to specify the driver)
Also, do not use "." (period) at the end of the project name.
- When the project name is specified with 8 or more characters by GX Developer (later than SW6D5-GPPW), characters past the 8th character will not be displayed if read by the old versions (older than SW2D5-GPPW) of GX Developer.
- The project path plus its name is within 150 half-width characters (75 full-width characters).
- The title is within 32 half-width characters (16 full-width characters).
- If there are spaces in the project path and project name, GX Developer cannot start normally even if GPPW.gpj, ***.gps is double-clicked in the Explorer window.
If there are spaces in the project path and project name, open the project by starting GX Developer → selecting [Project] → [Open project] from the menu.

Appendix 1.6.2 Saving the project as a new one

Point

If there is ladder that has not been compiled, press **Convert** (F4).

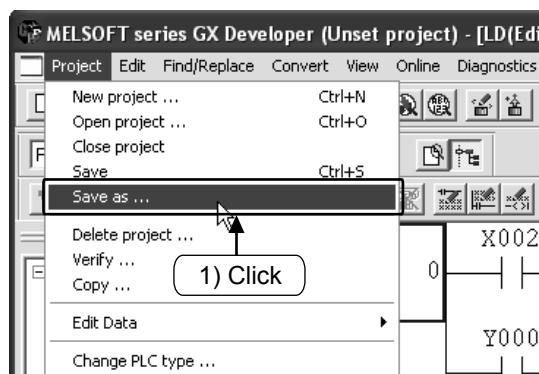

1) Select [Project] → [Save as] from the menu.

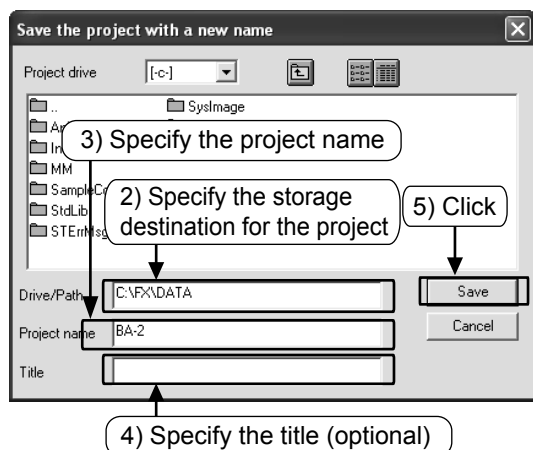

- 2) Specify the storage destination for the project.
- 3) Specify the project name.
- 4) Specify the title describing the project (optional).
- 5) Click **Save**.

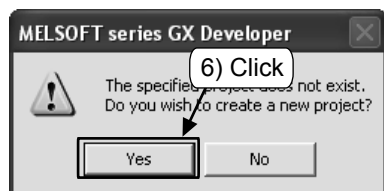

6) Click **Yes** in the confirmation dialog and finish.

For the way to name the driver/path and the project, see the previous page.

If there is not sufficient space in the floppy disk to save the project, temporarily save it to the hard disk and then move it to the other floppy disk.

Appendix 1.6.3 Reading the project

Reference

If another project is open when reading/opening a new file, the current project is closed.
If there is uncompiled ladder in the project or the project is not saved, a warning message is displayed.



- 1) Select  from the toolbar or select [Project] → [Open project] (**Ctrl** + **O**) from the menu.

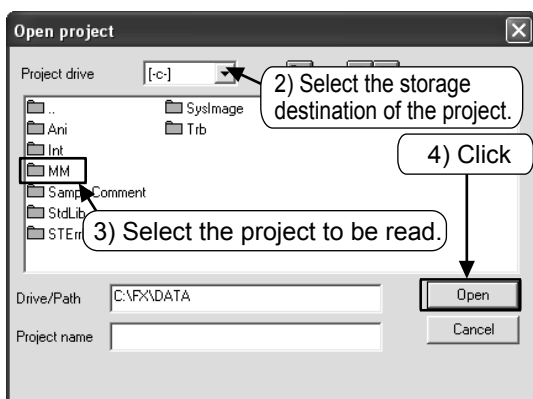
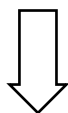

- 2) Select the storage destination of the project.
- 3) Select the project to be read.
- 4) Click **Open** and read the project.



Appendix 1.7 Necessary operation for the debugging program

For connecting to the PLC and the writing a program to the PLC, see "Appendix 1.4 Writing programs to PLC".

Appendix 1.7.1 Ladder monitor

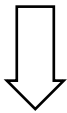
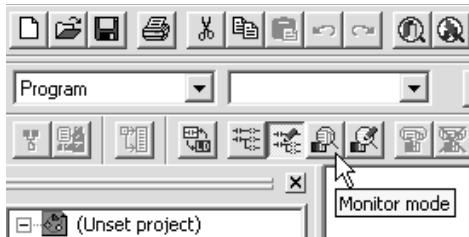
Display the ladder, and monitor the conduction status of the contacts and the driving status of the coils.



- 1) Select  from the toolbar or select [Online] → [Monitor] → [Monitor mode] from the menu.
- 2) The ON/OFF status of the ladder and the current value of word devices (timer, counter and data register) are displayed in the ladder monitor window.
- 3) Right click the window, select [Stop monitor] to quit the ladder monitor.
- 4) In order to correct and write the program, select  from the toolbar or select [Edit] → [Write mode] from the menu.

Reference

(1) the display of the monitor status dialog

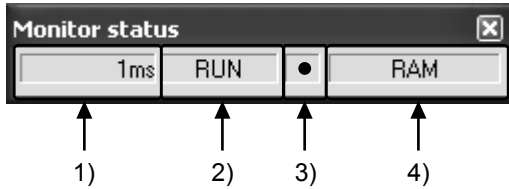

- 1) Scan time
The maximum scan time of the sequence program is displayed.
- 2) PLC status
The status of the PLC is displayed.
- 3) The execution status of the monitor
This icon flashing when the monitor is being executed.
- 4) Memory type
The memory type of the PLC is displayed.

(2) Interpretation of the ladder monitor display

1) Contact Instruction

Type \ Input contact	X0: OFF	X0: ON
NO contact	X000 — — Contact open	X000 —■— Contact close
NC contact	X000 —■— Contact close	X000 — — Contact open

2) Out Instruction

Type \ Driving status	Non-execution/ Non-drive	Execution/Drive
—()— OUT instruction	—(Y000)—	—■(Y000)■—
—[]— SET instruction, etc.	—[SET M0]—	—■[SET M0]■—

The ON/OFF status of the device to be reset is displayed by the monitor using RST instruction.

Type \ Device status	When device to be reset is OFF	When device to be reset is ON
—[]— RST instruction	—■[RST M0]■—	—[RST M0]—

Appendix 1.7.2 Device registration monitor

1) Registering optional devices

Register the optional devices in the monitor window and monitor the necessary part only.

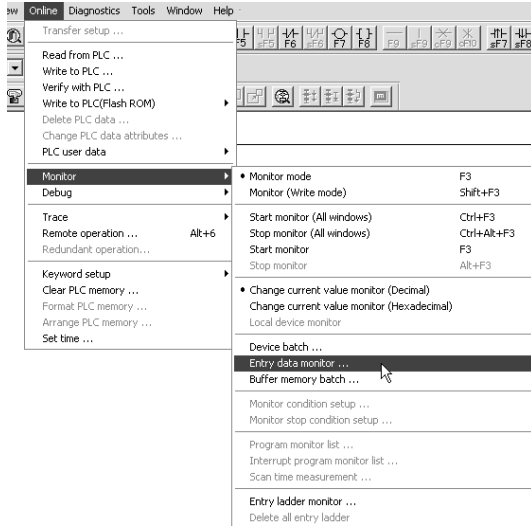

- 1) Set the ladder monitor status. (See Section Appendix 1.7.1)
- 2) Select [Online] → [Monitor] → [Entry data monitor] from the menu. Or right click the ladder window and select [Entry data monitor].

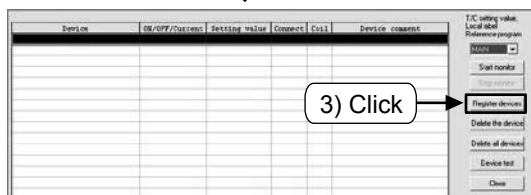
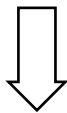

- 3) Click [Register devices] in the "Entry data monitor" window.

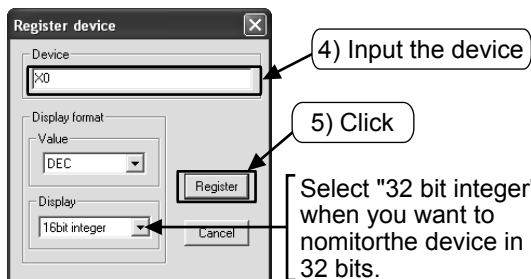
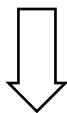

- 4) Input the device number to be registered in the Register device window.
- 5) Click [Register].

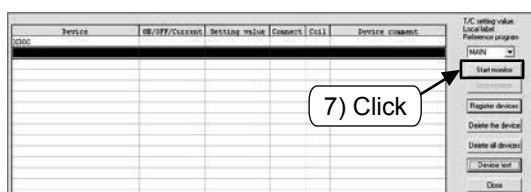
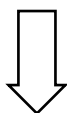

- 6) The device is registered in the monitor window.
- 7) Click [Start monitor], and the value showing the device action and the ON/OFF status of the contacts and coils are displayed.

2) Registering the devices displayed in the ladder monitor

Specify the area of the ladder in the ladder monitor window and register all of the devices in the area.

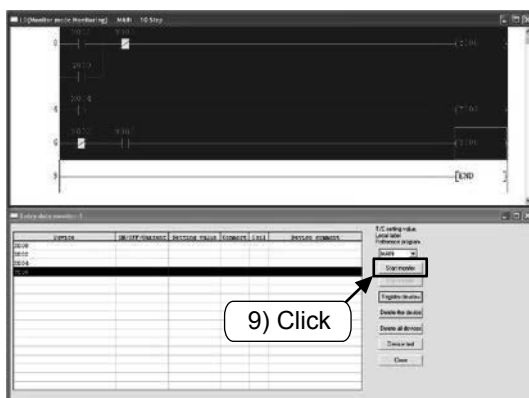
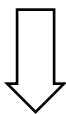
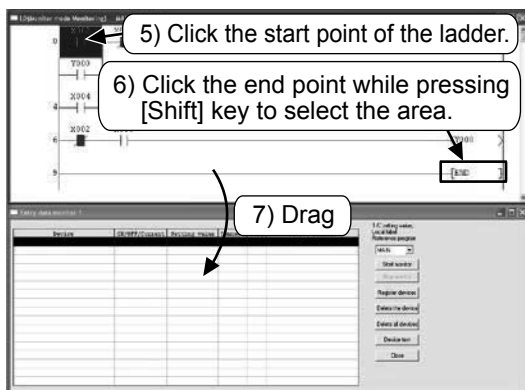
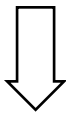
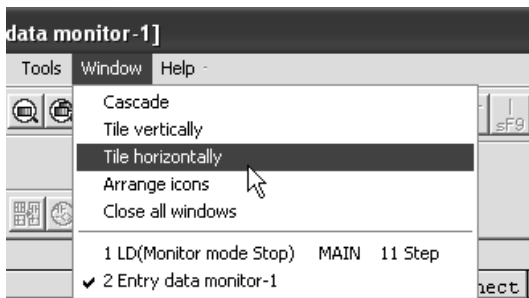

- 1) Set to monitor mode. (See Section to Appendix 1.7.1)
- 2) Select [Online] → [Monitor] → [Entry data monitor] from the menu. Or right click the ladder monitor window and select [Entry data monitor]. (See the previous page)
- 3) Select [Window] → [Tile horizontally] from the menu to display the "Ladder monitor window" and "Entry data monitor window" apposed together. (Set "Entry data monitor window" to the status of stop monitoring).
- 4) The "Ladder monitor window" and "Entry data monitor window" are displayed horizontally.
- 5) Click the start point of the ladder.
- 6) Click the end point while pressing the [Shift] key to select the area.
- 7) Drag the selected area to the "Entry data monitor window".
- 8) The devices are registered to the monitor window.
- 9) Click [Start monitor], and the value showing the device action and the ON/OFF status of the contacts and coils are displayed.

Appendix 1.7.3 Device batch monitor

Specify a device and monitor a continuous range of devices that follow it.

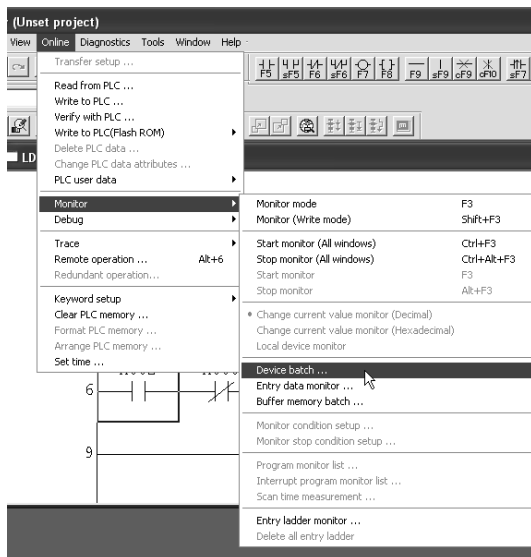

- 1) Set to monitor mode. (See Section Appendix 1.7.1)
- 2) Select [Online] → [Monitor] → [Device batch] from the menu. Or right click the ladder window and select [Device batch].

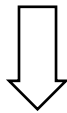

3) Input the device

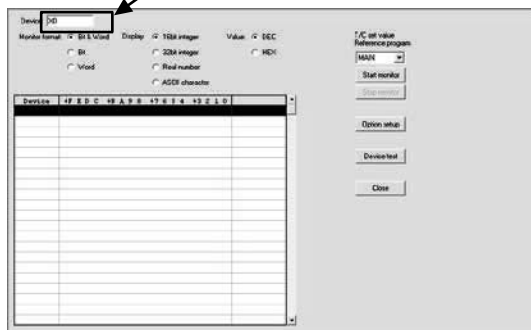

- 3) Input the first device of the devices to be monitored in the "Device batch monitor" window and then pressing the **Enter** key, and then click [Start monitor].

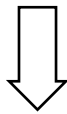

- 4) The value showing the device action and the ON/OFF status of the contacts and coils are displayed.

Appendix 1.7.4 Device test

1) Force ON/OFF

Forcedly turn ON/OFF the bit devices of PLC (M, Y, T, C and so on). (The forced ON/OFF function of X is not available).

When PLC is running, the forced ON/OFF function can turn on or off the devices only for one scan and the operations according to the sequence program are given priority. When checking the output, set PLC to the STOP status.

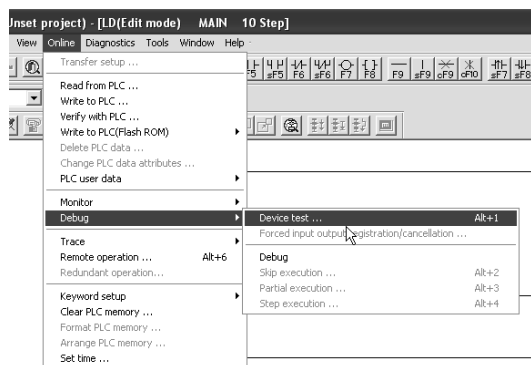

- 1) Set to monitor mode. (See Section Appendix 1.7.1)
- 2) Select [Online] → [Debug] → [Device test] from the menu. Or right click the ladder window and select [Device test].

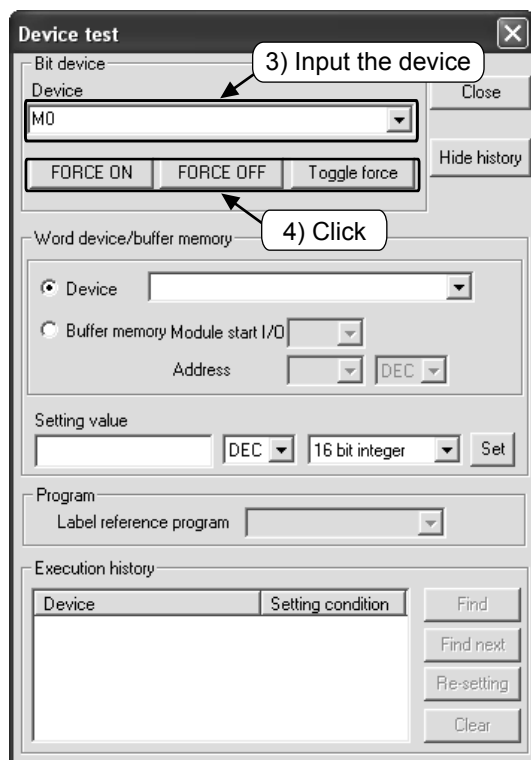
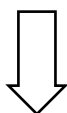

- 3) Input the device number to be forcibly turned on/off.
- 4) • [FORCE ON]: Forces device to ON.
• [FORCE OFF]: Forces device to OFF.
• [Toggle force]: Forces the device to toggle ON/OFF each time it is pressed.

Reference

Forced ON/OFF (Ladder monitor window)

Any bit device (contact and coil) can be forcedly turned on/off by double-clicking the device in the [Ladder monitor window] while pressing the [Shift] key.

2) Changing the current value of the word device

Change the current value of the PLC's word device (T, C, D and so on).

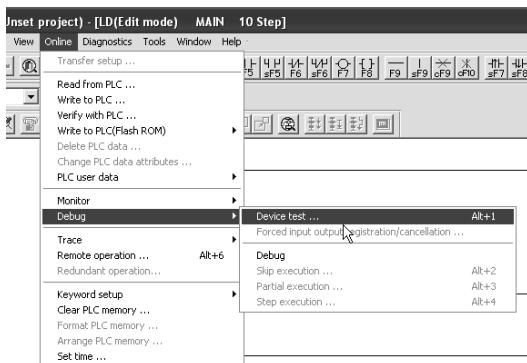

- 1) Set to monitor mode. (See Section Appendix 1.7.1.)
- 2) Select [Online] → [Debug] → [Device test] from the menu. Or right click the ladder

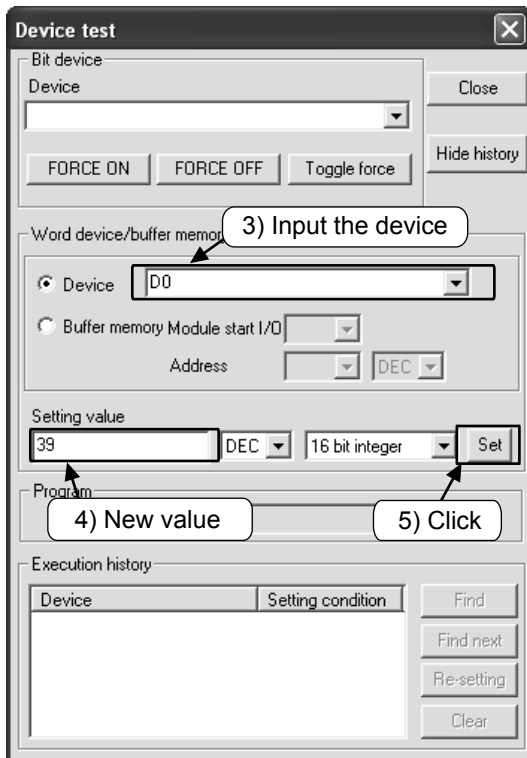
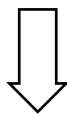

- 3) Input the device number to be changed.
- 4) Input a new value.
- 5) Click [Set].

Appendix 1.7.5 Writing a program to the PLC during RUN

Write the corrected part of the ladder to the PLC when the PLC is running.

Less time is needed for writing during RUN since the entire program is not transferred.

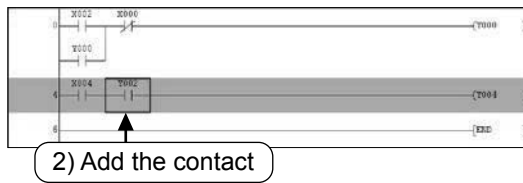
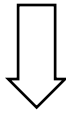
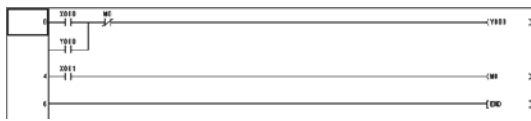

Write during RUN

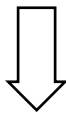

[Shift]+[F4]

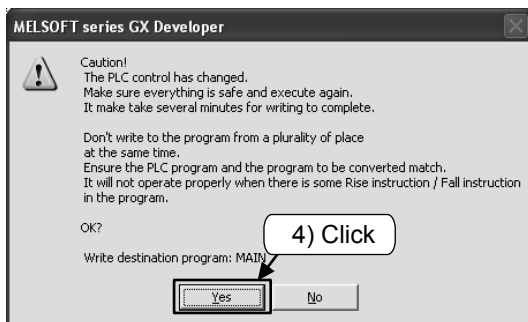

5) Click

1) A contact will be added to the ladder on the left as an example. Within the ladder view, set the mode to write mode ().

2) Add the contact.
The ladder block is displayed in gray.

3) Press [Shift] and [F4] together, or select [Convert] → [Convert (Write during RUN)] from the menu.

4) Click [Yes] to confirm the warning message about PLC safety regarding online changes.

5) The message "RUN write processing has completed." is displayed. Click [OK].

Caution

It is impossible to write the program to the PLC if the program in the PLC is different from the one in GX Developer. Verify in advance, or transfer the program first by using [Write to PLC].

Appendix 1.8 Inputting comment

Appendix 1.8.1 Types of the comment

The following 3 types of the comments can be input.

Type	Purpose	The number of characters (full-width)	Remark
1) Device comment	A comment describing the role and function of each device	16	It is necessary to set the "Comments capacity" in the parameter setting when writing to the PLC. The "Comment range setting" must also be set.
2) Statement	A comment describing the role and function of ladder blocks	32	This is a comment on GX Developer side. (It is not downloaded to the PLC).
3) Note	A comment describing the role and function of output instructions	16	This is a comment on GX Developer side. (It is not downloaded to the PLC).

[Comment Examples]

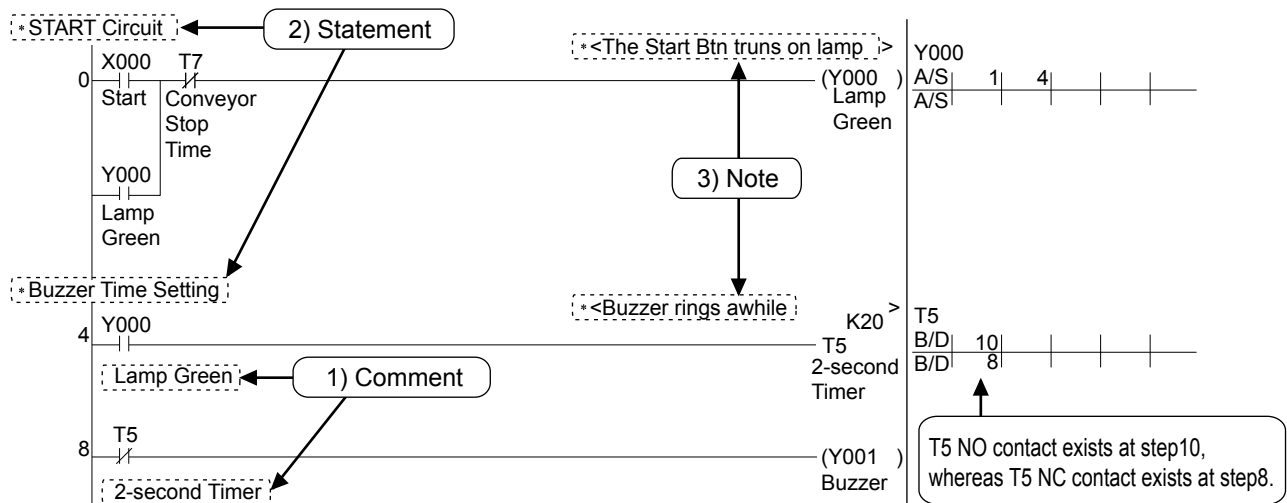

Point

How to display the comment

- Select [Display] → [Display comment] from the menu and then the comments are displayed.
- Repeat the operation above to stop displaying comments.

Appendix 1.8.2 Operation for creating device comments

1) How to input device comments using a list



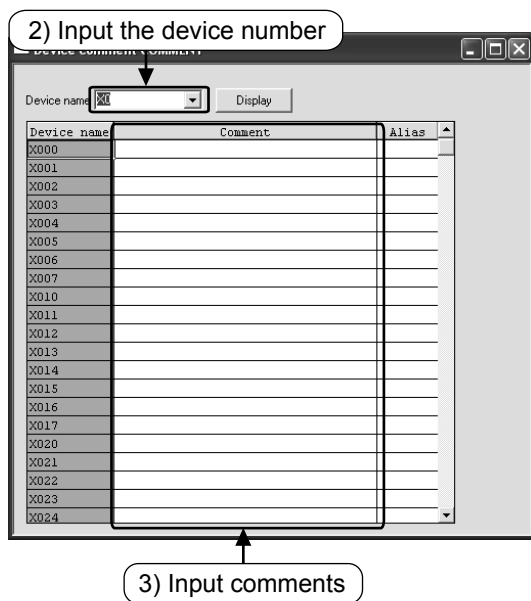

- 1) Double click [Device comment] → [COMMENT] in the project list.

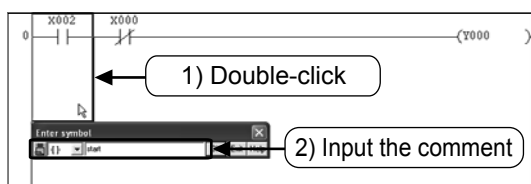

- 2) Input the start device of the devices to be commented in "Device name", and click [Display].
- 3) Input comments in the "Comment" column.
 - When inputting comments for another device, Input the device number again in step 2.

2) How to input the device comments in the ladder



- 1) Click  from the toolbar and double-click the ladder element to be commented.
- 2) Input the comment in the "Enter symbol" window and click [OK].
 - Click  on the toolbar again to finish the operation.

Point

Setting for writing the device comments to the PLC

It is necessary to set "Parameter setting" and "Comment range setting" in order to write the device comments to the PLC.

1) Parameter setting

- Select [Parameter] → [PLC parameter] in the project list.
- Set the "number of blocks" in the "Comments capacity" setting.
One block is equivalent to 50 comments, occupying 500-steps of program memory.

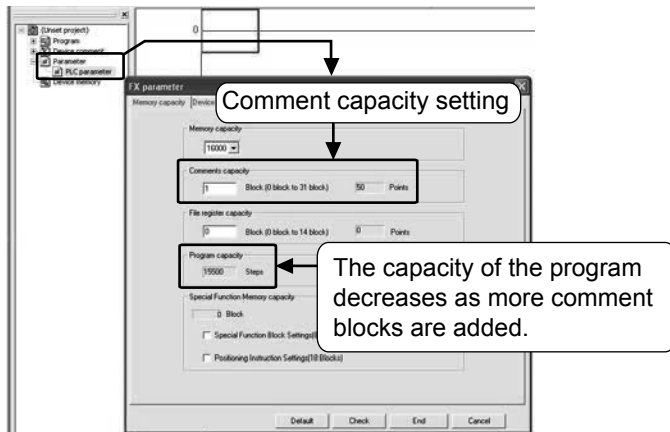

2) Comment range setting

- Select [Device comment] → [Comment], and then the comment input screen is displayed.
- Select [Edit] → [Setup comment range] from the menu.
- Set the type and the range of the devices to be written to PLC in the Setup comment rang dialog.

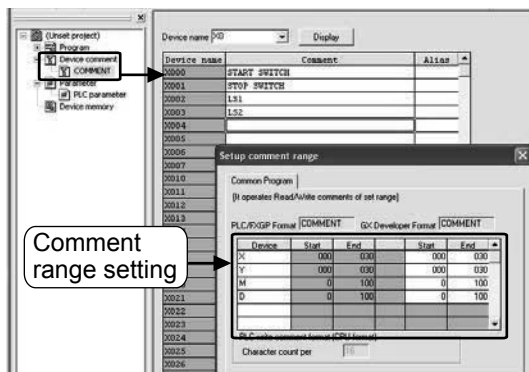

Reference

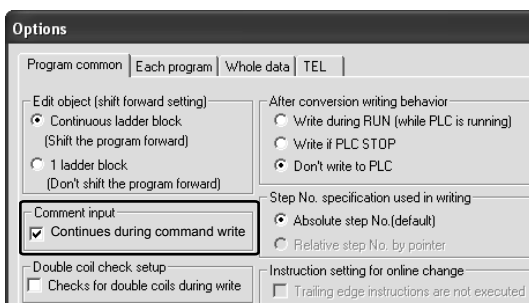



Select [Tool] → [Options] from the menu, Check "Continues during command write" of the [Comment input] box in the [Program common] tab.

After configuring the settings as above, the operation of the ladder input continues and the "Enter symbol" window described in step 2) is displayed, when the program is being created.

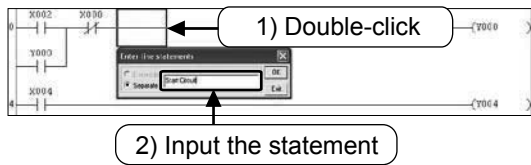

Appendix 1.8.3 Operation for creating statements

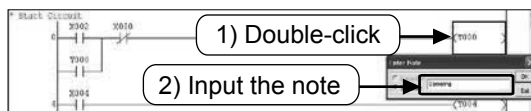

- 1) Click  from the toolbar, and double-click anywhere on the ladder block where the statement is to be written.
- 2) Input the statement in the "Enter line statements" window and click [OK].
 - Click  on the toolbar again to finish the operation.

Appendix 1.8.4 Operation for creating notes



- 1) Click  from the toolbar, and double-click the output instruction symbol where the note is to be written.
- 2) Input the note in the "Enter Note" window and click [OK].
 - Click  on the toolbar again to finish the operation.

Appendix 1.9 Operation for creating the program list

In GX Developer, the program can also be created by list.

Appendix 1.9.1 Displaying the list edit screen

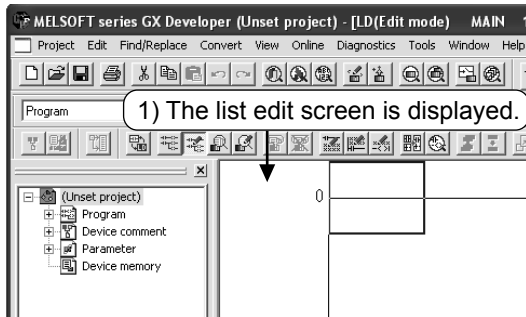

1) Create a new project (See Section Appendix 1.2.2) or display the ladder of the existing project.

2) Select  from the toolbar or select [View] →

[Instruction list] from the menu.

3) The list edit screen is displayed.

Click  on the toolbar again or select [View] → [Ladder] from the menu to return to the ladder display.

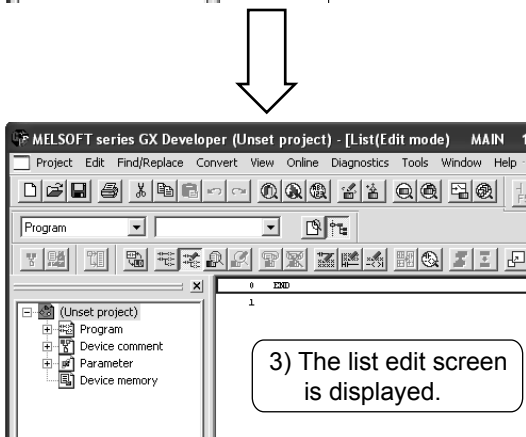

Appendix 1.9.2 How to input instructions

Initial screen

0	END
1	

After list input

0	LD	X000	
1	OUT	Y000	
2	LDI	X001	
3	AND	Y000	
4	OUT	M0	
5	LD	M0	
6	OUT	T0	K10
9	OUT	C0	K5
12			

1) Input the instruction language from step 0 sequentially. The step number is added automatically when instruction is input. (For the input procedures, see the next page).

- **How to input the basic instructions and the applied instructions**

A "space" is input between the instruction language, device number and operand.

[Examples for the basic instructions]

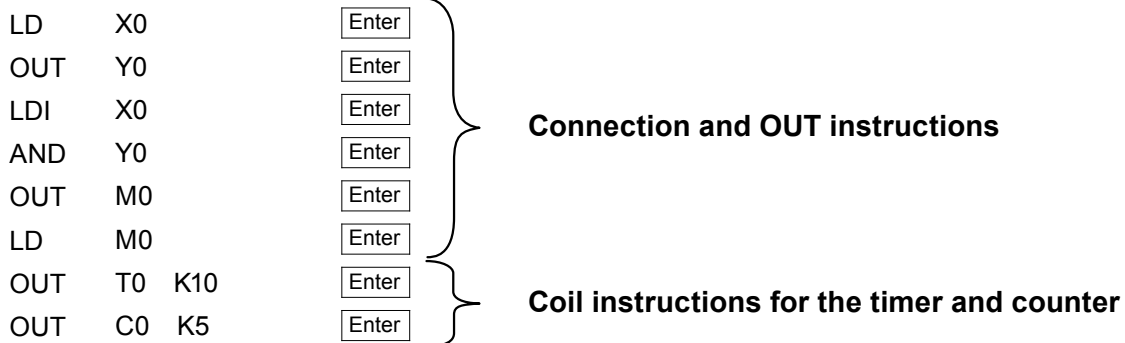

[Examples for the applied instructions]

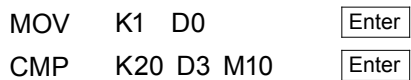

Reference

The key operation when inputting/editing

- "Ovrwrte"/"Insert" mode switches by pressing the key.
- An instruction can be deleted by the key.
- [Insert line] and [Delete line] operations can be done by the right click of the mouse

Appendix 1.9.3 Checking the content of the list input

Confirm that there are no errors in the program created by list input in the ladder display.

0	LD	X002
1	OR	Y000
2	ANI	X000
3	OUT	Y000
4	LD	X004
5	OUT	Y004
6	LDI	X002
7	AND	X000
8	OUT	Y000
9	LD	X003
10	OUT	M0
11	END	
12		

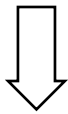
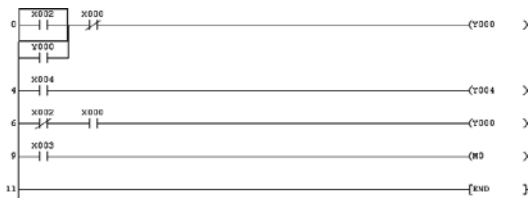
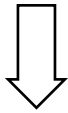

Check program (MAIN)

Check contents:

- Instruction check
- Double coil check
- Ladder check
- Device check
- Consistency (pair) check

Check target:

- Target the whole program
- Target the current program

SFC check data:

- All blocks
- Current block

Buttons: Execute, Close, Jump

Program name	Step/Row	Cause
MAIN		No errors.

1) Select  from the toolbar, or select [View] → [Ladder] from the menu.

2) Check whether the program created by list input is displayed.

3) Select [Tools] → [Check program] to execute the program check, and check whether errors occur and the error steps.

MEMO

Appendix 2

Introduction example list programs

Appendix 2.1 List programs

Introduction example 1

《List program: Example 1》

Step	Command
0	LD X001
1	OR Y000
2	ANI X003
3	OUT Y000
4	OUT Y003
5	END

《List program: Example 2》

Step	Command
0	LD X001
1	SET Y000
2	SET Y003
3	LD X003
4	RST Y000
5	RST Y003
6	END

Introduction example 3

《List program》

Step	Command
0	LD X001
1	OR Y000
2	ANI X003
3	OUT Y000
4	LD Y000
5	AND X000
6	OUT Y002
7	AND Y002
8	MPS
9	AND X005
10	ANI Y003
11	OUT Y001
12	MPP
13	AND X006
14	ANI Y001
15	OUT Y003
16	END

Introduction example 2

《List program》

Step	Command
0	LD X000
1	AND X001
2	OUT Y001
3	LD X003
4	OR Y003
5	ANI X004
6	OUT Y003
7	LD Y003
8	OUT C0 K5
11	LD C0
12	OUT Y000
13	LD X002
14	RST C0
16	END

Introduction example 4

《List program》

Step	Command
0	LD X001
1	OR Y003
2	ANI C0
3	OUT Y003
4	LD X004
5	OUT C0 K4
8	LD C0
9	OUT Y001
10	OUT T0 K10
13	AND T0
14	OUT Y002
15	OUT T1 K20
18	LD T1
19	RST C0
21	END

Introduction example 5

《List program》

Step	Command
0	LD X001
1	OR Y000
2	ANI T4
3	OUT Y000
4	OUT T0 K20
7	LD T0
8	OUT Y001
9	OUT T1 K20
12	LD T1
13	OUT Y002
14	OUT T2 K20
17	LD T2
18	OUT Y003
19	OUT T3 K20
22	LD T3
23	OUT Y004
24	OUT T4 K20
27	END

MEMO

Appendix 3

Handy Programming Panel

By using the handy programming panel (HPP) ...

You can easily edit programs in list format using the HPP.

For creating programs and debugging equipment on sites where personal computers cannot be always installed, the HPP is convenient to give simple modifications to programs and changing constants of timers and counters.

For checking the contents of errors ...

You can easily check the contents of errors using the monitor function and program check function of the HPP.

For storing programs and transferring programs to PLCs ...

The HPP FX-30P can store up to 15 sequence programs (or up to 7 sequence programs if their capacity exceeds 32000 steps). The personal computer is not required to update PLCs far way from the personal computer.

For export equipment ...

Because the HPP FX-30P offers display in Japanese, English and Chinese, it can be included with export machines.

Appendix 3.1 Handy programming panel (HPP)

You can easily edit programs in list format using the HPP FX-30P.

For creating programs and debugging equipment on sites where personal computers cannot be always installed, the HPP is convenient for making simple modifications to programs and changing constants of timers and counters.

- 1) Functions convenient for setting up equipment
 - Editing programs using instruction list
 - Monitoring and forcing ON/OFF of devices
- 2) Functions convenient for troubleshooting
 - Program check function
 - PLC diagnosis function
- 3) Functions convenient for maintenance
 - Change of timer set values and counter set values
 - Transfer of updated sequence programs
(The HPP can store up to 15 sequence programs whose capacity is 32000 steps or less).
- 4) Functions convenient for export equipment
 - Operation messages can be switched between English, simplified Chinese and Japanese.

[Example of connection]

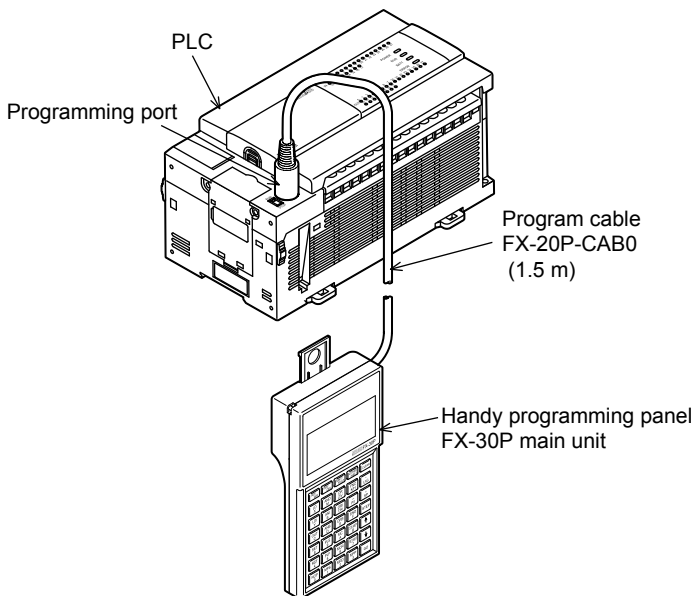

[FX-30P Dimensions]

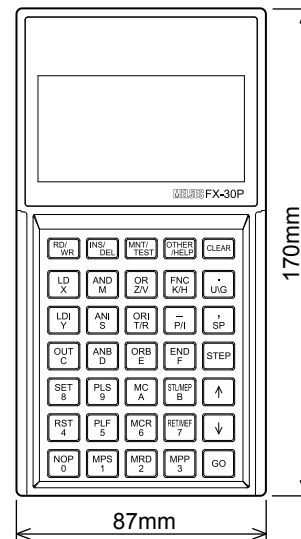

Mass : 0.3kg

[FX-30P Function List]

■ Online mode (Functions to directly access the memory inside the PLC)

Function		Description
Programming	Read	Reads a sequence program (from the program memory inside the PLC to the screen on the FX-30P).
	Write	Writes a sequence program (by key inputs in the FX-30P to the program memory inside the PLC).
	Insert	Inserts instructions into a sequence program (by key inputs in the FX-30P into the program memory inside the PLC).
	Delete	Deletes instructions from a sequence program (by key inputs in the FX-30P from the program memory inside the PLC).
Monitor		Reads the operation state (from the memory inside the PLC to the screen on the FX-30P).
Test		Forcibly writes devices (by key inputs in the FX-30P to the memory inside the PLC).
Others	Offline select	Switches to offline mode.
	PLC diagnosis	Diagnoses the PLC.
	Memory cassette transfer	Transfers data to the memory cassette.
	Parameter	Sets parameters.
	Keyword	Sets keywords.
	Device conversion	Executes device conversion.
	Latch clear	Executes latch clear.
	Device batch monitor	Executes device batch monitor.
	BFM batch monitor	Executes buffer memory batch monitor.
	Baud rate	Changes the baud rate.
	PLC memory clear	Clears the memory inside the PLC.
	Remote RUN/STOP	Changes over the PLC state between "RUN" and "STOP".
	PLC clock setting	Sets the clock in the PLC.
HPP setting	Sets the HPP	

■ Offline mode (Functions to access the RAM memory inside the FX-30P)

Function		Description
Programming	Read	Reads a sequence program (from the RAM built in the FX-30P to the screen on the FX-30P).
	Write	Writes a sequence program (by key inputs in the FX-30P to the RAM built in the FX-30P).
	Insert	Inserts instructions into a sequence program (by key inputs in the FX-30P into the RAM built in the FX-30P).
	Delete	Deletes instructions from a sequence program (by key inputs in the FX-30P from the RAM built in the FX-30P).
Others	Online select	Switches to online mode.
	Program check	Checks programs.
	HPP-FX transfer	Transfers data between the RAM built in the FX-30P and the FX PLC.
	HPP-PC transfer*	Transfers data between the RAM built in the FX-30P and the personal computer.
	Parameter	Sets parameters.
	Device conversion	Executes device conversion.
	PLC type	Changes the PLC type.
	HPP memory clear	Clears the memory inside the FX-30P.
	Program management	Manages programs stored in the RAM and flash memory (15 blocks) built in the FX-30P.
	HPP setting	Sets the HPP.

*: The firmware Ver. 1.10 or later supports transfer between the HPP and the personal computer.

■ HPP setting (Setting functions for the FX-30P main unit)

Function	Description
Language	Selects display language(English, Japanese and Chinese).
Buzzer sound volume	Adjusts the buzzer sound volume.
LCD contrast	Adjusts the LCD contrast.
Backlight brightness	Adjusts the backlight brightness.
Screen saver	Sets the screen saver.
HPP protect	Sets protection to programs stored in the FX-30P.
HPP initialization	Returns the FX-30P to factory default settings.
HPP F/W update	Updates the firmware stored in the FX-30P.

MEMO

Appendix 4

Training Machine Wiring

Appendix 4.1 I/O Wiring Diagram for Training Machine

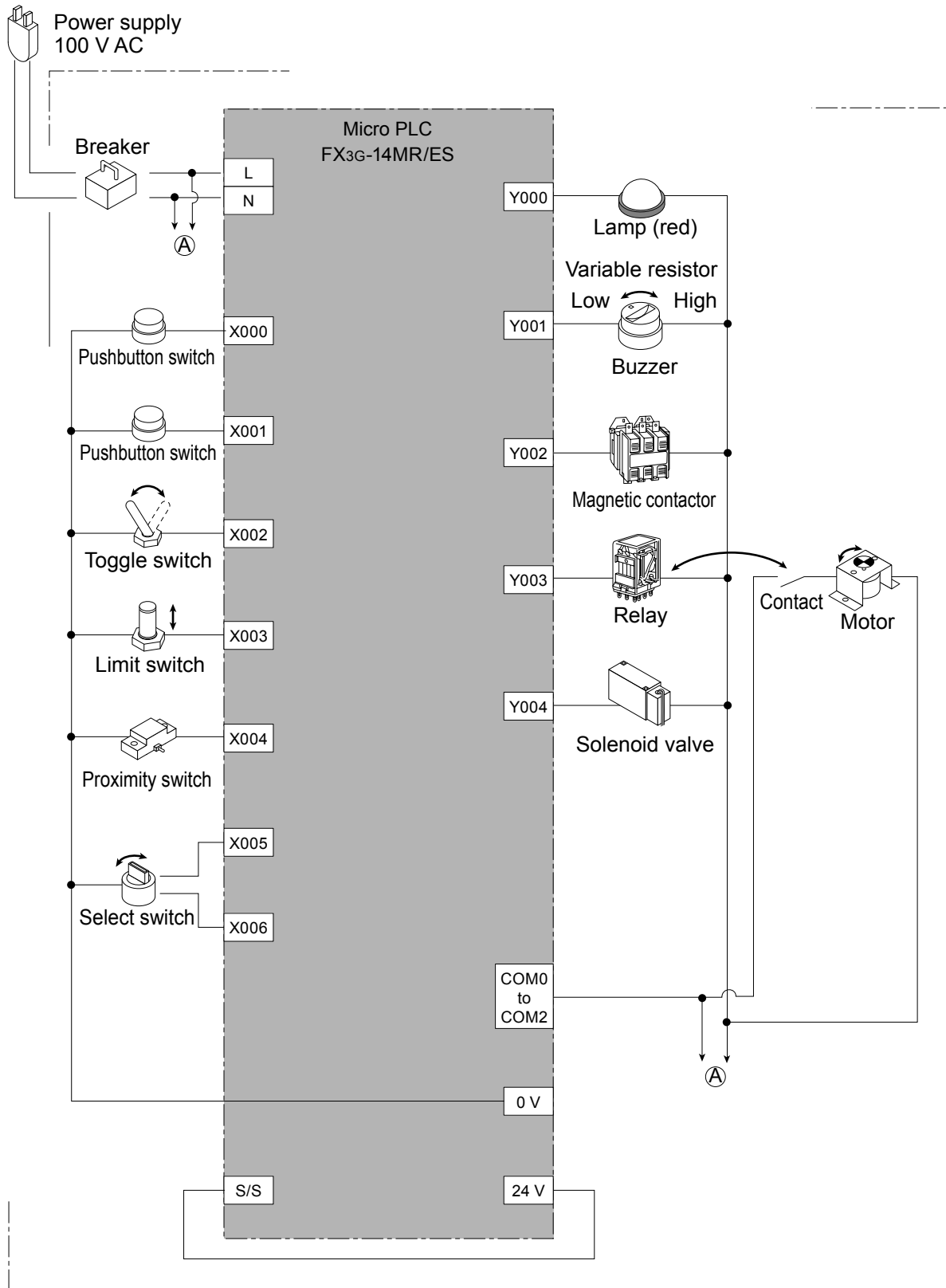

FX-I/O-DEMO2 Type Training Machine

MEMO

Revised History

Date	Revision	Description
4/2006	A	First Edition
3/2007	B	Adding and revising the other descriptions.
2/2014	C	Adding and revising the other descriptions.
9/2014	D	Adding and revising the other descriptions.
5/2015	E	A part of the cover design is changed.
7/2016	F	Adding and revising the other descriptions.

MITSUBISHI ELECTRIC CORPORATION

HEAD OFFICE : TOKYO BUILDING, 2-7-3 MARUNOUCHI, CHIYODA-KU, TOKYO 100-8310, JAPAN
