

<Hybrid-SiC Modules>

CMH400HC6-24NFM

HIGH POWER SWITCHING USE
INSULATED TYPE



single switch

Collector current I_C 400 A
 Collector-emitter voltage V_{CES} 1200 V
 Maximum junction temperature T_{jmax} 150 °C

- Silicon IGBT + Silicon Carbide Schottky Barrier Diode
- Flat base Type
- Copper base plate
- RoHS Directive compliant
- Recognized under UL1557, File E323585

APPLICATION

High frequency switching use(30kHz to 60kHz)
 Gradient magnetic power supply, Induction heating, etc.

OUTLINE DRAWING & INTERNAL CONNECTION

Dimension in mm

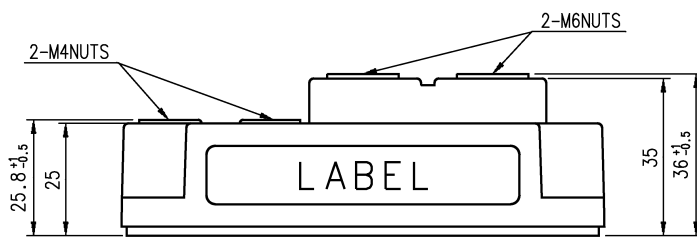
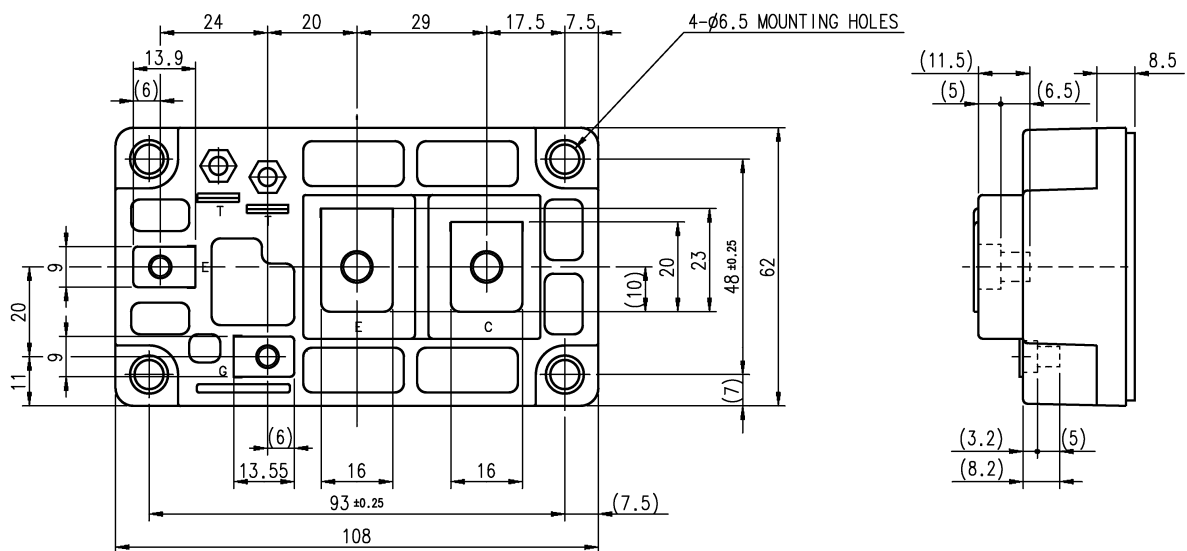

INTERNAL CONNECTION

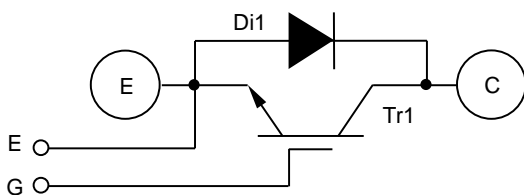

Tolerance otherwise specified

Division of Dimension	Tolerance
0.5 to 3	±0.2
over 3 to 6	±0.3
over 6 to 30	±0.5
over 30 to 120	±0.8
over 120 to 400	±1.2

CMH400HC6-24NFM

HIGH POWER SWITCHING USE
INSULATED TYPE

MAXIMUM RATINGS (T_j=25 °C, unless otherwise specified, per module)

Symbol	Item	Conditions	Rating	Unit
V _{CES}	Collector-emitter voltage	G-E short-circuited	1200	V
V _{GES}	Gate-emitter voltage	C-E short-circuited	± 20	V
I _C	Collector current	DC, T _C =25 °C (Note2, 4)	400	A
I _{CRM}		Pulse, Repetitive (Note3)	800	
P _{tot}	Total power dissipation	T _C =25 °C (Note2, 4)	2715	W
I _E (Note1)	Emitter current	DC, T _C =25 °C (Note2, 4)	400	A
I _{ERM} (Note1)		Pulse, Repetitive (Note3)	800	
V _{isol}	Isolation voltage	Terminals to base plate, RMS, f=60 Hz, AC 1 min	2500	V
T _j	Junction temperature	-	-40 ~ +150	°C
T _{stg}	Storage temperature	-	-40 ~ +125	

ELECTRICAL CHARACTERISTICS (T_j=25 °C, unless otherwise specified, per module)

Symbol	Item	Conditions	Limits			Unit	
			Min.	Typ.	Max.		
I _{CES}	Collector-emitter cut-off current	V _{CE} =V _{CES} , G-E short-circuited	-	-	20.0	mA	
I _{GES}	Gate-emitter leakage current	V _{GE} =V _{GES} , C-E short-circuited	-	-	1.4	μA	
V _{GE(th)}	Gate-emitter threshold voltage	I _C =40 mA, V _{CE} =10 V	4.5	6.0	7.5	V	
V _{CESat}	Collector-emitter saturation voltage	I _C =400 A, V _{GE} =15 V (Note5) Refer to the figure of test circuit	T _j =25 °C	-	3.0	4.5	V
			T _j =125 °C	-	3.0	-	
C _{ies}	Input capacitance	V _{CE} =10 V, G-E short-circuited	-	-	63	nF	
C _{oes}	Output capacitance		-	-	5.3		
C _{res}	Reverse transfer capacitance		-	-	1.2		
Q _G	Gate charge	V _{CC} =600 V, I _C =400 A, V _{GE} =15 V	-	1800	-	nC	
t _{d(on)}	Turn-on delay time	V _{CC} =600 V, I _C =400 A, V _{GE} =±15 V, R _G =3.0 Ω, Inductive load	-	-	300	ns	
t _r	Rise time		-	-	200		
t _{d(off)}	Turn-off delay time		-	-	500		
t _f	Fall time		-	-	200		
V _{EC} (Note1)	Emitter-collector voltage	I _E =400 A, G-E short-circuited (Note5) Refer to the figure of test circuit	T _j =25 °C	-	1.7	2.2	V
			T _j =125 °C	-	2.1	-	
Q _C (Note1)	Total capacitive charge	V _{CC} =600 V, I _E =100 A, V _{GE} =±15 V, R _G =3.0 Ω, Inductive load	-	1.5	-	μC	
E _{on}	Turn-on switching energy per pulse	V _{CC} =600 V, I _C /I _E =400 A,	-	10.0	-	mJ	
E _{off}	Turn-off switching energy per pulse	V _{GE} =±15 V, R _G =3.0 Ω,	-	28.0	-		
E _{rec} (Note1)	Reverse energy per pulse	T _j =125 °C, Inductive load	-	0.7	-	mJ	
r _g	Internal gate resistance	Per switch	-	0.75	-	Ω	

THERMAL RESISTANCE CHARACTERISTICS (per module)

Symbol	Item	Conditions	Limits			Unit
			Min.	Typ.	Max.	
R _{th(j-c)Q}	Thermal resistance	Junction to case (Note4)	-	-	46	K/kW
R _{th(j-c)D}		Junction to case (Note4)	-	-	123	
R _{th(c-s)}	Contact thermal resistance	Case to heat sink, Thermal grease applied (Note4, 6)	-	20	-	K/W

Caution; No short-circuit capability is designed.

CMH400HC6-24NFM

HIGH POWER SWITCHING USE
INSULATED TYPE

MECHANICAL CHARACTERISTICS

Symbol	Item	Conditions	Limits			Unit
			Min.	Typ.	Max.	
M_t	Mounting torque	Main terminals M 6 screw	1.96	2.45	2.94	N·m
M_t	Mounting torque	G/E auxiliary terminals M 4 screw	0.98	1.18	1.47	N·m
M_s	Mounting torque	Mounting to heat sink M 6 screw	1.96	2.45	2.94	N·m
m	mass	-	-	480	-	g
e_c	Flatness of base plate	On the centerline X ^(Note7)	0	-	100	μm
		On the centerline Y ^(Note7)	0	-	100	

*: This product is compliant with the Restriction of the Use of Certain Hazardous Substances in Electrical and Electronic Equipment (RoHS) directive 2011/65/EU.

Note1. Represent ratings and characteristics of the anti-parallel, emitter-collector free-wheeling diode (DIODE).

2. Junction temperature (T_j) should not increase beyond T_{jmax} rating.

3. Pulse width and repetition rate should be such that the device junction temperature (T_j) does not exceed T_{jmax} rating.

4. Case temperature (T_c) and heat sink temperature (T_s) are defined on the each surface (mounting side) of base plate and heat sink just under the chips. Refer to the figure of chip location.

5. Pulse width and repetition rate should be such as to cause negligible temperature rise.

6. Typical value is measured by using thermally conductive grease of $\lambda=0.9\text{ W/(m}\cdot\text{K)}$.

7. The base plate (mounting side) flatness measurement points (X, Y) are as follows of the following figure.

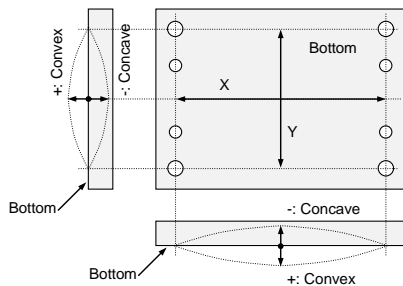

RECOMMENDED OPERATING CONDITIONS

Symbol	Item	Conditions	Limits			Unit
			Min.	Typ.	Max.	
V_{CC}	(DC) Supply voltage	Applied across C1-E2 terminals	-	600	800	V
V_{GEon}	Gate (-emitter drive) voltage	Applied across G1-Es1/G2-Es2 terminals	13.5	15.0	16.5	V
R_G	External gate resistance	Per switch	0.78	-	7.8	Ω

CHIP LOCATION (Top view)

Dimension in mm, tolerance: $\pm 1\text{ mm}$

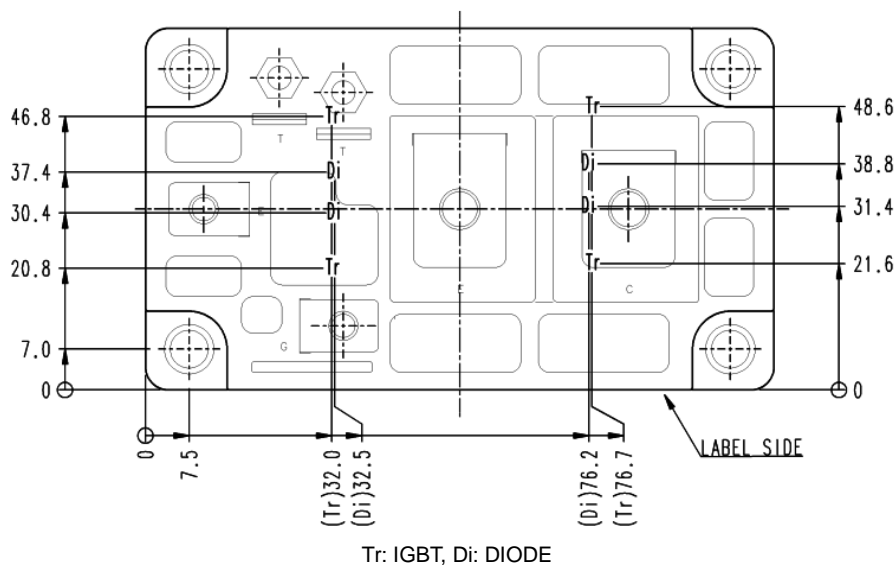

CMH400HC6-24NFM

HIGH POWER SWITCHING USE
INSULATED TYPE

TEST CIRCUIT AND WAVEFORMS

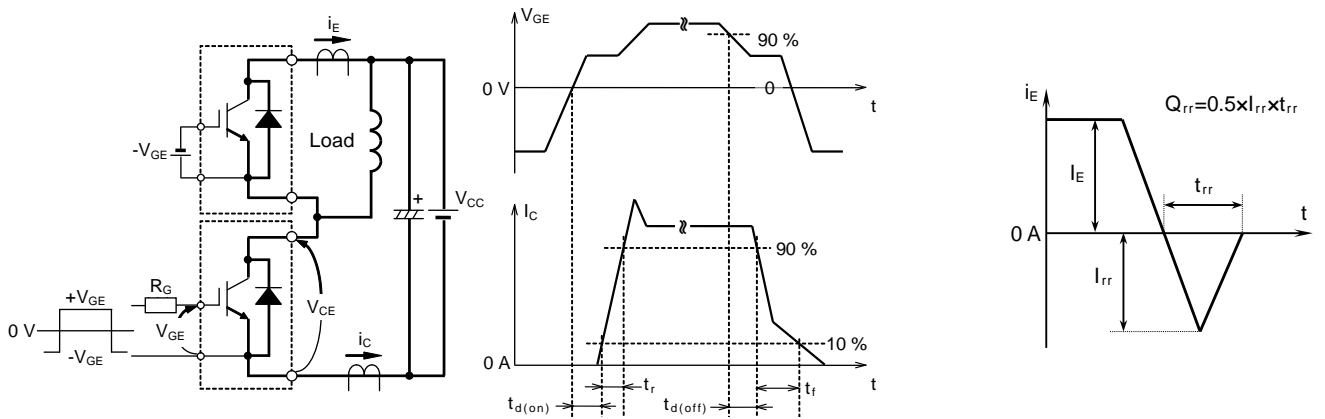

Switching test circuit and waveforms

t_{rr} , Q_{rr} test waveform

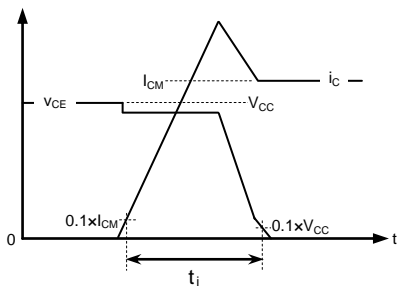

IGBT Turn-on switching energy

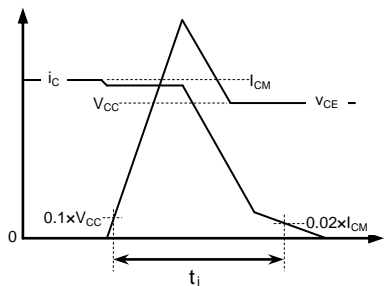

IGBT Turn-off switching energy

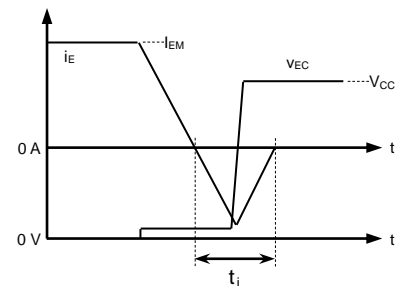

DIODE Reverse recovery energy

Turn-on / Turn-off switching energy and Reverse recovery energy test waveforms (Integral time instruction drawing)

TEST CIRCUIT

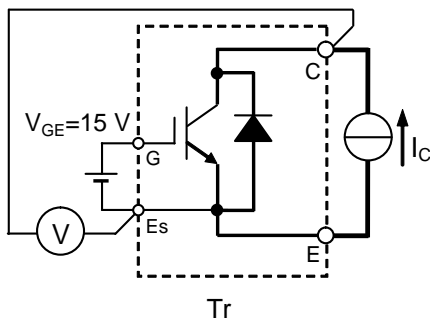

V_{CEsat} characteristics test circuit

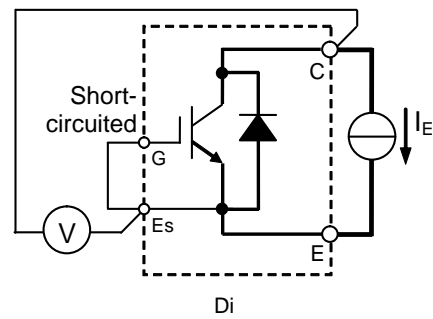

V_{EC} characteristics test circuit

CMH400HC6-24NFM

HIGH POWER SWITCHING USE
INSULATED TYPE

PERFORMANCE CURVES

OUTPUT CHARACTERISTICS (TYPICAL)

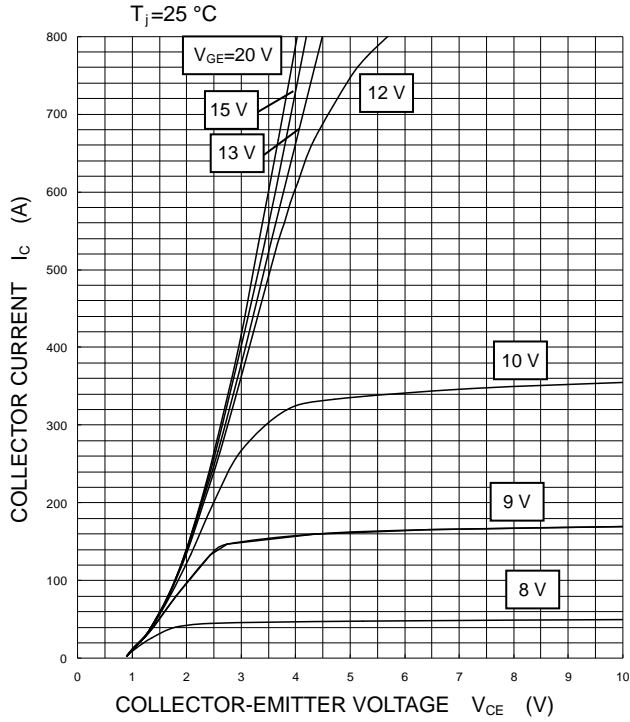

COLLECTOR-EMITTER SATURATION VOLTAGE CHARACTERISTICS (TYPICAL)

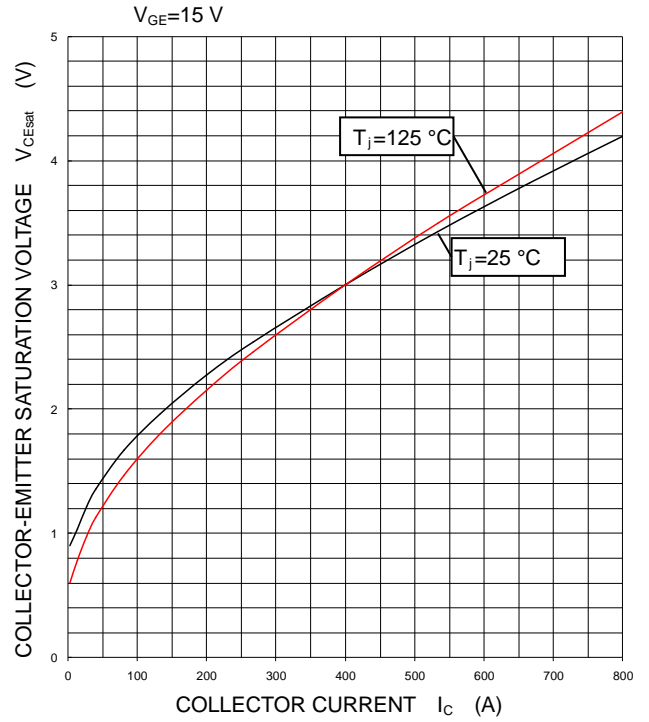

COLLECTOR-EMITTER SATURATION VOLTAGE CHARACTERISTICS (TYPICAL)

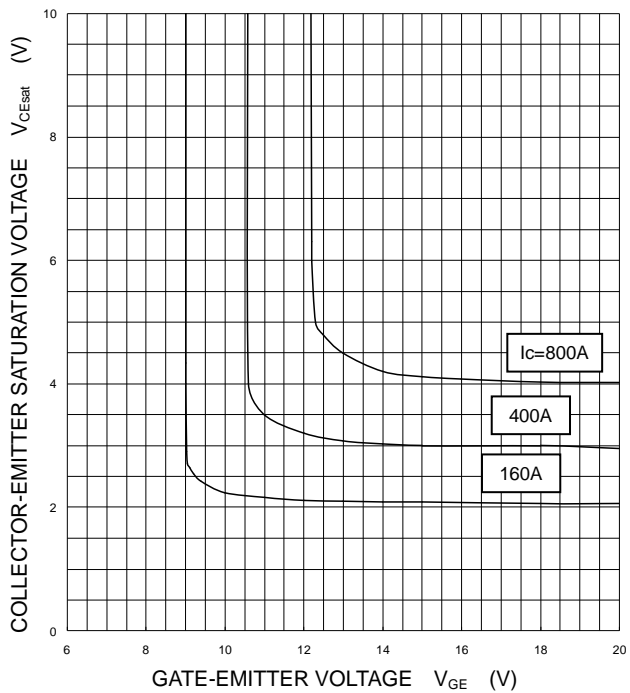

FREE WHEELING DIODE FORWARD CHARACTERISTICS (TYPICAL)

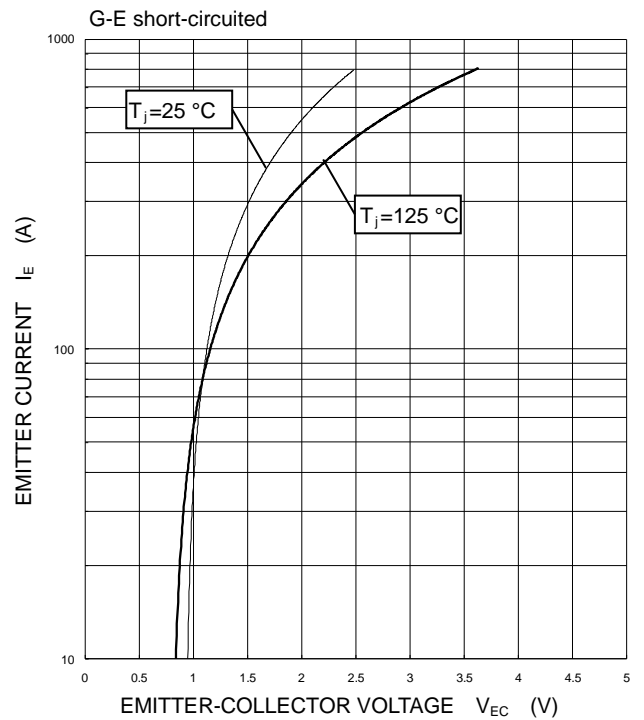

CMH400HC6-24NFM

HIGH POWER SWITCHING USE
INSULATED TYPE

PERFORMANCE CURVES

HALF-BRIDGE
SWITCHING CHARACTERISTICS
(TYPICAL)

$V_{CC}=600\text{ V}$, $V_{GE}=\pm 15\text{ V}$, $R_G=3.0\ \Omega$,
 $T_j=125\text{ }^\circ\text{C}$, INDUCTIVE LOAD

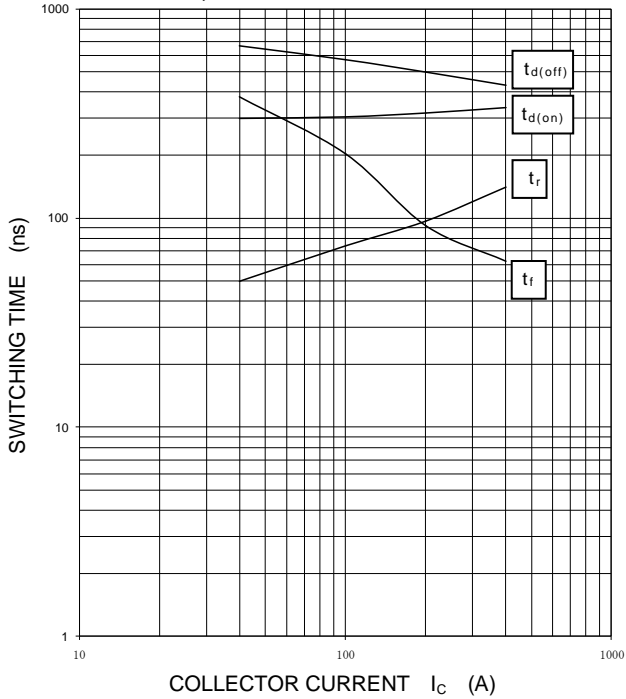

HALF-BRIDGE
SWITCHING CHARACTERISTICS
(TYPICAL)

$V_{CC}=600\text{ V}$, $V_{GE}=\pm 15\text{ V}$, $I_C=400\text{ A}$,
 $T_j=125\text{ }^\circ\text{C}$, INDUCTIVE LOAD

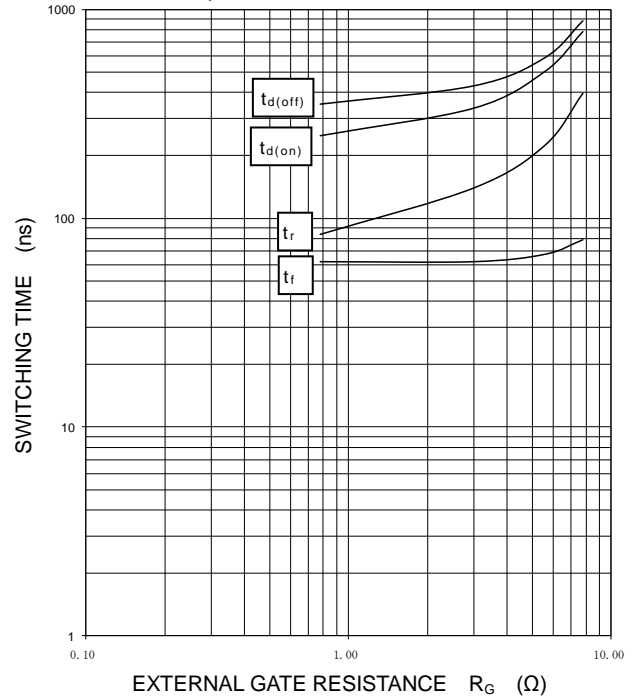

HALF-BRIDGE
SWITCHING CHARACTERISTICS
(TYPICAL)

$V_{CC}=600\text{ V}$, $V_{GE}=\pm 15\text{ V}$, $R_G=3.0\ \Omega$, $T_j=125\text{ }^\circ\text{C}$,
INDUCTIVE LOAD, PER PULSE

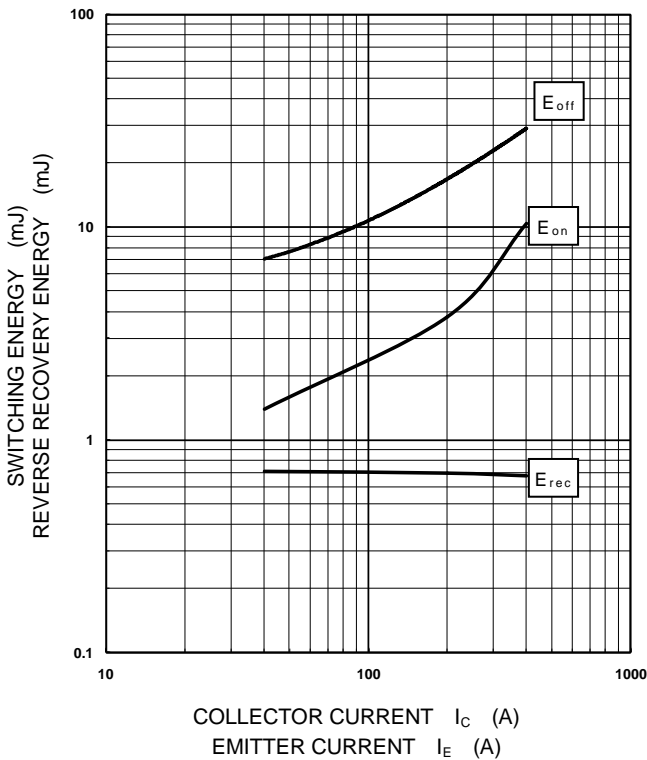

HALF-BRIDGE
SWITCHING CHARACTERISTICS
(TYPICAL)

$V_{CC}=600\text{ V}$, $V_{GE}=\pm 15\text{ V}$, $I_C/I_E=400\text{ A}$, $T_j=125\text{ }^\circ\text{C}$,
INDUCTIVE LOAD, PER PULSE

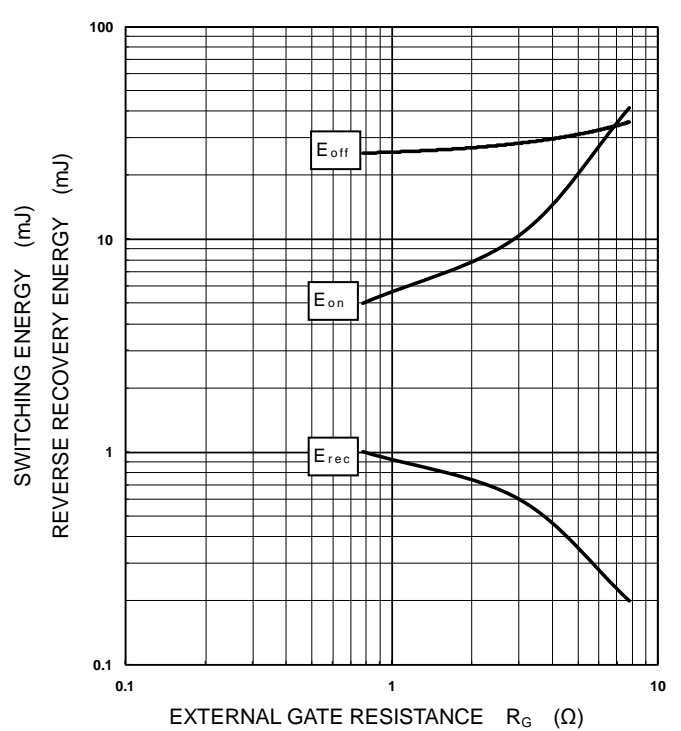

CMH400HC6-24NFM

HIGH POWER SWITCHING USE
INSULATED TYPE

PERFORMANCE CURVES

CAPACITANCE CHARACTERISTICS (TYPICAL)

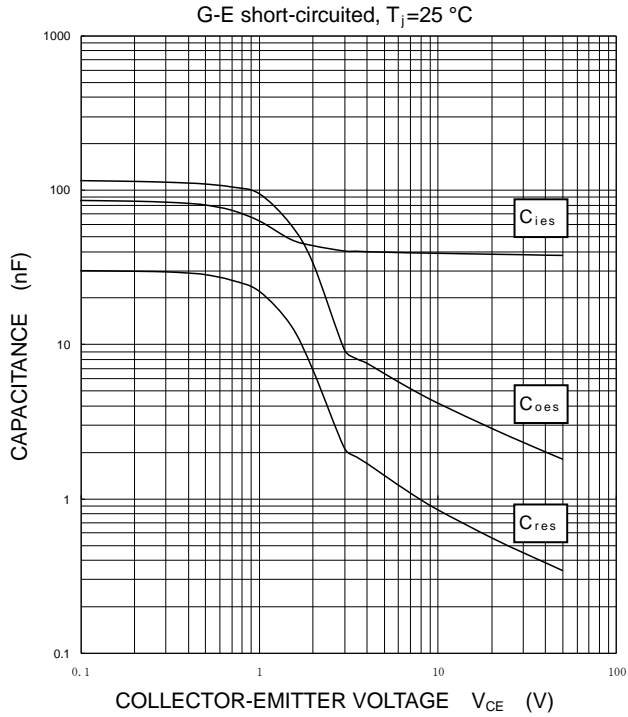

FREE WHEELING DIODE REVERSE RECOVERY CHARACTERISTICS (TYPICAL)

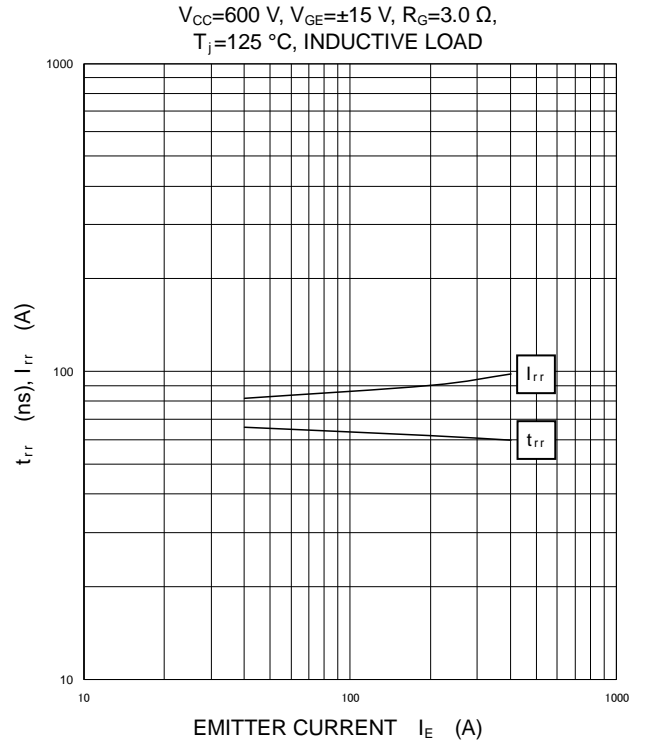

GATE CHARGE CHARACTERISTICS (TYPICAL)

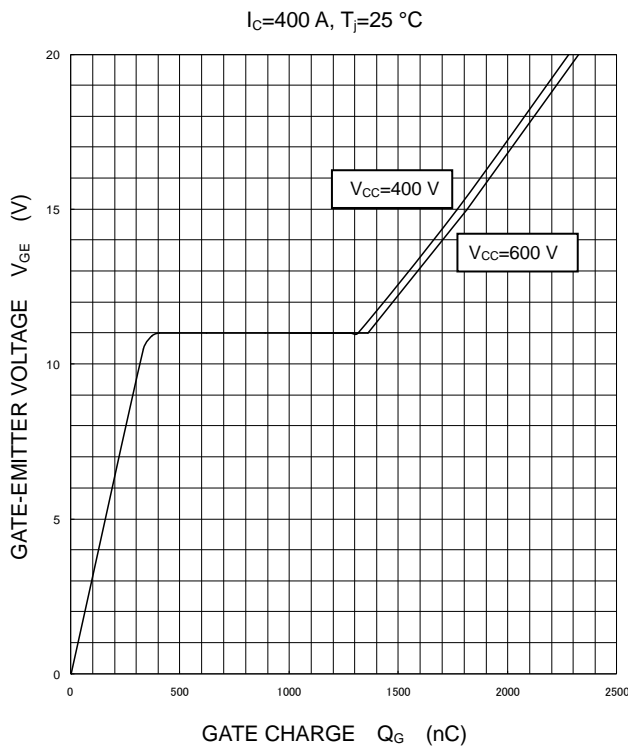

TRANSIENT THERMAL IMPEDANCE CHARACTERISTICS (MAXIMUM)

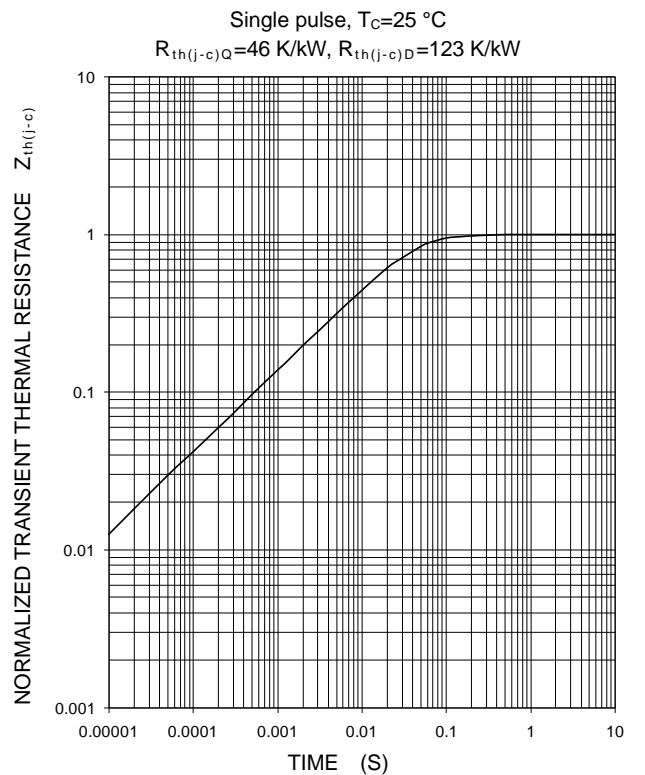

Note: The characteristics curves are presented for reference only and not guaranteed by production test, unless otherwise noted.

CMH400HC6-24NFM

HIGH POWER SWITCHING USE

INSULATED TYPE

Keep safety first in your circuit designs!

Mitsubishi Electric Corporation puts the maximum effort into making semiconductor products better and more reliable, but there is always the possibility that trouble may occur with them. Trouble with semiconductors may lead to personal injury, fire or property damage. Remember to give due consideration to safety when making your circuit designs, with appropriate measures such as (i) placement of substitutive, auxiliary circuits, (ii) use of non-flammable material or (iii) prevention against any malfunction or mishap.

Notes regarding these materials

- These materials are intended as a reference to assist our customers in the selection of the Mitsubishi semiconductor product best suited to the customer's application; they do not convey any license under any intellectual property rights, or any other rights, belonging to Mitsubishi Electric Corporation or a third party.
- Mitsubishi Electric Corporation assumes no responsibility for any damage, or infringement of any third-party's rights, originating in the use of any product data, diagrams, charts, programs, algorithms, or circuit application examples contained in these materials.
- All information contained in these materials, including product data, diagrams, charts, programs and algorithms represents information on products at the time of publication of these materials, and are subject to change by Mitsubishi Electric Corporation without notice due to product improvements or other reasons. It is therefore recommended that customers contact Mitsubishi Electric Corporation or an authorized Mitsubishi Semiconductor product distributor for the latest product information before purchasing a product listed herein.
The information described here may contain technical inaccuracies or typographical errors. Mitsubishi Electric Corporation assumes no responsibility for any damage, liability, or other loss rising from these inaccuracies or errors.
Please also pay attention to information published by Mitsubishi Electric Corporation by various means, including the Mitsubishi Semiconductor home page (www.MitsubishiElectric.com/semiconductors/).
- When using any or all of the information contained in these materials, including product data, diagrams, charts, programs, and algorithms, please be sure to evaluate all information as a total system before making a final decision on the applicability of the information and products. Mitsubishi Electric Corporation assumes no responsibility for any damage, liability or other loss resulting from the information contained herein.
- Mitsubishi Electric Corporation semiconductors are not designed or manufactured for use in a device or system that is used under circumstances in which human life is potentially at stake. Please contact Mitsubishi Electric Corporation or an authorized Mitsubishi Semiconductor product distributor when considering the use of a product contained herein for any specific purposes, such as apparatus or systems for transportation, vehicular, medical, aerospace, nuclear, or undersea repeater use.
- The prior written approval of Mitsubishi Electric Corporation is necessary to reprint or reproduce in whole or in part these materials.
- If these products or technologies are subject to the Japanese export control restrictions, they must be exported under a license from the Japanese government and cannot be imported into a country other than the approved destination.
Any diversion or reexport contrary to the export control laws and regulations of Japan and/or the country of destination is prohibited.
- Please contact Mitsubishi Electric Corporation or an authorized Mitsubishi Semiconductor product distributor for further details on these materials or the products contained therein.