

KD6R309AX3 Outline drawing

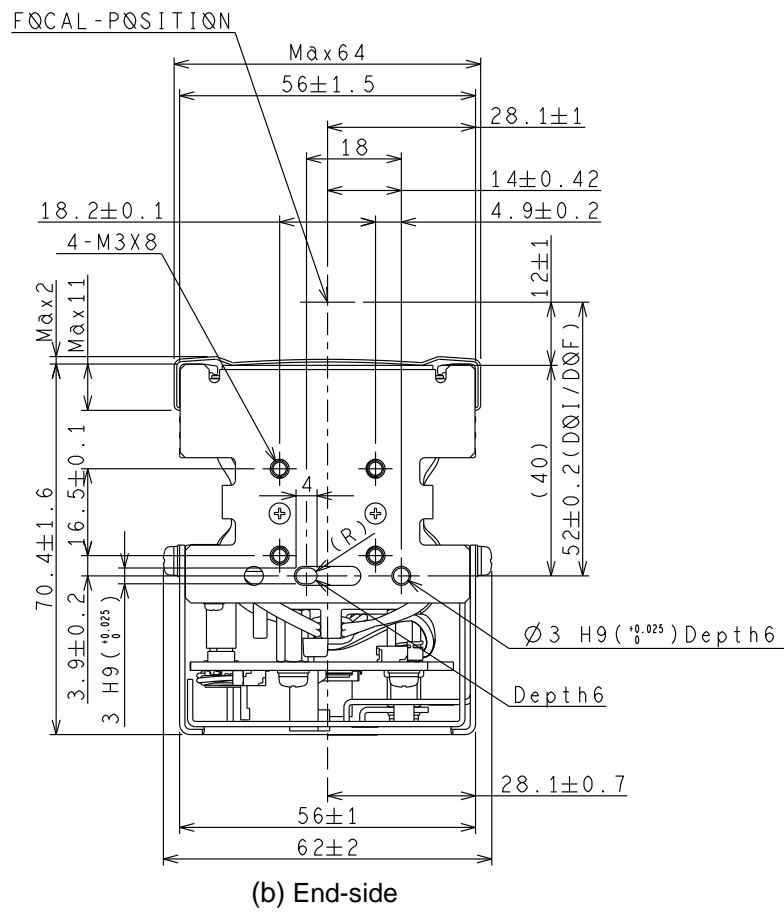
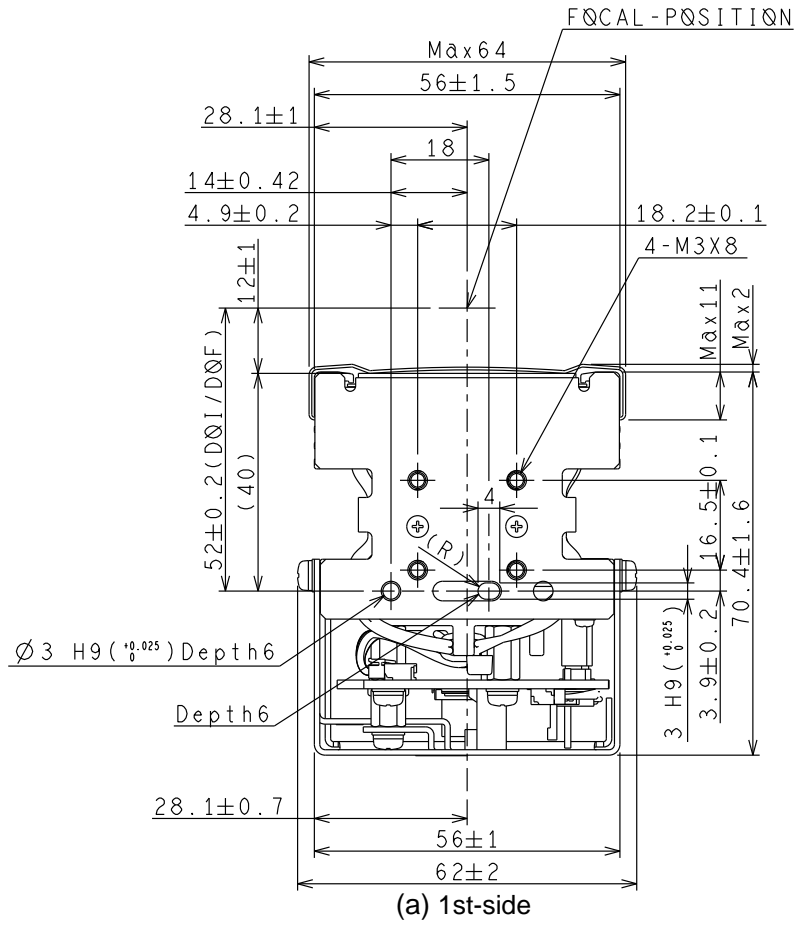

Side view (common mechanism to the illumination models)