

KD6R617MX Outline drawing

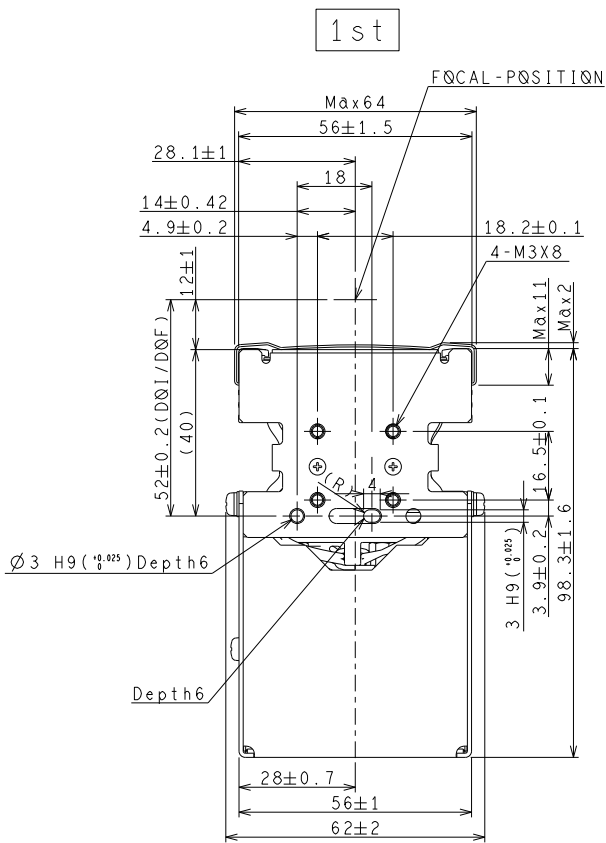

1st-side

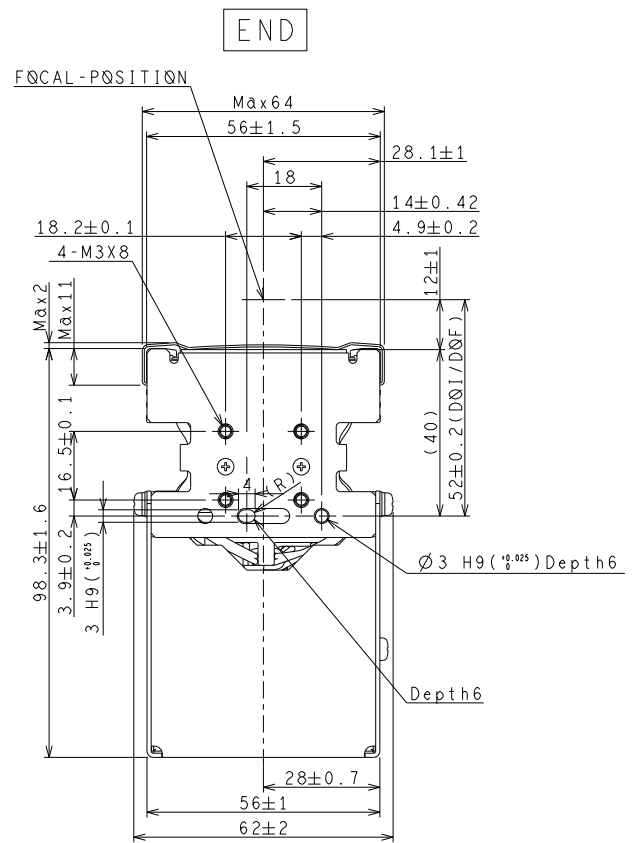

End-side

Side view (common mechanism)