

FACTORY AUTOMATION

Graphic Operation Terminal
GOT2000 Drive Control (Servo) Interactive Solutions

GOT Drive



MITSUBISHI GRAPHIC OPERATION TERMINAL

GOT2000

MITSUBISHI ELECTRIC SERVO SYSTEM

MELSERVO-J5

MITSUBISHI SERVO AMPLIFIERS & MOTORS

MELSERVO-J4

MITSUBISHI ELECTRIC SERVO SYSTEM

MELSERVO-JET

MITSUBISHI SERVO AMPLIFIERS & MOTORS

MELSERVO-JE



Automating the World



Our Factory Automation business is focused on "Automating the World" to make it a better, more sustainable environment supporting manufacturing and society, celebrating diversity and contributing towards an active and fulfilling role.

Mitsubishi Electric is involved in many areas including the following:

Energy and Electric Systems

A wide range of power and electrical products from generators to large-scale displays.

Electronic Devices

A wide portfolio of cutting-edge semiconductor devices for systems and products.

Home Appliance

Dependable consumer products like air conditioners and home entertainment systems.

Information and Communication Systems

Commercial and consumer-centric equipment, products and systems.

Industrial Automation Systems

Maximizing productivity and efficiency with cutting-edge automation technology.



The Mitsubishi Electric Group is actively solving social issues, such as decarbonization and labor shortages, by providing production sites with energy-saving equipment and solutions that utilize automation systems, thereby helping towards a sustainable society.

INDEX

1. GOT and servo system configurations	5
2. System configurations and supported models	10
3. Interactive functions list	22
4. Startup, adjustment	26
Parameter setting	26
Test operation	28
One-touch tuning function	29
Tuning function	30
Servo amplifier graph function (startup, adjustment)	31
FA transparent function	31
5. Maintenance	32
System launcher (servo network) function	32
Drive recorder function	33
Servo amplifier data analysis	33
Servo amplifier graph function (maintenance)	34
Backup/Restoration function	34
Monitor function	35
R motion monitor function/Q motion monitor function	36
R motion SFC monitor function/Q motion SFC monitor function	36
Motion program editor function	37
Servo amplifier monitor function	37
Intelligent module monitor function	38
Alarm display function	38
Encoder communication circuit diagnosis	39
Machine diagnosis (friction estimation, vibration estimation)	39
Machine diagnosis (tension estimation)	40
Machine diagnosis (total travel distance)	40
Gear Failure Diagnosis	41
Machine diagnosis function	42
Machine failure prediction function	43
Servo amplifier life diagnosis function	44
Switching axis numbers (station numbers) of servo amplifiers	44
6. Screen design	45
7. HMI lineup	46

GOT Drive Control (Servo) Interactive Solutions

1

GOT and servo system configurations

MITSUBISHI GRAPHIC OPERATION TERMINAL

GOT2000

GOT Drive

The GOT2000 provides advanced functionality and improves connectivity with Mitsubishi Electric servo systems. It provides some functions of MR Configurator2. The GOT Drive enhanced functionality is designed to eliminate need for additional hardware, software and suits customers' applications to speed up system startup, improve maintenance and troubleshooting.



GOT2000 Series
Drive Control
Interactive Solutions Movie



MITSUBISHI ELECTRIC SERVO SYSTEM
MELSERVO-J5



MITSUBISHI SERVO AMPLIFIERS & MOTORS
MELSERVO-J4



MITSUBISHI ELECTRIC SERVO SYSTEM
MELSERVO-JET



MITSUBISHI SERVO AMPLIFIERS & MOTORS
MELSERVO-JE



GOT and servo system configurations

MELSERVO-J5

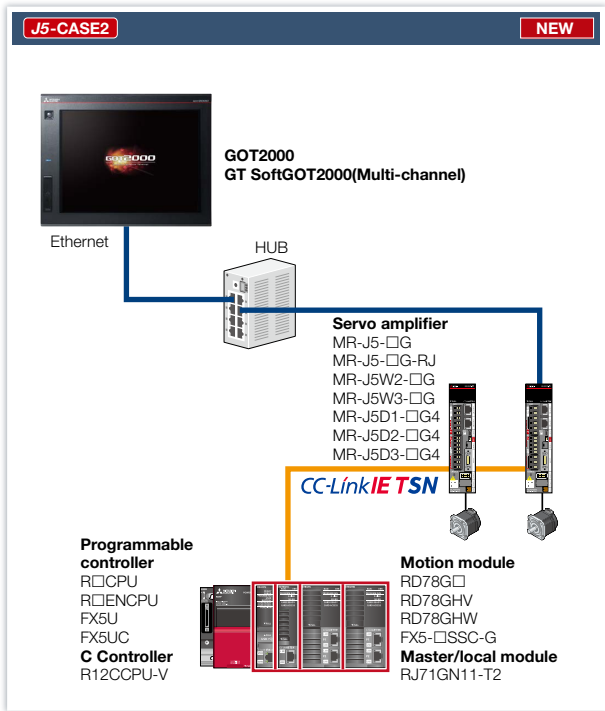
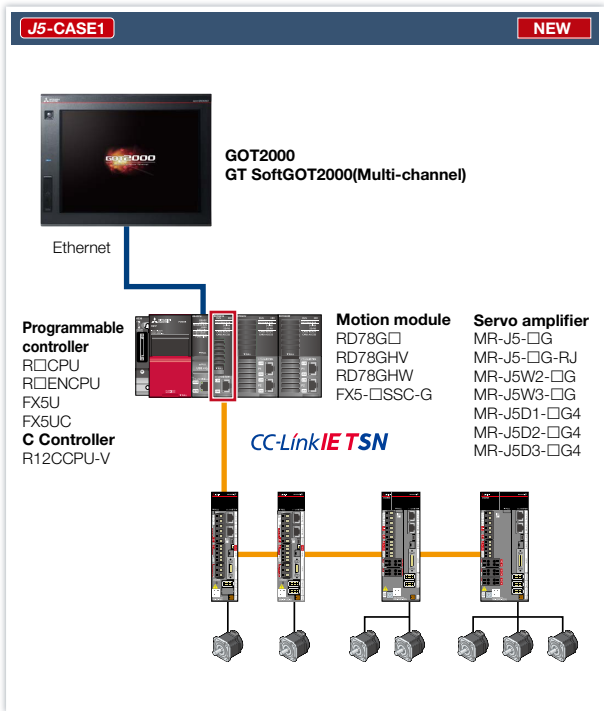

* Supported functions and specifications differ depending on controllers. For details, please refer to the relevant product manual.

System configuration continues on page 6 to 9 ➤➤➤

GOT and servo system configurations

MELSERVO-J5

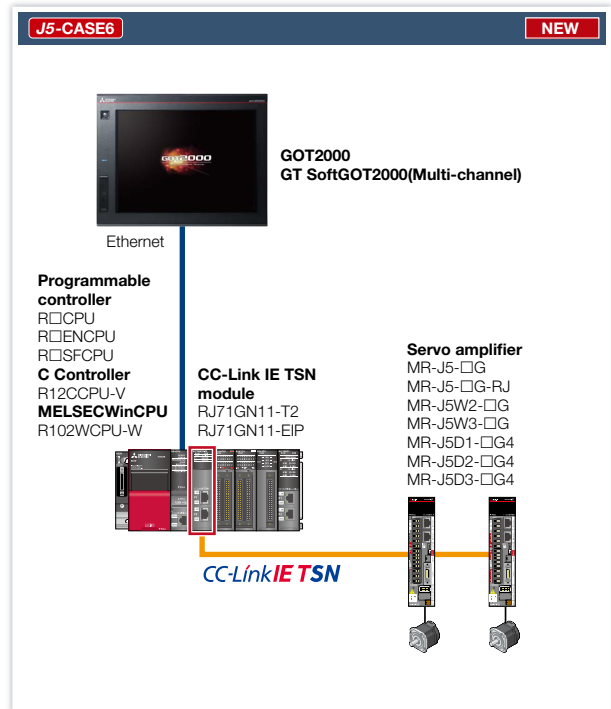
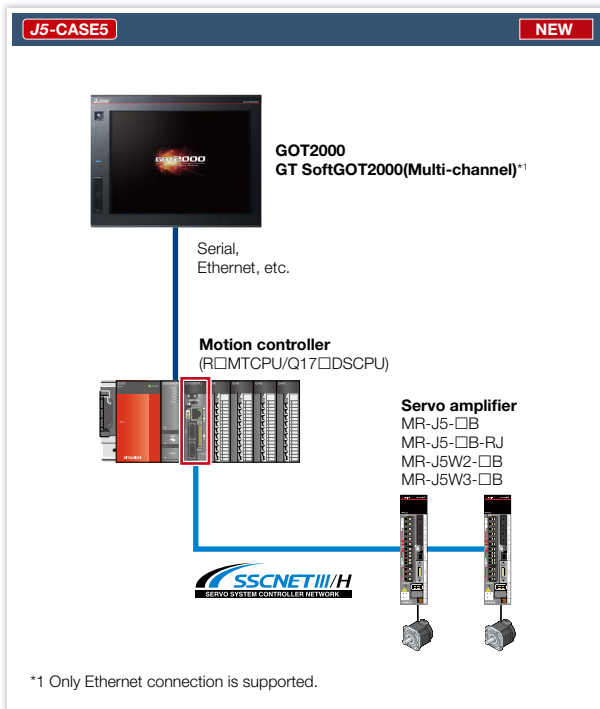
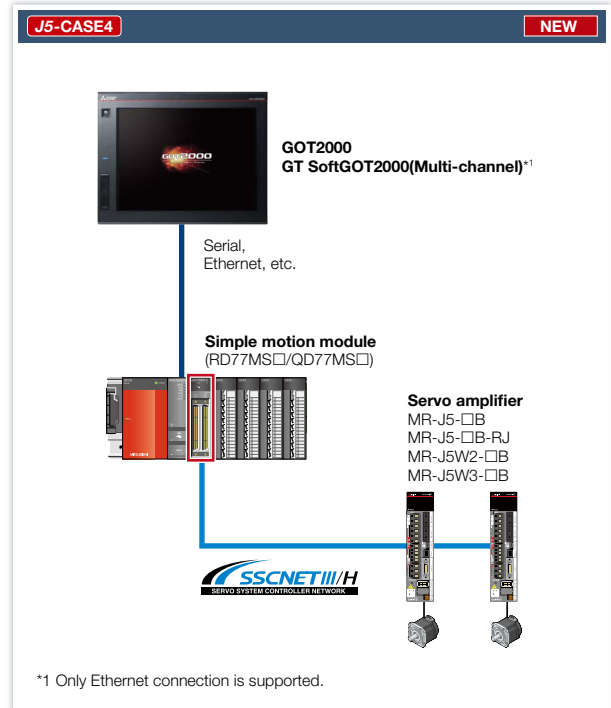
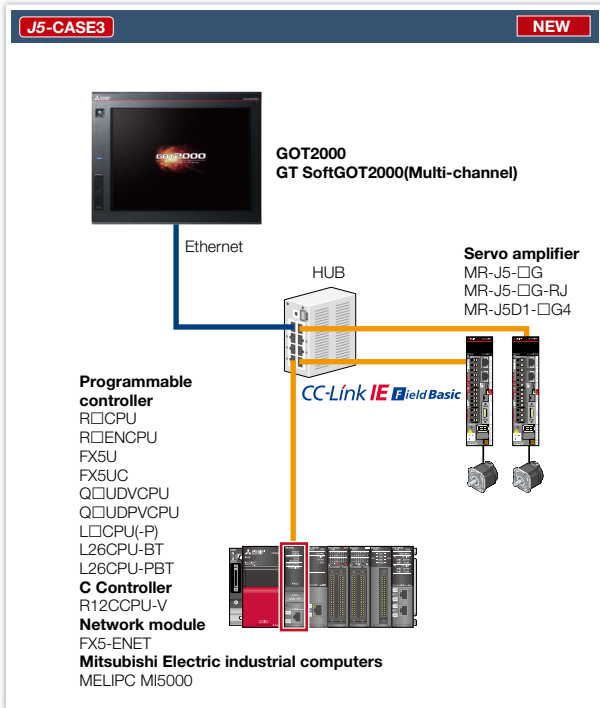

* Supported functions and specifications differ depending on controllers. For details, please refer to the relevant product manual.

GOT and servo system configurations

MELSERVO-J4

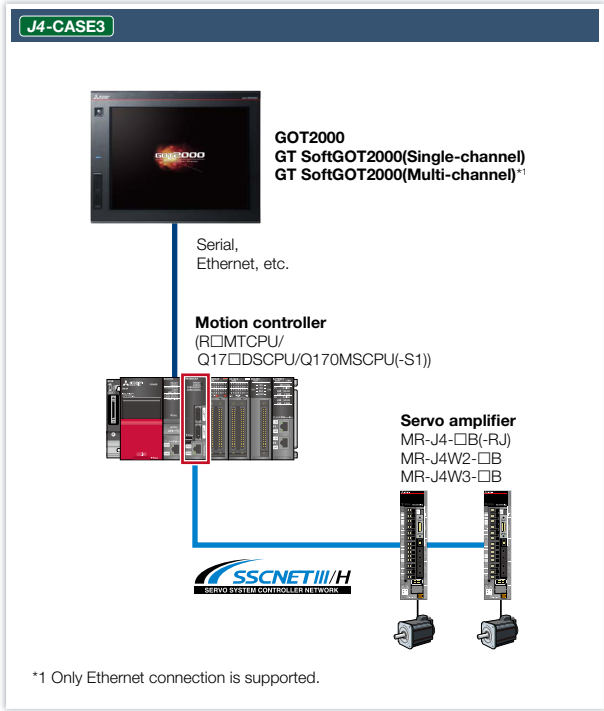
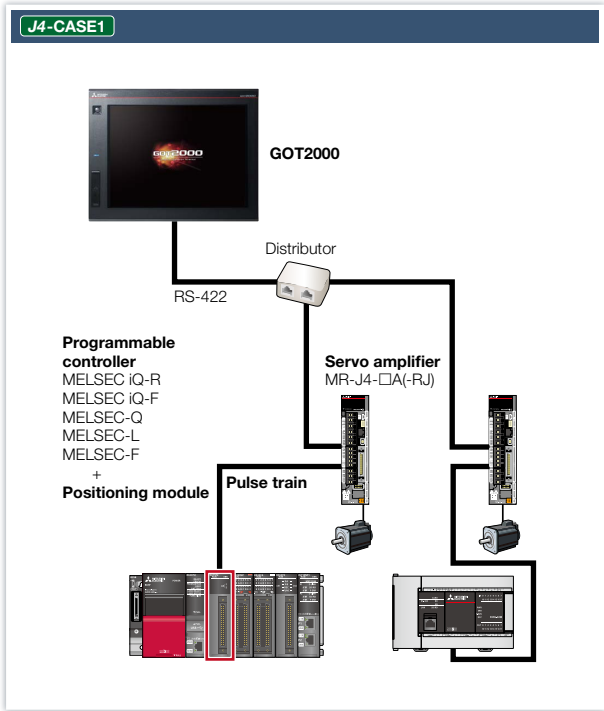

* Supported functions and specifications differ depending on controllers. For details, please refer to the relevant product manual.

■ GOT and servo system configurations

MELSERVO-JET

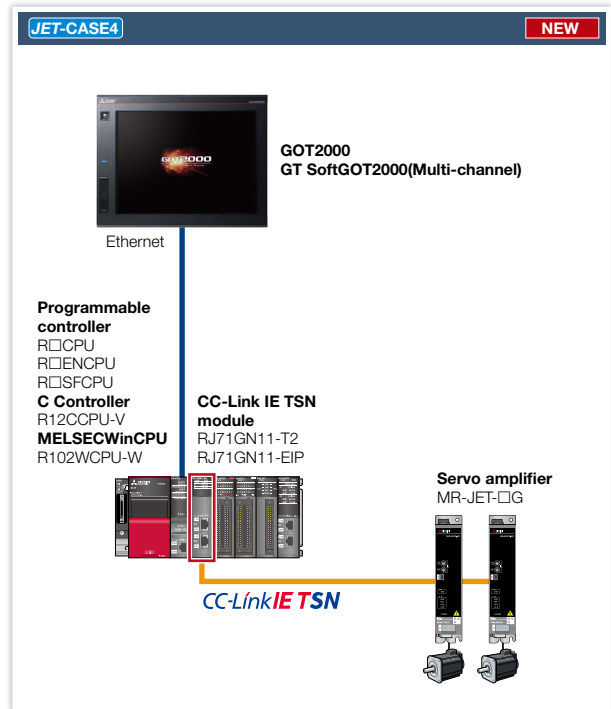
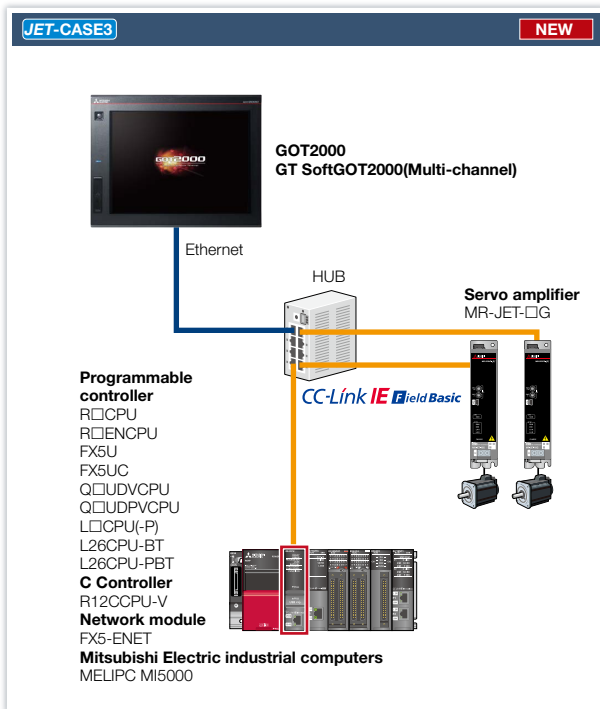
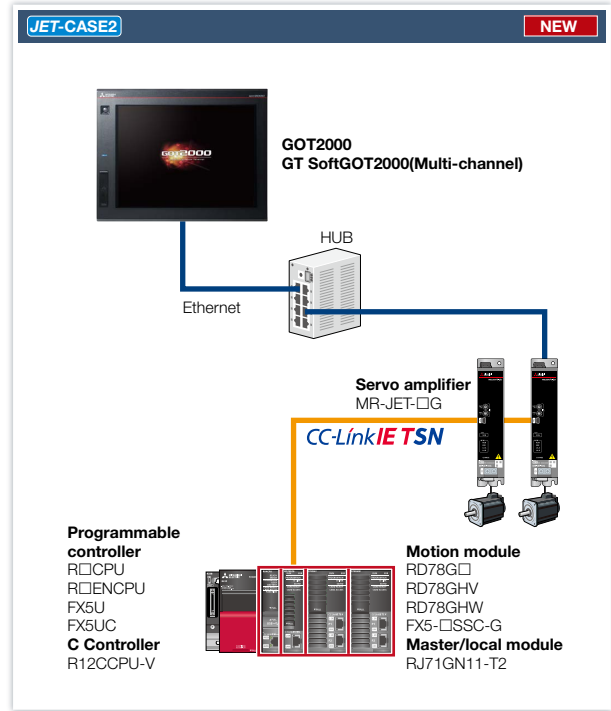
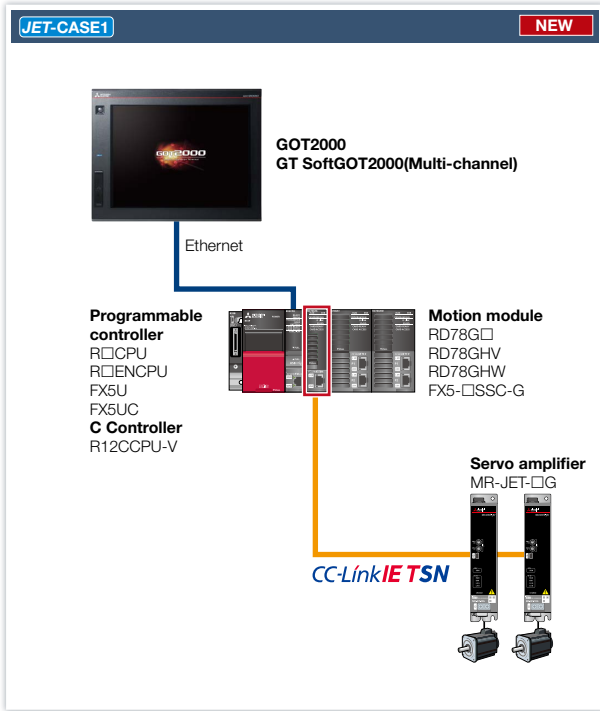

* Supported functions and specifications differ depending on controllers. For details, please refer to the relevant product manual.

GOT and servo system configurations

MELSERVO-JE

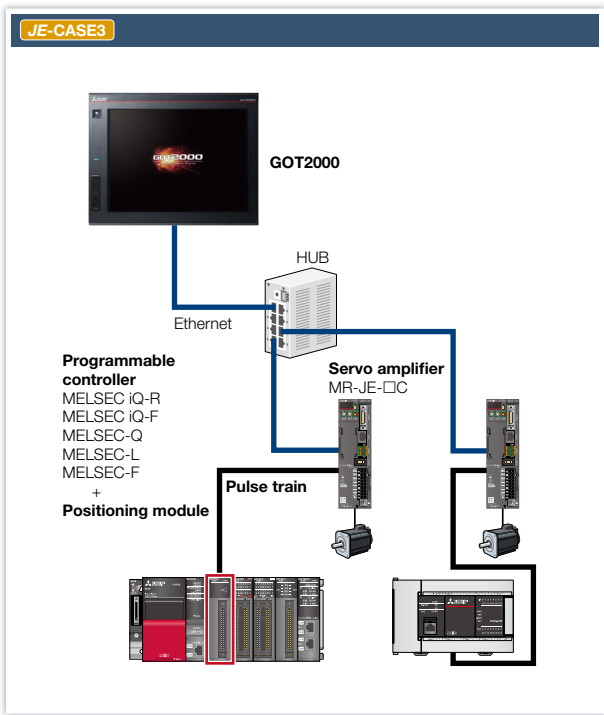
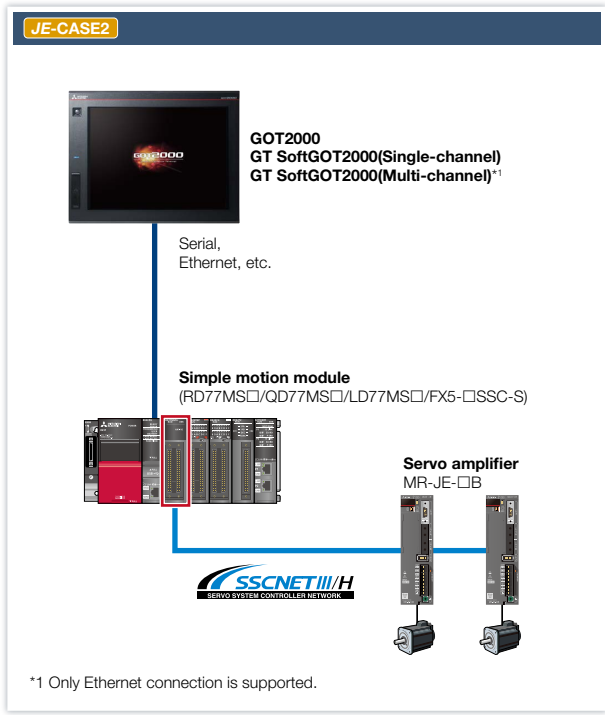
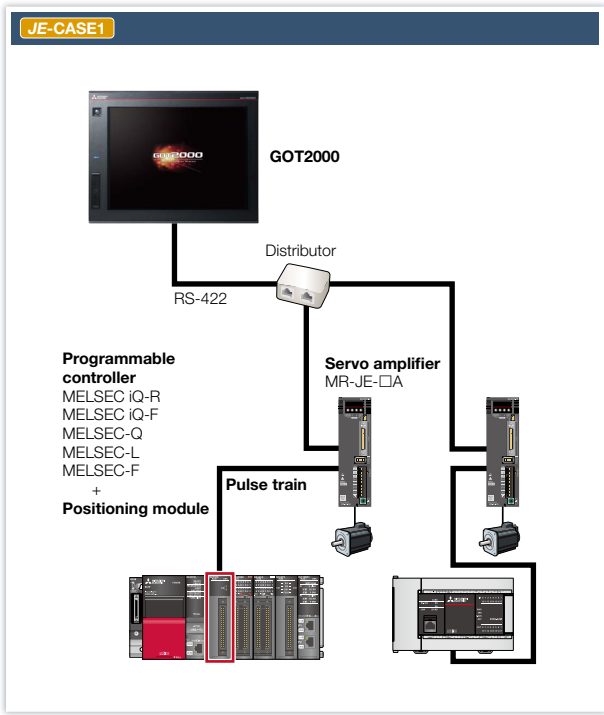

* Supported functions and specifications differ depending on controllers. For details, please refer to the relevant product manual.

System configurations and supported models

Supported GOT models and functions differ depending on the system configuration. Please refer to the following list.

Term Description

Term	Description
User-created screen	Without using the sample screen, you can freely arrange the parameters and information you want to display by numerical display, lamps, and other objects. The version of GT Works3 supported by the user-created screen differs depending on the system configuration.
Sample screen	Available for GT27**V (640 × 480), GT2104-R (480 × 272), and GS21**W-N (800×480) only. (As of January, 2024) The data can be used for GOTs with different resolutions by changing the GOT type. The version of GT Works3 supported by the sample screen differs depending on the system configuration.
Dedicated screen	This screen is provided as the extended function of GOT; therefore there is no need for the users to create the screen. The supported version of GT Works3 differs depending on connected devices and connection types.
FA transparent function	This function allows you to startup and adjust FA devices from a PC (Personal Computer) by connecting it to the GOT without the need for a direct connection between the FA devices and the PC. The supported version of GT Works3 differs depending on connected devices and connection types. For details, please refer to the GOT2000 Series Connection Manual.

GT27/GT25

●: Supported —: Not supported

CASE	System Configuration				Command interface	Controller/Servo amplifier	Name	Model type	User-created screen	Sample screen	Dedicated screen	FA transparent function
	Connection type	Name	Model type									
J5-CASE1 NEW	Ethernet	Programmable controller CPU+ Motion module	R□CPU/ R□ENCPU	RD78G□/ RD78GH□	CC-Link IE TSN	Servo amplifier	MR-J5-□G/MR-J5-□G-RJ/ MR-J5W2-□G/MR-J5W3-□G	●	●	●*4	—	
			FX5U/FX5UC	FX5-□SSC-G			MR-J5D1-□G4/MR-J5D2-□G4/ MR-J5D3-□G4	●	—	●*4	—	
			R12CCPU-V	RD78G□/ RD78GH□			MR-J5-□G/MR-J5-□G-RJ/ MR-J5W2-□G/MR-J5W3-□G	●	●*3	●*4	—	
							MR-J5D1-□G4/MR-J5D2-□G4/ MR-J5D3-□G4	●	—	●*4	—	
J5-CASE2 NEW	Ethernet	Servo amplifier	MR-J5-□G/MR-J5-□G-RJ/ MR-J5W2-□G/MR-J5W3-□G	CC-Link IE TSN	Programmable controller CPU+ Motion module	R□CPU/ R□ENCPU	RD78G□/ RD78GH□	●	●*3	—	—	
						FX5U/ FX5UC	FX5-□SSC-G	●	●*3	—	—	
						R□CPU/ R□ENCPU/ R12CCPU-V	RJ71GN11-T2	●	●*3	—	—	
						R□CPU/ R□ENCPU	RD78G□/ RD78GH□	●	—	—	—	
J5-CASE3 NEW	Ethernet	Servo amplifier	MR-J5-□G/MR-J5-□G-RJ	CC-Link IE Field Network Basic	Programmable controller CPU	R□CPU/R□ENCPU/ FX5U/FX5UC/ Q□UDVCPU/Q□UDPVCPU/ L□CPU(-P)/L26CPU-BT/L26CPU-PBT	●	●*3	—	—		
						C Controller (MELSEC iQ-R Series)	R12CCPU-V	●	●*3	—	—	
						Ethernet module (MELSEC iQ-F Series)	FX5-ENET	●	●*3	—	—	
						MELIPC	MI5122-VW	●	●*3	—	—	
J5-CASE4 NEW	Serial, Ethernet, etc.	Programmable controller CPU+ Simple Motion module	R□CPU	RD77MS□	SSCNET III/H	Servo amplifier	MR-J5-□B/MR-J5-□B-RJ/ MR-J5W2-□B/ MR-J5W3-□B	●	●*3	●*4	—	
			Q□CPU	QD77MS□			●	●	●*4	—		
			R□CPU	R□MTCPU			●	●*3	●*4	—		
			Q□CPU	Q17□DSCPU			●	●*3	●*4	—		
J5-CASE5 NEW	Serial, Ethernet, etc.	Programmable controller CPU+ Motion controller	R□CPU	R□MTCPU	SSCNET III/H	Servo amplifier	MR-J5-□B/MR-J5-□B-RJ/ MR-J5W2-□B/ MR-J5W3-□B	●	●*3	●*4	—	
			Q□CPU	Q17□DSCPU			●	●*3	●*4	—		
			R□CPU/ R□ENCPU/ R□SFCPU/ R12CCPU-V/ R102WCPU-W	RJ71GN11-T2			●	—	—	—		
			R□CPU/ R□ENCPU	RJ71GN11-EIP			●	—	—	—		
J5-CASE6 NEW	Ethernet	Programmable controller CPU+ CC-Link IE TSN module	R□CPU/ R□ENCPU/ R□SFCPU/ R12CCPU-V/ R102WCPU-W	RJ71GN11-T2	CC-Link IE TSN	Servo amplifier	MR-J5-□G/MR-J5-□G-RJ/ MR-J5W2-□G/MR-J5W3-□G/ MR-J5D1-□G4/MR-J5D2-□G4/ MR-J5D3-□G4	●	—	—	—	
			R□CPU/ R□ENCPU	RJ71GN11-EIP			●	—	—	—		

*3 The sample screen is set up based on a specific system configuration, such as the GOT being connected to a programmable controller CPU and the servo amplifier being controlled by a motion module. When using the sample screen, it is necessary to change the settings to match the actual system configuration. Please use the sample screen for GT27**V (640×480).

*4 The dedicated screen differs depending on the system configuration and the servo amplifier. For details, please refer to the GOT2000 Series Connection Manual (Mitsubishi Electric Products) and the GOT2000 Series User's Manual (Monitor).

Notes on sample screens

Depending on your system configuration (P.5-) and servo amplifier, there are cases where the sample screens may not be supported. In such cases, please refer to "User-created screen" on page 45. The sample screens are updated as necessary. The actual sample screens may be different from those in this catalog, and some function screens are not listed. If you wish to obtain the latest sample data, please contact your local sales office.

■GT27/GT25

●: Supported -: Not supported

System Configuration							User-created screen	Sample screen	Dedicated screen	FA transparent function	
CASE	Controllers connected directly to GOT and GT SoftGOT2000			Controller/Servo amplifier							
	Connection type	Name	Model type	Command interface	Name	Model type					
J4-CASE1	RS-422	Servo amplifier	MR-J4-□A/ MR-J4-□A-RJ	Pulse train (serial)	Programmable controller CPU+ Positioning module	MELSEC iQ-R Series Programmable controller CPU+ RD75D□, etc./ MELSEC iQ-F Series Programmable controller CPU (built-in positioning function)/ MELSEC iQ-F Series Programmable controller CPU+ FX5-20PG-P, etc./ MELSEC-Q Series Programmable controller CPU+ QD75D□/ MELSEC-L Series Programmable controller CPU+ LD75D□, etc./ MELSEC-F Series Programmable controller CPU (built-in positioning function)/ MELSEC-F Series Programmable controller CPU+ FX3U-1PG, etc.	●	●	●*1*4	-	
J4-CASE2	Serial, Ethernet, etc.	Programmable controller CPU+ Simple motion module	R□CPU	RD77MS□	SSCNET III/H	Servo amplifier	MR-J4-□B/ MR-J4-□B-RJ/ MR-J4W2-□B/ MR-J4W3-□B	●	●	●*4	-
			FX5CPU	FX5-□SSC-S			●	-	●*4	-	
			Q□CPU	QD77MS□			●	●*3	●*4	-	
			L□CPU	LD77MS□			●	-	●*4	-	
J4-CASE3	Serial, Ethernet, etc.	Programmable controller CPU+ Motion controller	R□CPU	R□MTCPU	SSCNET III/H	Servo amplifier	MR-J4-□B/ MR-J4-□B-RJ/ MR-J4W2-□B/ MR-J4W3-□B	●	●*3	●*4	●
			Q□CPU	Q17□DSCPU			●	●*3	●*4	●	
			Q□CPU	Q170MSCPU			●	-	●*4	●	
J4-CASE4	Serial, Ethernet, etc.	Programmable controller CPU+ CC-Link IE Field Network Simple Motion module	R□CPU	RD77GF□	CC-Link IE Field Network	Servo amplifier	MR-J4-□GF/ MR-J4-□GF-RJ	●	-	●*4	-
			Q□CPU	QD77GF□				●	-	●*4	-
		Programmable controller CPU+ CC-Link IE Field Network Master/local module	R□CPU	RJ71GF11-T2				●	-	●*4	-
			Q□CPU	QJ71GF11-T2				●	-	●*4	-
		L□CPU	LJ71GF11-T2	●				-	●*4	-	
		CC-Link IE built-in CPU module	R□ENCPU	●				-	●*4	-	
Programmable controller CPU+ CC-Link IE built-in Ethernet module	R□CPU	RJ71EN71	●	-	●*4	-					

*1 In case you use the "Intelligent module monitor function" in the dedicated screen, you need to add a wiring between the programmable controller and the GOT.

*3 The sample screen is set up based on a specific system configuration, such as the GOT being connected to a programmable controller CPU and the servo amplifier being controlled by a motion module. When using the sample screen, it is necessary to change the settings to match the actual system configuration. Please use the sample screen for GT27**V (640x480).

*4 The dedicated screen differs depending on the system configuration and the servo amplifier. For details, please refer to the GOT2000 Series Connection Manual (Mitsubishi Electric Products) and the GOT2000 Series User's Manual (Monitor).

GOT Drive Control (Servo) Interactive Solutions

2

System configurations and supported models

■GT27/GT25

●: Supported —: Not supported

System Configuration										User-created screen	Sample screen	Dedicated screen	FA transparent function
CASE	Controllers connected directly to GOT and GT SoftGOT2000				Controller/Servo amplifier								
	Connection type	Name	Model type		Command interface	Name	Model type						
JET-CASE1 NEW	Ethernet	Programmable controller CPU+ Motion module	R□CPU/ R□ENCPU	RD78G□/ RD78GH□	CC-Link IE TSN	Servo amplifier	MR-JET-□G		●	—	●*4	—	
			FX5U/ FX5UC	FX5-□SSC-S					●	—	●*4	—	
			R12CCPU-V	RD78G□/ RD78GH□					●	—	—	—	
JET-CASE2 NEW	Ethernet	Servo amplifier	MR-JET-□G		CC-Link IE TSN	Programmable controller CPU+ Motion module	R□CPU/ R□ENCPU	RD78G□/ RD78GH□	●	●*5	—	—	
						Programmable controller CPU+ CC-Link IE TSN Master/local module	FX5U/ FX5UC	FX5-□SSC-G	●	●*5	—	—	
JET-CASE3 NEW	Ethernet	Servo amplifier	MR-JET-□G		CC-Link IE Field Network Basic	Programmable controller CPU	R□CPU/R□ENCPU/ FX5U/FX5UC/ Q□UDVCPU/Q□UDVPCPU/ L□CPU(-)/L26CPU-BT/L26CPU-PBT		●	●*5	—	—	
						C Controller (MELSEC iQ-R Series)	R12CCPU-V		●	●*5	—	—	
						Ethernet module (MELSEC iQ-F Series)	FX5-ENET		●	●*5	—	—	
						MELIPC	MI5122-VW		●	●*5	—	—	
JET-CASE4 NEW	Ethernet	Programmable controller CPU+ CC-Link IE TSN module	R□CPU/ R□ENCPU/ R□SFCPU/ R12CCPU-V/ R102WCPU-W	RJ71GN11-T2	CC-Link IE TSN	Servo amplifier	MR-JET-□G		●	—	—	—	
			R□CPU/ R□ENCPU	RJ71GN11-EIP					●	—	—	—	
JE-CASE1	RS-422	Servo amplifier	MR-JE-□A		Pulse train (serial)	Programmable controller CPU+ Positioning module	MELSEC iQ-R Series Programmable controller CPU+ RD75D□, etc./ MELSEC iQ-F Series Programmable controller CPU (built-in positioning function)/ MELSEC iQ-F Series Programmable controller CPU+ FX5-20PG-P, etc./ MELSEC-Q Series Programmable controller CPU+ QD75D□/ MELSEC-L Series Programmable controller CPU+ LD75D□, etc./ MELSEC-F Series Programmable controller CPU (built-in positioning function)/ MELSEC-F Series Programmable controller CPU+ FX3U-1PG, etc.		●	—	●*1*4	—	
JE-CASE2	Serial, Ethernet, etc.	Programmable controller CPU+ Simple Motion module	R□CPU	RD77MS□	SSCNET III/H	Servo amplifier	MR-JE-□B		●	●*3	●*4	●	
			FX5CPU	FX5-□SSC-S					●	●	●*4	—	
			Q□CPU	QD77MS□					●	—	●*4	●	
			L□CPU	LD77MS□					●	—	●*4	●	
JE-CASE3	Ethernet	Servo amplifier	MR-JE-□C		Pulse train (serial)	Programmable controller CPU+ Positioning module	MELSEC iQ-R Series Programmable controller CPU+ RD75D□, etc./ MELSEC iQ-F Series Programmable controller CPU (built-in positioning function)/ MELSEC iQ-F Series Programmable controller CPU+ FX5-20PG-P, etc./ MELSEC-Q Series Programmable controller CPU+ QD75D□/ MELSEC-L Series Programmable controller CPU+ LD75D□, etc./ MELSEC-F Series Programmable controller CPU (built-in positioning function)/ MELSEC-F Series Programmable controller CPU+ FX3U-1PG, etc.		●	—	●	—	

*1 In case you use the "Intelligent module monitor function" in the dedicated screen, you need to add a wiring between the programmable controller and the GOT.
 *3 The sample screen is set up based on a specific system configuration, such as the GOT being connected to a programmable controller CPU and the servo amplifier being controlled by a motion module. When using the sample screen, it is necessary to change the settings to match the actual system configuration. Please use the sample screen for GT27**V (640×480).
 *4 The dedicated screen differs depending on the system configuration and the servo amplifier. For details, please refer to the GOT2000 Series Connection Manual (Mitsubishi Electric Products) and the GOT2000 Series User's Manual (Monitor).
 *5 The sample screen is set up based on a specific system configuration, such as the GOT being connected to a programmable controller CPU and the servo amplifier being controlled by a motion module. When using the sample screen, it is necessary to change the settings to match the actual system configuration. Please use the sample screen for GS21**-W-N (800×480).

Notes on sample screens

Depending on your system configuration (P.5-) and servo amplifier, there are cases where the sample screens may not be supported. In such cases, please refer to "User-created screen" on page 45. The sample screens are updated as necessary. The actual sample screens may be different from those in this catalog, and some function screens are not listed. If you wish to obtain the latest sample data, please contact your local sales office.

GT21

●: Supported —: Not supported

System Configuration										User-created screen	Sample screen	Dedicated screen	FA transparent function
CASE	Controllers connected directly to GOT and GT SoftGOT2000				Controller/Servo amplifier		Command interface	Name	Model type				
	Connection type	Name	Model type		Name	Model type							
J5-CASE1	Ethernet	Programmable controller CPU+ Motion module	R□CPU/ R□ENCPU	RD78G□/ RD78GH□	CC-Link IE TSN	Servo amplifier	MR-J5-□G/MR-J5-□G-RJ/ MR-J5W2-□G/MR-J5W3-□G	●	—	—	—		
			FX5U/FX5UC	FX5-□SSC-G			MR-J5D1-□G4/MR-J5D2-□G4/ MR-J5D3-□G4	●	—	—	—		
			R12CCPU-V	RD78G□/ RD78GH□			MR-J5-□G/MR-J5-□G-RJ/ MR-J5W2-□G/MR-J5W3-□G	●	—	—	—		
							MR-J5D1-□G4/MR-J5D2-□G4/ MR-J5D3-□G4	●	—	—	—		
J5-CASE2	Ethernet	Servo amplifier	MR-J5-□G/MR-J5-□G-RJ/ MR-J5W2-□G/MR-J5W3-□G		CC-Link IE TSN	Programmable controller CPU+ Motion module	R□CPU/ R□ENCPU	RD78G□/ RD78GH□	●	—	—	—	
			Programmable controller CPU+ CC-Link IE TSN Master/local module	R□CPU/ R□ENCPU/ R12CCPU-V		RJ71GN11-T2	●	—	—	—			
			Programmable controller CPU+ Motion module	R□CPU/ R□ENCPU		RD78G□/ RD78GH□	●	—	—	—			
			Programmable controller CPU+ CC-Link IE TSN Master/local module	R□CPU/ R□ENCPU/ R12CCPU-V		RJ71GN11-T2	●	—	—	—			
J5-CASE3	Ethernet	Servo amplifier	MR-J5-□G/MR-J5-□G-RJ		CC-Link IE Field Network Basic	Programmable controller CPU	R□CPU/R□ENCPU/ FX5U/FX5UC/ Q□UDVCPV/Q□UDPVCPV/ L□CPU(-P)/L26CPU-BT/L26CPU-PBT	●	—	—	—		
			C Controller (MELSEC iQ-R Series)	R12CCPU-V		●	—	—	—				
			Ethernet module (MELSEC iQ-F Series)	FX5-ENET		●	—	—	—				
			MELIPC	MI5122-VW		●	—	—	—				
			Programmable controller CPU	R□CPU/R□ENCPU/ FX5U/FX5UC/ Q□UDVCPV/Q□UDPVCPV/ L□CPU(-P)/L26CPU-BT/L26CPU-PBT		●	—	—	—				
			C Controller (MELSEC iQ-R Series)	R12CCPU-V		●	—	—	—				
J5-CASE4	Serial, Ethernet, etc.	Programmable controller CPU+ Simple Motion module	R□CPU	RD77MS□	SSCNET III/H	Servo amplifier	MR-J5-□B/MR-J5-□B-RJ/ MR-J5W2-□B/ MR-J5W3-□B	—	—	—	—		
			Q□CPU	QD77MS□			●	—	—	—			
J5-CASE5	Serial, Ethernet, etc.	Programmable controller CPU+ Motion controller	R□CPU	R□MTCPU	SSCNET III/H	Servo amplifier	MR-J5-□B/MR-J5-□B-RJ/ MR-J5W2-□B/ MR-J5W3-□B	—	—	—	—		
			Q□CPU	Q17□DSCPU			●	—	—	—			
J5-CASE6	Ethernet	Programmable controller CPU+ CC-Link IE TSN module	R□CPU/ R□ENCPU/ R□SFPCPU/ R12CCPU-V/ R102WCPU-W	RJ71GN11-T2	CC-Link IE TSN	Servo amplifier	MR-J5-□G/MR-J5-□G-RJ/ MR-J5W2-□G/MR-J5W3-□G/ MR-J5D1-□G4/MR-J5D2-□G4/ MR-J5D3-□G4	●	—	—	—		
			R□CPU/ R□ENCPU	RJ71GN11-EIP			●	—	—	—			

■ GT21

●: Supported -: Not supported

System Configuration							User-created screen	Sample screen	Dedicated screen	FA transparent function	
CASE	Controllers connected directly to GOT and GT SoftGOT2000			Controller/Servo amplifier							
	Connection type	Name	Model type		Command interface	Name	Model type				
J4-CASE1	RS-422	Servo amplifier	MR-J4-□A/ MR-J4-□A-RJ		Pulse train (serial)	Programmable controller CPU+ Positioning module	MELSEC iQ-R Series Programmable controller CPU+ RD75D□, etc./ MELSEC iQ-F Series Programmable controller CPU (built-in positioning function)/ MELSEC iQ-F Series Programmable controller CPU+ FX5-20PG-P, etc./ MELSEC-Q Series Programmable controller CPU+ QD75D□/ MELSEC-L Series Programmable controller CPU+ LD75D□, etc./ MELSEC-F Series Programmable controller CPU (built-in positioning function)/ MELSEC-F Series Programmable controller CPU+ FX3U-1PG, etc.	●	●	-	-
J4-CASE2	Serial, Ethernet, etc.	Programmable controller CPU+ Simple motion module	R□CPU	RD77MS□	SSCNET III/H	Servo amplifier	MR-J4-□B/ MR-J4-□B-RJ/ MR-J4W2-□B/ MR-J4W3-□B	●	●*6	-	-
			FX5CPU	FX5-□SSC-S				●	●	-	-
			Q□CPU	QD77MS□				●	-	-	-
			L□CPU	LD77MS□				●	-	-	-
J4-CASE3	Serial, Ethernet, etc.	Programmable controller CPU+ Motion controller	R□CPU	R□MTCPU	SSCNET III/H	Servo amplifier	MR-J4-□B/ MR-J4-□B-RJ/ MR-J4W2-□B/ MR-J4W3-□B	●	-	-	●*2
			Q□CPU	Q17□DSCPU				●	-	-	●*2
			Q□CPU	Q170MSCPU				●	-	-	●*2
J4-CASE4	Serial, Ethernet, etc.	Programmable controller CPU+ CC-Link IE Field Network Simple Motion module	R□CPU	RD77GF□	CC-Link IE Field Network	Servo amplifier	MR-J4-□GF/ MR-J4-□GF-RJ	●	-	-	-
			Q□CPU	QD77GF□				●	-	-	-
		Programmable controller CPU+ CC-Link IE Field Network Master/local module	R□CPU	RJ71GF11-T2				●	-	-	-
			Q□CPU	QJ71GF11-T2				●	-	-	-
		CC-Link IE built-in CPU module	L□CPU	LJ71GF11-T2				●	-	-	-
Programmable controller CPU+ CC-Link IE built-in Ethernet module	R□ENCPU		●	-	-	-					
		R□CPU	RJ71EN71				●	-	-	-	

*2 Cannot access or transfer data to servo amplifiers.

*6 The sample screen is set up based on a specific system configuration, such as the GOT being connected to a programmable controller CPU and the servo amplifier being controlled by a motion module. When using the sample screen, it is necessary to change the settings to match the actual system configuration. Please use the sample screen for GT2104-R (480×272).

Notes on sample screens

Depending on your system configuration (P.5-) and servo amplifier, there are cases where the sample screens may not be supported. In such cases, please refer to "User-created screen" on page 45. The sample screens are updated as necessary. The actual sample screens may be different from those in this catalog, and some function screens are not listed. If you wish to obtain the latest sample data, please contact your local sales office.

GT21

●: Supported -: Not supported

System Configuration										User-created screen	Sample screen	Dedicated screen	FA transparent function
CASE	Controllers connected directly to GOT and GT SoftGOT2000				Controller/Servo amplifier								
	Connection type	Name	Model type		Command interface	Name	Model type						
JET-CASE1 NEW	Ethernet	Programmable controller CPU+ Motion module	R□CPU/ R□ENCPU	RD78G□/ RD78GH□	CC-Link IE TSN	Servo amplifier	MR-JET-□G		●	-	-	-	
			FX5U/ FX5UC	FX5-□SSC-S					●	-	-	-	
			R12CCPU-V	RD78G□/ RD78GH□					●	-	-	-	
JET-CASE2 NEW	Ethernet	Servo amplifier	MR-JET-□G		CC-Link IE TSN	Programmable controller CPU+ Motion module	R□CPU/ R□ENCPU	RD78G□/ RD78GH□	●	●*5	-	-	
							FX5U/ FX5UC	FX5-□SSC-G	●	●*5	-	-	
							R□CPU/ R□ENCPU/ R12CCPU-V	RJ71GN11-T2	●	●*5	-	-	
JET-CASE3 NEW	Ethernet	Servo amplifier	MR-JET-□G		CC-Link IE Field Network Basic	Programmable controller CPU	R□CPU/R□ENCPU/ FX5U/FX5UC/ Q□UDVCPV/Q□UDPVCPU/ L□CPU-(P)/L26CPU-BT/L26CPU-PBT		●	●*5	-	-	
							C Controller (MELSEC iQ-R Series)	R12CCPU-V	●	●*5	-	-	
								Ethernet module (MELSEC iQ-F Series)	FX5-ENET	●	●*5	-	-
									MELIPC	MI5122-VW	●	●*5	-
JET-CASE4 NEW	Ethernet	Programmable controller CPU+ CC-Link IE TSN module	R□CPU/ R□ENCPU/ R□SFCPU/ R12CCPU-V/ R102WCPV-W	RJ71GN11-T2	CC-Link IE TSN	Servo amplifier	MR-JET-□G		●	-	-	-	
			R□CPU/ R□ENCPU	RJ71GN11-EIP					●	-	-	-	
JE-CASE1	RS-422	Servo amplifier	MR-JE-□A		Pulse train (serial)	Programmable controller CPU+ Positioning module	MELSEC iQ-R Series Programmable controller CPU+ RD75D□, etc./ MELSEC iQ-F Series Programmable controller CPU (built-in positioning function)/ MELSEC iQ-F Series Programmable controller CPU+ FX5-20PG-P, etc./ MELSEC-Q Series Programmable controller CPU+ QD75D□/ MELSEC-L Series Programmable controller CPU+ LD75D□, etc./ MELSEC-F Series Programmable controller CPU (built-in positioning function)/ MELSEC-F Series Programmable controller CPU+ FX3U-1PG, etc.		●	-	-	-	
JE-CASE2	Serial, Ethernet, etc.	Programmable controller CPU+ Simple Motion module	R□CPU	RD77MS□	SSCNET III/H	Servo amplifier	MR-JE-□B		●	-	-	-	
			FX5CPU	FX5-□SSC-S					●	-	-	-	
			Q□CPU	QD77MS□					●	-	-	-	
			L□CPU	LD77MS□					●	-	-	-	
JE-CASE3	Ethernet	Servo amplifier	MR-JE-□C		Pulse train (serial)	Programmable controller CPU+ Positioning module	MELSEC iQ-R Series Programmable controller CPU+ RD75D□, etc./ MELSEC iQ-F Series Programmable controller CPU (built-in positioning function)/ MELSEC iQ-F Series Programmable controller CPU+ FX5-20PG-P, etc./ MELSEC-Q Series Programmable controller CPU+ QD75D□/ MELSEC-L Series Programmable controller CPU+ LD75D□, etc./ MELSEC-F Series Programmable controller CPU (built-in positioning function)/ MELSEC-F Series Programmable controller CPU+ FX3U-1PG, etc.		●	-	-	-	

*5 The sample screen is set up based on a specific system configuration, such as the GOT being connected to a programmable controller CPU and the servo amplifier being controlled by a motion module. When using the sample screen, it is necessary to change the settings to match the actual system configuration. Please use the sample screen for GS21**-W-N (800x480).

GOT Drive Control (Servo) Interactive Solutions

2

System configurations and supported models

■ GOT SoftGOT2000 (single-channel connection)

●: Supported -: Not supported

System Configuration							User-created screen	Sample screen	Dedicated screen	FA transparent function		
CASE	Connection type	Name	Model type		Command interface	Controller/Servo amplifier						
J5-CASE1	Ethernet	Programmable controller CPU+ Motion module	R□CPU/ R□ENCPU	RD78G□/ RD78GH□	CC-Link IE TSN	Servo amplifier	MR-J5-□G/MR-J5-□G-RJ/ MR-J5W2-□G/MR-J5W3-□G	-	-	-	-	
			FX5U/FX5UC	FX5-□SSC-G			MR-J5D1-□G4/MR-J5D2-□G4/ MR-J5D3-□G4	-	-	-	-	
			R12CCPU-V	RD78G□/ RD78GH□			MR-J5-□G/MR-J5-□G-RJ/ MR-J5W2-□G/MR-J5W3-□G	-	-	-	-	
							MR-J5D1-□G4/MR-J5D2-□G4/ MR-J5D3-□G4	-	-	-	-	
J5-CASE2	Ethernet	Servo amplifier	MR-J5-□G/MR-J5-□G-RJ/ MR-J5W2-□G/MR-J5W3-□G		CC-Link IE TSN	Programmable controller CPU+ Motion module	R□CPU/ R□ENCPU	RD78G□/ RD78GH□	-	-	-	-
			FX5U/ FX5UC	FX5-□SSC-G			MR-J5D1-□G4/MR-J5D2-□G4/ MR-J5D3-□G4	-	-	-	-	
			R□CPU/ R□ENCPU/ R12CCPU-V	RJ71GN11-T2			MR-J5-□G/MR-J5-□G-RJ/ MR-J5W2-□G/MR-J5W3-□G	-	-	-	-	
			R□CPU/ R□ENCPU/ R12CCPU-V	RJ71GN11-T2			MR-J5D1-□G4/MR-J5D2-□G4/ MR-J5D3-□G4	-	-	-	-	
J5-CASE3	Ethernet	Servo amplifier	MR-J5-□G/MR-J5-□G-RJ		CC-Link IE Field Network Basic	Programmable controller CPU	R□CPU/R□ENCPU/ FX5U/FX5UC/ Q□UDVCPU/Q□UDPVCPU/ L□CPU(-P)/L26CPU-BT/L26CPU-PBT	-	-	-	-	
			R12CCPU-V	C Controller (MELSEC iQ-R Series)			-	-	-	-		
			FX5-ENET	Ethernet module (MELSEC iQ-F Series)			-	-	-	-		
			MI5122-VW	MELIPC			-	-	-	-		
			R□CPU/R□ENCPU/ FX5U/FX5UC/ Q□UDVCPU/Q□UDPVCPU/ L□CPU(-P)/L26CPU-BT/L26CPU-PBT	Programmable controller CPU			-	-	-	-		
			R12CCPU-V	C Controller (MELSEC iQ-R Series)			-	-	-	-		
FX5-ENET	Ethernet module (MELSEC iQ-F Series)	-	-	-	-							
		MI5122-VW	MELIPC	-	-	-	-					
J5-CASE4	Ethernet	Programmable controller CPU+ Simple Motion module	R□CPU	RD77MS□	SSCNET III/H	Servo amplifier	MR-J5-□B/MR-J5-□B-RJ/ MR-J5W2-□B/ MR-J5W3-□B	-	-	-	-	
		Q□CPU	QD77MS□									
J5-CASE5	Ethernet	Programmable controller CPU+ Motion controller	R□CPU	R□MTCPU	SSCNET III/H	Servo amplifier	MR-J5-□B/MR-J5-□B-RJ/ MR-J5W2-□B/ MR-J5W3-□B	-	-	-	-	
		Q□CPU	Q17□DSCPU									
J5-CASE6	Ethernet	Programmable controller CPU+ CC-Link IE TSN module	R□CPU/ R□ENCPU/ R□SFCPU/ R12CCPU-V/ R102WCPW-W	RJ71GN11-T2	CC-Link IE TSN	Servo amplifier	MR-J5-□G/MR-J5-□G-RJ/ MR-J5W2-□G/MR-J5W3-□G/ MR-J5D1-□G4/MR-J5D2-□G4/ MR-J5D3-□G4	-	-	-	-	
			R□CPU/ R□ENCPU	RJ71GN11-EIP								

Notes on sample screens

Depending on your system configuration (P.5-) and servo amplifier, there are cases where the sample screens may not be supported. In such cases, please refer to "User-created screen" on page 45. The sample screens are updated as necessary. The actual sample screens may be different from those in this catalog, and some function screens are not listed. If you wish to obtain the latest sample data, please contact your local sales office.

■ GOT SoftGOT2000 (single-channel connection)

●: Supported -: Not supported

System Configuration							User-created screen	Sample screen	Dedicated screen	FA transparent function	
CASE	Controllers connected directly to GOT and GT SoftGOT2000			Controller/Servo amplifier							
	Connection type	Name	Model type		Command interface	Name	Model type				
J4-CASE1	RS-422	Servo amplifier	MR-J4-□A/ MR-J4-□A-RJ		Pulse train (serial)	Programmable controller CPU+ Positioning module	MELSEC iQ-R Series Programmable controller CPU+ RD75D□, etc./ MELSEC iQ-F Series Programmable controller CPU (built-in positioning function)/ MELSEC iQ-F Series Programmable controller CPU+ FX5-20PG-P, etc./ MELSEC-Q Series Programmable controller CPU+ QD75D□/ MELSEC-L Series Programmable controller CPU+ LD75D□, etc./ MELSEC-F Series Programmable controller CPU (built-in positioning function)/ MELSEC-F Series Programmable controller CPU+ FX3U-1PG, etc.	-	-	-	-
J4-CASE2	Serial, Ethernet, etc.	Programmable controller CPU+ Simple motion module	R□CPU	RD77MS□	SSCNET III/H	Servo amplifier	MR-J4-□B/ MR-J4-□B-RJ/ MR-J4W2-□B/ MR-J4W3-□B	●	-	-	-
			FX5CPU	FX5-□SSC-S				●	-	-	-
			Q□CPU	QD77MS□				-	-	-	-
			L□CPU	LD77MS□				-	-	-	-
J4-CASE3	Serial, Ethernet, etc.	Programmable controller CPU+ Motion controller	R□CPU	R□MTCPU	SSCNET III/H	Servo amplifier	MR-J4-□B/ MR-J4-□B-RJ/ MR-J4W2-□B/ MR-J4W3-□B	●	-	-	-
			Q□CPU	Q17□DSCPU				-	-	-	-
			Q□CPU	Q170MSCPU				-	-	-	-
J4-CASE4	Ethernet	Programmable controller CPU+ CC-Link IE Field Network Simple Motion module	R□CPU	RD77GF□	CC-Link IE Field Network	Servo amplifier	MR-J4-□GF/ MR-J4-□GF-RJ	-	-	-	-
			Q□CPU	QD77GF□				-	-	-	-
		Programmable controller CPU+ CC-Link IE Field Network Master/local module	R□CPU	RJ71GF11-T2				-	-	-	-
			Q□CPU	QJ71GF11-T2				-	-	-	-
		CC-Link IE built-in CPU module	L□CPU	LJ71GF11-T2				-	-	-	-
Programmable controller CPU+ CC-Link IE built-in Ethernet module	R□ENCPU		-	-	-	-					
	R□CPU	RJ71EN71	-	-	-	-					

GOT Drive Control (Servo) Interactive Solutions

2

System configurations and supported models

■ GOT SoftGOT2000 (single-channel connection)

●: Supported -: Not supported

System Configuration							User-created screen	Sample screen	Dedicated screen	FA transparent function		
CASE	Connection type	Name	Model type		Command interface	Controller/Servo amplifier						
JET-CASE1	Ethernet	Programmable controller CPU+ Motion module	R□CPU/ R□ENCPU	RD78G□/ RD78GH□	CC-Link IE TSN	Servo amplifier	MR-JET-□G	-	-	-	-	
			FX5U/ FX5UC	FX5-□SSC-S				-	-	-	-	
			R12CCPU-V	RD78G□/ RD78GH□				-	-	-	-	
JET-CASE2	Ethernet	Servo amplifier	MR-JET-□G		CC-Link IE TSN	Programmable controller CPU+ Motion module	R□CPU/ R□ENCPU	RD78G□/ RD78GH□	-	-	-	-
							FX5U/ FX5UC	FX5-□SSC-G	-	-	-	-
JET-CASE3	Ethernet	Servo amplifier	MR-JET-□G		CC-Link IE Field Network Basic	Programmable controller CPU	R□CPU/R□ENCPU/ FX5U/FX5UC/ Q□UDVCPU/Q□UDPVCPU/ L□CPU(-P)/L26CPU-BT/L26CPU-PBT		-	-	-	-
							C Controller (MELSEC iQ-R Series)	R12CCPU-V	-	-	-	-
							Ethernet module (MELSEC iQ-F Series)	FX5-ENET	-	-	-	-
							MELIPC	MI5122-VW	-	-	-	-
JET-CASE4	Ethernet	Programmable controller CPU+ CC-Link IE TSN module	R□CPU/ R□ENCPU/ R□SFCPU/ R12CCPU-V/ R102WCPW-W	RJ71GN11-T2	CC-Link IE TSN	Servo amplifier	MR-JET-□G	-	-	-	-	
			R□CPU/ R□ENCPU	RJ71GN11-EIP				-	-	-	-	
JE-CASE1	RS-422	Servo amplifier	MR-JE-□A		Pulse train (serial)	Programmable controller CPU+ Positioning module	MELSEC iQ-R Series Programmable controller CPU+ RD75D□, etc./ MELSEC iQ-F Series Programmable controller CPU (built-in positioning function)/ MELSEC iQ-F Series Programmable controller CPU+ FX5-20PG-P, etc./ MELSEC-Q Series Programmable controller CPU+ QD75D□/ MELSEC-L Series Programmable controller CPU+ LD75D□, etc./ MELSEC-F Series Programmable controller CPU (built-in positioning function)/ MELSEC-F Series Programmable controller CPU+ FX3U-1PG, etc.	-	-	-	-	
JE-CASE2	Serial, Ethernet, etc.	Programmable controller CPU+ Simple Motion module	R□CPU	RD77MS□	SSCNET III/H	Servo amplifier	MR-JE-□B	●	-	-	-	
			FX5CPU	FX5-□SSC-S				●	-	-	-	
			Q□CPU	QD77MS□				-	-	-	-	
			L□CPU	LD77MS□				-	-	-	-	
JE-CASE3	Ethernet	Servo amplifier	MR-JE-□C		Pulse train (serial)	Programmable controller CPU+ Positioning module	MELSEC iQ-R Series Programmable controller CPU+ RD75D□, etc./ MELSEC iQ-F Series Programmable controller CPU (built-in positioning function)/ MELSEC iQ-F Series Programmable controller CPU+ FX5-20PG-P, etc./ MELSEC-Q Series Programmable controller CPU+ QD75D□/ MELSEC-L Series Programmable controller CPU+ LD75D□, etc./ MELSEC-F Series Programmable controller CPU (built-in positioning function)/ MELSEC-F Series Programmable controller CPU+ FX3U-1PG, etc.	-	-	-	-	

Notes on sample screens

Depending on your system configuration (P.5-) and servo amplifier, there are cases where the sample screens may not be supported. In such cases, please refer to "User-created screen" on page 45. The sample screens are updated as necessary. The actual sample screens may be different from those in this catalog, and some function screens are not listed. If you wish to obtain the latest sample data, please contact your local sales office.

GOT SoftGOT2000 (multi-channel connection) NEW

●: Supported -: Not supported

CASE	System Configuration				Command interface	Controller/Servo amplifier		User-created screen	Sample screen	Dedicated screen	FA transparent function	
	Connection type	Name	Model type			Name	Model type					
J5-CASE1	Ethernet	Programmable controller CPU+ Motion module	R□CPU/ R□ENCPU	RD78G□/ RD78GH□	CC-Link IE TSN	Servo amplifier	MR-J5-□G/MR-J5-□G-RJ/ MR-J5W2-□G/MR-J5W3-□G	●	●*3	●*4	-	
			FX5U/FX5UC	FX5-□SSC-G			MR-J5D1-□G4/MR-J5D2-□G4/ MR-J5D3-□G4	●	-	●*4	-	
							MR-J5-□G/MR-J5-□G-RJ/ MR-J5W2-□G/MR-J5W3-□G	●	●*3	●*4	-	
			R12CCPU-V	RD78G□/ RD78GH□			MR-J5D1-□G4/MR-J5D2-□G4/ MR-J5D3-□G4	●	-	●*4	-	
J5-CASE2	Ethernet	Servo amplifier	MR-J5-□G/MR-J5-□G-RJ/ MR-J5W2-□G/MR-J5W3-□G		CC-Link IE TSN	Programmable controller CPU+ Motion module	R□CPU/ R□ENCPU	RD78G□/ RD78GH□	●	-	-	-
			Programmable controller CPU+ CC-Link IE TSN Master/local module	R□CPU/ R□ENCPU/ R12CCPU-V		RJ71GN11-T2	●	-	-	-		
			Programmable controller CPU+ Motion module	R□CPU/ R□ENCPU		RD78G□/ RD78GH□	●	-	-	-		
			Programmable controller CPU+ CC-Link IE TSN Master/local module	R□CPU/ R□ENCPU/ R12CCPU-V		RJ71GN11-T2	●	-	-	-		
J5-CASE3	Ethernet	Servo amplifier	MR-J5-□G/MR-J5-□G-RJ		CC-Link IE Field Network Basic	Programmable controller CPU	R□CPU/R□ENCPU/ FX5U/FX5UC/ Q□UDVCPV/Q□UDPVCPV/ L□CPU(-P)/L26CPU-BT/L26CPU-PBT	●	-	-	-	
			C Controller (MELSEC iQ-R Series)	R12CCPU-V		●	-	-	-			
			Ethernet module (MELSEC iQ-F Series)	FX5-ENET		●	-	-	-			
			MELIPC	MI5122-VW		●	-	-	-			
			Programmable controller CPU	R□CPU/R□ENCPU/ FX5U/FX5UC/ Q□UDVCPV/Q□UDPVCPV/ L□CPU(-P)/L26CPU-BT/L26CPU-PBT		●	-	-	-			
			C Controller (MELSEC iQ-R Series)	R12CCPU-V		●	-	-	-			
J5-CASE4	Ethernet	Programmable controller CPU+ Simple Motion module	R□CPU	RD77MS□	SSCNET III/H	Servo amplifier	MR-J5-□B/MR-J5-□B-RJ/ MR-J5W2-□B/ MR-J5W3-□B	●	●*3	●*4	-	
			Q□CPU	QD77MS□			●	●*3	●*4	-		
J5-CASE5	Ethernet	Programmable controller CPU+ Motion controller	R□CPU	R□MTCPU	SSCNET III/H	Servo amplifier	MR-J5-□B/MR-J5-□B-RJ/ MR-J5W2-□B/ MR-J5W3-□B	●	●*3	●*4	-	
			Q□CPU	Q17□DSCPU			●	●*3	●*4	-		
J5-CASE6	Ethernet	Programmable controller CPU+ CC-Link IE TSN module	R□CPU/ R□ENCPU/ R□SFCPU/ R12CCPU-V/ R102WCPV-W	RJ71GN11-T2	CC-Link IE TSN	Servo amplifier	MR-J5-□G/MR-J5-□G-RJ/ MR-J5W2-□G/MR-J5W3-□G/ MR-J5D1-□G4/MR-J5D2-□G4/ MR-J5D3-□G4	●	-	-	-	
			R□CPU/ R□ENCPU	RJ71GN11-EIP			●	-	-	-		

*3 The sample screen is set up based on a specific system configuration, such as the GOT being connected to a programmable controller CPU and the servo amplifier being controlled by a motion module. When using the sample screen, it is necessary to change the settings to match the actual system configuration. Please use the sample screen for GT27**V (640x480).

*4 The dedicated screen differs depending on the system configuration and the servo amplifier. For details, please refer to the GOT2000 Series Connection Manual (Mitsubishi Electric Products) and the GOT2000 Series User's Manual (Monitor).

GOT Drive Control (Servo) Interactive Solutions

2

System configurations and supported models

■ GOT SoftGOT2000 (multi-channel connection) **NEW**

●: Supported -: Not supported

System Configuration							User-created screen	Sample screen	Dedicated screen	FA transparent function	
CASE	Connection type	Name	Model type		Command interface	Controller/Servo amplifier					
						Name	Model type				
J4-CASE1	RS-422	Servo amplifier	MR-J4-□A/ MR-J4-□A-RJ		Pulse train (serial)	Programmable controller CPU+ Positioning module	MELSEC iQ-R Series Programmable controller CPU+ RD75D□, etc./ MELSEC iQ-F Series Programmable controller CPU (built-in positioning function)/ MELSEC iQ-F Series Programmable controller CPU+ FX5-20PG-P, etc./ MELSEC-Q Series Programmable controller CPU+ QD75D□/ MELSEC-L Series Programmable controller CPU+ LD75D□, etc./ MELSEC-F Series Programmable controller CPU (built-in positioning function)/ MELSEC-F Series Programmable controller CPU+ FX3U-1PG, etc.	-	-	-	-
J4-CASE2	Ethernet	Programmable controller CPU+ Simple motion module	R□CPU	RD77MS□	SSCNET III/H	Servo amplifier	MR-J4-□B/ MR-J4-□B-RJ/ MR-J4W2-□B/ MR-J4W3-□B	●	●*3	●*4	-
			FX5CPU	FX5-□SSC-S				●	-	●*4	-
			Q□CPU	QD77MS□				●	-	●*4	-
			L□CPU	LD77MS□				●	-	●*4	-
J4-CASE3	Ethernet	Programmable controller CPU+ Motion controller	R□CPU	R□MTCPU	SSCNET III/H	Servo amplifier	MR-J4-□B/ MR-J4-□B-RJ/ MR-J4W2-□B/ MR-J4W3-□B	●	●*3	●*4	-
			Q□CPU	Q17□DSCPU				●	-	●*4	-
			Q□CPU	Q170MSCPU				●	-	●*4	-
J4-CASE4	Ethernet	Programmable controller CPU+ CC-Link IE Field Network Simple Motion module	R□CPU	RD77GF□	CC-Link IE Field Network	Servo amplifier	MR-J4-□GF/ MR-J4-□GF-RJ	●	-	●*4	-
			Q□CPU	QD77GF□				●	-	●*4	-
		Programmable controller CPU+ CC-Link IE Field Network Master/local module	R□CPU	RJ71GF11-T2				●	-	●*4	-
			Q□CPU	QJ71GF11-T2				●	-	●*4	-
		CC-Link IE built-in CPU module	L□CPU	LJ71GF11-T2				●	-	●*4	-
Programmable controller CPU+ CC-Link IE built-in Ethernet module	R□ENCPU		●	-	●*4	-					
			R□CPU	RJ71EN71			●	-	●*4	-	

*3 The sample screen is set up based on a specific system configuration, such as the GOT being connected to a programmable controller CPU and the servo amplifier being controlled by a motion module. When using the sample screen, it is necessary to change the settings to match the actual system configuration. Please use the sample screen for GT27**-V (640x480).

*4 The dedicated screen differs depending on the system configuration and the servo amplifier. For details, please refer to the GOT2000 Series Connection Manual (Mitsubishi Electric Products) and the GOT2000 Series User's Manual (Monitor).

Notes on sample screens

Depending on your system configuration (P.5-) and servo amplifier, there are cases where the sample screens may not be supported. In such cases, please refer to "User-created screen" on page 45. The sample screens are updated as necessary. The actual sample screens may be different from those in this catalog, and some function screens are not listed. If you wish to obtain the latest sample data, please contact your local sales office.

■ GOT SoftGOT2000 (multi-channel connection) NEW

●: Supported -: Not supported

System Configuration							User-created screen	Sample screen	Dedicated screen	FA transparent function		
CASE	Controllers connected directly to GOT and GT SoftGOT2000			Controller/Servo amplifier								
	Connection type	Name	Model type		Command interface	Name	Model type					
JET-CASE1	Ethernet	Programmable controller CPU+ Motion module	R□CPU/ R□ENCPU	RD78G□/ RD78GH□	CC-Link IE TSN	Servo amplifier	MR-JET-□G	●	-	●*4	-	
			FX5U/ FX5UC	FX5-□SSC-S				●	-	●*4	-	
			R12CCPU-V	RD78G□/ RD78GH□				●	-	-	-	
JET-CASE2	Ethernet	Servo amplifier	MR-JET-□G		CC-Link IE TSN	Programmable controller CPU+ Motion module	R□CPU/ R□ENCPU	RD78G□/ RD78GH□	●	●*5	-	-
						Programmable controller CPU+ CC-Link IE TSN Master/local module	FX5U/ FX5UC	FX5-□SSC-G	●	●*5	-	-
JET-CASE3	Ethernet	Servo amplifier	MR-JET-□G		CC-Link IE Field Network Basic	Programmable controller CPU	R□CPU/R□ENCPU/ FX5U/FX5UC/ Q□UDVPCU/Q□UDPVCPU/ L□CPU-(P)/L26CPU-BT/L26CPU-PBT		●	●*5	-	-
						C Controller (MELSEC iQ-R Series)	R12CCPU-V	●	●*5	-	-	
						Ethernet module (MELSEC iQ-F Series)	FX5-ENET	●	●*5	-	-	
						MELIPC	MI5122-VW	●	●*5	-	-	
JET-CASE4	Ethernet	Programmable controller CPU+ CC-Link IE TSN module	R□CPU/ R□ENCPU/ R□SFCPU/ R12CCPU-V/ R102WCPU-W	RJ71GN11-T2	CC-Link IE TSN	Servo amplifier	MR-JET-□G	●	-	-	-	
			R□CPU/ R□ENCPU	RJ71GN11-EIP				●	-	-	-	
JE-CASE1	RS-422	Servo amplifier	MR-JE-□A		Pulse train (serial)	Programmable controller CPU+ Positioning module	MELSEC iQ-R Series Programmable controller CPU+ RD75D□, etc./ MELSEC iQ-F Series Programmable controller CPU (built-in positioning function)/ MELSEC iQ-F Series Programmable controller CPU+ FX5-20PG-P, etc./ MELSEC-Q Series Programmable controller CPU+ QD75D□/ MELSEC-L Series Programmable controller CPU+ LD75D□, etc./ MELSEC-F Series Programmable controller CPU (built-in positioning function)/ MELSEC-F Series Programmable controller CPU+ FX3U-1PG, etc.	-	-	-	-	
JE-CASE2	Ethernet	Programmable controller CPU+ Simple Motion module	R□CPU	RD77MS□	SSCNET III/H	Servo amplifier	MR-JE-□B	●	-	●*4	-	
			FX5CPU	FX5-□SSC-S				●	-	●*4	-	
			Q□CPU	QD77MS□				●	-	●*4	-	
			L□CPU	LD77MS□				●	-	●*4	-	
JE-CASE3	Ethernet	Servo amplifier	MR-JE-□C		Pulse train (serial)	Programmable controller CPU+ Positioning module	MELSEC iQ-R Series Programmable controller CPU+ RD75D□, etc./ MELSEC iQ-F Series Programmable controller CPU (built-in positioning function)/ MELSEC iQ-F Series Programmable controller CPU+ FX5-20PG-P, etc./ MELSEC-Q Series Programmable controller CPU+ QD75D□/ MELSEC-L Series Programmable controller CPU+ LD75D□, etc./ MELSEC-F Series Programmable controller CPU (built-in positioning function)/ MELSEC-F Series Programmable controller CPU+ FX3U-1PG, etc.	-	-	-	-	

*4 The dedicated screen differs depending on the system configuration and the servo amplifier. For details, please refer to the GOT2000 Series Connection Manual (Mitsubishi Electric Products) and the GOT2000 Series User's Manual (Monitor).

*5 The sample screen is set up based on a specific system configuration, such as the GOT being connected to a programmable controller CPU and the servo amplifier being controlled by a motion module. When using the sample screen, it is necessary to change the settings to match the actual system configuration. Please use the sample screen for GS21**-W-N (800x480).

Interactive functions list

Supported drive control interactive functions differ depending on GOT models. Please check the following list for the compatibility status of each model.

■GT27/GT25

●: Supported -: Not supported

No.	Process	Application scenario	Function name	Page	User-created screen	Sample screen ^{*1}	Dedicated function
1	Startup, adjustment	Parameter setting	Basic setting parameters	P.26	●	●	—
2			Gain/filter parameters	P.26	●	●	—
3			Extension setting 1 parameters	P.26	●	●	—
4			Extension setting 2 parameters	P.26	●	●	—
5			Extension setting 3 parameters	P.26	●	●	—
6			I/O setting parameters	P.26	●	●	—
7			Linear servo/DD motor setting	P.26	●	●	—
8			Motor extension setting	P.26	●	●	—
9			Network setting	P.26	●	●	—
10			Option setting	P.26	●	●	—
11			Positioning control	P.26	●	●	—
12			Positioning extension setting	P.26	●	●	—
13			Point table	P.26	●	●	—
14		Test operation	JOG operation	P.28	●	●	—
15			Positioning operation	P.28	●	●	—
16			Motor-less operation	P.28	●	●	—
17			Output signal (DO) forced output	P.28	●	●	—
18		Adjustment	One-touch tuning function	P.29	●	●	—
19			Tuning function	P.30	●	●	—
20			Servo amplifier graph function (startup, adjustment)	P.31	—	—	●
21			FA transparent function	P.31	—	—	●
22	Maintenance	Troubleshooting	System launcher (servo network) function	P.32	—	—	●
23			Drive recorder function	P.33	—	—	●
24			Servo amplifier data analysis	P.33	—	—	●
25			Servo amplifier graph function (maintenance)	P.34	—	—	●
26			Backup/Restoration function	P.34	—	—	●
27			Monitor function	P.35	●	●	—
28			R motion monitor function	P.36	—	—	●
29			Q motion monitor function	P.36	—	—	●
30			R Motion SFC monitor function	P.36	—	—	●
31			Q motion SFC monitor function	P.36	—	—	●
32			Motion program editor function	P.37	—	—	●
33			Servo amplifier monitor function	P.37	●	●	●
34			Intelligent module monitor function	P.38	—	—	●
35			Alarm display function	P.38	●	●	—
36			Encoder communication circuit diagnosis	P.39	●	●	—
37			Predictive maintenance	Machine diagnosis (friction estimation, vibration estimation)	P.39	●	●
38		Machine diagnosis (tension estimation) screen		P.40	●	●	—
39		Machine diagnosis (total travel distance)		P.40	●	●	—
40		Gear Failure Diagnosis		P.41	●	●	—
41		Machine diagnosis function		P.42	●	●	—
42		Monitoring device values of machine failure prediction function		P.43	●	●	—
43		Servo amplifier life diagnosis function		P.44	●	●	—
44	Switching axis numbers (station numbers) of servo amplifiers	P.44		●	●	—	

^{*1} The sample screen assumes a specific system configuration, such as when GOT is connected to a programmable controller CPU and the servo amplifier controlled by a motion module. When using the sample screen, you need to change the settings to match your system configuration.

Notes on sample screens

Depending on your system configuration (P.5-) and servo amplifier, there are cases where the sample screens may not be supported. In such cases, please refer to "User-created screen" on page 45. The sample screens are updated as necessary. The actual sample screens may be different from those in this catalog, and some function screens are not listed. If you wish to obtain the latest sample data, please contact your local sales office.

GT21

●: Supported -: Not supported

No.	Process	Application scenario	Function name	Page	User-created screen	Sample screen*1	Dedicated function
1	Startup, adjustment	Parameter setting	Basic setting parameters	P.26	●	●	-
2			Gain/filter parameters	P.26	●	●	-
3			Extension setting 1 parameters	P.26	●	●	-
4			Extension setting 2 parameters	P.26	●	●	-
5			Extension setting 3 parameters	P.26	●	●	-
6			I/O setting parameters	P.26	●	●	-
7			Linear servo/DD motor setting	P.26	●	●	-
8			Motor extension setting	P.26	●	-	-
9			Network setting	P.26	●	●	-
10			Option setting	P.26	●	●	-
11			Positioning control	P.26	●	●	-
12			Positioning extension setting	P.26	●	●	-
13			Point table	P.26	●	●	-
14		Test operation	JOG operation	P.28	●	●	-
15			Positioning operation	P.28	●	●	-
16			Motor-less operation	P.28	●	-	-
17			Output signal (DO) forced output	P.28	●	●	-
18		Adjustment	One-touch tuning function	P.29	●	●	-
19			Tuning function	P.30	●	●	-
20			Servo amplifier graph function (startup, adjustment)	P.31	-	-	-
21			FA transparent function	P.31	-	-	●
22	Maintenance	Troubleshooting	System launcher (servo network) function	P.32	-	-	-
23			Drive recorder function	P.33	-	-	-
24			Servo amplifier data analysis	P.33	-	-	-
25			Servo amplifier graph function (maintenance)	P.34	-	-	-
26			Backup/Restoration function	P.34	-	-	-
27			Monitor function	P.35	●	●	-
28			R motion monitor function	P.36	-	-	-
29			Q motion monitor function	P.36	-	-	-
30			R Motion SFC monitor function	P.36	-	-	-
31			Q motion SFC monitor function	P.36	-	-	-
32			Motion program editor function	P.37	-	-	-
33			Servo amplifier monitor function	P.37	●	●	-
34			Intelligent module monitor function	P.38	-	-	-
35			Alarm display function	P.38	●	●	-
36			Encoder communication circuit diagnosis	P.39	●	-	-
37		Predictive maintenance	Machine diagnosis (friction estimation, vibration estimation)	P.39	●	●	-
38			Machine diagnosis (tension estimation) screen	P.40	●	-	-
39			Machine diagnosis (total travel distance)	P.40	●	-	-
40			Gear Failure Diagnosis	P.41	●	-	-
41			Machine diagnosis function	P.42	●	●	-
42			Monitoring device values of machine failure prediction function	P.43	●	-	-
43			Servo amplifier life diagnosis function	P.44	●	●	-
44	Switching axis numbers (station numbers) of servo amplifiers		P.44	●	●	-	

*1 The sample screen assumes a specific system configuration, such as when GOT is connected to a programmable controller CPU and the servo amplifier controlled by a motion module. When using the sample screen, you need to change the settings to match your system configuration.

GOT Drive Control (Servo) Interactive Solutions

■ GOT SoftGOT2000 (single-channel connection)

●: Supported -: Not supported

No.	Process	Application scenario	Function name	Page	User-created screen	Sample screen ^{*1}	Dedicated function
1	Startup, adjustment	Parameter setting	Basic setting parameters	P.26	●	—	—
2			Gain/filter parameters	P.26	●	—	—
3			Extension setting 1 parameters	P.26	●	—	—
4			Extension setting 2 parameters	P.26	●	—	—
5			Extension setting 3 parameters	P.26	●	—	—
6			I/O setting parameters	P.26	●	—	—
7			Linear servo/DD motor setting	P.26	●	—	—
8			Motor extension setting	P.26	—	—	—
9			Network setting	P.26	—	—	—
10			Option setting	P.26	—	—	—
11			Positioning control	P.26	—	—	—
12			Positioning extension setting	P.26	—	—	—
13			Point table	P.26	—	—	—
14		Test operation	JOG operation	P.28	●	—	—
15			Positioning operation	P.28	●	—	—
16			Motor-less operation	P.28	●	—	—
17			Output signal (DO) forced output	P.28	●	—	—
18		Adjustment	One-touch tuning function	P.29	●	—	—
19			Tuning function	P.30	●	—	—
20			Servo amplifier graph function (startup, adjustment)	P.31	—	—	—
21			FA transparent function	P.31	—	—	—
22	Maintenance	Troubleshooting	System launcher (servo network) function	P.32	—	—	—
23			Drive recorder function	P.33	—	—	—
24			Servo amplifier data analysis	P.33	—	—	—
25			Servo amplifier graph function (maintenance)	P.34	—	—	—
26			Backup/Restoration function	P.34	—	—	—
27			Monitor function	P.35	●	—	—
28			R motion monitor function	P.36	—	—	—
29			Q motion monitor function	P.36	—	—	—
30			R motion SFC monitor function	P.36	—	—	—
31			Q motion SFC monitor function	P.36	—	—	—
32			Motion program editor function	P.37	—	—	—
33			Servo amplifier monitor function	P.37	—	—	—
34			Intelligent module monitor function	P.38	—	—	—
35			Alarm display function	P.38	●	—	—
36			Encoder communication circuit diagnosis	P.39	—	—	—
37		Predictive maintenance	Machine diagnosis (friction estimation, vibration estimation)	P.39	—	—	—
38			Machine diagnosis (tension estimation) screen	P.40	—	—	—
39			Machine diagnosis (total travel distance)	P.40	—	—	—
40			Gear Failure Diagnosis	P.41	—	—	—
41			Machine diagnosis function	P.42	●	—	—
42			Monitoring device values of machine failure prediction function	P.43	—	—	—
43			Servo amplifier life diagnosis function	P.44	●	—	—
44	Switching axis numbers (station numbers) of servo amplifiers		P.44	●	—	—	

*1 The sample screen assumes a specific system configuration, such as when GOT is connected to a programmable controller CPU and the servo amplifier controlled by a motion module. When using the sample screen, you need to change the settings to match your system configuration.

Notes on sample screens

Depending on your system configuration (P.5-) and servo amplifier, there are cases where the sample screens may not be supported. In such cases, please refer to "User-created screen" on page 45. The sample screens are updated as necessary. The actual sample screens may be different from those in this catalog, and some function screens are not listed. If you wish to obtain the latest sample data, please contact your local sales office.

■ GOT SoftGOT2000 (multi-channel connection) NEW

●: Supported -: Not supported

No.	Process	Application scenario	Function name	Page	User-created screen	Sample screen*1	Dedicated function
1	Startup, adjustment	Parameter setting	Basic setting parameters	P.26	●	●	—
2			Gain/filter parameters	P.26	●	●	—
3			Extension setting 1 parameters	P.26	●	●	—
4			Extension setting 2 parameters	P.26	●	●	—
5			Extension setting 3 parameters	P.26	●	●	—
6			I/O setting parameters	P.26	●	●	—
7			Linear servo/DD motor setting	P.26	●	●	—
8			Motor extension setting	P.26	●	●	—
9			Network setting	P.26	●	●	—
10			Option setting	P.26	●	●	—
11			Positioning control	P.26	●	●	—
12			Positioning extension setting	P.26	●	●	—
13			Point table	P.26	●	●	—
14		Test operation	JOG operation	P.28	●	●	—
15			Positioning operation	P.28	●	●	—
16			Motor-less operation	P.28	●	●	—
17			Output signal (DO) forced output	P.28	●	●	—
18		Adjustment	One-touch tuning function	P.29	●	●	—
19			Tuning function	P.30	●	●	—
20			Servo amplifier graph function (startup, adjustment)	P.31	—	—	●
21			FA transparent function	P.31	—	—	—
22	Maintenance	Troubleshooting	System launcher (servo network) function	P.32	—	—	●
23			Drive recorder function	P.33	—	—	●
24			Servo amplifier data analysis	P.33	—	—	●
25			Servo amplifier graph function (maintenance)	P.34	—	—	●
26			Backup/Restoration function	P.34	—	—	●
27			Monitor function	P.35	●	●	—
28			R motion monitor function	P.36	—	—	—
29			Q motion monitor function	P.36	—	—	—
30			R motion SFC monitor function	P.36	—	—	—
31			Q motion SFC monitor function	P.36	—	—	—
32			Motion program editor function	P.37	—	—	—
33			Servo amplifier monitor function	P.37	—	—	—
34			Intelligent module monitor function	P.38	—	—	—
35			Alarm display function	P.38	●	●	—
36			Encoder communication circuit diagnosis	P.39	●	●	—
37			Predictive maintenance	Machine diagnosis (friction estimation, vibration estimation)	P.39	●	●
38		Machine diagnosis (tension estimation) screen		P.40	●	●	—
39		Machine diagnosis (total travel distance)		P.40	●	●	—
40		Gear Failure Diagnosis		P.41	●	●	—
41		Machine diagnosis function		P.42	●	●	—
42		Monitoring device values of machine failure prediction function		P.43	●	●	—
43		Servo amplifier life diagnosis function		P.44	●	●	—
44	Switching axis numbers (station numbers) of servo amplifiers	P.44		●	●	—	

*1 The sample screen assumes a specific system configuration, such as when GOT is connected to a programmable controller CPU and the servo amplifier controlled by a motion module. When using the sample screen, you need to change the settings to match your system configuration.

MR-J5 MR-J4 MR-JET MR-JE

GT27 GT25 GT21 SoftGOT (Single-ch)* SoftGOT (Multi-ch)

* Supported by MR-J4-□B(-RJ), MR-J4W2-□B, MR-J4W3-□B, MR-JE-□B only. See page 16 for details.

Key Feature 01

Parameter setting

Sample screen End user OEM Easy startup

The screens can be used to display and set the values of various parameters in the servo amplifier

Servo amplifier parameters and point table values can be displayed and set with GOT and SoftGOT2000.

Sample screens

Basic setting parameters screen

No.	Symbol	Name	Set value	Unit
PA01	**STY	Operation mode	00003000h	
PA02	**REG	Regenerative option	00000000h	
PA03	*ABS	Absolute position detection system	00000000h	
PA04	*AOP1	Function selection A-1	00002100h	
PA06	*CMX	Electronic gear - Numerator	1	
PA07	*CDV	Electronic gear - Denominator	1	
PA08	ATU	Auto tuning mode	00000004h	
PA09	RSP	Auto tuning response	32	
PA10	INP	In-position range	25600	
PA11	TLP	Forward rotation torque limit	300.0 %	
PA12	TLN	Reverse rotation torque limit	300.0 %	
PA14	*POL	Travel direction selection	0	
PA15	*ENR1	Encoder output pulses	4000	pulse/rev
PA16	*ENR2	Encoder output pulses 2	1	
PA17	**MSR	Servo motor series setting	00000000h	
PA18	**MTY	Servo motor type setting	00000000h	
PA19	*BLK	Servo parameter writing prohibited	000000ABh	
PA20	*TDS	Tough drive setting	00000000h	

Gain/filter parameters screen

No.	Symbol	Name	Set value	Unit
PB01	FILT	Adaptive tuning mode (adaptive filter II)	00000000h	
PB02	VRFT	Vib. supp. ctrl tuning mode (Adv. vib. supp. ctrl II)	00000000h	
PB03	TFBGN	Torque feedback loop gain	36000	rad/s
PB04	FFC	Feed forward gain	0	%
PB06	GD2	Load to motor inertia ratio/load to motor mass ratio	0.01	times
PB07	PG1	Model control gain	274.0	rad/s
PB08	PG2	Position control gain	499.0	rad/s
PB09	VG2	Speed control gain	2244	rad/s
PB10	VIC	Speed integral compensation	2.5	ms
PB11	VDC	Speed differential compensation	980	
PB12	OVA	Overshoot amount compensation	0	%
PB13	NH1	Machine resonance suppression filter 1	4500	Hz
PB14	NH01	Notch shape selection 1	00000000h	
PB15	NH2	Machine resonance suppression filter 2	725	Hz
PB16	NH02	Notch shape selection 2	00000100h	
PB17	NHF	Shaft resonance suppression filter	00000128h	
PB18	LPF	Low-pass filter setting	22210	rad/s
PB19	VRFT1	Vibration suppression control 1 - Vibration frequency	100.0	Hz

Extension setting parameters screen

No.	Symbol	Name	Set value	Unit
PC01	ERZ	Excessive error alarm trigger level	0	rev mm
PC02	MBR	Electromagnetic brake sequence output	0	ms
PC03	*ENRS	Encoder output pulses selection	00000000h	
PC04	**COP1	Function selection C-1	00000000h	
PC05	**COP2	Function selection C-2	00000000h	
PC06	**COP3	Function selection C-3	00000000h	
PC07	ZSP	Zero speed	50	r/min mm/s
PC08	OSL	Overspeed alarm detection level	0	r/min mm/s
PC09	MOD1	Analog monitor 1 output	00000000h	
PC10	MOD2	Analog monitor 2 output	00000001h	
PC11	MO1	Analog monitor 1 offset	0	mV
PC12	MO2	Analog monitor 2 offset	0	mV
PC16	*COP3A	Function selection C-3A	00000000h	
PC17	*COP4	Function selection C-4	00000000h	
PC19	*COP6	Function selection C-6	00000000h	
PC20	*COP7	Function selection C-7	00000000h	
PC21	*BPS	Alarm history clear	00000000h	
PC24	RSBR	Deceleration time constant at forced stop	100	ms

I/O setting parameters screen

No.	Symbol	Name	Set value	Unit
PD01	*DIA1	Input signal automatic ON selection 1	00000000h	
PD03	*D1	Input device selection 1	0000000ABh	
PD04	*D2	Input device selection 2	0000000Bh	
PD05	*D3	Input device selection 3	00000022h	
PD07	*D01	Output device selection 1	00000055h	
PD08	*D02	Output device selection 2	00000004h	
PD09	*D03	Output device selection 3	00000003h	
PD11	*DIF	Input filter setting	00000007h	
PD12	*DOP1	Function selection D-1	00000101h	
PD13	*DOP2	Function selection D-2	00000000h	
PD14	*DOP3	Function selection D-3	00000000h	
PD38	*D4	Input device selection 4	0000002Ch	
PD39	*D5	Input device selection 5	0000002Dh	
PD41	*DOP4	Function selection D-4	00000000h	
PD51	*D3W2	Input device selection 3-2	00000062h	
PD60	*DIP	DI pin polarity selection	00000000h	

* All of the above images are the connection sample screens of MR-J5-□G.

Motor extension setting screen



Network setting screen

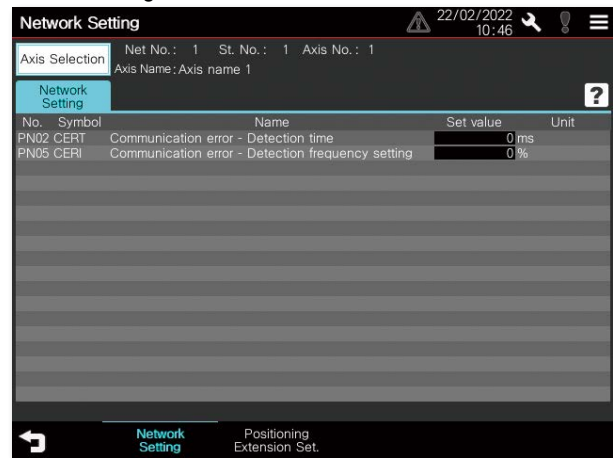

Positioning control screen

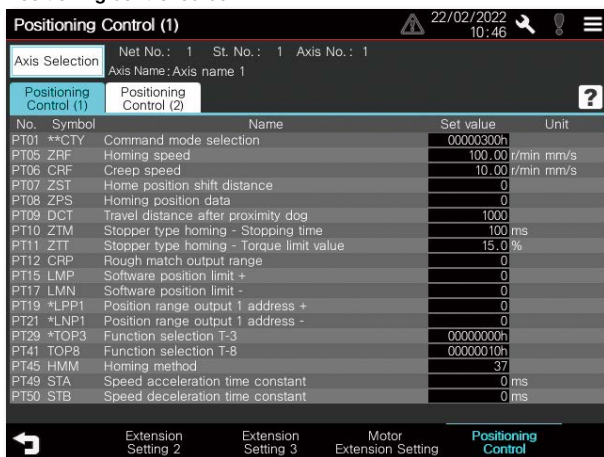

Positioning extension setting screen

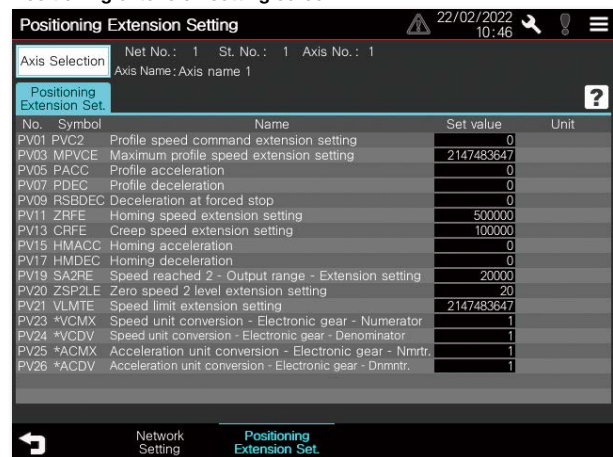

* All of the above images are the connection sample screens of MR-J5-□G.

●: Supported —: Not supported

No.	Function	MR-J5-□G(-RJ) MR-J5W2-□G MR-J5W3-□G	MR-J5D1-□G4 MR-J5D2-□G4 MR-J5D3-□G4	MR-J5-□B(-RJ) MR-J5W2-□B MR-J5W3-□B	MR-J4-□B(-RJ) MR-J4W2-□B MR-J4W3-□B	MR-J4- □A	MR-J4- □A-RJ	MR-J4- □GF(-RJ)	MR-JET- □G	MR-JE- □B	MR-JE- □A	MR-JE- □C
1	Basic setting servo parameters [Pr. PA_]	●	●	●	●	●	●	●	●	●	●	●
2	Gain/filter setting servo parameters [Pr. PB_]	●	●	●	●	●	●	●	●	●	●	●
3	Extension setting [Pr. PC_]	●	●	●	●	●	●	●	●	●	●	●
4	I/O setting [Pr. PD_]	●	●	●	●	●	●	●	●	●	●	●
5	Extension setting 2 [Pr. PE_]	●	●	●	●	●	●	●	●	●	●	●
6	Extension setting 3 [Pr. PF_]	●	●	●	●	●	●	●	●	●	●	●
7	Motor extension setting [Pr. PL_] NEW	●	●	●	—	—	—	—	●	—	—	—
8	Linear servo motor/DD motor setting [Pr. PL_]	—	—	—	●	●	●	●	—	—	—	—
9	Network setting [Pr. PN_]	●	●	—	—	—	—	●	●	—	—	●
10	Option setting [Pr. PO_]	●	●	—	—	—	●	—	●	—	—	—
11	Positioning control setting [Pr. PT_]	●	●	—	—	—	●	●	●	—	—	●
12	Positioning extension setting [Pr. PV_] NEW	●	●	—	—	—	—	—	●	—	—	—
13	Point table	●	●	—	—	—	●	—	●	—	—	—

GOT Drive Control (Servo) Interactive Solutions

MR-J5 MR-J4 MR-JET MR-JE

GT27 GT25 GT21 SoftGOT (Single-ch)* SoftGOT (Multi-ch)

* Supported by MR-J4-□B(-RJ), MR-J4W2-□B, MR-J4W3-□B, MR-JE-□B only. See page 16 for details.

Key Feature 02

Test operation

Sample screen End user OEM Easy startup

Check the equipment on the on-site GOT before going into full-scale operation

Without the need to set up a PC, you can confirm if the servo amplifier is working correctly before full-scale operation by checking on the on-site GOT.

Sample screens

With the sample screens, you can perform test operations equivalent to those performed with MR Configurator2, such as JOG operation, positioning operation, and output signal forced output.

4 Startup, adjustment

JOG operation screen

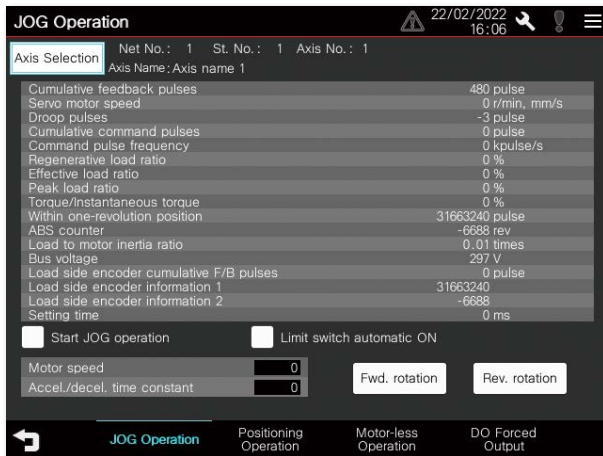

Positioning operation screen

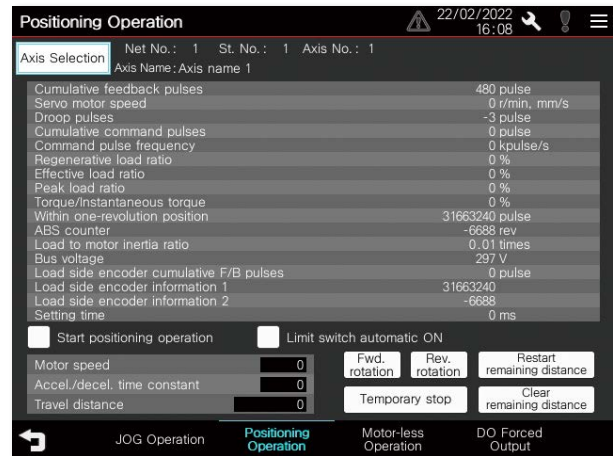

Motor-less operation

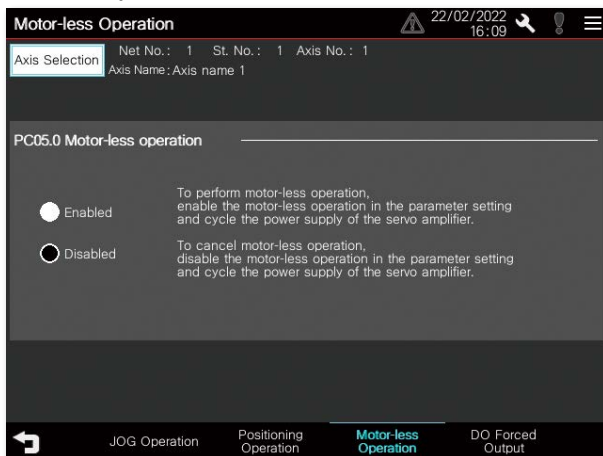

Output signal (DO) forced output screen

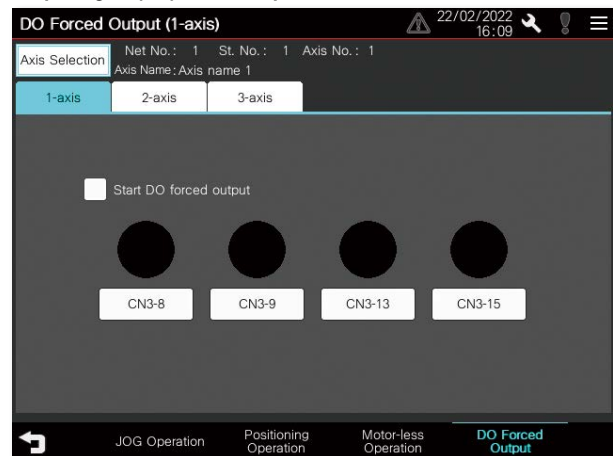

* All of the above images are the connection sample screens of MR-J5-□G.

●: Supported —: Not supported

No.	Function	MR-J5-□G(-RJ) MR-J5W2-□G MR-J5W3-□G	MR-J5D1-□G4 MR-J5D2-□G4 MR-J5D3-□G4	MR-J5-□B(-RJ) MR-J5W2-□B MR-J5W3-□B	MR-J4-□B(-RJ) MR-J4W2-□B MR-J4W3-□B	MR-J4-□A	MR-J4-□A-RJ	MR-J4-□GF(-RJ)	MR-JET-□G	MR-JE-□B	MR-JE-□A	MR-JE-□C
1	JOG operation	●	●	●	●	●	●	●	●	●	●	●
2	Positioning operation	●	●	●	●	●	●	●	●	●	●	●
3	Motor-less operation	●	●	●	●	●	●	●	●	●	●	●
4	Output signal (DO) forced output	●	●	●	●	●	●	●	●	●	●	●
5	Single-step feed	●	●	—	—	—	●	—	●	—	—	—

Key Feature 03

MR-J5 MR-J4 MR-JET MR-JE

GT27 GT25 GT21 SoftGOT (Single-ch)* SoftGOT (Multi-ch)

* Supported by MR-J4-□B(-RJ), MR-J4W2-□B, MR-J4W3-□B, MR-JE-□B only. See page 16 for details.

One-touch tuning function

Sample screen OEM Easy startup

Easily adjust servos on the on-site GOT

Challenges



I need a PC to adjust the servo!
How can I adjust the servo amplifier without a PC?

Solutions

Adjusting servos, which is challenging without experience, can be done in three steps using the on-site GOT. You can adjust the servos automatically by selecting from three response modes.

* The screen image shown is the connection sample screen of MR-J5-□G.

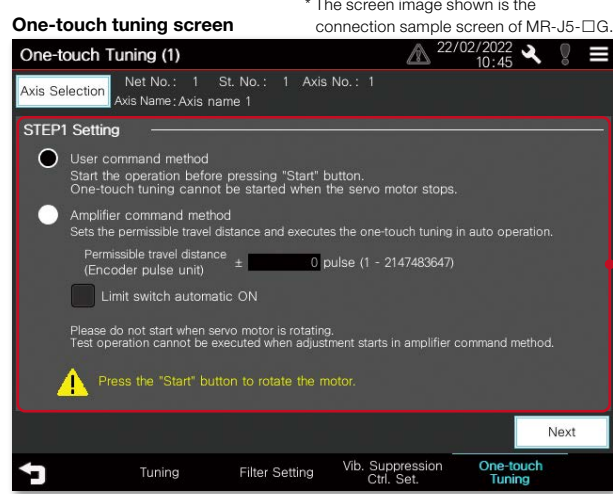

STEP1 : Select a command method

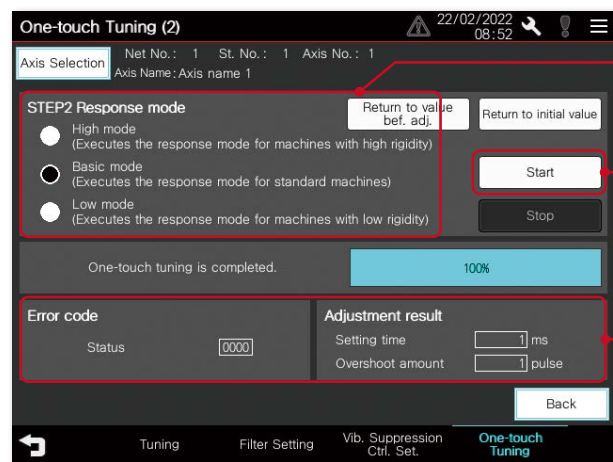

STEP2 : Select a response mode

STEP3 : Start adjustment

Adjustment results are shown

4 Startup, adjustment

No.	Function	MR-J5-□G(-RJ) MR-J5W2-□G MR-J5W3-□G	MR-J5D1-□G4 MR-J5D2-□G4 MR-J5D3-□G4	MR-J5-□B(-RJ) MR-J5W2-□B MR-J5W3-□B	MR-J4-□B(-RJ) MR-J4W2-□B MR-J4W3-□B	MR-J4-□A(-RJ)	MR-J4-□GF(-RJ)	MR-JET-□G	MR-JE-□B	MR-JE-□A	MR-JE-□C
1	One-touch tuning function	●	●	●	●	●	●	●	●	●	●

●: Supported —: Not supported

MR-J5 MR-J4 MR-JET MR-JE

GT27 GT25 GT21 SoftGOT (Single-ch)* SoftGOT (Multi-ch)

* Supported by MR-J4-□B(-RJ), MR-J4W2-□B, MR-J4W3-□B, MR-JE-□B only. See page 16 for details.

Key Feature 04

Tuning function

Sample screen OEM Easy startup

Adjust gains on the on-site GOT

Challenges



It's bothersome to connect a PC every time I adjust a gain.

Solutions

GOT can be used to adjust gains. The gain adjustment method can be selected according to the situation of the device to be started. Even after adjustment, you can manually adjust the gain parameters, response level setting, overshoot amount compensation, and so on. You can also set the filter to suppress the machine resonance of the device.

Tuning screen

* The screen image is the connection sample screen of MR-J5-□G.

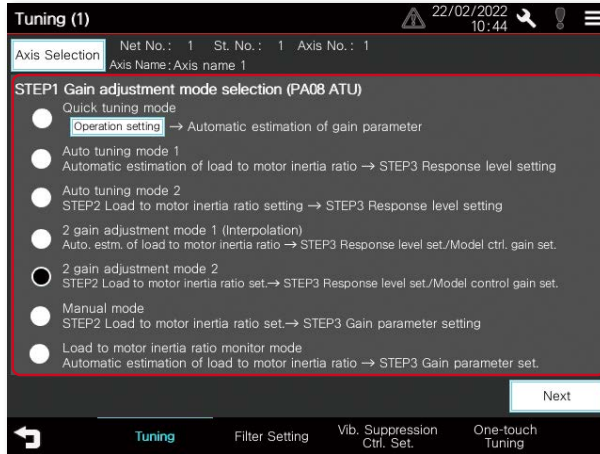

STEP1 : Select an adjustment mode



STEP2 : Set the load to motor inertia ratio

* Depending on the adjustment mode selected in STEP1, there is no need to set it.

STEP3 : Set the response level, gain parameters, and overshoot amount compensation.

* Depending on the adjustment mode selected in STEP1, there is no need to set it.

Adjustment starts once the servo amplifier is in the operating state.

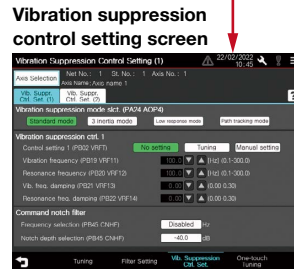
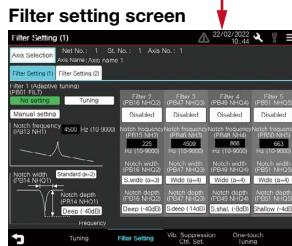

Filters can be set to suppress the machine resonance

4 Startup, adjustment

● : Supported — : Not supported

No.	Function	MR-J5-□G(-RJ)	MR-J5D1-□G4	MR-J5-□B(-RJ)	MR-J4-□B(-RJ)	MR-J4-□A(-RJ)	MR-J4-□GF(-RJ)	MR-JET-□G	MR-JE-□B	MR-JE-□A	MR-JE-□C
1	Tuning function	●	●	●	●	●	●	●	●	●	●

Key Feature 05

MR-J5 MR-J4 MR-JET MR-JE

GT27 GT25 GT21 SoftGOT (Single-ch) SoftGOT (Multi-ch)

Servo amplifier graph function (startup, adjustment)

Dedicated screen End user OEM Easy startup

Check the result of the gains adjusted on the on-site GOT in a graph waveform

Challenges



Can I check the waveform data on the GOT without connecting to a PC?

Solutions

The servo amplifier graph function visualizes the operational changes of the equipment associated with gain adjustment. Without a PC, you can start up the equipment while checking the gain adjustment results and parameter information, thereby enhancing work efficiency.

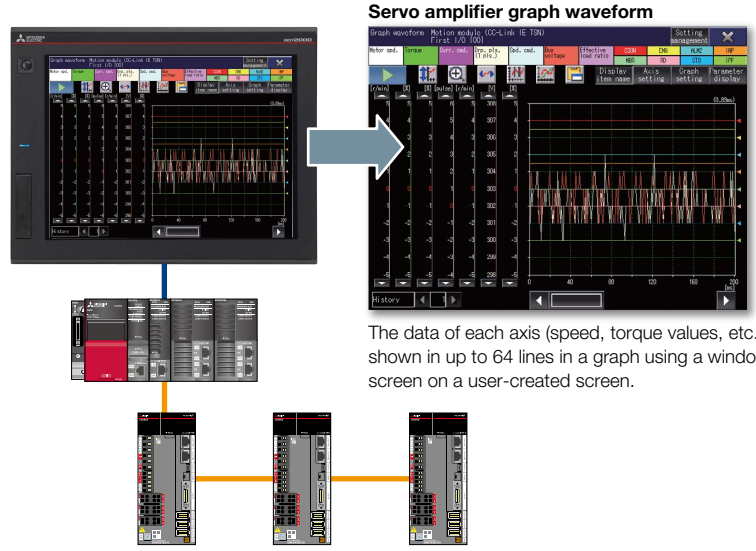

Key Feature 06

MR-J4

GT27 GT25 GT21 SoftGOT (Single-ch) SoftGOT (Multi-ch)

FA transparent function

End user OEM Maintenance Easy startup

Parameters and operating condition can be checked without opening the control panel

Challenges

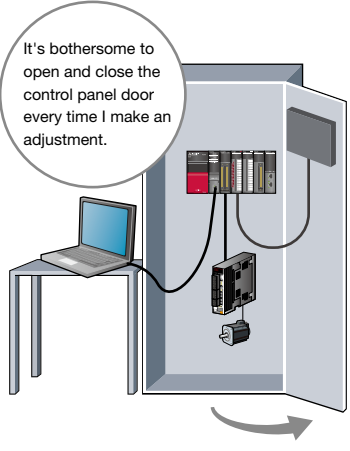

Is it possible to debug programs without opening the control panel?

Solutions

By connecting a PC to a GOT, you can use the GOT as a transparent gateway to enable programming, startup, and adjustment of servo amplifiers and PLCs. You do not have to bother with opening the control panel door or changing cable connections.

* GT21 cannot be used to access or transfer data to Mitsubishi Electric servo amplifiers.

- <Compatible software>
- MELSOFT MR Configurator2
 - MELSOFT MT Works2
 - MELSOFT GX Works3
 - MELSOFT GX Works2
 - MELSOFT GX Configurator-QP, etc.

* There are more compatible software applications. For details, please refer to the manual.



●: Supported —: Not supported

No.	Function	MR-J5-□G(-RJ) MR-J5W2-□G MR-J5W3-□G	MR-J5D1-□G4 MR-J5D2-□G4 MR-J5D3-□G4	MR-J5-□B(-RJ) MR-J5W2-□B MR-J5W3-□B	MR-J4-□B(-RJ) MR-J4W2-□B MR-J4W3-□B	MR-J4-□A(-RJ)	MR-J4-□GF(-RJ)	MR-JET-□G	MR-JE-□B	MR-JE-□A	MR-JE-□C
1	Servo amplifier graph function	●	●	—	●	—	—	●	●	—	—
2	FA transparent function	—	—	—	●	—	—	—	—	—	—

Key Feature 07

MR-J5 MR-J4 MR-JET MR-JE

GT27 GT25 GT21 SoftGOT (Single-ch) SoftGOT (Multi-ch)

System launcher (servo network) function

Dedicated screen End user OEM Maintenance Troubleshooting

Visually check the status of the servo system on the on-site GOT screen

Challenges



In case of a system failure, is there a simple and quick way to check where the problem occurred?

Solutions

GOT automatically generates the servo system configuration diagram, allowing you to visually check the status of the system. By selecting the servo amplifier in the system configuration diagram, you can easily check the alarm, device information, and system status.

5 Maintenance

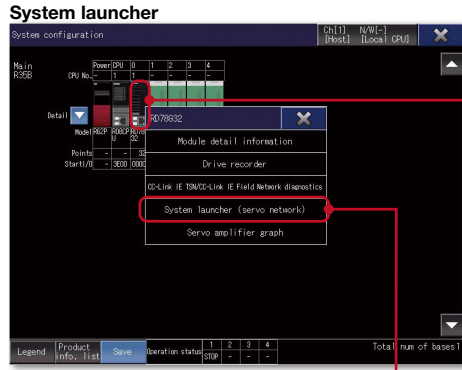

Select Motion CPU, Simple Motion module, or Motion module

Select system launcher (servo network) from the function list

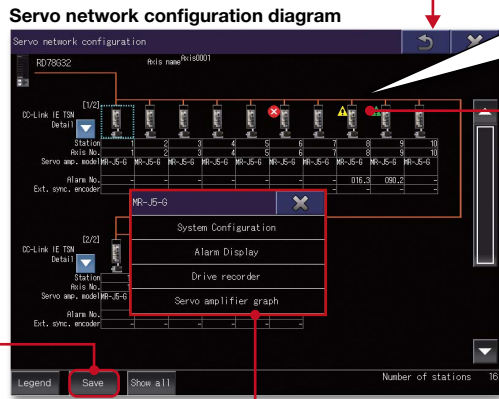

Where the error occurred is visible and easy to check

Select servo amplifier

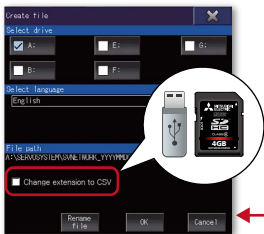

Output the servo network configuration information to a text/CSV file and send it by e-mail. You can check it at a remote location.

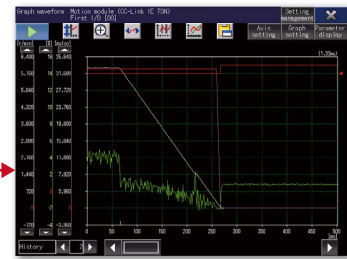

Servo amplifier graph waveform
Displays the waveform data of a servo amplifier that is useful for analysis.

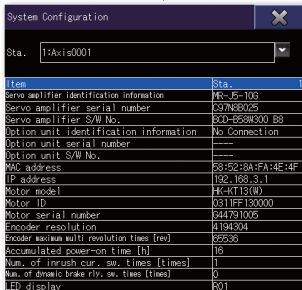

System configuration display
Displays the model and the serial number of servo amplifiers or motors.

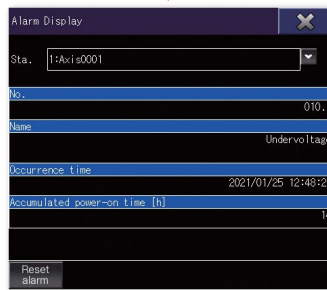

Alarm display
Displays currently occurring errors in the servo amplifier.

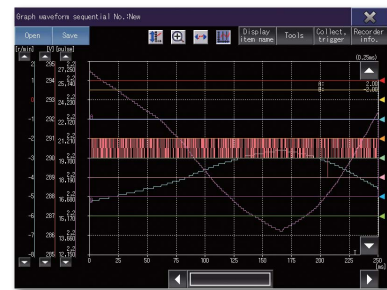

Drive recorder graph waveform
Displays waveform data from the drive recorder information screen that is useful for analysis.

* To use this function, open the [Common] > [GOT Setup] > [Advanced Setting] > [System Launcher] menu and check the [Update the setting of system launcher function], and also check the [Display the servo network configuration] in Controller System Launcher Function Setting.

●: Supported —: Not supported

No.	Function	MR-J5-□G(-RJ)	MR-J5D1-□G4	MR-J5-□B(-RJ)	MR-J4-□B(-RJ)	MR-J4-□A(-RJ)	MR-J4-□GF(-RJ)	MR-JET-□G	MR-JE-□B	MR-JE-□A	MR-JE-□C
1	System launcher (servo network) function	●	●	—	●	—	—	●	●	—	—

Key Feature 08

MR-J5 MR-J4 MR-JET MR-JE

GT27 GT25 GT21 SoftGOT (Single-ch) SoftGOT (Multi-ch)

Dedicated screen End user OEM Troubleshooting

Drive recorder function

Check the servo data at the time of alarm occurrence in a waveform list on the on-site GOT

Challenges

I cannot investigate the cause of the problem without a PC. I need to hurry.



In case of a system failure, is there a simple and quick way to check the problem cause?

Solutions

Servo alarm data such as motor current and position command can be read from the servo amplifier and checked in a waveform or a list format. Without a PC, you can use the on-site GOT to check the status when an alarm occurs, and respond quickly to issues.

Drive recorder information list screen

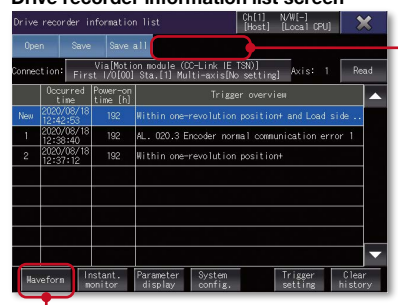

The axis label name is displayed when it is set.

Graph waveform screen

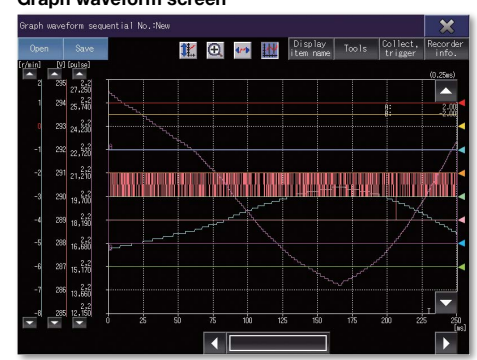

Display the waveform data that was collected at the occurrence of a servo alarm in a window screen.

Key Feature 09

MR-J5 MR-J4 MR-JET MR-JE

GT27 GT25 GT21 SoftGOT (Single-ch) SoftGOT (Multi-ch)

Dedicated screen End user OEM Troubleshooting

Servo amplifier data analysis

Retrieve servo data from the servo amplifier using the on-site GOT

Challenges

The cause of the trouble cannot be identified at the worksite.

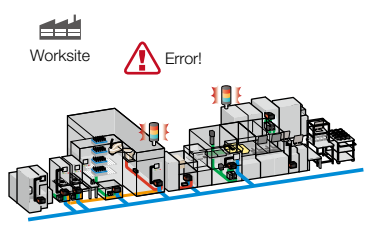

In case of a system failure, is there a simple and quick way to retrieve the servo data and analyze the problem cause?

Solutions

GOT reads the data which is saved in a servo amplifier and stores it in GOT's SD memory card or USB memory. After obtaining the servo data from GOT, you can send it to an office in a remote location and quickly solve the problem.

* MR-J5-□B(-RJ), MR-J5W2-□B, MR-J5W3-□B, and MR-J4-□GF(-RJ) do not support retrieving graph waveform file (gpf2) from the servo amplifier graph function.

System configuration

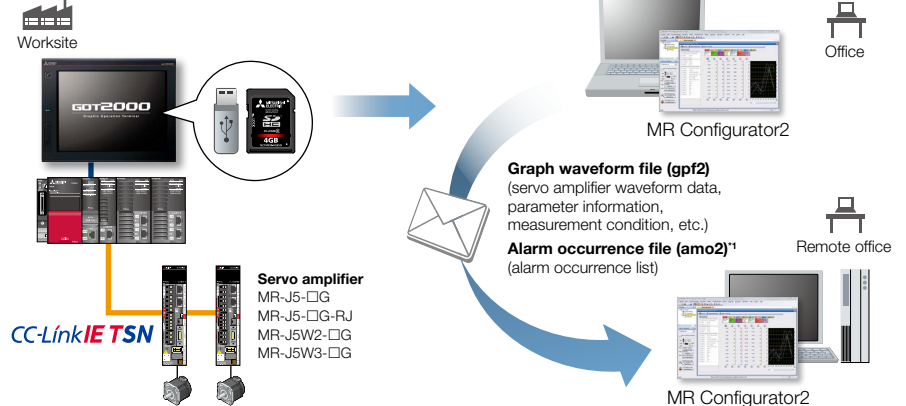

*1 Alarm occurrence file (amo2) is output only when the servo amplifier is MELSERVO-J4 or MELSERVO-JE.

No.	Function	MR-J5-□G(-RJ) MR-J5W2-□G MR-J5W3-□G	MR-J5D1-□G4 MR-J5D2-□G4 MR-J5D3-□G4	MR-J5-□B(-RJ) MR-J5W2-□B MR-J5W3-□B	MR-J4-□B(-RJ) MR-J4W2-□B MR-J4W3-□B	MR-J4-□A(-RJ)	MR-J4-□GF(-RJ)	MR-JET-□G	MR-JE-□B	MR-JE-□A	MR-JE-□C
1	Drive recorder function	●	●	●	●	—	●	●	●	—	—
2	Servo amplifier data analysis	●	●	●	●	—	●	●	●	—	—

●: Supported —: Not supported

Key Feature 10

MR-J5 MR-J4 MR-JET MR-JE

GT27 GT25 GT21

SoftGOT (Single-ch)

SoftGOT (Multi-ch)

Servo amplifier graph function (maintenance)

Dedicated screen End user OEM Preventive maintenance Troubleshooting

Analyze the waveform data of a servo amplifier using the on-site GOT

Challenges



How can I compare the data before and after the error occurrence?

Solutions

In the servo amplifier graph function, a specific period of time can be set in the collection and trigger setting window. Then the waveform data that occurred within the set period and the parameter information can be buffered in a servo amplifier, and can be read out and displayed on the GOT. By saving a normal waveform data as a history, you can compare it with the data measured in the same conditions by superimposing them; therefore it is useful for equipment maintenance.

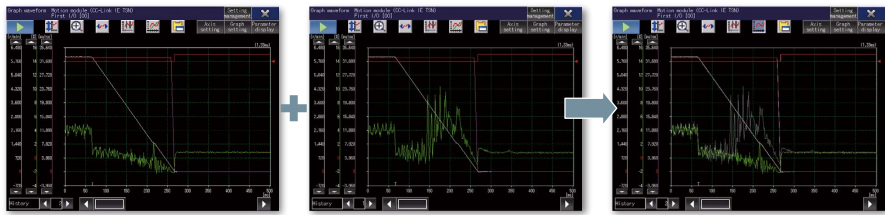

Normal waveform data

Abnormal waveform data

You can see the difference at a glance by superimposing normal and abnormal waveform data

5 Maintenance

Key Feature 11

MR-J4

GT27 GT25 GT21

SoftGOT (Single-ch)

SoftGOT (Multi-ch)

Backup/Restoration function

End user OEM Preventive maintenance Troubleshooting

Ensure worry-free operation even in the event of a servo amplifier failure by backing up programs and parameters with the on-site GOT

Challenges

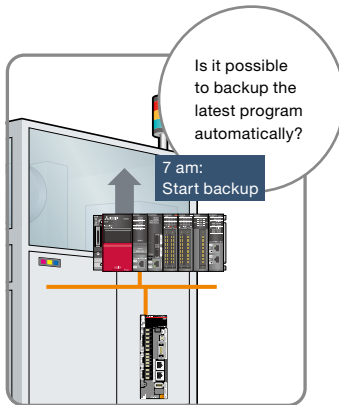

How can I backup programs and parameters of servo system periodically?

Solutions

Backup or restore programs of a motion controller or parameters of a servo amplifier to or from the GOT's SD memory card or USB memory. You can specify a trigger device, a day of the week, and time for automatic backup. The function makes it easier to backup data at the end of the day, before the weekend, or before the holiday. You can perform batch operation to restore the data to the servo amplifier.

- <Supported models>
- R64MTCPU/R32MTCPU/R16MTCPU
 - Q173DSCPU/Q172DSCPU
 - Q170MSCPU(-S1)
 - Q170MCPUCPU(-S1)
 - Q173DCPU(-S1)/Q172DCPU(-S1)
 - Q173HCPUCPU/Q172HCPUCPU
 - Q173CPU(N)/Q172CPU(N)
 - MR-J4-□GF

* Motion CPU (MELSEC-Q Series) should be SV13 or SV22.
* For the details of production number and the OS version supported by QCPU, please refer to the relevant product manual.

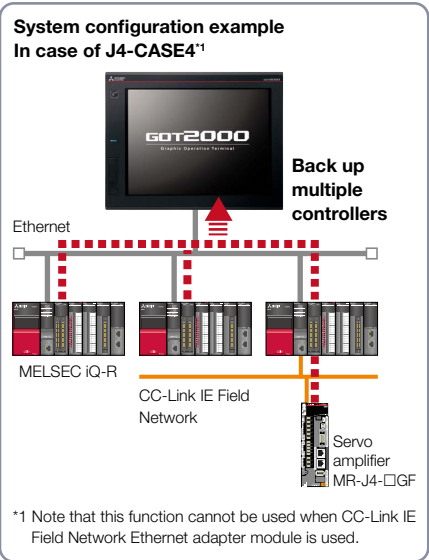

*1 Note that this function cannot be used when CC-Link IE Field Network Ethernet adapter module is used.

●: Supported —: Not supported

No.	Function	MR-J5-□G(-RJ) MR-J5W2-□G MR-J5W3-□G	MR-J5D1-□G4 MR-J5D2-□G4 MR-J5D3-□G4	MR-J5-□B(-RJ) MR-J5W2-□B MR-J5W3-□B	MR-J4-□B(-RJ) MR-J4W2-□B MR-J4W3-□B	MR-J4-□A(-RJ)	MR-J4-□GF(-RJ)	MR-JET-□G	MR-JE-□B	MR-JE-□A	MR-JE-□C
1	Servo amplifier graph function (maintenance)	●	●	—	●	—	—	●	●	—	—
2	Backup/Restoration function	—	—	—	—	—	●*	—	—	—	—

* MR-J4-□GF only

Monitor function

Sample screen End user OEM Troubleshooting

The screens can be used to display the status of the servo amplifier in operation and the I/O signals

The servo motor speed, torque, bus voltage and input/output signals of the servo amplifier can be displayed on the GOT and GT SoftGOT2000.

Sample screens

Operation monitor screen

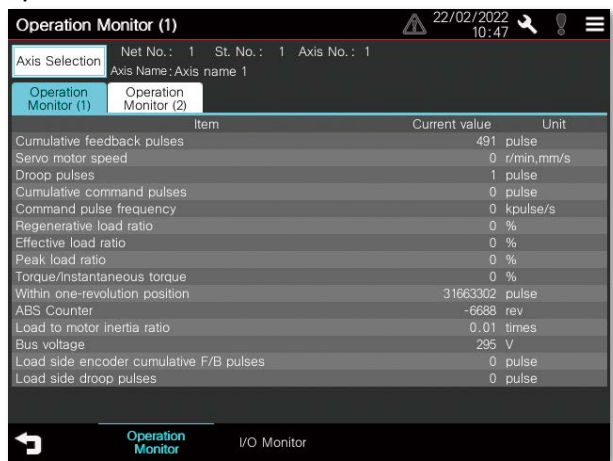

Operation monitor screen

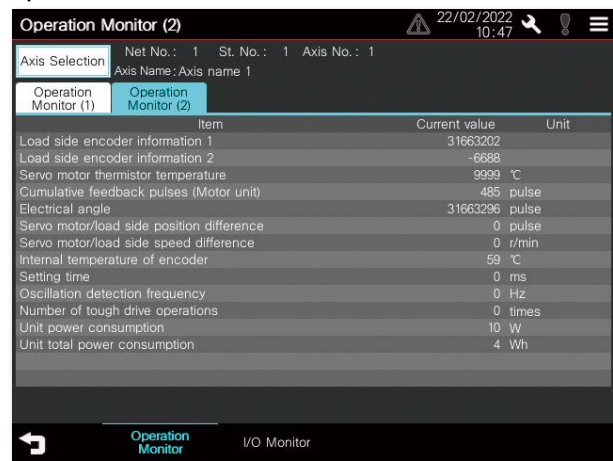

I/O monitor screen * For 1-axis servo amplifier

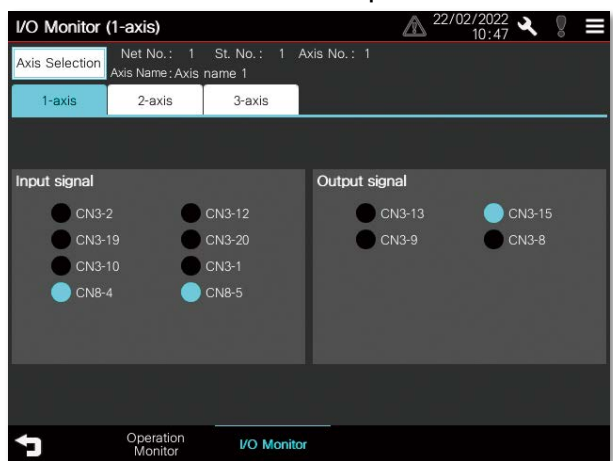

I/O monitor screen * For multi-axis servo amplifiers

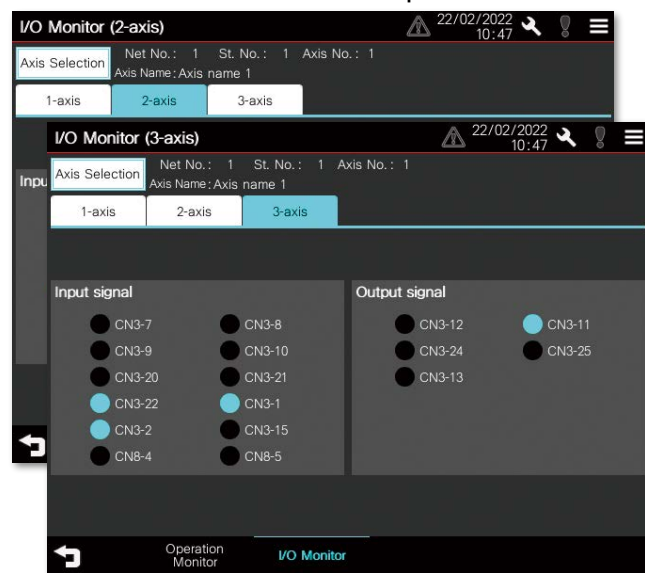

* All of the above images are the connection sample screens of MR-J5-□G.

No.	Function	MR-J5-□G(-RJ) MR-J5W2-□G MR-J5W3-□G	MR-J5D1-□G4 MR-J5D2-□G4 MR-J5D3-□G4	MR-J5-□B(-RJ) MR-J5W2-□B MR-J5W3-□B	MR-J4-□B(-RJ) MR-J4W2-□B MR-J4W3-□B	MR-J4-□A(-RJ)	MR-J4-□GF(-RJ)	MR-JET-□G	MR-JE-□B	MR-JE-□A	MR-JE-□C
1	Operation monitor	●	●	●	●	●	●	●	●	●	●
2	Input/output monitor	●	●	●	●	●	●	●	●	●	●

●: Supported —: Not supported

Key Feature 13 MR-J4

GT27 GT25 GT21 SoftGOT (Single-ch) SoftGOT (Multi-ch)

R motion monitor function/Q motion monitor function

Dedicated screen End user OEM Troubleshooting

Monitor and edit servo parameters of a motion controller using the on-site GOT

Challenges

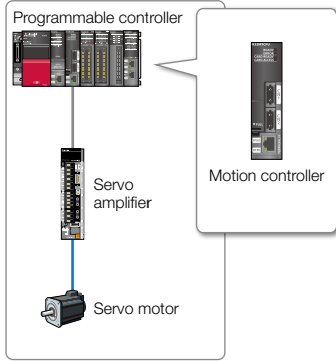

Can I check and change servo parameters of a motion controller easily?

Solutions

The R motion monitor function and Q motion monitor function allow you to monitor the motion controller and edit servo parameters.

R motion monitor screen

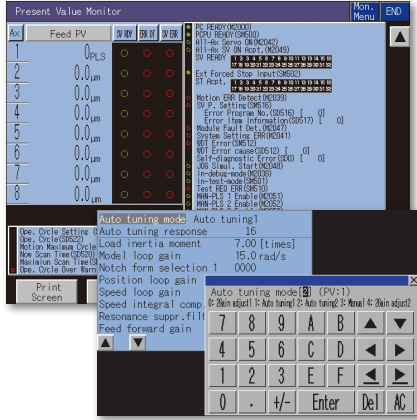

Parameter setting screen

<Supported models>

- R64MTCPU/R32MTCPU/R16MTCPU
- Q173DSCPU/Q172DSCPU
- Q170MSCPU(-S1)
- * Motion CPU (MELSEC-Q Series) should be SV13 or SV22. Supported contents of the Q motion monitor function vary depending on the CPU model.
- * For the details of supported devices and connection types, please refer to the relevant product manual.

Key Feature 14 MR-J4

GT27 GT25 GT21 SoftGOT (Single-ch) SoftGOT (Multi-ch)

R motion SFC monitor function/Q motion SFC monitor function

Dedicated screen End user OEM Troubleshooting

Check motion SFC programs using the on-site GOT

Challenges



How can I check motion SFC programs without a PC?

Solutions

GOT can be used to monitor motion SFC programs and device values of a Motion CPU (MELSEC iQ-R Series, MELSEC-Q Series) connected to the GOT. Viewing the program batch monitor or active step list enables you to check the complete status at a glance.

Program tabs

Touch a tab to display the program.

Step/transition

The active step is highlighted. Touch the step to display the detail program window. The SFC diagram scrolls automatically along with the progress of active steps.

Detail program window

Displays the program and the present value of the calculation control step/transition.

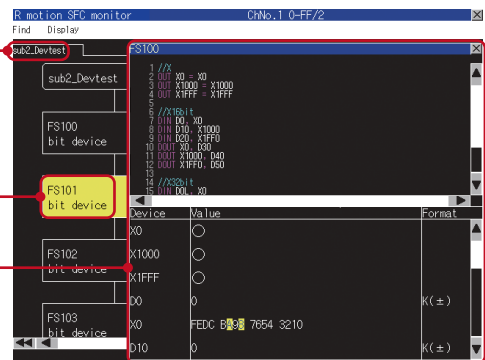

<Supported models>

- Motion CPU (MELSEC iQ-R Series, MELSEC-Q Series)
- * Motion CPU (MELSEC iQ-R Series, MELSEC-Q Series) requires the main OS and an add-on library that supports G code control.
- * Motion CPU (MELSEC-Q Series) should be SV13 or SV22.
- * For the details of production number and the OS version supported by Motion CPU (MELSEC-Q Series), please refer to the relevant product manual.

●: Supported —: Not supported

No.	Function	MR-J5-□G(-RJ) MR-J5W2-□G MR-J5W3-□G	MR-J5D1-□G4 MR-J5D2-□G4 MR-J5D3-□G4	MR-J5-□B(-RJ) MR-J5W2-□B MR-J5W3-□B	MR-J4-□B(-RJ) MR-J4W2-□B MR-J4W3-□B	MR-J4-□A(-RJ)	MR-J4-□GF(-RJ)	MR-JET-□G	MR-JE-□B	MR-JE-□A	MR-JE-□C
1	R motion monitor function	—	—	—	●	—	—	—	—	—	—
2	Q motion monitor function	—	—	—	●	—	—	—	—	—	—
3	R motion SFC monitor function NEW	—	—	—	●	—	—	—	—	—	—
4	Q motion SFC monitor function	—	—	—	●	—	—	—	—	—	—

Key Feature 15

MR-J4

GT27 GT25 GT21 SoftGOT (Single-ch) SoftGOT (Multi-ch)

Motion program editor function

Dedicated screen End user OEM Maintenance Troubleshooting

Display and edit motion programs (G-code programs) on the on-site GOT

Challenges



An error occurred during production. Can I edit the motion programs (G-code programs) at the worksite?

Solutions

Motion programs (G-code programs) can be edited in the dedicated screen of the motion program editor function of the GOT.

- * Supported by GOTs with a resolution of SVGA or higher.
- * To use G-code control, the G-code add-on library (paid) must be installed.

<Supported models>

- R64MTCPU/R32MTCPU/R16MTCPU (valid when the G-code add-on library is used)

Select a motion CPU and touch Program List

Select a program to edit and touch Select

5 Maintenance

Key Feature 16

MR-J4

GT27 GT25 GT21* SoftGOT (Single-ch) SoftGOT (Multi-ch)

* GT21 does not support the dedicated screens.

Servo amplifier monitor function

Sample screen Dedicated screen End user OEM Troubleshooting

Support the startup and adjustment of MR-J4-□A(-RJ) using the on-site GOT

Challenges

It's bothersome to design setting screen from scratch...



How can I check the status of the servo amplifier easily?

Solutions

In a system which outputs pulse trains, the GOT can be connected to a servo amplifier in a serial connection (RS-422) to perform the following operations: set up, monitoring, alarm display, diagnosis, parameter setting, and test operations.

Dedicated screens

MR-J4 Servo amp. Monitor [OS]			
Cumulative feedback pulses	-1061092 pulse	Within operation position	4066396 pulse
Servo motor speed	0 r/min	ABS counter	-627 rev
Droop pulses	1 pulse	Load to motor inertia ratio	7.00 times
Cumulative command pulses	0 pulse	Bus voltage	310 V
Command pulse frequency	0 kbps	Encoder internal temperature	58 °C
Analog speed command voltage	-0.05 V	Settling time	2 ms
Analog torque command voltage	0.00 V	Oscillation detection frequency	0 Hz
Regenerative load ratio	0 %	Tough drive times	0 times
Effective load ratio	0 %	Unit power consumption	10 g
Peak load ratio	0 %	Unit total power consumption	10 Wh
Instantaneous torque	0 %		

Sample screens (VGA)

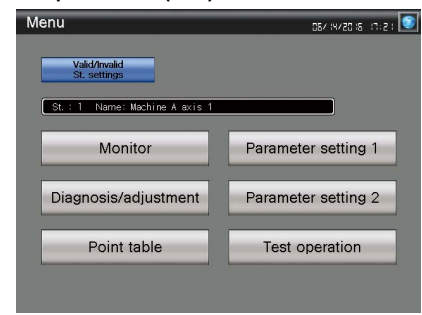

Without creating screens, parameters can be monitored and written from dedicated screens.

* GT21 does not support the dedicated screens.

Various sample screens such as monitoring, parameter settings, test operations are available and they are all customizable.

* Sample screens for GT21 are available in 480 × 272.

● : Supported — : Not supported

No.	Function	MR-J5-□G(-RJ) MR-J5W2-□G MR-J5W3-□G	MR-J5D1-□G4 MR-J5D2-□G4 MR-J5D3-□G4	MR-J5-□B(-RJ) MR-J5W2-□B MR-J5W3-□B	MR-J4-□B(-RJ) MR-J4W2-□B MR-J4W3-□B	MR-J4-□A(-RJ)	MR-J4-□GF(-RJ)	MR-JET-□G	MR-JE-□B	MR-JE-□A	MR-JE-□C
1	Motion program editor function	—	—	—	●	—	—	—	—	—	—
2	Servo amplifier monitor function	—	—	—	—	●	—	—	—	—	—

Key Feature 17
MR-J4 MR-JE

GT27 GT25 GT21 SoftGOT (Single-ch) SoftGOT (Multi-ch)
Dedicated screen End user OEM Troubleshooting

Intelligent module monitor function

Check the positioning module, status, or parameters on the on-site GOT

Challenges

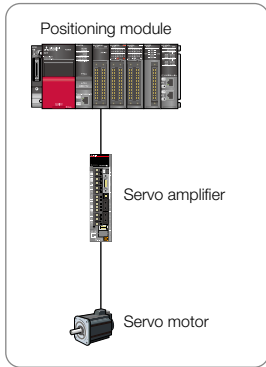

How can I debug positioning systems efficiently?

Solutions

You can debug positioning systems efficiently by displaying the data such as the status, parameters, and the I/O information of positioning module axes on GOT while monitoring positioning sequence programs on a PC simultaneously.

* For the details of supported devices and connection types, please refer to the relevant product manual.

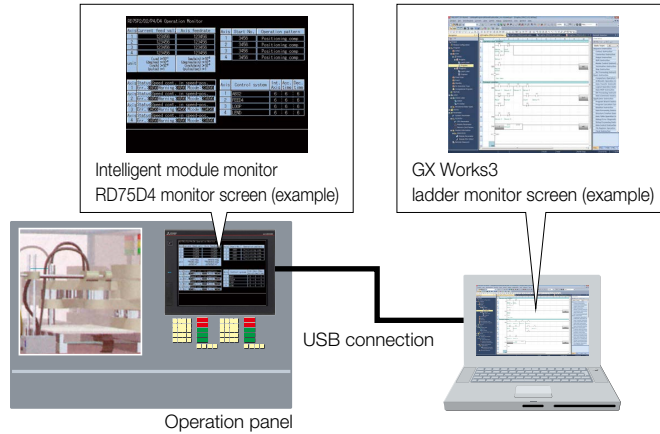

5 Maintenance

Key Feature 18
MR-J5 MR-J4 MR-JET MR-JE

GT27 GT25 GT21 SoftGOT (Single-ch)* SoftGOT (Multi-ch)
Sample screen End user OEM Troubleshooting

Alarm display function

Check alarm documentation stored on the GOT

Challenges

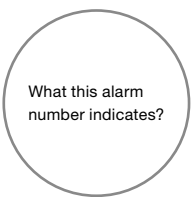

How can I check the details of an alarm that occurred on a servo amplifier?

Solutions

You can view alarms or warnings that are occurring and have occurred in the past, along with the number, message, and time of occurrence. Use the document display function to display the servo amplifier user's manual and quickly check troubleshooting procedures on the GOT.

* The document display function is not supported by GT21.

Alarm display screen

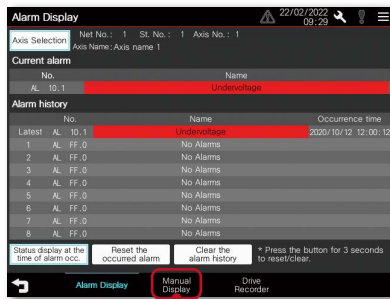

Touch here to display the detail information

Document display screen

* Not supported by GT21.

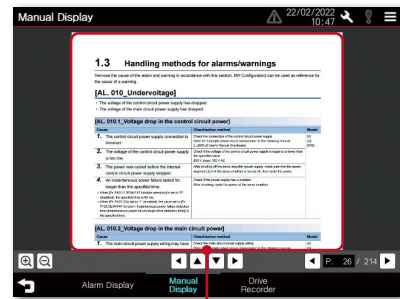

Display the PDF data and check the alarm details and corrective actions

* The screen image shown is the connection sample screen of MR-J5-□G.

No.	Function	MR-J5-□G(-RJ) MR-J5W2-□G MR-J5W3-□G	MR-J5D1-□G4 MR-J5D2-□G4 MR-J5D3-□G4	MR-J5-□B(-RJ) MR-J5W2-□B MR-J5W3-□B	MR-J4-□B(-RJ) MR-J4W2-□B MR-J4W3-□B	MR-J4-□A(-RJ)	MR-J4-□GF(-RJ)	MR-JET-□G	MR-JE-□B	MR-JE-□A	MR-JE-□C
1	Intelligent module monitor function	-	-	-	●	●	●	-	●	●	●
2	Alarm display function	●	●	●	●	●	●	●	●	●	●

●: Supported —: Not supported

Encoder communication circuit diagnosis

Sample screen End user Troubleshooting

The on-site GOT identifies the cause of an alarm generated by communication with the encoder

Challenges

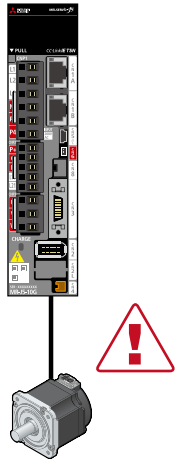

The encoder is acting strange. I need to bring a PC to check.

Solutions

When an encoder communication alarm occurs, you can use GOT to diagnose and determine whether the cause of the alarm is a servo amplifier failure or an encoder failure without preparing a PC.

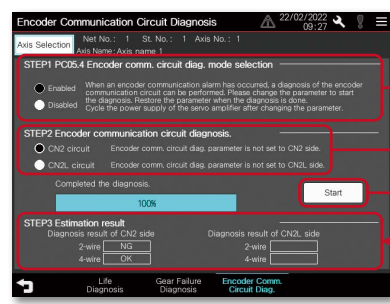

- STEP1: Select a diagnosis mode
- STEP2: Select a connector to be diagnosed
- STEP3: Start diagnosis
- STEP4: Diagnosis result

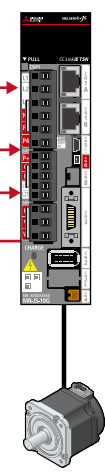

* The screen image shown is the connection sample screen of MR-J5-□G.

Machine diagnosis (friction estimation, vibration estimation)

Sample screen End user Predictive maintenance Maintenance

The on-site GOT provides information on when to perform maintenance on components such as ball screws and linear guides

Challenges

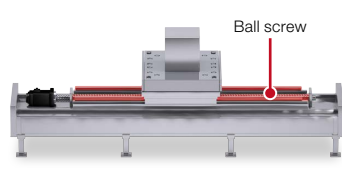

I want to know when to perform maintenance on components such as ball screws and linear guides.

Solutions

Maintenance can be performed on the machine before it fails because the servo amplifier estimates the friction and vibration of the drive unit, and GOT shows you a failure prediction warning.

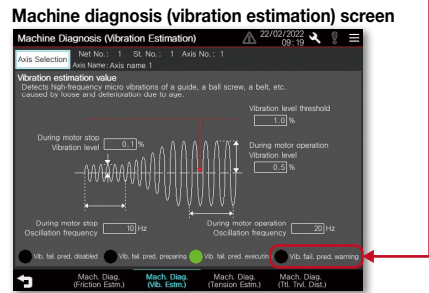
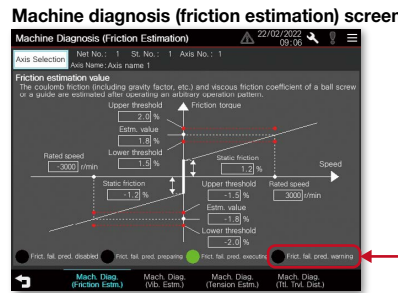
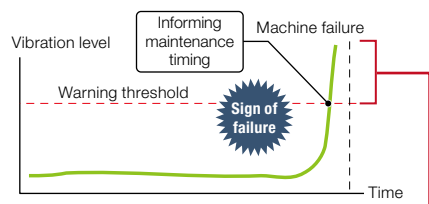
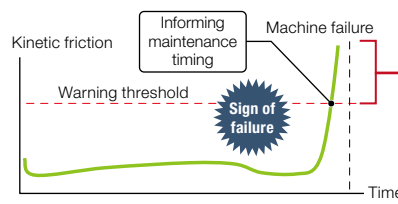

* The screen image shown is the connection sample screen of MR-J5-□G.

●: Supported —: Not supported

No.	Function	MR-J5-□G(-RJ) MR-J5W2-□G MR-J5W3-□G	MR-J5D1-□G4 MR-J5D2-□G4 MR-J5D3-□G4	MR-J5-□B(-RJ) MR-J5W2-□B MR-J5W3-□B	MR-J4-□B(-RJ) MR-J4W2-□B MR-J4W3-□B	MR-J4-□A(-RJ)	MR-J4-□GF(-RJ)	MR-JET-□G	MR-JE-□B	MR-JE-□A	MR-JE-□C
1	Encoder communication circuit diagnosis	●	●	●	—	—	—	●	—	—	—
2	Machine diagnosis (friction estimation, vibration estimation)	●	●	●	—	—	—	●	—	—	—

Key Feature 21 MR-J5 MR-JET

GT27 GT25 GT21 SoftGOT (Single-ch) SoftGOT (Multi-ch)

Machine diagnosis (tension estimation)

Sample screen End user Predictive maintenance Maintenance

The on-site GOT allows you to see the timing for belt maintenance

Challenges

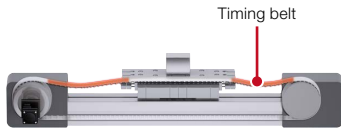

I want to know the belt's maintenance timing.

Solutions

The servo amplifier estimates the tension deterioration of the belt connected to the servo motor, and GOT displays a tension deterioration warning, allowing maintenance to be performed at an appropriate timing.

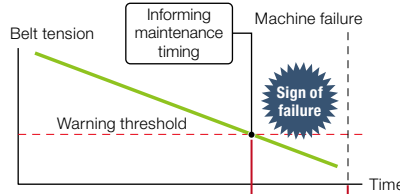

Machine diagnosis (tension estimation) (1) screen

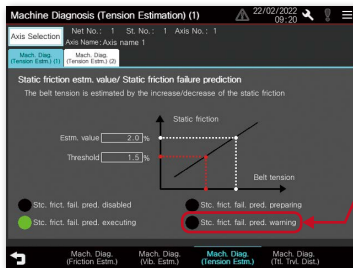

Machine diagnosis (tension estimation) (2) screen

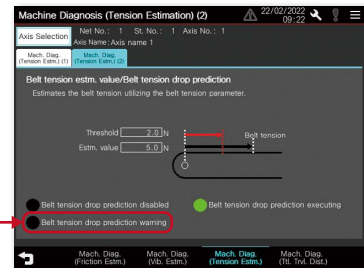

* The screen image shown is the connection sample screen of MR-J5-□G.

5 Maintenance

Key Feature 22 MR-J5 MR-JET

GT27 GT25 GT21 SoftGOT (Single-ch) SoftGOT (Multi-ch)

Machine diagnosis (total travel distance)

Sample screen End user Predictive maintenance Maintenance

The on-site GOT provides information on when to replace and maintain servo motors and machine parts

Challenges

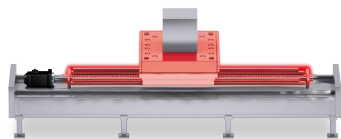

I want to know the replacement and maintenance timing for the servo motor and other mechanical parts.

Solutions

The GOT displays the total travel distance of the servo motor as an estimate for determining the timing of replacement and maintenance of both the servo motor and mechanical parts.

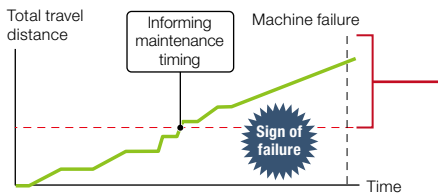

Machine diagnosis (total travel distance) screen

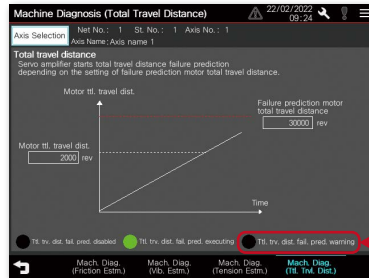

By setting [Pr. PF34.2 Servo motor total travel distance failure prediction warning selection], a warning will be displayed when the total travel distance of the servo motor exceeds the threshold.

* The screen image shown is the connection sample screen of MR-J5-□G.

40

●: Supported —: Not supported

No.	Function	MR-J5-□G(-RJ) MR-J5W2-□G MR-J5W3-□G	MR-J5D1-□G4 MR-J5D2-□G4 MR-J5D3-□G4	MR-J5-□B(-RJ) MR-J5W2-□B MR-J5W3-□B	MR-J4-□B(-RJ) MR-J4W2-□B MR-J4W3-□B	MR-J4-□A(-RJ)	MR-J4-□GF(-RJ)	MR-JET-□G	MR-JE-□B	MR-JE-□A	MR-JE-□C
1	Machine diagnosis (tension estimation)	●	●	●	—	—	—	●	—	—	—
2	Machine diagnosis (total travel distance)	●	●	●	—	—	—	●	—	—	—

Gear Failure Diagnosis

You can check if the gear is broken on the on-site GOT

Challenges

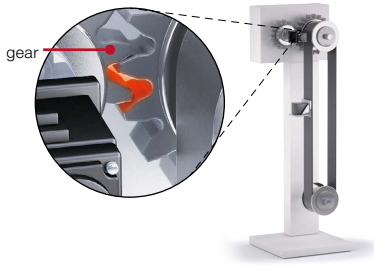

Can I check the wear of the gear without connecting to a PC?

Solutions

By checking and grasping the aging deterioration information of the gear acquired from the servo amplifier on the on-site the GOT, the system stop due to the failure can be prevented.

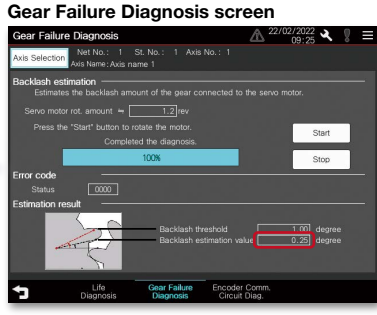

* The screen image shown is the connection sample screen of MR-J5-□G.

- Backlash estimation
Backlash estimation is performed by entering valid values for [Pr. PF66.0-3 Gear for backlash estimation - Numerator] and [Pr. PF66.4-7 Gear for backlash estimation - Denominator].
- Gear failure estimation
Gear failure prediction is performed by entering valid values for [Pr. PF67 Backlash nominal value] and [Pr. PF68 Backlash threshold multiplication]. Please compare the backlash estimation value of the estimation result with the backlash presented by the gear manufacturer.

●: Supported —: Not supported

No.	Function	MR-J5-□G(-RJ) MR-J5W2-□G MR-J5W3-□G	MR-J5D1-□G4 MR-J5D2-□G4 MR-J5D3-□G4	MR-J5-□B(-RJ) MR-J5W2-□B MR-J5W3-□B	MR-J4-□B(-RJ) MR-J4W2-□B MR-J4W3-□B	MR-J4-□A(-RJ)	MR-J4-□GF(-RJ)	MR-JET-□G	MR-JE-□B	MR-JE-□A	MR-JE-□C
1	Gear Failure Diagnosis	●	●	●	—	—	—	●	—	—	—

Machine diagnosis function

Sample screen End user Predictive maintenance Maintenance

With the on-site GOT, you can find out the maintenance timing of the equipment drive parts

Challenges

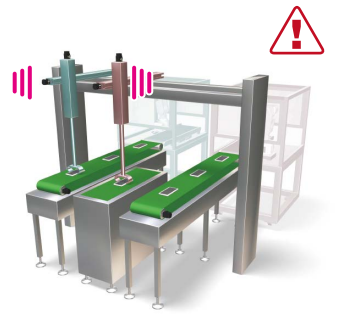

How can I predict deterioration of a machine if it has excessive load and is frequently accelerated?

Solutions

GOT can display estimated values (machine friction, torque vibration, etc.) that are collected by the machine diagnosis function of the servo amplifier. The difference between the initial value (at the startup) and the current value can be used to predict deterioration of the machine. Using this function with the GOT's alarm function will help you perform timely maintenance of machine parts.

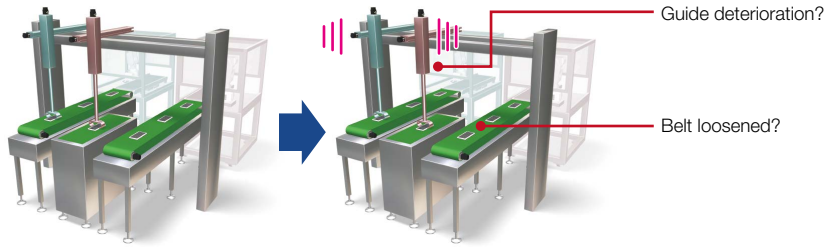

Machine before operation

Vibration increased after starting operation

Machine diagnosis screen

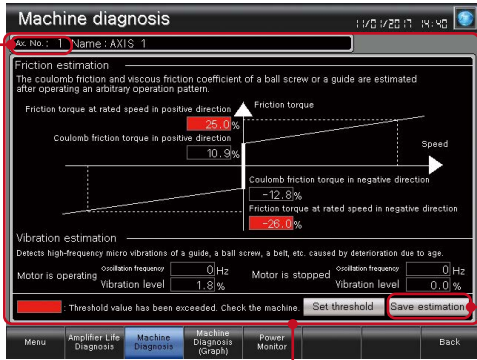

By switching the axis number, multiple axes can be maintained on the same screen.

Displays the estimated value upon completion of the machine diagnosis. When any of the estimation values exceed the threshold values that are set on the GOT, the numerical value display area turns red.

Descriptions of items on the machine diagnosis screen

Item	Description
Estimated friction value	Detect the estimated static friction (coulomb friction) (including gravity and etc.) and dynamic friction (viscous friction) coefficient of guides or ball screws according to the operation patterns.
Friction torque at rated speed (%)	Friction in operation at the rated speed. The value indicates the ratio (%) against the rated torque. The value increases as the machine deteriorates.
Static friction (coulomb friction) (%)	Regardless of the motor speed, a constant value is applied to friction. When an object begins to move, the torque must be greater than or equal to the static friction (coulomb friction) torque. The value indicates the ratio (%) against the rated torque. The value increases as the machine deteriorates.
Vibration estimation	The vibration estimation function observes the torque vibration and estimates the vibration level and the vibration frequency of high-frequency micro vibrations. This function allows checking of the increase of vibration level and the change in the vibration frequency that are caused by deterioration of a guide, a ball screw, a belt, etc. due to age.
Oscillation frequency (Hz)	Frequency of torque vibration when a machine vibrates during operation or when it is not operating. The value indicates the frequency when the machine oscillates due to a cause such as deterioration of the machine due to age.
Vibration level (%)	Torque amplitude when a machine vibrates during operation or when it is not operating. The value indicates the ratio (%) against the rated torque. The value increases as the machine oscillation increases due to a cause such as deterioration of the machine due to age.

Save estimation values to a file and compare the values to check the deterioration of the machine.

Friction estimation by using the machine diagnosis function

- Friction estimation results are obtained when the following conditions are satisfied:
- The machine was operated for 150 seconds or more at a motor rotation speed or linear servo motor speed equal to or above the value set for parameter [Pr. PF 31].
 - The machine was operated for 150 seconds or more at a motor rotation speed or linear servo motor speed below the value set for parameter [Pr. PF 31].

The value of parameter [Pr. PF 31] is treated as an absolute value. Use a positive number for operating the machine in the forward rotation direction and a negative number for operating it in the reverse rotation direction.

In the case of the operation pattern shown in Figure 1, when both (a)+(c) and (b) are operated in the forward rotation direction for 150 seconds or more, a friction estimation result can be obtained.

The friction estimation in the reverse rotation direction cannot be obtained because the speed during the reverse rotation direction operation ((d)) does not exceed the value of parameter [Pr. PF 31].

Change the value of parameter [Pr. PF 31] and perform the friction estimation. Also, when the value of the parameter [Pr. PF 31] is 0, the threshold value is the rated rotational speed or half the rated speed.

* PF31: Machine diagnosis function - Friction judgment speed
 * For the details of the machine diagnosis function, please refer to MR Configurator2 Help.

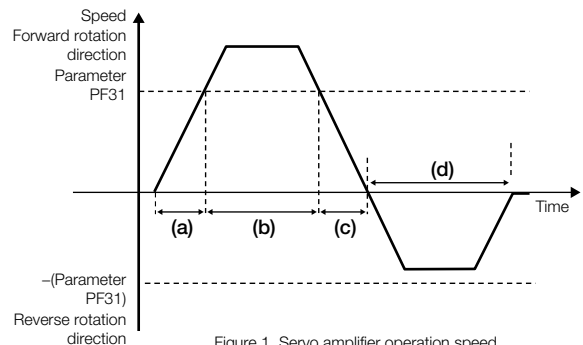

Figure 1. Servo amplifier operation speed

●: Supported —: Not supported

No.	Function	MR-J5-□G(-RJ) MR-J5W2-□G MR-J5W3-□G	MR-J5D1-□G4 MR-J5D2-□G4 MR-J5D3-□G4	MR-J5-□B(-RJ) MR-J5W2-□B MR-J5W3-□B	MR-J4-□B(-RJ) MR-J4W2-□B MR-J4W3-□B	MR-J4-□A(-RJ)	MR-J4-□GF(-RJ)	MR-JET-□G	MR-JE-□B	MR-JE-□A	MR-JE-□C
1	Machine diagnosis function	—	—	—	●	●	●	—	●	●	●

Machine failure prediction function

End user Predictive maintenance Maintenance

Notify maintenance timing of equipment drive parts using the on-site GOT

Challenges

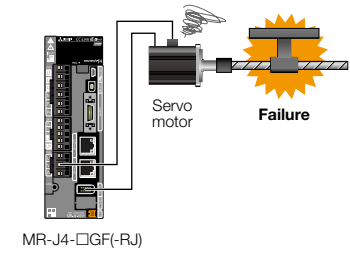

How can I perform predictive maintenance of equipment drive parts?

Solutions

By setting devices of MR Configurator2 machine failure prediction function to numerical display objects of GT Works3, you can predict deterioration of the servo amplifier drive parts by checking the GOT.

* The failure prediction function can be used on MR-J4-□GF(-RJ) servo amplifier with the software version A3 or later. This function does not guarantee prediction of all failures.

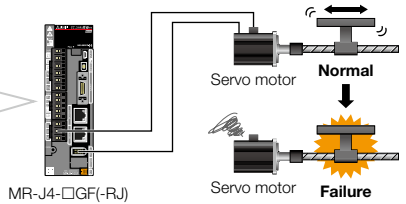
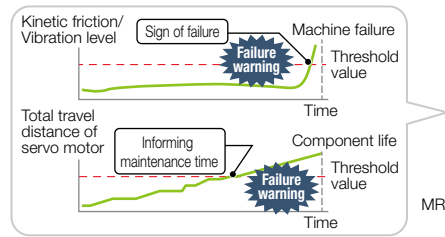

MR Configurator2 Version 1.68W screen

Device name	Item	Symbol
MD3	Machine diagnosis data Static friction at forward rotation torque	-
MD4	Machine diagnosis data Dynamic friction at forward rotation torque (at rated speed)	-
MD5	Machine diagnosis data Static friction at reverse rotation torque	-
MD6	Machine diagnosis data Dynamic friction at reverse rotation torque (at rated speed)	-
MD11	Machine diagnosis data Rated speed	-
MD15	Machine diagnosis data Friction failure prediction - Upper limit threshold	-
MD16	Machine diagnosis data Friction failure prediction - Lower limit threshold	-
PF19, PF1019	Friction failure prediction - Compensation coefficient 1	TSL
PF20, PF1020	Friction failure prediction - Compensation coefficient 2	TIC
PF31, PF1031	Machine diagnosis function - Friction judgment speed	FRIC
PF34, PF1034	Machine diagnosis function selection	*MFP
PF40, PF1040	Machine failure prediction parameter	MFPP
PF41, PF1041	Failure prediction - Servo motor travel distance	FPMT
PF42, PF1042	Friction failure prediction - Average characteristic	PAV
PF43, PF1043	Friction failure prediction - Standard deviation	PSD
MD7	Machine diagnosis data Vibration frequency during stop/servo-lock	-
MD8	Machine diagnosis data Vibration level during stop/servo-lock	-
MD9	Machine diagnosis data Vibration frequency during operation	-
MD10	Machine diagnosis data Vibration level during operation	-
MD17	Machine diagnosis data Vibration level threshold	-
PF34, PF1034	Machine diagnosis function selection	*MFP
PF40, PF1040	Machine failure prediction parameter	MFPP
PF45, PF1045	Vibration failure prediction - Average characteristic	VAV
PF46, PF1046	Vibration failure prediction - Standard deviation	VSC
MD14	Machine diagnosis data Servo motor travel distance	-
PF34, PF1034	Machine diagnosis function selection	*MFP
PF41, PF1041	Failure prediction - Servo motor travel distance (graph side) PF41 x PF34 multiplication numerator	-

* For details, please refer to the MR-J4-□GF(-RJ) Servo Amplifier Instruction Manual (Motion Mode) (SH(NA)-030218ENG).

●: Supported - : Not supported

No.	Function	MR-J5-□G(-RJ) MR-J5W2-□G MR-J5W3-□G	MR-J5D1-□G4 MR-J5D2-□G4 MR-J5D3-□G4	MR-J5-□B(-RJ) MR-J5W2-□B MR-J5W3-□B	MR-J4-□B(-RJ) MR-J4W2-□B MR-J4W3-□B	MR-J4-□A(-RJ)	MR-J4-□GF(-RJ)	MR-JET-□G	MR-JE-□B	MR-JE-□A	MR-JE-□C
1	Machine failure prediction function	-	-	-	-	-	●	-	-	-	-

Key Feature 26

MR-J5 MR-J4 MR-JET MR-JE

* Supported by MR-J4-□B(-RJ), MR-J4W2-□B, MR-J4W3-□B, MR-JE-□B only. See page 16 for details.

GT27 GT25 GT21 SoftGOT (Single-ch)* SoftGOT (Multi-ch)

Servo amplifier life diagnosis function

Sample screen End user Visualization Predictive maintenance

Supports predictive maintenance functions of servo amplifiers

Challenges



Is it possible to check the life of the servo amplifier with GOT without connecting it to a PC?

Solutions

Cumulative operation time, on/off counts of inrush relay, and replacement timing of servo amplifier components (capacitor, relay) can be checked on the GOT. Also, you can notify the replacement timing of servo amplifier components to on-site workers by using the GOT alarm function.



Periodic check

Life diagnosis screen

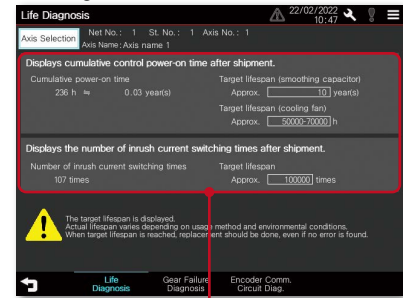

* The screen image shown is the connection sample screen of MR-J5-□G.

Check the smoothing capacitor energization time or the inrush relay on/off times at a glance

Key Feature 27

MR-J5 MR-J4 MR-JET MR-JE

* Supported by MR-J4-□B(-RJ), MR-J4W2-□B, MR-J4W3-□B, MR-JE-□B only. See page 16 for details.

GT27 GT25 GT21 SoftGOT (Single-ch)* SoftGOT (Multi-ch)

Switching axis numbers (station numbers) of servo amplifiers

Sample screen End user OEM Maintenance

Adjust and maintain multiple axes on one screen

Challenges

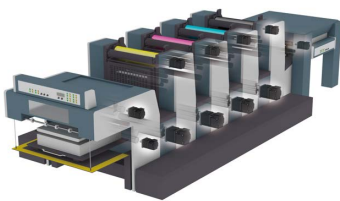

Creating a screen for each axis of a servo amplifier is time-consuming and can result in increased data storage usage.

Solutions

GOT can be used to monitor axes of servo amplifiers by switching the axis numbers so that you can adjust and maintain multiple axes on one screen. You can reduce the number of screens and also reduce the time for screen creation and equipment maintenance.

Switching MR-J5-□G axis numbers (station numbers) from 1 to 5

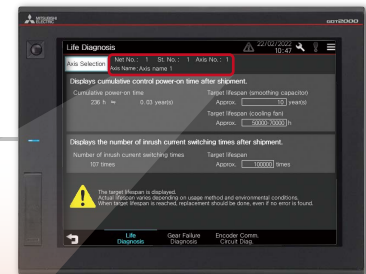
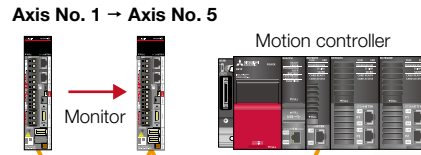

* The screen image shown is the connection sample screen of MR-J5-□G.

Switch to the axis number (station number) of the servo amplifier you want to monitor

Net No.: 1 Station No.: 1 Axis No.: 1
Axis name: Axis name 1

Net No.: 1 Station No.: 2 Axis No.: 5
Axis name: Axis name 5

●: Supported —: Not supported

No.	Function	MR-J5-□G(-RJ) MR-J5W2-□G MR-J5W3-□G	MR-J5D1-□G4 MR-J5D2-□G4 MR-J5D3-□G4	MR-J5-□B(-RJ) MR-J5W2-□B MR-J5W3-□B	MR-J4-□B(-RJ) MR-J4W2-□B MR-J4W3-□B	MR-J4-□A(-RJ)	MR-J4-□GF(-RJ)	MR-JET-□G	MR-JE-□B	MR-JE-□A	MR-JE-□C
1	Servo amplifier life diagnosis function	●	●	●	●	●	●	●	●	●	●
2	Switching axis numbers (station numbers) of servo amplifiers	●	●	●	●	●	●	●	●	●	●

Sample screens

Easy to use sample screens of various interactive functions

Sample screens are available for changing servo amplifier parameters, monitoring, and testing operations from the GOT2000 and GT SoftGOT2000. To reuse sample screens, you can select the whole project or individual screens. Sample screens are included with GT Works3.

In the GT Works3 menu, select [Project] → [Utilize Data].

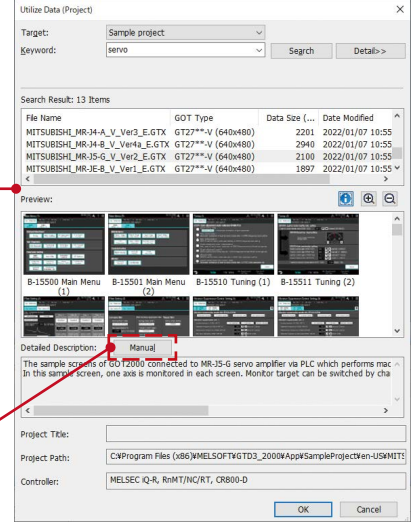
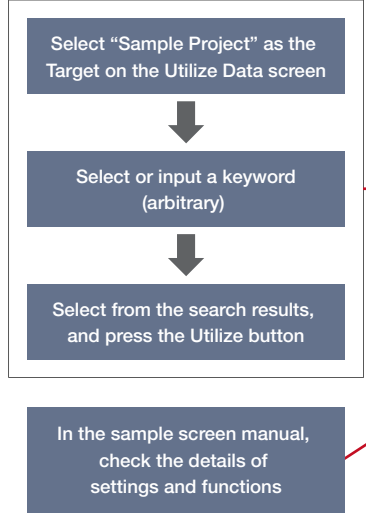

[Screen specifications]
 GOT type: GT27**-V (640 × 480)
 : GT2104-R (480 × 272)
 : GS21**-W-N (800×480)

* The data can be used for GOTs with different resolutions by changing the GOT type.

[Compatible language]
 English, Japanese, Chinese (Simplified)

How to obtain sample screens

Sample screens are included with GT Works3. If you would like to obtain the latest sample screen data, please contact your local sales office.

* Supported by MR-J4-□B(-RJ), MR-J4W2-□B, MR-J4W3-□B, MR-JE-□B only. See page 16 for details.

User-created screen

Create monitor screens by the users flexibly

Users can create screens and set data to be monitored flexibly. If there is no sample screens for the model you wish to use such as MR-J4-□GF or MR-J5D1-□G4, monitoring is possible by setting the parameters and devices in the numerical displays and lamps. Various connection types can be used so that you can create screens depending on the system.

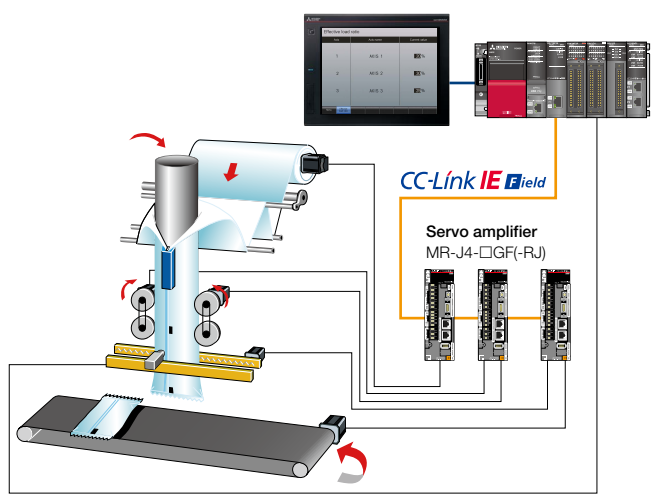

Effective load ratio		
Axis	Axis name	Current value
1	AXIS 1	20%
2	AXIS 2	30%
3	AXIS 3	25%

An example of displaying multiple axes information in one screen. Screens can be created flexibly to monitor necessary information.

●: Supported —: Not supported

No.	Function	MR-J5-□G(-RJ) MR-J5W2-□G MR-J5W3-□G	MR-J5D1-□G4 MR-J5D2-□G4 MR-J5D3-□G4	MR-J5-□B(-RJ) MR-J5W2-□B MR-J5W3-□B	MR-J4-□B(-RJ) MR-J4W2-□B MR-J4W3-□B	MR-J4-□A(-RJ)	MR-J4-□GF(-RJ)	MR-JET-□G	MR-JE-□B	MR-JE-□A	MR-JE-□C
1	Sample screens	●	—	●	●	●	—	●	●	●	—
2	User-created screen	●	●	●	●	●	●	●	●	●	●

HMI lineup







GOT2000 Series

GT27

Advanced model with multi-touch gesture functions

Ethernet RS-232 RS-422/485 CC-Link IE TSN CC-Link IE Control CC-Link IE Field*1 CC-Link IE Field Basic CC-Link Bus MELSECNET

*1 The CC-Link IE Field Network communication unit and GOT set is also available.

<p>15 inch</p> <p>TFT 65536 colors AC DC</p>  <p>XGA 1024x768</p> <p>GT2715-XTBA GT2715-XTBD</p>	<p>12.1 inch</p> <p>TFT 65536 colors AC DC</p>  <p>SVGA 800x600</p> <p>GT2712-STBA GT2712-STBD GT2712-STWA [White model] GT2712-STWD [White model]</p>	<p>10.4 inch</p> <p>TFT 65536 colors AC DC</p>  <p>SVGA 800x600</p> <p>GT2710-STBA GT2710-STBD</p> <p>VGA 640x480</p> <p>GT2710-VTBA GT2710-VTBD GT2710-VTWA [White model] GT2710-VTWD [White model]</p>	<p>8.4 inch</p> <p>TFT 65536 colors AC DC</p>  <p>SVGA 800x600</p> <p>GT2708-STBA GT2708-STBD</p> <p>VGA 640x480</p> <p>GT2708-VTBA GT2708-VTBD</p>
---	---	---	---





High performance, cost efficient, mid-range model

GT25

Ethernet RS-232 RS-422/485 CC-Link IE TSN*2 CC-Link IE Control*2 CC-Link IE Field*1*2 CC-Link IE Field Basic CC-Link*2 Bus*2 MELSECNET*2

Sound output*2 External I/O*2

*1 The CC-Link IE Field Network communication unit and GOT set is also available. *2 Not supported by GT2505.

<p>12.1 inch</p> <p>TFT 65536 colors AC DC</p>  <p>SVGA 800x600</p> <p>GT2512-STBA GT2512-STBD</p>	<p>10.4 inch</p> <p>TFT 65536 colors AC DC</p>  <p>VGA 640x480</p> <p>GT2510-VTBA GT2510-VTBD GT2510-VTWA [White model] GT2510-VTWD [White model]</p>	<p>8.4 inch</p> <p>TFT 65536 colors AC DC</p>  <p>VGA 640x480</p> <p>GT2508-VTBA GT2508-VTBD GT2508-VTWA [White model] GT2508-VTWD [White model]</p>	<p>5.7 inch</p> <p>TFT 65536 colors DC</p>  <p>VGA 640x480</p> <p>GT2505-VTBD</p>
--	---	---	---

GT25

GOT2000 widescreen expands your view

Wide Ethernet (2 ports) RS-232 RS-422/485 CC-Link IE Field Basic Sound output (built-in)

<p>12.1 inch</p> <p>TFT 65536 colors DC</p>  <p>WXGA 1280x800</p> <p>GT2512-WXTBD GT2512-WXTSD</p>	<p>10.1 inch</p> <p>TFT 65536 colors DC</p>  <p>WXGA 1280x800</p> <p>GT2510-WXTBD GT2510-WXTSD</p>	<p>7 inch</p> <p>TFT 65536 colors DC</p>  <p>WVGA 800x480</p> <p>GT2507-WTBD GT2507-WTSD</p>
--	--	---

Compact models with basic functions

GT21

Ethernet RS-232 RS-422/485 CC-Link IE Field Basic

Wide

GT21

Ethernet*1 RS-232*1 RS-422/485*1 CC-Link IE Field Basic*2

*1 Supported interfaces vary depending on the model. Please refer to descriptions in [] after the model.

*2 Supported only by the models equipped with an Ethernet port.

<p>7 inch</p> <p>TFT 65536 colors DC</p>  <p>WVGA 800x480</p> <p>GT2107-WTBD GT2107-WTSD</p>	<p>4.3 inch</p> <p>TFT 65536 colors DC</p>  <p>480x272</p> <p>GT2104-RTBD [Ethernet, RS-232, RS-422/485]</p>	<p>3.8 inch</p> <p>TFT mono-chrome DC</p>  <p>5-color LED</p> <p>320x128</p> <p>GT2103-PMBD [Ethernet, RS-422/485] GT2103-PMBDS [RS-232, RS-422/485] GT2103-PMBDS2 [RS-232 x 2 channels] GT2103-PMBLS [RS-422] 5 V DC type</p>
--	---	---

Multi-touch gesture Multimedia*2 Video/RGB*2 Sound output External I/O

*2 Not supported by GT2705.

5.7 inch

TFT
65536
colors DC



VGA
640x480

GT2705-VTBD

GT25

Open frame

A new style of GOT2000

Ethernet RS-232 RS-422/485 CC-Link IE TSN CC-Link IE Control CC-Link IE Field CC-Link IE Field Basic CC-Link Bus MELSECNET
Sound output External I/O

12.1 inch

TFT
65536
colors AC DC



SVGA
800x600

GT2512F-STNA
GT2512F-STND

10.4 inch

TFT
65536
colors AC DC



VGA
640x480

GT2510F-VTNA
GT2510F-VTND

8.4 inch

TFT
65536
colors AC DC



VGA
640x480

GT2508F-VTNA
GT2508F-VTND

GT25

Rugged

Ethernet (2 ports) RS-232 RS-422/485
CC-Link IE Field Basic Sound output (built-in)

7 inch

TFT
65536
colors DC



WVGA
800x480

GT2507T-WTSD

GT25

Handy

HMI functionality in the palm of your hand

Ethernet RS-232 RS-422/485*1 CC-Link IE Field Basic

*1 GT2505HS supports RS-422 only.

6.5 inch

TFT
65536
colors AC DC



VGA
640x480

GT2506HS-VTBD

5.7 inch

TFT
65536
colors AC DC



VGA
640x480

GT2505HS-VTBD

GOT2000 compatible HMI software

GT SoftGOT2000



USB port
license key



GT SoftGOT 2000 Version1

Make visualization of production
accessible

GOT Screen Design Software

MELSOFT GT Works3



GOT Screen Design Software
MELSOFT GT Works3

Professional designs in just a few clicks

For the status of conforming to various standards and laws, please contact your local sales office.

GOT2000



GOT2000

Graphic Operation Terminal

Designed to meet your industrial automation needs

The Graphic Operation Terminal GOT2000 Series continues to evolve and provide more solutions to customers

The GOT2000 boasts advanced functionality, acts as a seamless gateway to other industrial automation devices, all while increasing productivity and efficiency. The high quality display is designed to optimize operator control and monitoring of device and line statuses. If you are looking for an intuitive operation terminal, the new tablet-like operability and the higher functionality of operation terminal makes the GOT2000 the ideal choice. Incorporate the GOT2000 to bring forth flexibility, productivity, and quality on a global scale.



For details, please refer to the Mitsubishi Electric Graphic Operation Terminal GOT2000 Series catalog (L(NA)08270ENG).

MELSERVO-J5



MITSUBISHI ELECTRIC SERVO SYSTEM MELSERVO-J5

Create new value with MELSERVO-J5.
Unlock performance with a total drive solution.

Focused on improving total performance. The MELSERVO-J5 series servo system boasts industry-leading level basic performance. The high-speed, high-precision capabilities of MELSERVO-J5 help to increase the productivity of your machines.



For details, please refer to the Mitsubishi Electric AC Servo System MELSERVO-J5 catalog (L(NA)03179ENG).

MELSERVO-J4



MITSUBISHI SERVO AMPLIFIERS & MOTORS MELSERVO-J4

A complete system lineup to meet your production and manufacturing needs

To respond to an expanding range of applications including semiconductor and FPD manufacturing, robots, and food processing machines, MELSERVO-J4 combines with other Mitsubishi Electric product lines such as Motion controllers, networks, graphic operation terminals, programmable controllers and more. This gives you the freedom and flexibility to create a more advanced servo system.



For details, please refer to the Mitsubishi Electric Servo Amplifiers & Motors MELSERVO-J4 catalog (L(NA)03058).

MELSERVO-JET



MITSUBISHI ELECTRIC SERVO SYSTEM MELSERVO-JET

Create new value with MELSERVO-JET. Unlock performance with a total drive solution

Crafted from a different perspective, increase your productivity with a next generation servo system. The MELSERVO-JET Series servo system performs basic functions at a high level, while its high-speed, high-precision capabilities help increase the productivity of your machines.



For details, please refer to the Mitsubishi Electric AC Servo System MELSERVO-JET catalog (L(NA)03187ENG).

Related products

MELSERVO-JE

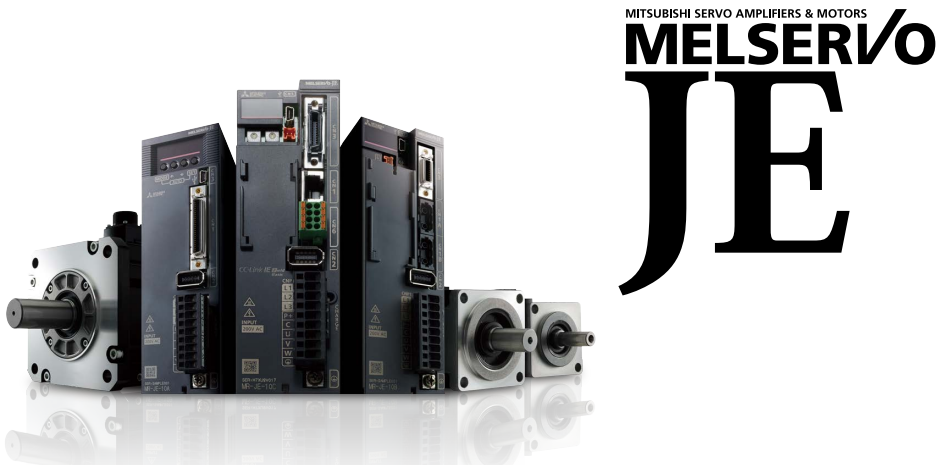

MITSUBISHI SERVO AMPLIFIERS & MOTORS
MELSERVO
JE

Apply servos to all machines with reliable basic performance and advanced ease-of-use!

With Mitsubishi Electric's commitment to total system solutions and global supports, the MELSERVO-JE becomes the answer to the world-wide needs in driving control.



For details, please refer to the Mitsubishi Electric Servo Amplifiers & Motors MELSERVO-JE catalog (L(NA)03086ENG).

GOT Drive Plus (Paid Template Screen)

GOT Drive^{plus}



MITSUBISHI GRAPHIC OPERATION TERMINAL
GOT2000 + MELSERVO-J4

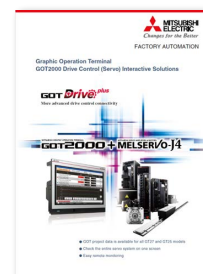

For details, please refer to the GOT2000 Drive Control (Servo) Interactive Solutions GOT Drive Plus catalog (L(NA)08594ENG).

Ready-to-use GOT project data is available for purchase. With this project data, you can cut down on design time and start your work or operation immediately without the need for a complex setup or screen creation.

All product and company names used herein are either trademarks or registered trademarks of their respective owners.

The actual color may differ slightly from the pictures in this catalog. The actual display may differ from what are shown on GOT screen images.

Precautions before use

This publication explains the typical features and functions of the products herein and does not provide restrictions or other information related to usage and module combinations. Before using the products, always read the product user manuals. Mitsubishi Electric will not be held liable for damage caused by factors found not to be the cause of Mitsubishi Electric; opportunity loss or lost profits caused by faults in Mitsubishi Electric products; damage, secondary damage, or accident compensation, whether foreseeable or not, caused by special factors; damage to products other than Mitsubishi Electric products; or any other duties.

⚠ For safe use

- To use the products given in this publication properly, always read the relevant manuals before beginning operation.
- The products have been manufactured as general-purpose parts for general industries, and are not designed or manufactured to be incorporated in a device or system used in purposes related to human life.
- Before using the products for special purposes such as nuclear power, electric power, aerospace, medicine or passenger-carrying vehicles, consult with Mitsubishi Electric.
- The products have been manufactured under strict quality control. However, when installing the products where major accidents or losses could occur if the products fail, install appropriate backup or fail-safe functions in the system.

Creating Solutions Together.



Low-voltage Power Distribution Products



Transformers, Med-voltage Distribution Products



Power Monitoring and Energy Saving Products



Power (UPS) and Environmental Products



Compact and Modular Controllers



Servos, Motors and Inverters



Visualization: HMIs



Edge Computing Products



Numerical Control (NC)



Collaborative and Industrial Robots

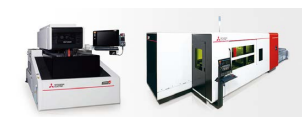

Processing machines: EDM, Lasers



SCADA, analytics and simulation software

Mitsubishi Electric's product lineup, from various controllers and drives to energy-saving devices and processing machines, all help you to automate your world. They are underpinned by software, innovative data monitoring, and modelling systems supported by advanced industrial networking and Edgecross IT/OT connectivity. Together with a worldwide partner ecosystem, Mitsubishi Electric factory automation (FA) has everything to make IoT and Digital Manufacturing a reality.

With a complete portfolio and comprehensive capabilities that combine synergies with diverse business units, Mitsubishi Electric provides a one-stop approach to how companies can tackle the shift to clean energy and energy conservation, carbon neutrality and sustainability, which are now a universal requirement of factories, buildings, and social infrastructure.

We at Mitsubishi Electric FA are your solution partners waiting to work with you as you take a step toward the realization of sustainable manufacturing and society through the application of automation. Let's automate the world together!

American Offices

USA Mitsubishi Electric Automation, Inc. 500 Corporate Woods Parkway, Vernon Hills, IL 60061, U.S.A. Tel: +1-847-478-2100	Mexico Mitsubishi Electric Automation, Inc. Mexico Branch Boulevard Miguel de Cervantes Saavedra 301, Torre Norte Piso 5, Ampliacion Granada, Miguel Hidalgo, Ciudad de Mexico, Mexico, C.P.11520 Tel: +52-55-3067-7500	Brazil Mitsubishi Electric do Brasil Comercio e Servicos Ltda. Avenida Adelino Cardana, 293, 21.o andar, Bethaville, Barueri SP, Brazil Tel: +55-11-4689-3000
--	---	--

Asia-Pacific Offices

China Mitsubishi Electric Automation (China) Ltd. Mitsubishi Electric Automation Center, No.1386 Hongqiao Road, Shanghai, China Tel: +86-21-2322-3030	Taiwan SETSUYO ENTERPRISE CO., LTD. 6F, No.105, Wugong 3rd Road, Wugu District, New Taipei City 24889, Taiwan Tel: +886-2-2299-2499	Korea Mitsubishi Electric Automation Korea Co., Ltd. 7F to 9F, Gangseo Hangang Xi-tower A, 401, Yangcheon-ro, Gangseo-Gu, Seoul, Korea Tel: +82-2-6103-9460
Singapore Mitsubishi Electric Asia Pte. Ltd. 307 Alexandra Road, Mitsubishi Electric Building, Singapore 159943 Tel: +65-6473-2486	Malaysia Mitsubishi Electric Sales Malaysia Sdn. Bhd. Lot 11, Jalan 51A/219, Seksyen 51A, 46100 Petaling Jaya, Selangor Darul Ehsan, Malaysia Tel: +60-3-7626-5000	Indonesia PT. Mitsubishi Electric Indonesia Gedung Jaya 8th Floor, JL. MH. Thamrin No.12, Jakarta Pusat 10340, Indonesia Tel: +62-21-3192-6461
Vietnam Mitsubishi Electric Vietnam Co., Ltd. 11th & 12th Floor, Viettel Tower B, 285 Cach Mang Thang Tam Street, Ward 12, District 10, Ho Chi Minh City, Vietnam Tel: +84-28-3910-5945	Thailand Mitsubishi Electric Factory Automation (Thailand) Co., Ltd. 101, True Digital Park Office, 5th Floor, Sukhumvit Road, Bang Chak, Prakanong, Bangkok, Thailand Tel: +66-2092-8600	Philippines MELCO Factory Automation Philippines Inc. 128, Lopez-Rizal St. Brgy. Highway Hills, Mandaluyong City, MM, Philippines Tel: +63-(0)2-8256-8042
India Mitsubishi Electric India Pvt. Ltd. Pune Branch ICC-Devi Gaurav Technology Park, Unit no. 402, Fourth Floor, Survey no. 191-192 (P), Opp. Vallabh Nagar Bus Depot, Pune - 411018, Maharashtra, India Tel: +91-20-4624-2100	Australia Mitsubishi Electric Australia Pty. Ltd. 348 Victoria Road, P.O. Box 11, Rydalmere, N.S.W. 2116, Australia Tel: +61-2-9684-7777	

European Offices

Germany Mitsubishi Electric Europe B.V. German Branch Mitsubishi-Electric-Platz 1, 40882 Ratingen, Germany Tel: +49-2102-486-0	UK Mitsubishi Electric Europe B.V. UK Branch Travellers Lane, UK-Hatfield, Hertfordshire, AL10 8XB, U.K. Tel: +44-1707-28-8780	Italy Mitsubishi Electric Europe B.V. Italian Branch Campus, Energy Park Via Energy Park 14, Vimercate 20871 (MB) Italy Tel: +39-039-60531
Spain Mitsubishi Electric Europe B.V. Spanish Branch Carretera de Rubi 76-80-Appdo. 420, E-08174 Sant Cugat del Valles (Barcelona), Spain Tel: +34-935-65-3131	France Mitsubishi Electric Europe B.V. French Branch 2, rue de l'Union-92565 Rueil-Malmaison Cedex-France Tel: +33-1-55-68-55-68	Czech Republic Mitsubishi Electric Europe B.V. Czech Branch, Prague Office Pekarska 621/7, 155 00 Praha 5, Czech Republic Tel: +420-734-402-587
Turkey Mitsubishi Electric Turkey Elektrik Urunleri A.S. Serifali Mah. Kale Sok. No:41 Umraniye / Istanbul, Turkey Tel: +90-216-969-2500	Poland Mitsubishi Electric Europe B.V. Polish Branch ul. Krakowska 48, 32-083 Balice, Poland Tel: +48-12-347-65-00	South Africa Adroit Technologies 20 Waterford Office Park, 189 Witkoppen Road, Fourways, South Africa Tel: +27-11-658-8100

The release date varies depending on the product and your region. For details, please contact your local sales office.

MITSUBISHI ELECTRIC CORPORATION

HEAD OFFICE: TOKYO BLDG., 2-7-3, MARUNOUCHI, CHIYODA-KU, TOKYO 100-8310, JAPAN
 NAGOYA WORKS: 1-14, YADA-MINAMI 5, HIGASHI-KU, NAGOYA, JAPAN