

# Programmable Controller Engineering Software MELSOFT GX Works3 FB Quick Start Guide

## Let's learn FB!



How to read this guide	1
Terms	2
Related manuals	3
Introduction	4
FBs	5
Using FB Libraries	6
Creating FBs	7









'Easy', 'Easy-to-read', and  
'Reduction of man-hours'

The collage illustrates the ease of using FBs in MELSOFT GX Works3. It shows the software interface with a function block being inserted into a ladder logic circuit, the resulting circuit diagram, and a completed circuit diagram with a timer and counter. Red arrows point from the text 'Easy', 'Easy-to-read', and 'Reduction of man-hours' to the corresponding parts of the software interface.

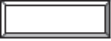
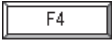

# 1 How to read this guide

The following explains the symbols used in this guide and their descriptions.

Symbol	Description	Example
	This symbol describes the information useful to know.	Select [View] → [Comment] (  key +  key). The comment display/hide setting can be switched.
	This symbol describes content that must be noted in operation.	When dismantling the module, the power must be turned off.
	Buttons on the screen	 button
[ ]	Menu names on the menu bar ([ ] → [ ] shows drop-down menus.)	Select [Project] → [New].
	Keys on the keyboard	 key
( )	Another procedure corresponding to a drop-down menu (icons and keys on the keyboard)	Select [Compile] → [Rebuild All]. 

# 2 Terms

The following shows the terms and abbreviations, such as function blocks, used in this guide.

Term or abbreviation	Description
FB	Abbreviation of Function Block.
FB library	A collection of FB parts that are usable in GX Works3. In GX Works3, "Module FB", modularization of processing of each module, is available. MELSOFT library releases the sample library for various modules/partner equipment. MELSOFT library can be used from Mitsubishi Electric FA site.
GX Works3	Engineering software that can perform from system design to maintenance. Generic product name of product type SWnDNC-GXW3 (n=Version No.)

1  
2

## 3 Related manuals

This guide offers the basic procedures to introduce FB.

Refer to the manuals in the following table as required.

The manuals can be downloaded for free from Mitsubishi Electric FA site.

Manual name	Manual number	Description
GX Works3 Installation Instructions	BCN-P5999-0391	Explains the introduction of GX Works3, such as the operating environment of GX Works3.
GX Works3 Operating Manual	SH-081215ENG	Explains the functions of GX Works3, such as system configurations, parameter settings of GX Works3 and the operation method of online functions, etc.
MITSUBISHI ELECTRIC FA Library	BCN-P5999-0053E	Explains how to use a parts collection (MELSOFT Library) that can easily use PLC-related modules or HMI, and various device equipment connected to them.

# 4 Introduction

This guide explains clearly the basic introduction procedures for first-time FB (Function Block) users. This guide helps you understand easily how to use FB.

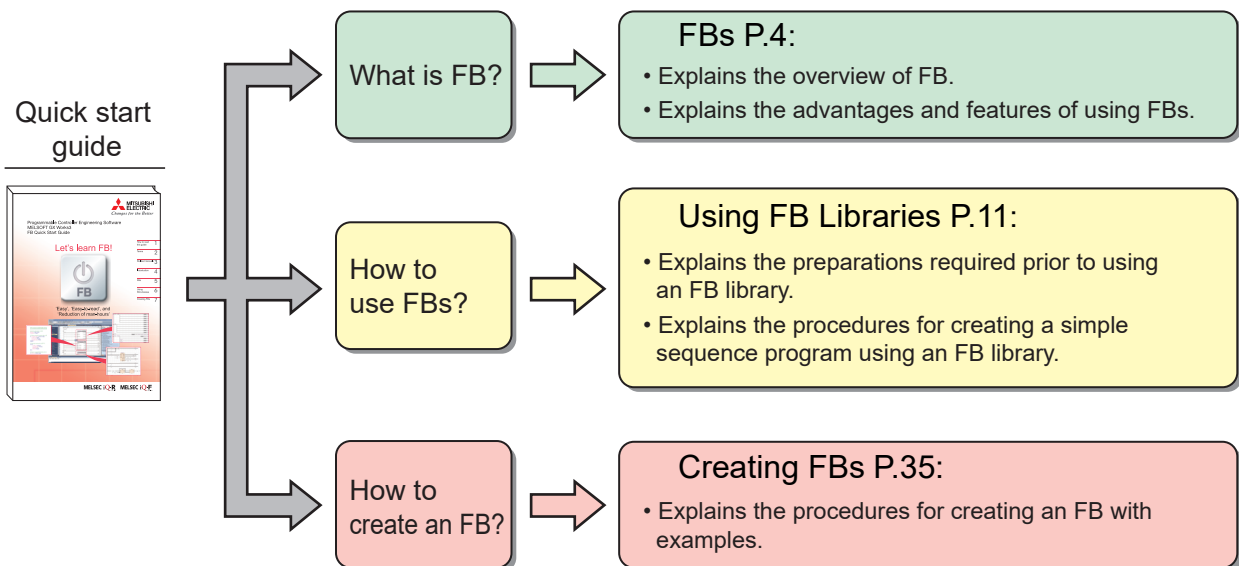

### Caution

This guide explains how to use FB Library and how to create FB using simple examples. When designing/operating systems, read the manuals of the CPU module and other modules that will be used, and use them safely.

# 5 FBs

FB is an abbreviation for a Function Block that is designed to convert a ladder block, which is used repeatedly in a sequence program, into a component (FB) to be utilized in a sequence program. This not only increases the efficiency of program development but also reduces programming mistakes to improve program quality.

Sequence program

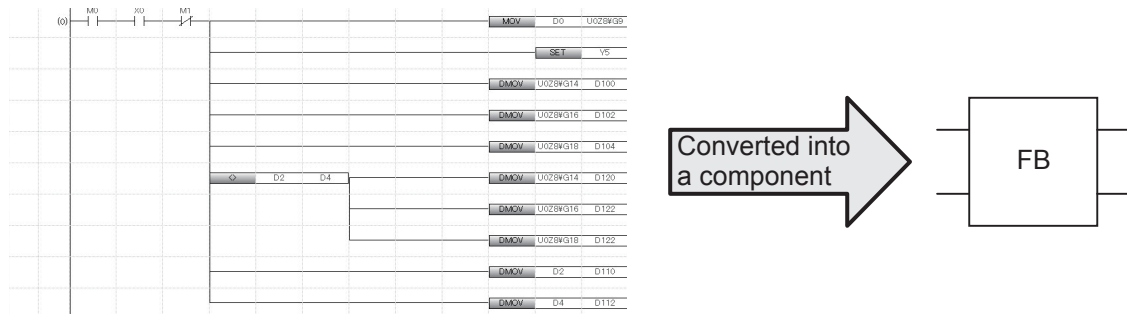

## 5 Converting into Components

What does it mean when a sequence program is converted into a component?

The following section explains the process to convert a simple program into a component.

[Example] A program in which the output signal (Y12) is turned ON when the input signal (X1) is turned ON 12 times.

(1) Program to be converted into a component

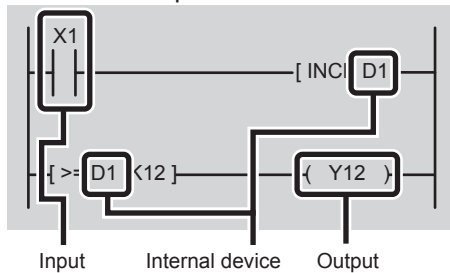

(2) Divide into input and output. In addition, replace the internal device with an internal label.

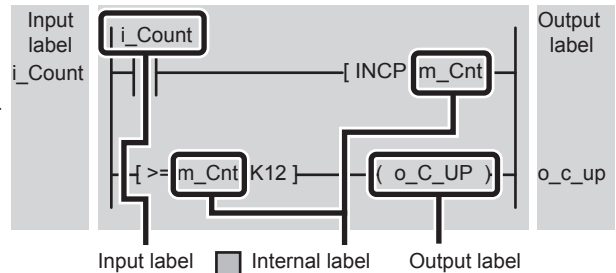

(3) When changing to an FB

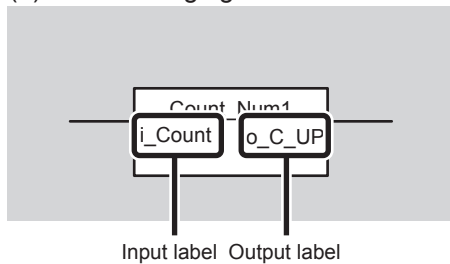

(4) Inserting the FB into a program

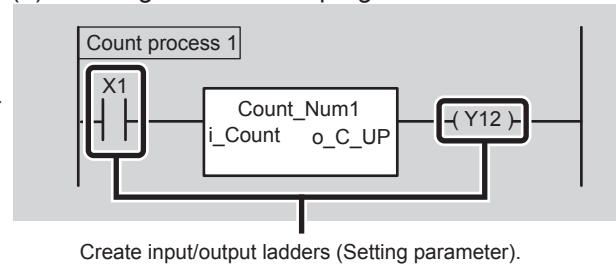

Create input/output ladders (Setting parameter).

# Advantages of Using FBs

This section introduces advantages of creating programs by using FBs.

## ■ Easy programming

A sequence program can be created simply by pasting in an FB. This significantly reduces the program development man-hours. (Programming is made easier using FB libraries provided by Mitsubishi Electric Corporation.)

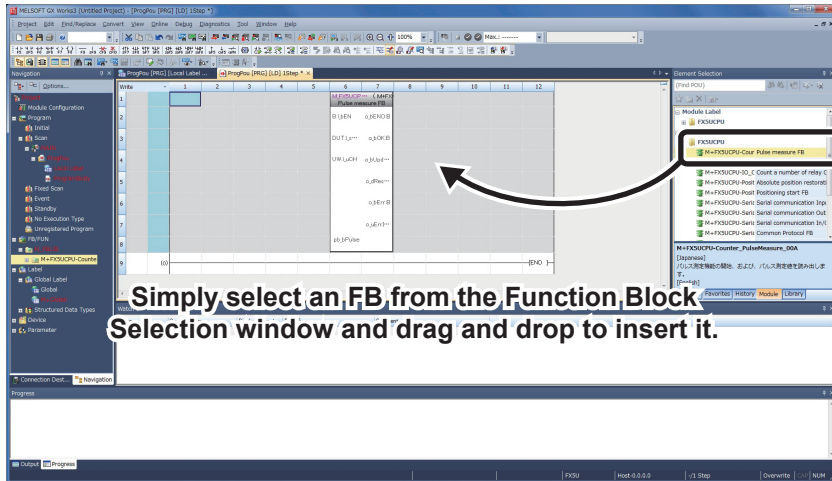

## ■ Easy reading

Using an FB creates a simple program with only a 'box' (FB), inputs, and outputs to create an easy-to-read sequence program.

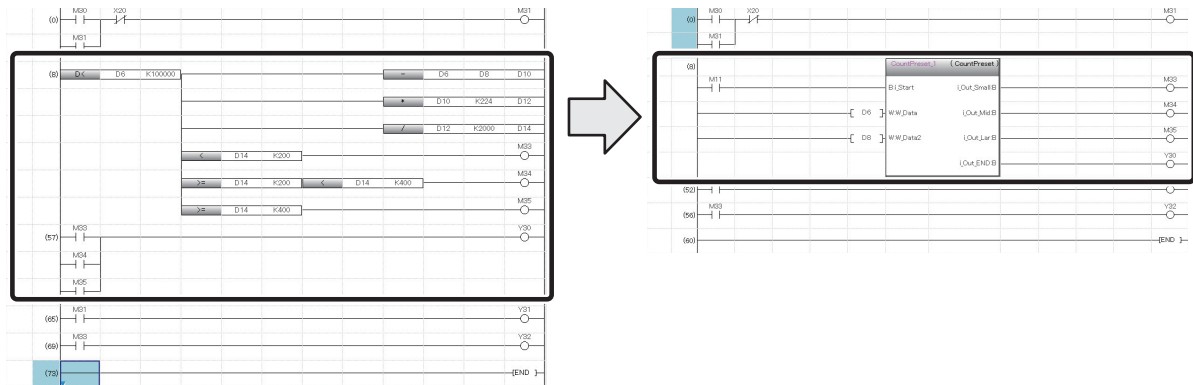

## ■ Reusing

Converting a standard program into a component allows the program to be reused any number of times. As a result, operations such as copying a sequence program and modifying devices becomes unnecessary.

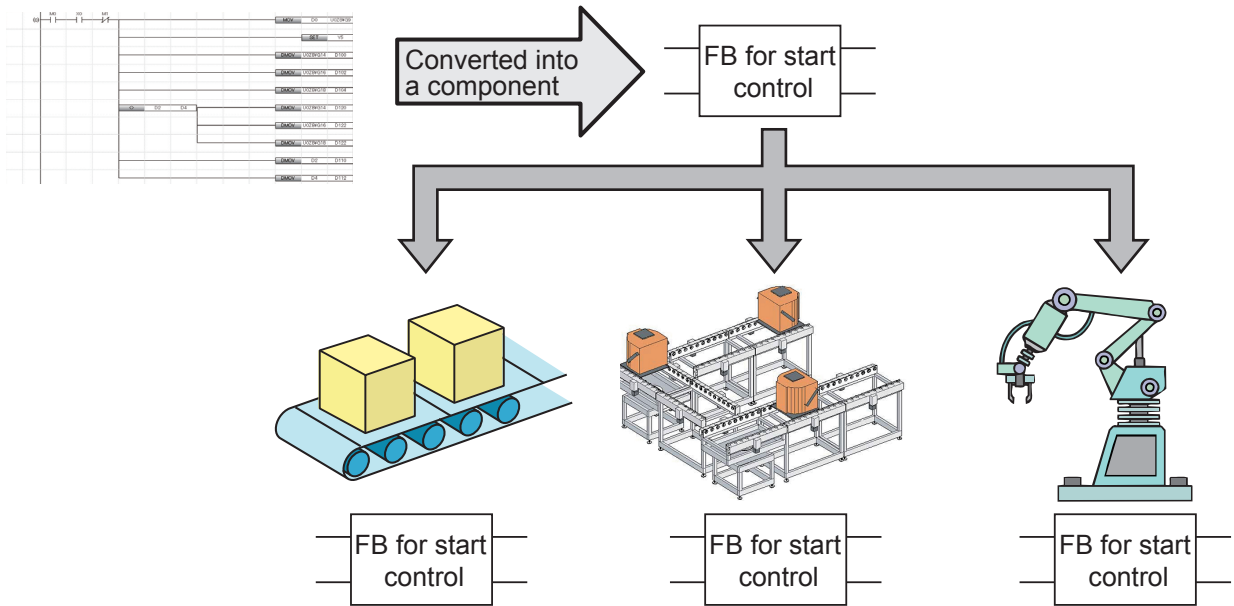

## ■ Improving quality

Converting a standard program into a component as an FB to reuse the program allows development of programs of consistent quality, without relying on the technical skill of the program developers.

When developers A and B are developing sequence programs for different devices, using the same FB for the common processing enables creating sequence programs of consistent quality.

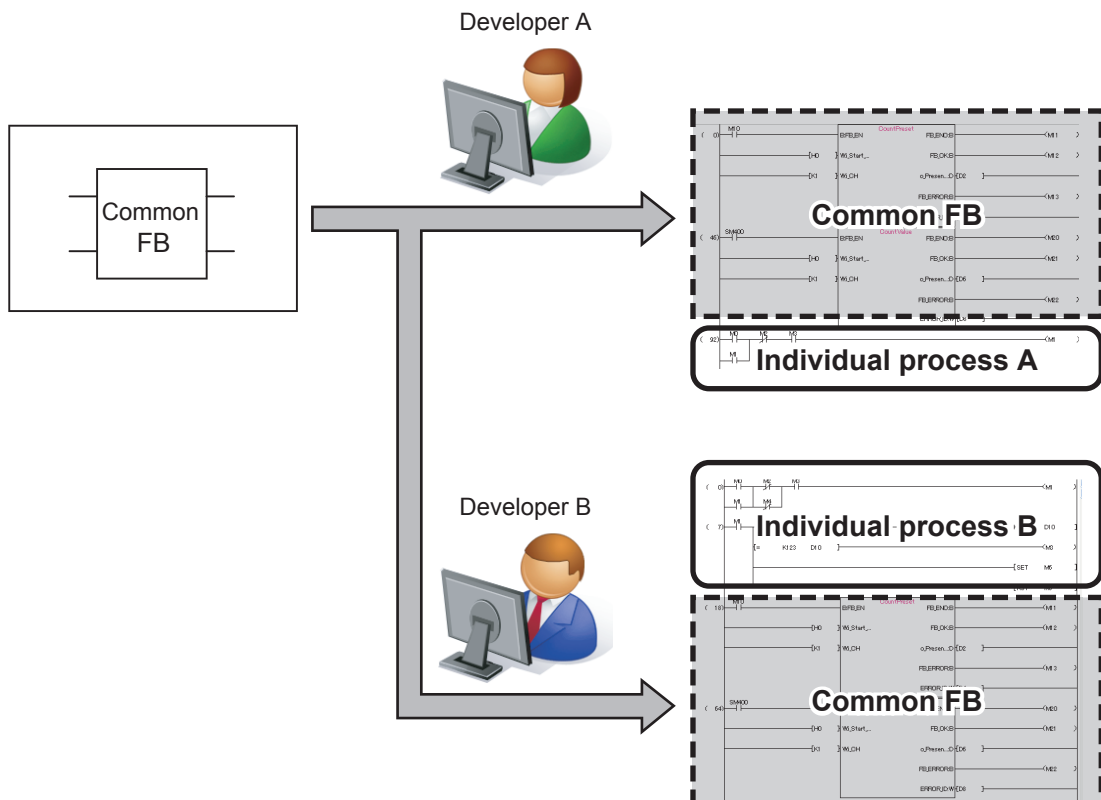



## ■ Protecting assets

By setting up a block password, the created FB can be protected so that it cannot be viewed.

Once the block password has been set, the following operations are restricted:

- Displaying and editing of FB program
- Editing of FB local label
- Copying to other project

The image illustrates the process of protecting assets in MELSOFT GX Works3. It shows the 'Block Password Setting' dialog box, which allows users to register, change, authenticate, or delete passwords for POU (Program Organizational Unit) elements. The POU List table is as follows:

Data Name	Registration Status
CountPreset	
ProgPou	

An arrow labeled 'Setting Block Password' points from the 'Block Password Setting' dialog to the 'Local Label' element in the project tree. Below, a screenshot of the ladder logic diagram shows an error message: 'Unable to display the specified data because it is read-protected.' This message is displayed over the 'CountPreset\_1' block in the program, indicating that the block is protected and its data cannot be viewed.

# FB Libraries

An FB library is a collection of FB parts usable in GX Works3. Using these enables easy settings and operations of MELSEC iQ-R and MELSEC iQ-F Series partner products.

<Example of iQ-R>

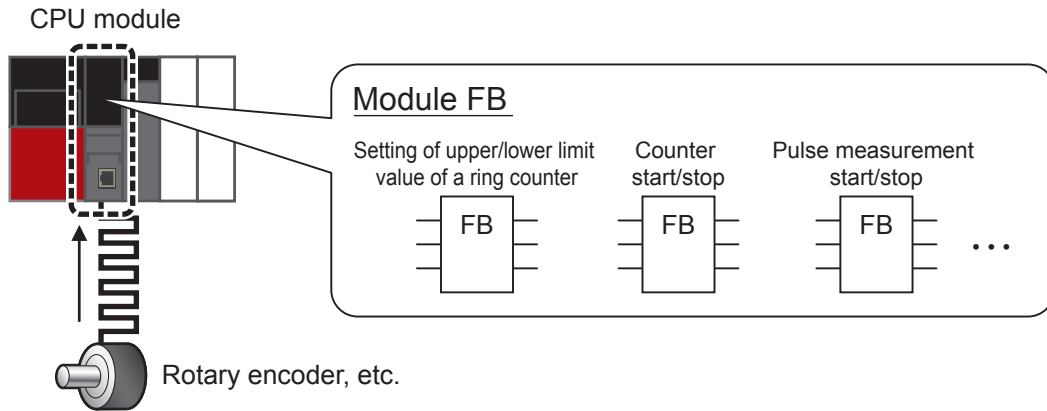

<Example of partner product>

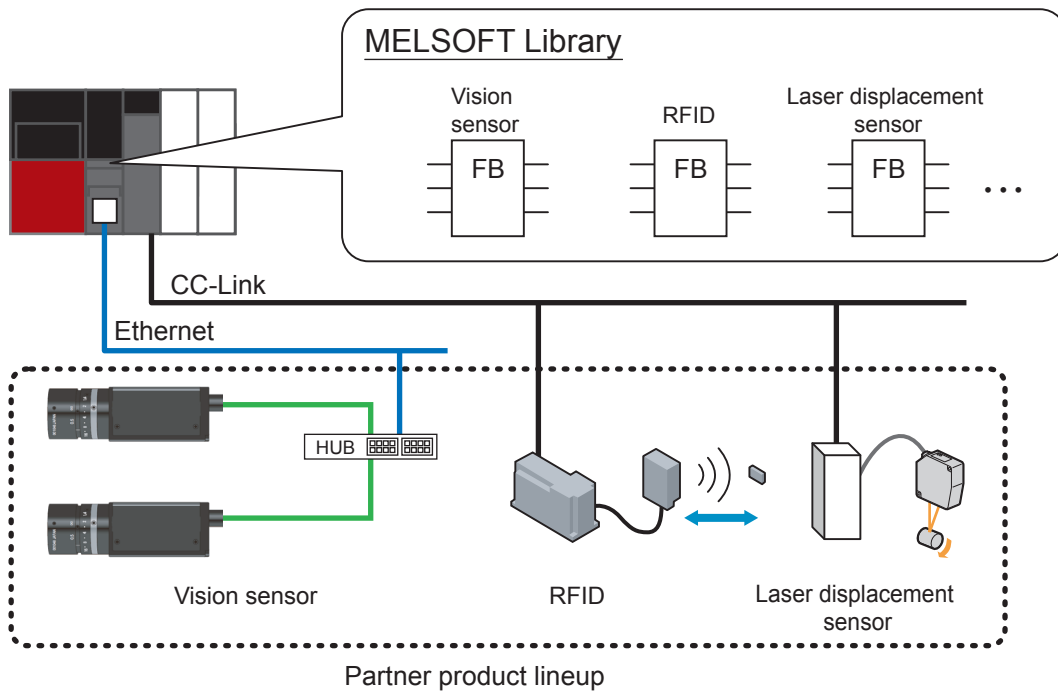

---

## ■ FB Library Lineup

---

"Module FB" and "MELSOFT Library", etc. are in FB libraries.

### Module FB

- CPU
- Analog input/output module
- Counter module
- Positioning module

⋮

### MELSOFT Library

- Data analysis
- RFID
- Laser displacement sensor
- Vision sensor

⋮

FB libraries supporting various functions are released periodically.

## ■ How to Obtain FB Libraries

---

Contact your local Mitsubishi Electric representative to obtain the MELSOFT Library.

## Development Tool

The following development tool is required to develop sequence programs using FBs.

Tool Name	Version
GX Works3	Supported from the first article (However, for MELSEC iQ-F Series, supported from Ver. 1.007H or later)



Depending on the FB library, supporting versions of GX Works3 may differ.

## FB Specifications and Precautions

For each FB library, refer to the restrictions and precautions of the reference manuals.

# 6 Using FB Libraries

This chapter explains the procedure to create a program by using an FB library.

	<b>Programs to be Created</b>	<b>P.12</b>
<b>1</b>	<b>Creating New Projects</b>	<b>P.15</b>
<b>2</b>	<b>Using Module Labels</b>	<b>P.18</b>
<b>3</b>	<b>How to Use Module FB</b>	<b>P.20</b>
<b>4</b>	<b>Setting Names of the Pasted FBs</b>	<b>P.22</b>
<b>5</b>	<b>Creating Input and Output Ladders</b>	<b>P.23</b>
<b>6</b>	<b>Performing Convert/Rebuild All</b>	<b>P.26</b>
<b>7</b>	<b>Writing and Executing Sequence Programs</b>	<b>P.27</b>
<b>8</b>	<b>Confirming Operations</b>	<b>P.28</b>
	<b>How to Use MELSOFT Library</b>	<b>P.31</b>

# Programs to be Created

This section explains how to use FB libraries using an example of reading pulse measurement values from the following module configuration.

[Example] Read the pulse measurement value of 1 phase 1 input into D10 from the pulse input to the input terminal when the switch (X10) is turned ON.

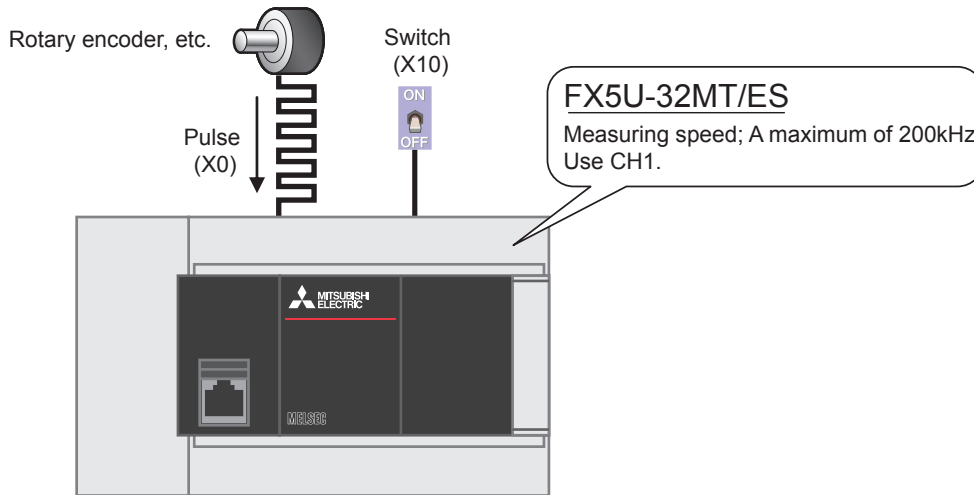

6



When a rotary encoder is used, actual wiring is as shown in the figure below.  
For details, refer to MELSEC iQ-F FX5S/FX5UJ/FX5U/FX5UC User's Manual (Hardware).

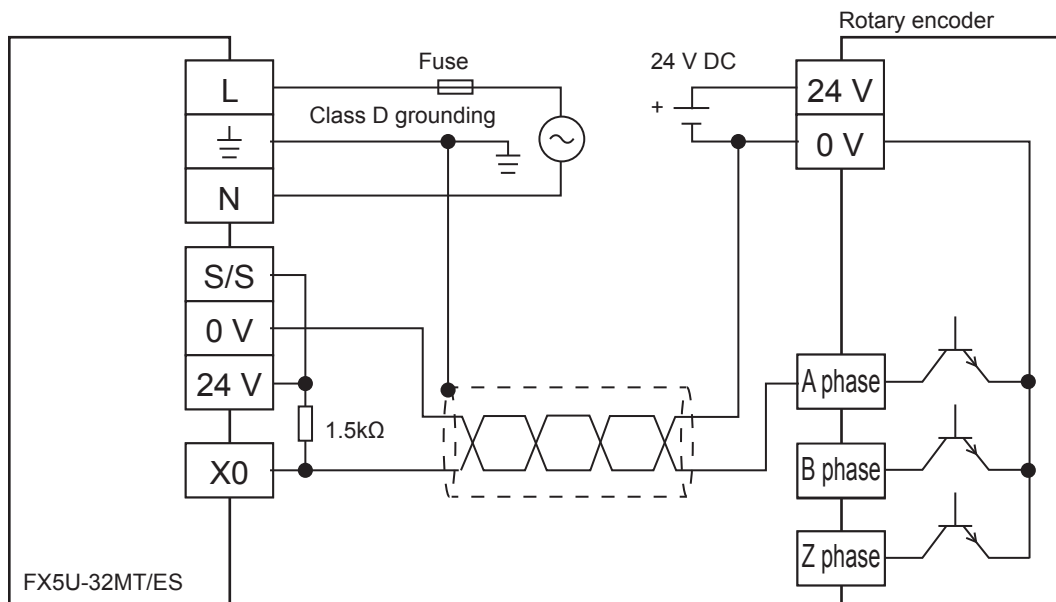

In the example, the parameters are set as follows.  
 For details, refer to MELSEC iQ-F FX5 User's Manual (Application).

### Setting of [High-Speed I/O]

(1) In the Navigation window, select [Parameter] → [FX5UCPU] → [Module Parameter] → [High Speed I/O].

(2) Select [Pulse Width Measurement].

(3) Set [Use Pulse Width Measurement] to [Use].

### Setting of [Input Response Time]

(1) In the Navigation window, select [Parameter] → [FX5UCPU] → [Module Parameter] → [Input Response Time].

(2) Set the input response time of X0 to [No Setting].

With the use of FB libraries, the following program is created.

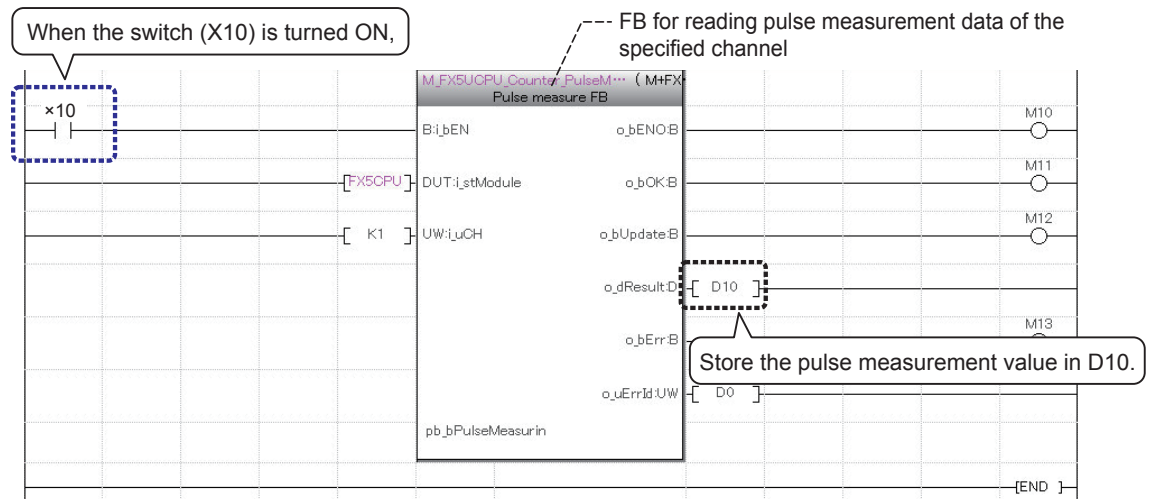

**Create this program in the following section.**



# ① Creating New Projects

This section explains how to create a new project by starting GX Works3.

## Operating procedure

1. Select [Start] → [All Programs] → [MELSOFT] → [GX Works3] → [GX Works3].

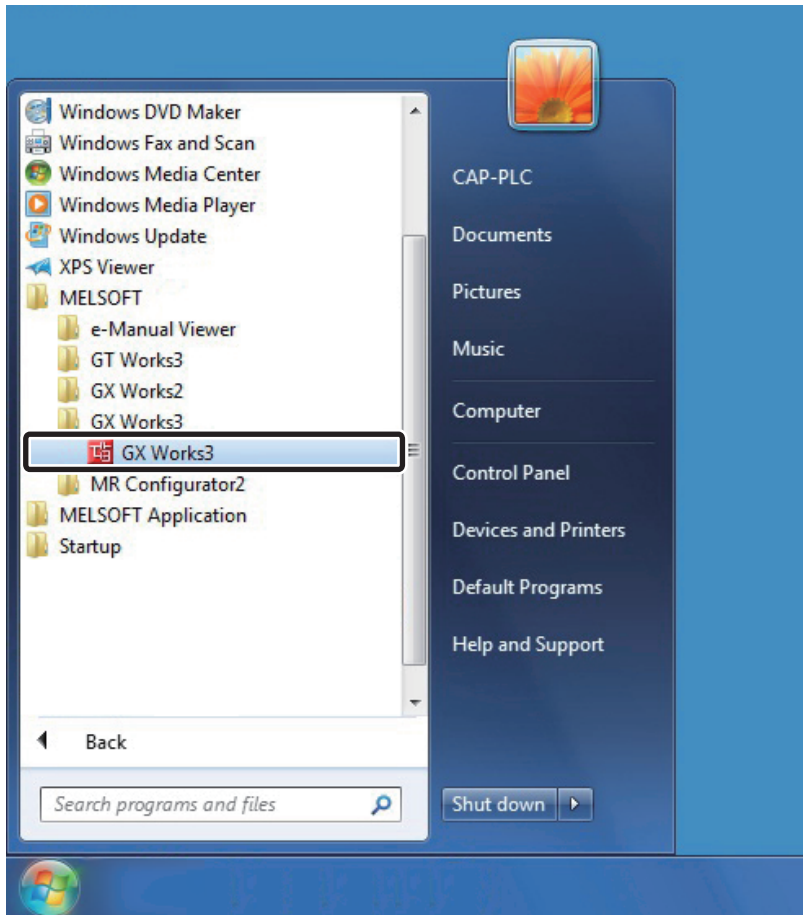

2. After starting, the GX Works3 main screen is displayed.

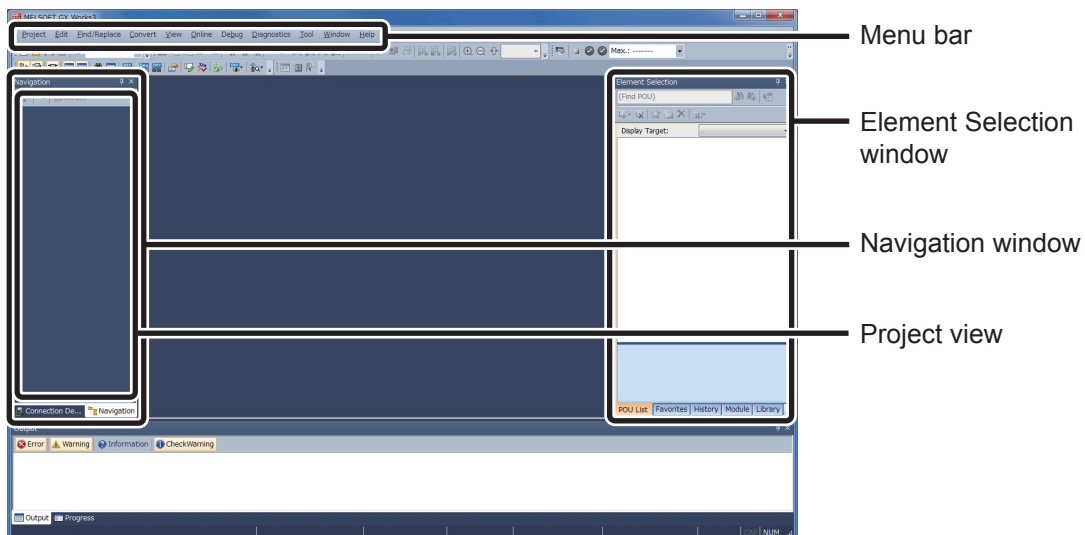

3. Select [Project] → [New].

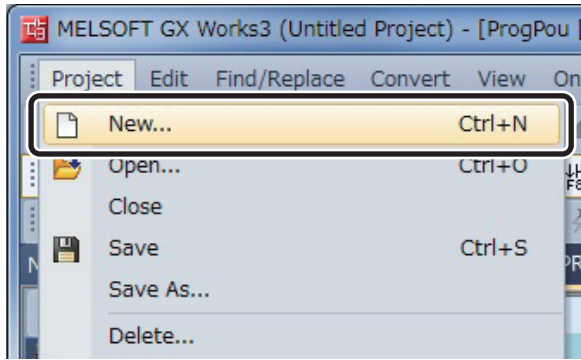

4. The "New" window is displayed.

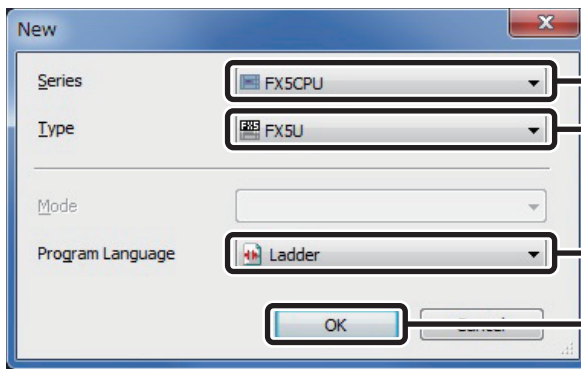

(1) Select the series (FX5CPU).

(2) Select the module to use (FX5U).

(3) Select the programming language (Ladder) to be developed.

(4) Click the  button.

5. A project tree and the ladder screen are displayed.

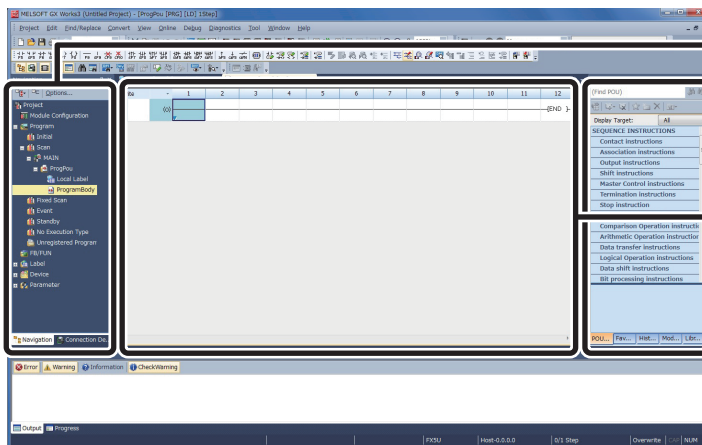

(1) A project tree is displayed in the Project view of the Navigation window.

(2) The ladder screen is displayed.

(3) The Element Selection window is displayed.

If the Navigation window is not displayed, use the following procedure to display it.

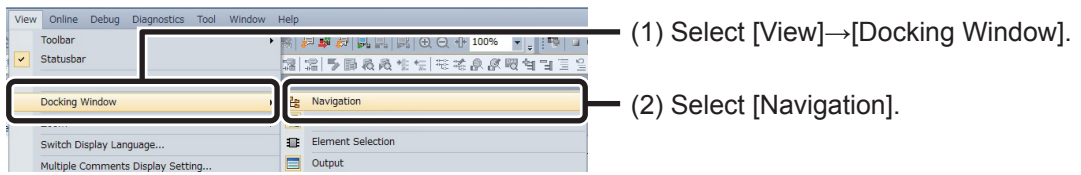

If the Function Block Selection window is not displayed, use the following procedure to display it.

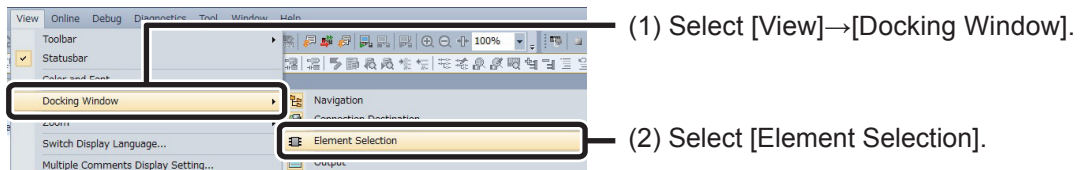

## ② Using Module Labels

Module Labels are pre-defined labels such as input signals and buffer memories of the modules to be used. With the use of module labels, it is possible to create easy to reuse programs without concern to the internal addresses of the module.

Module labels are installed together with GX Works3 and cannot be added or rewritten by users.

### Operating procedure

Make the module label usable in the project.

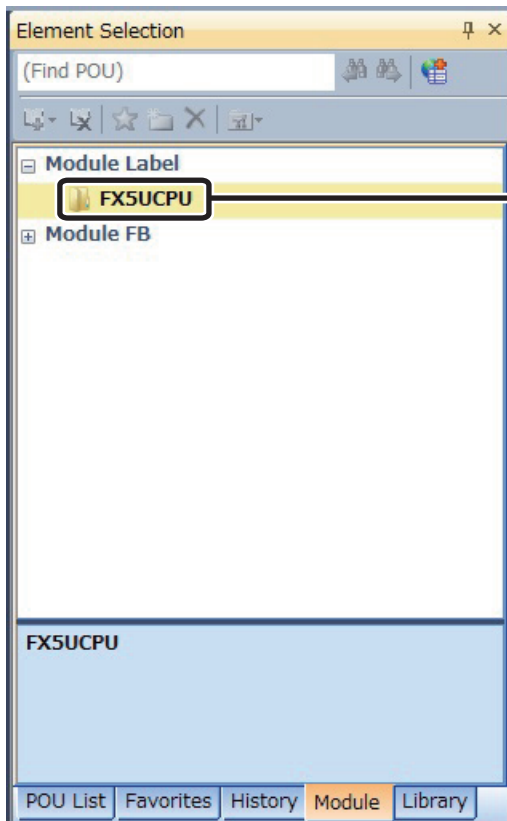

(1) In the Element Selection window, right-click [Module] → [Module Label] → [FX5UCPU].

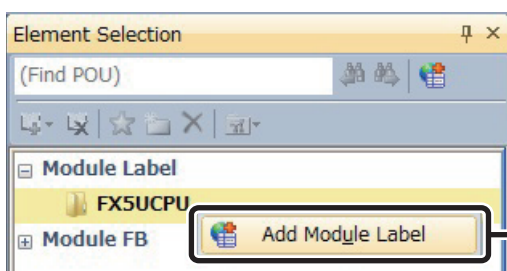

(2) Click [Add Module Label].

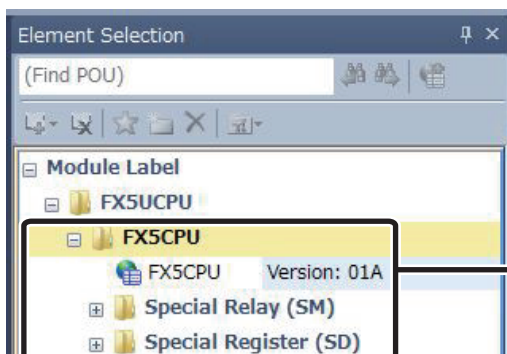

(3) The module label of FX5UCPU can be used.

The module label of the PLC can be registered also when creating a new project. Settings can be made from the confirmation window displayed when creating a new project.

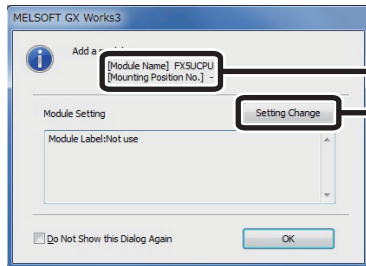

PLC selected at the time of creation

Click the **Setting Change** button.

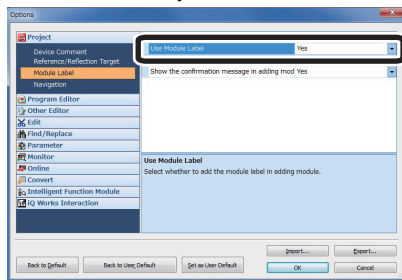

Set "Use Module Label" to "Yes".

The module label can be used in an ordinary program like a global label.

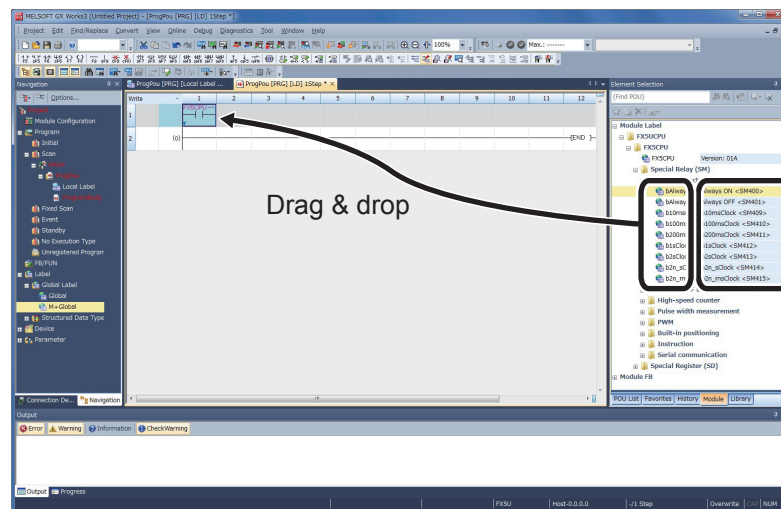

Drag & drop

Easy to understand as it is well-commented

## ③ How to Use Module FB

The Module FB can be used by drag & drop from the Element Selection window or the project view to the program window.

### Operating procedure

1. From the Element Selection window, the Module FB list is displayed by [Module] → [Module FB] → [FX5UCPU].

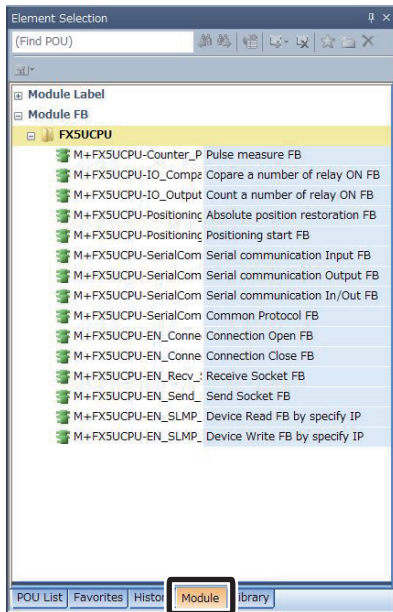

6

③

## 2. Drop [M+FX5UCPU-Counter\_PulseMeasure] in the program window.

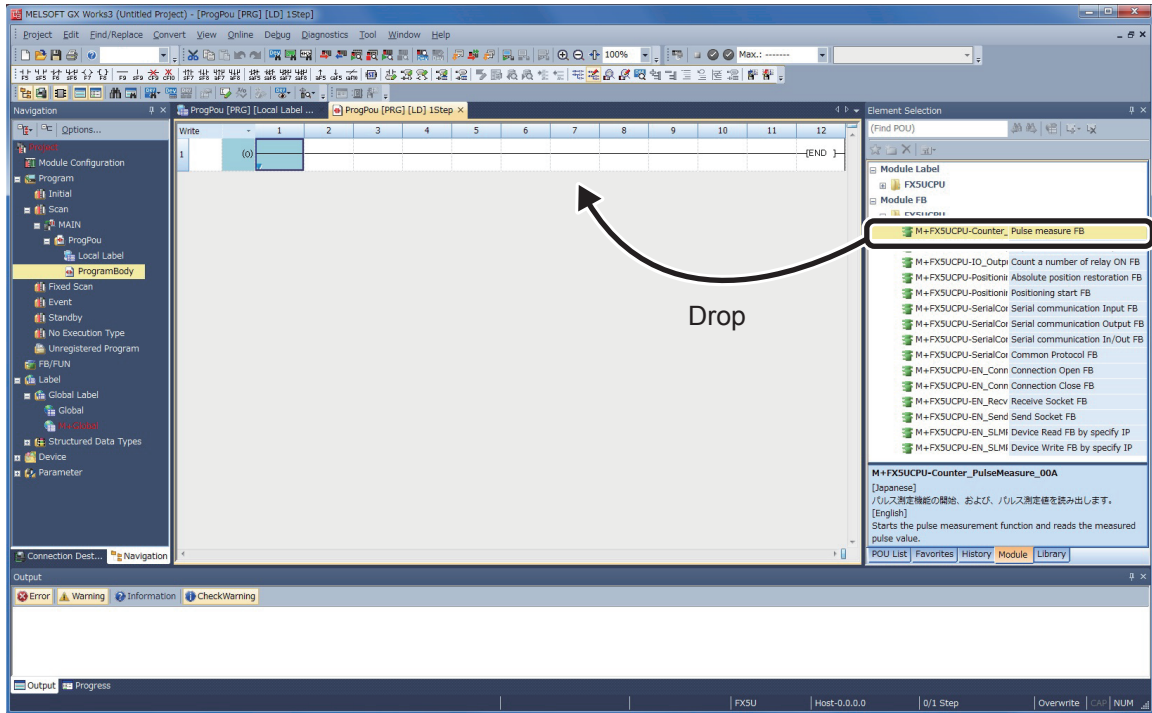

## 3. The "FB Instance Name" window is displayed.

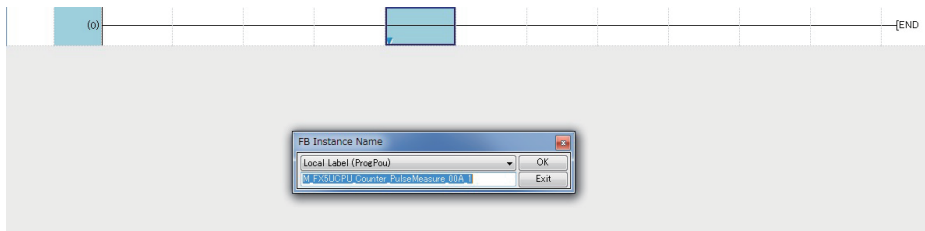

The details of the input method is described in "④ Setting Names of the Pasted FBs" on the next page.

## ④ Setting Names of the Pasted FBs

When an FB library is pasted to the program window, a window to input the name of the pasted FB (FB instance name\*) is displayed.

\* Instance name is to distinguish the FB.

A temporary name is automatically set to the instance name. To use the name as it is, close the window by clicking . Make sure that the same name does not exist in the same program when changing the name.

In this guide, it is set to the default.

### Operating procedure

#### 1. Input the FB instance name.

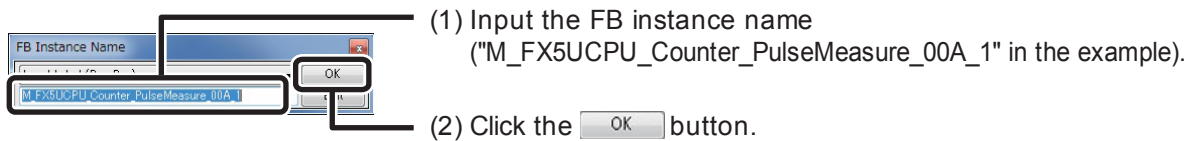

#### 2. The FB is pasted to the program window.

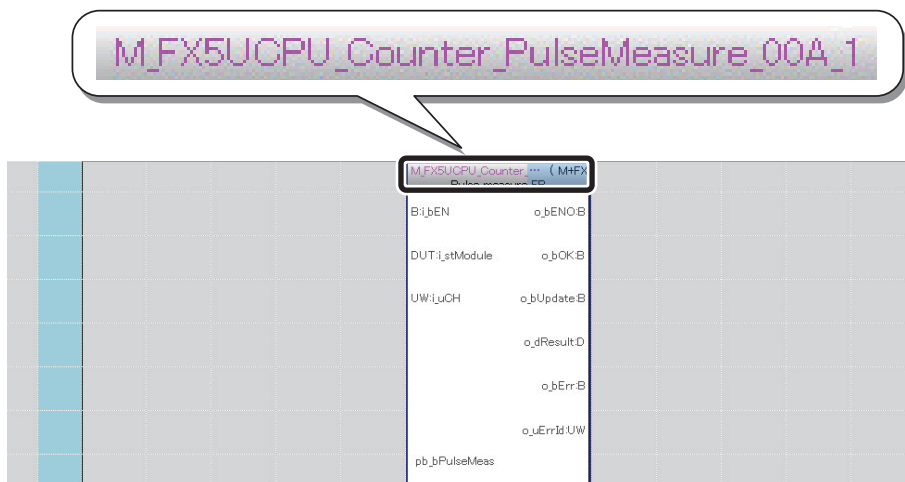

When inputting an instance name, be careful of the following points.

- Case-sensitive
- The maximum length for an instance name is 16 half-width characters.
- There are some symbols, such as !, ?, etc., that cannot be used.

For details, refer to GX Works3 Operating Manual.

An error occurs when clicking  with the following setting.

(When using letters that cannot be used)

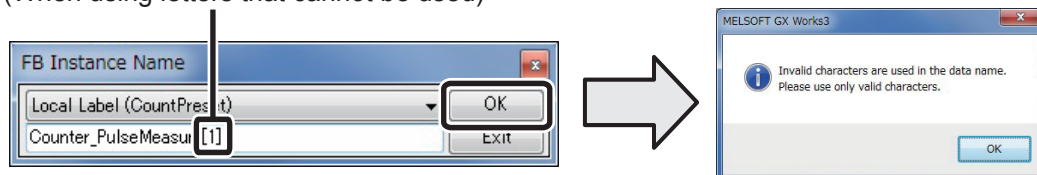



## ⑤ Creating Input and Output Ladders

Create the input ladder section and the output ladder section of the pasted FB, and complete the program.

Insert FB bit input from the far left of the circuit screen like an ordinary ladder program. (Insert to the far right in the output part.)

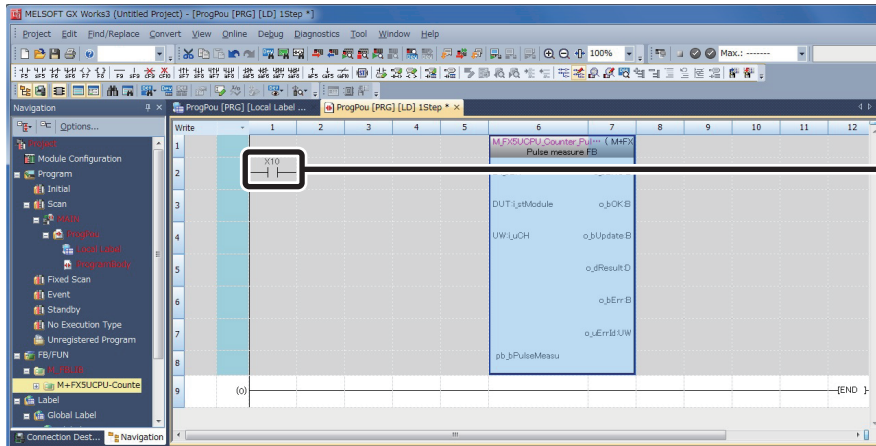

Insert a contact (X10) and input to B:i\_bEN.

Insert the module label applicable to the FB. The module label can be inserted by drag & drop from the Element Selection window.

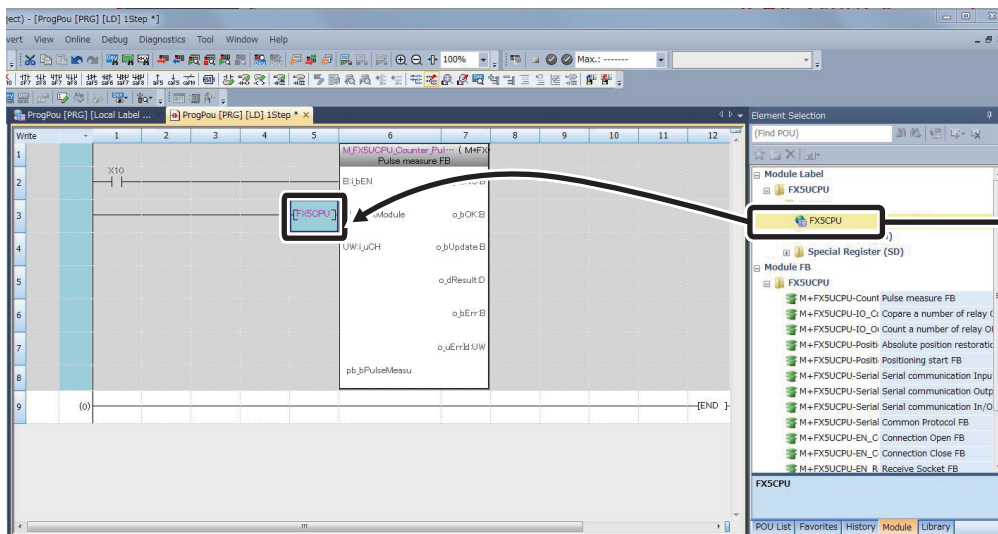

Select [FX5CPU] here.

6

5



The module label can be also inserted by direct input.

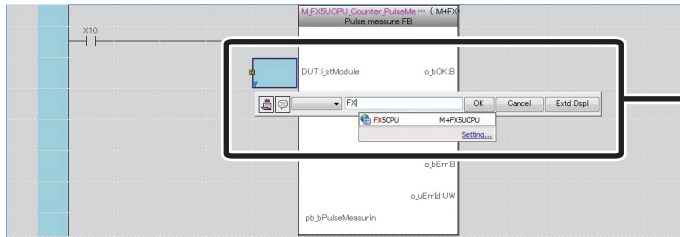

When the cursor is on the circuit screen, the direct input screen is displayed by inputting instructions or devices by keyboard.

Insert FB word device input to the far left of the FB (To the far right for output).

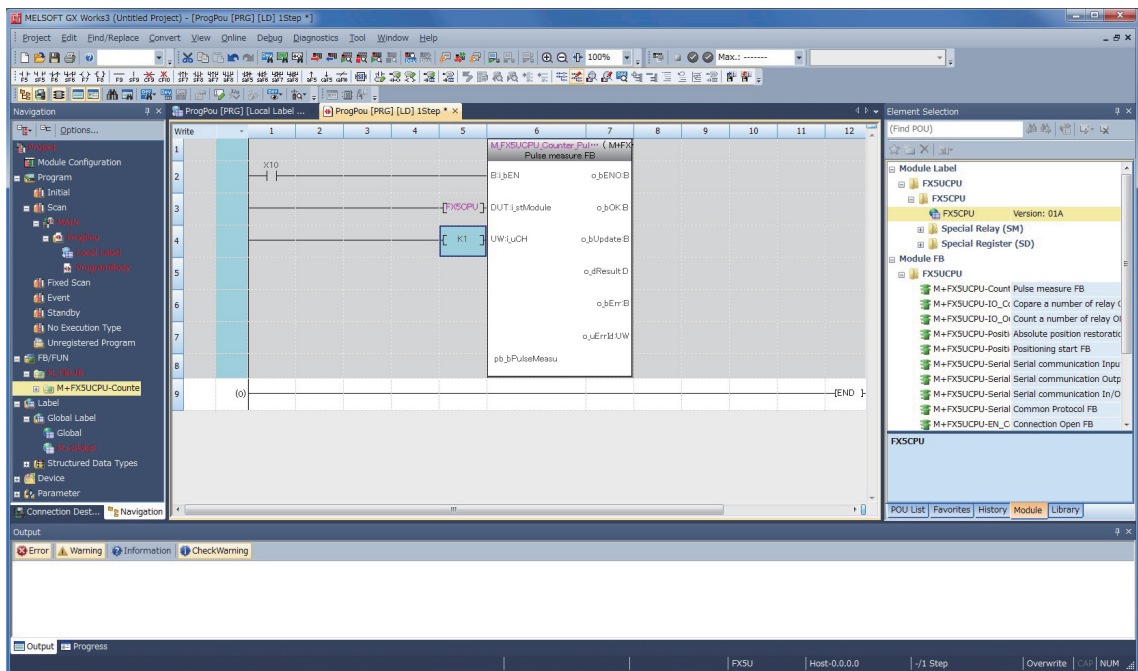

6

5

Repeat these procedures and input the circuit in the figure below.

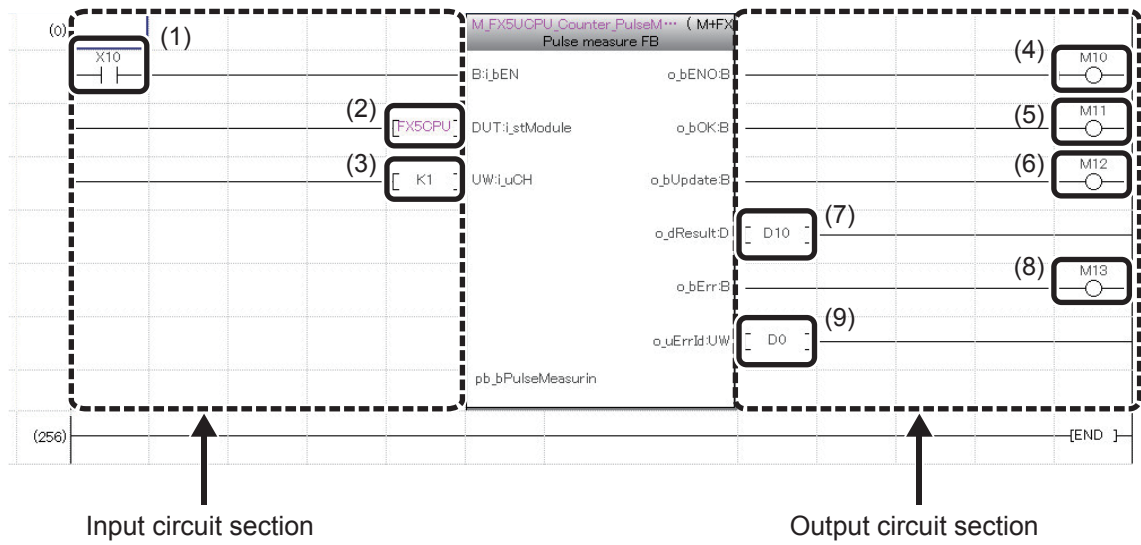

Number	Description
(1)	FB execution command: X10
(2)	Module label of module applicable to Module FB: FX5CPU
(3)	Target CH: K1 (1CH)
(4)	Execution status
(5)	Normal completion
(6)	Measured pulse value update flag
(7)	Measured pulse value
(8)	Error completion
(9)	Error code

## ⑥ Performing Convert/Rebuild All

Conversion is required to execute the created and completed program.

Rebuild all for the first time when the program is created.

The "convert" operation converts only the parts that have changed since the previous conversion.

The procedure to rebuild all is described as follows.

### Operating procedure

1. Select [Convert] → [Rebuild All].

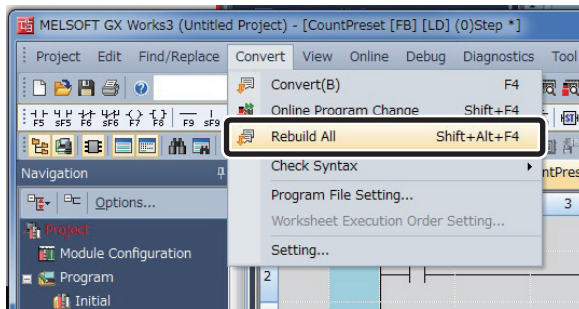

2. The following message is displayed.

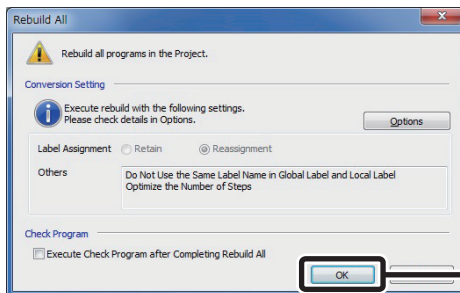

Click the **OK** button.

3. All programs are converted and the results are displayed in the output window.



When pasting a number of FBs that use device output with index modification (like OUT Y0Z9) internally, a double coil warning occurs at time of conversion, but there is no issue of functionality.

**This completes the program creation.**

## ⑦ Writing and Executing Sequence Programs

Write the created program to the CPU module and run the program.

### Operating procedure

1. Select [Online] → [Write to PLC].

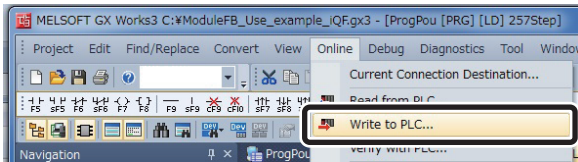

2. The "Online Data Operation" window is displayed.

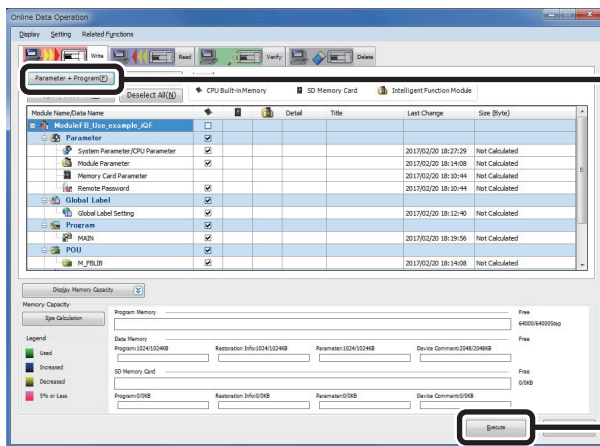

(1) Click the **Parameter + Program(E)** button.

(2) Click the **Execute** button.

3. Writing to the PLC is performed.

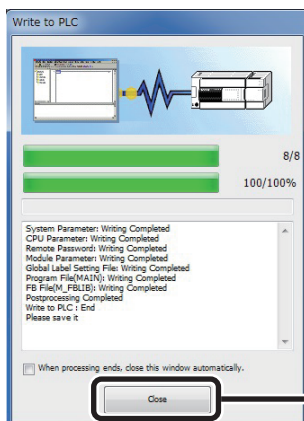

(3) After finishing writing, click the **Close** button.

**Preparation to run the created program is now completed.**

## ⑧ Confirming Operations

Confirm the created program's operations.

### Operating procedure

1. Select [Online] → [Monitor] → [Start Monitoring].

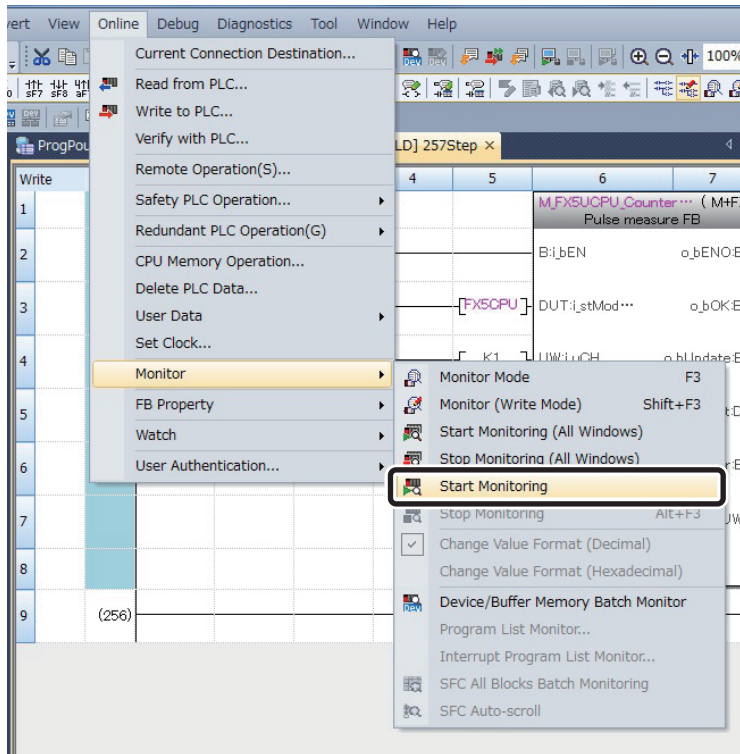

2. Turn the switch (X10) ON and confirm that the pulse measurement values have been read.

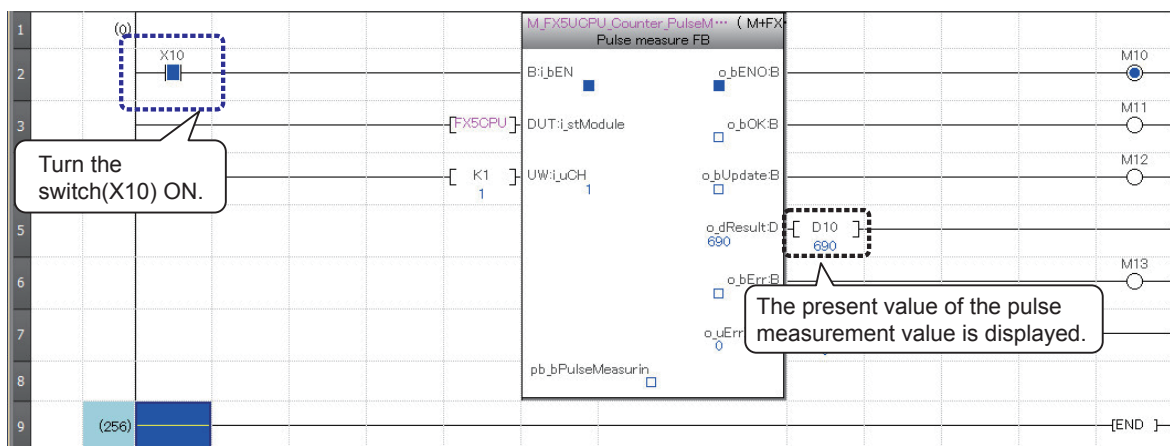

Double-clicking the FB in the sequence program on the screen enables monitoring of the sequence program status in the FB.

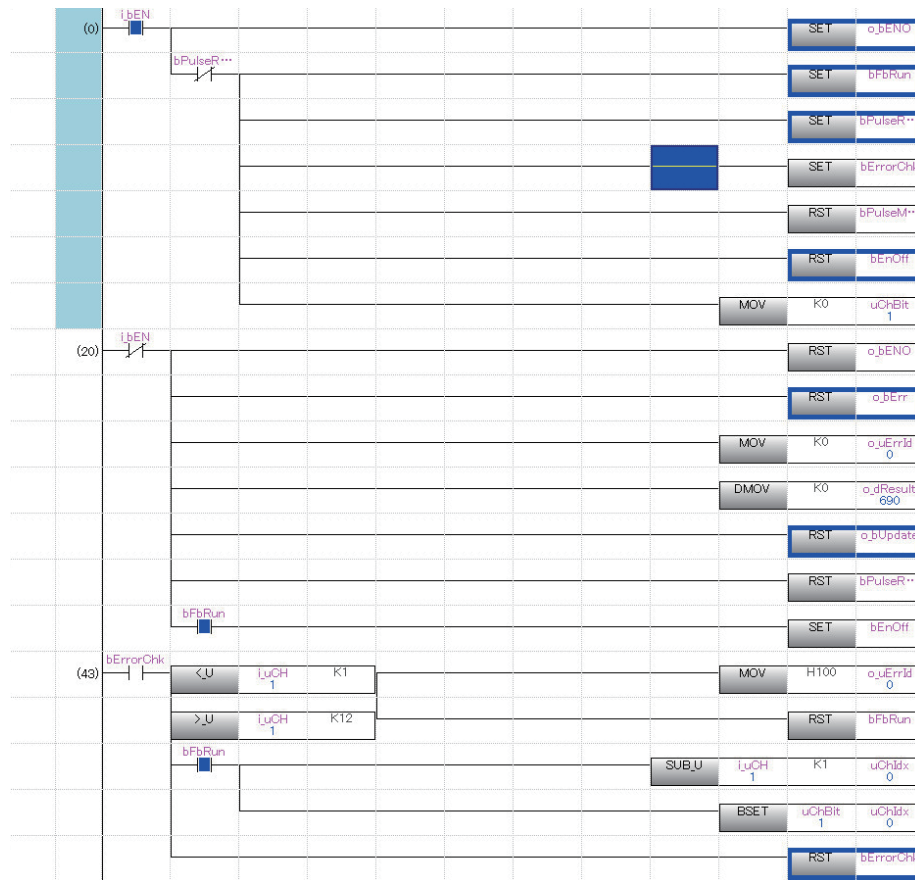

**This concludes the explanation of how to use Module FBs.**



## How to use the reference manual

Confirm the details of the Module FB and MELSOFT Library in the reference manual. Referable by registering MELSEC iQ-F FX5CPU Module FB Reference into e-Manual in advance. Various e-Manuals are available from your local Mitsubishi Electric representative.

The procedures to refer the reference manual by e-Manual Viewer are explained below.

### Operating procedure

1. Select the FB you want to display the reference manual and right click → [Help].

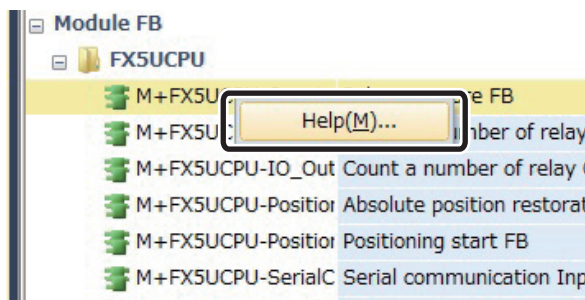

2. e-Manual Viewer starts up and jumps automatically to the position of the appropriate FB.

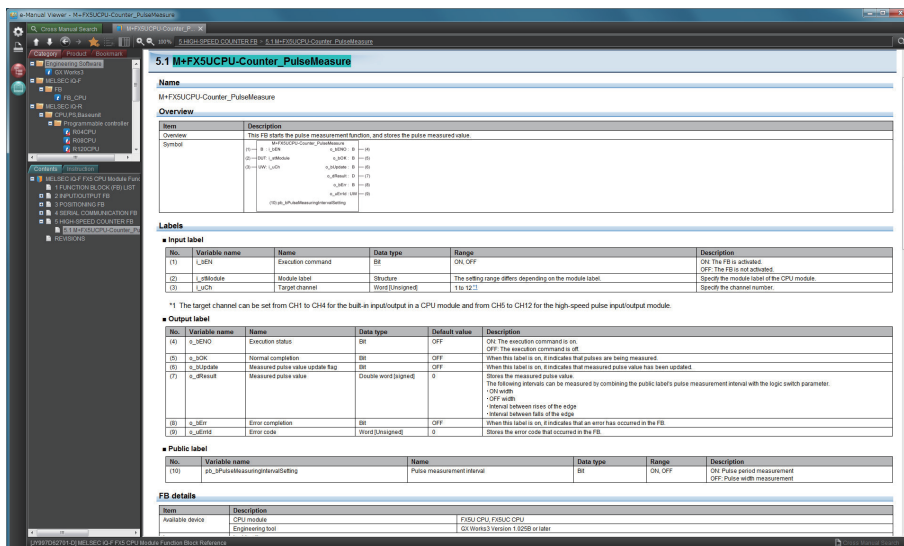



# How to Use MELSOFT Library

Before using an FB library, contact your distributors to obtain it.

(MELSOFT Library is not installed by installing GX Works3.)

If already registered into GX Works3, the following work becomes unnecessary.

## Operating procedure

1. As the file obtained from your distributor is a zip file (example "fb-dataanalysis\_r.zip"), unzip the file. Then "DataAnalysis\_R.mslm" is created.
2. In GX Works3, open the project and select [Project] → [Library Operation] → [Register to Library List] → [Library].

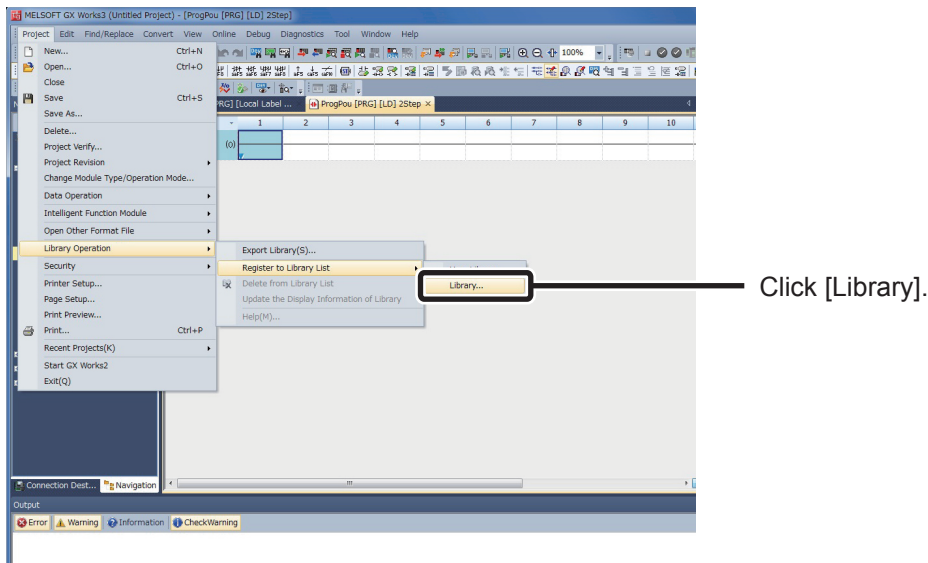

3. The confirmation dialog is displayed.

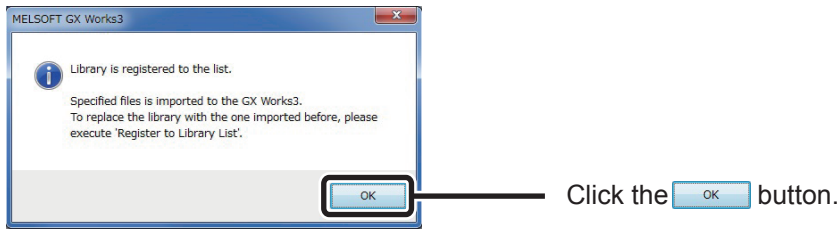

4. Select the "DataAnalysis\_R.mslm" file decompressed earlier and open it.

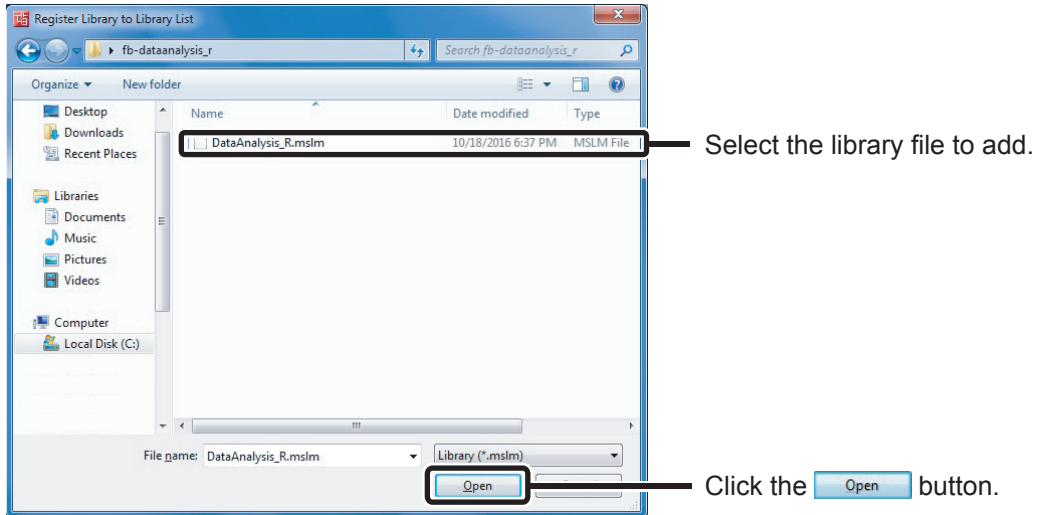

5. The "Library" item is added to the "Library" on the Element Selection window.

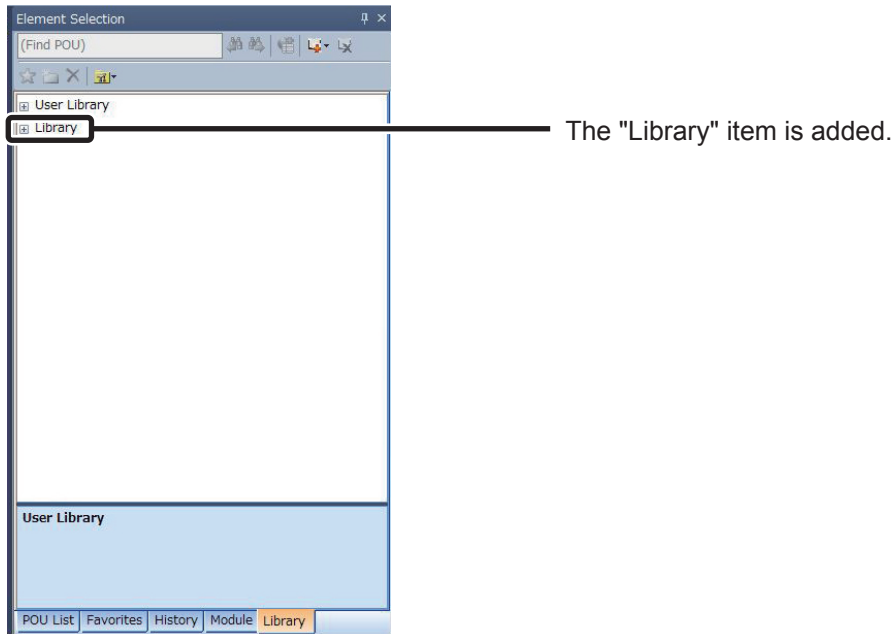

6. With that, the library has been added. The added library can be used by drag & drop as with the Module FB.

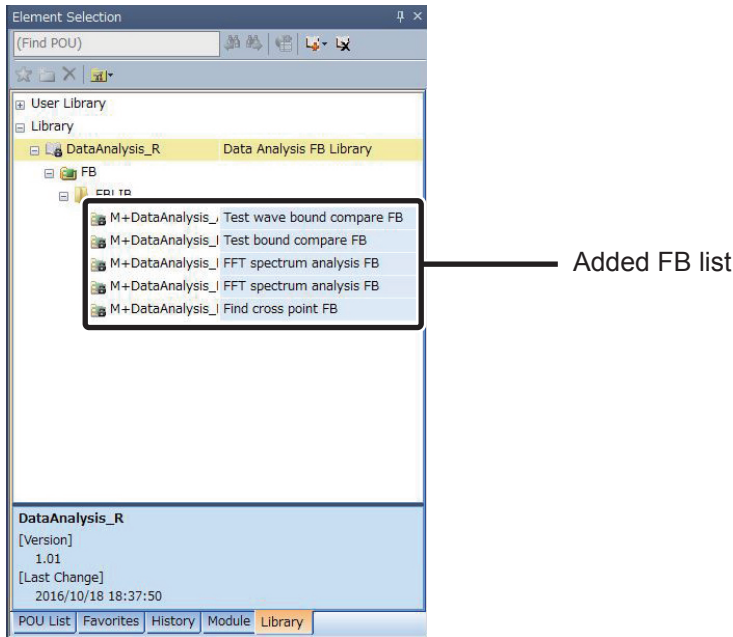

7. To upgrade the library with an updated version, after deleting the library once, execute again from the operating procedure 1 and import.

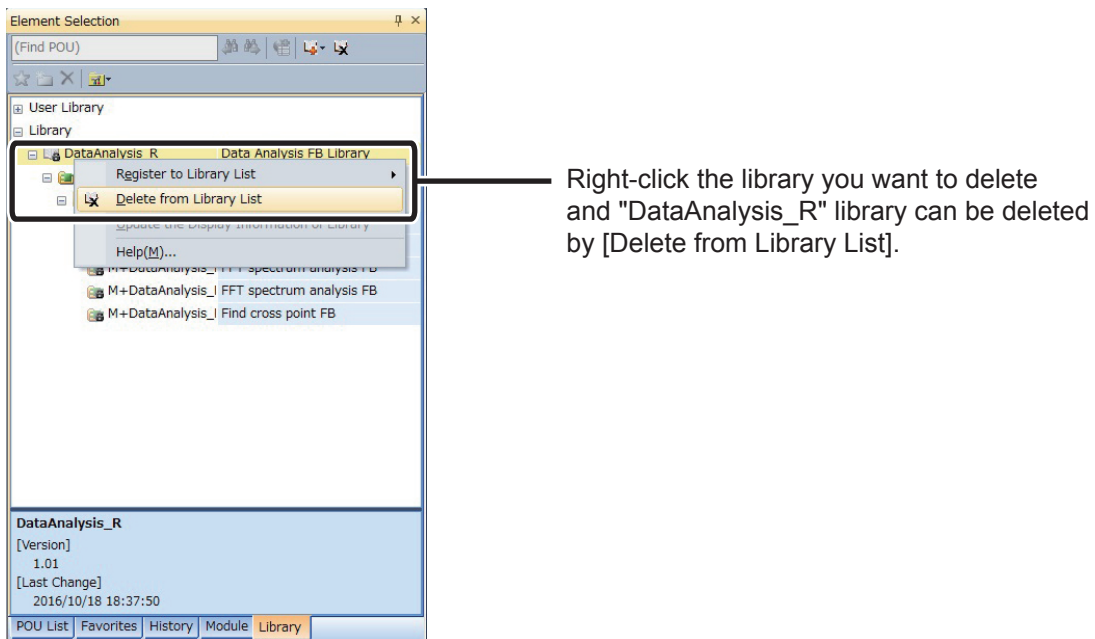

**With that, the preparation for using MELSOFT Library is ended.**

---

# MEMO

6

# 7 Creating FBs

This chapter explains the procedure to create a new FB.

Create an FB with the following procedures.

	<b>FBs to be Created</b>	<b>P.36</b>
①	<b>Creating New Projects</b>	<b>P.37</b>
②	<b>Creating New Data</b>	<b>P.39</b>
③	<b>Setting Labels</b>	<b>P.41</b>
④	<b>Creating FB Programs</b>	<b>P.43</b>
⑤	<b>Performing Convert/Rebuild All</b>	<b>P.44</b>
	<b>Protecting Created FBs</b>	<b>P.46</b>
	<b>How to Use User Libraries</b>	<b>P.48</b>
	<b>Techniques for Creating FBs</b>	<b>P.51</b>

# FBs to be Created

This section explains the procedure to create an FB from a simple program.

[Example] When input X1 is turned ON 12 times, output Y12 is turned ON.

[Sequence program]

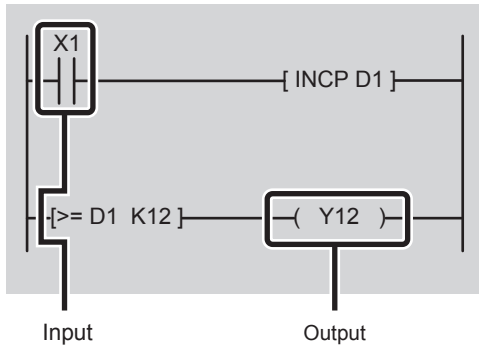

[Timing chart]

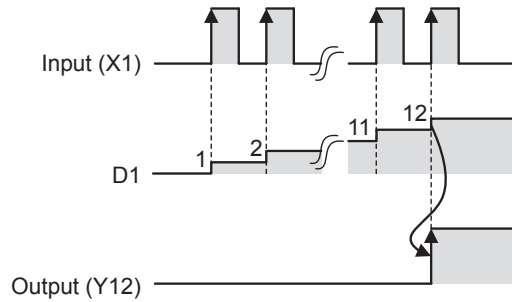

Creating an FB for the above program and pasting it to the sequence program creates a simple program with only an FB, an input, and an output.

[Sequence program to which FB is pasted]

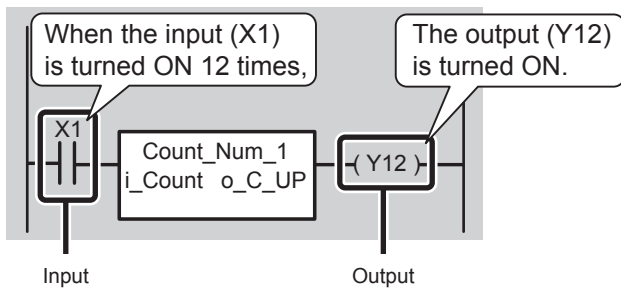

Create an FB in the following section.

# ① Creating New Projects

This section explains how to create a new project by starting GX Works3.

## Operating procedure

1. Select [Start] → [All Programs] → [MELSOFT] → [GX Works3] → [GX Works3].

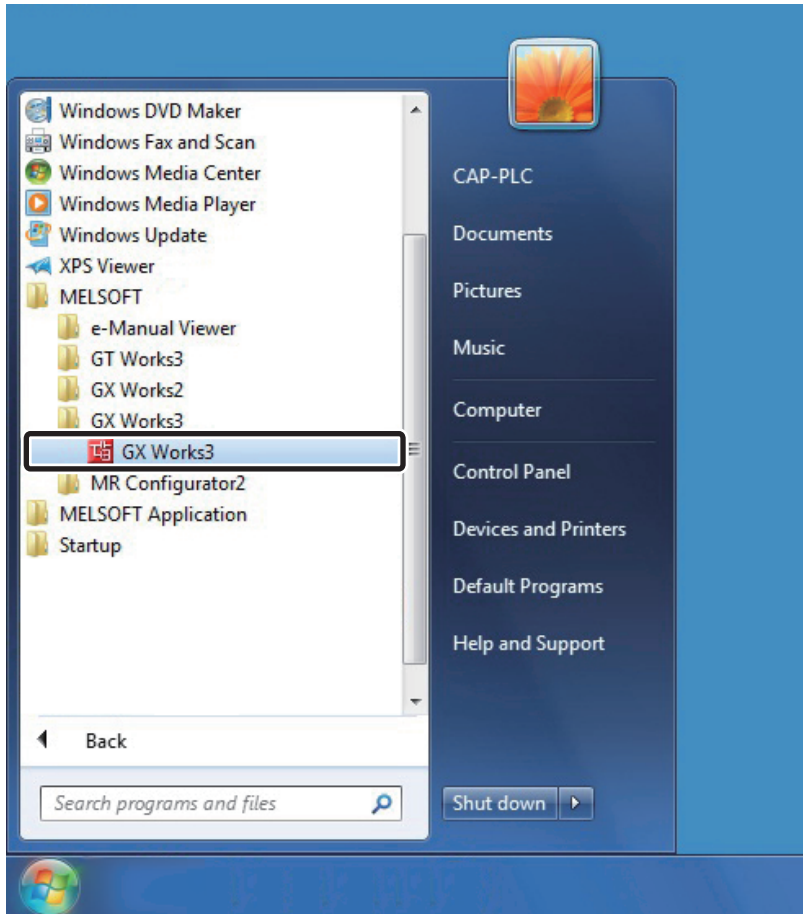

2. After starting, the GX Works3 main screen is displayed.

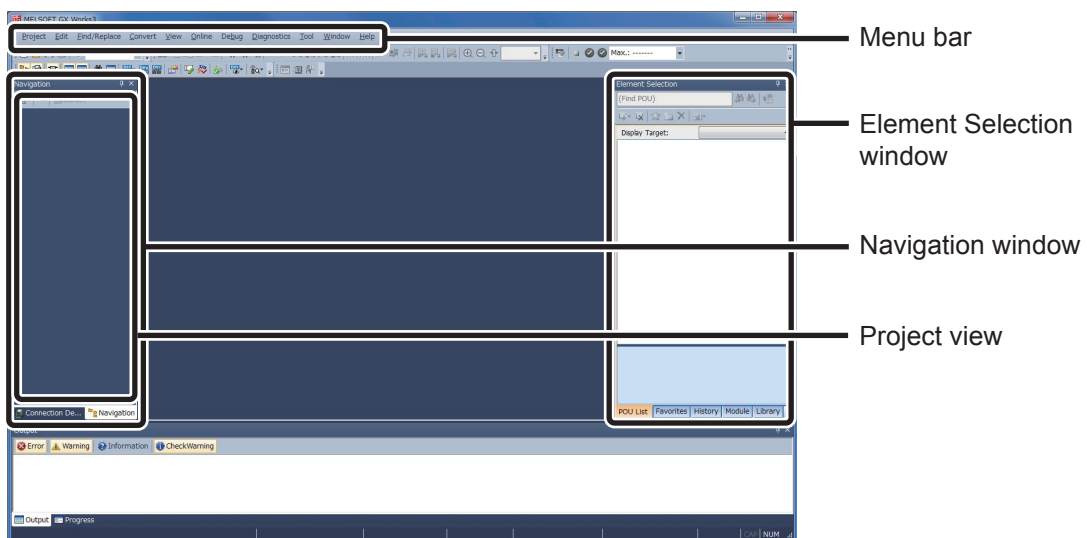

3. Select [Project] → [New].

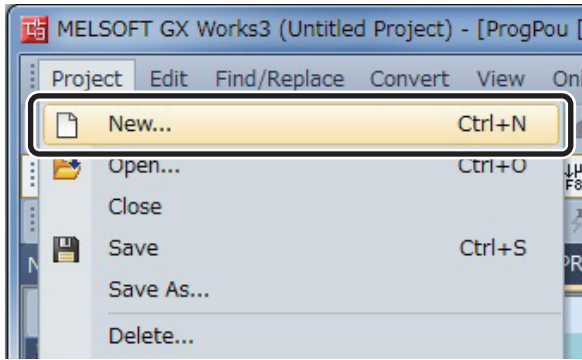

4. The "New" window is displayed.

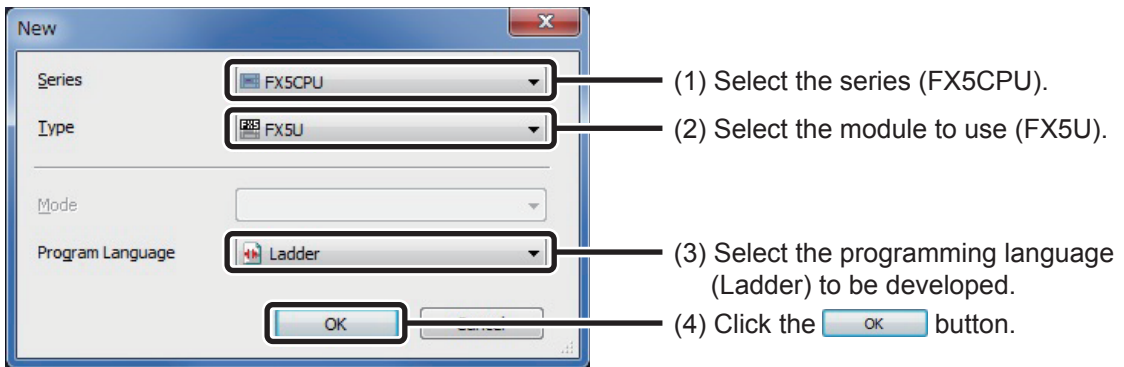

5. A project tree and the ladder screen are displayed.

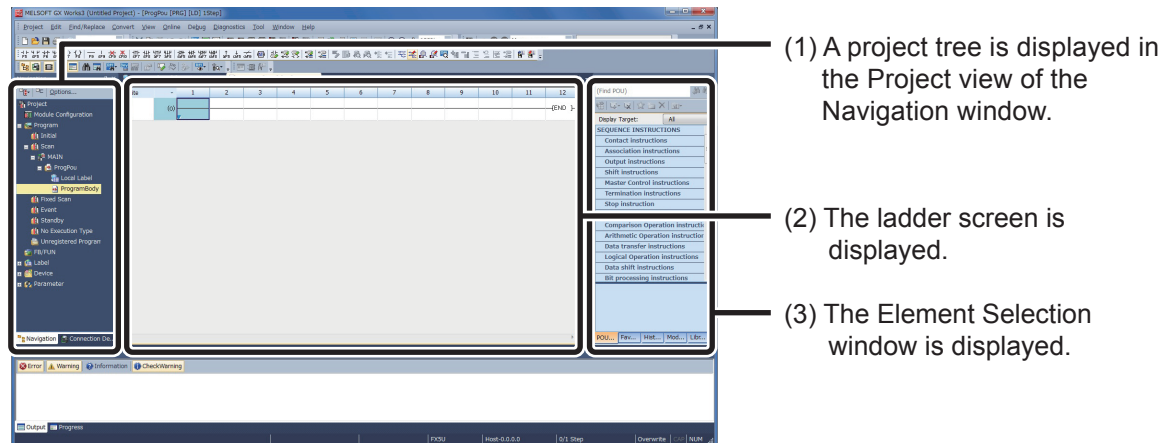



## ② Creating New Data

After a GX Works3 project is created, create a new data file ("Count\_Num" is used as an FB name in this section).

### Operating procedure

1. In the Navigation window, select [FB/FUN], and right-click and select [Add New Data] from the shortcut menu.

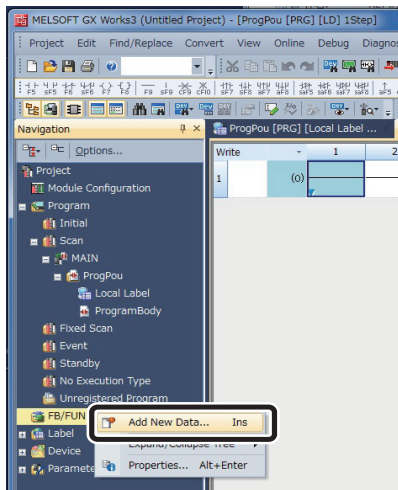

2. The "New Data" window is displayed.

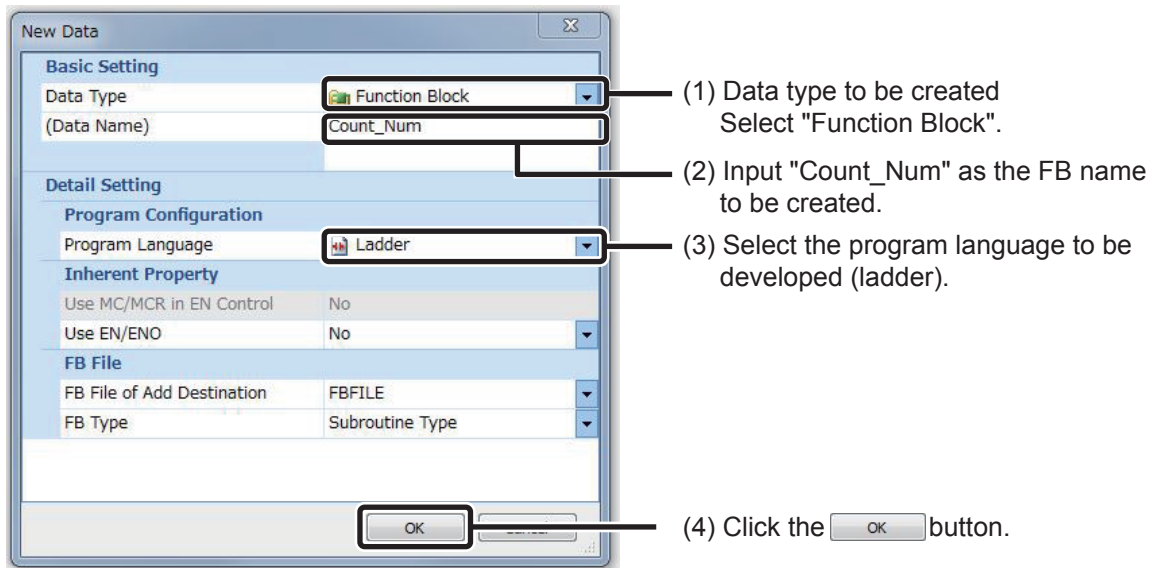

When entering an FB name, be careful of the following points.

- Case-sensitive
- The maximum number of characters for the FB name is 256.

3. The newly created FB (Count\_Num) is added to the Navigation window and the Element Selection window.

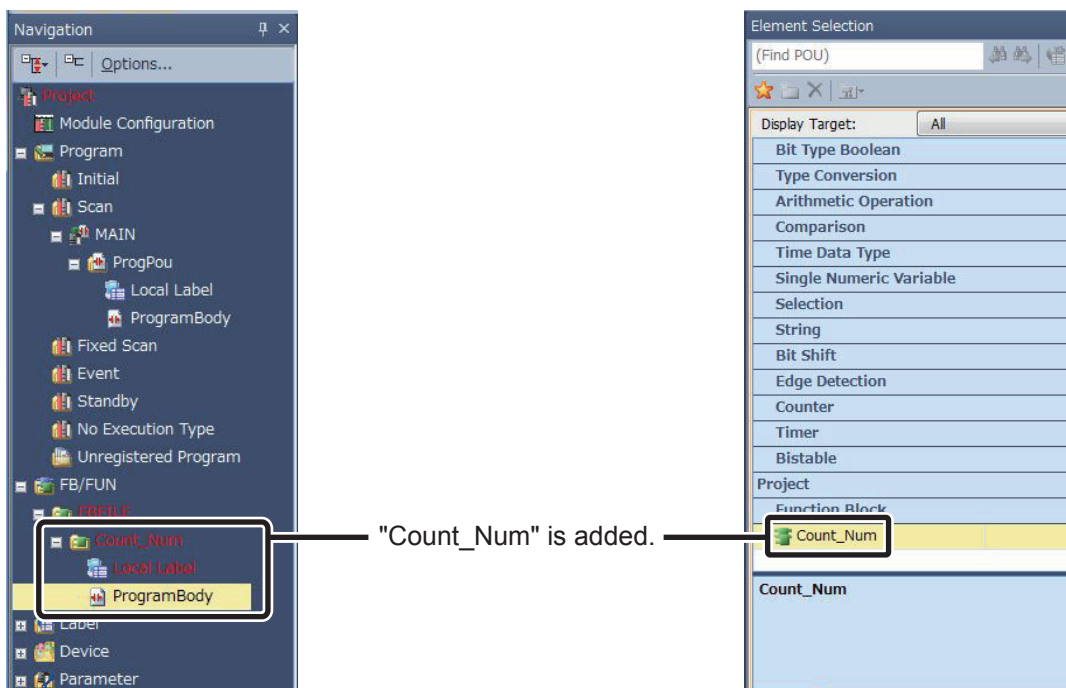

7

2

### ③ Setting Labels

Because FBs are utilized by being converted into components, devices are not used and input labels, output labels, and internal labels are used to create a program.

First, categorize the devices of the sequence program into, input device, output device, and internal device.

Next, set each label for the categorized devices.

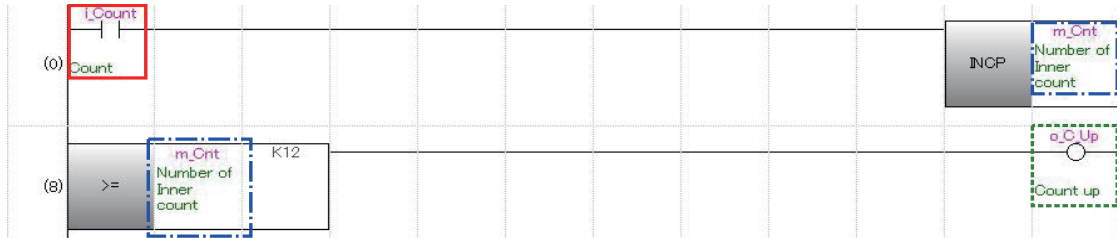

: Input device  
(Device that becomes an input label)

: Output device  
(Device that becomes an output label)

: Internal device  
(Device that becomes an internal label)

The labels corresponding to the actual devices in the FB that is to be created are as shown in the following tables.

Device type	Device name
Input device	X1
Output device	Y12
Internal device	D1

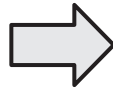

Label type (Class)	Label name	Data type
Input label (VAR_INPUT)	i_Count	bit
Output label (VAR_OUTPUT)	o_C_Up	bit
Internal label (VAR)	m_Cnt	word [signed]

Set the input label, output label, and internal label to be used in the FB in the following section.

## Operating procedure

1. Double-click "Local Label" of the added FB and display the Function/FB Label Setting screen.

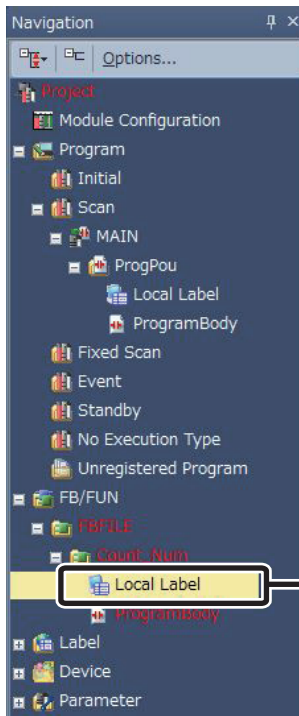

Double-click "Local Label".

2. The Function/FB Label Setting screen is displayed.

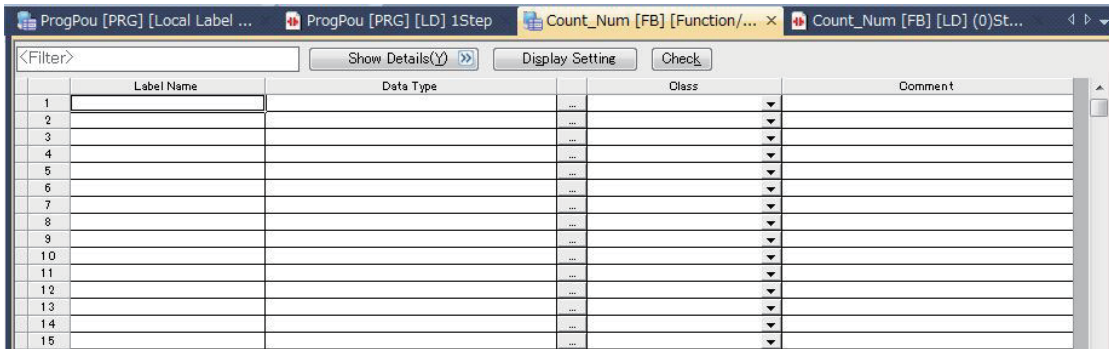

3. Set the labels as follows.

	Label Name	Data Type	Class	Comment
1	i_Count	Bit	VAR_INPUT	Count
2	o_C_Up	Bit	VAR_OUTPUT	Count up
3	m_Cnt	Word [Signed]	VAR	Number of Inner count
4				

— Input label  
— Output label  
— Internal label



The number of development man-hours can be reduced by creating the internal labels that are used normally, as design data with Microsoft® Excel® in advance and entering them by exporting and importing.

## ④ Creating FB Programs

This section explains how to create a sequence program in an FB using the set labels.

### Operating procedure

1. In the Navigation window, select [FB/FUN]→[FBFILE]→[Count\_Num], and double-click [Program Body].

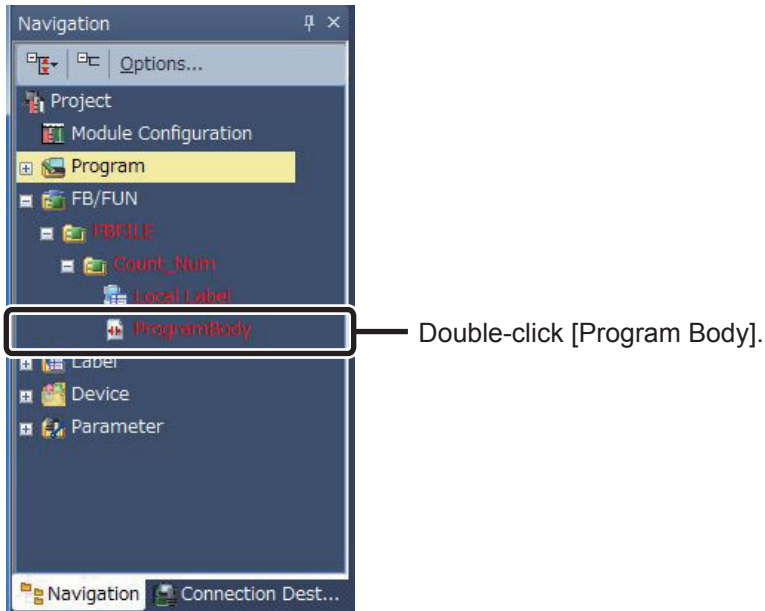

2. The "Count\_Num[FB][LD]" window is displayed.

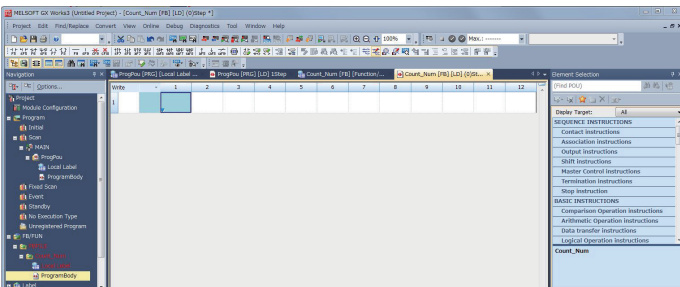

3. Create an FB sequence program.

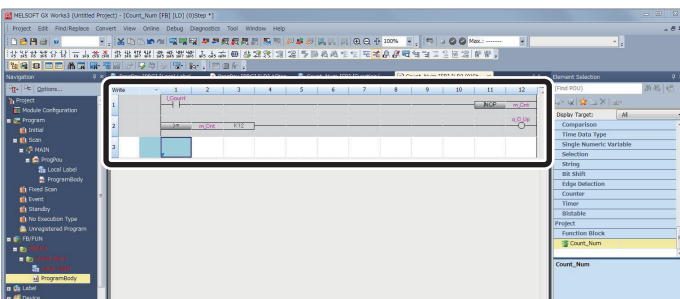

Sequence program of the FB to be created is described as follows.

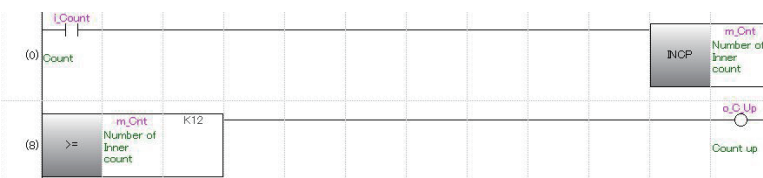

## ⑤ Performing Convert/Rebuild All

In order to operate FBs, it is necessary to convert/rebuild all.  
The procedures to rebuild all are explained below.

### Operating procedure

1. Select [Convert] → [Rebuild All].

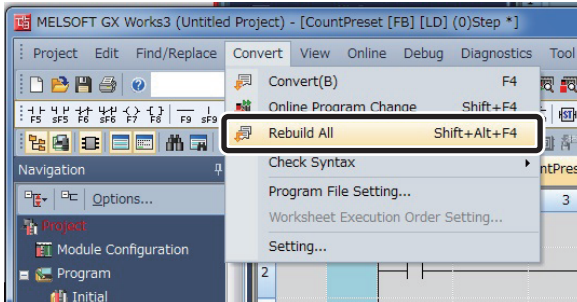

2. The following message is displayed.

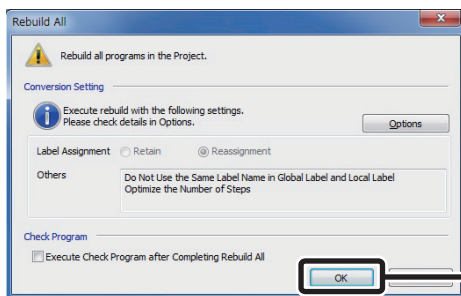

Click the **OK** button.

3. All the programs are converted and the results are displayed in the Output window.

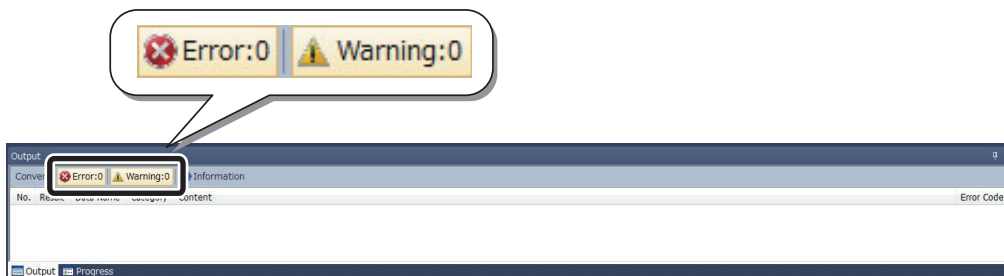

7

5

The sequence program created by pasting the created FB is as follows.

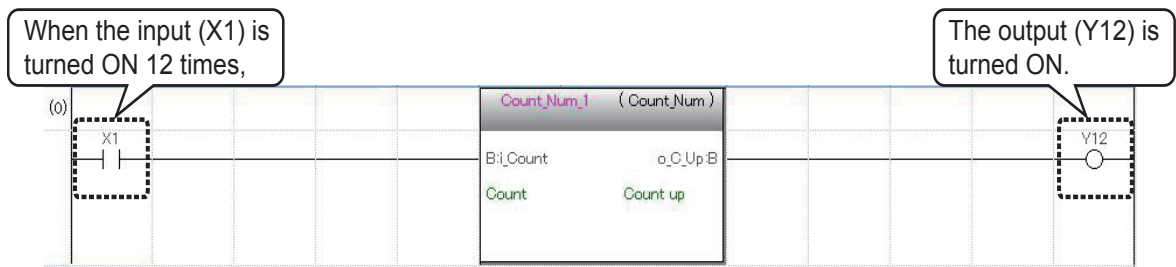

## This completes the creation of a new FB.

For the procedures to use created FB, refer to "③ How to use Module FB" and later sections in "6 Using FB Libraries".

# Protecting Created FBs

A created FB can be protected by setting up a block password.

Outflow of technological know-how can be prevented by using a password, as the password protection disables opening of programs in the FB.

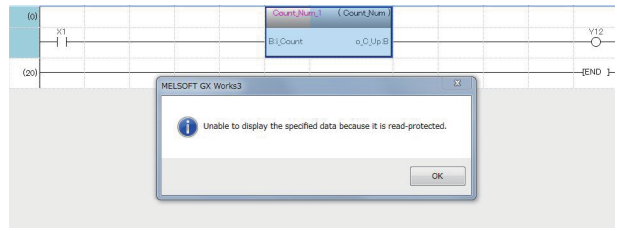

This section explains how to set up a block password for the created FB.

## Caution

If you forget the password, you cannot open the program in the FB.  
Do not lose the password.

## Operating procedure

1. In the Navigation window, select [FB/FUN] → [FBFILE] → [Count\_Num].

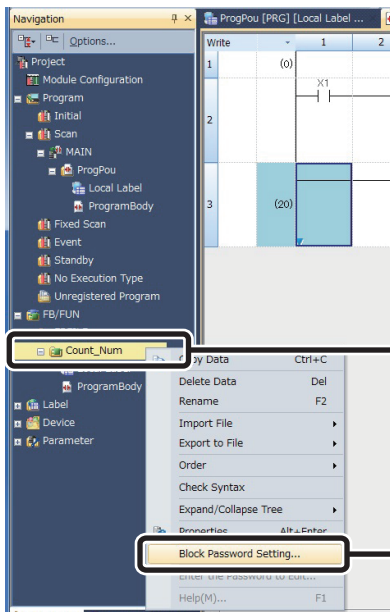

(1) Right-click the created FB "Count\_Num".

(2) Select [Block Password Setting]



2. The "Block Password Setting" window is displayed.

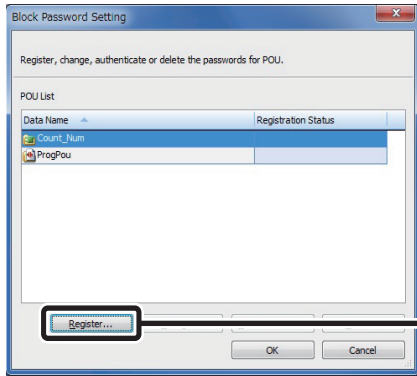

Click the **Register...** button.

3. The "Register Password" window is displayed.

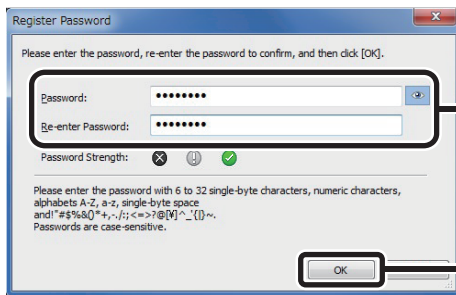

1) Set "Password" and "Re-enter Password".

2) Click the **OK** button.

4. The block password is set to "Count\_Num".

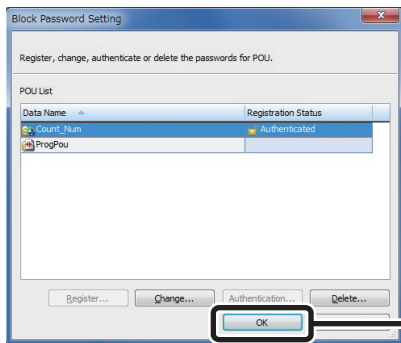

Click the **OK** button.

**Point**

- Locking an FB by using a block password is activated when the project is re-opened.
- The FBs for which the block passwords were set are displayed in the Project view as follows.

Key marks are added to the FB icons.

- A block password can be changed by resetting the password. In this case, unlock the password prior to change.

# How to Use User Libraries

FBs can be utilized in other projects.

When FBs are utilized in other projects, it is necessary to register in the User Library.

This section explains how to use FBs in other projects by using the FB "Count\_Num" created in this guide as an example.

## Operating procedure

1. In the file to be registered in the library, select [Project] → [Library Operation] → [Export Library].

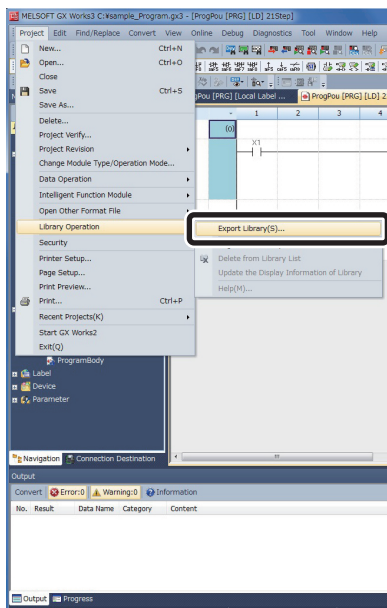

2. The confirmation screen is displayed.

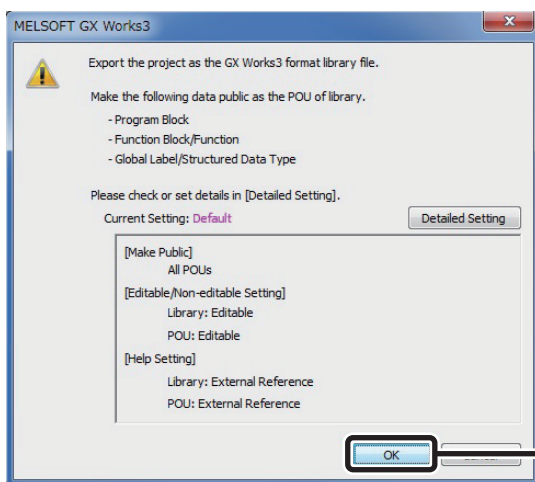

Click the **OK** button.

### 3. Save the file with a new name.

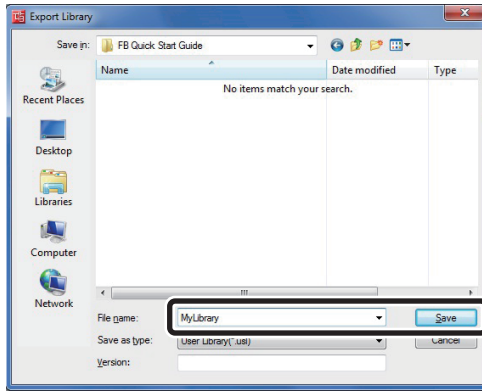

Here, the name is "MyLibrary".

### 4. Start up the project to use the saved user library and register the user library.

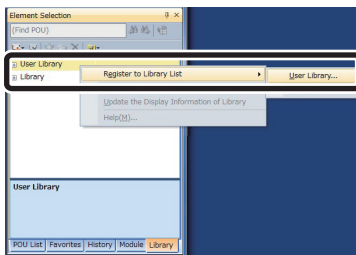

(1) Right-click [User Library]  
→ Click [Register to Library List]  
→ [User Library].

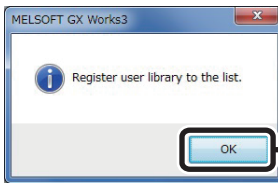

(2) Click the OK button.

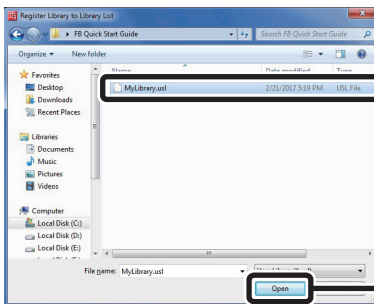

(3) Select the library file created in 3.

(4) Click the Open button.

5. "Count\_Num" was registered in the User Library.

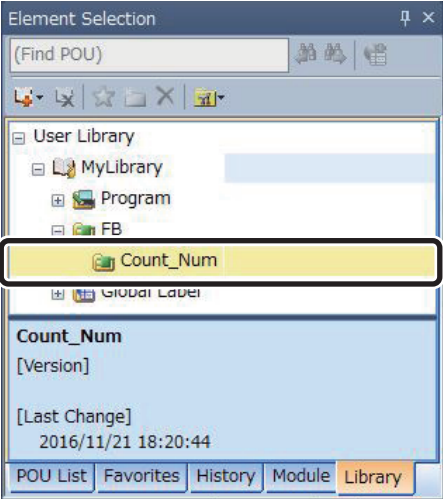

# Techniques for Creating FBs

This section introduces techniques for creating FB sequence programs.

## 1. To transfer multiple bits to a word label

Multiple bits can be transferred to a word label by using BSET and BRST instructions and setting up ON/OFF information for each bit of the target word.



## 2. To use index registers in an FB

When using index registers in an FB, add a save program and restore program for the index registers to protect them.

[Example of creation]

The following shows an example of saving index registers Z7, Z8, and Z9 in the FB prior to executing a program and restoring the index when the program ends.

Label name	Type	Purpose
int_Z_tmp [0]	Word	For saving index register Z9
int_Z_tmp [1]	Word	For saving index register Z8
int_Z_tmp [2]	Word	For saving index register Z7

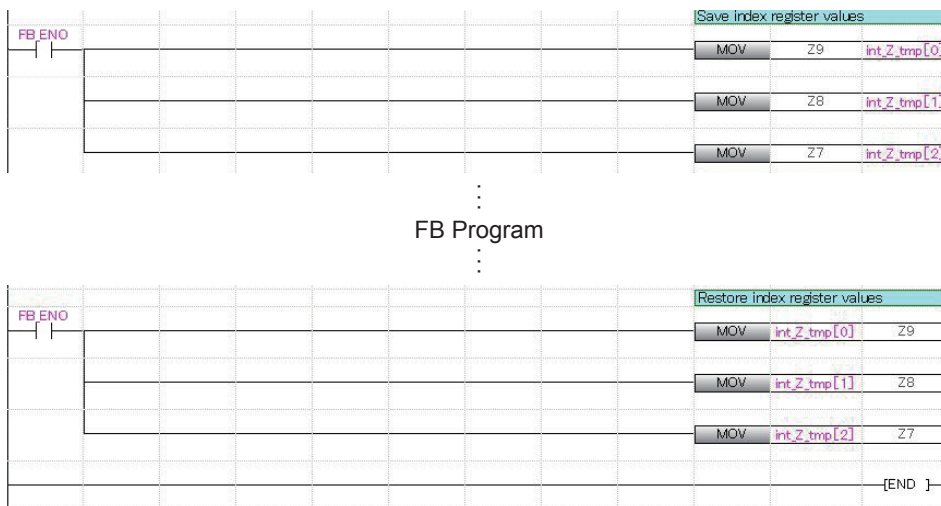

Microsoft, Microsoft Access, Excel, SQL Server, Visual Basic, Visual C++, Visual Studio, Windows, Windows NT, Windows Server, Windows Vista, and Windows XP are trademarks of the Microsoft group of companies.

The company names, system names and product names mentioned in this manual are either registered trademarks or trademarks of their respective companies.

In some cases, trademark symbols such as 'TM' or '®' are not specified in this manual.

#### Precautions before use

This publication explains the typical features and functions of the products herein and does not provide restrictions and other information related to usage and module combinations. Before using the products, always read the product user manuals. Mitsubishi Electric will not be held liable for damage caused by factors found not to be the cause of Mitsubishi Electric; opportunity loss or lost profits caused by faults in Mitsubishi Electric products; damage, secondary damage, or accident compensation, whether foreseeable or not, caused by special factors; damage to products other than Mitsubishi Electric products; and to other duties.

#### For safe use

- To use the products given in this publication properly, always read the relevant manuals before use.
- The products have been manufactured as general-purpose parts for general industries, and have not been designed or manufactured to be incorporated in a device or system used in purposes related to human life.
- Before using the products for special purposes such as nuclear power, electric power, aerospace, medicine or passenger movement vehicles, consult with Mitsubishi.
- The products have been manufactured under strict quality control. However, when installing the products where major accidents or losses could occur if the products fail, install appropriate backup or fail-safe functions in the system.



Country/Region	Sales office	Tel/Fax
USA	<p>500 Corporate Woods Parkway, Vernon Hills, IL 60061, U.S.A.</p>	<p>Tel : +1-847-478-2100 Fax : +1-847-478-2253</p>
Mexico	<p>MITSUBISHI ELECTRIC AUTOMATION, INC. Mexico Branch Mariano Escobedo #69, Col. Zona Industrial, Tlalhepantla Edo. Mexico, C.P.54030</p>	<p>Tel : +52-55-3067-7500</p>
Brazil	<p>MITSUBISHI ELECTRIC DO BRASIL COMÉRCIO E SERVIÇOS LTDA. Avenida Adelino Cardana, 293, 21 andar, Bethaville, Barueri SP, Brazil</p>	<p>Tel : +55-11-4689-3000 Fax : +55-11-4689-3016</p>
Germany	<p>MITSUBISHI ELECTRIC EUROPE B.V. German Branch Mitsubishi-Electric-Platz 1, 40882 Ratingen, Germany</p>	<p>Tel : +49-2102-486-0 Fax : +49-2102-486-1120</p>
UK	<p>MITSUBISHI ELECTRIC EUROPE B.V. UK Branch Travellers Lane, Hatfield, Hertfordshire, AL10 8XB, U.K.</p>	<p>Tel : +44-1707-28-8780 Fax : +44-1707-27-8695</p>
Ireland	<p>MITSUBISHI ELECTRIC EUROPE B.V. Irish Branch Westgate Business Park, Ballymount, Dublin 24, Ireland</p>	<p>Tel : +353-1-4198800 Fax : +353-1-4198890</p>
Italy	<p>MITSUBISHI ELECTRIC EUROPE B.V. Italian Branch Centro Direzionale Colleoni-Palazzo Sirio Viale Colleoni 7, 20864 Agrate Brianza(Milano) Italy</p>	<p>Tel : +39-039-60531 Fax : +39-039-6053-312</p>
Spain	<p>MITSUBISHI ELECTRIC EUROPE, B.V. Spanish Branch Carretera de Rubí, 76-80-Apdo. 420, 08190 Sant Cugat del Vallés (Barcelona), Spain</p>	<p>Tel : +34-935-65-3131 Fax : +34-935-89-1579</p>
France	<p>MITSUBISHI ELECTRIC EUROPE B.V. French Branch 25, Boulevard des Bouvets, 92741 Nanterre Cedex, France</p>	<p>Tel : +33-1-55-68-55-68 Fax : +33-1-55-68-57-57</p>
Czech Republic	<p>MITSUBISHI ELECTRIC EUROPE B.V. Czech Branch Avenir Business Park, Radlicka 751/113e, 158 00 Praha5, Czech Republic</p>	<p>Tel : +420-251-551-470 Fax : +420-251-551-471</p>
Poland	<p>MITSUBISHI ELECTRIC EUROPE B.V. Polish Branch ul. Krakowska 50, 32-083 Balice, Poland</p>	<p>Tel : +48-12-347-65-00 Fax : +48-12-630-47-01</p>
Sweden	<p>MITSUBISHI ELECTRIC EUROPE B.V. (Scandinavia) Fjellievägen 8, SE-22736 Lund, Sweden</p>	<p>Tel : +46-8-625-10-00 Fax : +46-46-39-70-18</p>
Russia	<p>MITSUBISHI ELECTRIC (RUSSIA) LLC St. Petersburg Branch Piskarevsky pr. 2, bld 2, lit "Sch", BC "Benua", office 720; 195027 St. Petersburg, Russia</p>	<p>Tel : +7-812-633-3497 Fax : +7-812-633-3499</p>
Turkey	<p>MITSUBISHI ELECTRIC TURKEY A.Ş Ümraniye Branch Serifali Mah. Kale Sok. No:41 34775 Umraniye - Istanbul, Turkey</p>	<p>Tel : +90-216-969-2500 Fax : +90-216-526-3995</p>
UAE	<p>MITSUBISHI ELECTRIC EUROPE B.V. Dubai Branch Dubai Silicon Oasis, P.O.BOX 341241, Dubai, U.A.E.</p>	<p>Tel : +971-4-3724716 Fax : +971-4-3724721</p>
South Africa	<p>ADROIT TECHNOLOGIES 20 Waterford Office Park, 189 Witkoppen Road, Fourways, South Africa</p>	<p>Tel : +27-11-658-8100 Fax : +27-11-658-8101</p>
China	<p>MITSUBISHI ELECTRIC AUTOMATION (CHINA) LTD. No.1386 Hongqiao Road, Mitsubishi Electric Automation Center, Shanghai, China</p>	<p>Tel : +86-21-2322-3030 Fax : +86-21-2322-3000</p>
Korea	<p>MITSUBISHI ELECTRIC AUTOMATION KOREA CO., LTD. 7F-9F, Gangseo Hangang Xi-tower A, 401, Yangcheon-ro, Gangseo-Gu, Seoul 07528, Korea</p>	<p>Tel : +82-2-3660-9530 Fax : +82-2-3664-8372</p>
Singapore	<p>MITSUBISHI ELECTRIC ASIA PTE. LTD. 307, Alexandra Road, Mitsubishi Electric Building, Singapore 159943</p>	<p>Tel : +65-6473-2308 Fax : +65-6476-7439</p>
Thailand	<p>MITSUBISHI ELECTRIC FACTORY AUTOMATION (THAILAND) CO., LTD. 12th Floor, SV.City Building, Office Tower 1, No. 896/19 and 20 Rama 3 Road, Kwaeng Bangpongpan, Khet Yannawa, Bangkok 10120, Thailand</p>	<p>Tel : +66-2682-6522 Fax : +66-2682-6020</p>
Vietnam	<p>MITSUBISHI ELECTRIC VIETNAM COMPANY LIMITED Hanoi Branch 6th Floor, Detech Tower, 8 Ton That Thuyet Street, My Dinh 2 Ward, Nam Tu Liem District, Hanoi, Vietnam</p>	<p>Tel : +84-4-3937-8075 Fax : +84-4-3937-8076</p>
Malaysia	<p>MITSUBISHI ELECTRIC SALES MALAYSIA SDN. BHD. Lot 11, Jalan 219, 46100 Petaling Jaya, Selangor Darul Ehsan, Malaysia</p>	<p>Tel : +60-3-7626-5000 Fax : +60-3-7658-3544</p>
Indonesia	<p>PT. MITSUBISHI ELECTRIC INDONESIA Gedung Jaya 11th Floor, JL. MH. Thamrin No.12, Jakarta Pusat 10340, Indonesia</p>	<p>Tel : +62-21-3192-6461 Fax : +62-21-3192-3942</p>
India	<p>MITSUBISHI ELECTRIC INDIA PVT. LTD. Pune Branch Emerald House, EL-3, J Block, M.I.D.C., Bhosari, Pune-411026, Maharashtra, India</p>	<p>Tel : +91-20-2710-2000 Fax : +91-20-2710-2100</p>
Australia	<p>MITSUBISHI ELECTRIC AUSTRALIA PTY. LTD. 348 Victoria Road, P.O. Box 11, Rydalmere, N.S.W 2116, Australia</p>	<p>Tel : +61-2-9684-7777 Fax : +61-2-9684-7245</p>

## MITSUBISHI ELECTRIC CORPORATION

HEAD OFFICE: TOKYO BLDG., 2-7-3, MARUNOUCHI, CHIYODA-KU, TOKYO 100-8310, JAPAN

[www.MitsubishiElectric.com](http://www.MitsubishiElectric.com)