

PLC

Intelligent Function Module (MELSEC iQ-R Series)

Programmable controller control is not limited to only simple input and output operation. Functionality can be extended by using the intelligent function module.

Introduction Purpose of the course

This course is aimed at those who will start or have just started using the MELSEC iQ-R Series intelligent function module. This course covers the fundamentals of the intelligent function module, the procedures to control the intelligent function module using the engineering software MELSOFT GX Works3 or programs, and the procedures to identify and resolve errors.

As prerequisites for this course, you should have already completed the following courses or possess the equivalent knowledge.

- MELSEC iQ-R Series Basic
- Programming Basics

Introduction **Course structure**

The contents of this course are as follows.

Chapter 1 - Intelligent function module fundamentals

Intelligent function module fundamentals and design concepts

Chapter 2 - Intelligent function module setting and control procedures

Intelligent function module setting and control procedures using parameter settings and programs

Chapter 3 - Identifying errors and troubleshooting

Identification procedures for the errors that occur during startup and operation

Final Test

Pass grade: 60% or higher

Introduction How to use this e-Learning tool



Go to the next page		Go to the next page.
Back to the previous page		Back to the previous page.
Move to the desired page		"Table of Contents" will be displayed, enabling you to navigate to the desired page.
Exit the learning		Exit the learning.

Safety precautions

When you learn based on using actual products, please carefully read the safety precautions in the corresponding manuals.

Precautions in this course

The displayed screens of the software version that you use may differ from those in this course.

This course uses the following software version:

- GX Works3 Version 1.032J

Chapter 1 Intelligent function module fundamentals

This chapter describes the fundamentals and design concepts of the intelligent function module.

- 1.1 Overview of the intelligent function module
- 1.2 Internal configuration of the intelligent function module
- 1.3 Design concepts of the intelligent function module control

1.1

Overview of the intelligent function module

The intelligent function module extends programmable controller functionality. This extended functionality includes input/output control of analog signals (voltage, current, temperature, and others), FA network connectivity for the exchange of data between connected devices, and precise positioning control.

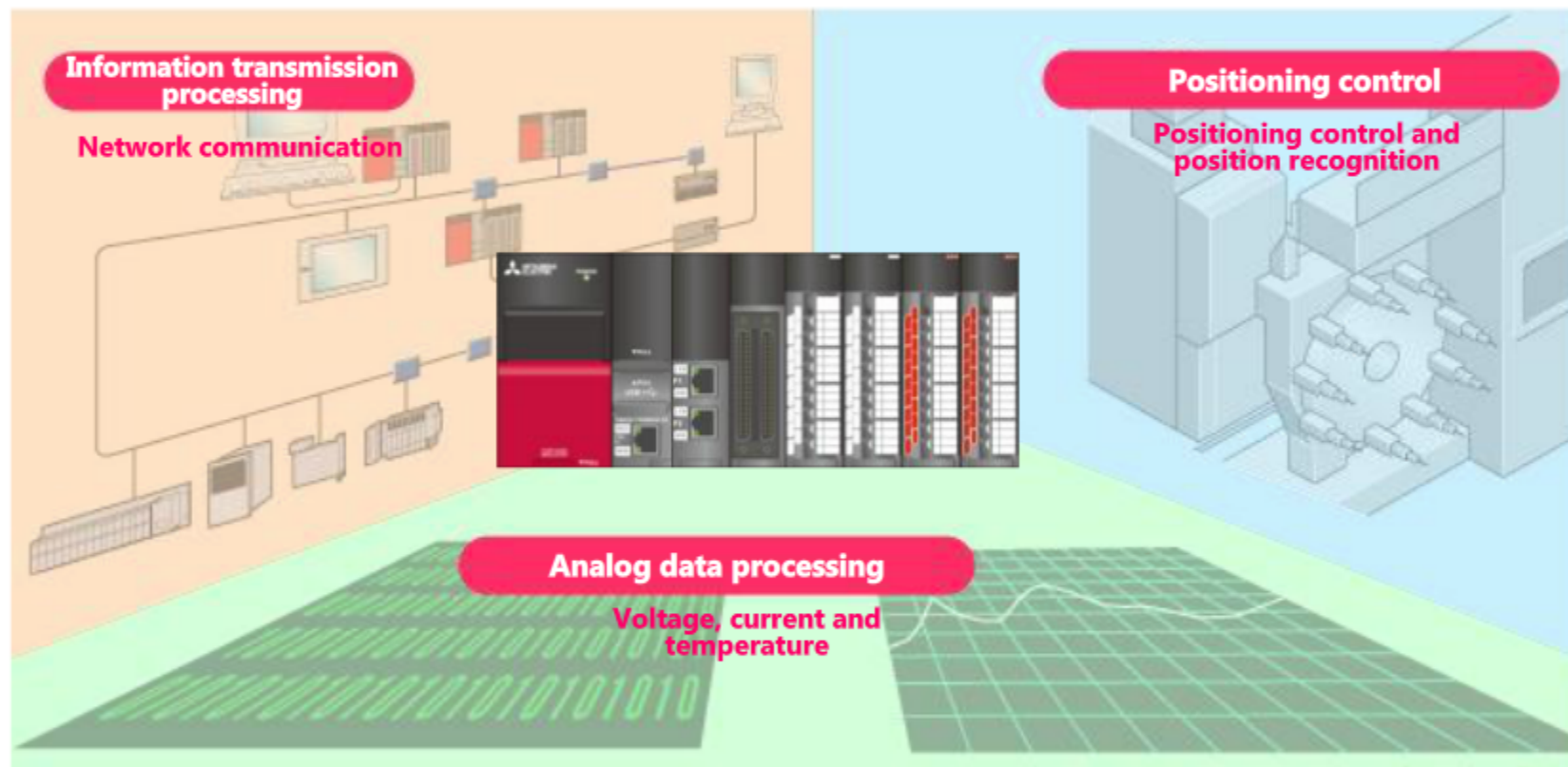

1.1.1

Types of intelligent function modules

The following table lists the main types of intelligent function modules and a corresponding overview.

Type	Name of module	Functional overview
Analog module	Analog input module	Converts analog input signals of voltage and current into digital data, and then transfers them to the programmable controller CPU.
	Analog output module	Converts the digital data received from the programmable controller CPU into analog signals of voltage and current, and then outputs them to connected devices.
	Temperature input module	Converts the analog input signals received from connected temperature sensors into digital data, and then transfers them to the programmable controller CPU.
	Temperature control module	Calculates the manipulated value using the temperature commanded by the programmable controller CPU and the analog input signal of temperature received from connected temperature sensors. This manipulated value is used for control of connected devices so that the temperature is automatically regulated at the commanded temperature.
Positioning/ counter module	High-speed counter module	Receives pulse train signals from rotary encoders and other sources, and counts the number of pulses. Machine speed, position, and orientation can be checked with the count result.
	Positioning module	Converts the positioning information received from the programmable controller CPU into the positioning command signal (position and speed), and then outputs them to servo amplifiers.
Network module	Serial communication module	Communicates with other devices over RS-232 communications.
	Ethernet interface module	Communicates with other devices over Ethernet.

1.2 Internal configuration of the intelligent function module

The following diagram illustrates the internal configuration of the intelligent function module and relationships with the programmable controller CPU module.

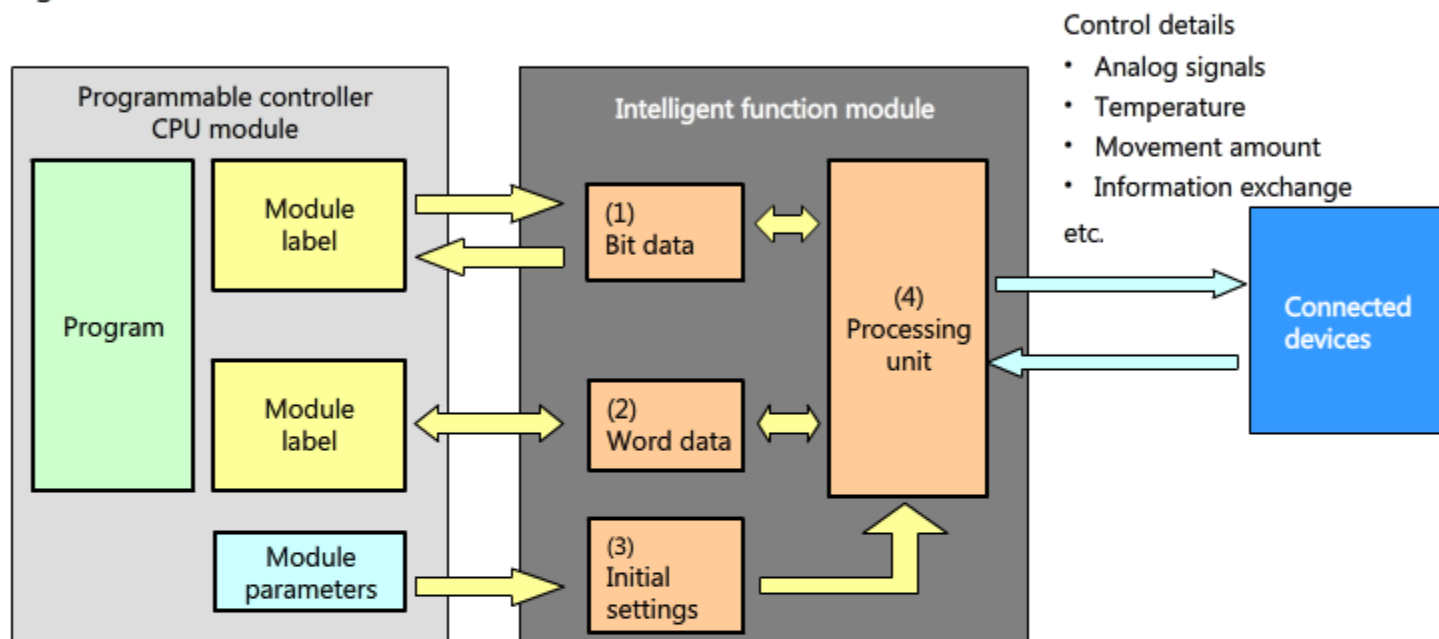

(1)	Bit data	This interface sends and receives bit signals, which represent on/off states.
(2)	Word data	This interface sends and receives word data.
(3)	Initial settings	These settings represent the initial module control specifications.
(4)	Processing unit	This unit processes commands received from (1), (2), and (3), and returns the result to the CPU module.

1.3 Design concepts of the intelligent function module control

1.3.1 Role of I/O signals

I/O signals are bit signals that represent on/off states. These signals are used to control the intelligent function module.

Input signals

These signals notify the status of intelligent function module to the programmable controller CPU module.

Output signals

These signals represent instructions sent from the programmable controller CPU module to the intelligent function module.

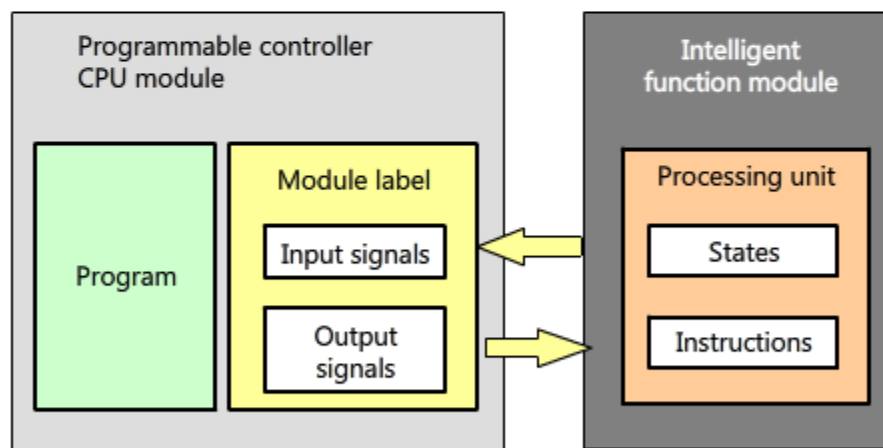

Signals used with analog output modules

Input signals

- Module ready output signal
- Error detection flag

Output signals

- CH output enable/disable flag
- Error clear request

1.3.2

Role of setting data and control data

Data exchanged between the intelligent function module and programmable controller CPU includes setting data and control data.

Setting data

When the intelligent function module first starts up, the programmable controller CPU module sends the initial settings to the intelligent function module.

Control data

This information is exchanged between the programmable controller CPU module and intelligent function module while the processing unit in the intelligent function module is operating.

Control data includes data sent from the programmable controller CPU module to the intelligent function module and data representing processing results returned by the intelligent function module to the CPU module.

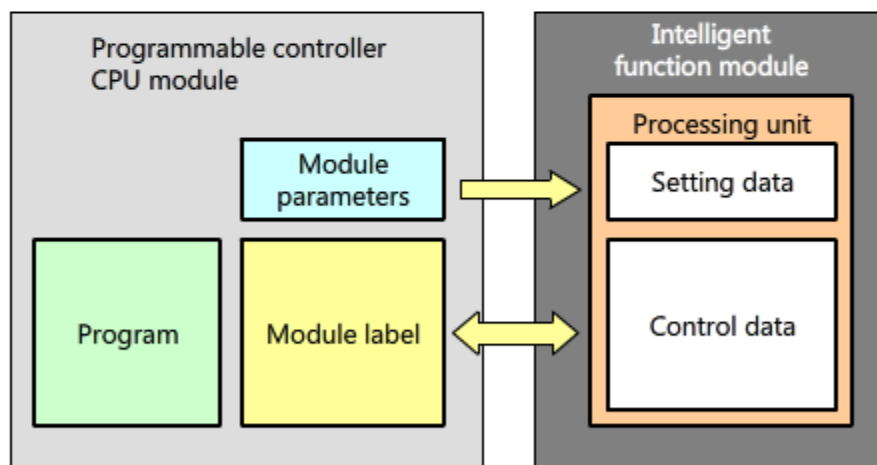

Data used with analog output modules

Setting data

- D/A conversion enabled/disabled for each channel

Control data

- Digital value for each channel
- Setting value check code for each channel
- Status and error codes

The contents of this chapter are:

- Overview of the intelligent function module and the types of modules
- Internal configuration of the intelligent function module
- Design concepts of the intelligent function module control

Important points to consider:

Type of module	<p>The intelligent function module extends programmable controller functionality. Available modules include the following:</p> <ul style="list-style-type: none"> • Input/output control of analog signals for voltage, current, temperature, and more • FA network connectivity for the exchange of data between connected devices • Precise positioning control
Processed data	The intelligent function module process bit data and word data.
Role of bit data	<ul style="list-style-type: none"> • I/O signals are bit signals that represent on/off states. These signals are used to control the intelligent function module. • Input signals notify the intelligent function module state to the programmable controller CPU module • Output signals represent instructions sent from the programmable controller CPU module to the intelligent function module
Role of word data	<ul style="list-style-type: none"> • Setting data and control data in the intelligent function module processing unit is exchanged as word data • Setting data: When the intelligent function module first starts up, the programmable controller CPU module sends the initial settings to the intelligent function module • Control data: This information is exchanged between the programmable controller CPU module and intelligent function module while the processing unit is operating • Word data representing instructions is sent by the programmable controller CPU module, and word data representing processing results is sent by the intelligent function module

Chapter 2 Intelligent function module setting and control procedures

This chapter describes the procedures to set and control the intelligent function module by using module parameters configured with engineering software or by using programs.
The engineering software MELSOFT GX Works3 is used in the description of these procedures.

2.1 Setting the intelligent function module

2.2 Controlling the intelligent function module

2.1 Setting the intelligent function module

2.1.1 Adding a module

Configure the module configuration diagram with the intelligent function module in use.
The R60DA4 analog output module is used in this course.

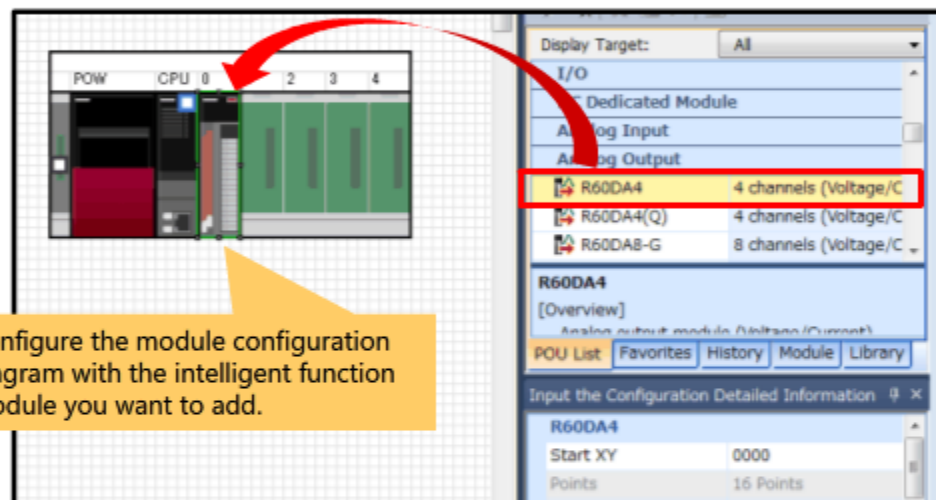

Configure the module configuration diagram with the intelligent function module you want to add.

Module configuration diagram

Once the module is placed onto the diagram, module parameters and module labels are added. The module parameters set the module operation and the module labels represent setting values and the module signals corresponding to the module slot position. Module labels are selected for use from a list during the programming process.

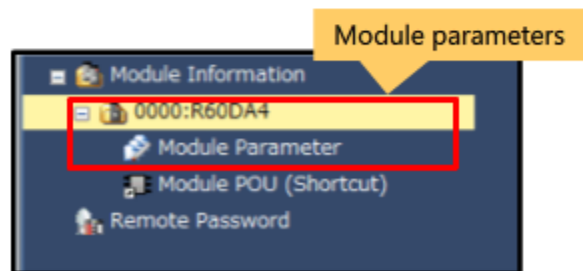

Navigation window

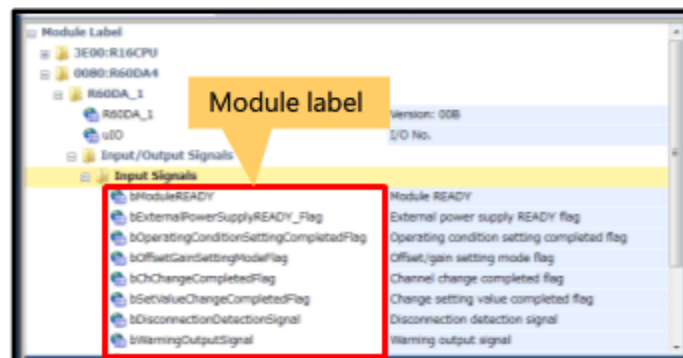

Element selection window

2.1.2 Overview of module parameters

Module parameters are used to configure the initial settings for intelligent function modules and the refresh settings used to determine the transfer destination of control data.

Module parameters are set using engineering software.

Module parameter settings are updated by powering on or resetting the system.

■ Conceptual diagram of data communication

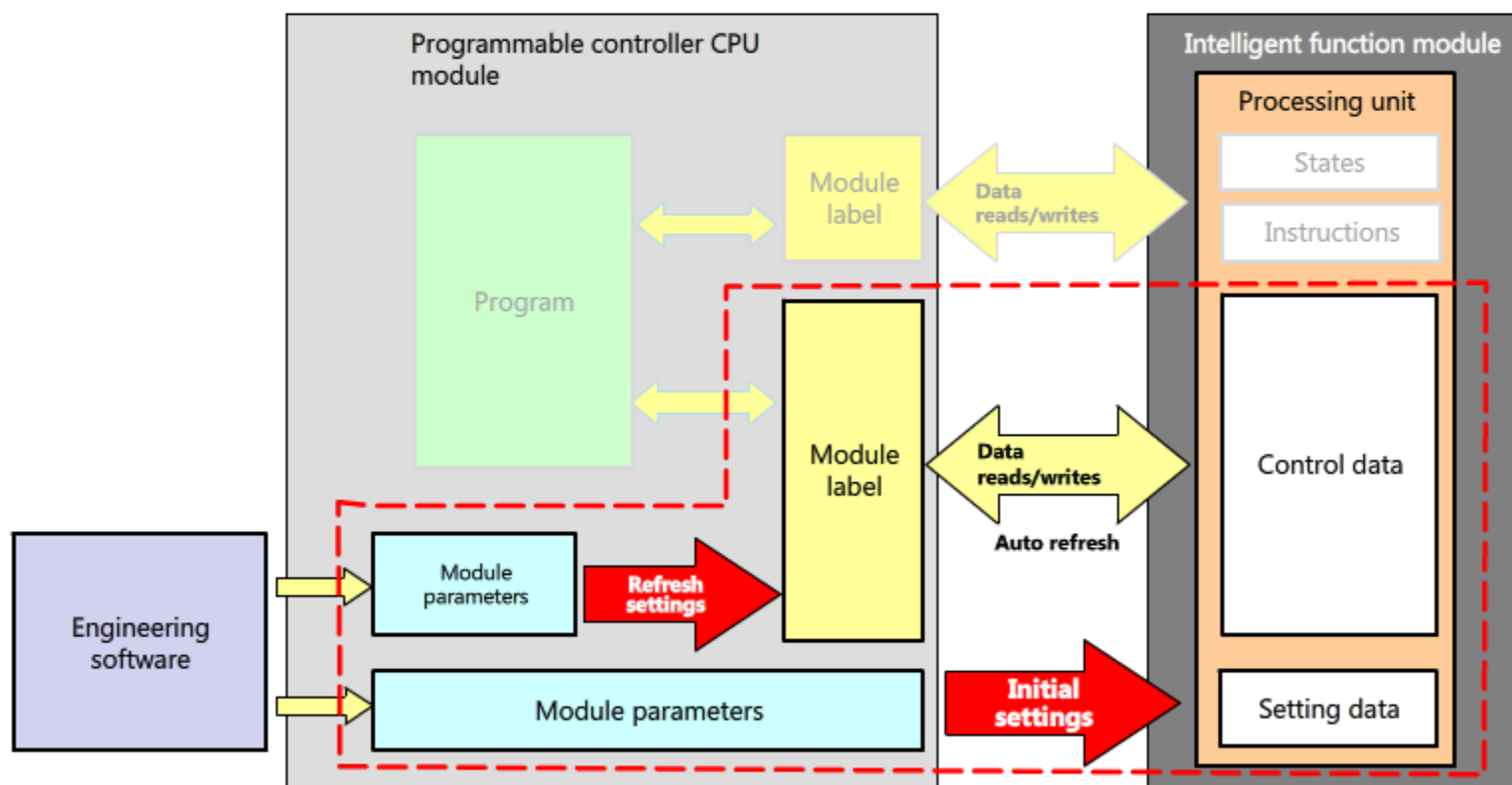

Control data is automatically transferred to module labels in accordance with the refresh settings (auto refresh).

2.1.3 Setting the module parameters (initial settings)

The following shows the setting window for module parameters.
 Initial settings can be configured using module parameters or programs.
 This course covers the module parameter method using engineering software as this method is easier to use.

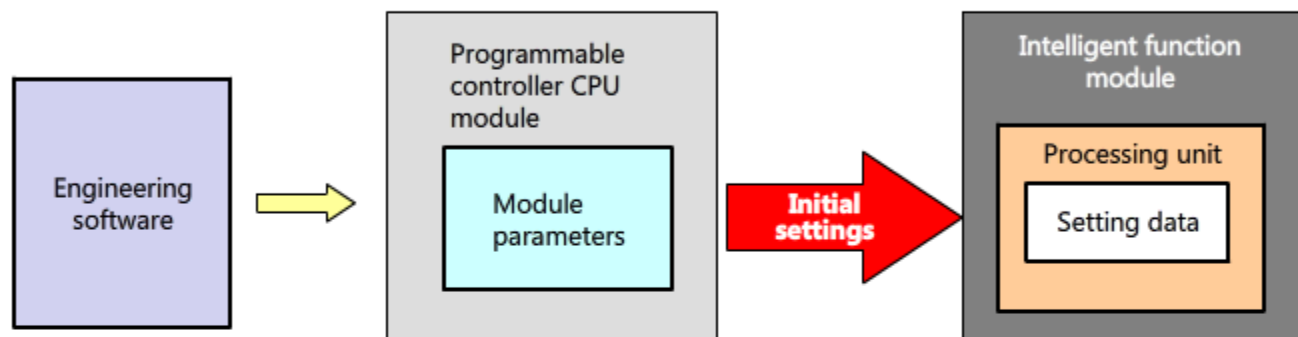

The screenshot shows the setting window for the R60DA4 analog output module. The available parameters depend on the module type. For more information, refer to the manual for the module used.

The module model name and start I/O number appear here.

Parameter names appear here.

CH1 D/A conversion is enabled for the system in this course.

Parameters are configured for each channel. Available options can be selected from a list for parameters with a predetermined range of setting values.

A description of the selected parameter appears here.

Module parameter setting window

Item	CH1	CH2	CH3	CH4
Range switching function Output range setting	This function enables to select the output range to be used from multiple ranges.			
	4 to 20mA			4 to 20mA
Operation mode setting function Operation mode setting	The two operation modes are "Normal mode (D/A conversion)" and "Offset/gain setting mode" to execute the output.			
	Normal mode (D/A conversion)			
Output mode setting	Normal output mode			
Output mode setting function Analog output HOLD/CLEAR setting	HOLD or CLEAR can be set for each channel. Refer to the manual for the analog output HOLD/CLEAR setting.			
	CLEAR	CLEAR	CLEAR	CLEAR
D/A conversion enable/disable function D/A conversion enable/disable setting	This function sets whether to enable or disable the D/A conversion for each channel.			
	D/A conversion disable	D/A conversion disable	D/A conversion disable	D/A conversion enable

2.1.4 Setting the module parameters (refresh settings)

The following shows the refresh setting window.

Refresh settings enable control data (word data) to be automatically exchanged between the programmable controller CPU module and intelligent function module during processing.

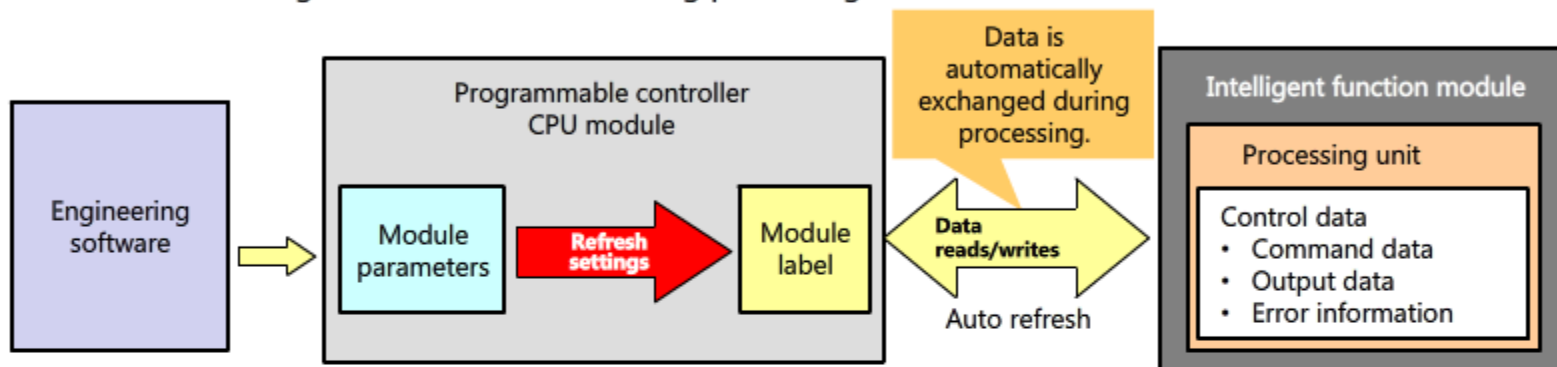

Item	CH1	CH2	CH3	CH4
Refresh at the set timing.				
Transfer to the intelligent function module.				
<i>Digital value</i>				
Transfer to the CPU.				
Latest error code				
Latest address of error history				
Latest alarm code				
Latest address of alarm history				
Interrupt factor detection flag 1				
Interrupt factor detection flag 2				
Interrupt factor detection flag 3				
Transfer the buffer memory data to the specified device.				
Enable	Enable	Enable	Enable	Enable
Transfer the buffer memory data to the specified device.				
Enable	Enable	Enable	Enable	Enable
Transfer the buffer memory data to the specified device.				
Enable	Enable	Enable	Enable	Enable
Transfer the buffer memory data to the specified device.				
Enable	Enable	Enable	Enable	Enable
Transfer the buffer memory data to the specified device.				
Enable	Enable	Enable	Enable	Enable

Explanation

(1) The digital value (16-bit signed binary data) for the D/A conversion is set for each channel from the CPU module.

Module parameter setting window (refresh settings)

The method of processing control data with module labels will be described next.

2.2

Controlling the intelligent function module

This section describes the procedure for controlling intelligent function modules with programs.

2.2.1

Accessing I/O signals with module labels

I/O signals are accessed using module labels.

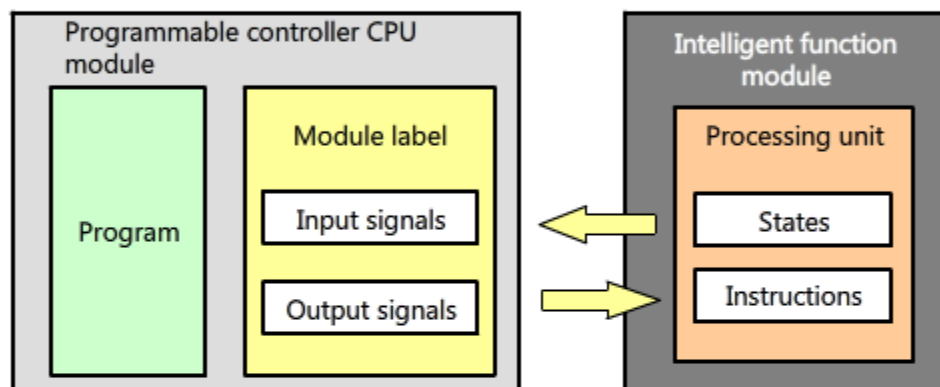

■ I/O signal accessing program

The CH1 output enable flag is turned on when the R60DA4 module ready signal is turned on. Programs are created by selecting the desired module label from the list of registered labels.

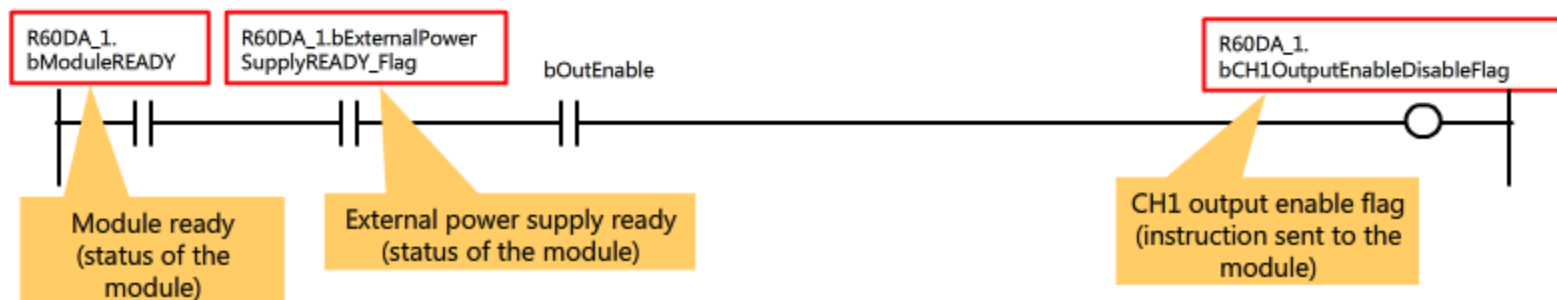

2.2.2

Exchanging control data with module labels

This section describes the method of reading and writing control data (word data).

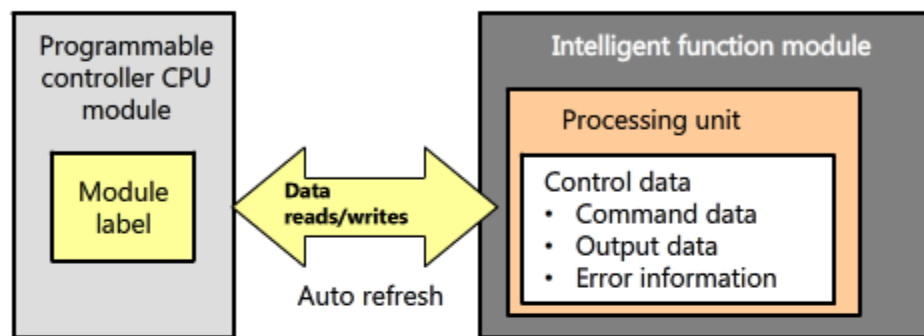

■ Reading control data

Triggered error codes are transferred to the "uErrorCode" label.

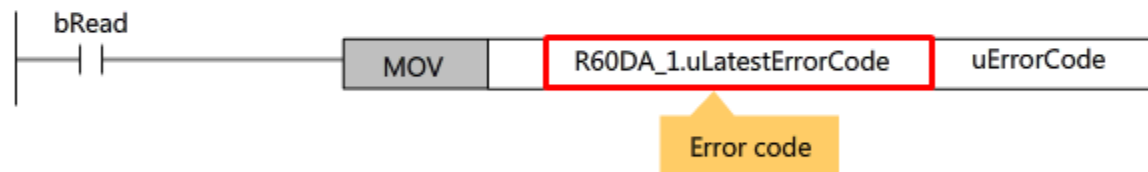

■ Writing control data

A digital value of "16000" is written to the analog output module.

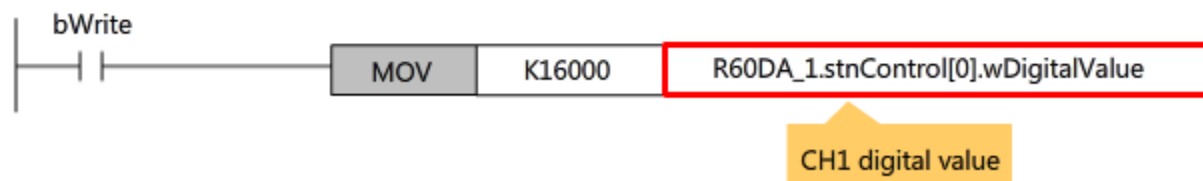

2.2.3

Programs for controlling the analog output module

The following shows a program that outputs an analog signal from CH1 of the R60DA4 analog output module. A module function block added by setting the module configuration diagram is used to monitor module error status. The "**Conversion enable**" and "**Output enable**" settings must be turned on for each channel that you want to enable analog output. The "Conversion enable" setting is turned on with module parameters. The "Output enable" setting is turned on with a program.

Program

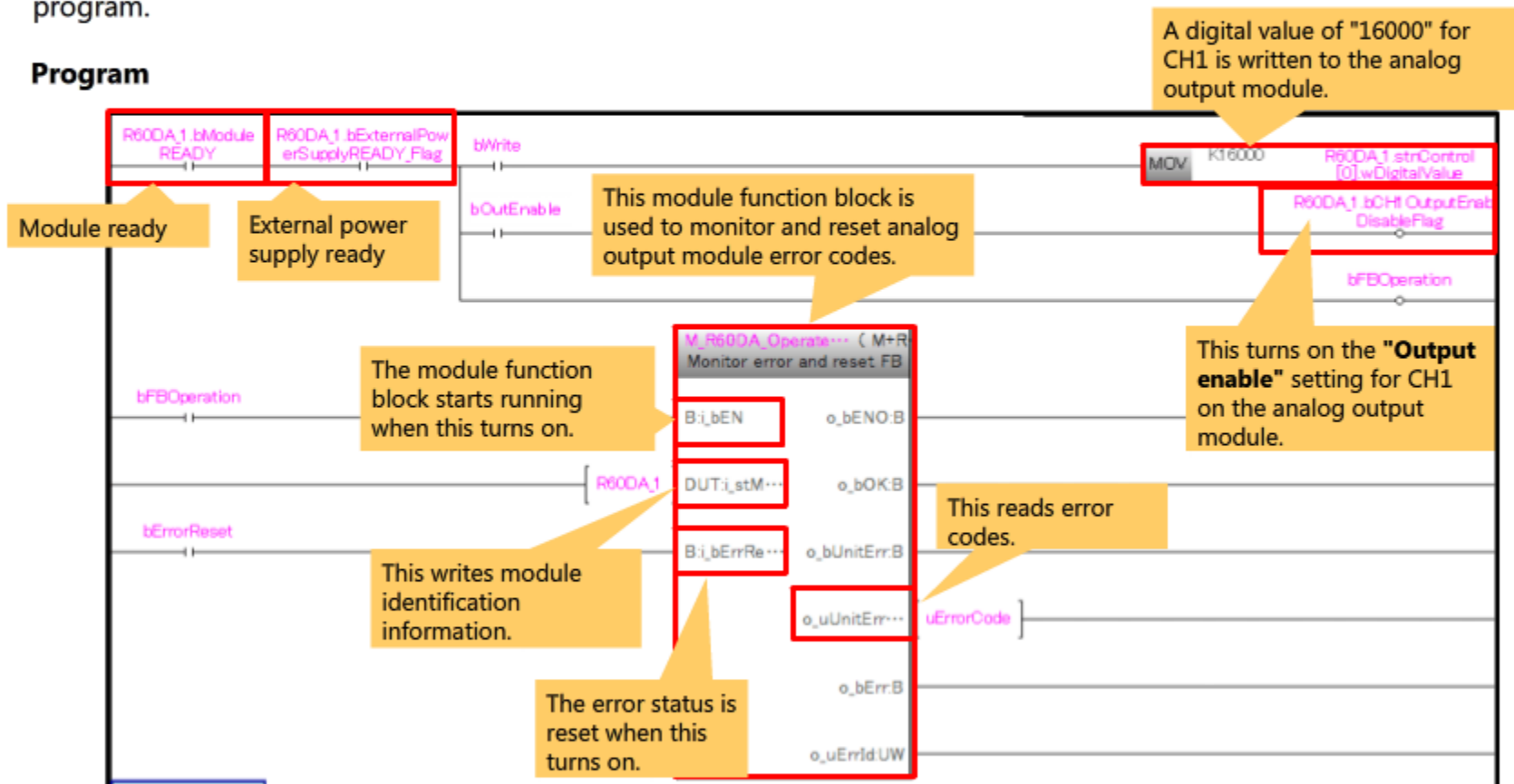

For more information on the module function blocks, refer to the e-Learning courses "GX Works3 (Ladder)" or the "Efficient Programming".

This course covers the method of accessing the intelligent function module using module labels. Programs that explicitly specify buffer memory addresses can also be used. For details, refer to the e-Learning course "Intelligent Function Module" for MELSEC-Q/L Series or the manual for the intelligent function module used.

The contents of this chapter are:

- Addition of an intelligent function module
- Initial settings for the intelligent function module
- Auto refresh settings

Important points to consider:

Addition of module	<ul style="list-style-type: none">• Module configuration diagrams are configured with the intelligent function module before module parameters can be set• Once the module is placed onto the diagram, module parameters and module labels are added. The module parameters set the module operation and the module labels represent setting values and the module signals corresponding to the module slot position.
Module parameter setting	<ul style="list-style-type: none">• Module parameters are used to configure the intelligent function module initial settings and the refresh settings used to determine the transfer destination of control data• Engineering software provides easy-to-understand descriptions of module parameter settings
Auto refresh	Auto refresh automatically transfers programmable controller CPU module labels and intelligent function module data.
I/O signal access	I/O signals can be accessed using module labels.
Control data access	Control data can be accessed using module labels and module function blocks.

Chapter 3 Identifying errors and troubleshooting

This chapter describes the procedures to check the errors that occur during startup and operation.

- 3.1 Procedures for checking errors
- 3.2 Checking errors using the system monitor
- 3.3 Checking errors using the intelligent function module monitor

3.1 Procedures for checking errors

When an error occurs during system startup or operation, use the monitor function in engineering software to identify the cause and resolve the error. This course covers the MELSOFT GX Works3 system monitor and the intelligent function module monitor.

System monitor	The system monitor enables you to monitor the entire programmable controller system and to check the following: <ul style="list-style-type: none">• Slot position of the module where the error has occurred• Error status of each module• Troubleshooting procedure for the error
Intelligent function module monitor	This function enables you to monitor the status of individual intelligent function modules, including the following: <ul style="list-style-type: none">• Current values of I/O signals, setting data, control data, and error codes

■ Check procedure using the monitor function

1. Use the system monitor to identify the intelligent function module where the error has occurred
2. Check the error details and troubleshooting procedure.
Use the intelligent function module monitor to check the current values of I/O signals, setting data, and control data for identifying the error cause.
3. Perform the troubleshooting procedure that appears in the system monitor

3.2 Checking errors using the system monitor

The system monitor enables you to monitor the module configuration and errors for the entire programmable controller system.

The base unit configuration of the system appears here.

The module configuration for each base/extended base unit and information for each module appear here.

System Monitor Main (R35B)

Module Find Target Find

Operation Status No. 1 No. 2 No. 3
RUN - -

Double-click the module column to view detailed information on the module status. (Refer to Section 3.2.1.)

Corresponding icons and error numbers appear here when an error has occurred.

	Power Supply	CPU	I/O0	I/			
Start I/O No.	-	3E00	0000	0010	0020	0030	0040
Points	-	-	16 Point	16 Point	16 Point	16 Point	16 Point
Module Name	R61P	R16CPU	R60DA4				
Error Status	-	-	⚠ 1862				
Module Configuration							
Control CPU	-	-	-	-	-	-	-
Network Information	-	-	-	-	-	-	-

Stop Monitoring

Product Information List... Event History... Create File... Error Status Legend

- ⚠ Major
- ⚠ Moderate
- ⚠ Minor
- 🔴 Unit/Base Access Error

Close

System monitor window

3.2.1

Checking errors using the module diagnostics

The module diagnostics enables you to check the module status and error information.

Module Diagnostics(Start I/O No. 0080)

Module Name: R60DA4
Production information: 0101192550210121

Supplementary Function: [Dropdown]
Execute [Button] Stop Monitoring [Button]

Monitoring [Green Button]

Error Information | Module Information List

No.	Occurrence Date	Status	Error Code	Overview
1	2016/11/24 16:32:54.656		1862	Model mismatch error at OGSTOR execution

Recent error and error history information appears here.

An icon that represents the severity of errors appears.

Legend: Major Moderate Minor

Error Jump [Button]
Event History [Button]
Clear Error [Button]

Error details and troubleshooting procedures for the error code selected in the Error Information list appear here.

Detailed Information	-	-	-
Cause	The G(P).OGSTOR instruction is executed for a model different from the one to which the G(P).OGLOAD instruction is executed or the (P).OGSTOR instruction is executed before the G(P).OGLOAD instruction.		
Corrective Action	Execute the G(P).OGLOAD and G(P).OGSTOR instructions on the same module. As the other way, execute the G(P).OGLOAD instruction on the module whose data is to be restored, and then execute the G(P).OGSTOR instruction on the module to which the data is restored.		

Create File... [Button] Close [Button]

Module diagnostics window

3.3 Checking errors using the intelligent function module monitor

This monitor is used to check the current values of I/O signals, setting data, and control data for each intelligent function module.

I/O signals, setting data, and control data usable by the target module

Module model name and start I/O number

The current value of parameters
 • Bit (ON/OFF)
 • Word

Input/output device numbers assigned to parameters and memory addresses of setting and control data

Data type for parameters

The screenshot shows the 'Intelligent Function Module Monitor 1(0000:R60DA4)[Watching]' window. It contains a table with the following columns: Name, Current Value, Assign (Device/Label), and Data Type. A 'Detailed Display' dialog box is open over the table, showing error details for code H1862.

Name	Current Value	Assign (Device/Label)	Data Type
I/O Signal Monitor			
Input Signal(X):			
Module READY	ON	X0	Bit
External Power Supply READY Flag	OFF	X7	Bit
Operating Condition Setting Completed Flag	ON	X9	Bit
Offset/Gain Setting Mode Status Flag			Bit
Channel Change Completed Flag			Bit
Setting Value Change Completed Flag			Bit
Disconnect Detection Signal			Bit
Alarm Output Signal			Bit
Error Occur Flag			Bit
Output Signal(Y):			
Buffer Memory Monitor			
Latest Error Code...			Word [Unsigned]/Bit String [16-bit]
Latest Alarm Code...			Word [Unsigned]/Bit String [16-bit]
Range Setting Monitor			
CH1 Range Setting Monitor	4 to 20mA	U0WG830	Word [Unsigned]/Bit String [16-bit]
CH2 Range Setting Monitor			Word [Unsigned]/Bit String [16-bit]
CH3 Range Setting Monitor			Word [Unsigned]/Bit String [16-bit]
CH4 Range Setting Monitor	4 to 20mA	U0WG1030	Word [Unsigned]/Bit String [16-bit]
Digital Value			
CH1 Digital Value	0	U0WG460	Word [Signed]
CH2 Digital Value	0	U0WG660	Word [Signed]

Detailed Display

Code: H1862

Content: The G(P).OGLSTOR instruction is executed for a model different from the one to which the G(P).OGLLOAD instruction is executed or the (P).OGLSTOR instruction is executed before the G(P).OGLLOAD instruction.

Message: Execute the G(P).OGLLOAD and G(P).OGLSTOR instructions on the same module. As the other way, execute the G(P).OGLLOAD instruction on the module whose data is to be restored, and then execute the G(P).OGLSTOR instruction on the module to which the data is restored.

Close

Details such as error codes appear in a separate window.

Detail Dialog
 Detail Dialog

Intelligent function module monitor window

The contents of this chapter are:

- Procedures for checking errors
- Checking errors using the system monitor
- Checking errors using the intelligent function module monitor

Important points to consider:

Error check	When an error occurs during system startup or operation, use the monitor function in engineering software to identify the cause and resolve the error.
System monitor	The system monitor enables you to monitor the entire programmable controller system and to check the following: <ul style="list-style-type: none">• Slot position of the module where the error has occurred• Error status of each module• Troubleshooting procedure for the error
Intelligent function module monitor	This function enables you to monitor the status of individual intelligent function modules, including the following: <ul style="list-style-type: none">• Current values of I/O signals, setting data, control data, and error codes

Test Final Test

Now that you have completed all of the lessons of the **Intelligent Function Module (MELSEC iQ-R Series)** course, you are ready to take the final test. If you are unclear on any of the topics covered, please take this opportunity to review those topics.

There are a total of 5 questions (9 items) in this Final Test.

You can take the final test as many times as you like.

How to score the test

After selecting the answer, make sure to click the **Answer** button. Your answer will be lost if you proceed without clicking the Answer button. (Regarded as unanswered question.)

Score results

The number of correct answers, the number of questions, the percentage of correct answers, and the pass/fail result will appear on the score page.

Correct answers : 5

Total questions : 5

Percentage : 100%

To pass the test, you have to answer **60%** of the questions correct.

Proceed

Review

- Click the **Proceed** button to exit the test.
- Click the **Review** button to review the test. (Correct answer check)
- Click the **Retry** button to retake the test again.

Test

Final Test 1



Overview of the intelligent function module
Select the correct description about the intelligent function module.

- This module functions as the brain of a programmable controller system to control the entire system through the use of engineering software to write control specifications.
- This module extends the functionality of programmable controllers, such as analog input/output, positioning, and communications connectivity for I/O modules that control input/output.
- This module supplies power to other modules.

Back

✓ Select the correct description about the input/output signal functionality of the intelligent function module.

- Receives sensor status information and drives actuators.
- ✓ Exchanges module requests and module status information.

Back

Test

Final Test 3



- Select the terms that correctly completes the following description of setting and control data exchanges with the intelligent function module.

[Q1], which is used to control the intelligent function module, are exchanged using word data. Word data represents commands sent from the [Q2] to the [Q3] and corresponding responses sent from the [Q3] to the [Q2]. Methods of performing word data communications include the [Q4] configured in engineering software and programs that contain [Q5].

Q1



Q2



Q3



Q4



Q5



✓ Select the correct description about the process of accessing the intelligent function module with programs.

- By using module labels and module function blocks, programs can be created without having to worry about of I/O numbers and memory addresses.
- Device number configurations must be planned during the design phase to avoid conflicts.

Back

✔ Select the correct description about the monitor function in engineering software.

- Displays status information on intelligent function modules and troubleshooting procedures for errors that have occurred to help restore systems quickly and easily.
- Intelligent function module errors are automatically resolved when detected.

Back

Test**Test Score**

You have completed the Final Test. Your results are as follows.
To end the Final Test, proceed to the next page.

Correct answers : **5**

Total questions : **5**

Percentage : **100%**

Congratulations. You passed the test.

You have completed the **Intelligent Function Module (MELSEC iQ-R Series)** course.

Thank you for taking this course.

We hope you enjoyed the lessons and the information you acquired in this course will be useful in the future.

You can review the course as many times as you want.

Review

Close