

< Silicon RF Power MOS FET (Discrete) >

RD10HMS2

RoHS Compliance, Silicon MOSFET Power Transistor, 870MHz, 10W, 12.5V

DESCRIPTION

RD10HMS2 is a MOS FET type transistor specifically designed for 870MHz RF power amplifiers applications.

FEATURES

- High power gain and High Efficiency
 $P_{out}=11W$ typ, Drain Effi. =65% typ
 @ $V_{DS}=12.5V$, $I_{dq}=0.3A$, $P_{in}=0.6W$, $f=870MHz$
- Integrated gate protection diode

APPLICATION

For output stage of high power amplifiers in 800MHz-band mobile radio sets

RoHS COMPLIANT

RD10HMS2 is EU RoHS compliant.

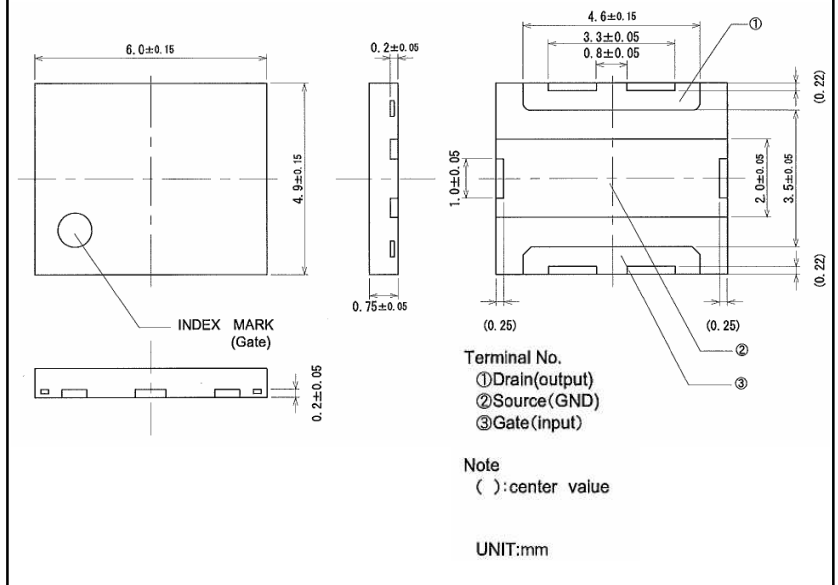
OUTLINEDRAWING

ABSOLUTE MAXIMUM RATINGS (T_{case}= +25°C, Z_g=Z_l=50Ω UNLESS OTHERWISE NOTED)

SYMBOL	PARAMETER	CONDITIONS	RATINGS	UNIT
V _{DSS}	Drain to source voltage	V _{GS} =0V	40	V
V _{GSS}	Gate to source voltage	V _{DS} =0V	-5/+10	V
P _{ch} *	Channel dissipation	-	50	W
P _{in}	Input Power	-	1.2	W
I _D	Drain Current	-	3.0	A
T _{ch}	Junction Temperature	-	150	°C
T _{stg}	Storage temperature	-	-40 to +125	°C

Note: Above parameters are guaranteed independently.

* Theoretical value in case of mounted on infinite heat sink

ELECTRICAL CHARACTERISTICS (T_{case}= +25°C, Z_g=Z_l=50Ω UNLESS OTHERWISE NOTED)

SYMBOL	PARAMETER	CONDITIONS	LIMITS			UNIT
			MIN	TYP	MAX.	
I _{DSS}	Zero Gate Voltage Drain Current	V _{DS} =37V, V _{GS} =0V	-	-	20	μA
I _{GSS}	Gate to Source Leak Current	V _{GS} =10V, V _{DS} =0V	-	-	2.5	μA
V _{th}	Gate threshold Voltage	V _{DS} =12V, I _{DS} =1mA	1.7	-	2.7	V
P _{out}	Output power	f=870MHz, V _{DD} =12.5V	10	11	-	W
η _D	Drain efficiency	P _{in} =0.6W, I _{dq} =0.3A	60	65	-	%
VSWR*	Load VSWR Tolerance	f=870MHz, V _{DD} =15.2V I _{dq} =0.3A, P _{out} =10W(P _{in} Control) Load VSWR=20:1(All Phase)	No destroy			-

Note: Above parameters, ratings, limits and conditions are subject to change.

* Random sampling (22 pcs/ Lot)

TEMPERATURE CHARACTERISTICS (T_{case}= +25°C UNLESS OTHERWISE NOTED)

SYMBOL	PARAMETER	CONDITIONS	LIMITS			UNIT
			MIN	TYP	MAX	
R _{th(j-c)}	Thermal Resistance	Junction to Case	-	1.4	2.5	°C/W

* Random sampling (22 pcs/ Lot)

RD10HMS2

RoHS Compliance, Silicon MOSFET Power Transistor, 870MHz, 10W

TYPICAL CHARACTERISTICS

(These are only typical curves and devices are not necessarily guaranteed at these curves.)

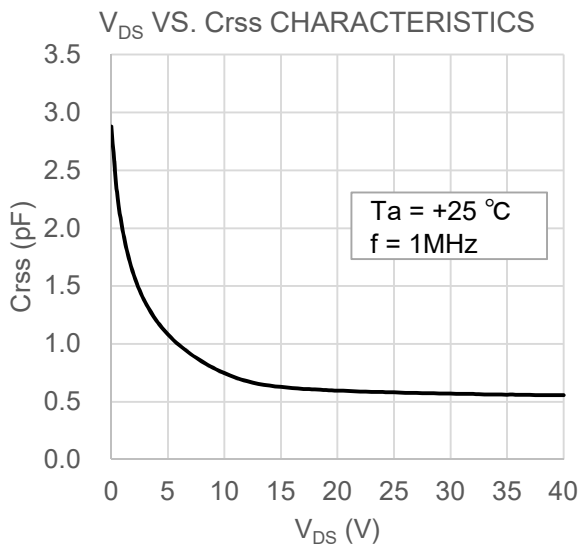
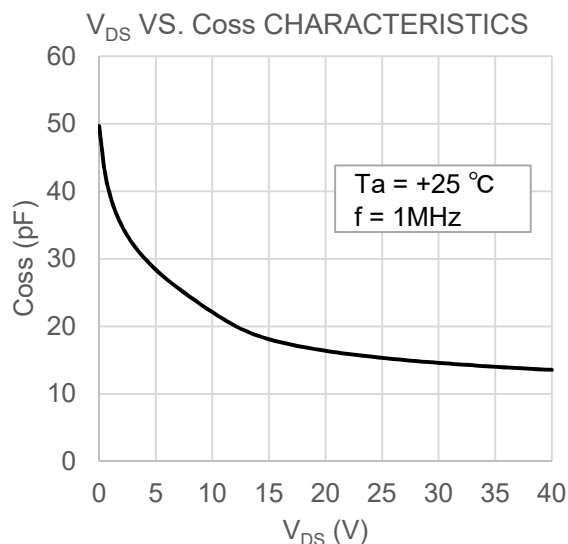
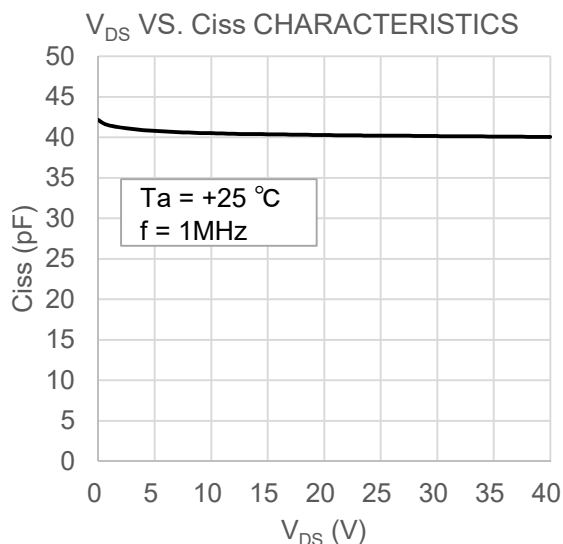
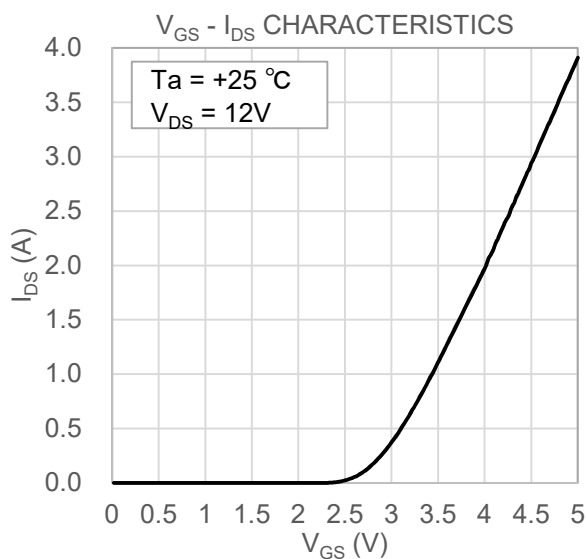
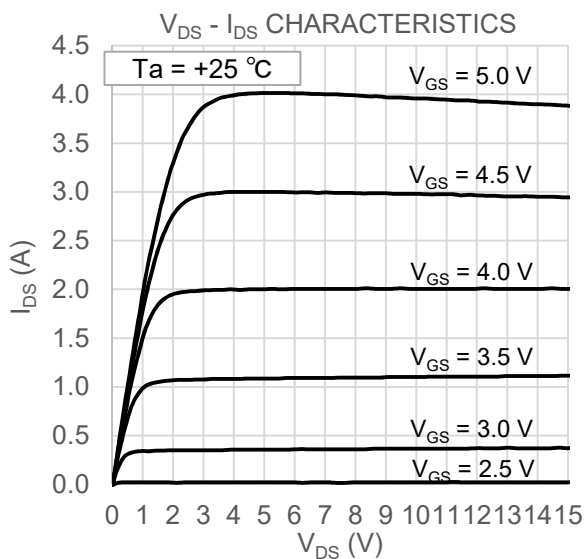

RD10HMS2

RoHS Compliance, Silicon MOSFET Power Transistor, 870MHz, 10W

TYPICAL CHARACTERISTICS (f=764-870MHz, Ta=+25°C)

(These are only typical curves and devices are not necessarily guaranteed at these curves.)

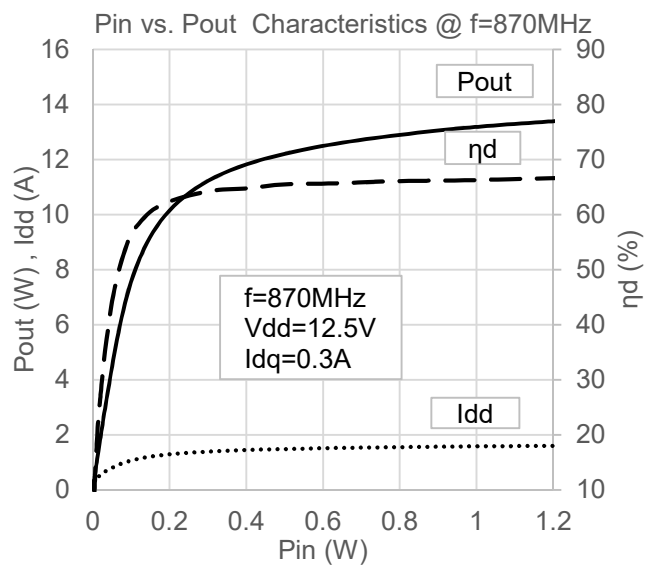
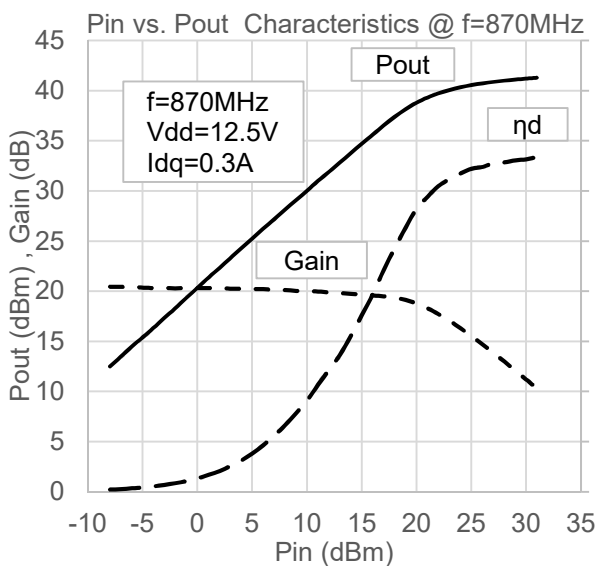
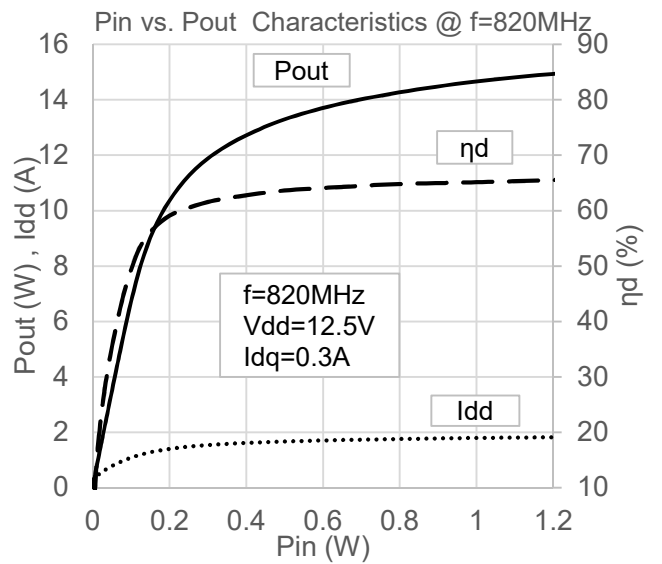
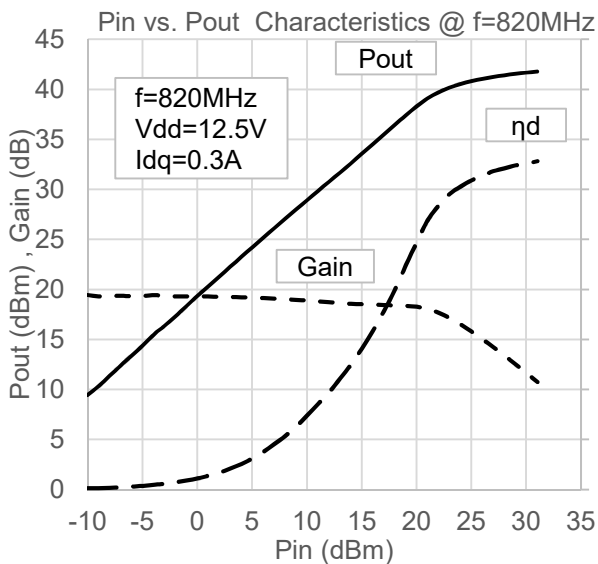
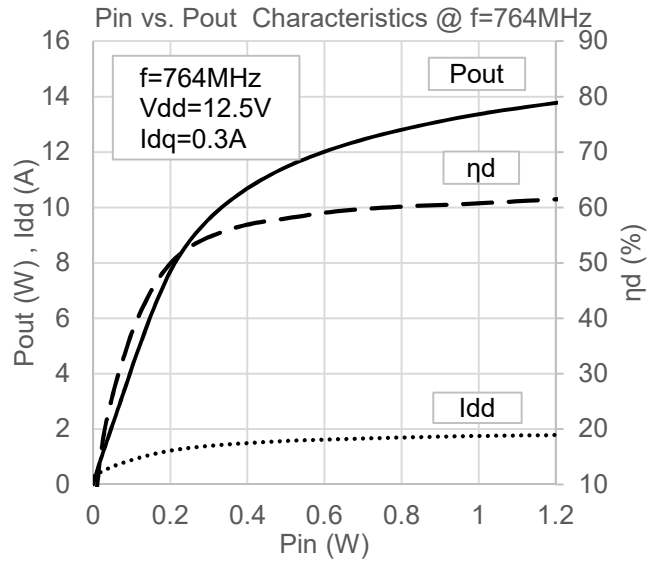
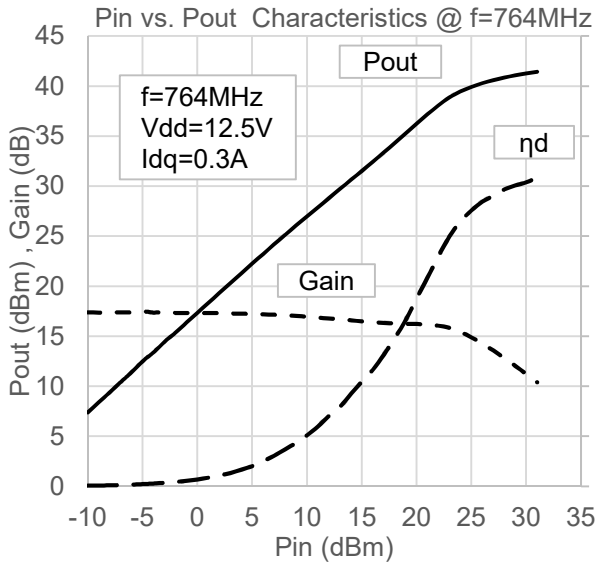

RD10HMS2

RoHS Compliance, Silicon MOSFET Power Transistor, 870MHz, 10W

TYPICAL CHARACTERISTICS (f=764-870MHz, Ta=+25°C)

(These are only typical curves and devices are not necessarily guaranteed at these curves.)

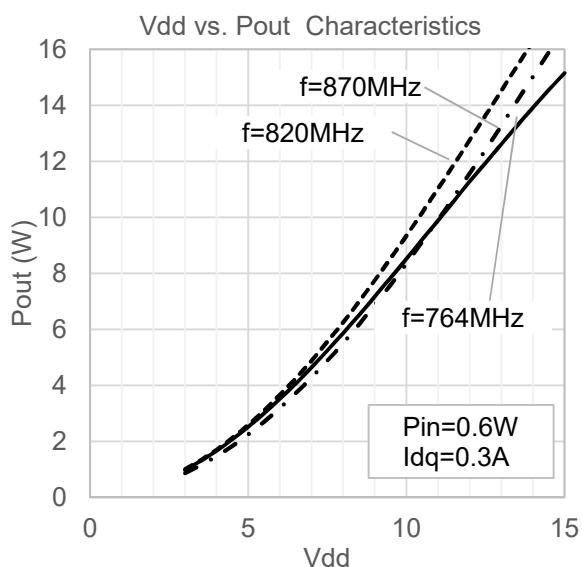
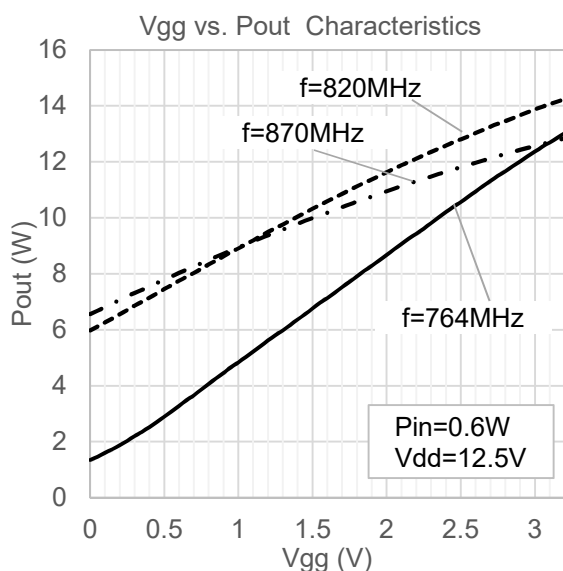
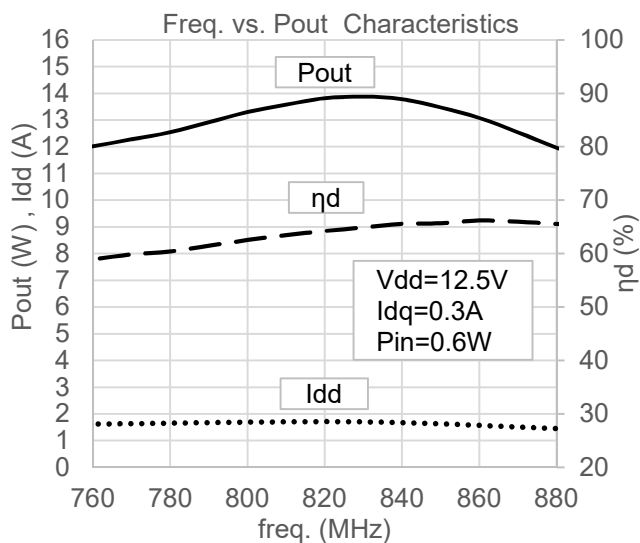

RD10HMS2

RoHS Compliance, Silicon MOSFET Power Transistor, 870MHz, 10W

EQUIVALENT CIRCUITRY (f = 764 – 870 MHz)

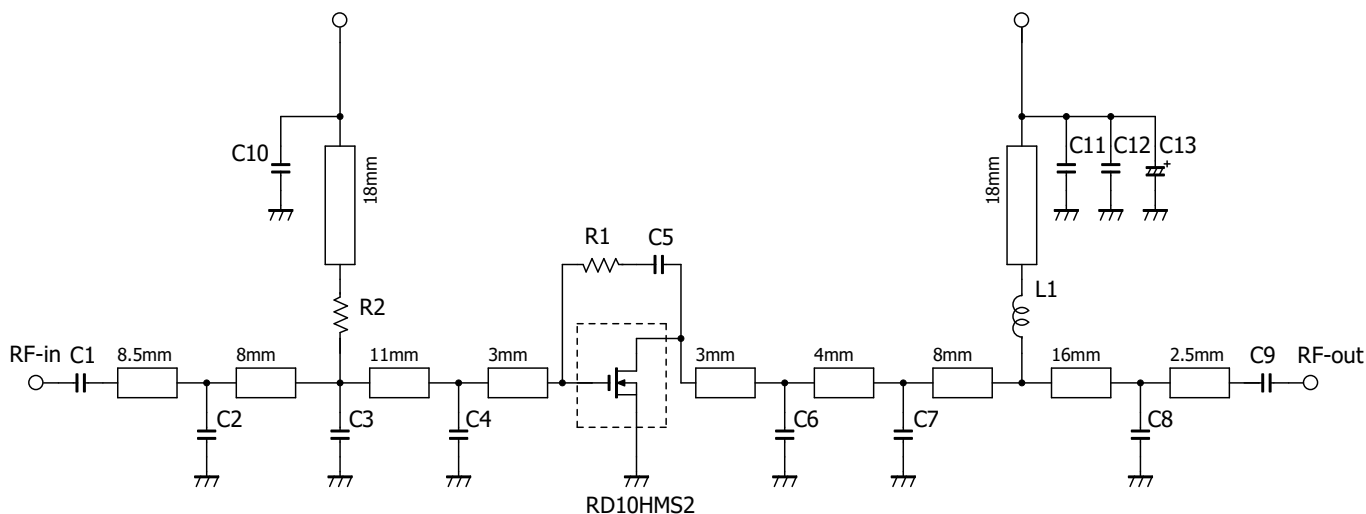

Note : Board material Glass-Epoxy substrate $\epsilon_r = 4.8$, $t = 0.8\text{mm}$

Micro strip line width=1.3mm

Component List

No.	Description			P/N	Manufacturer
	Capacitance	Size	Remarks		
C1	100pF	1608	Hi-Q 250V	GQM1875C2E101JB12D	MURATA MANUFACTURING CO.
C2	1.0pF	1608	Hi-Q 250V	GQM1875C2E1R0CB12D	MURATA MANUFACTURING CO.
C3	3.6pF	1608	Hi-Q 250V	GQM1875C2E3R6CB12D	MURATA MANUFACTURING CO.
C4	22pF	1608	Hi-Q 250V	GQM1872C2E220JB12D	MURATA MANUFACTURING CO.
C5	47pF	1608	50V	GRM1882C1H470JA01	MURATA MANUFACTURING CO.
C6	3.6pF	1608	Hi-Q 250V	GQM1875C2E3R6CB12D	MURATA MANUFACTURING CO.
C7	13pF	1608	Hi-Q 250V	GQM1872C2E130JB12D	MURATA MANUFACTURING CO.
C8	3.6pF	1608	Hi-Q 250V	GQM1875C2E3R6CB12D	MURATA MANUFACTURING CO.
C9	100pF	1608	Hi-Q 250V	GQM1875C2E101JB12D	MURATA MANUFACTURING CO.
C10	1000pF	1608	50V	GRM1882C1H102JA01	MURATA MANUFACTURING CO.
C11	1000pF	1608	50V	GRM1882C1H102JA01	MURATA MANUFACTURING CO.
C12	22000pF	2012	50V	GRM216B11H223KA01	MURATA MANUFACTURING CO.
C13	220 μ F	-	35V	EEUFC1V221	Panasonic Corporation

* Inductor of Rolling Coil measurement condition : f=100MHz

No.	Description	Inductance			P/N	Manufacturer	Remarks	
		Diameter	Wire Φ					
			Inside Φ	T/N of coils				
L	1	29 nH *	0.4 mm	2.46 mm	6	4006C	YC Corporation Co.,Ltd.	Enameled wire

No.	Description		P/N	Manufacturer	
	Resistance	Size			
R	1	470 Ω	1608	RPC05T471J	TAIYOSHA ELECTRIC CO.
R	2	4700 Ω	1608	RPC05T472J	TAIYOSHA ELECTRIC CO.

RD10HMS2

RoHS Compliance, Silicon MOSFET Power Transistor, 870MHz, 10W

input / Output Impedance VS. Frequency Characteristics for f=764-870MHz

Method of Measurement

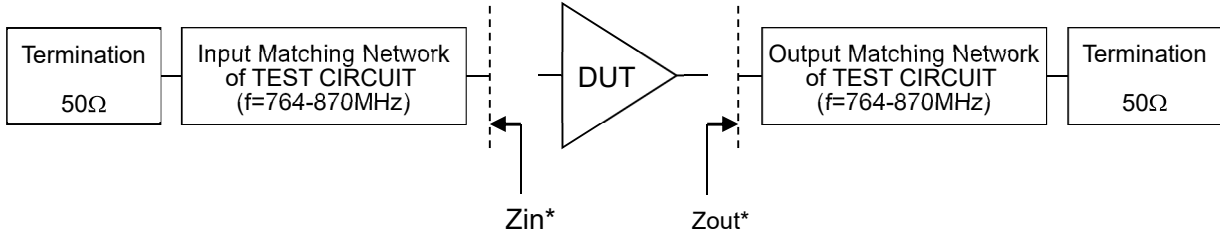

Z_{in}^* : Input Matching Network impedance measured from DUT

Z_{out}^* : Output Matching Network impedance measured from DUT

Z_0 : Characteristic impedance

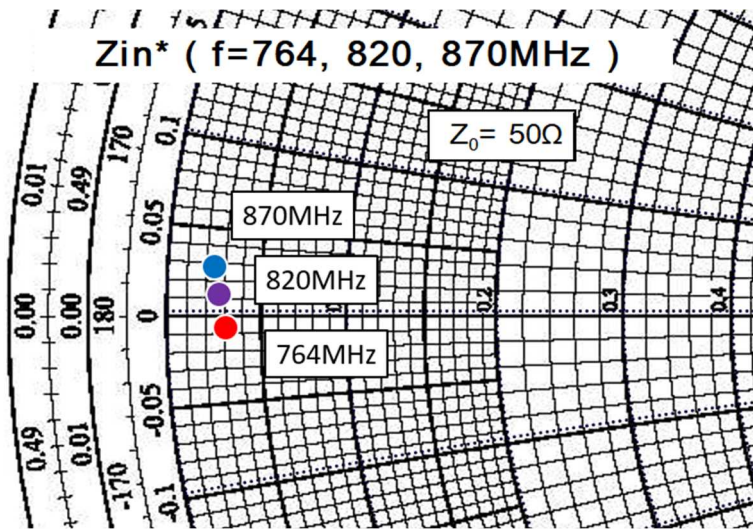

f (MHz)	Z_{in}^* (Ω)
764	1.55 - j 0.49
820	1.37 + j 0.48
870	1.22 + j 1.24

Z_{in}^* : Complex conjugate of input impedance

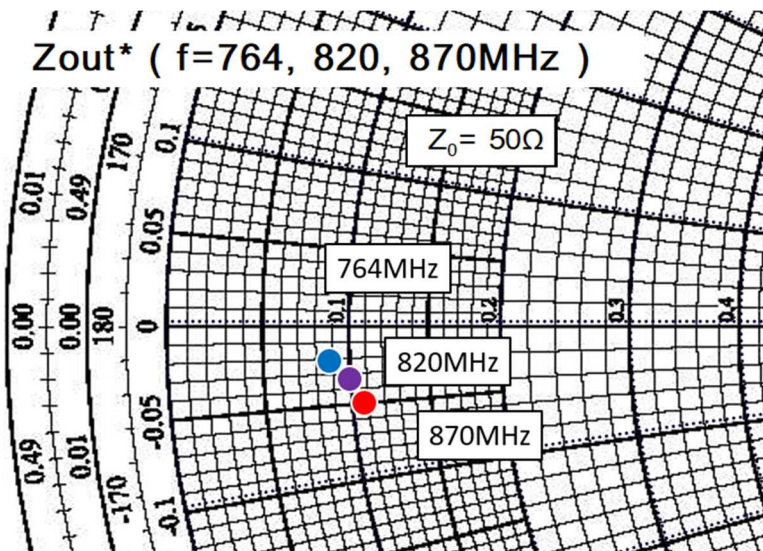

f (MHz)	Z_{out}^* (Ω)
764	5.37 - j 2.67
820	4.98 - j 1.89
870	4.41 - j 1.26

Z_{out}^* : Complex conjugate of output impedance

RD10HMS2

RoHS Compliance, Silicon MOSFET Power Transistor, 870MHz, 10W

S-Parameter data (Vdd=12.5V, Id=300mA)

(MHz)	S11		S21		S12		S22	
	(mag)	(ang)	(mag)	(ang)	(mag)	(ang)	(mag)	(ang)
100	0.84	-130	34.08	94	0.013	5	0.60	-94
150	0.84	-143	22.23	78	0.013	-9	0.62	-110
200	0.86	-151	15.80	67	0.012	-19	0.67	-120
250	0.88	-156	11.84	58	0.011	-27	0.72	-128
300	0.89	-160	9.20	51	0.010	-32	0.76	-134
350	0.91	-163	7.34	45	0.009	-37	0.80	-139
400	0.92	-165	5.97	39	0.008	-41	0.83	-144
450	0.93	-167	4.94	35	0.007	-44	0.85	-148
500	0.94	-169	4.15	31	0.006	-46	0.87	-151
550	0.94	-171	3.53	27	0.005	-46	0.88	-154
600	0.95	-172	3.04	24	0.004	-47	0.90	-156
650	0.95	-173	2.64	21	0.003	-44	0.91	-158
700	0.96	-175	2.32	19	0.003	-40	0.92	-161
750	0.96	-176	2.05	16	0.002	-33	0.93	-162
760	0.96	-176	2.00	16	0.002	-32	0.93	-163
770	0.96	-176	1.96	16	0.002	-30	0.93	-163
780	0.97	-177	1.91	15	0.002	-26	0.93	-164
790	0.97	-177	1.87	15	0.002	-22	0.94	-164
800	0.97	-177	1.83	14	0.002	-20	0.94	-164
810	0.97	-177	1.79	14	0.002	-16	0.94	-165
820	0.97	-177	1.75	13	0.001	-11	0.94	-165
830	0.97	-178	1.71	13	0.001	-10	0.94	-165
840	0.97	-178	1.68	13	0.001	-2	0.94	-166
850	0.97	-178	1.64	12	0.001	0	0.94	-166
860	0.97	-178	1.61	12	0.001	7	0.94	-166
870	0.97	-178	1.57	11	0.001	12	0.95	-166
880	0.97	-178	1.54	11	0.001	15	0.95	-167
890	0.97	-179	1.51	11	0.001	19	0.95	-167
900	0.97	-179	1.48	10	0.001	28	0.95	-167
910	0.97	-179	1.45	10	0.001	33	0.95	-168
920	0.97	-179	1.42	10	0.001	35	0.95	-168
930	0.97	-179	1.40	9	0.001	41	0.95	-168
940	0.97	-180	1.37	9	0.001	43	0.95	-168
950	0.97	-180	1.34	9	0.002	49	0.95	-169
1000	0.98	179	1.22	7	0.002	59	0.96	-170
1050	0.98	179	1.12	5	0.002	67	0.96	-171
1100	0.98	178	1.03	4	0.003	71	0.96	-173
1150	0.98	177	0.95	2	0.003	73	0.97	-174
1200	0.98	176	0.88	1	0.004	75	0.97	-175
1250	0.98	176	0.82	-1	0.004	75	0.97	-176
1300	0.98	175	0.76	-2	0.005	76	0.97	-177
1350	0.98	174	0.71	-3	0.005	76	0.97	-178
1400	0.98	173	0.67	-4	0.005	76	0.97	-179
1450	0.98	172	0.62	-6	0.006	77	0.97	-180
1500	0.98	172	0.59	-7	0.006	76	0.98	179
1550	0.98	171	0.55	-8	0.007	76	0.98	178
1600	0.98	170	0.52	-9	0.007	75	0.98	177
1650	0.98	169	0.49	-10	0.008	75	0.98	176
1700	0.98	169	0.47	-12	0.008	75	0.98	175
1750	0.98	168	0.44	-13	0.008	74	0.98	174
1800	0.98	167	0.42	-14	0.009	73	0.98	174
1850	0.98	167	0.40	-15	0.009	72	0.98	173
1900	0.98	166	0.38	-16	0.010	71	0.97	172
1950	0.98	165	0.36	-17	0.010	70	0.97	171
2000	0.98	164	0.35	-18	0.010	69	0.97	170

RD10HMS2

RoHS Compliance, Silicon MOSFET Power Transistor, 870MHz, 10W

ATTENTION:

- 1.High Temperature ; This product might have a heat generation while operation,Please take notice that have a possibility to receive a burn to touch the operating product directly or touch the product until cold after switch off. At the near the product,do not place the combustible material that have possibilities to arise the fire
- 2.Generation of High Frequency Power ; This product generate a high frequency power. Please take notice that do not leakage the unnecessary electric wave and use this products without cause damage for human and property per normal operation.
- 3.Before use; Before use the product,Please design the equipment in consideration of the risk for human and electric wave obstacle for equipment.

PRECAUTIONS FOR THE USE OF MITSUBISHI SILICON RF POWER DEVICES:

1. The specifications of mention are not guarantee values in this data sheet. Please confirm additional details regarding operation of these products from the formal specification sheet. For copies of the formal specification sheets, please contact one of our sales offices.
- 2.RA series products (RF power amplifier modules) and RD series products (RF power transistors) are designed for consumer mobile communication terminals and were not specifically designed for use in other applications.
In particular, while these products are highly reliable for their designed purpose, they are not manufactured under a quality assurance testing protocol that is sufficient to guarantee the level of reliability typically deemed necessary for critical communications elements and In the application, which is base station applications and fixed station applications that operate with long term continuous transmission and a higher on-off frequency during transmitting, please consider the derating, the redundancy system, appropriate setting of the maintain period and others as needed. For the reliability report which is described about predicted operating life time of Mitsubishi Silicon RF Products , please contact Mitsubishi Electric Corporation or an authorized Mitsubishi Semiconductor product distributor.
3. RD series products use MOSFET semiconductor technology. They are sensitive to ESD voltage therefore appropriate ESD precautions are required.
4. In the case of use in below than recommended frequency, there is possibility to occur that the device is deteriorated or destroyed due to the RF-swing exceed the breakdown voltage.
5. In order to maximize reliability of the equipment, it is better to keep the devices temperature low. It is recommended to utilize a sufficient sized heat-sink in conjunction with other cooling methods as needed (fan, etc.) to keep the channel temperature for RD series products lower than 120deg/C(in case of Tchmax=150deg/C) ,140deg/C(in case of Tchmax=175deg/C) under standard conditions.
6. Do not use the device at the exceeded the maximum rating condition. In case of plastic molded devices, the exceeded maximum rating condition may cause blowout, smoldering or catch fire of the molding resin due to extreme short current flow between the drain and the source of the device. These results causes in fire or injury.
7. For specific precautions regarding assembly of these products into the equipment, please refer to the supplementary items in the specification sheet.
8. Warranty for the product is void if the products protective cap (lid) is removed or if the product is modified in any way from it's original form.
9. For additional "Safety first" in your circuit design and notes regarding the materials, please refer the last page of this data sheet.

RD10HMS2

RoHS Compliance, Silicon MOSFET Power Transistor, 870MHz, 10W

10. Please avoid use in the place where water or organic solvents can adhere directly to the product and the environments with the possibility of caustic gas, dust, salinity, etc. Reliability could be markedly decreased and also there is a possibility failures could result causing a serious accident. Likewise, there is a possibility of causing a serious accident if used in an explosive gas environment. Please allow for adequate safety margin in your designs.

11. Please refer to the additional precautions in the formal specification sheet.

RD10HMS2

RoHS Compliance, Silicon MOSFET Power Transistor, 870MHz, 10W

Keep safety first in your circuit designs!

Mitsubishi Electric Corporation puts the maximum effort into making semiconductor products better and more reliable, but there is always the possibility that trouble may occur with them. Trouble with semiconductors may lead to personal injury, fire or property damage. Remember to give due consideration to safety when making your circuit designs, with appropriate measures such as (i) placement of substitutive, auxiliary circuits, (ii) use of non-flammable material or (iii) prevention against any malfunction or mishap.

Notes regarding these materials

- These materials are intended as a reference to assist our customers in the selection of the Mitsubishi Electric Semiconductor product best suited to the customer's application; they do not convey any license under any intellectual property rights, or any other rights, belonging to Mitsubishi Electric Corporation or a third party.
- Mitsubishi Electric Corporation assumes no responsibility for any damage, or infringement of any third-party's rights, originating in the use of any product data, diagrams, charts, programs, algorithms, or circuit application examples contained in these materials.
- All information contained in these materials, including product data, diagrams, charts, programs and algorithms represents information on products at the time of publication of these materials, and are subject to change by Mitsubishi Electric Corporation without notice due to product improvements or other reasons. It is therefore recommended that customers contact Mitsubishi Electric Corporation or an authorized Mitsubishi Electric Semiconductor product distributor for the latest product information before purchasing a product listed herein.
The information described here may contain technical inaccuracies or typographical errors. Mitsubishi Electric Corporation assumes no responsibility for any damage, liability, or other loss rising from these inaccuracies or errors.
Please also pay attention to information published by Mitsubishi Electric Corporation by various means, including the Mitsubishi Electric Semiconductor home page (<http://www.MitsubishiElectric.com/semiconductor/>).
- When using any or all of the information contained in these materials, including product data, diagrams, charts, programs, and algorithms, please be sure to evaluate all information as a total system before making a final decision on the applicability of the information and products. Mitsubishi Electric Corporation assumes no responsibility for any damage, liability or other loss resulting from the information contained herein.
- Mitsubishi Electric Corporation semiconductors are not designed or manufactured for use in a device or system that is used under circumstances in which human life is potentially at stake. Please contact Mitsubishi Electric Corporation or an authorized Mitsubishi Electric Semiconductor product distributor when considering the use of a product contained herein for any specific purposes, such as apparatus or systems for transportation, vehicular, medical, aerospace, nuclear, or undersea repeater use.
- The prior written approval of Mitsubishi Electric Corporation is necessary to reprint or reproduce in whole or in part these materials.
- If these products or technologies are subject to the Japanese export control restrictions, they must be exported under a license from the Japanese government and cannot be imported into a country other than the approved destination.
Any diversion or re-export contrary to the export control laws and regulations of Japan and/or the country of destination is prohibited.
- Please contact Mitsubishi Electric Corporation or an authorized Mitsubishi Electric Semiconductor product distributor for further details on these materials or the products contained therein.