

< Silicon RF Power MOS FET (Discrete) >

RD32HMP2

RoHS Compliance, Silicon MOSFET Power Transistor, 870MHz, 32W, 12.5V

DESCRIPTION

RD32HMP2 is a MOS FET type transistor specifically designed for 870MHz RF power amplifiers applications.

FEATURES

- Supply with Tape and Reel. 500 Units per Reel
- Utilize Mold Package
- High Power and High Efficiency
 $P_{out}=35W$ typ, Drain Effi.=64% typ
@ $V_{DD}=12.5V$, $I_{DQ}=0.5A$, $P_{in}=5W$, $f=870MHz$
- Integrated gate protection diode

APPLICATION

For output stage of high power amplifiers in 800MHz-band mobile radio sets

RoHS COMPLIANT

RD32HMP2 is EU RoHS compliant.

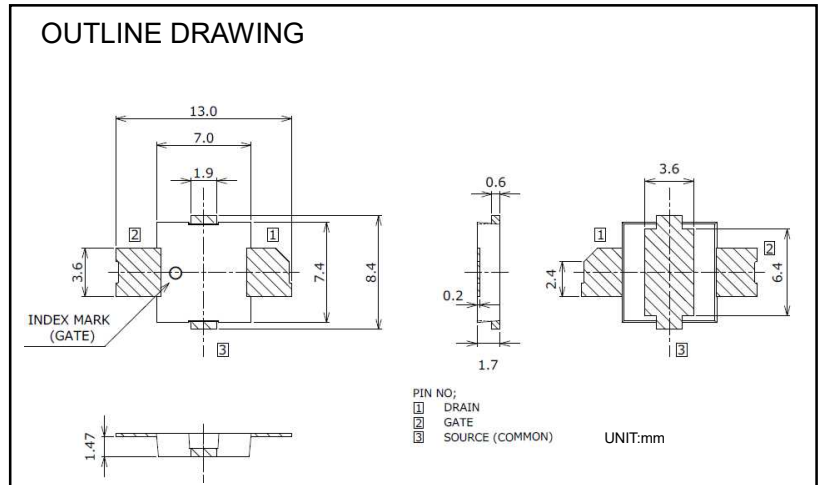

RD32HMP2

RoHS Compliance, Silicon MOSFET Power Transistor, 870MHz, 32W, 12.5V

ABSOLUTE MAXIMUM RATINGS (T_{case}= +25°C, Z_G=Z_L=50Ω UNLESS OTHERWISE NOTED)

SYMBOL	PARAMETER	CONDITIONS	RATINGS	UNIT
V _{DSS}	Drain to Source Voltage	V _{GS} =0V	40	V
V _{GSS}	Gate to Source Voltage	V _{DS} =0V	-5/+10	V
P _{ch} *	Channel Dissipation	T _c =25°C	197	W
P _{in}	Input Power	-	10	W
I _D	Drain Current	-	10	A
T _{ch}	Channel Temperature	-	175	°C
T _{stg}	Storage Temperature	-	-40 to +175	°C

Note: Above parameters are guaranteed independently.

*Theoretical value in case of mounted on infinite heat sink.

ELECTRICAL CHARACTERISTICS (T_{case}= +25°C, Z_G=Z_L=50Ω UNLESS OTHERWISE NOTED)

SYMBOL	PARAMETER	CONDITIONS	LIMITS			UNIT
			MIN	TYP	MAX.	
I _{DSS}	Zero Gate Voltage Drain Current	V _{DS} =37V, V _{GS} =0V	-	-	150	μA
I _{GSS}	Gate to Source Leak Current	V _{GS} =10V, V _{DS} =0V	-	-	2.5	μA
V _{TH}	Gate Threshold Voltage	V _{DS} =12V, I _{DS} =1mA	1.6	2.1	2.6	V
P _{out}	Output Power	f=870MHz, V _{DD} =12.5V	32	35	-	W
η _D	Drain Efficiency	P _{in} =5W, I _{DQ} =0.5A	60	64	-	%
VSWR1 *	Load VSWR Tolerance	Load VSWR=65:1(All Phase), f=870MHz, V _{DD} =16.3V, P _{in} =1.5W(Z _G /Z _L =50Ω), I _{DQ} =0.5A	No destroy			-
VSWR2	Load VSWR Tolerance	Load VSWR=20:1(All Phase) V _{DS} =16.3V in creased after P _{out} adjusted to 32 W(Z _G /Z _L =50Ω) by P _{in} (under 870MHz, V _{DS} =12.5V and I _{DQ} =0.5 A)	No destroy			-

Note: Above parameters, ratings, limits and conditions are subject to change.

* Random sampling (22 pcs/ Lot)

TEMPERATURE CHARACTERISTICS (T_{case}= +25°C UNLESS OTHERWISE NOTED)

SYMBOL	PARAMETER	CONDITIONS	LIMITS			UNIT
			MIN	TYP	MAX	
R _{th(j-c)} *	Thermal Resistance	Junction to Case	-	0.45	0.76	°C /W

* Random sampling (22 pcs/ Lot)

RD32HMP2

RoHS Compliance, Silicon MOSFET Power Transistor, 870MHz, 32W, 12.5V

TYPICAL DC CHARACTERISTICS

(These are only typical curves and devices are not necessarily guaranteed at these curves.)

V_{DS} - I_{DS} CHARACTERISTICS

@ $T_a=+25^\circ\text{C}$

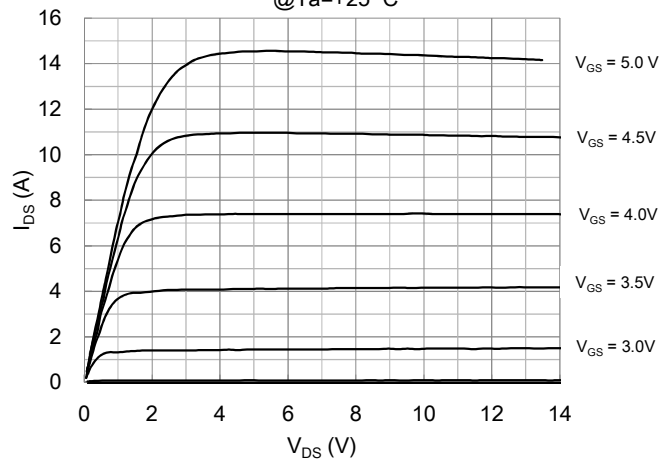

V_{GS} - I_{DS} CHARACTERISTICS

@ $T_a = +25^\circ\text{C}$, $V_{DS} = 12.5\text{ V}$

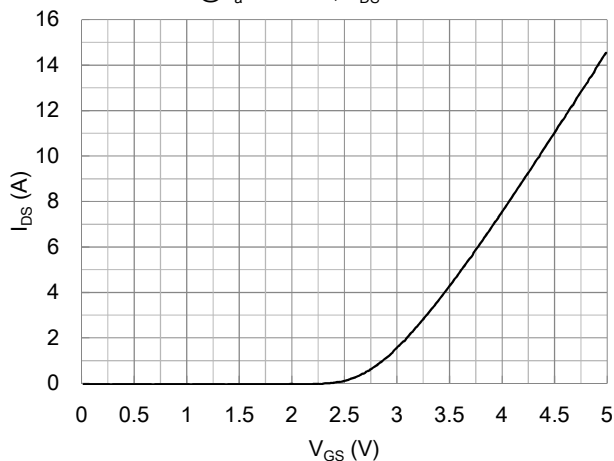

V_{DS} - C_{iss} Characteristics

@ $T_a=+25^\circ\text{C}$, $f=1\text{MHz}$, $V_{GS}=0\text{V}$

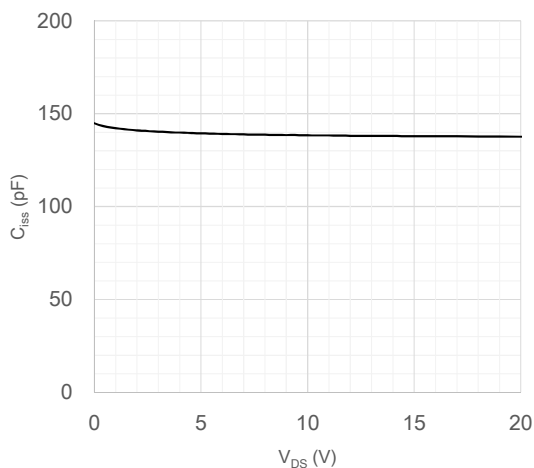

V_{DS} - C_{oss} Characteristics

@ $T_a=+25^\circ\text{C}$, $f=1\text{MHz}$, $V_{GS}=0\text{V}$

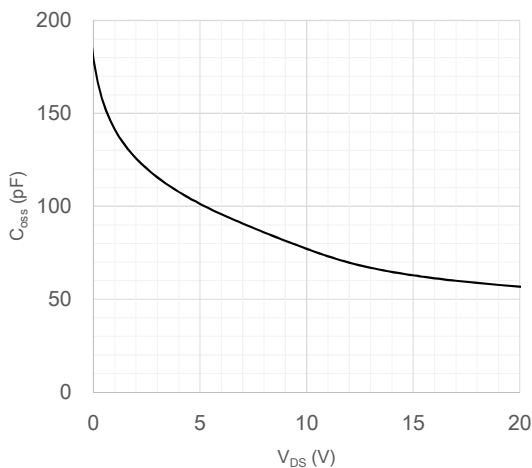

V_{DS} - C_{rss} Characteristics

@ $T_a=+25^\circ\text{C}$, $f=1\text{MHz}$, $V_{GS}=0\text{V}$

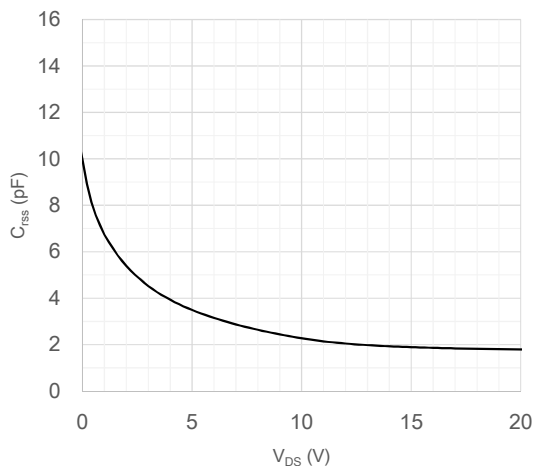

RD32HMP2

RoHS Compliance, Silicon MOSFET Power Transistor, 870MHz, 32W, 12.5V

TYPICAL RF CHARACTERISTICS (Frequency vs P_{out} , η_D)

(These are only typical curves and devices are not necessarily guaranteed at these curves.)

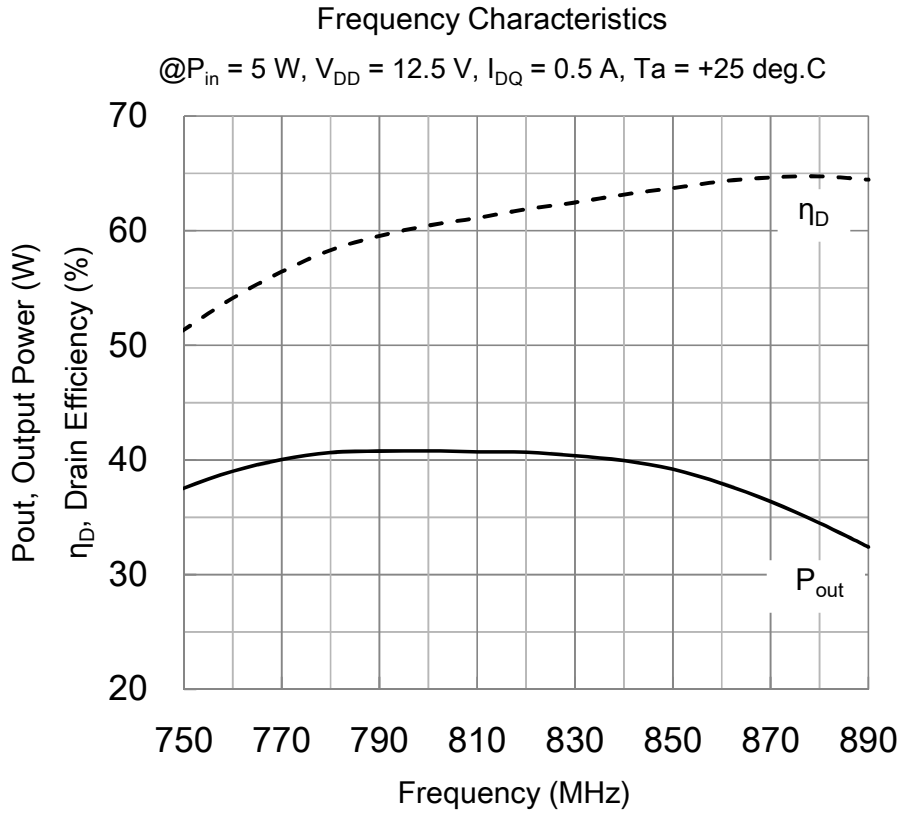

RD32HMP2

RoHS Compliance, Silicon MOSFET Power Transistor, 870MHz, 32W, 12.5V

TYPICAL RF CHARACTERISTICS (P_{in} vs P_{out} , G_p , η_D , I_{DD})

(These are only typical curves and devices are not necessarily guaranteed at these curves.)

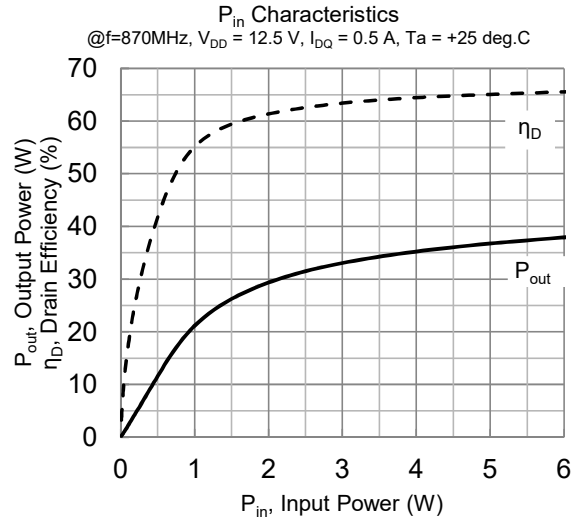
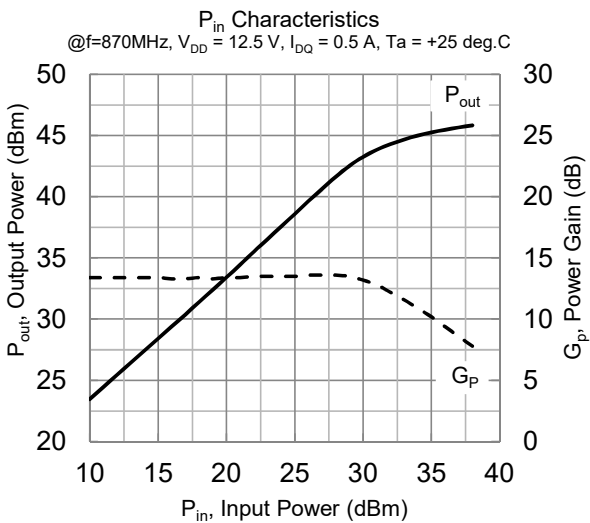
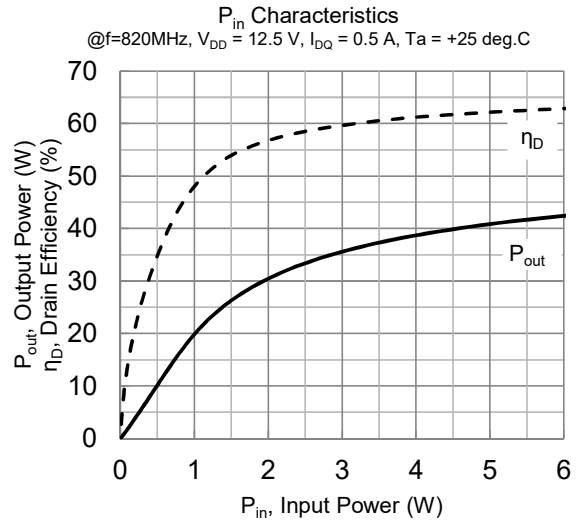
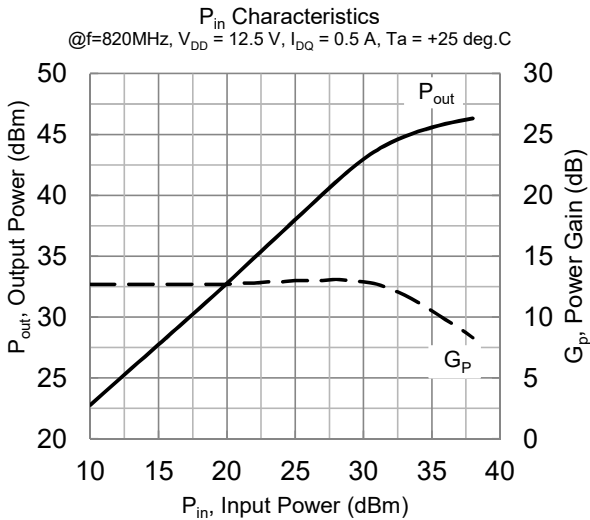
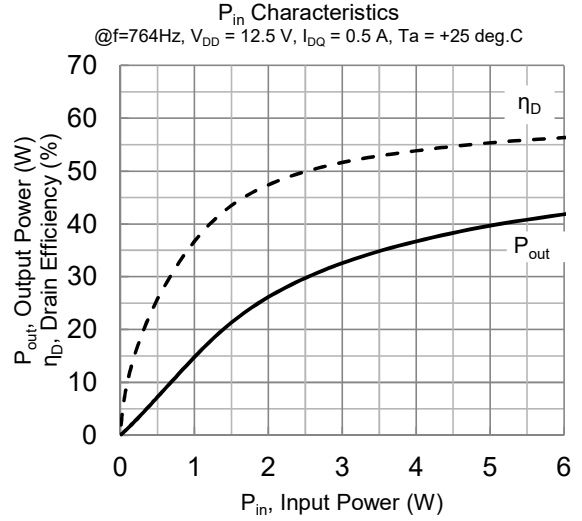
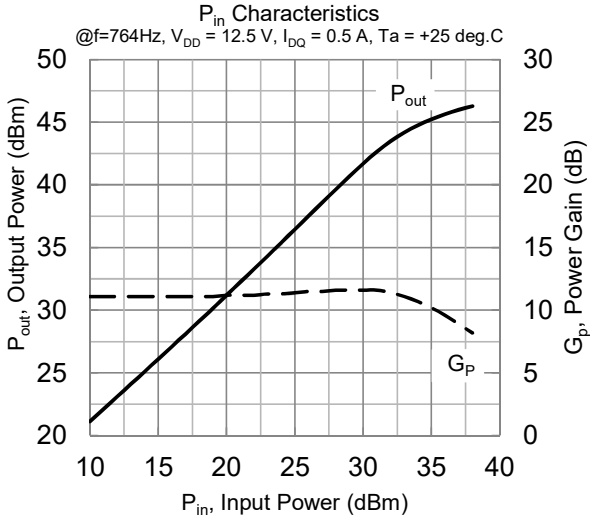

RD32HMP2

RoHS Compliance, Silicon MOSFET Power Transistor, 870MHz, 32W, 12.5V

EQUIVALENT CIRCUITRY for EVB Circuit of f=764-870 MHz

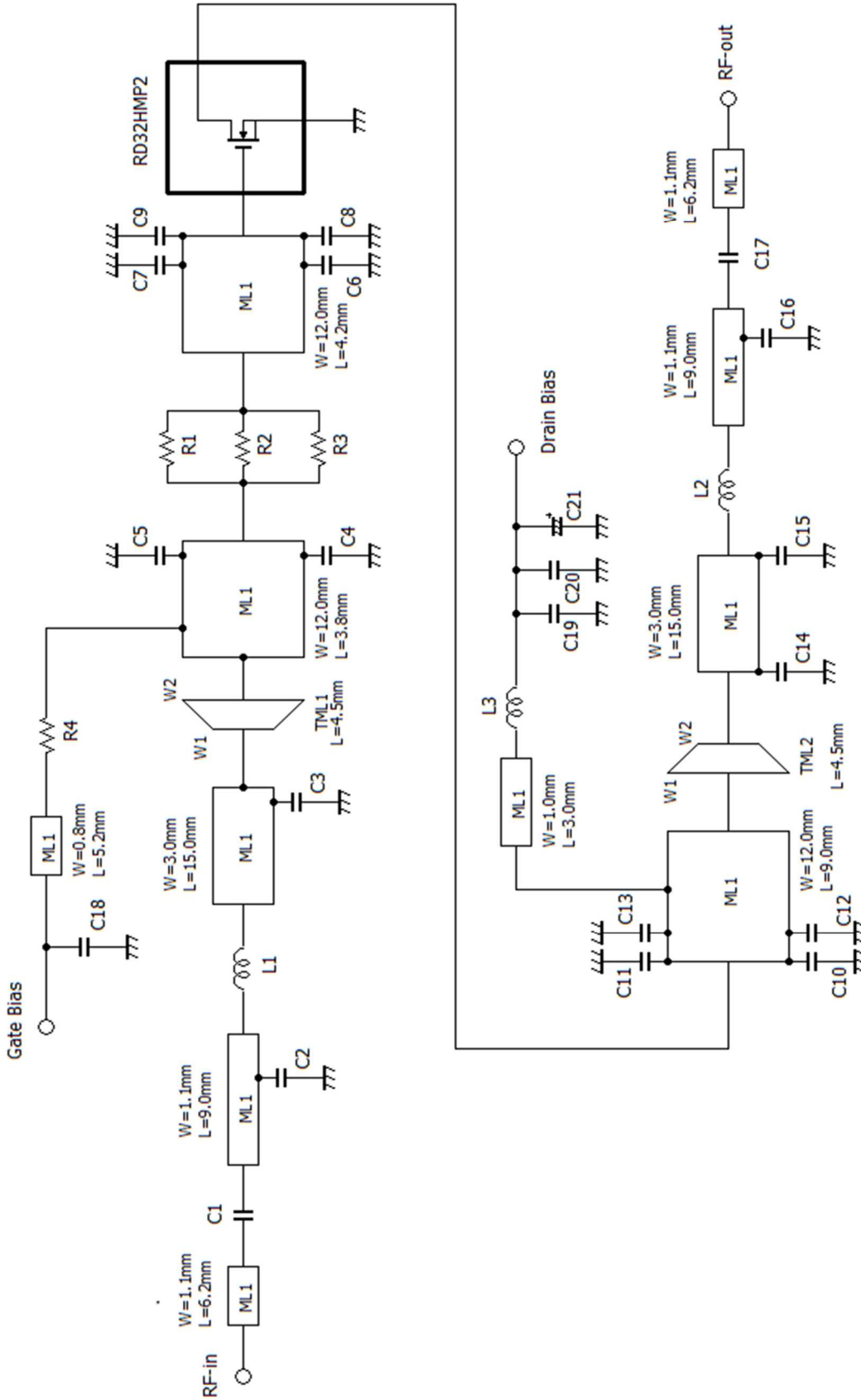

Board material : Glass Epoxy Substrate ($\epsilon_r=4.8$, $\tan\delta=0.018@1\text{GHz}$)

Micro Strip Line Substrate Thickness : ML1, T=0.6mm

Linear Tapered Microstrip Line :

TML1 W1=3.0mm, W2=12.0mm T=0.6mm,
TML2 W1=12.0mm, W2=3.0mm T=0.6mm

RD32HMP2

RoHS Compliance, Silicon MOSFET Power Transistor, 870MHz, 32W, 12.5V

COMPONENT LIST

No.	Description			P/N	Manufacturer
	Capacitance	Size	Remarks		
C1	100pF	2012	Hi-Q 250V	GQM2195C2E101JB12	MURATA MANUFACTURING CO.
C2	2.0pF	1608	Hi-Q 250V	GQM1875C2E2R0CB12D	MURATA MANUFACTURING CO.
C3	3.0pF	1608	Hi-Q 250V	GQM1875C2E3R0CB12D	MURATA MANUFACTURING CO.
C4	3.0pF	1608	Hi-Q 250V	GQM1875C2E3R0CB12D	MURATA MANUFACTURING CO.
C5	3.0pF	1608	Hi-Q 250V	GQM1875C2E3R0CB12D	MURATA MANUFACTURING CO.
C6	4.7pF	1608	Hi-Q 250V	GQM1875C2E4R7CB12D	MURATA MANUFACTURING CO.
C7	4.7pF	1608	Hi-Q 250V	GQM1875C2E4R7CB12D	MURATA MANUFACTURING CO.
C8	4.7pF	1608	Hi-Q 250V	GQM1875C2E4R7CB12D	MURATA MANUFACTURING CO.
C9	4.7pF	1608	Hi-Q 250V	GQM1875C2E4R7CB12D	MURATA MANUFACTURING CO.
C10	10pF	1608	Hi-Q 250V	GQM1875C2E100JB12D	MURATA MANUFACTURING CO.
C11	10pF	1608	Hi-Q 250V	GQM1875C2E100JB12D	MURATA MANUFACTURING CO.
C12	1.0pF	1608	Hi-Q 250V	GQM1875C2E1R0CB12D	MURATA MANUFACTURING CO.
C13	1.0pF	1608	Hi-Q 250V	GQM1875C2E1R0CB12D	MURATA MANUFACTURING CO.
C14	3.0pF	1608	Hi-Q 250V	GQM1875C2E3R0CB12D	MURATA MANUFACTURING CO.
C15	2.0pF	1608	Hi-Q 250V	GQM1875C2E2R0CB12D	MURATA MANUFACTURING CO.
C16	2.0pF	1608	Hi-Q 250V	GQM1875C2E2R0CB12D	MURATA MANUFACTURING CO.
C17	100pF	2012	Hi-Q 250V	GQM2195C2E101JB12	MURATA MANUFACTURING CO.
C18	1000pF	2012	50V	GRM216R11H102KA01	MURATA MANUFACTURING CO.
C19	1000pF	2012	50V	GRM216R11H102KA01	MURATA MANUFACTURING CO.
C20	0.22μF	2012	50V	GRM21BR71H224KA01	MURATA MANUFACTURING CO.
C21	220μF	-	35V	EEUFC1V221	Panasonic Corporation

* Inductor of Rolling Coil measurement condition : f=100MHz

No.	Description					P/N	Manufacturer	Remarks
	Inductance	Diameter			T/N of coils			
		Wire Φ	Inside Φ					
L 1	5.1 nH					Cu Bridge	YOSHIKAWA KOGYO Co.,Ltd.	Bridge inductor
L 2	1.1 nH					Cu Bridge H01	OISHI INDUSTRIES, Ltd.	Bridge inductor
L 3	16 nH*	0.8 mm	3.86 mm	4		8004C	YC Corporation Co.,Ltd.	Enameled wire

No.	Description		P/N	Manufacturer
	Resistance	Size		
R 1	2.2 Ω	2012	RPC10T2R2J	TAIYOSHA ELECTRIC CO.
R 2	1 Ω	2012	RPC10T1R0J	TAIYOSHA ELECTRIC CO.
R 3	2.2 Ω	2012	RPC10T2R2J	TAIYOSHA ELECTRIC CO.
R 4	4700 Ω	1608	RPC05T472J	TAIYOSHA ELECTRIC CO.

RD32HMP2

RoHS Compliance, Silicon MOSFET Power Transistor, 870MHz, 32W, 12.5V

Input / Output Impedance VS. Frequency Characteristics for f=764-870MHz

Method of Measurement

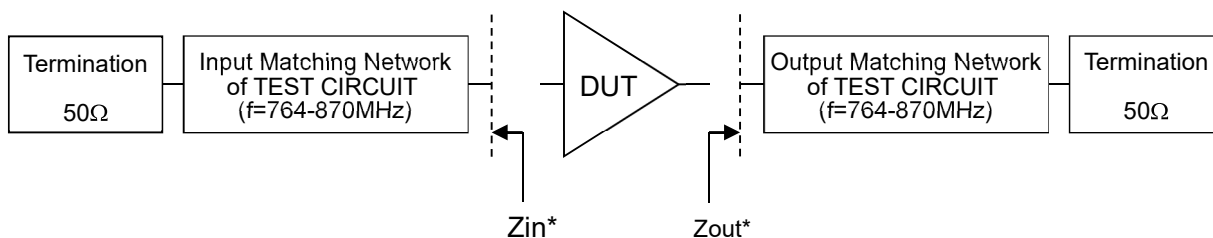

Zin*: Input Matching Network impedance measured from DUT

Zout*: Output Matching Network impedance measured from DUT

Z₀: Characteristic impedance

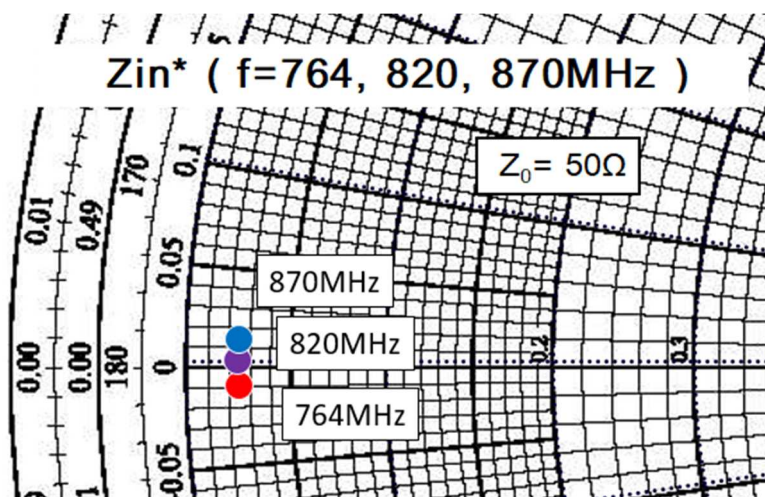

f (MHz)	Zin* (Ω)
764	1.25 - j 0.61
820	1.23 + j 0.04
870	1.22 + j 0.58

Zin*: Complex conjugate of input impedance

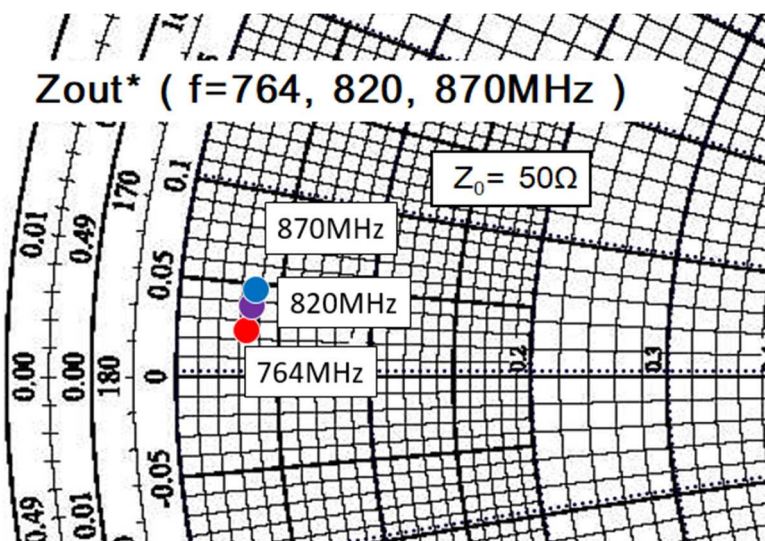

f (MHz)	Zout* (Ω)
764	1.69 + j 1.10
820	1.79 + j 1.75
870	1.84 + j 2.21

Zout*: Complex conjugate of output impedance

RD32HMP2

RoHS Compliance, Silicon MOSFET Power Transistor, 870MHz, 32W, 12.5V

S-Parameter data ($V_{DD} = 12.5\text{ V}$, $I_{DD} = 0.5\text{ A}$)

(MHz)	S11		S21		S12		S22	
	(mag)	(ang)	(mag)	(ang)	(mag)	(ang)	(mag)	(ang)
100	0.86	-166	14.08	62	0.008	-24	0.70	-153
150	0.90	-169	8.19	48	0.006	-35	0.79	-156
200	0.93	-172	5.31	38	0.005	-43	0.86	-160
250	0.95	-174	3.66	30	0.004	-45	0.91	-164
300	0.96	-176	2.63	24	0.002	-43	0.93	-168
350	0.97	-177	1.98	20	0.002	-37	0.94	-170
400	0.97	-178	1.55	17	0.001	-13	0.95	-172
450	0.98	-180	1.25	14	0.001	28	0.96	-173
500	0.98	179	1.03	11	0.001	57	0.96	-175
550	0.98	178	0.86	9	0.002	71	0.97	-176
600	0.99	178	0.73	7	0.002	76	0.97	-177
650	0.99	177	0.62	6	0.003	78	0.97	-179
700	0.99	176	0.54	4	0.003	79	0.98	-179
750	0.99	175	0.47	2	0.004	79	0.98	180
760	0.99	175	0.46	2	0.004	79	0.98	179
770	0.99	175	0.45	2	0.004	79	0.98	179
780	0.99	175	0.44	1	0.004	79	0.98	179
790	0.99	175	0.43	1	0.004	79	0.98	179
800	0.99	174	0.42	1	0.004	80	0.98	179
810	0.99	174	0.41	0	0.004	80	0.98	179
820	0.99	174	0.40	0	0.004	80	0.98	178
830	0.99	174	0.39	0	0.004	80	0.98	178
840	0.99	174	0.38	0	0.005	80	0.98	178
850	0.99	174	0.37	-1	0.005	79	0.98	178
860	0.99	173	0.36	-1	0.005	80	0.98	178
870	0.99	173	0.35	-1	0.005	79	0.98	178
880	0.99	173	0.35	-1	0.005	79	0.98	177
890	0.99	173	0.34	-1	0.005	79	0.98	177
900	0.99	173	0.33	-2	0.005	79	0.98	177
910	0.99	173	0.33	-2	0.005	79	0.98	177
920	0.99	173	0.32	-2	0.005	79	0.98	177
930	0.99	172	0.31	-2	0.005	79	0.98	177
940	0.99	172	0.31	-2	0.005	79	0.98	176
950	0.99	172	0.30	-2	0.005	79	0.98	176
1000	0.99	172	0.27	-3	0.006	79	0.99	176
1050	0.99	171	0.25	-5	0.006	79	0.99	175
1100	0.99	170	0.22	-6	0.006	78	0.99	174
1150	0.99	170	0.20	-7	0.007	78	0.99	174
1200	0.99	169	0.19	-7	0.007	77	0.99	173
1250	0.99	168	0.18	-8	0.008	77	0.99	172
1300	0.99	168	0.16	-8	0.008	76	0.99	172
1350	0.99	167	0.15	-9	0.008	76	0.99	171
1400	0.99	166	0.14	-10	0.008	75	0.99	171
1450	0.99	166	0.13	-11	0.009	75	0.99	172
1500	0.99	165	0.12	-11	0.009	74	0.99	172
1550	0.99	164	0.11	-12	0.009	74	0.99	172
1600	0.99	164	0.10	-12	0.010	73	0.99	171

RD32HMP2

RoHS Compliance, Silicon MOSFET Power Transistor, 870MHz, 32W, 12.5V

ATTENTION:

- 1.High Temperature ; This product might have a heat generation while operation,Please take notice that have a possibility to receive a burn to touch the operating product directly or touch the product until cold after switch off. At the near the product,do not place the combustible material that have possibilities to arise the fire
- 2.Generation of High Frequency Power ; This product generate a high frequency power. Please take notice that do not leakage the unnecessary electric wave and use this products without cause damage for human and property per normal operation.
- 3.Before use; Before use the product,Please design the equipment in consideration of the risk for human and electric wave obstacle for equipment.

PRECAUTIONS FOR THE USE OF MITSUBISHI SILICON RF POWER DEVICES:

1. The specifications of mention are not guarantee values in this data sheet. Please confirm additional details regarding operation of these products from the formal specification sheet. For copies of the formal specification sheets, please contact one of our sales offices.
- 2.RA series products (RF power amplifier modules) and RD series products (RF power transistors) are designed for consumer mobile communication terminals and were not specifically designed for use in other applications.
In particular, while these products are highly reliable for their designed purpose, they are not manufactured under a quality assurance testing protocol that is sufficient to guarantee the level of reliability typically deemed necessary for critical communications elements and In the application, which is base station applications and fixed station applications that operate with long term continuous transmission and a higher on-off frequency during transmitting, please consider the derating, the redundancy system, appropriate setting of the maintain period and others as needed. For the reliability report which is described about predicted operating life time of Mitsubishi Silicon RF Products , please contact Mitsubishi Electric Corporation or an authorized Mitsubishi Semiconductor product distributor.
3. RD series products use MOSFET semiconductor technology. They are sensitive to ESD voltage therefore appropriate ESD precautions are required.
4. In the case of use in below than recommended frequency, there is possibility to occur that the device is deteriorated or destroyed due to the RF-swing exceed the breakdown voltage.
5. In order to maximize reliability of the equipment, it is better to keep the devices temperature low. It is recommended to utilize a sufficient sized heat-sink in conjunction with other cooling methods as needed (fan, etc.) to keep the channel temperature for RD series products lower than 120deg/C(in case of Tchmax=150deg/C) ,140deg/C(in case of Tchmax=175deg/C) under standard conditions.
6. Do not use the device at the exceeded the maximum rating condition. In case of plastic molded devices, the exceeded maximum rating condition may cause blowout, smoldering or catch fire of the molding resin due to extreme short current flow between the drain and the source of the device. These results causes in fire or injury.
7. For specific precautions regarding assembly of these products into the equipment, please refer to the supplementary items in the specification sheet.
8. Warranty for the product is void if the products protective cap (lid) is removed or if the product is modified in any way from it's original form.
9. For additional "Safety first" in your circuit design and notes regarding the materials, please refer the last page of this data sheet.

RD32HMP2

RoHS Compliance, Silicon MOSFET Power Transistor, 870MHz, 32W, 12.5V

10. Please avoid use in the place where water or organic solvents can adhere directly to the product and the environments with the possibility of caustic gas, dust, salinity, etc. Reliability could be markedly decreased and also there is a possibility failures could result causing a serious accident. Likewise, there is a possibility of causing a serious accident if used in an explosive gas environment. Please allow for adequate safety margin in your designs.

11. Please refer to the additional precautions in the formal specification sheet.

RD32HMP2

RoHS Compliance, Silicon MOSFET Power Transistor, 870MHz, 32W, 12.5V

Keep safety first in your circuit designs!

Mitsubishi Electric Corporation puts the maximum effort into making semiconductor products better and more reliable, but there is always the possibility that trouble may occur with them. Trouble with semiconductors may lead to personal injury, fire or property damage. Remember to give due consideration to safety when making your circuit designs, with appropriate measures such as (i) placement of substitutive, auxiliary circuits, (ii) use of non-flammable material or (iii) prevention against any malfunction or mishap.

Notes regarding these materials

- These materials are intended as a reference to assist our customers in the selection of the Mitsubishi Electric Semiconductor product best suited to the customer's application; they do not convey any license under any intellectual property rights, or any other rights, belonging to Mitsubishi Electric Corporation or a third party.
- Mitsubishi Electric Corporation assumes no responsibility for any damage, or infringement of any third-party's rights, originating in the use of any product data, diagrams, charts, programs, algorithms, or circuit application examples contained in these materials.
- All information contained in these materials, including product data, diagrams, charts, programs and algorithms represents information on products at the time of publication of these materials, and are subject to change by Mitsubishi Electric Corporation without notice due to product improvements or other reasons. It is therefore recommended that customers contact Mitsubishi Electric Corporation or an authorized Mitsubishi Electric Semiconductor product distributor for the latest product information before purchasing a product listed herein.
The information described here may contain technical inaccuracies or typographical errors. Mitsubishi Electric Corporation assumes no responsibility for any damage, liability, or other loss rising from these inaccuracies or errors.
Please also pay attention to information published by Mitsubishi Electric Corporation by various means, including the Mitsubishi Electric Semiconductor home page (<http://www.MitsubishiElectric.com/semiconductor/>).
- When using any or all of the information contained in these materials, including product data, diagrams, charts, programs, and algorithms, please be sure to evaluate all information as a total system before making a final decision on the applicability of the information and products. Mitsubishi Electric Corporation assumes no responsibility for any damage, liability or other loss resulting from the information contained herein.
- Mitsubishi Electric Corporation semiconductors are not designed or manufactured for use in a device or system that is used under circumstances in which human life is potentially at stake. Please contact Mitsubishi Electric Corporation or an authorized Mitsubishi Electric Semiconductor product distributor when considering the use of a product contained herein for any specific purposes, such as apparatus or systems for transportation, vehicular, medical, aerospace, nuclear, or undersea repeater use.
- The prior written approval of Mitsubishi Electric Corporation is necessary to reprint or reproduce in whole or in part these materials.
- If these products or technologies are subject to the Japanese export control restrictions, they must be exported under a license from the Japanese government and cannot be imported into a country other than the approved destination.
Any diversion or re-export contrary to the export control laws and regulations of Japan and/or the country of destination is prohibited.
- Please contact Mitsubishi Electric Corporation or an authorized Mitsubishi Electric Semiconductor product distributor for further details on these materials or the products contained therein.