

RA07H4047M

RoHS Compliance, 400-470MHz 7W, 12.5V, 2 Stage Amp. For Portable Radio

DESCRIPTION

The RA07H4047M is a 7-watt RF MOSFET Amplifier Module for 12.5-volt portable radios that operate in the 400- to 470MHz range. The battery can be connected directly to the drain of the enhancement-mode MOSFET transistors. Without the gate voltage ($V_{GG}=0V$), only a small leakage current flows into the drain and the RF input signal attenuates up to 60 dB. The output power and drain current increase as the gate voltage increases. With a gate voltage around 2.5V (minimum), output power and drain current increases substantially. The nominal output power becomes available at 3V (typical) and 3.5V (maximum).

This module is designed for non-linear FM modulation, but may also be used for linear modulation by setting the drain quiescent current with the gate voltage and controlling the output power with the input power.

FEATURES

- Enhancement-Mode MOSFET Transistors
($I_{DD} \approx 0$ @ $V_{DD}=12.5V$, $V_{GG}=0V$)
- $P_{out} > 7W$ @ $V_{DD}=12.5V$, $V_{GG}=3.5V$, $P_{in}=20mW$
- $\eta_T > 40\%$ @ $P_{out}=7W$ (V_{GG} control), $V_{DD}=12.5V$, $P_{in}=20mW$
- Broadband Frequency Range: 400-470MHz
- Module Size: 30 x 10 x 5.4 mm
- Linear operation is possible by setting the quiescent drain current with the gate voltage and controlling the output power with the input power

RoHS COMPLIANCE

- RA07H4047M is a RoHS compliant products.
- This product include the lead in the Glass of electronic parts and the lead in electronic Ceramic parts.
However, it is applicable to the following exceptions of RoHS Directions.
 1. Lead in the Glass of a cathode-ray tube, electronic parts, and fluorescent tubes.
 2. Lead in electronic Ceramic parts.

ORDERING INFORMATION:

ORDER NUMBER	SUPPLY FORM
RA07H4047M-501	Antistatic tray, 50 modules/tray

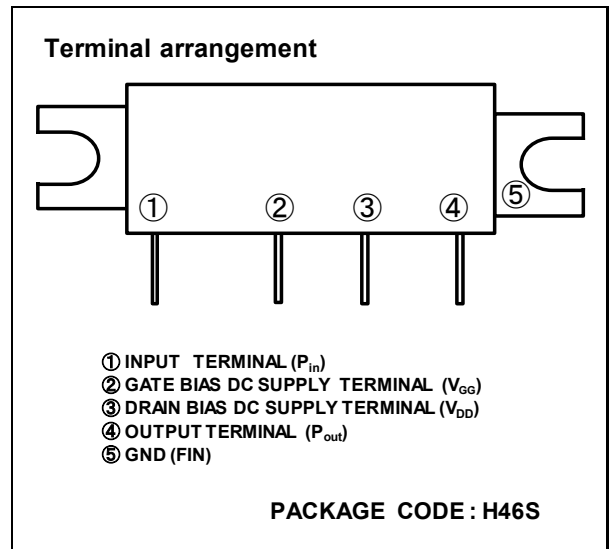

RA07H4047M

RoHS Compliance, 400-470MHz 7W, 12.5V, 2 Stage Amp. For Portable Radio

MAXIMUM RATINGS ($T_{case}=+25^{\circ}\text{C}$, $Z_G=Z_L=50\Omega$, unless otherwise specified)

SYMBOL	PARAMETER	CONDITIONS	RATING	UNIT
V_{DD}	Drain Voltage	$V_{GG}=0\text{V}$, $P_{in}=0\text{W}$	16	V
V_{GG}	Gate Voltage	$V_{DD}\leq 12.5\text{V}$, $P_{in}=20\text{mW}$	4	V
I_{DD}	Total Current	-	4	A
P_{in}	Input Power	$f=400\text{-}470\text{MHz}$, $V_{GG}\leq 3.5\text{V}$	30	mW
P_{out}	Output Power		10	W
$T_{case(OP)}$	Operation Case Temperature Range		-30 to +90	$^{\circ}\text{C}$
T_{stg}	Storage Temperature Range	-	-40 to +110	$^{\circ}\text{C}$

The above parameters are independently guaranteed.

ELECTRICAL CHARACTERISTICS ($T_{case}=+25^{\circ}\text{C}$, $Z_G=Z_L=50\Omega$, unless otherwise specified)

SYMBOL	PARAMETER	CONDITIONS	MIN	TYP	MAX	UNIT
f	Frequency Range	-	400	-	470	MHz
P_{out}	Output Power	$V_{DD}=12.5\text{V}$, $V_{GG}=3.5\text{V}$, $P_{in}=20\text{mW}$	7	-	-	W
η_T	Total Efficiency	$P_{out}=7\text{W}$ (V_{GG} adj.), $V_{DD}=12.5\text{V}$, $P_{in}=20\text{mW}$	40	-	-	%
$2f_0$	2 nd Harmonic		-	-	-25	dBc
$3f_0$	3 rd Harmonic		-	-	-30	dBc
ρ_{in}	Input VSWR		-	-	4:1	-
I_{DD}	Drain Current	$V_{DD}=16\text{V}$, $V_{GG}=0\text{V}$, $P_{in}=0\text{W}$	-	300	-	μA
-	Load VSWR Tolerance	$V_{DD}=13.2\text{V}$, $P_{in}=20\text{mW}$, $P_{out}=7\text{W}$ (V_{GG} adj.), Load VSWR=20:1 (All Phase)	No degradation or destroy			-
-	Stability	$V_{DD}=7.2/12.5/15.0\text{V}$, $P_{in}=10/20/30\text{mW}$, $P_{out}\leq 8\text{W}$ (V_{GG} control), Load VSWR=4:1 (All Phase)	No parasitic oscillation more than -60dBc			-

All parameters, conditions, ratings, and limits are subject to change without notice.

RA07H4047M

RoHS Compliance, 400-470MHz 7W, 12.5V, 2 Stage Amp. For Portable Radio

TYPICAL PERFORMANCE ($T_{case}=+25^{\circ}C$, $Z_G=Z_L=50\Omega$, unless otherwise specified)

OUTPUT POWER, TOTAL EFFICIENCY, and INPUT VSWR versus FREQUENCY

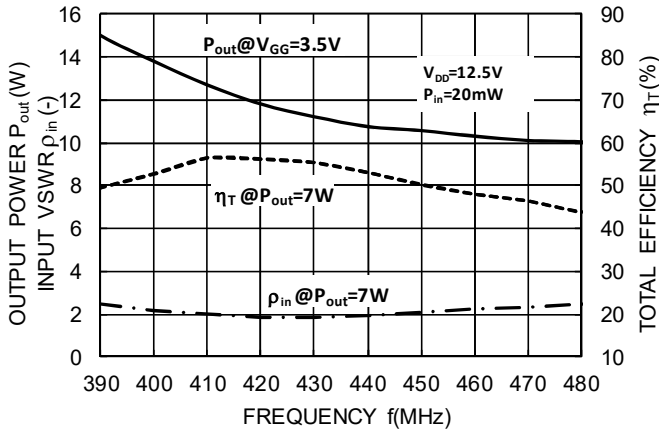

2nd, 3rd HARMONICS versus FREQUENCY

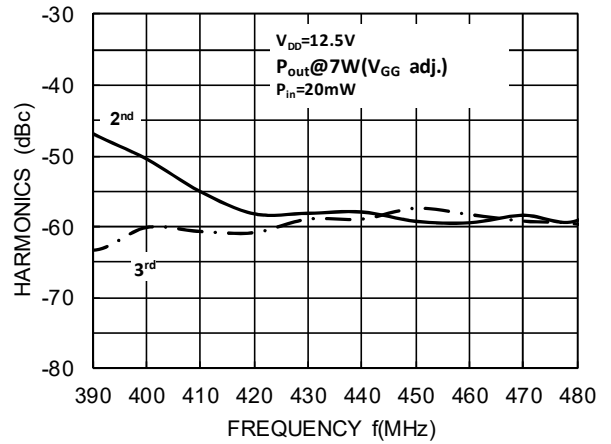

OUTPUT POWER, POWER GAIN and DRAIN CURRENT versus INPUT POWER

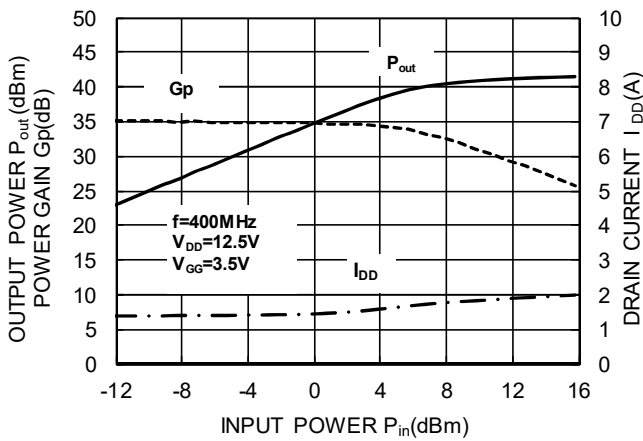

OUTPUT POWER, POWER GAIN and DRAIN CURRENT versus INPUT POWER

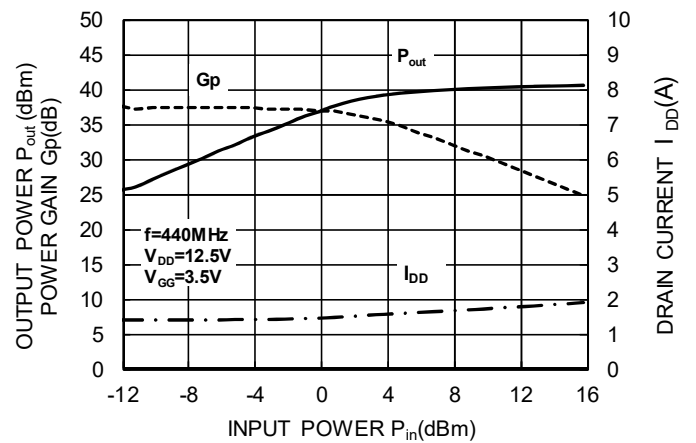

OUTPUT POWER, POWER GAIN and DRAIN CURRENT versus INPUT POWER

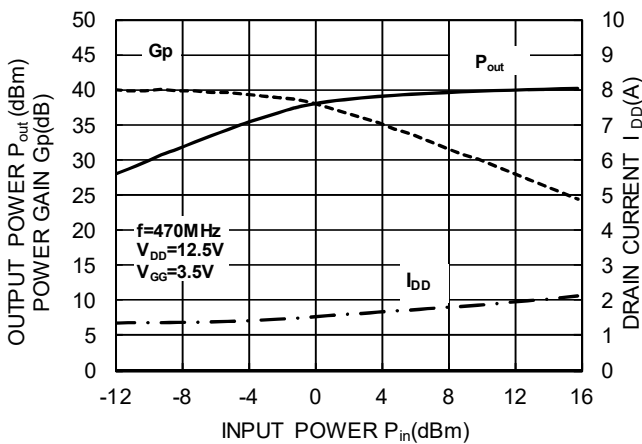

RA07H4047M

RoHS Compliance, 400-470MHz 7W, 12.5V, 2 Stage Amp. For Portable Radio

TYPICAL PERFORMANCE ($T_{case}=+25^{\circ}C$, $Z_G=Z_L=50\Omega$, unless otherwise specified)

OUTPUT POWER, and DRAIN CURRENT versus FREQUENCY

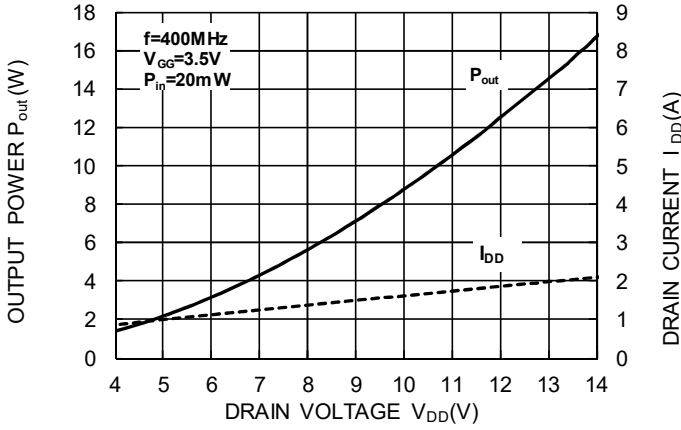

OUTPUT POWER, and DRAIN CURRENT versus DRAIN VOLTAGE

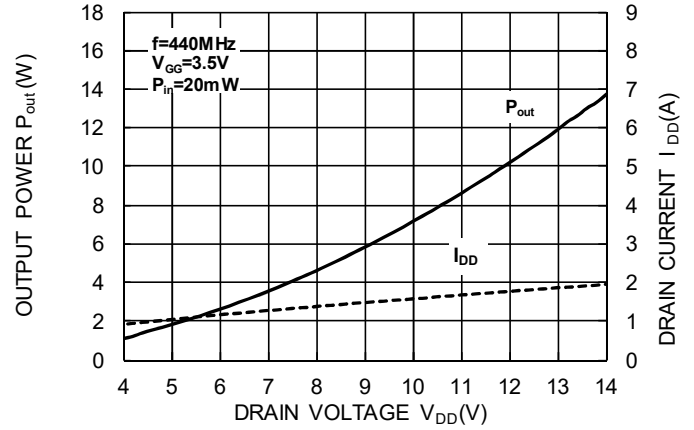

OUTPUT POWER, and DRAIN CURRENT versus DRAIN VOLTAGE

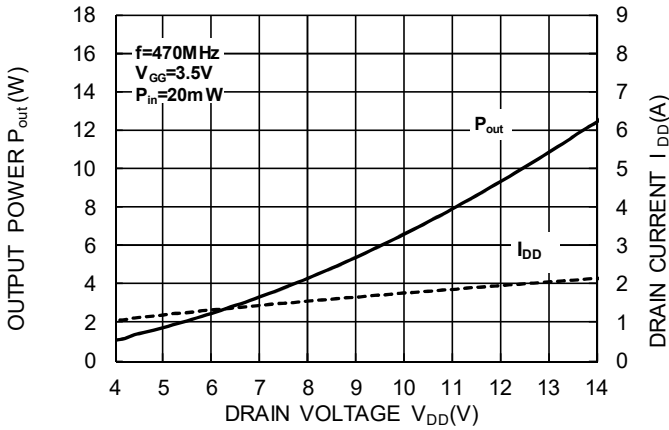

RA07H4047M

RoHS Compliance, 400-470MHz 7W, 12.5V, 2 Stage Amp. For Portable Radio

TYPICAL PERFORMANCE ($T_{case}=+25^{\circ}C$, $Z_G=Z_L=50\Omega$, unless otherwise specified)

**OUTPUT POWER and DRAIN CURRENT
versus GATE VOLTAGE**

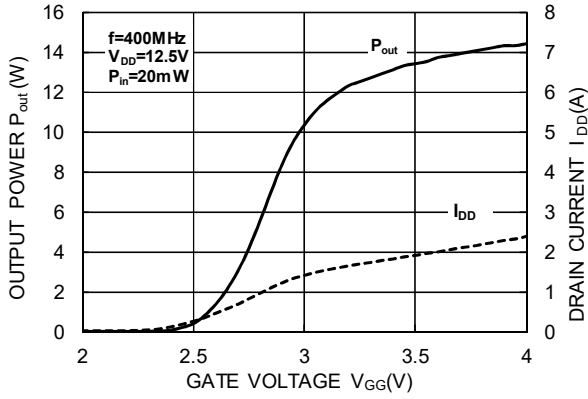

**OUTPUT POWER and DRAIN CURRENT
versus GATE VOLTAGE**

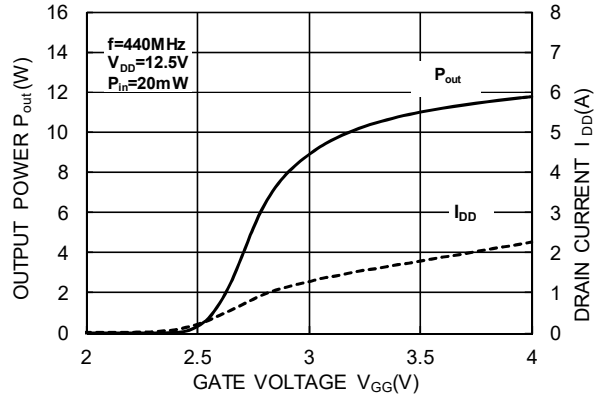

**OUTPUT POWER and DRAIN CURRENT
versus GATE VOLTAGE**

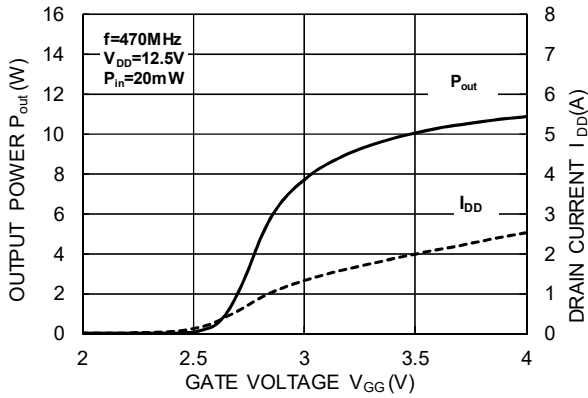

RA07H4047M

RoHS Compliance, 400-470MHz 7W, 12.5V, 2 Stage Amp. For Portable Radio

OUTLINE DRAWING (mm)

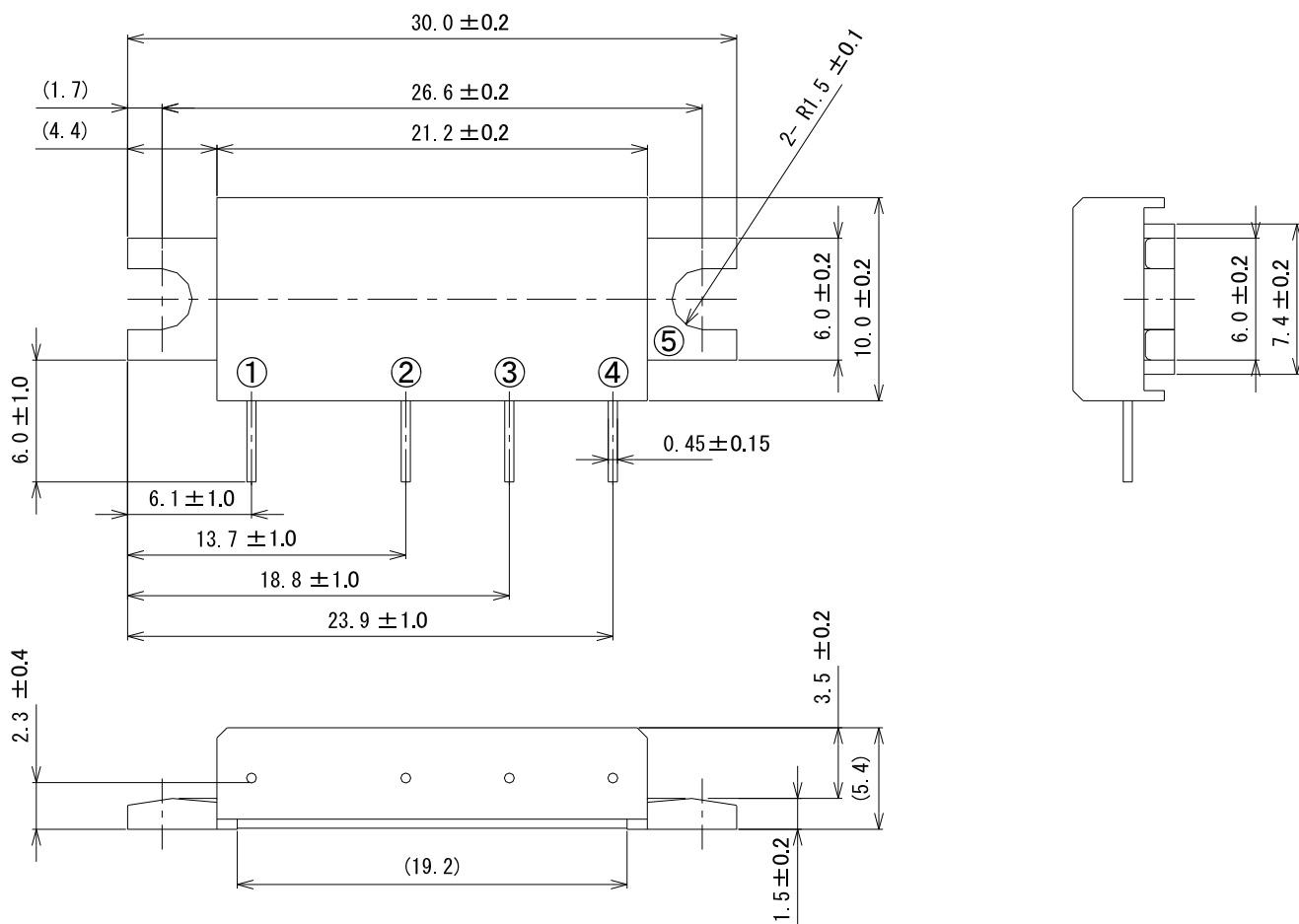

- ① INPUT TERMINAL (P_{in})
- ② GATE BIAS DC SUPPLY TERMINAL (V_{GG})
- ③ DRAIN BIAS DC SUPPLY TERMINAL (V_{DD})
- ④ OUTPUT TERMINAL (P_{out})
- ⑤ FIN (GND)

RA07H4047M

RoHS Compliance, 400-470MHz 7W, 12.5V, 2 Stage Amp. For Portable Radio

TEST BLOCK DIAGRAM

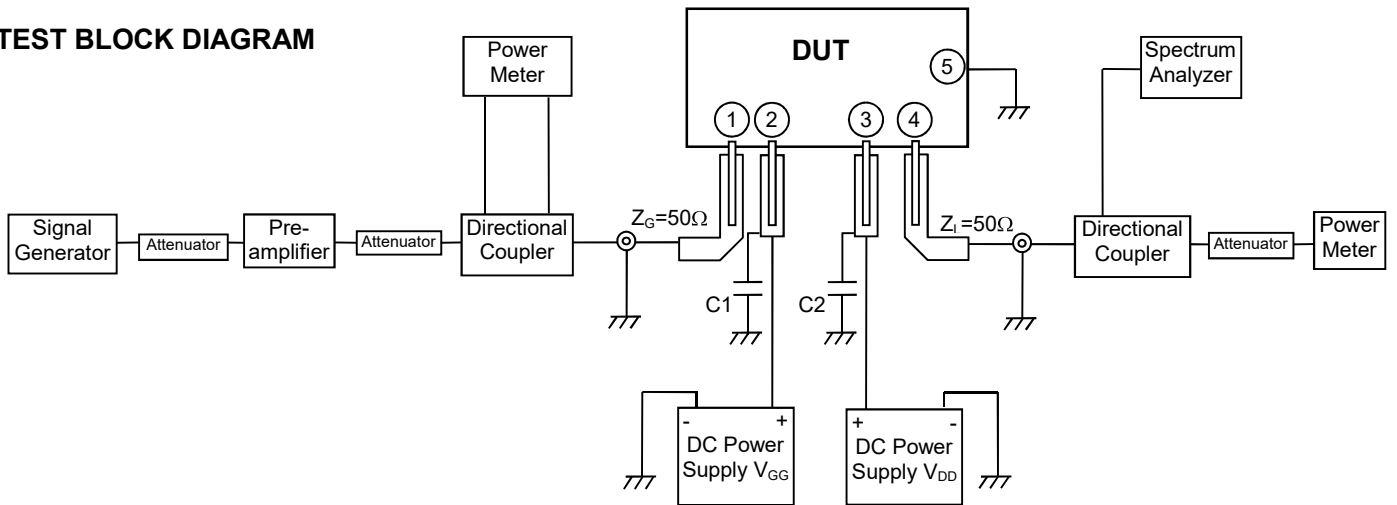

C1, C2: 4700pF, 22uF in parallel

- ① INPUT TERMINAL (P_{in})
- ② GATE BIAS DC SUPPLY TERMINAL (V_{GG})
- ③ DRAIN BIAS DC SUPPLY TERMINAL (V_{DD})
- ④ OUTPUT TERMINAL (P_{out})
- ⑤ FIN (GND)

EQUIVALENT CIRCUIT

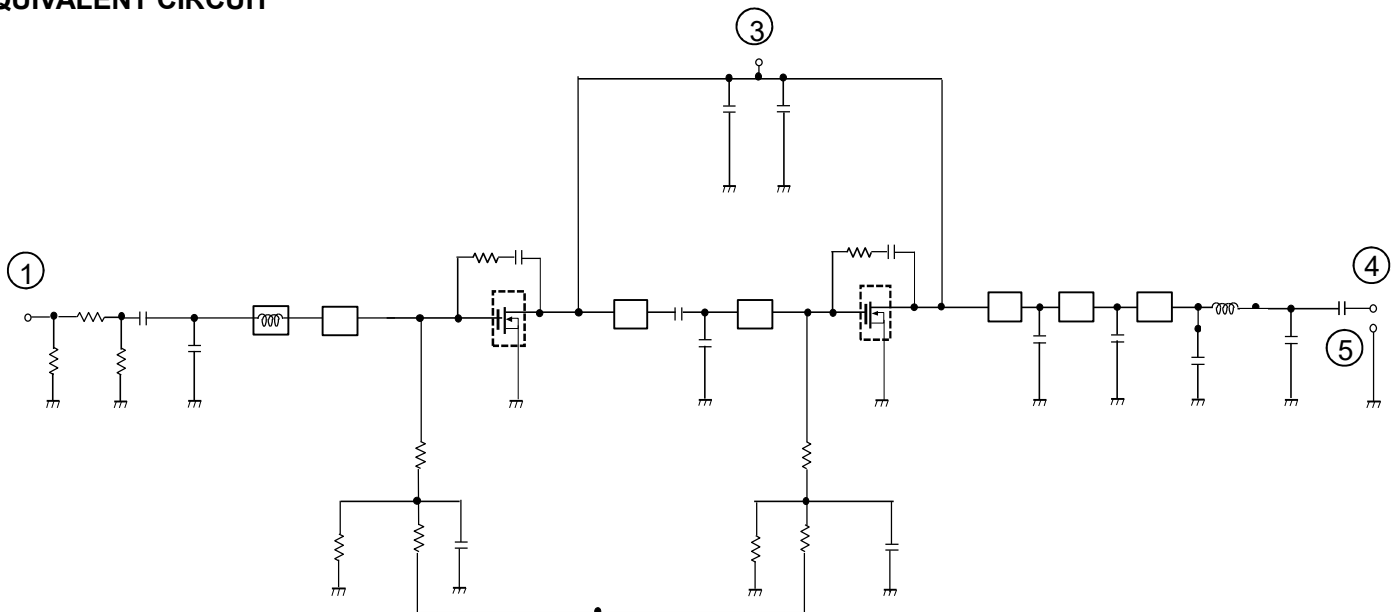

- ① INPUT TERMINAL (P_{in})
- ② GATE BIAS DC SUPPLY TERMINAL (V_{GG})
- ③ DRAIN BIAS DC SUPPLY TERMINAL (V_{DD})
- ④ OUTPUT TERMINAL (P_{out})
- ⑤ FIN (GND)

RA07H4047M

RoHS Compliance, 400-470MHz 7W, 12.5V, 2 Stage Amp. For Portable Radio

RECOMMENDATIONS and APPLICATION INFORMATION:

Construction:

This module consists of an alumina substrate soldered onto a copper flange. For mechanical protection, a plastic cap is attached with silicone. The MOSFET transistor chips are die bonded onto metal, wire bonded to the substrate, and coated with resin. Lines on the substrate (eventually inductors), chip capacitors, and resistors form the bias and matching circuits. Wire leads soldered onto the alumina substrate provide the DC and RF connection.

Following conditions must be avoided:

- a) Bending forces on the alumina substrate (for example, by driving screws or from fast thermal changes)
- b) Mechanical stress on the wire leads (for example, by first soldering then driving screws or by thermal expansion)
- c) Defluxing solvents reacting with the resin coating on the MOSFET chips (for example, Trichloroethylene)
- d) ESD, surge, overvoltage in combination with load VSWR, and oscillation

ESD:

This MOSFET module is sensitive to ESD voltages down to 1000V. Appropriate ESD precautions are required.

Mounting:

Heat sink flatness must be less than 50 μm (a heat sink that is not flat or particles between module and heat sink may cause the ceramic substrate in the module to crack by bending forces, either immediately when driving screws or later when thermal expansion forces are added).

A thermal compound between module and heat sink is recommended for low thermal contact resistance and to reduce the bending stress on the ceramic substrate caused by the temperature difference to the heat sink.

The module must first be screwed to the heat sink, then the leads can be soldered to the printed circuit board.

M2.6 screws are recommended with a tightening torque of 1.8 to 3.0 kgf-cm.

Soldering and Defluxing:

This module is designed for manual soldering.

The leads must be soldered after the module is screwed onto the heat sink.

The temperature of the lead (terminal) soldering should be lower than 350°C and shorter than 3 second.

Ethyl Alcohol is recommend for removing flux. Trichloroethylene solvents must not be used (they may cause bubbles in the coating of the transistor chips which can lift off the bond wires).

Thermal Design of the Heat Sink:

At $P_{out}=7W$, $V_{DD}=12.5V$ and $P_{in}=20mW$ each stage transistor operating conditions are:

Stage	P_{in} (W)	P_{out} (W)	$R_{th(ch-case)}$ (°C/W)	$I_{DD} @ \eta_T=40\%$ (A)	V_{DD} (V)
1 st	0.02	1.5	4.5	0.25	12.5
2 nd	1.5	7.0	2.4	1.15	

The channel temperatures of each stage transistor $T_{ch} = T_{case} + (V_{DD} \times I_{DD} - P_{out} + P_{in}) \times R_{th(ch-case)}$ are:

$$T_{ch1} = T_{case} + (12.5V \times 0.25A - 1.5W + 0.02W) \times 4.5^\circ C/W = T_{case} + 7.4^\circ C$$

$$T_{ch2} = T_{case} + (12.5V \times 1.15A - 7.0W + 1.5W) \times 2.4^\circ C/W = T_{case} + 21.3^\circ C$$

For long-term reliability, it is best to keep the module case temperature (T_{case}) below 90°C. For an ambient temperature $T_{air}=60^\circ C$ and $P_{out}=7W$, the required thermal resistance $R_{th(case-air)} = (T_{case} - T_{air}) / ((P_{out} / \eta_T) - P_{out} + P_{in})$ of the heat sink, including the contact resistance, is:

$$R_{th(case-air)} = (90^\circ C - 60^\circ C) / (7W/40\% - 7W + 0.02W) = 2.85^\circ C/W$$

When mounting the module with the thermal resistance of 2.85 °C/W, the channel temperature of each stage transistor is:

$$T_{ch1} = T_{air} + 37.4^\circ C$$

$$T_{ch2} = T_{air} + 51.3^\circ C$$

The 175°C maximum rating for the channel temperature ensures application under derated conditions.

RA07H4047M

RoHS Compliance, 400-470MHz 7W, 12.5V, 2 Stage Amp. For Portable Radio

Output Power Control:

By the gate voltage (V_{GG}).

Around $V_{GG}=2.5V$, the output power and drain current increases substantially.

Around $V_{GG}=3V$ (typical) to $V_{GG}=3.5V$ (maximum), the nominal output power becomes available.

Oscillation:

To test RF characteristics, this module is put on a fixture with two bias decoupling capacitors each on gate and drain, a 4700 pF chip capacitor, located close to the module, and a 22 μF (or more) electrolytic capacitor.

When an amplifier circuit around this module shows oscillation, the following may be checked:

- a) Do the bias decoupling capacitors have a low inductance pass to the case of the module?
- b) Is the load impedance $Z_L=50\Omega$?
- c) Is the source impedance $Z_G=50\Omega$?

ATTENTION:

1. High Temperature; This product might have a heat generation while operation, Please take notice that have a possibility to receive a burn to touch the operating product directly or touch the product until cold after switch off. At the near the product, do not place the combustible material that have possibilities to arise the fire.
2. Generation of High Frequency Power; This product generate a high frequency power. Please take notice that do not leakage the unnecessary electric wave and use this products without cause damage for human and property per normal operation.
3. Before use; Before use the product, Please design the equipment in consideration of the risk for human and electric wave obstacle for equipment.

PRECAUTION FOR THE USE OF MITSUBISHI SILICON RF POWER AMPLIFIER DEVICES:

1. The specifications of mention are not guarantee values in this data sheet. Please confirm additional details regarding operation of these products from the formal specification sheet. For copies of the formal specification sheets, please contact one of our sales offices.
2. RA series products (RF power amplifier modules) and RD series products (RF power transistors) are designed for consumer mobile communication terminals and were not specifically designed for use in other applications. In particular, while these products are highly reliable for their designed purpose, they are not manufactured under a quality assurance testing protocol that is sufficient to guarantee the level of reliability typically deemed necessary for critical communications elements. In the application, which is base station applications and fixed station applications that operate with long term continuous transmission and a higher on-off frequency during transmitting, please consider the derating, the redundancy system, appropriate setting of the maintain period and others as needed. For the reliability report which is described about predicted operating life time of Mitsubishi Silicon RF Products, please contact Mitsubishi Electric Corporation or an authorized Mitsubishi Semiconductor product distributor.
3. RA series products use MOSFET semiconductor technology. They are sensitive to ESD voltage therefore appropriate ESD precautions are required.
4. In order to maximize reliability of the equipment, it is better to keep the devices temperature low. It is recommended to utilize a sufficient sized heat-sink in conjunction with other cooling methods as needed (fan, etc.) to keep the case temperature for RA series products lower than 60deg/C under standard conditions, and less than 90deg/C under extreme conditions.
5. RA series products are designed to operate into a nominal load impedance of 50 ohms. Under the condition of operating into a severe high load VSWR approaching an open or short, an over load condition could occur. In the worst case there is risk for burn out of the transistors and burning of other parts including the substrate in the module.
6. The formal specification includes a guarantee against parasitic oscillation under a specified maximum load mismatch condition. The inspection for parasitic oscillation is performed on a sample basis on our manufacturing line. It is recommended that verification of no parasitic oscillation be performed at the completed equipment level also.
7. For specific precautions regarding assembly of these products into the equipment, please refer to the supplementary items in the specification sheet.
8. Warranty for the product is void if the products protective cap (lid) is removed or if the product is modified in any way from it's original form.
9. For additional "Safety first" in your circuit design and notes regarding the materials, please refer the last page of this data sheet.

RA07H4047M

RoHS Compliance, 400-470MHz 7W, 12.5V, 2 Stage Amp. For Portable Radio

10. Design and use environment:

Please avoid use in the place where water or organic solvents can adhere directly to the product and the environments with the possibility of salt air, caustic gas(hydrosulfuric H₂S, sulfurous gas SO₂, chlorine gas Cl₂, nitrogen dioxide NO₂, ozone O₃, etc), dust, salinity, etc. Reliability could be markedly decreased and also there is a possibility failures could result causing a serious accident. Likewise, there is a possibility of causing a serious accident if used in an explosive gas environment. Please allow for adequate safety margin in your designs.

11. Please refer to the additional precautions in the formal specification sheet.

Keep safety first in your circuit designs!

Mitsubishi Electric Corporation puts the maximum effort into making semiconductor products better and more reliable, but there is always the possibility that trouble may occur with them. Trouble with semiconductors may lead to personal injury, fire or property damage. Remember to give due consideration to safety when making your circuit designs, with appropriate measures such as (i) placement of substitutive, auxiliary circuits, (ii) use of non-flammable material or (iii) prevention against any malfunction or mishap.

Notes regarding these materials

- These materials are intended as a reference to assist our customers in the selection of the Mitsubishi semiconductor product best suited to the customer's application; they do not convey any license under any intellectual property rights, or any other rights, belonging to Mitsubishi Electric Corporation or a third party.
- Mitsubishi Electric Corporation assumes no responsibility for any damage, or infringement of any third-party's rights, originating in the use of any product data, diagrams, charts, programs, algorithms, or circuit application examples contained in these materials.
- All information contained in these materials, including product data, diagrams, charts, programs and algorithms represents information on products at the time of publication of these materials, and are subject to change by Mitsubishi Electric Corporation without notice due to product improvements or other reasons. It is therefore recommended that customers contact Mitsubishi Electric Corporation or an authorized Mitsubishi Semiconductor product distributor for the latest product information before purchasing a product listed herein.
The information described here may contain technical inaccuracies or typographical errors. Mitsubishi Electric Corporation assumes no responsibility for any damage, liability, or other loss rising from these inaccuracies or errors.
Please also pay attention to information published by Mitsubishi Electric Corporation by various means, including the Mitsubishi Semiconductor home page (<http://www.MitsubishiElectric.com/>).
- When using any or all of the information contained in these materials, including product data, diagrams, charts, programs, and algorithms, please be sure to evaluate all information as a total system before making a final decision on the applicability of the information and products. Mitsubishi Electric Corporation assumes no responsibility for any damage, liability or other loss resulting from the information contained herein.
- Mitsubishi Electric Corporation semiconductors are not designed or manufactured for use in a device or system that is used under circumstances in which human life is potentially at stake. Please contact Mitsubishi Electric Corporation or an authorized Mitsubishi Semiconductor product distributor when considering the use of a product contained herein for any specific purposes, such as apparatus or systems for transportation, vehicular, medical, aerospace, nuclear, or undersea repeater use.
- The prior written approval of Mitsubishi Electric Corporation is necessary to reprint or reproduce in whole or in part these materials.
- If these products or technologies are subject to the Japanese export control restrictions, they must be exported under a license from the Japanese government and cannot be imported into a country other than the approved destination.
Any diversion or re-export contrary to the export control laws and regulations of Japan and/or the country of destination is prohibited.
- Please contact Mitsubishi Electric Corporation or an authorized Mitsubishi Semiconductor product distributor for further details on these materials or the products contained therein.