

RM400DY-66S

HIGH POWER SWITCHING USE
INSULATED TYPE

High Voltage Diode Module

RM400DY-66S



- IF 400A
- VRRM 3300V
- Insulated Type
- 2-element in a Pack
- Copper Baseplate

APPLICATION

Traction drives, High Reliability Converters / Inverters, DC choppers

OUTLINE DRAWING & CIRCUIT DIAGRAM

Dimensions in mm

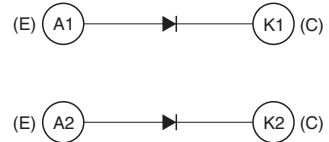
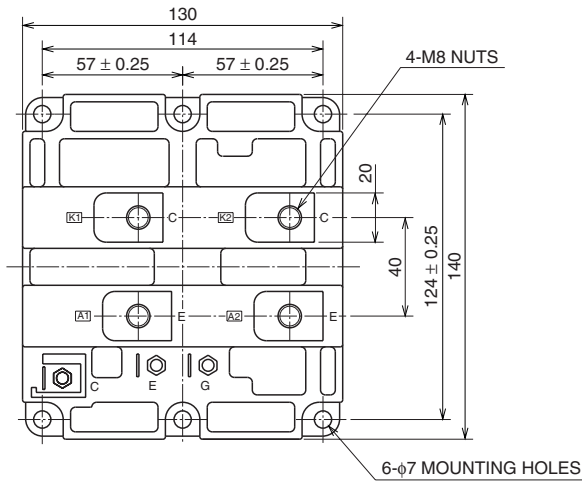

CIRCUIT DIAGRAM

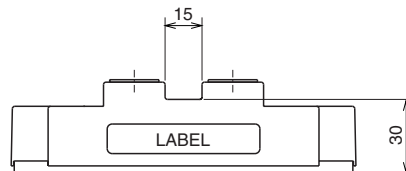
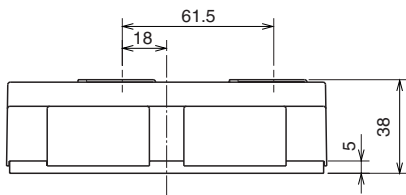

High Voltage Diode Module

RM400DY-66S

**HIGH POWER SWITCHING USE
INSULATED TYPE**

High Voltage Diode Module

MAXIMUM RATINGS

Symbol	Item	Conditions	Ratings	Unit
VRRM	Repetitive peak reverse voltage	T _j = 25 °C	3300	V
VRSM	Non-repetitive peak reverse voltage	T _j = 25 °C	3300	V
VR(DC)	Reverse DC voltage	T _j = 25 °C	2200	V
IF	DC forward current	T _c = 25 °C	400	A
IFSM	Surge forward current	T _j = 25 °C start, t _w = 8.3 ms Half sign wave	3200	A
i ² t	Current-squared, time integration	T _j = 25 °C start, t _w = 8.3 ms Half sign wave	42.7	kA ² s
V _{iso}	Isolation voltage	Charged part to the baseplate RMS sinusoidal, 60Hz 1min.	6000	V
T _j	Junction temperature	—	-40 ~ +150	°C
T _{op}	Operating temperature	—	-40 ~ +125	°C
T _{stg}	Storage temperature	—	-40 ~ +125	°C

ELECTRICAL CHARACTERISTICS

Symbol	Item	Conditions	Limits			Unit
			Min	Typ	Max	
IRRM	Repetitive reverse current	V _{RM} = VRRM	T _j = 25 °C	—	3.0	mA
			T _j = 125 °C	—	10	
VFM	Forward voltage (Note 1)	I _F = 400 A	T _j = 25 °C	—	4.55	V
			T _j = 125 °C	—	3.75	
t _{rr}	Reverse recovery time	V _R = 1650 V, I _F = 400 A di/dt = -800 A/μs L _s =200nH, T _j = 125 °C	—	0.75	—	μs
I _{rr}	Reverse recovery current		—	300	—	A
Q _{rr}	Reverse recovery charge		—	200	—	μC
E _{rec}	Reverse recovery energy (Note 2)		—	0.15	—	J/P

Note 1. It doesn't include the voltage drop by internal lead resistance.
2. E_{rec} is the integral of 0.1V_Rx 0.1I_{rr}x dt.

RM400DY-66S

**HIGH POWER SWITCHING USE
INSULATED TYPE**

High Voltage Diode Module

THERMAL CHARACTERISTICS

Symbol	Item	Conditions	Limits			Unit
			Min	Typ	Max	
R _{th(j-c)}	Thermal resistance	Junction to case (per 1/2 module)	—	—	72.0	K/kW
R _{th(c-f)}	Contact thermal resistance	Case to Fin, λ _{grease} = 1W/m-K D _(c-f) =100μm, (per 1/2 module)	—	36.0	—	K/kW

MECHANICAL CHARACTERISTICS

Symbol	Item	Conditions	Limits			Unit
			Min	Typ	Max	
M _t	Mounting torque	M8: Main terminals screw	6.67	—	8.24	N·m
M _s		M6: Mounting screw	2.84	—	3.43	N·m
m	Mass	—	—	1.5	—	kg

PERFORMANCE CURVES

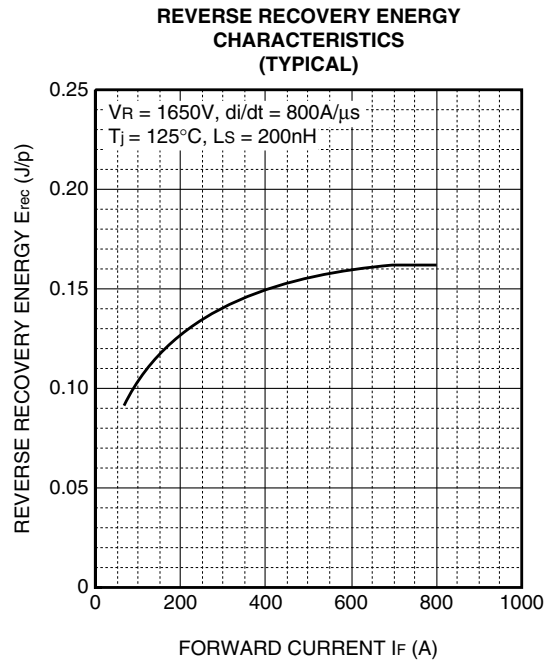
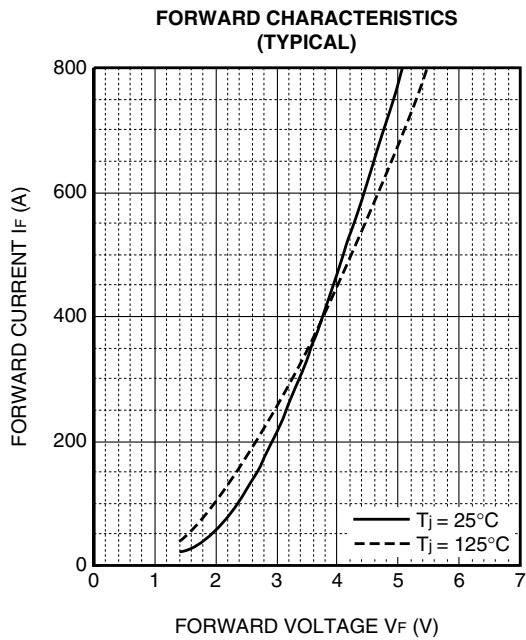

High Voltage Diode Module

RM400DY-66S

**HIGH POWER SWITCHING USE
INSULATED TYPE**

High Voltage Diode Module

REVERSE RECOVERY CHARACTERISTICS (TYPICAL)

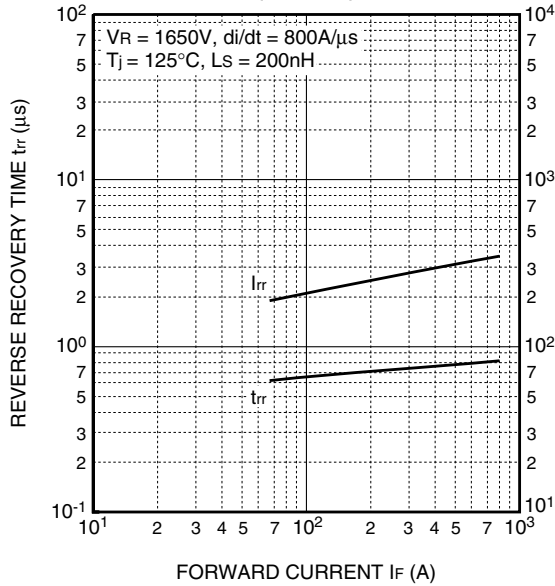

REVERSE RECOVERY SAFE OPERATING AREA (RRSOA)

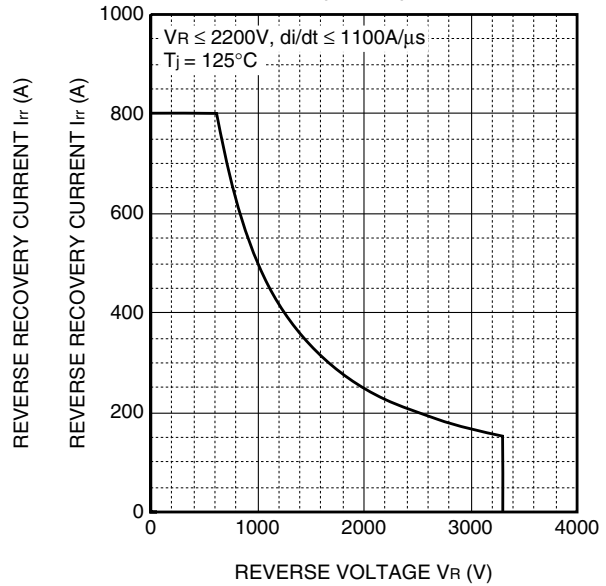

TRANSIENT THERMAL IMPEDANCE CHARACTERISTICS

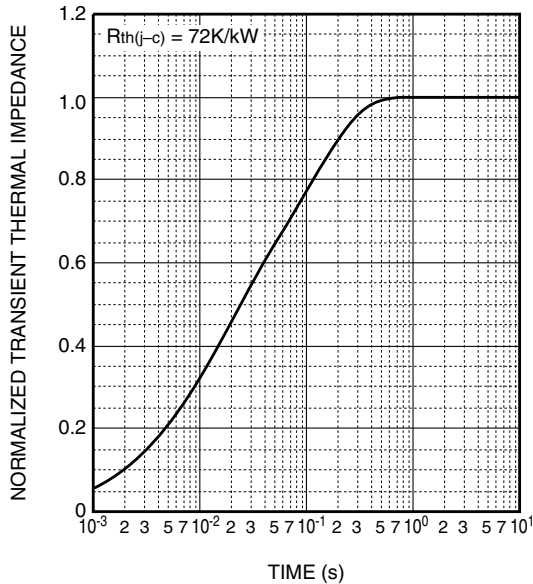

High Voltage Diode Module

Important Notice

The information contained in this datasheet shall in no event be regarded as a guarantee of conditions or characteristics. This product has to be used within its specified maximum ratings, and is subject to customer's compliance with any applicable legal requirement, norms and standards.

Except as otherwise explicitly approved by Mitsubishi Electric Corporation in a written document signed by authorized representatives of Mitsubishi Electric Corporation, our products may not be used in any applications where a failure of the product or any consequences of the use thereof can reasonably be expected to result in personal injury.

In usage of power semiconductor, there is always the possibility that trouble may occur with them by the reliability lifetime such as Power Cycle, Thermal Cycle or others, or when used under special circumstances (e.g. condensation, high humidity, dusty, salty, highlands, environment with lots of organic matter / corrosive gas / explosive gas, or situations which terminals of semiconductor products receive strong mechanical stress). Therefore, please pay sufficient attention to such circumstances. Further, depending on the technical requirements, our semiconductor products may contain environmental regulation substances, etc. If there is necessity of detailed confirmation, please contact our nearest sales branch or distributor.

The contents or data contained in this datasheet are exclusively intended for technically trained staff. Customer's technical departments should take responsibility to evaluate the suitability of Mitsubishi Electric Corporation product for the intended application and the completeness of the product data with respect to such application. In the customer's research and development, please evaluate it not only with a single semiconductor product but also in the entire system, and judge whether it's applicable. As required, pay close attention to the safety design by installing appropriate fuse or circuit breaker between a power supply and semiconductor products to prevent secondary damage. Please also pay attention to the application note and the related technical information.

Keep safety first in your circuit designs!

Mitsubishi Electric Corporation puts the maximum effort into making semiconductor products better and more reliable, but there is always the possibility that trouble may occur with them. Trouble with semiconductors may lead to personal injury, fire or property damage. Remember to give due consideration to safety when making your circuit designs, with appropriate measures such as (i) placement of substitutive, auxiliary circuits, (ii) use of non-flammable material or (iii) prevention against any malfunction or mishap.

Notes regarding these materials

- These materials are intended as a reference to assist our customers in the selection of the Mitsubishi Electric Semiconductor product best suited to the customer's application; they do not convey any license under any intellectual property rights, or any other rights, belonging to Mitsubishi Electric Corporation or a third party.
- Mitsubishi Electric Corporation assumes no responsibility for any damage, or infringement of any third-party's rights, originating in the use of any product data, diagrams, charts, programs, algorithms, or circuit application examples contained in these materials.
- All information contained in these materials, including product data, diagrams, charts, programs and algorithms represents information on products at the time of publication of these materials, and are subject to change by Mitsubishi Electric Corporation without notice due to product improvements or other reasons. It is therefore recommended that customers contact Mitsubishi Electric Corporation or an authorized Mitsubishi Electric Semiconductor product distributor for the latest product information before purchasing a product listed herein.
The information described here may contain technical inaccuracies or typographical errors. Mitsubishi Electric Corporation assumes no responsibility for any damage, liability, or other loss rising from these inaccuracies or errors.
Please also pay attention to information published by Mitsubishi Electric Corporation by various means, including the Mitsubishi Electric Semiconductor home page (<https://www.MitsubishiElectric.com/semiconductors/>).
- When using any or all of the information contained in these materials, including product data, diagrams, charts, programs, and algorithms, please be sure to evaluate all information as a total system before making a final decision on the applicability of the information and products. Mitsubishi Electric Corporation assumes no responsibility for any damage, liability or other loss resulting from the information contained herein.
- Mitsubishi Electric Corporation semiconductors are not designed or manufactured for use in a device or system that is used under circumstances in which human life is potentially at stake. Please contact Mitsubishi Electric Corporation or an authorized Mitsubishi Electric Semiconductor product distributor when considering the use of a product contained herein for any specific purposes, such as apparatus or systems for transportation, vehicular, medical, aerospace, nuclear, or undersea repeater use.
- The prior written approval of Mitsubishi Electric Corporation is necessary to reprint or reproduce in whole or in part these materials.
- If these products or technologies are subject to the Japanese export control restrictions, they must be exported under a license from the Japanese government and cannot be imported into a country other than the approved destination.
Any diversion or re-export contrary to the export control laws and regulations of Japan and/or the country of destination is prohibited.
- Please contact Mitsubishi Electric Corporation or an authorized Mitsubishi Electric Semiconductor product distributor for further details on these materials or the products contained therein.