

< HV MOSFET MODULE >

# FMF185DC-66A

HIGH POWER SWITCHING USE  
INSULATED TYPE

1<sup>st</sup> gen. HV MOSFET (High Voltage Metal Oxide Semiconductor Field Effect Transistor) Modules

## FMF185DC-66A



- $I_D$ .....185A
- $V_{DSX}$ .....3300V
- 2-element in a Pack
- Insulated Type
- SiC MOSFET
- JBS(Junction Barrier Schottky)

## APPLICATION

Traction drives, High Reliability Converters / Inverters, DC choppers

### OUTLINE DRAWING & CIRCUIT DIAGRAM

Dimensions in mm

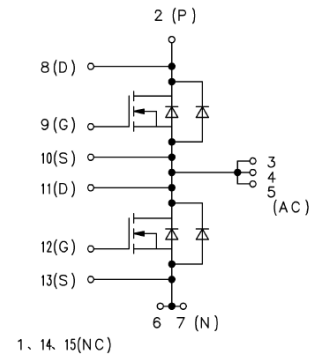
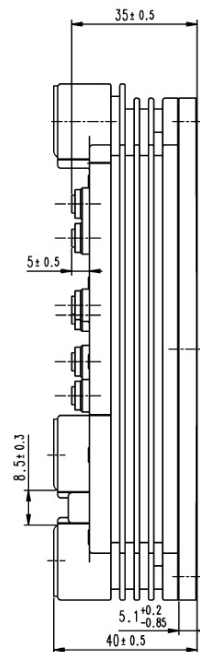
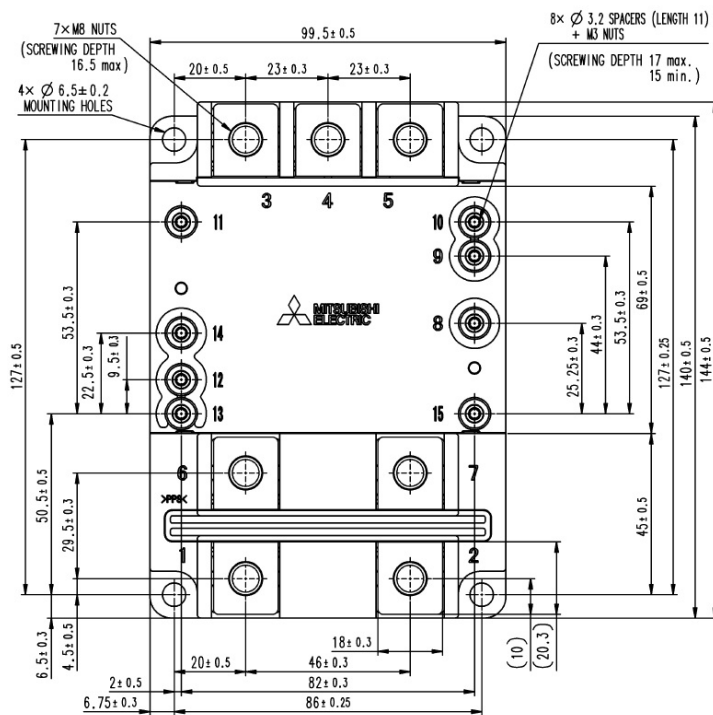

CIRCUIT DIAGRAM

No.	Terminals
1	NC
2	DC+, D(P)
3, 4, 5	AC, S(P), D(N)
6, 7	DC-, S(N)
8	D(P)
9	G(P)
10	S(P)
11	D(N) / S(P)
12	G(N)
13	S(N)
14, 15	NC

Note 1. Terminal 1 is not connected to the circuit, but must be shorted to terminal 2 when using the module.

< HV MOSFET MODULE >

**FMF185DC-66A**

HIGH POWER SWITCHING USE

INSULATED TYPE

1<sup>st</sup> gen. HV MOSFET (High Voltage Metal Oxide Semiconductor Field Effect Transistor) Modules

**MAXIMUM RATINGS (T<sub>j</sub>=25 °C, unless otherwise specified)**

Symbol	Item	Conditions	Ratings	Unit
V <sub>DSX</sub>	Drain-source voltage	V <sub>GS</sub> = -5V	3300	V
V <sub>GSS</sub>	Gate-source voltage	V <sub>DS</sub> = 0V	±20	V
I <sub>D</sub>	Drain current	DC (Note 1)	185	A
I <sub>DM</sub>		Pulse (Note 2)	370	A
I <sub>S</sub>	Source current (Note 3)	DC (Note 1)	185	A
I <sub>SM</sub>		Pulse (Note 2)	370	A
P <sub>tot</sub>	Maximum power dissipation (Note 4)	T <sub>c</sub> = 25°C, MOSFET part	1150	W
V <sub>ISO</sub>	Isolation voltage	RMS, sinusoidal, f = 60Hz, t = 1 min., T <sub>j</sub> = 25°C	6000	V
V <sub>e</sub>	Partial discharge extinction voltage	RMS, sinusoidal, f = 60Hz, Q <sub>PD</sub> ≤ 10 pC., T <sub>j</sub> = 25°C	2600	V
T <sub>j</sub>	Channel temperature	—	-40 ~ +175	°C
T <sub>op</sub>	Operating channel temperature	—	-40 ~ +175	°C
T <sub>stg</sub>	Storage temperature	—	-40 ~ +175	°C

**ELECTRICAL CHARACTERISTICS (T<sub>j</sub>=25 °C, unless otherwise specified)**

Symbol	Item	Conditions	Limits			Unit	
			Min	Typ	Max		
I <sub>GSS</sub>	Gate leakage current	V <sub>GS</sub> = V <sub>GSS</sub> , V <sub>DS</sub> = 0 V, T <sub>j</sub> = 25°C	-0.5	—	0.5	μA	
I <sub>DSX</sub>	Drain-source cut-off current	V <sub>DS</sub> = V <sub>DSX</sub> , V <sub>GS</sub> = -5 V	T <sub>j</sub> = 25°C	—	—	0.7	mA
			T <sub>j</sub> = 150°C	—	—	—	
			T <sub>j</sub> = 175°C	—	0.8	—	
V <sub>GS(th)</sub>	Gate-source threshold voltage	V <sub>DS</sub> = 10V, I <sub>C</sub> = 18.5mA	T <sub>j</sub> = 25°C	—	2.1	—	V
r <sub>DS(on)</sub>	Drain-source resistance	V <sub>DS</sub> = V <sub>DS(on)</sub> V <sub>GS</sub> = 17V	T <sub>j</sub> = 25°C	—	9.5	—	mΩ
			T <sub>j</sub> = 150°C	—	—	—	
			T <sub>j</sub> = 175°C	—	21.1	—	
V <sub>DS(on)</sub>	Drain-source on voltage	V <sub>GS</sub> = 17V, I <sub>D</sub> = 185A	T <sub>j</sub> = 25°C	—	1.75	—	V
			T <sub>j</sub> = 150°C	—	—	—	
			T <sub>j</sub> = 175°C	—	3.90	—	
C <sub>iss</sub>	Input capacitance	V <sub>DS</sub> = 10V, V <sub>GS</sub> = 0V, f = 100kHz, T <sub>j</sub> = 25°C	—	52.5	—	nF	
C <sub>oss</sub>	Output capacitance		—	8.5	—	nF	
C <sub>riss</sub>	Reverse transfer capacitance		—	0.2	—	nF	
Q <sub>G</sub>	Total gate charge	V <sub>DD</sub> = 1800V, I <sub>D</sub> = 185A, V <sub>GS</sub> = +17V / -5V	—	1.68	—	μC	
t <sub>d(on)</sub>	Turn-on delay time	V <sub>DD</sub> = 1800V, I <sub>D</sub> = 185A V <sub>GS</sub> = +17V / -5V	T <sub>j</sub> = 175°C	—	—	1.2	μs
t <sub>r</sub>	Rise time		T <sub>j</sub> = 175°C	—	—	0.72	μs
E <sub>on(10%)</sub>	Turn-on switching energy per pulse	R <sub>G(on)</sub> = 2.0 Ω, L <sub>s</sub> = 60 nH Inductive load	T <sub>j</sub> = 150°C	—	—	—	mJ
			T <sub>j</sub> = 175°C	—	130	—	
t <sub>d(off)</sub>	Turn-off delay time	V <sub>DD</sub> = 1800V I <sub>D</sub> = 185 A	T <sub>j</sub> = 150°C	—	—	—	μs
			T <sub>j</sub> = 175°C	—	0.90	—	
t <sub>f</sub>	Fall time	V <sub>GS</sub> = +17 V / -5V R <sub>G(off)</sub> = 2.0 Ω	T <sub>j</sub> = 150°C	—	—	—	μs
			T <sub>j</sub> = 175°C	—	0.24	—	
E <sub>off(10%)</sub>	Turn-off switching energy per pulse	L <sub>s</sub> = 60 nH Inductive load	T <sub>j</sub> = 150°C	—	—	—	mJ
			T <sub>j</sub> = 175°C	—	45	—	

< HV MOSFET MODULE >

# FMF185DC-66A

HIGH POWER SWITCHING USE

INSULATED TYPE

1<sup>st</sup> gen. HV MOSFET (High Voltage Metal Oxide Semiconductor Field Effect Transistor) Modules

## ELECTRICAL CHARACTERISTICS

Symbol	Item	Conditions	Limits			Unit	
			Min	Typ	Max		
V <sub>SD</sub>	Source-drain voltage (Note 3)	I <sub>S</sub> = 185 A V <sub>GS</sub> = 0 V	T <sub>J</sub> = 25°C	—	2.50	—	V
			T <sub>J</sub> = 150°C	—	—	—	
			T <sub>J</sub> = 175°C	—	3.50	—	
V <sub>SD</sub>	Source-drain voltage (Note 3)	I <sub>S</sub> = 185 A V <sub>GS</sub> = +17 V	T <sub>J</sub> = 25°C	—	1.20	—	V
			T <sub>J</sub> = 150°C	—	—	—	
			T <sub>J</sub> = 175°C	—	2.40	—	
Q <sub>C(10%)</sub>	Total capacitive charge (Note 3)	V <sub>DD</sub> = 1800V, I <sub>D</sub> = 185A V <sub>GS</sub> = +17V / -5V	T <sub>J</sub> = 150°C	—	—	—	μC
E <sub>off diode(10%)</sub>	Diode turn-off energy per pulse (Note 3)	R <sub>G(on)</sub> = 2.0 Ω, L <sub>s</sub> = 60 nH Inductive load	T <sub>J</sub> = 150°C	—	—	—	mJ
			T <sub>J</sub> = 175°C	—	7.5	—	

## THERMAL CHARACTERISTICS

Symbol	Item	Conditions	Limits			Unit
			Min	Typ	Max	
R <sub>th(f-c)Q</sub>	Thermal resistance	Junction to Case, MOSFET part, 1/2 module	—	—	128.0	K/kW
R <sub>th(f-c)D</sub>		Junction to Case, FWDi part, 1/2 module	—	—	218.0	K/kW
R <sub>th(c-s)</sub>	Contact thermal resistance	Case to heat sink, λ <sub>grease</sub> = 1W/m·K, D <sub>(c-s)</sub> = 100μm, 1/2 module	—	90.0	—	K/kW

## MECHANICAL CHARACTERISTICS

Symbol	Item	Conditions	Limits			Unit
			Min	Typ	Max	
M <sub>t</sub>	Mounting torque	Main terminals screw M8 <sup>(Note 5)</sup>	7.0	—	14.0	N·m
M <sub>s</sub>		Mounting screw M6	3.0	—	6.0	N·m
M <sub>t</sub>		Auxiliary terminals screw M3	0.4	—	0.6	N·m
m	Mass	-	—	0.80	—	kg
CTI	Comparative tracking index	-	600	—	—	—
d <sub>a</sub>	Clearance	Between terminals and baseplate	19.2	—	—	mm
d <sub>s</sub>	Creepage distance	-	32	—	—	mm
L <sub>P P-N</sub>	Parasitic stray inductance	Between terminal 2 and terminal 6,7	—	30.0	—	nH
L <sub>P S-SS</sub>	Internal inductance	Between Auxiliary terminals (terminal 10-11)	—	—	—	nH
		Between Auxiliary terminals and DC- (terminal 13-6,7)	—	—	—	
R <sub>DD'+SS'</sub>	Internal lead resistance	Between DC+ and DC- (terminal 2-6,7)	—	—	—	mΩ
		Between DC+ and AC (terminal 2-3,4,5)	—	0.66	—	
		Between AC and DC- (terminal 3,4,5-6,7)	—	0.83	—	

Note 1. The energization time is a short time in which the internal electrode does not generate heat.

Note 2. Pulse width and repetition rate should be such that junction temperature (T<sub>J</sub>) does not exceed T<sub>Jmax</sub> rating.

Note 3. The symbols represent characteristics of the anti-parallel, source to drain free-wheel diode (FWD).

Note 4. Junction temperature (T<sub>J</sub>) should not exceed T<sub>Jmax</sub> rating.

Note 5. This is the case when installing the product on the bus bar

PERFORMANCE CURVES

**OUTPUT CHARACTERISTICS (TYPICAL)**

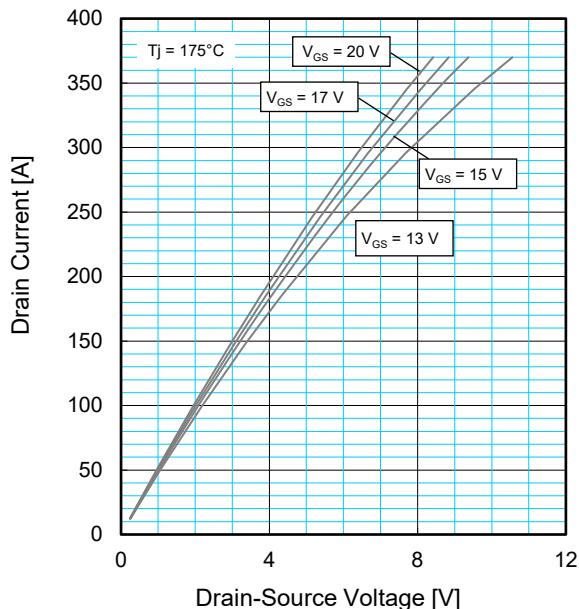

**TRANSFER CHARACTERISTICS (TYPICAL)**

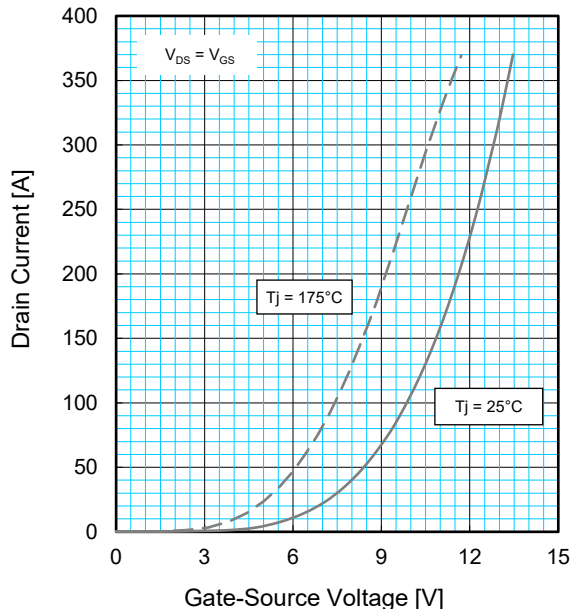

**DRAIN-SOURCE ON VOLTAGE CHARACTERISTICS (TYPICAL)**

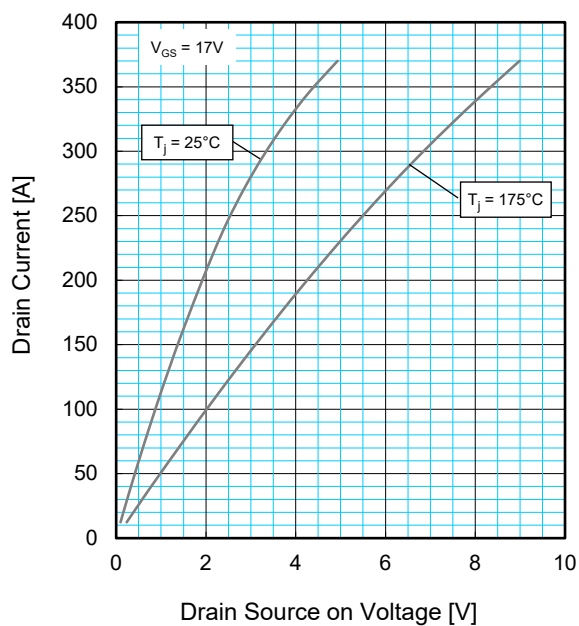

**FREE-WHEEL DIODE FORWARD CHARACTERISTICS (TYPICAL)**

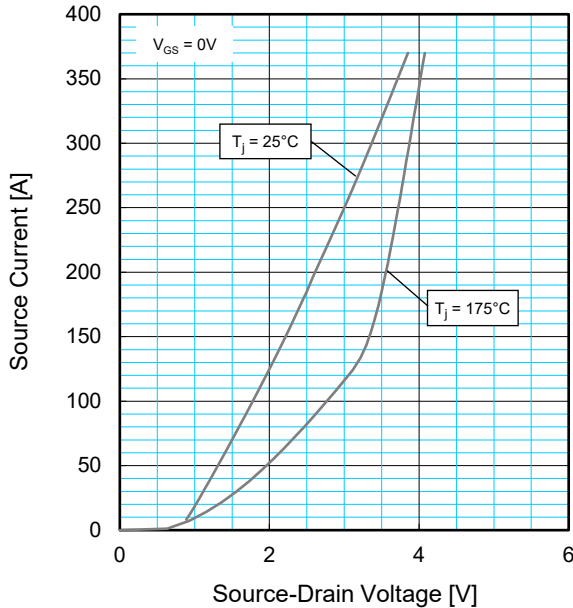

PERFORMANCE CURVES

**FREE-WHEEL DIODE FORWARD CHARACTERISTICS (TYPICAL)**

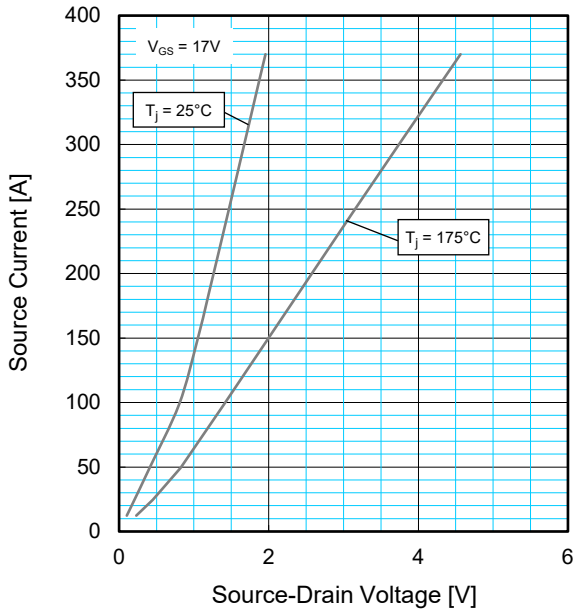

**HALF-BRIDGE SWITCHING ENERGY CHARACTERISTICS (TYPICAL)**

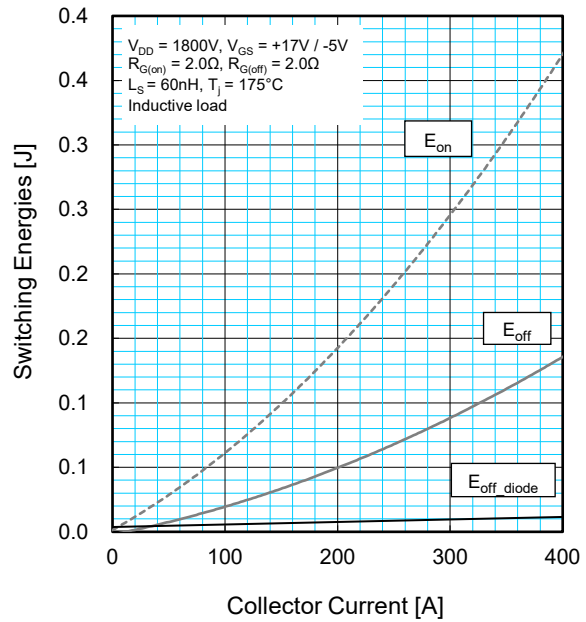

**CAPACITANCE CHARACTERISTICS (TYPICAL)**

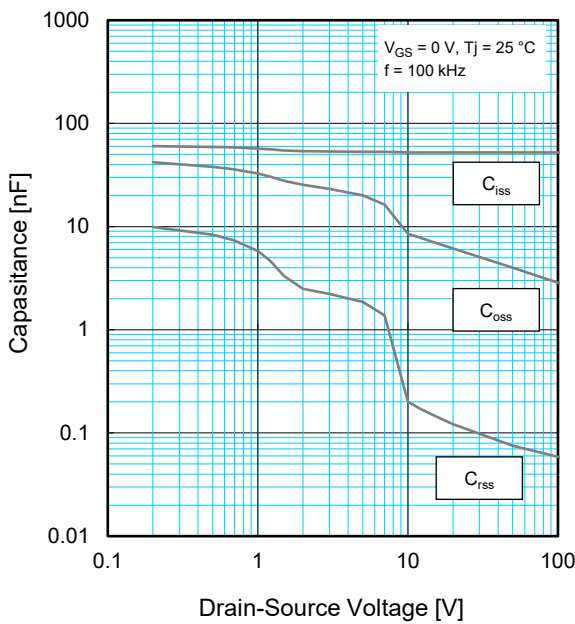

**GATE CHARGE CHARACTERISTICS (TYPICAL)**

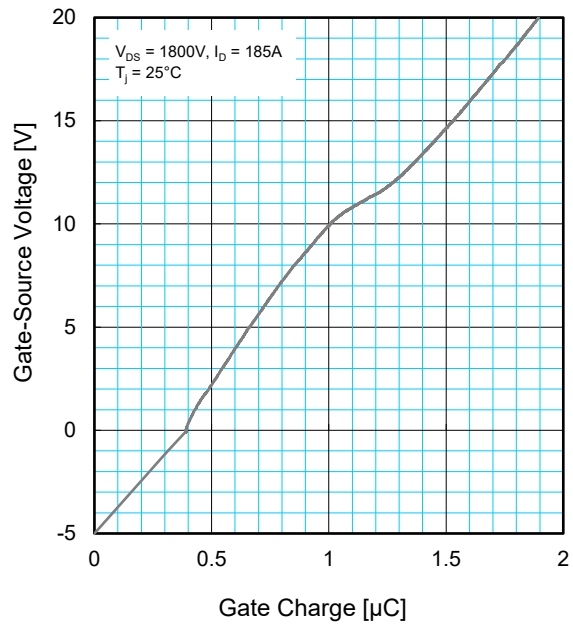

PERFORMANCE CURVES

**HALF-BRIDGE SWITCHING ENERGY CHARACTERISTICS (TYPICAL)**

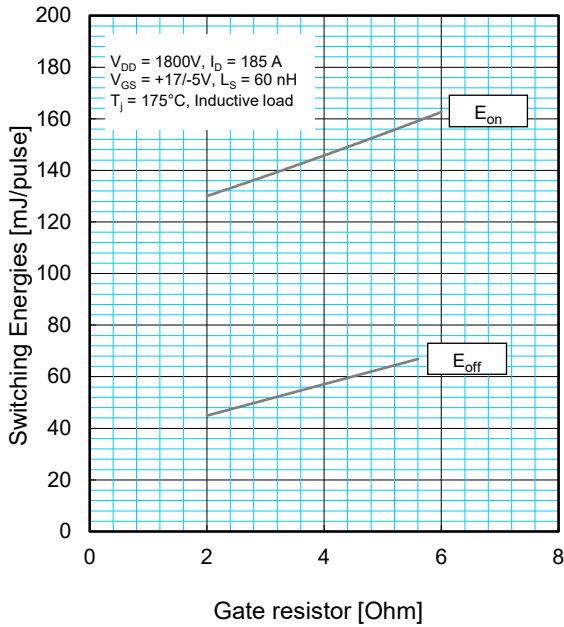

**HALF-BRIDGE SWITCHING TIME CHARACTERISTICS (TYPICAL)**

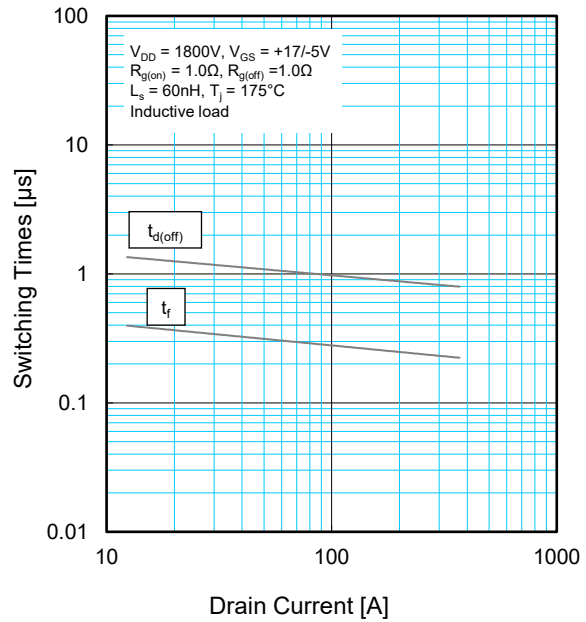

**REVERSE BIAS SAFE OPERATING AREA (RBSOA)**

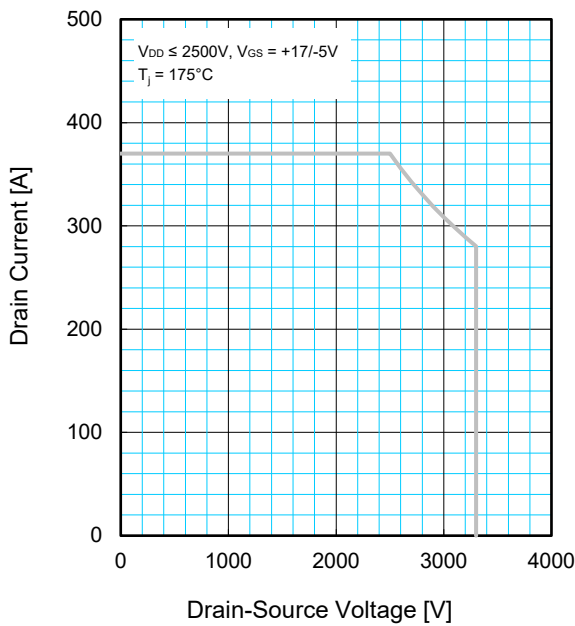

**SHORT CIRCUIT SAFE OPERATING AREA (SCSOA)**

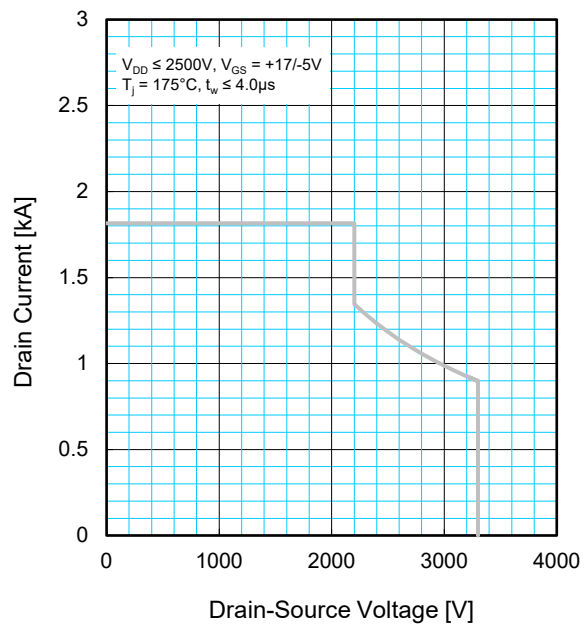

PERFORMANCE CURVES

**TRANSIENT THERMAL IMPEDANCE CHARACTERISTICS**

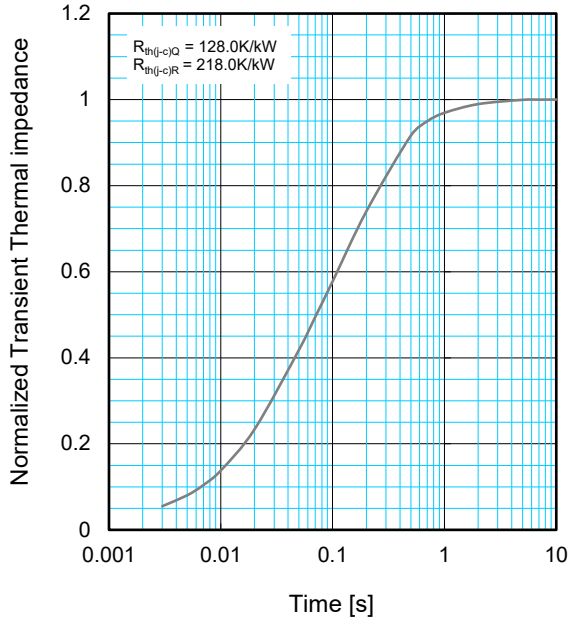

$$Z_{th(j-c)}(t) = \sum_{i=1}^n R_i \left\{ 1 - \exp\left(-\frac{t}{\tau_i}\right) \right\}$$

	1	2	3	4
$R_i / R_{th}$ :	0.0145	0.3107	0.5977	0.0772
$\tau_i$ [sec.] :	0.0001	0.0291	0.1797	1.0024

### **Important Notice**

The information contained in this datasheet shall in no event be regarded as a guarantee of conditions or characteristics. This product has to be used within its specified maximum ratings, and is subject to customer's compliance with any applicable legal requirement, norms and standards.

Except as otherwise explicitly approved by Mitsubishi Electric Corporation in a written document signed by authorized representatives of Mitsubishi Electric Corporation, our products may not be used in any applications where a failure of the product or any consequences of the use thereof can reasonably be expected to result in personal injury.

In usage of power semiconductor, there is always the possibility that trouble may occur with them by the reliability lifetime such as Power Cycle, Thermal Cycle or others, or when used under special circumstances (e.g. condensation, high humidity, dusty, salty, highlands, environment with lots of organic matter / corrosive gas / explosive gas, or situations which terminals of semiconductor products receive strong mechanical stress). Therefore, please pay sufficient attention to such circumstances. Further, depending on the technical requirements, our semiconductor products may contain environmental regulation substances, etc. If there is necessity of detailed confirmation, please contact our nearest sales branch or distributor.

The contents or data contained in this datasheet are exclusively intended for technically trained staff. Customer's technical departments should take responsibility to evaluate the suitability of Mitsubishi Electric Corporation product for the intended application and the completeness of the product data with respect to such application. In the customer's research and development, please evaluate it not only with a single semiconductor product but also in the entire system, and judge whether it's applicable. As required, pay close attention to the safety design by installing appropriate fuse or circuit breaker between a power supply and semiconductor products to prevent secondary damage. Please also pay attention to the application note and the related technical information.



**Keep safety first in your circuit designs!**

Mitsubishi Electric Corporation puts the maximum effort into making semiconductor products better and more reliable, but there is always the possibility that trouble may occur with them. Trouble with semiconductors may lead to personal injury, fire or property damage. Remember to give due consideration to safety when making your circuit designs, with appropriate measures such as (i) placement of substitutive, auxiliary circuits, (ii) use of non-flammable material or (iii) prevention against any malfunction or mishap.

**Notes regarding these materials**

- These materials are intended as a reference to assist our customers in the selection of the Mitsubishi Electric Semiconductor product best suited to the customer's application; they do not convey any license under any intellectual property rights, or any other rights, belonging to Mitsubishi Electric Corporation or a third party.
- Mitsubishi Electric Corporation assumes no responsibility for any damage, or infringement of any third-party's rights, originating in the use of any product data, diagrams, charts, programs, algorithms, or circuit application examples contained in these materials.
- All information contained in these materials, including product data, diagrams, charts, programs and algorithms represents information on products at the time of publication of these materials, and are subject to change by Mitsubishi Electric Corporation without notice due to product improvements or other reasons. It is therefore recommended that customers contact Mitsubishi Electric Corporation or an authorized Mitsubishi Electric Semiconductor product distributor for the latest product information before purchasing a product listed herein.  
The information described here may contain technical inaccuracies or typographical errors. Mitsubishi Electric Corporation assumes no responsibility for any damage, liability, or other loss rising from these inaccuracies or errors.  
Please also pay attention to information published by Mitsubishi Electric Corporation by various means, including the Mitsubishi Electric Semiconductor home page (<https://www.MitsubishiElectric.com/semiconductors/>).
- When using any or all of the information contained in these materials, including product data, diagrams, charts, programs, and algorithms, please be sure to evaluate all information as a total system before making a final decision on the applicability of the information and products. Mitsubishi Electric Corporation assumes no responsibility for any damage, liability or other loss resulting from the information contained herein.
- Mitsubishi Electric Corporation semiconductors are not designed or manufactured for use in a device or system that is used under circumstances in which human life is potentially at stake. Please contact Mitsubishi Electric Corporation or an authorized Mitsubishi Electric Semiconductor product distributor when considering the use of a product contained herein for any specific purposes, such as apparatus or systems for transportation, vehicular, medical, aerospace, nuclear, or undersea repeater use.
- The prior written approval of Mitsubishi Electric Corporation is necessary to reprint or reproduce in whole or in part these materials.
- If these products or technologies are subject to the Japanese export control restrictions, they must be exported under a license from the Japanese government and cannot be imported into a country other than the approved destination.  
Any diversion or re-export contrary to the export control laws and regulations of Japan and/or the country of destination is prohibited.
- Please contact Mitsubishi Electric Corporation or an authorized Mitsubishi Electric Semiconductor product distributor for further details on these materials or the products contained therein.